

ECONOMICAL DESIGN CONSIDERATIONS FOR ONE-WAY 300 FOOT SPAN, STEEL,  
PARALLEL TOP & BOTTOM CHORD WARREN TRUSSES

by

JOSHUA HEATH

B.S., Kansas State University, 2012

A REPORT

submitted in partial fulfillment of the requirements for the degree

MASTER OF SCIENCE

Department of Architectural Engineering  
College of Engineering

KANSAS STATE UNIVERSITY  
Manhattan, Kansas

2012

Approved by:

Major Professor  
Kimberly W. Kramer, P.E., S.E.

# **Copyright**

JOSHUA CHRISTMAN HEATH

2012

## **Abstract**

Trusses are an efficient way to span long distances with minimal material required. This report is a parametric study of the different design and construction aspects for a 300'-0" span, steel, Warren type truss. The study specifically examines the vertical loading on the truss, including components and cladding wind loading. The engineering variables investigated are panel point location, steel shape size and type, steel grade, member orientation, and connection design. Each of these aspects are studied independently with major results accounted for later in analysis. This allows for the most economical truss by reviewing each alternative possibly not commonly used in steel construction.

However, trusses require special consideration in constructability compared to a common steel structure such as an office building. Because of this added complexity, constructability issues are also examined after all parametric studies are completed for engineering variables. Transportation regulations and restrictions, steel erecting (including the construction loading of the ASCE 37-02), and temporary structures are considered for the 300'-0" span steel truss.

The results of the engineering design variables are documented showing the benefit of using W-Shape members with higher grades of steel in select members, and the rotation of members for truss stability and simplified connection detailing. Each of the multiple construction considerations are presented, providing the most recent information available at the time of this report.

# Table of Contents

List of Figures .....	vi
List of Tables .....	viii
Acknowledgements .....	ix
Dedication .....	x
Chapter 1 - Introduction .....	1
General Trusses .....	1
Truss Mechanics .....	2
Chapter 2 - Truss Economics and Analysis Specifics .....	6
Economics .....	6
Material Cost .....	7
Fabrication Labor Cost .....	8
Erection Labor Costs .....	10
Other Costs .....	10
Truss in Analysis .....	12
Loading .....	14
Panel Points .....	16
Overall Intended Results .....	17
Chapter 3 - Engineering Design Considerations .....	19
Panel Points .....	19
Panel Point Results .....	20
Steel Shape .....	21
Round HSS .....	22
Rectangular HSS .....	22
Steel Shape Results .....	24
Steel Grades .....	27
Steel Grade Results .....	29
Member Orientation .....	31
Member Orientation Results .....	33

Connections .....	33
Field Bolted Connection .....	35
Welding.....	38
Connecting Gusset Plate .....	40
Chapter 4 - Construction Considerations.....	45
Transportation.....	47
Steel Erecting.....	48
ASCE 37-02.....	50
Temporary Structures .....	51
Chapter 5 - Conclusions.....	53
Bibliography .....	55
Appendix A - Building Load Calculations (IBC 2012 & ASCE 7-10) .....	57
Appendix B - Truss Analysis Detailed Results.....	61

## List of Figures

Figure 1-1: Steel Beam and Truss Section Showing Analogous Mechanics.....	4
Figure 2-1: Typical Mill Pricing (adapted from information obtained from ASIC).....	6
Figure 2-2: Material Percentage Cost (adapted from “Save More Money” <i>Modern Steel Construction</i> March 2008).....	8
Figure 2-3: Fabrication Labor Percentage Cost (adapted from “Save More Money” <i>Modern Steel Construction</i> March 2008).....	9
Figure 2-4: Erection Labor Percentage Cost (adapted from “Save More Money” <i>Modern Steel Construction</i> March 2008).....	10
Figure 2-5: Other Costs Percentage Cost (adapted from “Save More Money” <i>Modern Steel Construction</i> March 2008).....	11
Figure 2-6: Truss Layout Plan .....	12
Figure 2-7: Section Through Hangar .....	13
Figure 2-8: Roof Components and Cladding Zone Diagram.....	15
Figure 2-9: Panel Point Illustration.....	16
Figure 3-1: Member Orientation Illustration .....	32
Figure 3-2: Shearing Plane & Bolt Length Difference .....	36
Figure 3-3: Sample Connection Showing Required Bolt Quantities .....	37
Figure 3-4: Sample Connection Showing Required Welds .....	39
Figure 3-5: Block Shear Illustration .....	41
Figure 3-6: Whitmore Section Illustration.....	42
Figure 3-7: Member End Preference Illustration.....	44
Figure 4-1: Graphical Representation of Constructability (adapted from <i>Constructability: Maximizing Simplicity</i> ) .....	45
Figure B-1: Truss Model #1 Member Layout.....	61
Figure B-2: Truss Model #2 Member Layout.....	61
Figure B-3: Truss Model #3 Member Layout.....	61
Figure B-4: Truss Model #4 Member Layout.....	61
Figure B-5: Truss Model #5 Member Layout.....	62

Figure B-6: Truss Model #6 Member Layout.....	62
Figure B-7: Truss Model #7 Member Layout.....	62
Figure B-8: Truss Model #1 Member and Steel Grade Layout .....	62
Figure B-9: Truss Model #2 Member and Steel Grade Layout .....	63
Figure B-10: Truss Model #3 Member and Steel Grade Layout .....	63
Figure B-11: Truss Model #4 Member and Steel Grade Layout .....	63
Figure B-12: Truss Model #5 Member and Steel Grade Layout .....	64
Figure B-13: Truss Model #6 Member and Steel Grade Layout .....	64
Figure B-14: Truss Model #7 Member and Steel Grade Layout .....	64
Figure B-15: Dead Load Truss Loading .....	65
Figure B-16: Roof Live Load Truss Loading .....	65
Figure B-17: Snow Load Truss Loading .....	66
Figure B-18: Wind Loading (Components and Cladding) Truss Loading .....	66

## List of Tables

Table 3-1: Panel Point Analysis Results.....	20
Table 3-2: Truss Model Shape Variable Results .....	24
Table 3-3: ASTM Preferred and Alternative Steel Grades.....	27
Table 3-4: Truss Model Steel Grade Variable Results .....	29
Table 3-5: Bolt Quantity for Different Truss Connections.....	37
Table 3-6: Minimum Weld Length for Different Truss Connections.....	39



## **Acknowledgements**

Thank you to all teachers I've had throughout my schooling career. Each has given me knowledge and inspiration to make this report possible.

## **Dedication**

This report is dedicated to my parents, Melissa and Ed, who have been supportive and encouraging behind anything I choose to undertake.

## **Chapter 1 - Introduction**

This report examines some of the main design considerations of a parallel chord Warren truss spanning one direction for 300'-0". The design considerations examined are categorized into: (1) engineering design and analysis considerations, and (2) fabrication and erection considerations. Engineering design and analysis considerations are specifying steel member types and grade, member orientation, and truss analysis and computer modeling. Whereas fabrication and erection considerations examined are transportation, temporary hoisting and bracing requirements, and steel erection requirements during construction. Both categories work together and affect each other to make the best possible economic design. This information can be applied specifically to Warren trusses, while different truss configurations can be investigated further with the basic knowledge learned from this report. The type of truss considered is a long-span, carrying only vertical loads, Warren-type truss composed of steel members, entirely field-assembled. This parametric study finds practical solutions to make the 300'-0", one-directional Warren truss the most economical in both phases of design and construction. The Warren truss was chosen to analyze as it is among the oldest trusses to be patented and is one someone new to truss design can easily follow and understand (Smith, 2009).

### **General Trusses**

Trusses have been utilized as an efficient way to span long distances since the first patented trusses in the early 1800's (Smith, 2009). Today, facilities such as airport hangars, industrial facilities, auditoriums, and arenas warrant the use of a structural member to span greater distances without the need for intermediate supports. This allows for large open spaces below that are required for the function of a building. All trusses can be categorized into either a pitched truss or a parallel chord truss. The "Warren" truss throughout this report is considered a parallel chord truss.

As well, shorter spans can utilize trusses as an architectural feature. These facilities could include churches or other religious facilities, unique dining facilities, and other unique architectural structures. In such aforementioned facilities, the structure essentially becomes the architecture and is often the defining aspect of the facility. Many times facilities featuring unique trusses are the result of design competitions and are high profile, "iconic" structures.

With trusses, flexibility in the material chosen for construction exists but more variables exist affecting economics of the structural system. For this report and many common cases for construction, steel is the material of choice. One of the biggest benefits of steel is the relatively high strength to weight properties compared to other structural materials. For quick comparison, a concrete member would weigh 37.2 pounds per linear foot compared to a steel member weighing 31 pounds per linear foot for the same compressive force applied and same unbraced length. As well, steel is a good material for both compression and tension, where other materials such as concrete have better properties for certain forces relative to others.

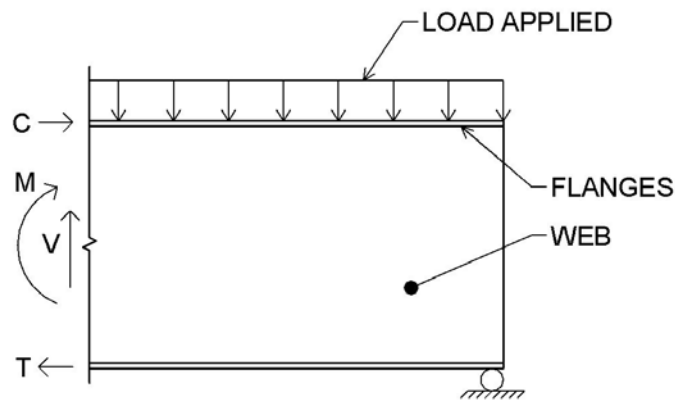
Another benefit of trusses is the simpler integration and coordination with other building systems such as mechanical and electrical. With greater than 60'-0" to 100'-0" span trusses, ample space between web members exists for easy routing of duct runs for mechanical system purposes or conduit for electrical system purposes. Whereas for other solid members used in roof framing systems, such as W-Shapes, all mechanical, electrical, and plumbing equipment is placed below the structure, increasing the amount of plenum space required. This in turn requires a taller structure increasing the total cost of the building due to additional exterior wall system (skin of the building) and interior space to condition in addition to the cost of longer columns. Routing can be accomplished through solid members, but requires more coordination amongst the different design disciplines and contractor for successful installation. To the Architect and ultimately building owner, this routing of materials through trusses is extremely beneficial as the floor-to-floor height can be reduced saving material, time, and money. Time is saved during construction by the less amount of material needed to install with a shorter structure.

## **Truss Mechanics**

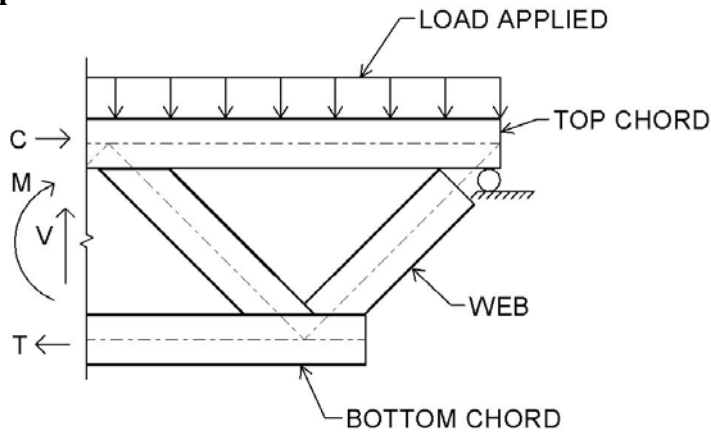
All trusses are composed of one or more triangles varying in shape and size. Triangles are the simplest, most structurally stable shape. Triangles will retain their shape without the need for intermediate braces or extra supports when lengths of their sides are fixed. For each extra member added to a simple geometric shape, additional bracing is required as is the case is with a square, pentagon, etc. While circles are also a structurally stable shape, steel members are rolled in linear shapes from the steel mill and any bending required is done afterwards. This adds costs to the project requiring non-linear steel members, such as circles.

Due to the geometric arrangement of these triangles within a truss, loads that cause the entire truss to bend are converted into tensile or compressive forces in the members. For this report, planar trusses where all members lie within the same vertical plane are studied. Space trusses in which members extend in three dimensions also exist and are suitable for specific applications. Space trusses, also known as space frames, commonly require more hand-analysis or computer analysis time and are less common for long spans, and therefore not included in this report. As well, many space trusses have become proprietary information to the companies spending time and money to research new three-dimensional truss configurations (Chen & Lui, 2005).

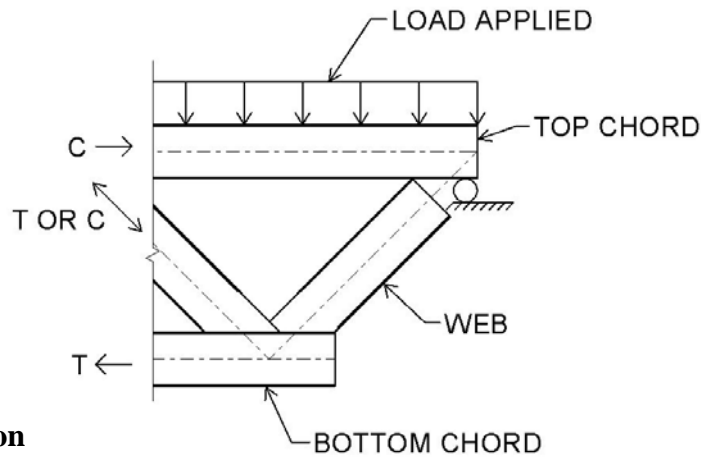
Any configuration truss can be idealized as a beam with all unnecessary material removed. Basic mechanics of a parallel top and bottom chord truss, such as the Warren truss, is analogous to a singular W-Shape steel member. As shown in **Figure 1-1(a)**, the flanges of a W-Shape carry all compressive and tensile forces while the web carries all shear forces. For the condition of a uniform gravity (downward) load applied to the top of the member, the top chord of the truss is put into compression and bottom chord in tension.



a) Steel Beam



b) Truss



c) Truss Section

**Figure 1-1: Steel Beam and Truss Section Showing Analogous Mechanics**

Different from W-Shape members as shown in **Figure 1-1 (b)**, the web components within the interior of the truss, both tension and compression occurs throughout the multiple members. This is from the unique configuration of web members where loads causing the entire truss to bend are converted to these tensile or compressive forces as shown in **Figure 1-1 (c)**.

This is one of the largest advantages of a truss, in that it uses less material to support a given load.

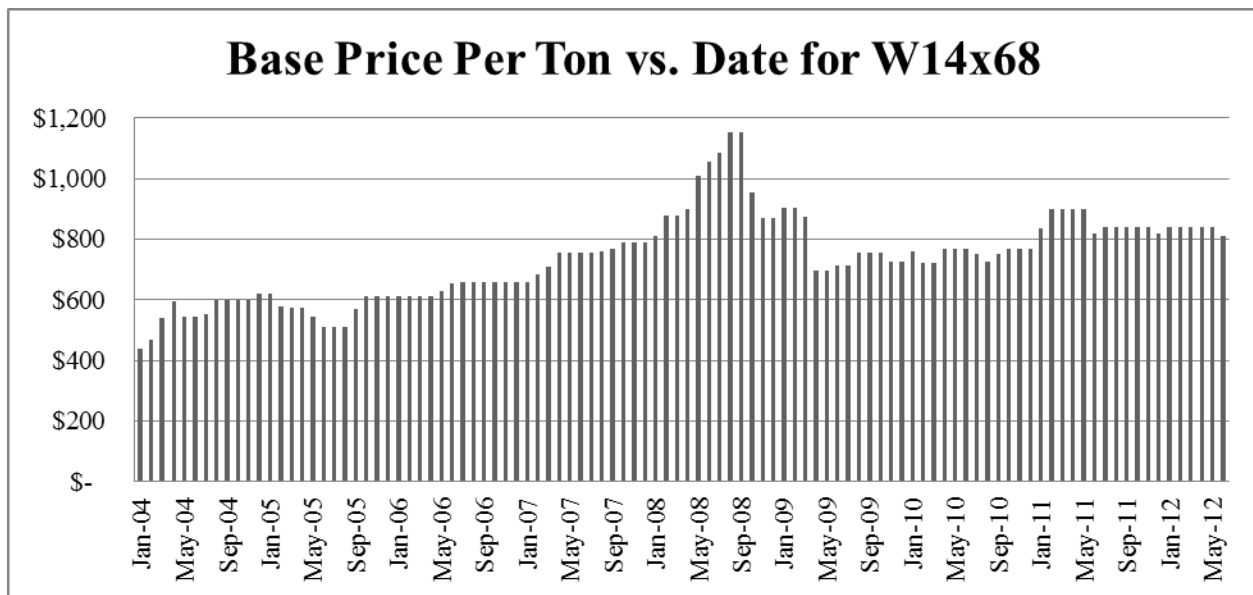
Chord members form the top and bottom of a truss. Chord members take the largest tensile and compressive forces throughout the truss and serve the same function as flanges in a W-Shape member. Web members are the diagonal members located between the chord members. These members transfer the shear forces through compression or tension to the chord members. The type of force and magnitude depends on the arrangement of the members and application and direction of loading. As well as carrying these compressive and tensile forces, web members also serve to brace the chords and stabilize the entire truss.

## Chapter 2 - Truss Economics and Analysis Specifics

### Economics

With any structure, it is in the engineer's best interest to make the most economically efficient structure for the owner, while meeting calculated capacities and mandatory code requirements. This will ensure the building owner is not paying extra for oversized structural components for the given loads. As well, larger members have a greater stiffness and will attract higher forces during a seismic event which can lead to many structural problems. This is outside the scope of this report.

However with trusses, economy comes in many forms such as material, shop labor, erection and temporary supports, and other miscellaneous items in addition to the engineering design fee. This section presents the recent history of all previously mentioned costs for steel construction. **Figure 2-1** shows historical base prices per ton of steel as purchase price directly from the steel mill obtained from the American Institute of Steel Construction (AISC).



**Figure 2-1: Typical Mill Pricing (adapted from information obtained from ASIC)**

Although the above graph is for a W14x68, it remains close to the average cost of all sections rolled by mills and is a good indicator of steel prices (American Institute of Steel Construction, 2012). While all construction materials see some degree of volatility in prices,



steel has seen a sharp increase in recent history. This drastic increase in steel prices can be tied to many different factors, but increased demand for steel scrap and other additives is the largest contributor. Steelmaking originally depended strictly on the mining of iron ore. However, an average of 90% recycled scrap content now exists in all hot-rolled shapes produced in the United States, while a nearby steel mill in Blytheville, Arkansas utilizes up to 95% (McKee, 2007). Additionally, steel is an energy intensive material to produce the final steel shapes. Nearly all hot-rolled shapes, the main shape used in this report are produced using electric-arc furnaces, with a steel mill requiring a nearby power plant to generate enough electricity to fire the furnace. As well, transportation costs exist to get the scrap metals to the steel mill site, sorted and separated to pull out any unwanted materials, and finally into the furnace.

The steel industry as well has been a large benefactor in helping the United States economy by its output. The most recent information available shows of the 7 million tons of total structural steel rolled by U.S. steel mills in 2011, 6.3 million tons were used for construction domestically. As well, the U.S. is a net exporter of structural steel shapes where the scrap to produce these shapes is gathered domestically (AISC).

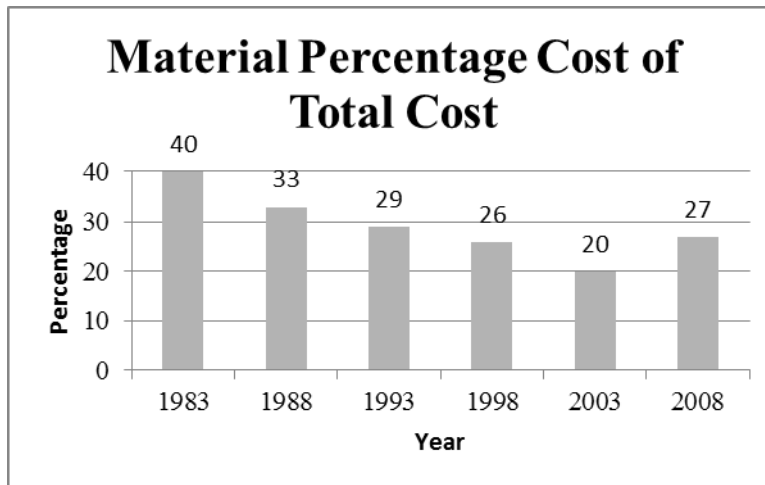
In addition to just the raw steel material cost shown previously from the steel mill, other costs associated with producing the pieces and constructing a truss are material, shop labor, erection labor, and other costs.

### ***Material Cost***

Material cost “includes the structural shapes, plates, steel joists, steel deck, bolting products, welding products, painting products, and any other products that must be purchased and incorporated into the work. (Carter & Schlafly, 2008)” Work is defined as the fabrication and eventual construction of the entire steel project. This material cost also includes any waste materials, such as short lengths of beams resulting from the members being cut to the required length for the project (the truss in this report). Common steel mill lengths range from 30’-0” to 80’-0” in 5’-0” increments (McKee, 2007). However, individual mill practices and standards vary, so it is best to consult with the individual mill directly for available lengths.

As steel is sold by weight, the largest component of material cost is the weight of structural shapes. This is larger by an order of magnitude over other components such as welding/bolting products, etc. Also, the larger quantities of material directly ordered from the

steel mill and the smaller quantities ordered through steel service centers can make an impact on total material cost as well. Steel mills and service centers also account for overhead and profit in the published material cost information. **Figure 2-2** illustrates the breakdown of percentage of total cost for steel structure construction over a twenty five year period.



**Figure 2-2: Material Percentage Cost (adapted from “\$ave More Money” *Modern Steel Construction* March 2008)**

With the most recent information presented, material costs are still approximately one third less than twenty five years ago. This is an important economic consideration to note when designing trusses. Some of the items included in this category such as steel deck & steel joists are not specifically applicable for this report in regards to the truss design. AISC’s published information is from most common steel construction projects which include steel deck and joists.

### ***Fabrication Labor Cost***

Fabrication labor cost “includes the detailing and fabrication labor required to prepare and assemble the shop assemblies of structural shapes, plates, bolts, welds and other materials and products for shipment and subsequent erection in the field. (Carter & Schlafly, 2008)” With the truss for this report, the individual pieces would be shop prepared, but minimal welding or bolting would take place in the fabrication shop as all connections would be done in the field before erection. This is covered in **Chapter 3**.

Fabrication costs also include painting costs. This is important as many long-span trusses are exposed to the space below, whereas other steel framing applications such as an office

building could be covered with a drop ceiling or other architectural finishes. Besides aesthetical purposes, painting of steel members also helps guard against corrosion issues. While the hangar for this report is a conditioned space, large temperature differences can lead to condensation problems, eventually causing steel to corrode (ASIC, 2010b). These large temperature differences can occur when the hangar doors are open letting aircrafts in or out. As well, a white or light-colored paint is commonly used for large hangars to help in light reflection, reducing artificial lighting needs for the interior of the hangar. However, without painting the steel, further savings is achieved as long as the steel can be guarded against corrosion or otherwise deemed negligible.

Fabrication costs are the total costs of detailing and shop time required to prepare and assemble components, including overhead and profit for the steel fabricator. **Figure 2-3** illustrates the breakdown of fabrication labor percentage of total cost for steel construction over a twenty five year period.

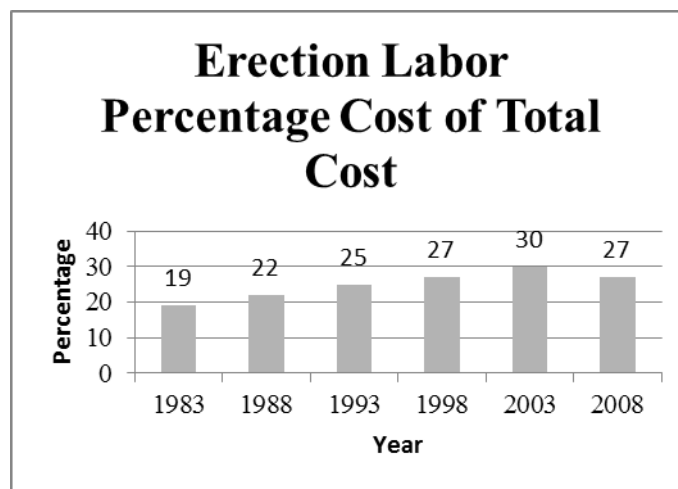


**Figure 2-3: Fabrication Labor Percentage Cost (adapted from “\$ave More Money” *Modern Steel Construction* March 2008)**

While this information is published by AISC as an average for all types of steel construction, trusses can be slightly higher or lower because of the special nature of the structural member. This can include a difference in time preparing member ends for connections compared to other common steel project. Note that labor costs have been more consistent than material costs over the same time span from **Figure 2-2** and **Figure 2-3**.

### *Erection Labor Costs*

Erection labor costs “includes the erection labor required to unload, lift, place and connect the components of the structural steel frame. (Carter & Schlafly, 2008)” This category has the potential biggest difference from a typical steel framed building compared to a long-span truss. More time is required for this field-assembled truss and erection compared to other steel structure where field assembly of the truss is not required. This category includes overhead and profit for the steel erection company. **Figure 2-4** illustrates the breakdown of percentage of total cost for steel construction over a twenty five year period.

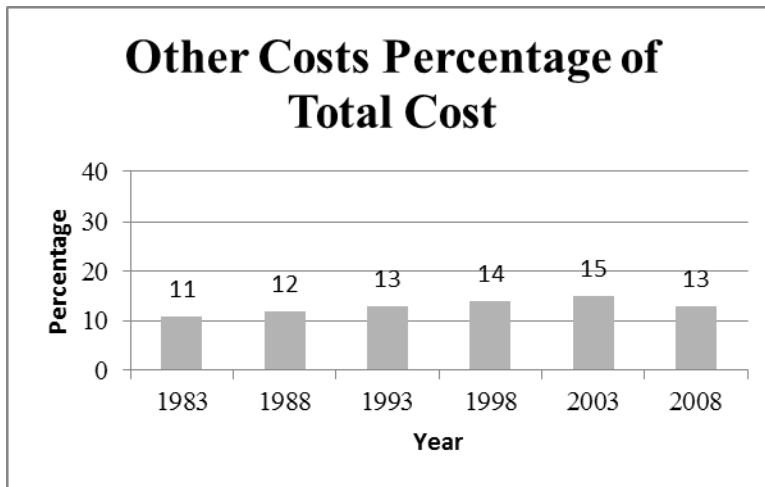


**Figure 2-4: Erection Labor Percentage Cost (adapted from “\$ave More Money” *Modern Steel Construction* March 2008)**

Different from fabrication labor costs, erection labor costs has seen an increase in recent history despite a minor drop off around the 2008 time.

### *Other Costs*

Other costs includes any items that do not fall directly into the material cost, fabrication labor cost, or erection labor costs sub-categories previously discussed. This can include other services outside of steel erection, additional costs associated with the project risk, the need for contingency, and specific schedule requirements of the project. **Figure 2-5** illustrates the breakdown of percentage of total cost for steel construction over a twenty five year period.



**Figure 2-5: Other Costs Percentage Cost (adapted from “\$ave More Money” *Modern Steel Construction* March 2008)**

The published percentages by AISC depicted in **Figure 2-2** through **Figure 2-5** can vary by specific characteristics of any given project, including the design and construction teams involved. One sub-category of the four can also dominate the total cost. The biggest item to note from the percentages shown previously is the labor involved in all steps throughout the steel construction process is a majority of the cost of a given project. “Other costs” have remained fairly constant and material costs have decreased in recent times to roughly 25 percent of the total construction cost, however labor costs contribute approximately 60 percent of the total construction cost based on the information presented above. From this, reducing the amount of labor time involved both in the shop and field will help in achieving the most economical truss design.

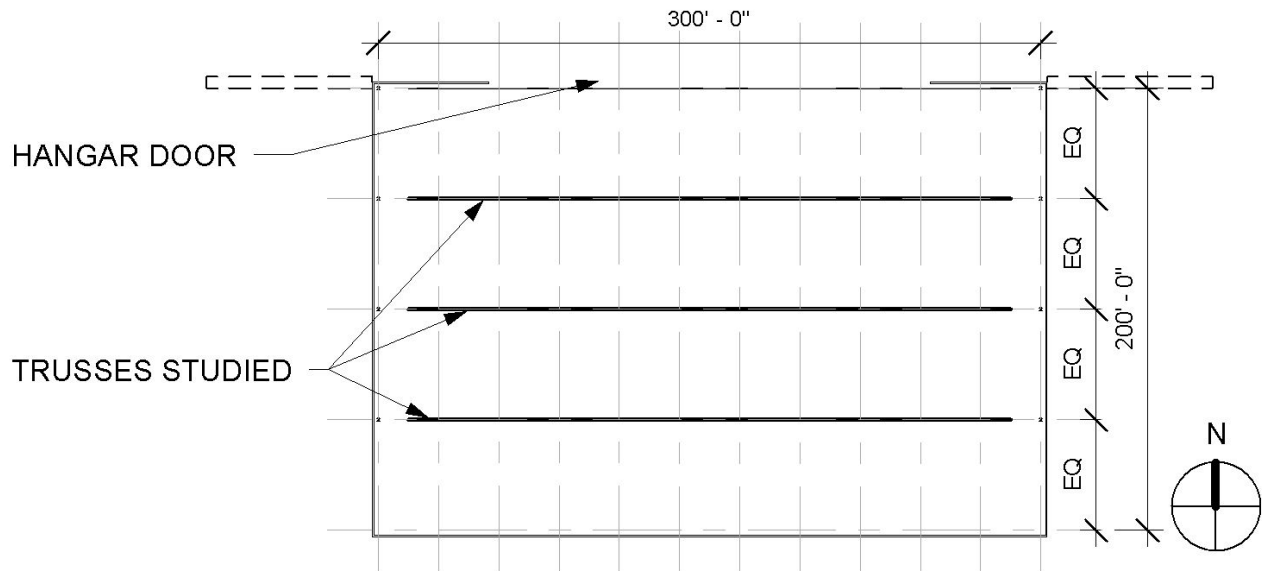
With the Warren truss, an economic benefit comes from parallel chord trusses that use webs of the same lengths and thus reduce shop fabrication costs for very long spans. Some Warren trusses use additional vertical members in order to reduce the unsupported length of the compression chord members; this is out of the scope of this report. For uniformly loaded trusses, the most economical span to depth ratio is within the range of 15 to 20 (Schmits, 2008). This depth is from the centerline of top chord to the centerline of bottom chord members. Thus, for this report the most economical depth is between 15’-0” and 20’-0” for a 300’-0” span truss.

Another potential economic benefit comes from the potential use of HSS structural members. HSS members generally have less surface area to paint and have excellent weak-axis

flexural strength compared to wide-flange cross-sections. Steel shape selection is covered in **Chapter 3**.

### Truss in Analysis

For this report, a hangar facility with a span of 300'-0" is studied. The building is 200'-0" wide by 300'-0" long and located in Manhattan, KS. A simplified hangar roof framing plan is shown in **Figure 2-6**.



**Figure 2-6: Truss Layout Plan**

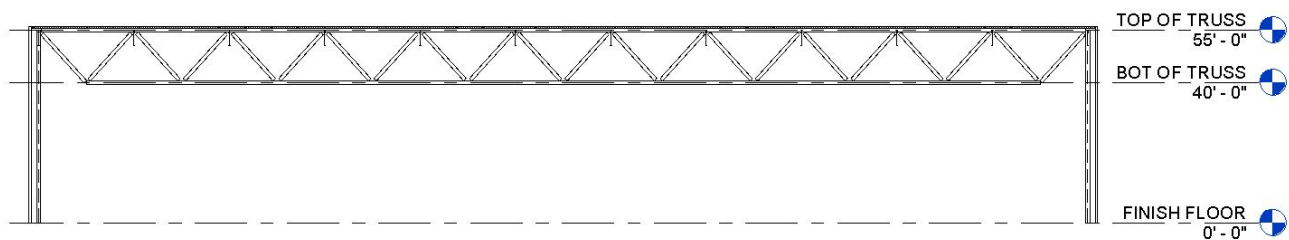
The three similar trusses in analysis for this report are shown by the bold horizontal lines in **Figure 2-6**. Secondary roof framing members and columns around the perimeter of the building are not shown for clarity. As well, a large opening is located along the north face of the hangar envelope for function of the structure. While sliding doors are not shown for clarity, the end of each wall is shown instead.

The trusses carry only vertical loads, including gravity forces and wind uplift and downward force due to components and cladding per the American Society of Civil Engineers (ASCE) *Minimum Design Loads for Buildings and Other Structures* 7-10, hereafter referred to as the ASCE 7-10. The trusses examined are not part of the lateral force resisting system for the scope of this report.

When wind is obstructed by a long building, such as the one under analysis, the wind acts similar to hitting a wing on an airplane. Upon hitting the side of a building, the wind will speed

up over the top of the structure and around the sides to maintain the same wind speed before encountering an obstacle. This speed up effect at the top and sides of the structure creates a suction force outwards, away from all surfaces of the building envelope. On the roof of the hangar in analysis, it creates upward lift and can increase drastically for the longer distances the wind has to travel over.

For hangar design, the height of the bottom truss chord members is typically set for the clearance required within the structure, with the roof supporting members designed above. For this report, the main opening is 40'-0" tall from the finish floor to the bottom of truss. Each face of the hangar envelope has small openings for personnel doors, but the largest opening is the main opening for aircrafts. This main opening is 200'-0" long by 40'-0" high along the North face of the building. The total truss depth is set at 15'-0" for this report, an economical depth as discussed previously, resulting in a top of truss height of 55'-0". A section through the hangar is shown in **Figure 2-7**.



**Figure 2-7: Section Through Hangar**

The larger distance for total truss depth, distance between top and bottom chords, results in a lesser moment couple, in turn lowering tensile and compressive forces in the chords. These lower forces can lead to smaller cross-section members required. However, this must be balanced with the added material needed throughout the entire truss by making it a deeper total truss depth. As well, this increased depth requires the web members to be longer, which increases the compression member's unbraced length that may result in larger members to resist buckling.

To quickly analyze the forces throughout an entire truss, the following idealizations of the truss must be made (Smith, 2009):

1. Members are straight and carry only axial load. For simple analysis, this assumption also implies the designer neglects the self-weight of the members,

specifically the web members. If the weight of the member is significant, the designer can approximate the effect by applying one half of the self-weight as a concentrated load to the joints at each end of the member. If member self-weight is included in analysis, a bending moment is then induced, increasing the complexity of analysis with minimal difference in overall results.

2. Members are connected to joints by frictionless pins. Thus, no moments can be transferred between the end of a web member and the joint to which it connects. Connections throughout the truss then must allow for rotation between members while still transferring axial forces throughout.
3. Loads are applied only at joints. If loads are applied at non-joint locations, a bending moment is induced into the truss through member supporting the point load above the truss.

All lateral forces for the entire building's main lateral force resisting system (MLFRS) are transferred by braced frames between grids along all major sides of the hangar. However, bracing is required for the diaphragm along the bottom and possibly the top of the truss. This bracing along the diaphragm in-turn provides horizontal bracing for the trusses in its weak direction.

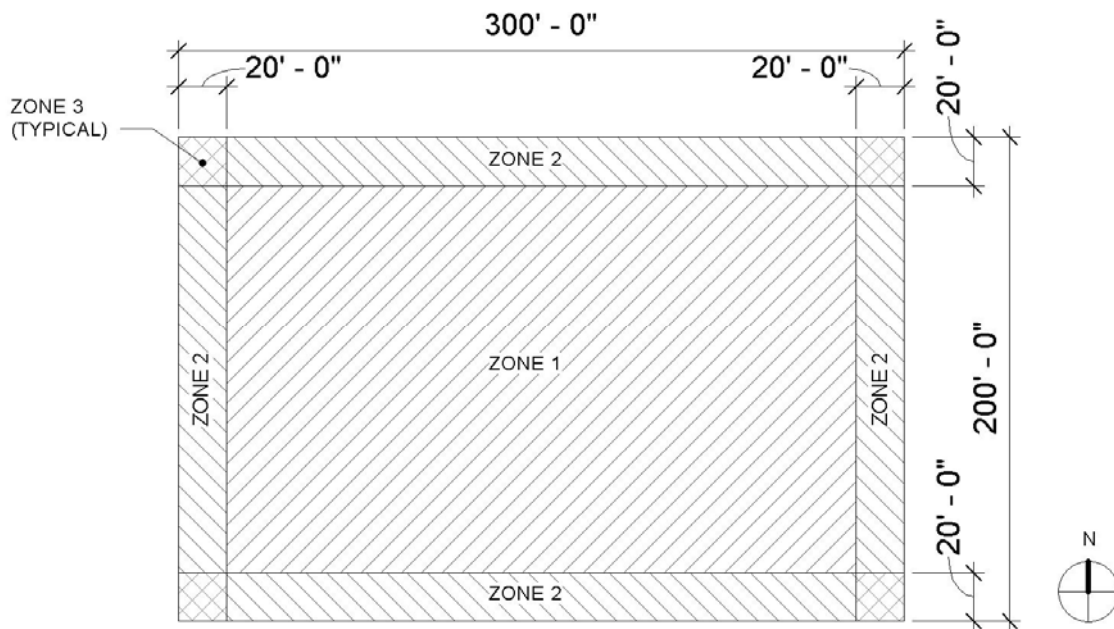
However, when utilizing a computer structural analysis program as this report uses, joints are now treated slightly differently. In reality, connections where joints are bolted with gusset plates or welded connections, some amount of fixity at each joint exists. This would make the truss in analysis highly statically indeterminate. For this report using RISA-3D, joints are considered and analyzed as pinned-pinned conditions; assumption #2 listed above.

## **Loading**

The loads used in analysis are determined in accordance with the 2012 *International Building Code* (IBC), hereafter referred to as the 2012 IBC, which references the ASCE 7-10 for Manhattan, KS where applicable. This includes dead load, construction live load, flat roof snow load, and uplift and downward force caused from wind (components and cladding). The dead load includes member self-weight of the truss along with the weight of the roofing materials, metal decking, and rigid insulation above the truss. These roofing materials are what keep out



the elements such as rain. Dead load of the truss members can be a large factor in the overall truss design, and is a variable examined based on different member selection. The dead load excluding the truss self-weight is 25.0 psf. The roof live load, typically caused by a worker on the roof for servicing needs, is 20.0 psf on the horizontal projected plane. The 2012 IBC in which live loads are taken from in the design process, allows for the reduction of live load based on horizontal projected plane of the slope of the roof and the tributary area of member in analysis. For this analysis, the reduction is used as it greatly reduces the total load on each panel point throughout the truss. Thus, making a more economical truss required to carry less total load spanning the 300'-0". The flat roof snow load,  $p_f$ , equal to 20.0 psf with no rain-on-snow surcharge is applicable. To achieve minimum slope on the roof to avoid ponding issues, the rigid insulation above the metal deck is sloped accordingly at one quarter inch per foot. All loads previously discussed are at service load levels per the ASCE 7-10. As well, the wind uplift on the structure at strength levels per the ASCE 7-10 is 46.3, 52.7, and 52.7 psf for zones 1, 2, and 3, respectively. A diagram of the different roof zones is shown in **Figure 2-8**, in accordance with the ASCE 7-10.



**Figure 2-8: Roof Components and Cladding Zone Diagram**

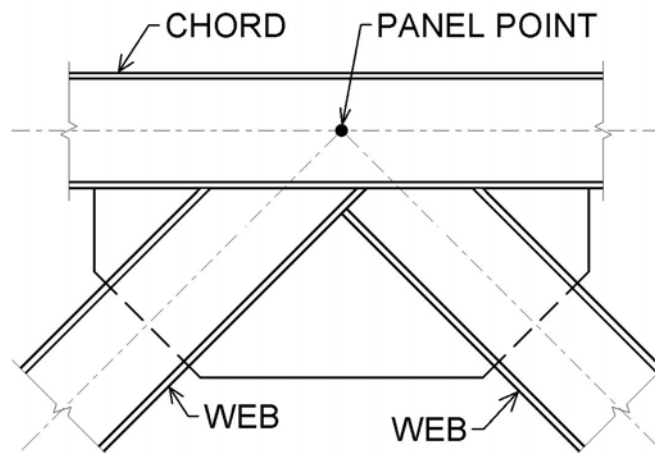
The envelope design method is used per the ASCE 7-10, Section 28.1.1 for buildings limited to 60'-0" or less in height. If the uplift from wind is greater than all others loads applied

downward, then the bottom chord of the truss is put into compression and will change the design considerably. If no net uplift occurs, the bottom chord carries a tensile load.

For calculation purposes, Load Resistance and Factor Design (LRFD) is used throughout this report. All detailed load calculations and load combination used can be found in **Appendix A and B**. Only the applicable load combinations utilizing the loads previously described are used for calculation. Thus, all load combinations with seismic forces involved are not examined as there is no seismic load throughout this report.

### Panel Points

Panel points are the intersection of web and chord members throughout the truss. All roof loads carried by the secondary framing of the roof structure is transferred through bearing to these panel points. The best design practice is to study any specific loading criteria on the roof supported by the truss as well as allowable spans of the roof deck sought by the architect for the project. These specific loads could include HVAC equipment, cranes, or other unique equipment requiring support. Added panel points for these specific locations will reduce the amount of axial load carried by all members surrounding the point load, as well eliminate any moment induced into the truss. Moment can be induced into a truss if any point loads occur at other spots along the truss other than the panel points. **Figure 2-9** illustrates the intersection of members and panel point location.



**Figure 2-9: Panel Point Illustration**

The most economical orientation for web members, to locate panel points, is at a 45 degree angle from the top or bottom chord (Schmits, 2008). If the web members are at a greater or lesser angle, the amount of axial force is increased in each member, potentially requiring a larger member size or extra lateral bracing, thus increasing the overall cost of the truss being designed. For this report, different panel point configurations are studied to prove the most economical orientation of 45 degrees with the overall truss depth set at 15'-0". The results with web members of shallower or deeper angles than 45 degrees and the related design criteria caused by such geometry choices are documented in **Chapter 3**.

### **Overall Intended Results**

Throughout the following analysis, the best truss design practices for panel point orientation, as well as truss member size, grade, orientation and general connection design variables are found. It will consist of a piece-by-piece breakdown of each component and examine alternatives possibly not used in common steel design practices. These different components are examined independently, but include any significant results in subsequent sections if the previous results affect the following.

W-Shape members are proved to be the most economical steel shape to specify for this span of truss due to compressive strength, while also determining the exact orientation of each member throughout the truss. Unique solutions using higher grades of steel for selective members of the truss are found in **Chapter 3**. As well, the benefits of using bolted field connections instead of field welding are examined.

The construction aspects of long-span Warren trusses are then examined. The most economical shipment of the truss while conforming to local transportation regulations for wide-load shipments is examined. This also includes the temporary hoisting/shoring requirements and the equipment needed. As well as, discuss on the differences in site area needed for layout of truss components in either individual piece setup or truss sections prefabricated off-site. This can potentially be a large factor in design consideration as many large facilities utilize the open space below (within the building envelope) for large construction equipment or other storage needs throughout construction.

All calculations are documented for loading used to find truss stresses and forces. Results of the numerous truss models are also included for trusses with members meeting

capacity demands. These are combined with the latest economic information pertaining to steel material prices. This gives a quantitative comparison and options for each variable can be easily compared to other choices as results are achieved. Exact labor costs are not included, rather discussed as precise numbers for fabrication costs vary from one company to the other. To get hard numbers for all labor involved throughout the truss fabrication and erection process is beyond the scope of this report due to its variability.

As well, this report is only based on calculated strength capacity while serviceability issues relating to deflection are not considered. Changing member size and steel grade (resulting in different/smaller member size) changes the overall stiffness of the truss. This changing in total truss stiffness will change the deflection under service loading at each step throughout the parametric study.

## Chapter 3 - Engineering Design Considerations

### Panel Points

As discussed in **Chapter 2**, layout of panel points is the first step in designing a long-span steel truss. Panel point connections connect diagonal web members to the chord members of a truss. These web members deliver axial forces, tensile or compressive, to the truss chord. In bolted connections, a gusset plate is commonly required because of bolt spacing and edge requirements.

The available strength of a panel point connection is determined from the applicable limit states for the bolts or welds and connecting elements (such as gusset plates and members). In all cases, the available strength must exceed the required strength.

In an idealized panel point connection, the neutral axes of the diagonal web members intersect the neutral axis of the horizontal truss chord. As a result, the forces in all members of the truss are axial, as previously noted in **Chapter 1**. It is common practice, however, to modify working lines slightly from the gravity axes to establish repetitive panels and avoid fractional dimensions less than 1/8", or to accommodate a larger panel point connection or a connection for bottom chord lateral bracing, a purlin, or a sway-frame. This eccentricity and the resulting moment must be considered in the design of the truss chord (AISC, 2010b).

In contrast, for the design of the truss web members, the AISC 360-10 Specifications, hereafter referred to as the *Specifications*, Section J1.7 permits that the center of gravity of the end connection of a statically loaded truss member need not coincide with the gravity axis of the connected member. This is because tests performed by AISC have shown that no appreciable difference in the available strength exists between balanced and unbalanced connections subjected to static loading. Accordingly, the truss web members and their end connection may be designed for the axial load, and neglect the effect of this minor eccentricity.

To achieve economy in panel point layout, a balance must be met between the minimum amount of axial force must be applied to web members and unbraced length of each member, where a smaller member of lesser self-weight can be specified. The only variable with panel points, however, is the horizontal distance along the chords that points are selected, mandating the angle and unbraced length of web members connecting panel points. **Table 3-1** summarizes the results of different panel point locations and the resulting angle of the web members. Only

three truss models were run for this variable in overall truss design; one at 45°, then one shallower and one at a deeper angle from horizontal.

### *Panel Point Results*

**Table 3-1: Panel Point Analysis Results**

Member Angle From Vertical	Tributary Area of Panel Point (ft <sup>2</sup> )	Required Web W-Shape	Max Force in Web Members (T or C) (kips)	Web Members Quantity	Total Web Members Weight (lbs)
45°	1500	W14x99	875	20	<b>42,000</b>
42.27°	1374	W14x90	839	22	<b>40,200</b>
48°	1665	W14x109	935	18	<b>43,900</b>

As shown in **Table 3-1**, the most economical panel point layout and resulting web member orientation varies. **Table 3-1** also shows the required W-Shape web members as simply an equal comparison between different panel point layout models. The required shape shown is what was required for strength purposes, with the truss bottom and top chords economized as well (not shown in table however for member size.) The 42.27° layout produced the most economical design for web members based on material costs and was the lightest total weight truss of the three models. The 42.27° layout also would require the greatest amount of fabrication labor as it has the largest quantity of web members. Whereas the 48° layout produced the heaviest web members and overall heaviest truss when accounting top and bottom chord members.

However, only material weight and consequently material price is considered for comparison despite other costs associated with steel construction as previously mentioned in **Chapter 2**. Since all web members in each panel point layout orientation are the same length and would have similar connections throughout, shop labor would be consistent throughout the truss fabrication process for each truss model. Therefore, only a hard number for total steel tonnage is used for comparison purposes. Thus, the 45° layout is used on all following truss analysis models due to the economical balance between web member material weight, total truss weight, and potential fabrication labor involved.

## Steel Shape

While trusses can be composed of any combination of shapes, typically for long span trusses one shape is used throughout the different truss section sets (such as top chord, web, and bottom chord) for simplicity and repetition of fabrication and connection designs. Some possible shapes that could be used in a steel long-span truss include: (1) W-Shapes, (2) Hollow Structural Sections (HSS) square/rectangular or round, (3) WT-Shapes, or (4) Double Angles. All shapes can potentially have different orientation throughout the truss. As well, connection impacts with such shapes as round HSS members occur.

From the basic truss mechanics where all loads applied to the upper chord at panel points are converted into axial loads, all member possibilities are only limited by their unbraced length for compression. Thus, no immediate shapes can be ruled out. With a simple span beam, a W-Shape is beneficial from the geometry of the shape and larger moment of inertia ( $I_x$  or  $I_y$ ) achieved to resist bending. However, all four categories of shapes are examined as a possibility for this report.

From the 14<sup>th</sup> edition of the AISC Steel Construction Manual, hereafter referred to as the *Steel Construction Manual* for compact and non-compact sections the nominal compressive strength is:

“The lowest value obtained according the limit states of flexural buckling, torsional buckling, and flexural-torsional buckling.”

This includes the Euler’s buckling equation where it is a function of:

$$F = \frac{\pi^2 E}{\left(\frac{Kl}{r}\right)^2} \quad (\text{AISC 360-10 EQ E3-4})$$

- $l$  = laterally un-braced length of the member
- $r$  = governing radius of gyration
- $K$  = the effective length factor determined in accordance with Section C2 of the *Steel Construction Manual*

For this truss analysis and ease of comparison, length,  $l$ , is a fixed value based on the  $45^\circ$  panel point orientation used, and  $K$  factor will be set at 1.0 from the idealization of all panel points being a pinned-pinned condition. Further connection detailing discussions are in **Connections** from **Chapter 2**. Modulus of Elasticity,  $E$ , in Euler's equation is a constant for steel at 29,000,000 psi. By quick inspection, the most economical shape is taken as the shape with the largest radius of gyration. With this, a difference in total truss self-weight is compared with the same loading and truss configuration between different steel shapes.

However, per the *Specifications* Section K2, special requirements exist for HSS-to-HSS (both round and square/rectangular) truss connections. These special design requirements are listed on pages 16.1-141 through 16.1-153 of the *Steel Construction Manual* and cover all different applicable connection types such as:

### ***Round HSS***

1. Branches with Axial Loads in T- and Y- Connections
2. Branches with Axial Loads in Cross-Connections
3. Branches with Axial Loads in K-Connections With Gap or Overlap

### ***Rectangular HSS***

1. Branches with Axial Loads in T-, Y- and Cross-Connections
2. Branches with Axial Loads in Gapped K-Connections
3. Branches with Axial Loads in Overlapped K-Connections
4. Welds to Branches

For analysis of different members, the panel point layout was set at  $45^\circ$  from vertical for web members as shown in previous analysis as an economical layout. Different members were tested to see if available capacity could be reached with various steel shapes. However, combinations of mixed members (such as HSS web members with W-Shape chord members) were tested. AISC regularly publishes the availability of all possible shapes at [www.aisc.org/availability](http://www.aisc.org/availability). Designers can then check which of the closest AISC steel mills produce the desired steel shapes for further economy from less transportation costs.

Results of the fourteen different truss models run with the member shape as a variable are summarized in **Table 3-2**. Truss model #1 was all W-Shapes with consistent member sizes



throughout each section set. Truss model #2 was varying member sizes throughout each section set, but only a maximum of three times. Then truss model #3 was similar to the first model in the members are consistent in each section set, but now used a square HSS used for web members. Next, truss model #4 was similar to the model #2 for top and bottom chord members used, but then varying the web members from model #3. Models #5 and #6 are the same top and bottom chord members as model #2, but with a round HSS tube shape used and then varied to see what savings are achieved. Lastly, model #7 has similar chord layouts as model #1 with consistent WT-Shapes for the web members. These are the truss models successful for capacity demand. Where the notation “(Varied)” is not shown, member size and weight is consistent throughout each section set of the truss.

### *Steel Shape Results*

**Table 3-2: Truss Model Shape Variable Results**

Truss Model Number	Truss Member Selection	Sub-Total Weight (lbs)	Total Truss Weight (lbs)
1	W-Shapes Top Chord	47,700	<b>166,200</b>
	W-Shapes Web	42,000	
	W-Shapes Bottom Chord	76,500	
2	W-Shapes Top Chord (Varied)	40,800	<b>128,000</b>
	W-Shapes Web (Varied)	32,200	
	W-Shapes Bottom Chord (Varied)	55,000	
3	W-Shapes Top Chord	47,700	<b>159,700</b>
	HSS Web	35,500	
	W-Shapes Bottom Chord	76,500	
4	W-Shapes Top Chord (Varied)	40,800	<b>122,200</b>
	HSS Web (Varied)	26,400	
	W-Shapes Bottom Chord (Varied)	55,000	
5	W-Shapes Top Chord (Varied)	40,750	<b>140,400</b>
	HSS Tube Web	40,600	
	W-Shapes Bottom Chord (Varied)	59,050	
6	W-Shapes Top Chord (Varied)	40,800	<b>123,600</b>
	HSS Tube Web (Varied)	27,800	
	W-Shapes Bottom Chord (Varied)	55,000	
7	W-Shapes Top Chord	47,700	<b>170,300</b>
	WT-Shapes Web	46,100	
	W-Shapes Bottom Chord	76,500	

As shown in **Table 3-2**, the most economical shape from purely a steel tonnage comparison is the truss model #4 with varied W-Shapes for top and bottom chords and varied HSS square members for the web members. However, economy exists in maximizing repetitive

connection design of web-to-chord members. This repetitious connection design would be easiest accomplished through truss model #1 or #2, where all members for top and bottom chords as well as web members are W14 shapes with similar  $d$  dimensions from top of flange to bottom of flange for each W-Shape. Even though truss model #1 is one of the heaviest total weight trusses of the multiple truss models analyzed, it has the best potential to save labor costs for fabrication and erection costs.

Also, even though truss model #4 and #6 are the most economical for material quantity, the special provisions listed previously for HSS connection design come into effect. This further complicates connection design as the web members for truss model #6 are round HSS members with W-Shape members for the top and bottom chords. Furthermore, the chord members are not similar in size to the web members. The chords are all W14 shapes with the HSS tube size requiring a round HSS16 for strength purposes. This difference in size would complicate connection detailing throughout the truss. A gusset plate welded to the chord members would be needed with the web members being slotted and welded to connect the web members to the chord members. This adds to the labor costs for fabrication and steel erection throughout the truss design.

WT-Shapes were also analyzed as possible members throughout the truss. It was found they could be utilized successfully for web members as shown by truss model #7 in **Table 3-2**. However, these results from the RISA-3D analysis show the sub-total for weight of web members is higher than truss model #1 or #2 for W-Shapes. Thus, the total truss weight is higher where the same W-Shape sections are required for top and bottom chords of the truss. For reference, a WT13.5x108.5 is required for capacity of web members, where a W14x99 was required for truss model #1. Thus, no advantage exists in material weight between a required W-Shape and WT-Shape for web members in the truss. WT13.5 shapes with a lesser weight per linear foot than 108 are slender for compression, which further complicates calculation. WT-Shapes would also generally require more attention for connection design as well, making it further less economical as a possible web member shape.

Throughout the truss analysis process, some shapes were ruled out for possibilities and results not included in **Table 3-2**. Double angles, equal-length legs or long-leg-back-to-back orientation were insufficient for web members. The maximum force in a web member was 887 kips. Per Table 4-8 in the *Steel Construction Manual*, with  $k_1=21.213'$  from the  $45^\circ$  web

orientation layout, the largest double angle possible of 2L8x8x1 1/8 only has an available capacity of 610 kips. Thus, double angles are not sufficient for members with the maximum force and therefore not used for any web members in the truss analyzed for this report. This maximum force in web members occurs near the supports where shear forces are highest for the total truss. No further models involving double angles were run as this initial model with the largest double angle possible did not meet capacities needed.

HSS members were also analyzed as a possibility for use in top and bottom chords of the truss. These truss models analyzed not included in **Table 3-2** are models not meeting needed capacities. These included five different truss models: one with consistent square HSS member for chords and web members, another with varied HSS square members throughout each section set, a third with square HSS member consistent throughout the top and bottom chords and round HSS members for the web members, another model with consistent square HSS members for the chords and varied round HSS members for the web, and lastly a model with varied square HSS members for the chords and varied round HSS member throughout the web. All five of these models did not meet capacities needed for strength purposes. For all truss models, P- $\Delta$  effects are included in the RISA-3D analysis causing bending moments resulting from the deflection of the entire truss under loading. Thus, the member with the most P- $\Delta$  effect is the center member of the bottom chord. The largest possible HSS as a HSS32x32x1.250 still fails under the combined loading of axial force and bending moment. While the largest forces are axial tension in the bottom chord, enough induced moment exists to cause the member to fail. Thus, HSS members are not sufficient for the maximum loading in the chords, and results not included in **Table 3-2**. As well, these jumbo HSS shapes pose a potential problem for availability as they are only produced by limited suppliers per AISC's website, and would cost extra for transportation purposes compared to multiple suppliers carrying the required shape.

In total, fourteen different truss models were analyzed with different combination of consistent members and varied members, but only the truss models analyzed with sufficient capacity members are included in **Table 3-2**. All truss diagrams for member layout of the different successful truss models are located in **Appendix B**.

## Steel Grades

Common if all similar shapes are used, steel grade is typically consistent throughout the entire truss for easy mill ordering and/or better availability of shapes in storage already produced. Within the *Steel Construction Manual*, the American Society of Testing and Materials (ASTM) provides a table of preferred steel grades for the different steel shapes available to designers. These preferred steel grades are simply a recommendation from AISC for easiest availability and what testing has been done throughout history on steel members. However, other steel grades are shown as an alternative to the preferred grade, and many of the design equations within the *Specifications* of the code are a function of steel grade,  $F_y$  and  $F_u$ . As an example, per the *Specifications* Section D2, for tension members with failure modes of tensile yielding and tensile rupture:

$$P_n = F_y A_g \quad (\text{AISC 360-10 EQ D2-1})$$

$$\phi_t = 0.9(\text{LRFD})$$

$$P_n = F_u A_e \quad (\text{AISC 360-10 EQ D2-2})$$

$$\phi_t = 0.75(\text{LRFD})$$

Thus, values obtained in calculation for member tensile capacity can easily reflect the differing higher steel grades. For the possible shapes considered for this report the following **Table 3-3** shows the preferred and alternative steel grades:

**Table 3-3: ASTM Preferred and Alternative Steel Grades**

Steel Shape	Preferred Material			Higher Alternatives		
	ASTM Designation	$F_y$ (ksi)	$F_u$ (ksi)	ASTM Designation	$F_y$ (ksi)	$F_u$ (ksi)
W-Shape or WT-Shape	A992	50	65	A913 Gr. 65	65	80
HSS (Round)	A500 Gr. B	42	58	A618 Gr. III	50	65
HSS (Square or Rect.)	A500 Gr. B	46	58	A618 Gr. III	50	65
Double Angle	A36	36	58	A529 Gr. 55	55	70

The alternatives shown in **Table 3-3** are for different steel grades without limitations based on member component sizes. While many possible alternatives are listed, most have certain criteria to meet in order to use the given design values.

While some shapes have a higher  $F_y$  and  $F_u$  design value, caution should be taken as a designer when specifying higher grades of steel. Higher grades of steel have less carbon percentage within the steel. All preferred steel grades for different shapes already contain a very low percentage of carbon. Carbon in steel provides ductility to the member, allowing it to deflect elastically without damage. Thus, the lower carbon percentage, the more brittle a member will be, increasing the chances for a non-ductile failure mode in the event of failure.

Specialty steel grades can also increase the amount of time to get steel delivered to your jobsite. The entire steel ordering process is typically a lengthy one. Steel mills commonly hot roll shapes at the preferred steel grades, as most projects utilize these preferred materials. Thus, for specialty orders of higher grade steel, it will depend on the steel mill's schedule as to when they will be next rolling a certain shape(s) at a specific steel grade. The possibility of the mill not even rolling a specific combination of shape and steel grade exists as it would not be profitable to the mill for the extremely limited amount of steel needed, versus the amount of time and energy needed to produce such limited quantity shapes. A designer would need to directly contact the steel mill producing the desired shape to check on steel grade availability and costs associated with specialty grades of steel as neither of these important figures are given on AISC's website discussed in **Steel Shapes**.

Results of the same fourteen different truss models with the steel grade as a variable for truss members are shown in **Table 3-4**.

### *Steel Grade Results*

**Table 3-4: Truss Model Steel Grade Variable Results**

Truss Model Number	Truss Member Selection	Steel Grade	Sub-Total Weight (lbs)	Total Truss Weight (lbs)	Weight Savings (lbs)
1	W-Shapes Top Chord	A913 Gr. 65	43,600	134,100	<b>32,100</b>
	W-Shapes Web	A992	38,300		
	W-Shapes Bottom Chord	A913 Gr. 65	52,200		
2	W-Shapes Top Chord (Varied)	Mixed	36,900	117,200	<b>10,800</b>
	W-Shapes Web (Varied)	A992	32,200		
	W-Shapes Bottom Chord (Varied)	Mixed	48,100		
3	W-Shapes Top Chord	A913 Gr. 65	43,600	131,300	<b>28,400</b>
	HSS Web	A500 Gr. 46	35,500		
	W-Shapes Bottom Chord	A913 Gr. 65	52,200		
4	W-Shapes Top Chord (Varied)	Mixed	36,900	110,700	<b>11,500</b>
	HSS Web (Varied)	Mixed	25,700		
	W-Shapes Bottom Chord (Varied)	Mixed	48,100		
5	W-Shapes Top Chord (Varied)	Mixed	43,600	128,600	<b>11,800</b>
	HSS Tube Web	A618 Gr. III	32,8000		
	W-Shapes Bottom Chord (Varied)	Mixed	52,200		
6	W-Shapes Top Chord (Varied)	Mixed	36,900	108,000	<b>15,600</b>
	HSS Tube Web (Varied)	Mixed	23,000		
	W-Shapes Bottom Chord (Varied)	Mixed	48,100		
7	W-Shapes Top Chord	A913 Gr. 65	43,600	136,900	<b>33,400</b>
	WT-Shape Web	A913 Gr. 65	41,100		
	W-Shapes Bottom Chord	A913 Gr. 65	52,200		

The results of varying steel grade are interesting as it varied throughout the analysis of different truss models. Truss model #1 produced one of the largest savings compared to **Table**

**3-2**, where all members along the top and bottom chord are the higher grade of steel. This resulted in smaller members along the top and bottom chords, especially in the bottom chord. However, even with the lighter members utilized, it is still one of the heavier trusses for total weight. This could also cause issues for steel ordering as both top and bottom chords are significant amounts of steel at the higher, specialty grade.

In the truss model #2, the higher grade steel is used in select members, such as the middle of the top and bottom chords, while the recommended steel grade is used throughout the remainder of the truss. This resulted in less savings compared to truss model #1, but was substantially lighter than initially in **Table 3-2** where the same member was not used throughout the entire top and bottom chord. The worst case (controlling case) for member size is the middle of each the top and bottom chord, where the end members of each chord are utilized much less. This is why in **Table 3-4**, there is a substantial difference in truss total weight from model #1 to model #2. So trying to economize this further utilizing different steel grades is much less effective compared to truss model #1.

For the truss model #3, a large weight savings can be achieved, but the model is based on consistent members throughout the top and bottom chords, similar to the truss model #1, with no savings achieved in reducing the size required for web members.

For the truss model #4, savings can be achieved in reducing the web member wall thickness, while maintaining similar overall dimensions. The web members nearest the supports had the increased steel grade to achieve a decrease in member wall thickness. This is due to the high shear forces at the ends of the truss, similar to a simply supported beam, where for a truss equates to a higher axial force for web members near the ends of a truss.

Truss models #5 and #6 also reduce the weight of the total truss, but the savings is mostly from the top and bottom chord members. Truss model #5 and #6 web members have a 7,800 lb and 4,800 lb weight savings, respectively. This savings for web members is minimal relative to the total weight savings of the truss.

The most interesting results were from truss models #3 through #6. In these models, the increase of steel grade had minimal effect on the member size required for strength design. Compared to the higher steel grade alternative for W-Shapes, the HSS higher possible steel grade does not have as significant increase in yield strength,  $F_y$ , and ultimate strength,  $F_u$  from the preferred ASTM steel grade. This minimal change resulted in no material savings for a truss



with higher steel grade for select or entire group of members throughout the truss. This is also similar for truss models with round tube shapes for web members where a slightly greater increase in  $F_y$  from 42 to 50 ksi.

The truss model with double angles used for web members still did not meet strength requirements even with the higher grade of steel utilized in the analysis. This is surprising as angles specified at the higher grade of steel A529 Gr. 55 has a large increase from grade A36 of  $F_y=36$  ksi to  $F_y=55$  ksi and  $F_u=58$  ksi to  $F_u=70$  ksi. However, the limiting factor for double angles is buckling and how the members back-to-back are not symmetric compared to other shapes such as a HSS. As well, the truss models with all HSS members used for both chords and web sections still did not meet strength requirements with the same largest possible HSS shape in RISA-3D of an HSS32x32x1.250 at the higher grade of steel.

In total, the same fourteen truss models were analyzed from the **Steel Shapes** section to see what material savings can be achieved. The results listed in **Table 3-4** only show the truss models of adequate capacity while also producing material savings. Specific truss layout of steel grade and related member sizes for each truss model can be found in **Appendix B**.

### **Member Orientation**

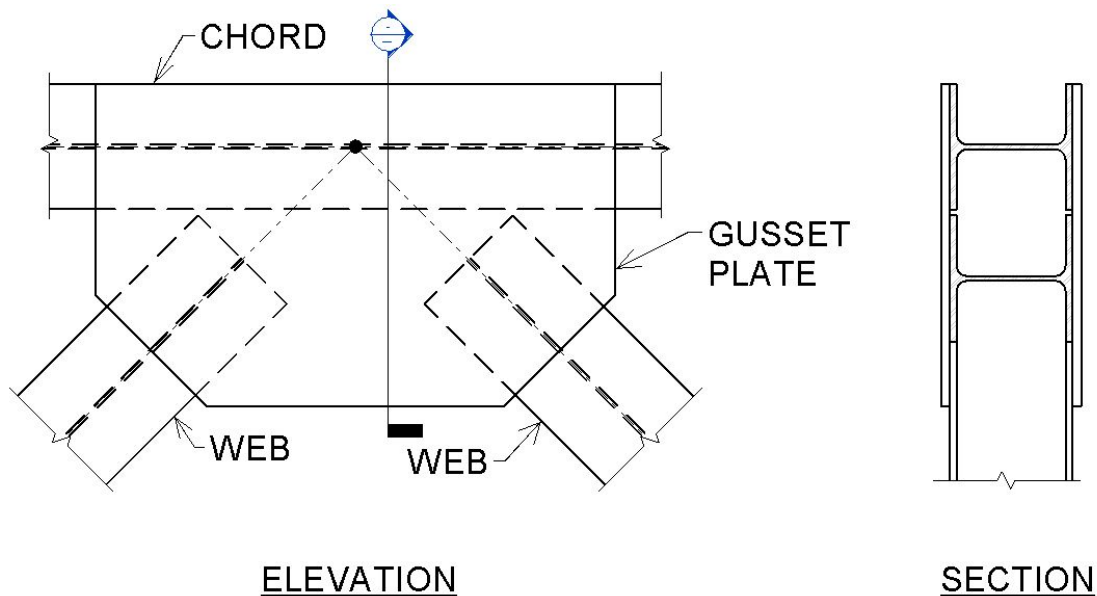
Member orientation within the truss can serve many different purposes. Less common, individual members are rotated to achieve a specific result for better structural capacity. More common, however, sets of members such as the entire top or bottom chord members are oriented a certain way throughout. This rotation of entire sets of members can help achieve lateral stability to a truss in addition to the diaphragm bracing already required for the roof structure. As well, for certain member shapes, rotation helps greatly simplify connection design and detailing.

Trusses are extremely stiff in their own plane, but have little lateral stiffness and therefore must be braced against lateral displacement to achieve the member's full strength capacity. When rotating top or bottom chord members, the engineer is putting the strong-axis of the members in the direction of lateral displacement. For the case of W-Shapes, moment of inertia about the x-axis,  $I_x$ , of the members are now utilized for lateral stability. This rotation minimizes the out-of-plane slenderness effect on the truss. As well, this has minimal effect on

member size where the truss top and bottom chords are carrying mostly axial force, where possible bending about the weak-axis is a negligible concern.

For web members, where different members are subjected to either tensile or compressive forces, stability requirements for compression members require larger member sizes than for equally loaded tension members. Proper orientation of web members can lead to more efficient designs with regards to sizing members for compression.

For connection purposes, with a truss consisting of all W14 shape members, orientation of web and chord members can simplify the connection detailing needed throughout the truss. In the case of this report where a significant amount of field assembly is required for the truss, bolted connections can be accomplished much easier with web horizontal for chord and web truss members. In other words, the webs of all members are perpendicular to the plane of the truss. An illustration of such member orientations is shown in **Figure 3-1**.



**Figure 3-1: Member Orientation Illustration**

For analysis, the results from **Table 3-4** are used to see if any further economy can be achieved by simply changing orientation of members throughout the truss.

### ***Member Orientation Results***

After studying the different combinations of web only, top-chord only, web and top-chord only, top and bottom-chord only, bottom-chord only, and bottom-chord and web only member orientation, no major savings achieved for steel tonnage was found. The required steel shape for strength purposes did not change in any of the truss models in RISA-3D. However, as described previously, other benefits to rotating members throughout the truss exist in connection design.

It should be noted that all truss models with HSS members throughout the truss are not benefited like the rotation of W-Shapes or WT Shapes. This is due to the required shape for axial force was a square HSS member, with the same moment of inertia in both directions. This is contrasted to a W-Shape or WT-Shape where a major difference can be achieved between the moment of inertia about both the x-axis,  $I_x$ , and y-axis,  $I_y$ , values for a given member.

### **Connections**

Connections are one of the largest components of potential savings in the truss analyzed for this report. This is due to the highly variable amount of labor required to accomplish all connections needed throughout the truss. As shown in **Economics of Chapter 2**, fabrication and erection labor costs have remained fairly constant and increased steadily over time, each respectively. For fabrication labor costs, this comes in the form of personnel time required to run the equipment punching the required number and placement of holes for bolted connections. For possible shop welded connections, this consists of the certified welder's time spent making all required welds after steel sections have been cut and prepared for welding.

Per Section J1.7 in the *Specifications* on the placement of welds and bolts:

“Groups of welds or bolts at the ends of any member which transmit axial force into that member shall be sized so that the center of gravity of the group coincides with the center of gravity of the member, unless provision is made for the eccentricity. The forgoing provision is not applicable to end connections of statically loaded single angle, double angle, and similar members.”

Section J1.10 in the *Specifications* on limitations on bolted and welded connections:

“Pretensioned joints, slip-critical joints or welds shall be used for the following connections:

- In all structures carrying cranes of over 5-ton capacity: roof truss splices and connection of trusses to columns, column splices, column bracing, knee braces, and crane supports.

Per Section 13, page 12 of the *Steel Construction Manual* which references the *Specifications*, a minimum required strength of 10 kips for LRFD is suggested in the absence of design loads. However, since loads are known for this report, the loads per ASCE 7-10 will be used.

Since the depth of truss in this analysis is set at 15'-0" and can save on over-size transportation costs, all pieces could be shipped individually to the site and then entirely field connected. However, the quantity and quality of field connection is of concern. For the most economical field connection, the minimal amount of field welding should be considered. Field welding is almost always taken as more expensive over shop welding. Quality control of field welding is also of concern compared to shop welding. Thus, field bolting is commonly used for truss connections where pre-fabricated shop connections cannot be utilized. Staggered bolted connections are also preferred to allow for easier access tightening with a pneumatic wrench, if the connection is all-bolted (AISC, 2010b).

In addition to the design loads and load combinations per the ASCE 7-10, consideration should be given to the induced loads during shipping, handling, and erection. This occurs from pieces of the truss assembled on site and set in place, where design loads are not yet applicable to the truss connections, but self-weight or shoring may induce loads not traditionally anticipated. These are covered in the ASCE 37-02, refer to **Chapter 4**.

Per Section 13 of the *Steel Construction Manual*, member lengthening and shortening due to loading should be considered for field-made connections. This can be of greatest concern at the ends of the truss chords where support is provided by columns. Member length change, while can be small, can cause the truss to encroach on its connection to the supporting column.

This can be overcome with shop-made connections by providing shims to fill out whatever space remains after the truss is erected and loaded.

All field-bolted connections need to take this member length change into account though. An approximation for change in individual member length is given by:

$$\Delta = \frac{Pl}{AE} \quad (\text{AISC 360-10 EQ 13-25})$$

Where:  $\Delta$  = elongation in inches.

$P$  = axial force due to service loads, kips.

$A$  = gross area of the truss chord, in<sup>2</sup>.

$l$  = length, in.

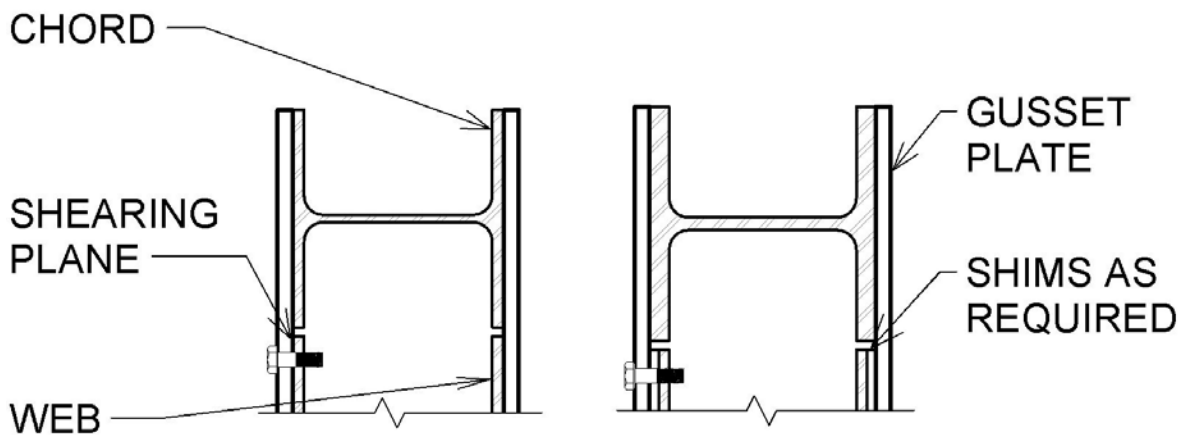
The summation of the individual chord segments will give the total change in length of the truss chord. The misalignment at each support connection of the truss chord is then half the total elongation. For connection design, slotted holes can be used to overcome this change in member length without the reaming of holes or other modifications needed in the field.

### ***Field Bolted Connection***

With a field-bolted connection, gusset plates are generally needed on each side of member flange (if using W-Shapes) at each panel point location. Each bolt is in single shear, one shearing plane between gusset plate and member flange if designing as a bearing-type or slip-critical bolted connection. As discussed in **Truss in Analysis**, the all-bolted connection with gusset plates provides some amount fixity. RISA-3D which utilizes the stiffness method for structural analysis, can take this into account. However, the joints are modeled as pinned-pinned throughout this report in RISA-3D, transferring no moment between members. The exact amount of fixity provided by each connection is somewhere between fully pinned and fully fixed. Thus, for analysis the pinned-pinned condition is used as a design analysis assumption. For truss chords that are non-continuous without eccentric connections represent this design assumption accurately (Smith, 2009).

Bolted connections typically utilize the design values from the *Steel Construction Manual* for bolts where the threads are included in the shearing plane. This greatly reduces the capacity per bolt, but is a conservative design choice. If the threads are to be excluded from the shearing plane, each individual bolt must be guaranteed long enough for each possible connection throughout the truss which additional inspection to verify this is required. This inspection increases the cost of each connection. Therefore, a cost comparison should be performed between designing the connection as threads included versus threads excluded. Threads excluded will require fewer bolts than threads included. Thus, with a truss top and bottom chord of varying member size with varying flange width, the possibility of a connection using the wrong length bolt exists. This can cause a large difference in designed connection capacity to what is then actually constructed if inspection misses the threads included. As well, bolts with threads excluded from the shearing plane requires more field inspection verifying the threads are excluded, resulting in greater costs for the truss and project in total.

**Figure 3-2** shows the difference in shearing planes caused by varying member size throughout the truss and the resulting bolt length concern.



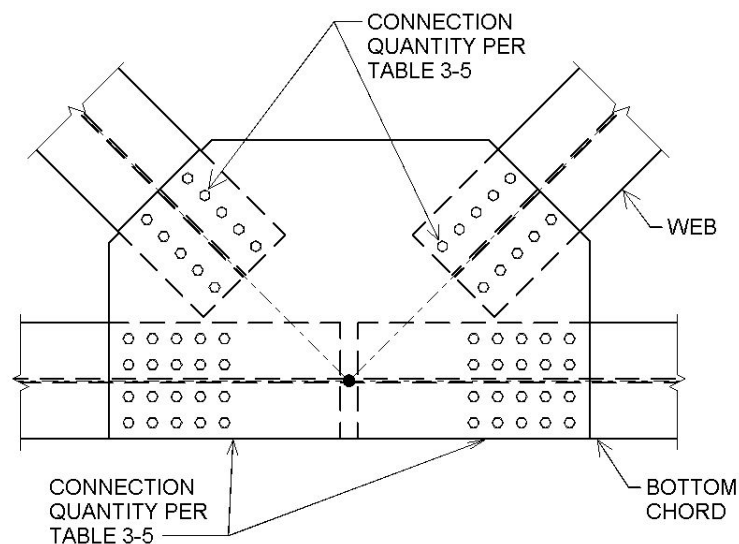
**Figure 3-2: Shearing Plane & Bolt Length Difference**

In **Table 3-5**, a summary of the required number of bolts is shown throughout different components of the truss for a bearing-type connection. The worst-case loading is taken from truss model #1 in **Table 3-2** due to the increased self-weight

**Table 3-5: Bolt Quantity for Different Truss Connections**

Bolt Grade	Bolt Diameter	Bolt Quantity Required Per Connection		
		Web-to-Chord	Top Chord	Bottom Chord
A325N	3/4"	28	34	106
	1"	16	20	60
	1 1/8"	14	16	48
A490N	3/4"	22	28	84
	1"	14	16	48
	1 1/8"	10	12	40

For the listed bolt quantities in **Table 3-5**, the increase in both bolt size and grade benefit the economics of the entire truss. The listed quantities are per connection for members with the largest forces. This is the bottom and top chord connections at mid-span, and the web-to-chord connection near the ends of the truss. The quantity of bolts can be reduced for connections where less force occurs (such as web members near mid-span), but still the total number of bolts for the entire truss is large. The physical size of gusset plate is also directly affected by the number of bolts required per connection. An illustration of the A490N connection for 1 1/8" diameter bolts is shown in **Figure 3-3**.



**Figure 3-3: Sample Connection Showing Required Bolt Quantities**

For a slip-critical connection, additional capacity can be gained with the addition of extra material preparation over a bearing-type condition. With slip-critical connections, the plies of all steel members throughout the connection are held together by clamping forces to resist design loads solely by friction without displacement. However, the faying surfaces must meet specific steel mill surface conditions. Slip-critical connections are only required to be used if the joints at the connection use oversized or slotted holes. The possibility of slotted holes in connection design is discussed earlier relating to member shortening or elongation.

For inspection of bolted connections, it depends on the type of bolted condition designed for. Bearing-type connections require much less inspection, many times simple visual inspection of the individual bolts is sufficient ensuring the plies of the connected elements have been brought into firm contact and washers have been used appropriately. No further inspection is needed for bearing-type connections. From an economic standpoint, this is beneficial where an independent inspector on the job site would need minimal time to visually inspect connections, requiring less pay, and less total cost to the hangar facility.

For slip-critical joints, the inspector must ensure the faying surfaces meet the surface preparation requirements listed on the construction drawings. After the surfaces are verified, the inspector must ensure the turn-of-nut method, calibrated wrench, twist-off-type bolt or other pretensioned joint is properly satisfied. This requires more time spent on site inspecting multiple items, thus more cost for the total project.

### ***Welding***

For field welding, or components such as gusset plates already shop welded to chord members, welds should be limited to a 5/16" thick fillet weld if at all possible. This is due to the maximum size for a single pass, simplest weld, requiring less time by a certified welder. **Table 3-6** shows the minimum weld length on each side of member edge required for strength purposes for a 5/16" fillet weld. These lengths are calculated from Table 8-4 in the *Steel Construction Manual* from the worst-case loading truss model #1 in **Table 3-2** due to the increased self-weight.



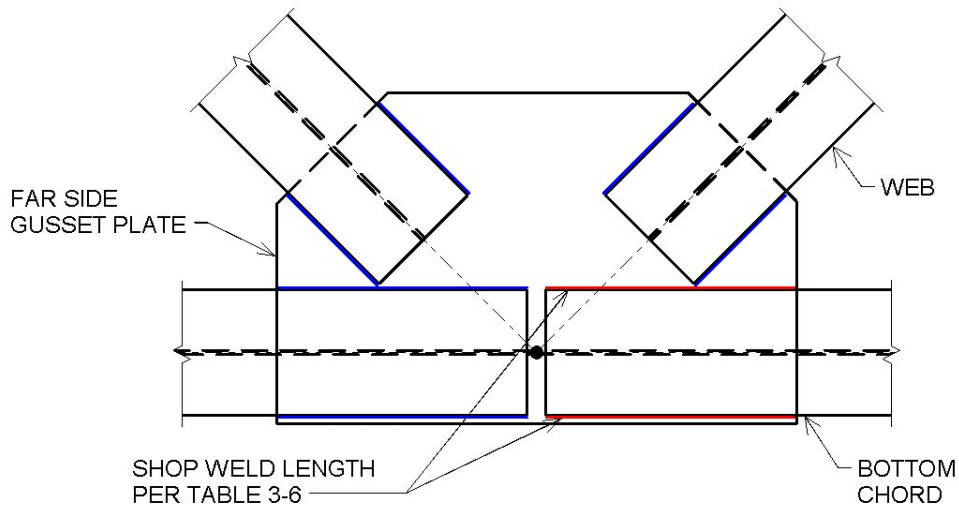
**Table 3-6: Minimum Weld Length for Different Truss Connections**

Length of weld (total along each side of flange) (in)		
Web-to-Chord	Top Chord	Bottom Chord
16	19	60

While it might seem at first more economical to provide a welded connection because of relatively short weld lengths, most of these welds are made in the field. Similar to bolting, all members would need to be setup in place to exact tolerances before welding of joints occurs. For the very long span covered by the truss in the report, tolerances would be hard to meet in the field compared to shop punched holes where quality control is much better.

As well, with some of the longer weld lengths needed, this would require a larger gusset plate connecting the two members at each type of joint in the truss. This increases material cost for the entire truss, and subsequently total hangar facility.

**Figure 3-4** shows a sample connection for welded condition. The red lines show the shop welded members that would then come to the field with gusset plate attached. The remaining welds on the far side gusset plate (shown in blue) would be field welds as well as all welds on the near side gusset plate installed after all welds completed on the far side gusset plate.



**Figure 3-4: Sample Connection Showing Required Welds**

Inspection of welds can be costly. The level of detail which is needed must be specified by the structural engineer on the construction drawings or within the project specifications. Visual inspection is the least time consuming, thus least expensive, and is the most common type of inspection. Joints are inspected prior to welding for fit-up, alignment, gaps, and other prepared conditions of the steel. After the welding is completed, visual inspection is again performed. If any possible issues arise such as poor weld quality, the welds must be repaired or another more costly method used to validate the weld capacity.

Welded connections, though, benefit from the full section being utilized for force transfer. Contrasted with bolted connections, only the bearing area of each bolt into the connecting element is utilized and is the resulting available capacity for bolted connections.

### ***Connecting Gusset Plate***

For gusset plate design throughout the truss, the plates must withstand axial and shear forces as well as any bending moment resulting from deflection of the entire truss. Axial force includes both tension and compression throughout the different web members of the truss as discussed in **Truss Mechanics** from **Chapter 1**.

For field-bolted connections with the webs of all members horizontal, tensile axial force must be guarded from block shear as a failure mode for the gusset plate. This failure mode is different from individual bolts failing in shear as the thickness of the gusset plate affects the connection capacity. The gusset plate capacity is governed by Section J4.3 of the *Specifications*.

$$R_n = 0.6F_u A_{nv} + U_{bs}F_u A_{nt} \leq 0.6F_y A_{gv} + U_{bs}F_u A_{nt}$$

$$\phi_t = 0.9(LRFD) \quad (\text{AISC 360-10 EQ J4-5})$$

Where:  $F_u$  and  $F_y$  are material properties of the gusset plate.

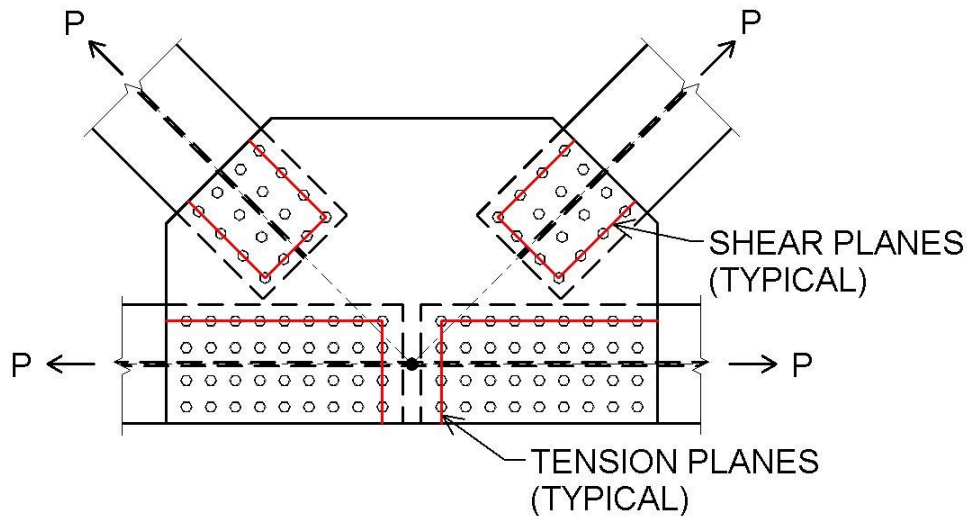
$A_{gv}$  = gross area of the plate for the shear plane

$A_{nv}$  = net area of the plate for the shear plane

$A_{nt}$  = net area of the plate for the tension plane

$U_{bs}$  = 1.0 unless tension stresses are not uniform, then 0.5

The members of the bottom chord of the truss in analysis carry the largest forces, requiring the largest net area of the gusset plate of the truss connections. **Figure 3-5** depicts a simplified illustration of the failure planes involved with block shear for gusset plate design.



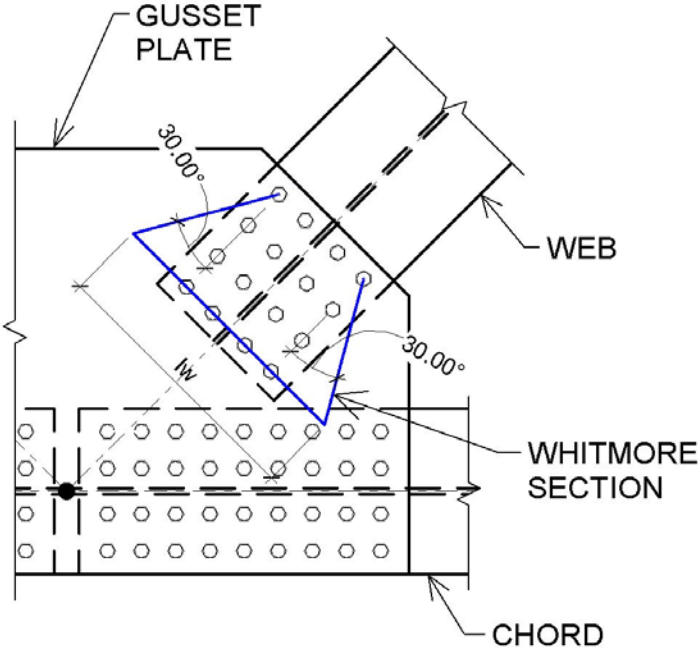
**Figure 3-5: Block Shear Illustration**

The failure planes perpendicular to the member forces are the tension planes, while the planes parallel to the member force are the shearing planes. Each plane is important to the net area subjected to each type of force for the total block shear strength capacity defined by the *Specifications*. These planes are shown in **Figure 3-5** by the bold red lines for clarity. The diameter of bolts also affects the net area of each plane involved in block shear, but is a balance between shear strength of the bolts throughout the connection and the thickness of gusset plate. As well, block shear is a function of the grade of steel used for the gusset plate. A different steel grade rather than the preferred steel grade for plates can be utilized if a greater capacity is needed, but a designer should try to conform with the preferred material per Table 2-4 in the *Steel Construction Manual* for plates and bars. However, a designer must take into account the fabrication of gusset plates with other grades of steel. “Drills might require special bits of different speed/feed parameters, shear may have to be down-rated, blade clearances may have to be tweaked, hold-downs reinforced, and so on. (Anderson, 2011)”

In starting design of gusset plate thickness, the connection of web-to-gusset is first designed to provide a minimum thickness of gusset plate. This is due to the lower forces carried

by the web members for a truss of this span. After this minimum thickness is established, the gusset-to-chord connection is then designed by checking this minimum thickness. If greater capacity is needed for gusset-to-chord connection, a thicker plate or higher grade of steel can then be specified.

As well, with axial forces for large gusset plates, the Whitmore Section can be utilized for area calculations. Whitmore sections are utilized when the connecting elements are large in comparison to the bolted (or welded) joints within them. This Whitmore Section is determined at the end of the joint by spreading the force from the start of the joint 30 degrees to each side in the connecting element along the line of force. If the gusset plate is different steel strength from the web or chord members, the Whitmore section can take advantage of the higher strength materials. “Once the lower strength material (typically the gusset plate) reaches its yield strength, it will strain and allow the load to distribute to the higher strength material. This is an inelastic but self-limiting deformation, and any tendency to rotate due to the uneven stress distribution is limited by the surrounding material that do not participate in load resistance, but would have to shear for rotation to occur. (Thornton & Lini, 2011)” **Figure 3-6** illustrates the Whitmore Section in blue lines for clarity of gusset plate connections.



**Figure 3-6: Whitmore Section Illustration**

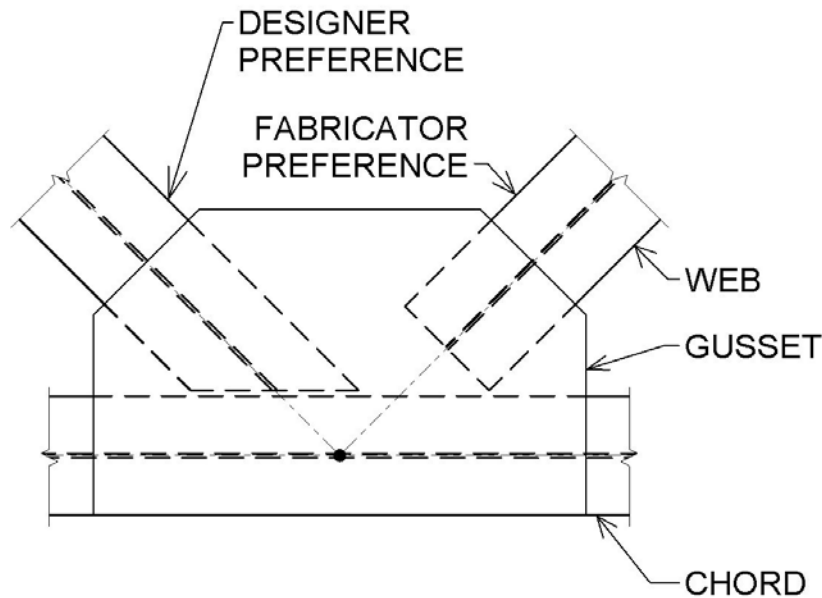
For the same truss connection orientation, but subjected to compressive forces the gusset plate must be designed to resist the limit states of yielding and buckling per Section J4.4 of the *Specifications*.

$$P_n = F_y A_g \quad (\text{AISC 360-10 EQ J4-6})$$
$$\phi_t = 0.9(\text{LRFD})$$

This section of the *Specifications* is for connecting elements that have a slenderness ratio,  $Kl/r$  value of 25 or less, whereas the design of other members with larger  $Kl/r$  per Chapter E of the *Specifications*.  $K$  is taken theoretically as 0.5 for a fixed-fixed condition, as the bolted connection prevents rotation of the plate at the ends, with a value of 0.65 recommended and verified (Gross, 1990). However,  $K$  can be taken as 1.0 conservatively, for a smaller value for  $Kl/r$ . The unbraced length,  $l$  is taken as the length from the end of the Whitmore section width ( $l_w$  in **Figure 3-6**) along the line of force, which is the centerline of the member for an idealized truss. The  $K$  value of 0.65 was used for either bolted or welded connection for this report, as either type of connection provides fixity against rotation in the plate.

For the value of  $A_g$  within the Equation J4-6, the Whitmore Section width,  $l_w$ , is then multiplied by the thickness of the gusset plate. Thus for a set truss geometry from panel point layout, the only additional capacity can be gained from increasing the plate thickness, increasing  $A_g$  for connecting element capacity.

As well, a difference exists in preference for engineering purposes and fabrication purposes for the end of web members. **Figure 3-7** illustrates the difference in member end preferences.



**Figure 3-7: Member End Preference Illustration**

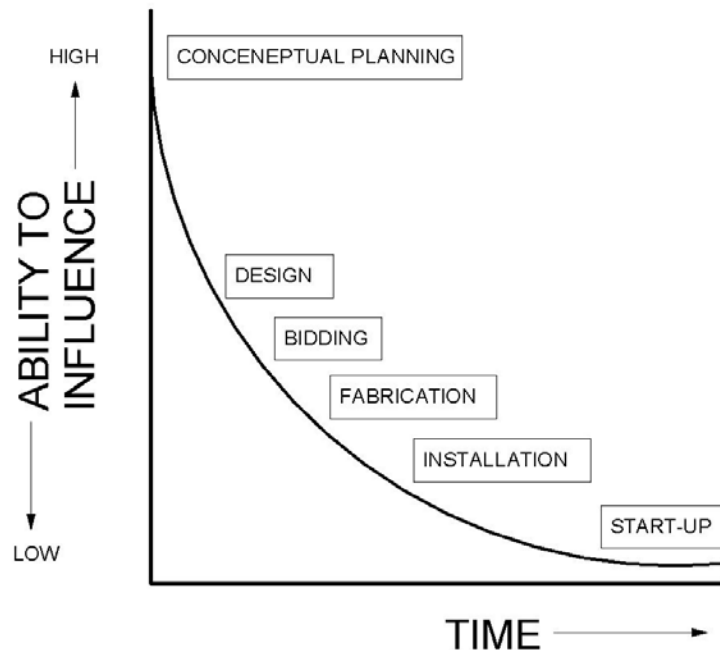
In **Figure 3-7**, the designer preference is the web member cut to minimize the unbraced length of the gusset plate for calculation purposes involving Equation J4-6. However, this slanted end is a more difficult cut to perform in the fabrication shop over a square cut perpendicular to the length of the member. If a designer chooses to use the slanted member end cut, the details on the drawings should show this as it will add complexity to the overall truss connection design.

## Chapter 4 - Construction Considerations

Constructability has been defined by the Construction Industry Institute as:

“The optimum use of construction knowledge and experience in planning, design, procurement and field operations to achieve overall project objectives.” (Ruby, 2006)

This concept brings real benefits to all involved throughout the design and construction process: clients, engineers, architects, contractors, and users of the building. Constructability is the idea of thinking through the entire project prior to any actual design work being started. This early planning will help in maximizing simplicity of the truss, as well as economy and speed of construction. However, it also takes into account site conditions, code restrictions and owner’s requirements of the building. An illustration of this early construction coordination throughout the entire design and construction process is shown in **Figure 4-1**.



**Figure 4-1: Graphical Representation of Constructability (adapted from *Constructability: Maximizing Simplicity*)**

By incorporating the construction knowledge earlier than typically done, more alternatives can be equally compared, leading to better informed decisions being made.

Contractors, steel fabricators, and erectors all bring valuable information pertaining to up-to-date cost and scheduling information. This early addition of knowledgeable people to a design team is different from value engineering, which typically takes place after major decisions have been made and construction drawings and project specifications have been issued.

Some major roles played by general contractors, steel fabricators, and steel erectors in constructability are:

- *Development of the Project Plan.* This can help avoid flaws relating to construction sequence and schedule that would otherwise hinder deliveries and installation, or other construction durations that are not feasible. As most structural engineers are not formally trained on scheduling for projects, these factors can be easily overlooked.
- *Site Layout.* For a large truss as looked at throughout this report, this is important as it can cause inefficiencies during construction. This includes inadequate lay-down area for assembly of truss components and eventually the entire truss, or limited access for personnel and material deliveries. As well, limitations on the availability of installation methods or equipment can be of site layout concern. This would include equipment such as portable air compressors for pneumatic wrenches needed for bolted connections.

Another benefit of bringing the construction perspective into the design stage is the reduced project risk and improved quality. Since the construction team is being utilized during the creation of construction documents, their perspective is inherently incorporated into the construction drawings and project specifications. This will improve the completeness of final documents produced for detailing purposes. As well, this completeness will level the playing field for competitive bids by general contractors (if not already in contractual agreement for the project) as general contractors cannot “low-ball” their bids relative to other general contractors. Low-ball bids come from contractors not receiving complete detailed information on plans and project specifications, and contractors not “connecting-the-dots” for what is needed on the project. Conscientious general contractors will include these extra costs, but in the process price



themselves out of the competition for the new project. Poorly prepared construction drawings and project specifications can lead to poor contractor selection.

## **Transportation**

As discussed in **Chapter 2**, the most economical depth for the 300'-0" span truss is between 15'-0" and 20'-0" with all truss models in this report using a depth of 15'-0" for analysis. The Kansas Department of Transportation (KDOT) is investigated as a representative governing body with other states having comparable highway transportation regulations. The Kansas maximum legal width limit for highways is set at 8'-6" and maximum legal gross weight limit is 80,000 pounds (KDOT, 1996). However, wide load permits are available for purchase for loads over 8'-6". With the minimum truss depth set at 15'-0", a wide load permit would be required for a truss condition where multiple sections are spliced in the field after being shipped in sections to the job site.

For KDOT, the costs of an over-size transportation permit are as follows:

- \$5.00 for each single-trip permit
- \$125.00 for each annual permit
- \$2,000.00 per year for each qualified company, plus \$50.00 per power unit (truck) operating under this annual permit

When purchasing an over-size transportation permit, the width of possible load is increased to a maximum of 16'-6" and gross weight varying per type of permit purchased. However, for a possible spliced truss, the limiting factor is the width where total gross weight is commonly not a concern.

As well, KDOT requires a pilot car(s) for over-size loads 14'-0" or wider. KDOT mandates one pilot car in front and one behind the rig. However, if the route is exclusively 4 lanes or less, the rear pilot car can be eliminated with the use of an amber light on the truck cab and rear of the load being transported. KDOT also restricts the time for transportation of these over-size loads to between a half hour before sunrise and a half hour after sunset all days of the week, with no overnight movements allowed.

For the truss in analysis, the fewest trips required for possible spliced connection shipment is 6 per truss, using a standard 53'-0" allowable length flatbed. The hanger in analysis has 3 Warren trusses throughout the roof structure, bringing the total number of trips for shipment to 18 trips with a wide-load transportation permit.

For a construction job with a possible spliced truss, a company that does frequent over-size loads would likely be utilized on the project. However, the permit costs would be included in the cost per mile commonly charged by transportation companies to haul from the fabrication shop to the job site. This extra cost for transportation will add to the total construction cost, making it likely less economical when compared to a completely site constructed truss.

Also, the coordination of deliveries to the site and required area to store materials until the trusses are actually assembled. The idea of just-in-time deliveries to the job site will greatly reduce congestion and other coordination issues amongst multiple trades while working on the job. Just-in-time delivery is simply minimizing the time between when the transportation crew arrives and unloads the steel members onto the site until the steel members are used (erected) on the structure. This provides the most economical solution for delivery purposes to the site, but needs to be highly coordinated, especially if utilizing multiple steel fabricators for a single job. This reduces the amount of shipping and handling required for all needed materials, an economic benefit for a large truss composed of many individual members.

## **Steel Erecting**

One of the largest construction considerations for a large steel project, such as the truss in analysis for this report, is the steel erecting to get the final in-place solution provided on construction drawings from the structural engineer. However, many times the structural engineer of record has a vague "catch-all" general note on their plans stating something such as:

"The structure is stable only in its completed form. Temporary supports required for stability during all intermediate stages of construction shall be designed, furnished and installed by the contractor. Contractor is responsible for construction analysis and erection procedures, including design and erection of falsework, temporary bracing, etc."

This is due to structural engineers only being legally responsible for the final completed form on the structure. A typical design fee for the structural engineer would not include this extra work involved to help in the steel erection process. However, for large and complicated steel structures such as the truss for this report, this vague general note is simply a liability reducing measure taken by the structural engineer, but does not help in actually constructing the truss. Ideally, the structural engineer should get the contractor and steel erector in meetings throughout the design process. This way, constructability issues can be dealt with throughout the design process instead of addressing the issue after construction drawings have been issued by the structural engineer. As well to note, during the steel erection process deflection limits associated with permanent structures do not necessarily apply to temporary conditions.

The driving force behind steel erection concerns is stability. Steel erectors for a large truss would be most concerned with the top chord of the truss. This is because of the multiple pick points used to lift the field assembled truss into place from the top chord. However, a steel erector would be concerned if it is acceptable to take the truss off lifting hooks once in place, or if any additional bracing or guy wires are needed beforehand (Jacobs & Rex, 2012). In general, a quality steel erector will likely have a good idea of how to best erect the truss. The structural engineer should start with these ideas and build upon those ideas while meeting standards currently in place such as the ASCE 37-02; see the following section for further information on the ASCE 37-02. To best communicate any erection steps, whether dictated by the structural engineer of record for the project or secondary erection engineering firm hired by the general contractor, something as simple as a bulleted list of erection steps or as involved as an animated or highlighted Revit 3D model to convey exact procedures should be used (Jacobs & Rex, 2012).

Per the AISC 303-10, *Code of Standard Practice for Steel Buildings and Bridges*, hereafter referred to as the AISC 303-10, Section 7.13.1.2(h) pertaining to erection tolerances states:

“For a member that is field-assembled, element-by-element in place, tolerances shall be met in the supported condition with working points taken at the point(s) of temporary support.”

This condition in turn references 7.13.1.2(d) for exact tolerance values. These tolerance values for plumbness, elevation, and alignment shall be 1/500 of the distance between working

points. For the truss in analysis, web members and chord members must meet 0.50” and 0.72” tolerances, respectively.

Trusses completely fabricated in the field are potentially more sensitive to deflections of the individual truss components and the partially completed work during erection, particularly the chord members (ASIC, 2010b). The erection process and plan shall address this issue. See **Connections** within **Chapter 3** for ways to address this issue.

### ***ASCE 37-02***

For design considerations needed throughout steel erection, construction loading is a large issue. The primary document addressing these construction loadings is the ASCE 37-02, *Design Loads on Structures During Construction*, hereafter referred to as the ASCE 37-02. In this standard published by ASCE, minimum design load requirements during construction are given for buildings and other structures. Similar to the ASCE 7-10, the ASCE 37-02 bases its loads on probabilistic analysis as well as observation of construction practices, and expert opinions. It provides temporary loading information, load combinations, and wind velocity reduction factors for temporary loading.

The ASCE 37-02 does not explicitly prescribe who is responsible for the design of temporary loading. These roles and responsibilities are commonly defined by state law and the contracts effective among the parties involved throughout construction. As well, the ASCE 37-02 does not account for loads caused by gross negligence and error (Subrizi, Fisher, & Deerkoski, 2004).

The 2012 IBC is the model building code adopted with any changes needed by local jurisdictions. The 2012 IBC in turn references other standards such as many of the ASCE publications. In fact, the 2012 IBC does not mention the word erection a single time throughout the entire document. This leaves the ASCE 37-02’s use up to the engineer and contractor’s discretion.

From the ASCE 37-02, the temporary wind loading often controls design for construction loading. However, a minor disconnect occurs between the construction loading prescribed by the ASCE 37-02 and the wind loading determined for permanent structures in the ASCE 7-10. This is due to the drag factors and multiple wind surfaces associated with the open-structure wind loading. The ASCE 37-02 does recommend a maximum force reduction of only fifteen

percent though due to shielding for members in the fourth and subsequent rows of framing. This demonstrates wind loading is a major factor in design for steel erection. However, construction loading does not cover loads that are not predictable, such as loads from hurricane, tornado, earthquake, explosion or collision.

## **Temporary Structures**

Many times for erecting these large trusses into their final place as shown on construction drawings, temporary structures and/or foundations are needed. After erecting the truss on the ground, large roof trusses can utilize shoring towers with jacks to help lift and stabilize the trusses while the rest of the roof framing is installed and fastened to complete the roof structure. These possible shoring towers would require the rental or possible design of the tower structure as well as the design and installation of independent foundation systems below the towers. These temporary foundations add material and labor costs to the overall project, and should only be used as a last resort. These temporary foundations as well can be left in place below the finish floor/surface after erection and stabilization of the roof structure is complete, or removed if required for use of the space below grade for function of the building.

Other temporary structures needed for constructability concerns are the points of contact to which guy wires or other temporary bracing or shoring are anchored to. These hold-down locations must be sufficient in structural strength to withstand loading, while being mobile enough to be re-used after guy-wires are not needed for a particular application. This re-use of materials or pre-cast members will reduce material costs, while only minimally impacting labor costs for handling of anchors and other temporary but moveable structures.

Per the AISC 303-10, Section 7.10.4 relating to temporary structures states:

“All temporary supports that are required for the erection operation and furnished and installed by the Erector shall remain the property of the Erector and shall not be modified, moved, or removed without the consent of the Erector. Temporary supports provided by the Erector shall remain in place until the portion of the Structural Steel frame that they brace is complete and the lateral-load-resisting system and connecting diaphragm elements are installed. Temporary supports that are required to be left in place after the completion of Structural Steel erection shall be removed when no longer needed and returned to the Erector in good condition.”

This code of standard practice is a common publication ensuring different quality control practices throughout the design and construction process. Section 7.10.4 listed above simply protects the Erector during the construction process and outlines the responsibility and care taken for temporary supports. The structural engineer must identify on the construction documents:

- The lateral-load-resisting system and connecting diaphragm elements that provide for lateral strength and stability in the completed structure.
- Any special erection conditions that are required by the design concept.

A better solution to potentially avoid temporary structures altogether is the use of portable cranes. The rental of such cranes can be more economical, even if required on site for multiple days, over the time needed to excavate, material cost and labor time all required for foundations. Multiple portable cranes would be required to help provide more pick points for lifting the truss into place after assembly on the ground is complete.

## Chapter 5 - Conclusions

This report has investigated the economical design and construction considerations for a 300'-0" span, one-way, Warren, steel truss. While only carrying gravity loads at the panel points in the 2D plane, each design consideration was examined independently to determine what resulted from a parametric study.

While many of the results tabulated in the design consideration results are based on material quantity, one should also realize many other variables related to each design decision exist. While something as simple as changing the grade of steel on selective members or entire member sets, this can and will increase the steel ordering time from the mill. As a structural engineer, one should keep this in mind when specifying steel.

As well, these variables also need to be considered with constructability issues in mind. A truss could be extremely economical from a design stand point, but might be extremely complicated or even nearly impossible to construct. Many times, these constructability issues outweigh the design economic considerations as constructability is a labor intensive process. As shown, labor costs associated with steel construction has held steady or increased in recent years at 60 percent of the total cost compared to the material cost at roughly 25 percent.

The conclusions that can be drawn from this parametric study and discussions are:

- Varying the steel member size throughout the truss achieves a significant weight savings.
- W-Shapes are the most practical for consistent layout and easier connection design.
- Steel grade has minor impacts for savings, but must be weighed against the extra lead time needed to get specialty grade members from the steel mill.
- The earlier in the design process a structural engineer brings on a steel fabricator and/or general contractor to discuss the possible (big or small) design choices, the more economical the final truss design.
- Less material weight does not always equal the most economical design.

- Quality control in the fabrication shop will be greater over field conditions, but may not always be achievable due to other factors, such as transportation limitations or availability of workforce.

The complete design of a truss is a balancing act between all possible variables throughout the design and construction of the structural member. There are multiple solutions to truss design, but structural engineers should gather as much information from knowledgeable people throughout the entire design and construction process to achieve a soundly designed and successfully constructed truss.



## Bibliography

- American Institute of Steel Construction (AISC), (2010). *Code of Standard Practice for Steel Buildings and Bridges*, Chicago, IL.
- American Institute of Steel Construction (AISC), (n.d.). *Made In America*. Retrieved November 12, 2012, from American Institute of Steel Construction:  
<http://www.aisc.org/content.aspx?id=32622>
- American Institute of Steel Construction (AISC), (2010a). *Specifications for Structural Steel Buildings*, Chicago, IL.
- American Institute of Steel Construction (AISC), (2010b) *Steel Construction Manual*, Chicago, IL.
- American Institute of Steel Construction (AISC). (2012, June). Typical Mill Pricing W14x68. Chicago, Illinois, United States of America.
- American Society of Civil Engineers (ASCE), (2010). *American Society of Civil Engineers: Minimum Design Loads for Buildings and Other Structures 2010*. Reston: American Society of Civil Engineers.
- Chen, W., & Lui, E. M. (Eds.). (2005). *Handbook of Structural Engineering*. New York: CRC Press.
- Carter, C. J., & Schlafly, T. D. (2008, March). Save More Money. *Modern Steel Construction*, 55-59.
- Gross, J. L. (1990). Experimental Study of Gusseted Connections, *Engineering Journal*, 27(3), 89-97.
- International Building Code (IBC) (2012). International Building Code Council, 2012.
- Jacobs, W. P., & Rex, C. O. (2012, April). Erection Engineering: The Science Behind the Art. *Modern Steel Construction*, 44-46.
- Kansas Department of Transportation (KDOT) Oversize/Overweight Permits (1996).
- McKee, B. (2007, August). Structural Steel. *Modern Steel Construction*, 22-29.
- Ruby, D. (2006, June). Constructability: Maximizing Simplicity. *STRUCTURE Magazine*, 52-54.
- Smith, M. (2009). *An Analysis of Secondary Stresses in Steel Parallel Chord Pratt Trusses*. Manhattan: Kansas State University. Retrieved from <http://k-rex.k-state.edu>

- Schmits, B. (2008). *Design Considerations for Parallel Chord One-Way Long-Span Steel Trusses*. Manhattan: Kansas State University. Retrieved from <http://k-rex.k-state.edu>
- Subrizi, C., Fisher, A., & Deerkoski, J. S. (2004, March). Introducing SEI/ASCE 37-02 Design Loads on Structures during Construction. *STRUCTURE Magazine*, 26-28.
- Thornton, W., & Lini, P. (2011, July). The Whitmore Section. *Modern Steel Construction*, 52-56.

# Appendix A - Building Load Calculations (IBC 2012 & ASCE 7-10)

## Dead and Live Loads

### DEAD

ASCE 7-10, Table C3-1

ITEM	DESCRIPTION	WEIGHT (psf)	REFERENCE
Roof Covering	Waterproofing Membranes: Bituminous, smooth surface	1.5	
Insulation	Rigid Insulation: 0.75/.5" x 6 for 3" total	4.5	
Deck	3" deck, metal, 18 gage	2.5	
MEP	Including sprinklers	4.0	
Cat Walk System		10.0	**Assumed
Miscellaneous		2.5	
Sub-Total		<b>25.0</b>	

### LIVE

IBC 2012 Section 1607.11

ITEM	DESCRIPTION	WEIGHT (psf)	REFERENCE
Ordinary flat, pitched, and curved roofs		20.0	
	$L_r = L_o R_1 R_2$ where: $12 < L_r < 20$ $R_1 = 0.6$ by $A_T$ greater than $600\text{ft}^2$ for panel point $R_2 = 1$ by $F < 4$ in $1/4"/12"$ slope		IBC '12 EQ'N 16-25
	$L_r = 12\text{psf}$		
Total		<b>12.0</b>	

# Snow Loading

## SNOW LOADING (ASCE7-10)

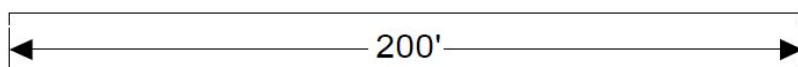
### Building details

Roof type Flat  
Width of roof  $b = 200.00$  ft

### Ground snow load

Ground snow load  $p_g = 20.00$  lb/ft<sup>2</sup>  
Density of snow  $\gamma = \min(0.13 \times p_g / 1\text{ft} + 14\text{lb/ft}^3, 30\text{lb/ft}^3) = 16.60$  lb/ft<sup>3</sup>  
Terrain type C  
Exposure condition (Table 7-2) Fully exposed  
Exposure factor (Table 7-2)  $C_e = 0.90$   
Thermal condition (Table 7-3) All  
Thermal factor (Table 7-3)  $C_t = 1.10$   
Importance category (Table 1-1) II  
Importance factor (Table 7-4)  $I_s = 1.00$   
Min snow load for low slope roofs (Sect 7.3.4)  $p_{f\_min} = I_s \times p_g = 20.00$  lb/ft<sup>2</sup>  
Flat roof snow load (Sect 7.3)  $p_f = \max(0.7 \times C_e \times C_t \times I_s \times p_g, p_{f\_min}) = 20.00$  lb/ft<sup>2</sup>

Balanced load

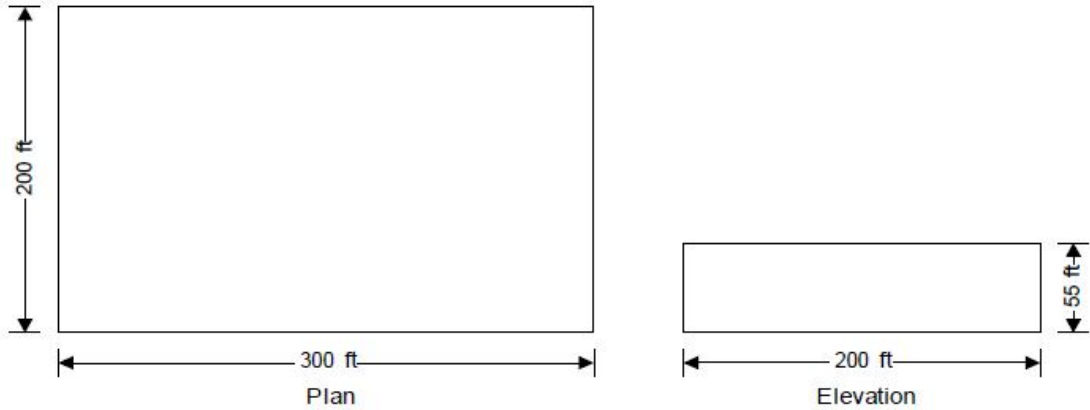


Roof elevation

# Wind Loading

## WIND LOADING (ASCE7-10)

Using the components and cladding design method



### Building data

Type of roof	Flat
Length of building	$b = 300.00$ ft
Width of building	$d = 200.00$ ft
Height to eaves	$H = 55.00$ ft
Mean height	$h = 55.00$ ft

### General wind load requirements

Basic wind speed	$V = 115.0$ mph
Risk category	II
Velocity pressure exponent coeff (Table 26.6-1)	$K_d = 0.85$
Exposure category (cl.26.7.3)	C
Enclosure classification (cl.26.10)	Partially enclosed buildings
Internal pressure coeff. +ve (Table 26.11-1)	$GC_{pi,p} = 0.55$
Internal pressure coeff. -ve (Table 26.11-1)	$GC_{pi,n} = -0.55$
Gust effect factor	$G_f = 0.85$

### Topography

Topography factor not significant	$K_{zt} = 1.0$
-----------------------------------	----------------

### Velocity pressure

Velocity pressure coefficient (T.30.3-1)	$K_z = 1.11$
Velocity pressure	$q_h = 0.00256 \times K_z \times K_{zt} \times K_d \times V^2 \times 1 \text{ psf/mph}^2 = 31.9$ psf

### Peak velocity pressure for internal pressure

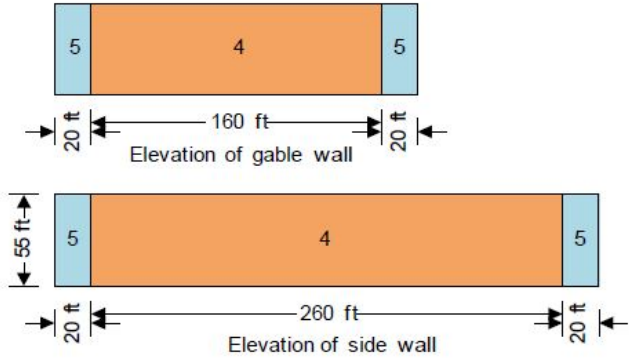
Peak velocity pressure – internal (as roof press.)	$q_i = 31.94$ psf
--	-------------------

### Equations used in tables

Net pressure	$p = q_h \times [GC_p - GC_{pi}]$
--------------	-----------------------------------

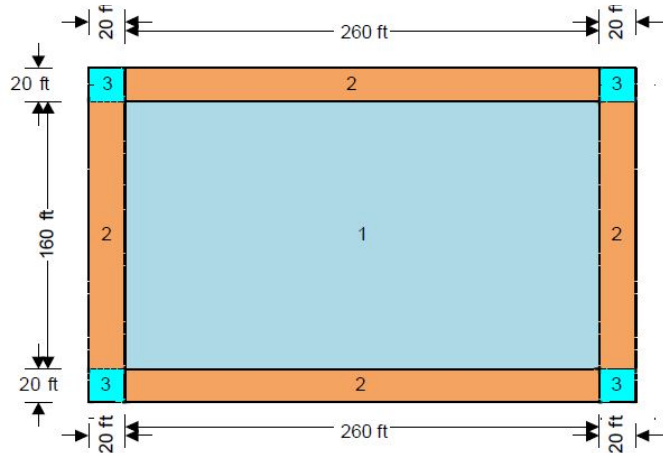
Components and cladding pressures - Wall (Figure 30.4-1)

Component	Zone	Length (ft)	Width (ft)	Eff. area (ft <sup>2</sup> )	+GC <sub>p</sub>	-GC <sub>p</sub>	Pres (+ve) (psf)	Pres (-ve) (psf)
<10sf	4	-	-	10.0	0.90	-0.99	46.3	-49.2
50sf	4	-	-	50.0	0.79	-0.88	42.8	-45.6
200sf	4	-	-	200.0	0.69	-0.78	39.7	-42.6
>500sf	4	-	-	500.0	0.63	-0.72	37.7	-40.6
<10sf	5	-	-	10.0	0.90	-1.26	46.3	-57.8
50sf	5	-	-	50.0	0.79	-1.04	42.8	-50.7
200sf	5	-	-	200.0	0.69	-0.85	39.7	-44.6
>500sf	5	-	-	500.0	0.63	-0.72	37.7	-40.6



Components and cladding pressures - Roof (Figure 30.4-2A)

Component	Zone	Length (ft)	Width (ft)	Eff. area (ft <sup>2</sup> )	+GC <sub>p</sub>	-GC <sub>p</sub>	Pres (+ve) (psf)	Pres (-ve) (psf)
<10sf	1	-	-	10.0	0.30	-1.00	27.2	-49.5
25sf	1	-	-	25.0	0.26	-0.96	25.9	-48.2
50sf	1	-	-	50.0	0.23	-0.93	24.9	-47.3
>100sf	1	-	-	100.0	0.20	-0.90	24.0	-46.3
<10sf	2	-	-	10.0	0.30	-1.80	27.2	-75.1
25sf	2	-	-	25.0	0.26	-1.52	25.9	-66.2
50sf	2	-	-	50.0	0.23	-1.31	24.9	-59.4
>100sf	2	-	-	100.0	0.20	-1.10	24.0	-52.7
<10sf	3	-	-	10.0	0.30	-2.80	27.2	-107.0
25sf	3	-	-	25.0	0.26	-2.12	25.9	-85.4
50sf	3	-	-	50.0	0.23	-1.61	24.9	-69.1
>100sf	3	-	-	100.0	0.20	-1.10	24.0	-52.7



# Appendix B - Truss Analysis Detailed Results

## Truss Model Diagrams

Note that only half of each truss model is shown for better clarity, where all truss models are symmetric about the mid-span point.

### Steel Shapes

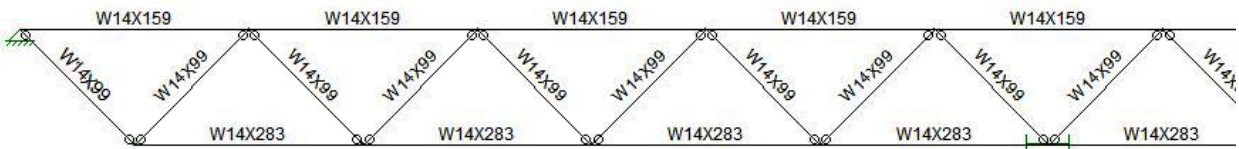


Figure B-1: Truss Model #1 Member Layout

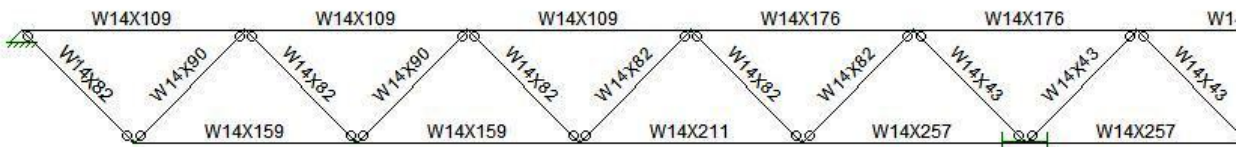


Figure B-2: Truss Model #2 Member Layout

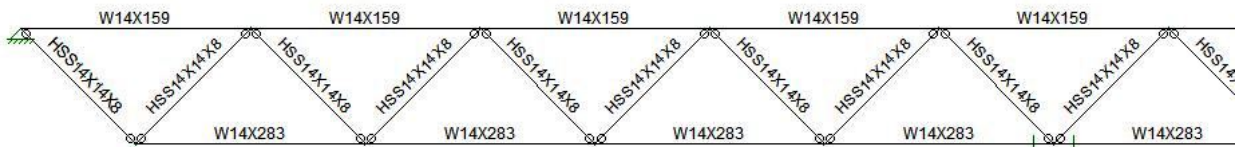


Figure B-3: Truss Model #3 Member Layout

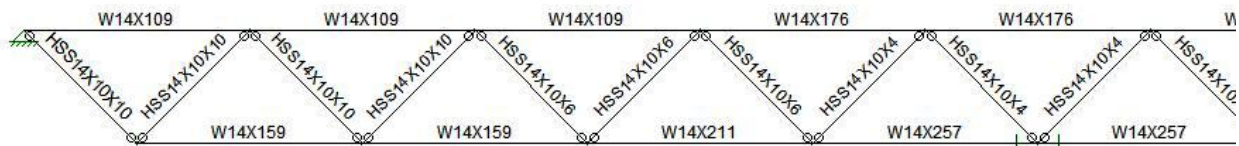
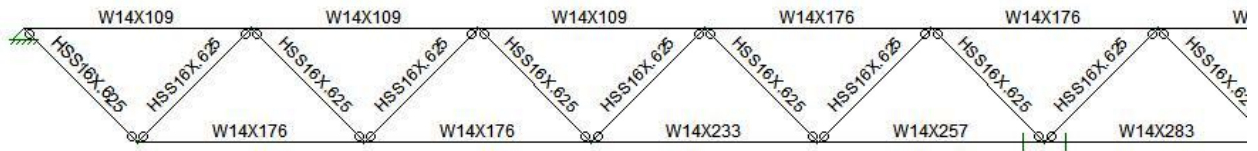
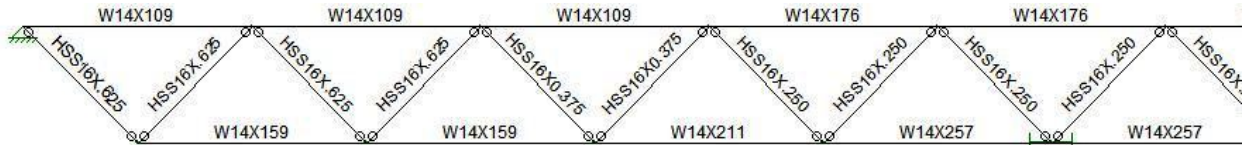


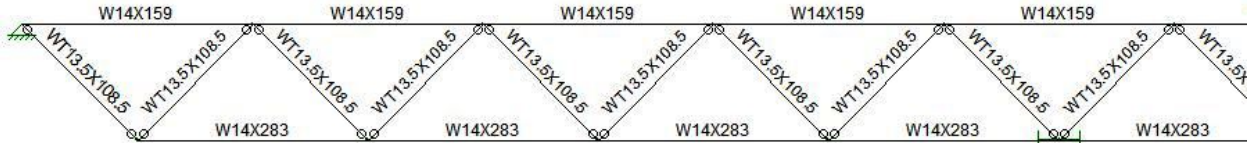
Figure B-4: Truss Model #4 Member Layout



**Figure B-5: Truss Model #5 Member Layout**

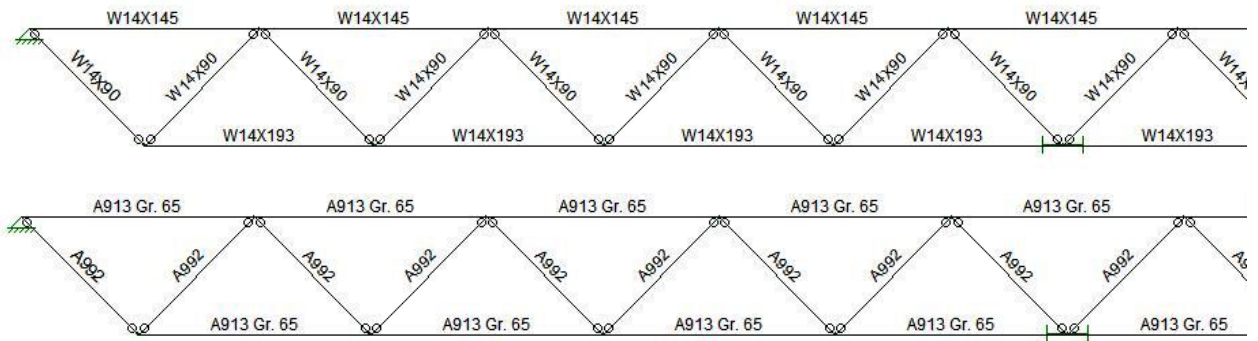


**Figure B-6: Truss Model #6 Member Layout**



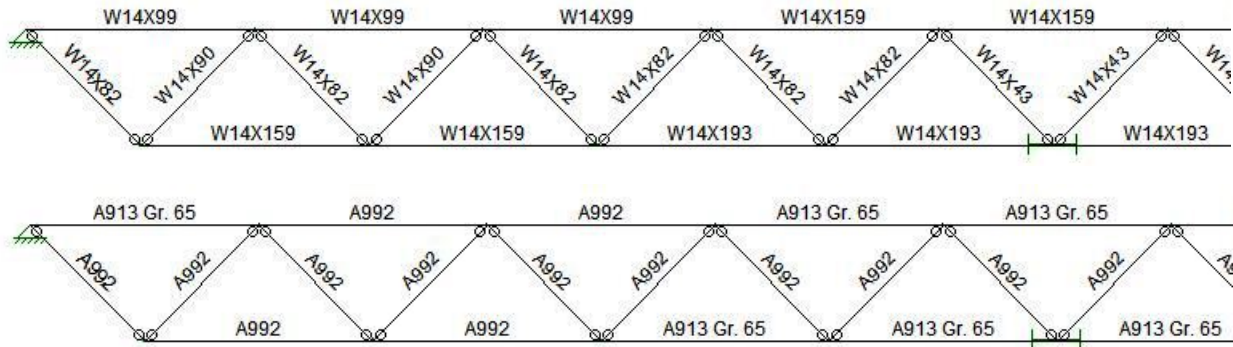
**Figure B-7: Truss Model #7 Member Layout**

*Steel Grade*

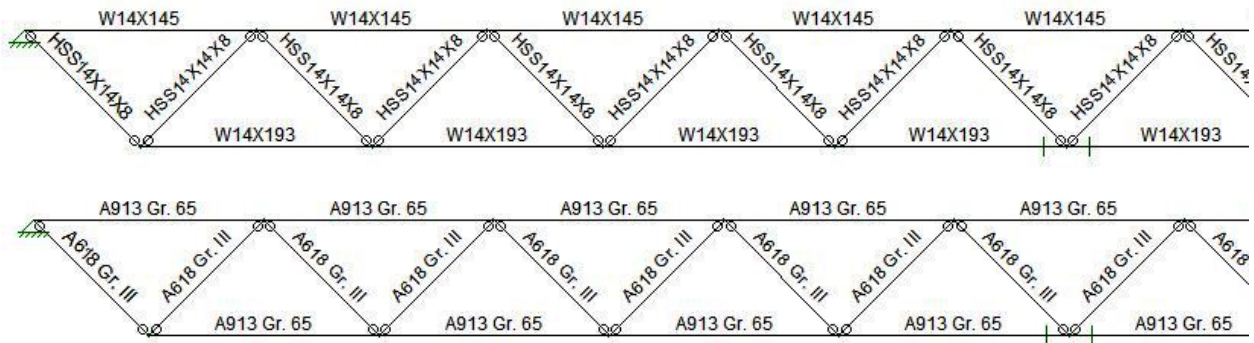


**Figure B-8: Truss Model #1 Member and Steel Grade Layout**

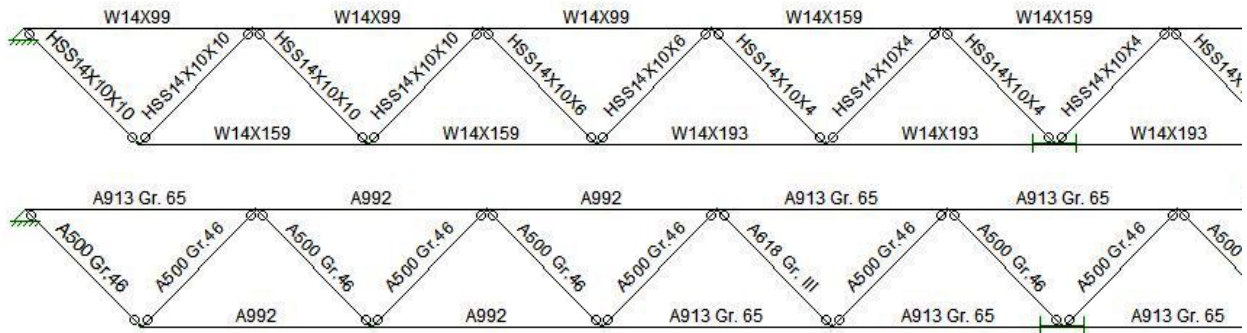




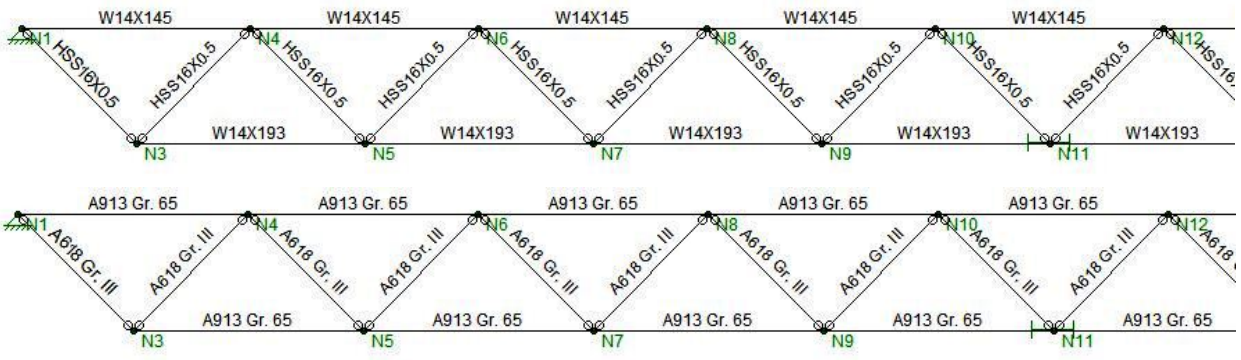
**Figure B-9: Truss Model #2 Member and Steel Grade Layout**



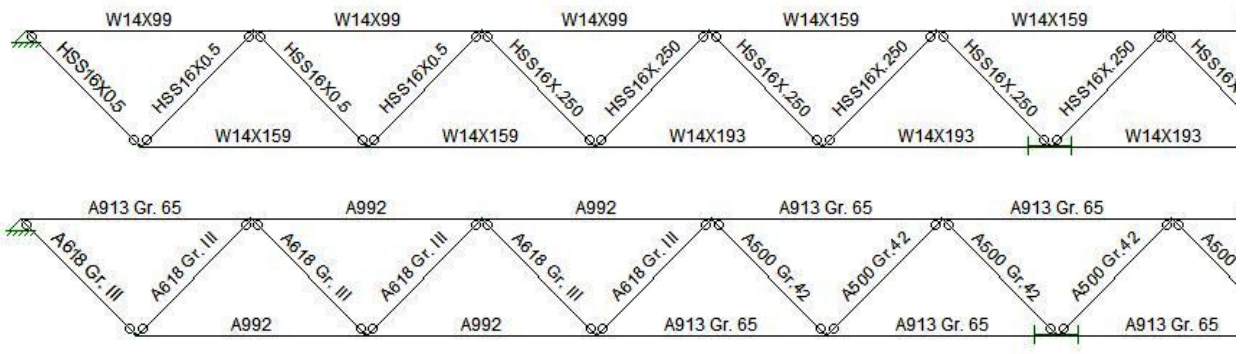
**Figure B-10: Truss Model #3 Member and Steel Grade Layout**



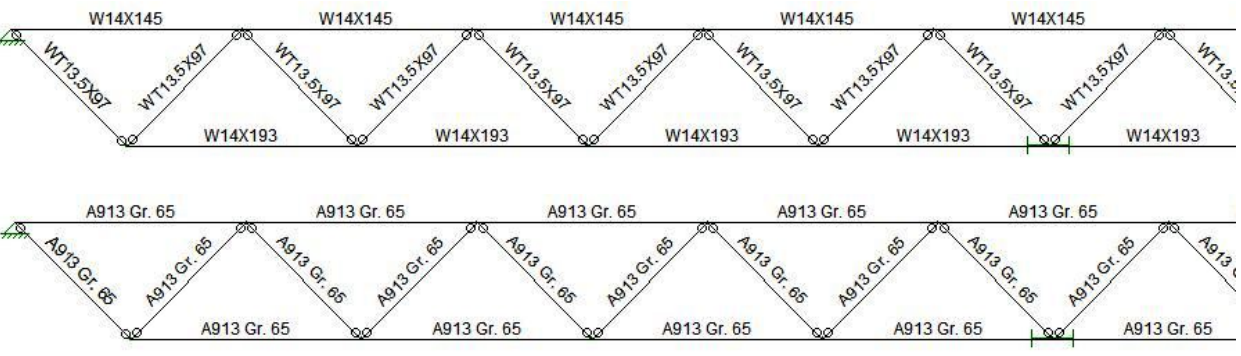
**Figure B-11: Truss Model #4 Member and Steel Grade Layout**



**Figure B-12: Truss Model #5 Member and Steel Grade Layout**



**Figure B-13: Truss Model #6 Member and Steel Grade Layout**



**Figure B-14: Truss Model #7 Member and Steel Grade Layout**

## Load Combinations Used

Per Section 2.3.2 of the ASCE 7-10:

#1.  $1.4D$

#2.  $1.2D + 1.6L + 0.5(L_r \text{ or } S \text{ or } R)$

#3.  $1.2D + 1.6(L_r \text{ or } S \text{ or } R) + (L \text{ or } 0.5W)$

#4.  $1.2D + 1.0W + L + 0.5(L_r \text{ or } S \text{ or } R)$

#6.  $0.9D + 1.0W$

## Truss Loading Diagrams

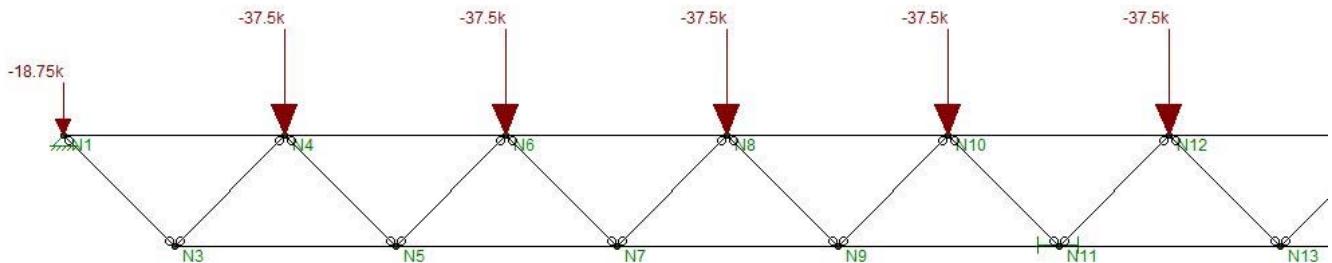


Figure B-15: Dead Load Truss Loading

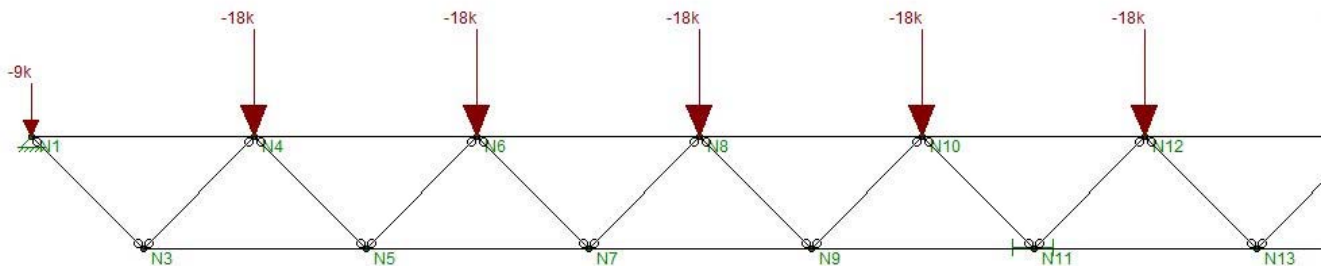
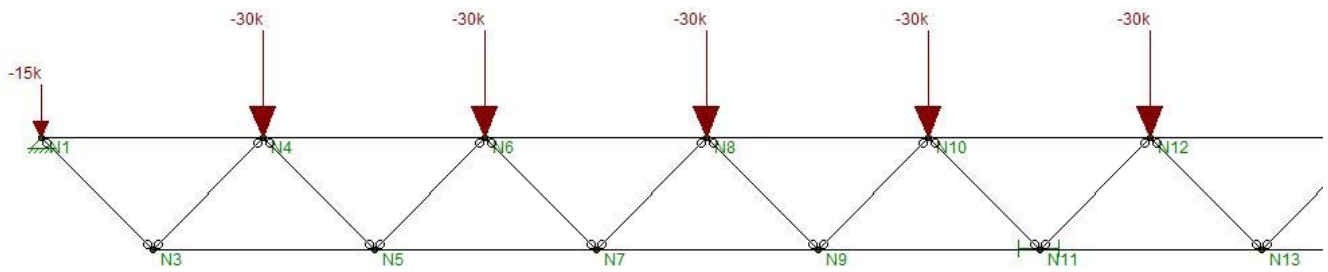
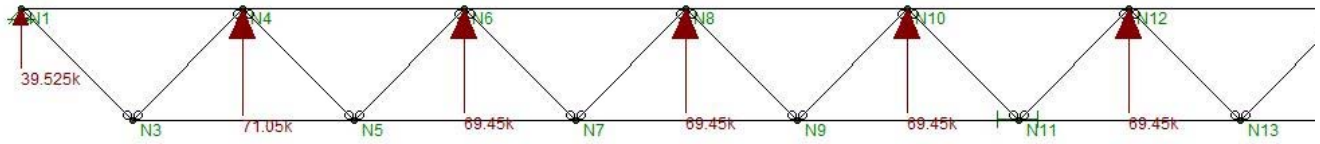


Figure B-16: Roof Live Load Truss Loading



**Figure B-17: Snow Load Truss Loading**



**Figure B-18: Wind Loading (Components and Cladding) Truss Loading**