

Beef cattle data analytics: Trends in feedlot cattle health, performance, and carcass traits, and effects of beef on dairy programs

by

Esther Dorice McCabe

B.S., Kansas State University, 2015

M.S., Kansas State University, 2018

AN ABSTRACT OF A DISSERTATION

submitted in partial fulfillment of the requirements for the degree

DOCTOR OF PHILOSOPHY

Department of Animal Sciences and Industry
College of Agriculture

KANSAS STATE UNIVERSITY

Manhattan, Kansas

2021

Abstract

Data science has emerged as an academic field and an important decision-making tool for the private sector. This is the result of advances in technology that allow the collection and management of large data sets. Data analytics allows scientists to pursue questions that cannot be addressed with controlled experiments. The objective of studies within this dissertation was to use data analytics to evaluate trends in performance, health and carcass traits from feedlot cattle, and determine the effect of Holstein and beef-dairy cross breed descriptions of cattle lots on sale price.

The first study utilized the Tri-County Steer Carcass Futurity Cooperative data collected from 2002 through 2018 to analyze trends across years for performance, health, and carcass traits for steers and heifers. Performance traits evaluated included arrival weight, average daily gain, feed to gain, days on feed, and harvest weight. The regression coefficients (slope) were significant ($P < 0.10$) for each of these traits for both steers and heifers with the exception of feed:gain ($P = 0.59$). The R^2 for these equations was small, however, indicating that year only accounted for small amount of the variation, and that there was little change in these traits for the duration of the study. Health trends included morbidity risk, number of times treated, and mortality risk. The percentage morbidity increased ($P < 0.0001$) for steers and heifers. The overall mean morbidity risk for steers was 24% and 20% for heifers. The percentage of steers and heifers receiving no treatments for morbidity decreased ($P < 0.0001$). Concurrently, the percentage of steers and heifers treated one, two, or three or more times increased ($P < 0.0001$). Mortality percentage increased for steers ($P < 0.0001$) and heifers ($P < 0.001$). The overall mean mortality risk for steers was 1.8% and 1.4% for heifers. Carcass trait trends evaluated included hot carcass weight, fat thickness, ribeye area, kidney pelvic heart fat percentage, dressing percentage, marbling score, calculated yield grade, and carcass value. The regression coefficients (slope) were significant ($P < 0.01$) for each of these

traits for both steers and heifers. With the exception of carcass value, the R^2 value for these equations was small. This indicates that year only accounted for small amount of the variation, and that there was little change in these traits over the duration of the study.

The second study utilized the Tri-County Steer Carcass Futurity Cooperative data to evaluate the effect of sire breed on performance, health, and carcass traits for steers and heifers. Sire breeds included in these analyses were Angus, Charolais, Hereford, Red Angus, and Simmental. Sire breed affected arrival weight, average daily gain, harvest weight, days on feed, feed to gain, feed cost, feed consumed, hot carcass weight, dressing percentage, fat thickness, ribeye area, calculated yield grade, and overall carcass value. Odds ratios were calculated for morbidity and mortality events. The sire breed of an animal was associated ($P < 0.0001$) with the likelihood of a morbidity event. Sire breed was not associated ($P = 0.67$) with mortality.

The third study utilized Superior Livestock Auction data to determine 1) the relative value of Holstein feeder steer lots compared to the steer lots of other breed descriptions, and 2) value of beef-dairy crosses compared to other breed combinations on the sale price of lots of calves. Holstein feeder steer lots sold for the lowest ($P < 0.05$) sale price compared with all other breed descriptions. To determine potential change in relative value of Holstein feeder steers from 2010 to 2018, data were analyzed in three-year increments. In all three-year increments, Holstein feeder lots sold for the lowest ($P < 0.05$) sale price compared to the other breed descriptions of beef steer lots. There was a greater relative price discount in each year increment, likely indicating lessening interest in the feedlot sector to feed Holstein steers to harvest. As the value of the Holstein steer has decreased in the beef industry, some dairy producers are breeding lower performing dairy cows to beef semen, producing a beef-dairy cross animal. The second objective was to evaluate the value of beef-dairy cross lots compared with other breed descriptions of lots selling through summer

2020 video auctions. Beef-dairy cross calf lots sold for a greater ($P < 0.05$) sale price than Holstein lots. Beef-dairy cross lots sold for a lower ($P < 0.05$) sale price than Brahman influenced calf lots, English-Continental cross calf lots, and English, English cross calf lots. These results indicate the beef-dairy cross had greater value than the traditional Holstein calf entering the beef supply chain.

Beef cattle data analytics: Trends in feedlot cattle health, performance, and carcass traits, and effects of beef on dairy programs

by

Esther Dorice McCabe

B.S., Kansas State University, 2015

M.S., Kansas State University, 2018

A DISSERTATION

submitted in partial fulfillment of the requirements for the degree

DOCTOR OF PHILOSOPHY

Department of Animal Sciences and Industry
College of Agriculture

KANSAS STATE UNIVERSITY
Manhattan, Kansas

2021

Approved by:

Co-Major Professor
Karol Fike

Approved by:

Co-Major Professor
Kenneth Odde

Copyright

© Esther McCabe 2021.

Abstract

Data science has emerged as an academic field and an important decision-making tool for the private sector. This is the result of advances in technology that allow the collection and management of large data sets. Data analytics allows scientists to pursue questions that cannot be addressed with controlled experiments. The objective of studies within this dissertation was to use data analytics to evaluate trends in performance, health and carcass traits from feedlot cattle, and determine the effect of Holstein and beef-dairy cross breed descriptions of cattle lots on sale price.

The first study utilized the Tri-County Steer Carcass Futurity Cooperative data collected from 2002 through 2018 to analyze trends across years for performance, health, and carcass traits for steers and heifers. Performance traits evaluated included arrival weight, average daily gain, feed to gain, days on feed, and harvest weight. The regression coefficients (slope) were significant ($P < 0.10$) for each of these traits for both steers and heifers with the exception of feed:gain ($P = 0.59$). The R^2 for these equations was small, however, indicating that year only accounted for small amount of the variation, and that there was little change in these traits for the duration of the study. Health trends included morbidity risk, number of times treated, and mortality risk. The percentage morbidity increased ($P < 0.0001$) for steers and heifers. The overall mean morbidity risk for steers was 24% and 20% for heifers. The percentage of steers and heifers receiving no treatments for morbidity decreased ($P < 0.0001$). Concurrently, the percentage of steers and heifers treated one, two, or three or more times increased ($P < 0.0001$). Mortality percentage increased for steers ($P < 0.0001$) and heifers ($P < 0.001$). The overall mean mortality risk for steers was 1.8% and 1.4% for heifers. Carcass trait trends evaluated included hot carcass weight, fat thickness, ribeye area, kidney pelvic heart fat percentage, dressing percentage, marbling score, calculated yield grade, and carcass value. The regression coefficients (slope) were significant ($P < 0.01$) for each of these

traits for both steers and heifers. With the exception of carcass value, the R^2 value for these equations was small. This indicates that year only accounted for small amount of the variation, and that there was little change in these traits over the duration of the study.

The second study utilized the Tri-County Steer Carcass Futurity Cooperative data to evaluate the effect of sire breed on performance, health, and carcass traits for steers and heifers. Sire breeds included in these analyses were Angus, Charolais, Hereford, Red Angus, and Simmental. Sire breed affected arrival weight, average daily gain, harvest weight, days on feed, feed to gain, feed cost, feed consumed, hot carcass weight, dressing percentage, fat thickness, ribeye area, calculated yield grade, and overall carcass value. Odds ratios were calculated for morbidity and mortality events. The sire breed of an animal was associated ($P < 0.0001$) with the likelihood of a morbidity event. Sire breed was not associated ($P = 0.67$) with mortality.

The third study utilized Superior Livestock Auction data to determine 1) the relative value of Holstein feeder steer lots compared to the steer lots of other breed descriptions, and 2) value of beef-dairy crosses compared to other breed combinations on the sale price of lots of calves. Holstein feeder steer lots sold for the lowest ($P < 0.05$) sale price compared with all other breed descriptions. To determine potential change in relative value of Holstein feeder steers from 2010 to 2018, data were analyzed in three-year increments. In all three-year increments, Holstein feeder lots sold for the lowest ($P < 0.05$) sale price compared to the other breed descriptions of beef steer lots. There was a greater relative price discount in each year increment, likely indicating lessening interest in the feedlot sector to feed Holstein steers to harvest. As the value of the Holstein steer has decreased in the beef industry, some dairy producers are breeding lower performing dairy cows to beef semen, producing a beef-dairy cross animal. The second objective was to evaluate the value of beef-dairy cross lots compared with other breed descriptions of lots selling through summer

2020 video auctions. Beef-dairy cross calf lots sold for a greater ($P < 0.05$) sale price than Holstein lots. Beef-dairy cross lots sold for a lower ($P < 0.05$) sale price than Brahman influenced calf lots, English-Continental cross calf lots, and English, English cross calf lots. These results indicate the beef-dairy cross had greater value than the traditional Holstein calf entering the beef supply chain.

Table of Contents

List of Figures	xvi
List of Tables	xviii
Acknowledgements	xx
Dedication	xxii
Chapter 1 - Literature Review.....	1
Data Analytics.....	1
Applications in Animal Agriculture	4
Databases	7
Tri-Country Steer Carcass Futurity Cooperative	7
Superior Livestock Auction	12
Summary.....	20
Literature Cited.....	23
Chapter 2 - Performance, health, and carcass trends for steers and heifers finished through Tri-County Steer Carcass Futurity Cooperative from 2002 through 2018	28
Abstract.....	29
Introduction.....	29
Materials and Methods.....	31
Data Collection	31
Statistical Analyses	34
Results and Discussion	34
Performance Trends	35
Health Trends.....	35

Morbidity	35
Number of Times Treated.....	36
Mortality	36
Carcass Trends	37
Applications	39
Acknowledgements.....	40
Literature Cited.....	41
Figures and Tables	46
Chapter 3 - Effect of sire breed on performance, health, and carcass traits for steers and heifers finished through Tri-County Steer Carcass Futurity Cooperative from 2002 through 2018.	65
Abstract.....	66
Introduction.....	66
Materials and Methods.....	67
Data Collection	67
Statistical Analysis.....	71
Results and Discussion	71
Performance Traits.....	71
Arrival Weight	71
Average Daily Gain	72
Harvest Weight	72
Feed Variables	74
Days on Feed.....	74
Feed to Gain.....	74

Feed Cost	75
Feed Consumed.....	75
Health Traits.....	76
Morbidity	76
Mortality	76
Carcass Traits	78
Hot Carcass Weight	78
Dressing Percentage.....	78
Fat Thickness	79
Ribeye Area	79
Calculated Yield Grade.....	80
Marbling Score.....	80
Carcass Value.....	81
Applications	84
Acknowledgements.....	85
Literature Cited	86
Tables.....	91
Chapter 4 - Effect of Holstein and beef-dairy cross breed description on the sale price of lots of steers sold through Superior Livestock Auction video sales	102
Abstract.....	103
Introduction.....	103
Materials and Methods.....	105
Data Collection	105

Feeder Steer Lots	105
Steer Calf Lots	106
Statistical Analyses	107
Results and Discussion	109
Feeder Steer Lots	109
Steer Calf Lots	112
Applications	114
Literature Cited	115
Tables	119
Appendix A - Tri-County Steer Carcass Futurity Cooperative – Rules and regulations, and health requirements	124
Tri-County Steer Carcass Futurity Cooperative Rules and Regulations	124
Health Protocol for Tri-County Steer Carcass Futurity Cooperative.	126
Appendix B - Tri-County Steer Carcass Futurity Cooperative Database	128
Description of the Iowa State University Tri-County Steer Carcass Futurity Data 2002 through 2019	128
Source of data	128
Total number of records	128
Live and carcass data 2002 through 2019.....	128
Additional variables and costs 2002 through 2019.....	139
Appendix C - Superior Livestock Auction - History of the project 1995 through 2020	142
History of the Superior Livestock Auction project 1995 through 2020	142
Brief description of each year of the study	146

1995.....	146
1996.....	146
1997.....	146
1998.....	146
1999.....	146
2000.....	147
2001.....	147
2002.....	147
2003.....	147
2004.....	147
2005.....	148
2006.....	148
2007.....	148
2008.....	149
2009.....	149
2010.....	149
2011.....	150
2012.....	150
2013.....	150
2014.....	151
2015.....	151
2016.....	151
2017.....	152

2018.....	152
2019.....	152
2020.....	152
1995 to 2020 Superior Master Database.....	153
Appendix D - Superior Livestock Auction – History and description of variables in database 1995 through 2020.....	154
History of the variables available for the Superior Livestock Auction data 1995 through 2020	154
Description of the Superior Livestock Auction master database 1995 through 2018	156
Source of data	156
Description of the 2020 Superior Livestock Auction database	168
Source of data	168
Appendix E - Imitating the dynamic bovine cervix with 3D printing technology to teach artificial insemination in cattle.....	176

List of Figures

Figure 1.1 - Lot examples from a 1995 Superior Livestock Auction video sale catalog	16
Figure 1.2 - Lot examples from a 2020 Superior Livestock Auction video sale catalog	17
Figure 2.1 - Arrival weight trend for steers and heifers finished through the Tri-County Steer Carcass Futurity Cooperative from 2002 through 2018.....	48
Figure 2.2 - Average daily gain trend for steers and heifers finished through the Tri-County Steer Carcass Futurity Cooperative from 2002 through 2018.....	49
Figure 2.3 - Feed to gain trend for steers and heifers finished through the Tri-County Steer Carcass Futurity Cooperative from 2002 through 2018.....	50
Figure 2.4 - Days on feed trend for steers and heifers finished through the Tri-County Steer Carcass Futurity Cooperative from 2002 through 2018.....	51
Figure 2.5 - Harvest weight trend for steers and heifers finished through the Tri-County Steer Carcass Futurity Cooperative from 2002 through 2018.....	52
Figure 2.6 - Trend in morbidity risk for steers and heifers finished through Tri-County Steer Carcass Futurity Cooperative from 2002 through 2018.....	53
Figure 2.7 - Trend in number of times treated for steers finished through Tri-County Steer Carcass Futurity Cooperative from 2002 through 2018.....	54
Figure 2.8 - Trend in number of times treated for heifers finished through Tri-County Steer Carcass Futurity Cooperative from 2002 through 2018.....	55
Figure 2.9 - Trend in mortality risk for steers and heifers finished through Tri-County Steer Carcass Futurity Cooperative from 2002 through 2018.....	56
Figure 2.10 - Hot carcass weight trend for steers and heifers finished through the Tri-County Steer Carcass Futurity Cooperative from 2002 through 2018.....	57

Figure 2.11 - Fat thickness trend for steers and heifers finished through the Tri-County Steer Carcass Futurity Cooperative from 2002 through 2018.....	58
Figure 2.12 - Ribeye area trend for steers and heifers finished through the Tri-County Steer Carcass Futurity Cooperative from 2002 through 2018.....	59
Figure 2.13 - Kidney, pelvic, heart fat percentage trend for steers and heifers finished through the Tri-County Steer Carcass Futurity Cooperative from 2002 through 2018	60
Figure 2.14 - Dressing percentage trend for steers and heifers finished through the Tri-County Steer Carcass Futurity Cooperative from 2002 through 2018	61
Figure 2.15 - Marbling score ¹ trend for steers and heifers finished through the Tri-County Steer Carcass Futurity Cooperative from 2002 through 2018.....	62
Figure 2.16 - Calculated yield grade trend for steers and heifers finished through the Tri-County Steer Carcass Futurity Cooperative from 2002 through 2018	63
Figure 2.17 - Carcass value trend for steers and heifers finished through the Tri-County Steer Carcass Futurity Cooperative from 2002 through 2018.....	64
Figure E.1 - Flashforge Creator Pro Dual Extrusion Printer printing a 3D cervix using NinjaFlex filament	177
Figure E.2 - Prototypes of 3D printed cervix, half angle and section views, from Kansas State University Industrial Engineering.....	177
Figure E.3 - Various types of 3D printed cervices representing both cow and heifer cervices..	177
Figure E.4 - The 3D printed cervix assembled in the pelvic box from the top view	177
Figure E.5 - The 3D printed cervix assembled in the pelvic box from the rear view.....	177

List of Tables

Table 2.1 - Non-adjusted means, medians, and ranges for continuous variables describing 70,196 steers and 30,965 heifers finished through the Tri-County Steer Carcass Futurity Cooperative from 2002 through 2018	46
Table 2.2 - Regression coefficients, P values, and R ² values for effect of year on outcomes of interest for steers and heifers finished through the Tri-County Steer Carcass Futurity Cooperative from 2002 through 2018.....	47
Table 3.1 - Unadjusted mean, SD, median, and range values for continuous variables for steers ¹ finished through Tri-County Steer Carcass Futurity Cooperative, Lewis, IA from 2002 through 2018	91
Table 3.2 - Unadjusted mean, SD, median, and range values for continuous variables for heifers ¹ finished through Tri-County Steer Carcass Futurity Cooperative, Lewis, IA from 2002 through 2018	92
Table 3.3 - Effect of sire breed, sex, and year-group for arrival weight, average daily gain, and harvest weight in feedlot cattle finished through Tri-County Steer Carcass Futurity Cooperative, Lewis, IA from 2002 through 2018.....	93
Table 3.4 - Effect of sire breed, sex, and year-group for days on feed, feed to gain, feed cost, and feed consumed in feedlot cattle finished through Tri-County Steer Carcass Futurity Cooperative, Lewis, IA from 2002 through 2018.....	95
Table 3.5 - The effect of sire breed, sex, and year-group on the morbidity risk of feedlot cattle finished through Tri-County Steer Carcass Futurity Cooperative, Lewis, IA from 2002 through 2018	97

Table 3.6 - The effect of sire breed, sex, and year-group on the mortality risk of feedlot cattle finished through Tri-County Steer Carcass Futurity Cooperative, Lewis, IA from 2002 through 2018	98
Table 3.7 - Effect of sire breed, sex, and year-group for carcass traits in feedlot cattle finished through Tri-County Steer Carcass Futurity Cooperative, Lewis, IA from 2002 through 2018	99
Table 4.1 - Non-adjusted means, medians, and ranges for factors describing single-gender lots of feeder steers sold through 211 Superior Livestock Auction video sales from 2010 through 2018.....	119
Table 4.2 - Non-adjusted means, medians, and ranges for factors describing weaned steer calf lots originating in either the Rocky Mountain/North Central or the South Central region that sold through six Superior Livestock Auction video sales in the summer of 2020	120
Table 4.3 - Sale price of Holstein feeder steer lots relative to other breed descriptions sold through 211 Superior Livestock Auction video sales from 2010 through 2018	121
Table 4.4 - Non-adjusted mean sale price of Holstein feeder steer lots and the percentage discount as compared with English-English cross, English-Continental cross, and Brahman influenced steer lots for each three-year increment	122
Table 4.5 - Effect of breed description on the sale price of weaned steer calf lots originating in either the Rocky Mountain/North Central or the South Central region that sold through six Superior Livestock Auction video sales in the summer of 2020	123

Acknowledgements

First, to my major professors, Dr. Ken Odde and Dr. Karol Fike, there truly are not words to express how grateful I am for the last five years of mentorship. Dr. Odde, thank you for your guidance, endless mentorship, and insight for new questions to ask. Dr. Fike, my thankfulness for your patience, insight, and ability to teach the importance of “story telling” cannot be overstated. You both have had incredible influence over the last five years, so thank you. To my committee members, Dr. David Grieger and Dr. Bob Larson, thank you for your guidance and insight throughout the program. Dr. Grieger, thank you for sharing your passion for teaching, allowing me to participate in your research, and teaching me the fun of bluegill and fly fishing. Dr. Larson, thank you for serving on my committee and your assistance throughout these projects. Dr. Susan Moore, thank you for your time and input serving as the outside chairperson.

Mr. Mike King, without your willingness to provide insight, guidance, and endless patience, none of the projects I have had to opportunity to be a part of would be possible. Your knowledge of databases and data analytics are second to none and I am very fortunate to have learned from one of the best.

Tri-County Steer Carcass Futurity Cooperative, Matt Groves, thank you for providing the data for part of this dissertation. Your patience and willingness to work with our group is greatly appreciated. These projects would not have been possible without your cooperation.

The American Angus Association, Angus Foundation, American Angus Auxiliary, National Junior Angus Association, and Kansas Junior Angus Association, thank you for the support as a junior member. The financial support through undergraduate and graduate school was extraordinary and has had a significant impact. The development opportunities the Angus

Association provides to junior members are unparalleled. Thank you for the investment in the junior members.

The faculty, staff, and students in the Animal Sciences and Industry Department at Kansas State University are second to none. Thank you for providing a challenging and fun learning environment. The graduate students I had the pleasure to work with, thank you for your perspectives, willingness to help with projects, and a few being more like family than friends. Ashley Hartman, thank you for teaching me lab skills through your projects and letting me be a small part of your research trials. You are the best graduate school fishing buddy and guide.

Finally, thank you to my family who has supported and encouraged the entire journey. To my mom and dad, thank you for all the opportunities you provided us kids. Those opportunities took sacrifice but without it, we would not be where we are today. You both invested countless hours, dollars, and miles to teach us the value of hard work and integrity. To my siblings, their families, and AJ, thank you for helping along the way, keeping me humble and a smile on my face, and mostly for being a great support system. I love you all.

Dedication

This dissertation is dedicated to my parents, Randy and Varee.

“The rules have changed!”

Chapter 1 - Literature Review

Data Analytics

Data science has emerged as an academic field and an important decision-making tool for the private sector. This is the result of advances in technology that allow the collection and management of large data sets. Data analytics allow scientists to pursue questions that cannot be addressed with controlled experiments.

As this field continues to rapidly evolve, new terminology continues to grow. Differentiating between data science, data analytics, and big data is important for understanding the purpose of each area. While these phrases are related, and assist in data-driven decision making, the phrases are not interchangeable. Data science is a multidisciplinary field, focused on discovering insight to a broad topic (Liberty, 2019). Data science is used to find the right question to answer and the potential ways to answer the question (Liberty, 2019). Data analytics is performing statistical analysis on existing datasets in order to answer a specific question (Liberty, 2019). Data analytics is a field focused on answering specific questions and using the results to make improvements (Liberty, 2019). Big data refers to not only the size of a data set, to truly be big data, but the results from analyses generated are used to make better decisions (SAS, 2020). Big data is often described using the three V's: 1) volume, 2) velocity, and 3) variety (Agrawal et al., 2011; SAS, 2020). There are two additional V's also used to describe big data, variability and veracity (SAS, 2020). In order for data to be "big data", it must meet the requirements of the three V's. Volume refers to the magnitude or size of a dataset (Agrawal et al., 2011; Jain, 2016; SAS, 2020). Velocity refers to the speed at which data are created and can be analyzed (Agrawal et al., 2011; Jain, 2016; SAS 2020). Variety of data refers to the type of data, which can be structured, semi-structured, or unstructured data (Agrawal et al., 2011; Jain, 2016; SAS 2020). Variability is

the unpredictable changes in the data from data flow to the information provided in a dataset; the information may not always be consistent over time (Jain, 2016; SAS, 2020). Veracity describes the quality of the data, meaning the data need to be managed to create valuable insight (SAS, 2020). Data science, data analytics, and big data are all growing areas of interests for all fields, from business to health care to agriculture. The opportunities in these areas are unprecedented, which also creates new challenges.

Businesses have used data analytics since the 19th century (Foote, 2018). Early documentation of data analytics included time management exercises initiated by Frederick Winslow Taylor as well as the efficiency of assembly lines by Henry Ford (Foote, 2018). While data analytics is not a new phenomenon, the practical use of data analytics evolved with the use of computer systems. For example, prior to computers, the completion of the 1880 United States Census took seven years (Marr 2015; Foote, 2018). With the invention of a tabulating machine by Herman Hollerith, the 1890 census only took 18 months to complete by using punch cards to read the data (Foote, 2018). “In the late 1960s, data analytics began receiving more attention as computers became decision-making support systems” (Foote, 2018). Today, data analytics is used across a variety of disciplines from business to human medicine to agronomy to animal agriculture.

Data analytics is the process of collecting raw data, transforming the data into an analyzable format, and making conclusions from the data. Maintaining a data source, often in the form of a database, is a tedious process. Data are constantly created, data are in a variety of formats and there are underlying complexities to create, maintain, and analyze a valuable dataset (Agrawal et al., 2015; Gandomi and Haider, 2015). Incoming data can be in a variety of formats, from structured to unstructured data, containing quantitative and qualitative information. Structured data includes information such as dates, phone numbers, names, and inventory, typically stored in a length-

delineated format (Taylor, 2018). Unstructured data includes files such as audio, video, image, reports, and text files (Taylor, 2018). Structured data is easier to analyze than unstructured data, but unstructured data can provide businesses with valuable information (Taylor, 2018). New tools are being developed to help analyze unstructured data with more efficiency. Within these data types, there can be both qualitative and quantitative data. Qualitative data is descriptive, such as a breed description, feed information, or product names. Qualitative data often requires coding of the data into categorical data in order to use in data analytics. Quantitative data is numerical, such as age, weight, or a volume. All these types of data provide useful information to help drive decision making and provide insight for a question. Maintaining a dynamic database can provide up-to-date information, but it is a complex process. The validity of the data not only depends on the data collected, but also how the data is managed. Data preparation, including collecting, cleaning, organizing, and coding data, accounts for approximately 80% of the time spent with data (Press, 2016). This means, only approximately 20% of the time is spent analyzing the data.

There are four types of data analytics, each providing different insight. The types of data analytics include descriptive, diagnostic, predictive, and prescriptive (Bekker, 2019; Michigan State University, 2019). Descriptive analytics provide information about what happened in the past (Bekker, 2019; Michigan State University, 2019). Descriptive analytics do not provide insight about why an event happened but includes analytics methods such as reports and summary statistics (Bekker, 2019; Michigan State University, 2019). Diagnostic analytics provides information about why an event happened (Bekker, 2019; Michigan State University, 2019). Diagnostic analytics includes techniques such as principle component analysis and regression analysis (Michigan State University, 2019). Predictive analytics provides insight for what might happen based on parameters provided (Bekker, 2019; Michigan State University, 2019). Predictive

analytics uses information from descriptive and diagnostic analyses to predict future trends and outcomes (Bekker, 2019; Michigan State University, 2019). Predictive analytics are commonly used in forecasting and is analyzed through methods such as predictive modeling and machine learning algorithms (Bekker, 2019; Michigan State University, 2019). Prescriptive analytics provides insight of what actions to take to reach a desired outcome (Bekker, 2019; Michigan State University, 2019). Prescriptive analytics uses techniques such as simulation analysis and artificial intelligence (Bekker, 2019; Michigan State University, 2019).

Applications in Animal Agriculture

Animal agriculture industries develop and adapt new technologies at different rates. All animal agriculture industries have collected data for decades to sustainably produce protein for a growing population (Koltés et al., 2019). While data have been collected, they are frequently under-utilized and segmented within a sector of production. While most producers have a system to manage on-farm data, the data is often not fully utilized (Piñeiro et al., 2016). When data are analyzed within their segment of production, the results are still informative. When the data are integrated together in a whole system approach, the insight gleaned is more useful.

For more than 40 years, the dairy industry has used data analytics to increase milk production (Koltés et al., 2019). The beef, dairy, poultry, and swine industries have used data analytics to improve production and efficiency (Hill, 2016). As data storage and computing technology has advanced, the amount of data collected from commercial systems as well as experimental studies has also increased (White et al., 2018). This allows for more in depth analysis of large datasets. Descriptive analytics and diagnostic analytics are commonly used to evaluate the data collected. Descriptive analytics are used to describe and summarize historical data. Descriptive analytics often include information such as mean, standard deviation, median, range,

and general trends of the data. Examples include summarizing information about weight of cattle, milk production, and number of piglets per litter. Diagnostic analytics are used to determine why an event happened. Diagnostic analytics, for example, can be used to determine what factors are influencing milk production for dairy cows or factors affecting the sale price of calves. As technology continues to develop and more operations use the technologies to the fullest capabilities, predictive analytics and prescriptive analytics will become more common in animal agriculture.

Animal agriculture industries currently using more automated systems for production, such as dairy, swine, and poultry, have an advantage in data collection and utilization compared with less automated animal agriculture industries such as beef and sheep. The dairy industry has incorporated technological advancements in everyday production. Some of these technologies include wearable sensors and robotic milking systems (Cabrera et al., 2020). Dairy operations also routinely collect feeding, reproduction, and behavior data (Cabrera et al., 2020). These technologies produce a vast amount of on-farm data but integrating all the data produced into a whole system decision-making process has been challenging (Cabrera et al., 2020).

The use of data analytics is currently limited in the beef industry. The current infrastructure of the beef industry limits the flow of data. An animal destined for the feedlot may change owners several times prior to harvest. The diverse nature of beef production and lack of vertical integration creates challenges for data transfer. While there are within-operation data analytics that occur, whether at the cow-calf, backgrounder, or feedlot, there is not much transfer of the information between segments of production.

Beef and dairy producers have access to a variety of selection tools, partially as a result of data analytics. Expected progeny differences (EPDs), primarily used by the seedstock operations,

use data analytics to estimate an animal's genetic value (Greiner, 2009). These EPDs allow for improved selection and accuracy for identifying superior parent animals (Greiner, 2009). Each breed association has EPDs for animals in their registry. Using EPDs in selection decisions can improve selected traits such as milk production, marbling, growth, and birth weight.

Precision agriculture technology is more commonly used in the agronomic sector of agriculture than in animal agriculture. Crop farmers have adopted new technologies to increase crop yields while lowering inputs. Through a variety of advancements, many crop producers are using or looking to use variable-rate applications (fertilizers, herbicides, etc.) to specifically meet the needs of each area of a field (USDA, NIFA, n.d.b). The animal agriculture industries have started to incorporate more precision agriculture in production to help manage and monitor animals (USDA, NIFA, n.d.a). One example of incorporating precision agriculture in animal production is through wearable sensors (Koltes et al., 2019). These sensors detect movement such as walking, lying, standing, mounting, and rumination (Abell, 2017; Koltes et al., 2019). The sensors can also measure temperature or heart rate (USDA, NIFA, n.d.b). The detected movements can be used to predict estrus, disease, or feeding behavior (Abell, 2017; Koltes et al., 2019). The information derived from these sensors can be used to “improve animal efficiency, health, and welfare” (Koltes et al., 2019). Precision agriculture, whether for crop production or animal production, not only requires data collection, but data analysis as well in order to use the information to make improvements (USDA, NIFA, n.d.b).

As technology continues to progress, the use of data analytics will as well. As more data are created, the concern of data ownership continues to grow. Incorporating and analyzing data from a whole systems approach will provide more insight for animal agriculture industries.

Databases

Creating databases that are functional and analyzable is a part of the data analytics process. A database has a structured set of data that is accessible in a variety of ways, meaning the data can be evaluated in multiple formats. Depending on the database, the kind of information will change, but the information in the database is related to the purpose of the database. For example, a database on a cattle operation may contain information for each animal such as an identification number, dam, sire, sex, birthdate, weaning date, birth weight, weaning weight, breeding information, pregnancy data, etc. This information in a database is relevant to the needs of the database. The studies within this dissertation are a result of years of data collection and management. The specific details and development of the databases for research in this dissertation are described below.

Tri-Country Steer Carcass Futurity Cooperative

The first two studies are derived from data collected by the Tri-County Steer Carcass Futurity Cooperative based in Lewis, Iowa. “The principle objective of the Tri-County Steer Carcass Futurity Cooperative program is to provide information to beef producers they can use in managing and marketing their product. The program will provide cow-calf producers information on feedlot performance, average daily gain, and carcass data on one or more steers/heifers entered” (Tri-County Steer Carcass Futurity Cooperative, 2020). The purpose of this program is for producers to use the information to make breeding and management decisions based on the performance data of cattle finished through the program.

Tri-County Steer Carcass Futurity Cooperative began in 1982 (Busby, 2015). The board of the Cooperative wanted to answer, “What is the most profitable steer to feed?” (Busby, 2015). To answer this question, the board “recruited 35 southwest Iowa cow-calf producers to consign 106

steers” (Busby, 2015). In 2002, a service cooperative was formed by the cow-calf producers participating in the program (Busby, 2015). Since that time, the cooperative has worked for the cow-calf producers consigning cattle to identify potential areas of improvement in breeding, management programs, and marketing programs to become better, more profitable producers. Currently, there are six feedlots in southwest Iowa feeding cattle in this program (Tri-County Steer Carcass Futurity Cooperative, 2020). The program has significantly grown since it began with 106 steers (Busby, 2015). There were 4,115 head of steers and heifers enrolled in the program in the 2019-2020 Tri-County Steer Carcass Futurity Cooperative cattle on feed report (Tri-County Steer Carcass Futurity Cooperative, 2020).

For entry into the program, cow-calf producers must meet the rules and regulations as outlined by Tri-County Steer Carcass Futurity Cooperative. The list of rules and regulations can be found at http://www.tscsf.com/TCSCF_Rules_Regulations.pdf. The current list of rules and regulations as of October 1, 2020 are also listed in Appendix A. The current health requirements for the program can be found at http://www.tscsf.com/Health_Protocol.pdf. The current health requirements as of October 1, 2020 are also listed in the Appendix A. Cow-calf producers consigning cattle provide records from the cow-calf level such as the sire, dam, birth date, etc. of the animals. The more information consigners provide about the cattle, the more detailed the analysis from the cooperative can be (Busby, 2015).

Other information collected prior to starting on test includes frame and muscling scores based on the USDA feeder grades. These scores are assigned to calves upon arrival by a USDA market reporter (Tri-County Steer Carcass Futurity Cooperative, 2020a). Long-haul calves are rested no more than four days and recover their shrink prior to arrival processing (Busby, 2015). Cattle are weighed, body condition scored, vaccinated, and implanted within four days of arrival

to the feedlot (Busby, 2015). A modest implant program is used for cattle finished through Tri-County Steer Carcass Futurity (Groves, 2020). All feedlots participating in the program feed a common dietary energy level (Groves, 2020). A warm-up ration is fed for 28 days prior to starting test (Tri-County Steer Carcass Futurity Cooperative, 2020a). Individual feed intake within a pen is determined using the Cornell Net Carbohydrate and Protein Model (Busby, 2015; Groves, 2020). The Cornell Net Carbohydrate and Protein Model is well described in literature and periodically updated to improve accuracy (Cornell University, 2020). “The Cornell Net Carbohydrate and Protein System was developed to predict requirements, feed utilization, animal performance and nutrient excretion for dairy and beef cattle using accumulated knowledge about feed composition, digestion, and metabolism in supplying nutrients to meet requirements” (Cornell University, 2020).

Health information on cattle finished through the Tri-County Steer Carcass Futurity Cooperative is recorded by feedlot personnel. Cattle are observed daily for morbidity and mortality by feedlot employees or a feedlot veterinarian. Employees that evaluate health are trained by Iowa State University veterinarians (Reinhardt et al., 2009). The health information reported varies between each feedlot, meaning some feedlots report rectal temperatures, morbidity diagnosis, cause of mortality, or products used for treatment. The health information collected consistently between feedlots includes number of times treated, treatment cost, if a morbidity event occurred, and if a mortality event occurred.

Steers and heifers are weighed at least four times: 1) arrival, 2) start of test, 3) re-implant, and 4) harvest (Tri-County Steer Carcass Futurity Cooperative, 2020a). Steers and heifers are determined to be ready for harvest based on visual appraisal of backfat thickness. The target for many years was 0.4 inches of backfat but was increased to an individual target of 0.5 inches of

backfat (Groves, 2020). Each pen of cattle has at least two harvest dates, minimum five weeks apart (Tri-County Steer Carcass Futurity Cooperative, 2020a). Carcass data is collected at time of harvest (Groves, 2020). Cattle were harvested in Denison, IA from 2002 through 2014 and in Dakota City, NE from 2015 through 2018. Carcass data began to be collected using instrument grading in 2015.

There have been numerous studies from the Tri-County Steer Carcass Futurity program data. Some of these studies include:

- Busby, W., D. Loy, and D. Maxwell. 2004. Effect of Synovex Choice implant on performance and carcass traits of steer calves. Iowa State University Animal Industry Report, A. S. Leaflet R1889. doi.org/10.31274/ans_air-180814-512
- Busby, W. D., D. R. Strohnehm, P. Beedle, and L. R. Corah. 2004. Effect of postweaning health on feedlot performance and quality grade. Iowa State University Animal Industry Report, A. S. Leaflet R1885. doi.org/10.31274/ans_air-180814-521
- Tait, R. G., G. H. Rouse, P. B. Wall, W. D. Busby, and D. L. Maxwell. 2004. Real-time ultrasounding and performance measures to assist in feedlot cattle sorting for marketing decisions. Iowa State University Animal Industry Report, A. S. Leaflet R1872. doi.org/10.31274/ans_air-180814-415
- Ibarburu, M. and J. D. Lawrence. 2005. Predicting animals in feedlot that produce discounted carcasses. Iowa State University Animal Industry Report, A. S. Leaflet R2001. doi.org/10.31274/ans_air-180814-1120
- Busby, D., D. Loy, and D. Maxwell. 2006. Management of Optaflexx in feedlots that sort cattle prior to market. Iowa State University Animal Industry Report, A. S. Leaflet R2074. doi.org/10.31274/ans_air-180814-516

- Busby, D. D. Strohbehn, P. Beedle, and M. King. 2006. Effect of disposition on feedlot gain and quality grade. Iowa State University Animal Industry Report, A. S. Leaflet R2070. doi.org/10.31274/ans_air-180814-518
- Schneider, M., R. G. Tait, and J. Reecy. 2007. Estimation of the effects of bovine respiratory disease treatments through the feedlot phase and the difference among sires of Angus cattle. Iowa State University Animal Industry Report, A. S. Leaflet R2195. doi.org/10.31274/ans_air-180814-444
- Busby, W. D., M. E. King, and G. D. Fike. 2008. Factors affecting lot low choice and above and lot premium choice acceptance rate of beef calves in the Tri-County Steer Carcass Futurity Program. Iowa State University Animal Industry Report, A.S. Leaflet R2284. Iowa State University Animal Industry Report, A. S. Leaflet R2292. doi.org/10.31274/ans_air-180814-433
- Busby, W. D. and D. R. Strohbehn. 2008. Evaluation of mud scores on finished beef steers dressing percent. Iowa State University Animal Industry Report, A. S. Leaflet R2292. doi.org/10.31274/ans_air-180814-426
- Reinhardt, C. D., W. D. Busby, and L. R. Corah. 2009. Relationship of various incoming cattle traits with feedlot performance and carcass traits. *J. Anim. Sci.* 87:3030-3042. doi:10.2527/jas.2008-1293
- Ibarburu-Blanc, M. A., J. D. Lawrence, D. Busby, and D. Strohbehn. 2010. Assessing the cost of beef quality revisited. Iowa State University Animal Industry Report, A. S. Leaflet R2505. doi.org/10.31274/ans_air-180814-515

- Busby, W. D. 2015. Lessons learned from 32 years of retained ownership – TCSCF summary. Driftless Region Beef Conference. Dubuque, Iowa. January 22-23. Accessed October 1, 2020.
<https://lib.dr.iastate.edu/cgi/viewcontent.cgi?article=1009&context=driftlessconference>

While this list of studies does not include all the studies from the Tri-County Steer Carcass Futurity Cooperative data, this list shows how the questions asked of the data evolve over time. These studies also reveal the richness of a dataset like the one from the Tri-County Steer Carcass Futurity Cooperative. Large datasets, when consistently and properly maintained, provide the unique opportunity to evaluate a multitude of variables, relationships between those variables, and trends in the data.

The rules and regulation, and health requirements as of October 1, 2020 are listed in Appendix A. The full description of the Tri-County Steer Carcass Futurity Cooperative database that was maintained in Microsoft Access and used in this dissertation is in Appendix B.

Superior Livestock Auction

Superior Livestock Auction is the largest cattle auction service in North America, marketing approximately two million head of cattle each year (Superior Livestock Auction, 2020). Introducing satellite video marketing in 1987, Superior Livestock Auction changed the way producers could market load-lots of cattle by creating a national livestock market (Superior Livestock Auction, 2020). Superior Livestock Auction is a nation-wide cattle marketing service, serving both the buyer and seller of lots of cattle (Superior Livestock Auction, 2020). Superior Livestock Auction has several sale formats including video auctions, Country Page, private treaty,

Internet auction, dairy video auctions, and Superior Select video auctions. Compared with traditional livestock markets, such as local sale barns, marketing cattle through video auctions allows a seller to market cattle to buyers throughout the nation, without limitations of local supply and demand.

Starting in 1995, Pfizer Animal Health, in cooperation with Colorado State University, began collecting and storing data that described lots of beef cattle marketed for sale through Superior Livestock Auction video sales in computer databases (Microsoft Access) for the purpose of evaluating the effect of health protocols on the sale price. Separate databases were created for each year of the study, then combined in a master database. In 1995, only lots of single gender beef calves and that sold through seven summer video auctions were recorded in the database. There were 1,825 lots of single gender beef calves included in the 1995 database. In 1996, all videos auctions were included and lots of single gender beef calves and feeder cattle that sold or did not sell were included in the database. From 1995 through 2009, the data about a lot of cattle were obtained from sale catalogs that contained written descriptions about the lot as provided by the seller and a sales representative from the auction service. The detailed information for lots of cattle consigned to video auctions was entered manually into the databases. Data were only collected on single gender lots of beef calves and lots of feeder cattle (1995-2005) marketed through video auctions during this time.

The primary objective of the project when initiated in 1995 was to quantify the effects of the health protocols of Superior Livestock Auction Value-Added Health program on the sale price of lots of beef calves while adjusting for all other factors that significantly affected the price. Initially, the Value-Added Calf (VAC) program consisted of four calf health protocols: VAC 24, VAC 34, VAC 45, and VAC PreCon. In 2008, the VAC 34+ protocol was added to the program.

The VAC 45+ protocol was added in 2012. The VAC 60 protocol was added in 2020. The management and vaccination requirements for each of these health protocols have remained essentially the same throughout the study years with only minor changes being made. This project was funded by Pfizer Animal Health from 1995 through 2012.

Beginning in 2013, Merck Animal Health funded the project, and Kansas State University became responsible for managing the database. Superior Livestock Auction began to provide the sale and delivery data for all lots of cattle including calves, feeder cattle, replacement heifers, bred heifers, spayed heifers, open cows, bred cows, cow-calf pairs, breeding bulls, exposed heifers, milking cows, open feeder heifers, springer heifers, exposed cows, weight cows, and cull bulls in an electronic format (Microsoft Excel). Receiving the data in an electronic format made for a richer database with more detailed information about a lot because more information was provided, and it was in a more user-friendly format than manually recording the information. The electronic spreadsheet also included all of the cattle sale types including video auctions, Country Page, private treaty, Internet auction, dairy video auctions, and Superior Select video auctions. Data were available for all cattle types in both single- and mixed-gender lots. Superior Livestock Auction provided the sale and delivery data in an electronic format from 2010 through May 23, 2019.

Maintaining a database like the one described above was a tedious and dynamic process. As the beef industry changes and evolves, the detailed information provided for a buyer about a lot of cattle changes. The more information the buyer has about a lot of cattle, the less risk involved in the purchase. For example, if a buyer has the information before purchase that a lot of calves is not vaccinated, not weaned, and co-mingled in the sale barn, the buyer is better able to assess the risk associated with the purchase of those animals, and better gauge the price they are willing to pay. Another example is if a buyer is wants to purchase animals for potential export markets, if

the buyer provides the necessary information, the buyer knows if a lot of calves will meet their needs. While there is no published literature relating to the amount of detail buyers prefer for purchasing a lot of calves, it is assumed that more information available to a buyer results in a more informed decision.

In order to collect data reflective of industry changes, this required manual coding of data to store in the database, even after the information was received electronically. The complexity of coding these data is due to the types of data included. Some data were quantitative, such as weight and number of head within the lot. Other parts of the data were qualitative, such as breed description, origin, frame score, and flesh score. The integrity of a database lies within the validity of the data. This project and database are unique as the same person has maintained the database since 1995. Mr. Mike King maintained this database in its entirety and made all subjective coding decisions for the qualitative variables describing lots of cattle. Mr. King having been the sole manager of the database creates uniformity and consistency of the subjective decisions required to maintain the database.

Figure 1.1 - Lot examples from a 1995 Superior Livestock Auction video sale catalog

<p>LOT # 7382A 95 Weaned Str Calves Lazy Horse Ranch BASE WT: 525# CURRENT LOCATION: Lazy Horse Ranch, 40 miles E of McAlester, OK which is 190 miles E of Oklahoma City, OK BREED TYPE: Out of Black, BWF & RWF raw boned stretchy cows by High Indexing Performance Tested Salers bulls. A few calves have a touch of ear, mostly English crosses with Salers influence. ORIGIN: Home Raised FRAME: Med, Med Lg EST. WT. VAR: Uneven FEED: Weaned on native & bermuda grass supplemented with 10 lbs. per hd per day of Purina Pre-Condition Chow, hand fed. DELIVERY: FOB Lazy Horse Ranch - November 5-15, 1994, Rep's Option. WEIGHING COND: Gather from pasture by 8:00 a.m., sex, load on buyer's truck, haul 40 miles to Big V Feed Mill in McAlester, OK & weigh on the truck with a 1%. SLIDE: 10 cents - over 10 lbs. over base weight COMMENTS: Weaned 3rd week in September. Calves are enrolled in Superior's Vac-45 program as well as Friona Industries Pro-Edge Health program. Calves will qualify for the All Natural Program. IMPLANTED: No REPRESENTED BY: Sherrill Livestock 918-423-2834 Kenneth Sherrill 918-423-7684 PRICE <u>82.00</u> ✓</p> 	<p>LOT # 7387A 275 Weaned Str Calves T&M Cattle Co. BASE WT: 540# CURRENT LOCATION: Ranch, 5 miles E of Richmond, TX which is 30 miles W of Houston, TX BREED TYPE: Out of Brahman influence cows by Hereford & Angus bulls. ORIGIN: Home Raised FRAME: Med, Lg EST. WT. VAR: Uneven FEED: Grass & chow. DELIVERY: FOB Ranch - October 24-26, 1994, Rep's Option. WEIGHING COND: Gather early morning, sort, load on buyer's truck, haul 7 miles to scales & weigh on the truck with a 2%. SLIDE: 10 cents - over 10 lbs. over base weight COMMENTS: Vacc. with IBR, PI3, BRSV, Pasteurella, 8-Way Blackleg & Ivomec F. Knife cut. Weaned 45 days on first delivery date. IMPLANTED: No REPRESENTED BY: Steve Jordan 713-371-2396 PRICE <u>76.85</u> ✓</p>
---	---

The beef industry is continually evolving, and some industry shifts were reflected in these data collected over more than two decades. The way lots of cattle are described when sold through video auctions has changed. Figure 1.1 includes two lot examples from one of the 1995 Superior Livestock Auction video sale catalogs when the project began. Figure 1.2 includes two lot examples from one of the 2020 Superior Livestock Auction video sale catalogs. Though industry changes have certainly been apparent, many of

Figure 1.2 - Lot examples from a 2020 Superior Livestock Auction video sale catalog

LOT# 1831A **Hanging U Ranch**

60 Weaned Str Calves **BASE WT: 650#**
ORIGIN: Home Raised **RightSlide: \$0.70**
CURRENT LOCATION: Ranch, 16 mile(s) S of Yuma, CO which is 140 miles NE of Denver, CO
BREED TYPE: Out of Angus & a few BWF cows by high indexing Cheyenne & Cardinal Charolais bulls. Head counts may vary due to sort.
FRAME: Med - Med Lg **FLESH:** Medium
EST. WT. VAR: Uneven **HORNS:** Nubs or Small, if any
FEED: Rye pasture, salt & mineral.
DELIVERY: Feb. 1-10, 2020, Rep's Option. FOB Ranch
WEIGHING COND: Gather early by horseback, sort for sex, brand inspect, load on buyers truck, haul approx. 16 miles & weigh on truck w/a 1%. Freight adjustment of \$300 if over 100 miles, \$100 if under 100 miles. 39,000# Id(s).
COMMENTS: Knife cut. Very nice set of green, home raised calves.
VACCINATIONS: VAC 60. BoviShield Gold 5 & One Shot Ultra 7 @ branding. Boosted with same twice. Dectomax Pour On twice in the fall. BQA certified.
IMPLANTED: No
SOURCE/AGE VERIFIED: SUPERIOR VERIFIED
REPRESENTED BY: Mike Bolinger 970 380-7253
 Austin Bolinger 970 571-3297

LOT# 1112 **Harrington Ranch LLC**

40 Feeder Steers **BASE WT: 760#**
27 Feeder Heifers - \$ 12/cwt Back **640#**
ORIGIN: Home Raised
SLIDE: 10 cents over/under up to 25# over/under base weight
CURRENT LOCATION: Ranch, 5 mile(s) N of Separ, NM which is 40 miles W of Deming, NM
BREED TYPE: Out of Angus, Angus Hereford cross & Angus Brangus cross cows by reg. McKenzie Angus & reg. Upstream Hereford bulls. 100% Black & BWF. ***Certified Non GMO Compliant***
FRAME: Medium **FLESH:** Lt Med - Med
EST. WT. VAR: Uneven **HORNS:** Dehorned, Muley, few w/Horns
FEED: Weaned on hay & native pasture supplemented w/12% PreCon pellets.
DELIVERY: Jan. 12-17, 2020, Rep's Option. FOB Ranch
WEIGHING COND: Gather early from trap & weigh on ground w/a 3%.
COMMENTS: Big sort from 400 str & middle sort from 370 hrs. NM BQA certified. 2 ranch brands.
VACCINATIONS: Tested PI Free. VAC 60. BoviShield Gold & Ultrabac 7 Somnus @ brand. BoviShield Gold One Shot @ wean. Boosted w/BoviShield Gold & Ivomec.
IMPLANTED: No
SOURCE/AGE VERIFIED: SUPERIOR VERIFIED
REPRESENTED BY: Butch Mayfield 575 436-2544

the foundational variables described about these lots have not changed such as weight, origin, location, breed type, frame score, flesh score, and implant status. A noticeable difference between the 1995 and 2020 lots descriptions are the icons at the bottom of the description. Each icon represents a “value-added program” or a “genetic merit program” recognized by Superior Livestock Auction. Few programs existed in 1995 but a number of programs have been added since and continue to be developed. The VAC icon was the first in the catalogs as Superior

has been an industry leader in developing health and management programs designed to increase value of calves.

Other programs beyond calf health were also added over time. The Certified Natural program was introduced to Superior video auction catalogs in 2004. Age and Source Verified followed in 2005. In 2006, the first lots of AngusSource program cattle were identified in the database. In 2008, two new programs were added: bovine viral diarrhea persistently infected free (BVD-PI Free) and Non-Hormone Treated Cattle (NHTC). The Superior Progressive Genetics program was added in 2009. From there, the number of programs a lot can qualify for has vastly grown. In 2020, there were 23 programs recognized through Superior Livestock Auction (Superior Livestock Auction, 2020). The specific timeline of changes and additions to the database can be found in Appendix C.

Other changes in the beef industry that are reflected in these data include changes in management practices such as vaccinations administered and use of growth promoting implants. At the beginning of this project in 1995, 40% of the lots sold included calves that were not weaned and received no viral vaccinations. This population of calf lots was initially used as the reference population for health programs in analyses. In 2010, however, only 1% of the lots sold were not weaned and had not received viral vaccinations indicating a significant shift in cow-calf management practices. The reference population for health programs subsequently changed to those lots of calves not weaned and that had received a respiratory viral vaccination at some time. The reference population for health protocols changed again in 2013 to the VAC 24 protocol. The change in the reference population for vaccinations demonstrated a change in the health management by beef producers using video auctions to sell their calves.

Since the onset of development of the Superior Livestock Auction database, numerous studies, abstracts, and popular press articles were published from data analyses. In the early stages

of the project, the primary goal was to evaluate the effect of value-added health programs offered through Superior Livestock. As the beef industry changes, new questions become relevant and information needed to answer those questions change. As new value-added programs became available and as new questions arose concerning the data, additional information was recorded for each lot such as sire breed of the lot and if a lot met the qualifications for the Beef Quality Assurance program. This additional information provided insight into different types of questions that have been addressed by analysis of these data throughout the last two decades. More recent studies in the literature arising from analyses of the Superior Livestock Auction database include:

- King, M.E., M.D. Salman, T.E. Wittum, K.G. Odde, J.T. Seeger, D.M. Grotelueschen, G.M. Rogers, G.A. Quakenbush. 2006. Effect of certified health programs in the sale price of beef calves marketed through a livestock video auction service from 1995 through 2005. *JAVMA* 229:1389-1400. <https://doi.org/10.2460/javma.229.9.1389>
- Seeger, J.T., M.E. King, D.M. Grotelueschen, G.M. Rogers, G.S. Stokka. 2011. Effect of management, marketing, and certified health programs on the sale price of beef calves sold through a livestock video auction service from 1995 through 2009. *JAVMA* 239:451-466. doi: 10.2460/javma.239.4.451
- Rogers, G.M., M.E. King, K.L. Hill, T.E. Wittum, K.G. Odde. 2015. The effect of growth promoting implant status on the sale price of beef calves sold through a livestock video auction service from 2010 through 2013. *Prof. Anim. Sci.* 31:443-447. <https://doi.org/10.15232/pas.2015-01396>
- McCabe, E. D., M. E. King, K. E. Fike, K. L. Hill, G. M. Rogers, K. G. Odde. 2019. Breed composition affects the sale price of beef steer and heifer calves sold through video

auctions from 2010 through 2016. *Applied Animal Science*. 35: 221-226.
<https://doi.org/10.15232/aas.2018-01806>

- McCabe, E. D., M. E. King, K. E. Fike, K. L. Hill, G. M. Rogers, K. G. Odde. 2020. Breed trends in beef calf lots marketed through video auctions from 1995 through 2018. *Applied Animal Science*. 36: 78-90. <https://doi.org/10.15232/aas.2019-01902>

These studies demonstrate how the questions asked evolved. Early in the project, the questions were about management, vaccination, and marketing programs. The questions evolved to evaluating specific breed and sire-breed effects on sale price to evaluating national and regional breed trends for lots of beef calves sold. The fourth chapter of this dissertation evaluates additional breed effects, specially the value of the Holstein breed, for lots of feeder cattle, and the value of the beef-dairy cross for lots of calves sold through Superior Livestock Auction.

A more detailed timeline of specific changes in the database were included in Appendix C. The list of variables included in the database is included in Appendix D. This list also includes the specific years when variables were added to the database, sectioned by foundational variables, Superior Livestock Auction programs, and programs that were not Superior Livestock Auction programs but recognized through the catalog.

Summary

Databases like the two described above provide the unique opportunity to investigate questions that cannot be met with traditional experimental studies. The information derived from these databases over the last 25 years has provided insight for beef producers and others in academics. Assessing the changes in trends, whether for variables about lots of calves selling through video auctions or variables for feedlot cattle, demonstrates the change during that time

period. For example, evaluating the trends for vaccinations of lots of calves sold through video auctions demonstrated the progress made for use of vaccinations in beef calves. Another example includes evaluating the trends of breed descriptions for lots of beef calves marketed through video auctions. These breed description trends show changes in the beef industry for the primary breed make-up of lots of calves. While this information can be speculated, having the data to truly show changes or lack thereof demonstrates if “progress” is actually made.

The opportunity to dive into databases allows additional questions to be asked of the data based on what information is available in the database. There is incredible potential for data analytics in the beef industry, once data is properly collected and managed. The biggest challenges for data analytics in the beef industry is proper data collection, management, and execution of analyzing the data. In addition, those in the beef industry have to use the data to make decisions for the data analytics process to be meaningful.

All segments of beef production already use forms of data analytics. The cow-calf segment uses data analytics to make breeding and culling decisions, determine costs and revenue, and track cow production. The stocker segment uses data analytics for tracking performance, morbidity and mortality, and timing of when cattle are ready to go to the feedlot. The feedlot segment uses data analytics to evaluate performance, feed costs, and project when cattle are going to be finished.

At this point, descriptive analytics and diagnostic analytics are primarily used in the beef industry. Databases, however, allow the opportunity for use of predictive analytics in the beef industry. These predictive analytics can be used to predict heifers or cows coming into estrus, cattle with subclinical illness, or what bull calves are most valued for a seedstock producer.

There are numerous data sources available in the beef industry and they are not created equally. The insight gleaned from a database is only as good as the quality of data used. For

example, if the data in the database was not properly maintained or the information is not accurate, the results from those data will not be useful. If a database, however, is maintained and properly managed, the insight from those data can be valuable. The beef industry is in the beginning stages of identifying the possibilities of data analytics. The studies from the databases used for this dissertation does not encompass all of the potential with these data. These studies, however, provide insight and examples of how data analytics can use observational data from the beef industry.

Literature Cited

- Abell, K. 2017. Predictive analytics and data management in beef cattle production medicine. PhD. Diss. Kansas State Univ., Manhattan, KS.
- Agrawal, D., P. Bernstein, E. Bertino, S. Davidson, U. Dayal, M. Franklin, J. Gehrke, L. Haas, A. Halevy, J. Han, H. V. Jagadish, A. Librinidis, S. Madden, Y. Papakonstantinou, J. Patel, R. Ramakrishnan, K. Ross, C. Shahabi, D. Suciu, S. Vaithyanathan, and J. Widom. 2011. Challenges and opportunities with big data 2001-1. Cyber Center Technical Reports. Paper 1.
- Bekker, A. 2019. 4 types of data analytics to improve decision-making. ScienceSoft. Accessed October 10, 2020. <https://www.scnsoft.com/blog/4-types-of-data-analytics>
- Busby, D. 2015. Lessons learned from 32 years of retained ownership – TCSCF summary. Driftless Region Beef Conference, Dubuque, IA.
- Cabrera, V. E., J. A. Barrientos-Blanco, H. Delgado, and L. Fadul-Pacheco. 2020. Symposium review: Real-time continuous decision making using big data on dairy farms. *J. Dairy Sci.* 103:3856-3866. doi.org/10.3168/jds.2019-17145
- Cornell University. 2020. Cornell net carbohydrate and protein system. Accessed October 10, 2020. <https://blogs.cornell.edu/cncps/>

Foote, K. D. 2018. A brief history of analytics. Dataversity. Accessed September 21, 2020.

<https://www.dataversity.net/brief-history-analytics/#>

Gandomi, A. and M. Haider. 2015. Beyond the hype: Big data concepts, methods, and analytics.

Int. J. Inf. Manage. 35:137-144. doi.org/10.1016/j.ijinfomgt.2014.10.007

Greiner, S. P. 2009. Understanding expected progeny differences (EPDs). Virginia Cooperative

Extension, Publications and Educational Resources. 400-804. Accessed September 21,

2020. <https://www.pubs.ext.vt.edu/400/400-804/400-804.html>

Groves, M. 2020. Personal communication. January 28, 2020.

Hill, W. G. 2016. Is continued genetics improvement of livestock sustainable? *Genetics*.

202:877-881. doi.org/10.1534/genetics.115.186650

Jain, A. 2016. The 5 V's of big data. IBM. Accessed October 10, 2020.

<https://www.ibm.com/blogs/watson-health/the-5-vs-of-big-data/>

Koltes, J. E., J. B. Cole, R. Clemmens, R. N. Dilger, L. M. Kramer, J. K. Lunney, M. E. McCue,

S. D. McKay, R. G. Mateescu, B. M. Murdoch, R. Reuter, C. E. Rexroad, G. M. Rosa, N.

L. Serão, S. N. White, M. J. Woodward-Greene, M. Worku, H. Zhang, and J. M. Reecy.

2019. A vision for development and utilization of high-throughput phenotyping and big

data analytics in livestock. *Front. Genet.* 10:1197. doi: 10.3389/fgene.2019.01197

Liberty, D. 2019. Data science vs. data analytics – What’s the difference? Sisense. Accessed October 12, 2020. <https://www.sisense.com/blog/data-science-vs-data-analytics/>

Marr, B. 2015. A brief history of big data everyone should read. World Economic Forum. Accessed September 21, 2020. <https://www.weforum.org/agenda/2015/02/a-brief-history-of-big-data-everyone-should-read/>

Michigan State University. 2019. 4 types of data analytics and how to apply them. Michigan State University. Accessed October 10, 2020. <https://www.michiganstateuniversityonline.com/resources/business-analytics/types-of-data-analytics-and-how-to-apply-them/>

Piñeiro, C., J. Morales, M. Rodríguez, M. Aparicio, E. G. Manzanilla, and Y. Koketsu. 2019. Big (pig) data and the internet of the swine things: a new paradigm in the industry. *Anim. Front.* 9:6-15. doi.org/10.1093/af/vfz002

Press, G. 2016. Cleaning big data: Most time-consuming, least enjoyable data science task, survey says. Accessed October 1, 2020. <https://www.forbes.com/sites/gilpress/2016/03/23/data-preparation-most-time-consuming-least-enjoyable-data-science-task-survey-says/#595f77db6f63>

Reinhardt, C. D., W. D. Busby, and L. R. Corah. 2009. Relationship of various incoming cattle traits with feedlot performance and carcass traits. *J. Anim. Sci.* 87:3030-3042.

doi:10.2527/jas.2008-1293

SAS. 2020. Big Data, what it is and why it matters. SAS Big Data Insights. Accessed October 10, 2020. https://www.sas.com/en_us/insights/big-data/what-is-big-data.html

Superior Livestock Auction. 2020. About Superior Livestock Auction. Accessed October 1, 2020. <http://www.superiorlivestock.com/home/about-us>

Taylor, C. 2018. Structured vs. unstructured data. Accessed October 15, 2020.

<https://www.datamation.com/big-data/structured-vs-unstructured-data.html>

Tri-County Steer Carcass Futurity Cooperative. 2020a. TCSCF Rules & Regulations. Accessed October 1, 2020. http://www.tcscf.com/TCSCF_Rules_Regulations.pdf

Tri-County Steer Carcass Futurity Cooperative. 2020b. Welcome. Accessed October 1, 2020.

<http://www.tcscf.com/>

United States Department of Agriculture, National Institute of Food and Agriculture, (USDA, NIFA). n.d.a. Precision Agriculture in Animal Production. Accessed October 21, 2020.

<https://nifa.usda.gov/precision-agriculture-animal-production>

United States Department of Agriculture, National Institute of Food and Agriculture (USDA, NIFA). n.d.b. Precision Agriculture in Crop Production. Accessed October 21, 2020.
<https://nifa.usda.gov/precision-agriculture-crop-production>

White, B. J., D. E. Amrine, and R. L. Larson. 2018. Big data analytics and precision animal agriculture symposium: Data to decisions. *J. Anim. Sci.* 96:1531-1539. doi:
10.1093/jas/skx065

**Chapter 2 - Performance, health, and carcass trends for steers and
heifers finished through Tri-County Steer Carcass Futurity
Cooperative from 2002 through 2018**

E. D. McCabe*, M. E. King*, M. Groves[†], J. Waggoner*, K. E. Fike*, and K. G. Odde*

*Department of Animal Sciences and Industry, Kansas State University, Manhattan, KS, 66506;

[†]Tri-County Steer Carcass Futurity Cooperative, Lewis, IA, 51544

Abstract

The objective was to analyze the overall trends for performance, health, and carcass traits for steers and heifers finished through the Tri-County Steer Carcass Futurity Cooperative from 2002 through 2018. Data analyzed for performance and carcass trends included 70,196 steers and 30,965 heifers. Any animals with missing data for performance or carcass traits were removed from this dataset. Performance measurements included arrival weight, average daily gain, feed to gain, days on feed, and harvest weight. Carcass trait trends evaluated for steers and heifers included calculated yield grade score, fat thickness, hot carcass weight, kidney pelvic heart fat, marbling score, and ribeye area. Data analyzed for health trends included 76,118 steers and 34,632 heifers. Health trends for morbidity, number of times treated, and mortality were evaluated for steers and heifers. Marbling and mortality increased over the duration of this study. Hot carcass weight increased, but not as much as observed in other industry sources. Fat thickness increased over the duration of the study. This was likely due to a management decision to increase carcass value. This study describes overall trends in performance, health and carcass traits for steers and heifers managed in Iowa feedlots. Understanding these trends will be useful for decision making for cow-calf producers and feedlot managers.

Introduction

The number of cattle for beef production has decreased by approximately six percent since 1970 (USDA, ERS, 2018). During that same time, beef production has increased by 25% (USDA, ERS 2018), indicating beef production has become more efficient. Increased efficiency in beef production is likely a result of improvements in nutrition, management and genetics. Since 1970,

the average weight of cattle at slaughter has increased more than 30%, allowing more beef production with fewer head of cattle (USDA, ERS, 2018).

The United States beef cow inventory peaked at just under 46 million head in 1975 (USDA, NASS, 2020a). Today's United States beef cow inventory is just under 32 million head (USDA, NASS, 2020a). Meanwhile, metric tonnes of beef produced in the United States was 10.9 million in 1975, while metric tonnes of beef produced in the United States in 2019 was 12.3 million (USDA, NASS, 2020b). The United States beef industry is now producing slightly more beef than it did in 1975 and doing it with 16 million fewer beef cows. This increase in beef production efficiency is likely due to increased reproductive efficiency, improved calf survival and growth and increases in carcass weight at slaughter. Traits of importance in beef cattle production are often antagonistic. For example, marbling and rib eye area have been reported to have negative genetic correlations (Johnston et al., 1992; Bergen et al., 2005). Health and growth performance have also been reported to have negative genetic correlations (Snowder et al., 2007; Schneider et al., 2010). Recent evidence suggests that calf health in the feedlot is declining rather than improving (Maday, 2016). Documenting trends in performance, health and carcass traits should provide a better understanding of the "true progress" being made.

The opportunity to evaluate trends in performance, health and carcass traits was available through a feedlot cooperative in Iowa. Tri-County Steer Carcass Futurity Cooperative was started to determine what the "most profitable steer was to feed" (Busby, 2015). The Tri-County Steer Carcass Futurity Cooperative provides feedlot performance and carcass data back to participants. The purpose of the program is for producers to use the information to make breeding and management decisions based on the performance data of the cattle. There were an average of 6,638 head finished annually through the program during the time of this study. This provides the unique

opportunity to evaluate trends for performance, health, and carcass data. The objective was to analyze the overall trends for performance, health, and carcass traits for steers and heifers finished through the Tri-County Steer Carcass Futurity Cooperative from 2002 through 2018.

Materials and Methods

Data Collection

Approval for this research by an Institutional Animal Care and Use Committee was not needed given the nature of the records and data used for analyses.

Information describing factors about steers and heifers finished through Tri-County Steer Carcass Futurity Cooperative (Lewis, IA) was obtained in an electronic format. These data were collected for steers and heifers fed at 23 Iowa feedlots from 2002 through 2018. Not all feedlots participated in all years.

The health protocol was listed at www.tscsf.com. Calves enrolled in the program were to be weaned at least 30 days prior to delivery. Bulls were castrated prior to arrival and was suggested to be performed prior to weaning. Calves needed to be treated for internal and external parasites. Horns were removed prior to arrival and was suggested to be performed prior to weaning. All cattle were to receive two doses of modified live viral vaccine, preferably preweaning and at weaning, respectively. Cattle were required to receive two doses of a 7-way blackleg prior to arrival. Tri-County Steer Carcass Futurity Cooperative encouraged consignors to work with their veterinarian to develop a complete herd health program.

The Tri-County Steer Carcass Futurity Cooperative primary objective was to provide producers participating in the program with performance and carcass data on enrolled steers and heifers. Steers and heifers fed through the Tri-County Steer Carcass Futurity Cooperative were

typically spring-born calves. The majority of calves in the program were delivered to the feedlot in Iowa during September, October, November, or December (10, 21, 22, and 13%, respectively). Steers or heifers weighing greater than 453.1 kg upon arrival were removed from analysis. From 2002 through 2018, an average of 6,599 steers or heifers were enrolled in the program annually. Steers comprised 69% and heifers 31% of animals enrolled in the program during this time. A “modest” implant program was used in these steers and heifers. All feedlots participating in the program fed a common dietary energy level. A warm-up ration was fed for 28 days prior to starting test (Tri-County Steer Carcass Futurity Cooperative, 2020).

Animals were fed in a total of 1,076 pens with an average of 94 head of steers and/or heifers in a pen. Pens of steers and/or heifers were harvested on at least two different dates approximately five weeks apart based on visual appraisal determined by the Tri-County Steer Carcass Futurity Board. These cattle were then marketed on a grid. These cattle were primarily harvested during the months of March, April, May, or June (10, 23, 21, and 11%, respectively). Steers and heifers were weighed at least four times including arrival weight, start of test, time of re-implant, and prior to harvest. Carcass data were collected at time of slaughter. Cattle were harvested in Denison, IA from 2002 through 2014, and in Dakota City, NE from 2015 through 2018. Carcass data began to be collected from instrument grading starting in 2015. Instrument grading was used for carcass trait measurement starting in 2015. There were eight animals with a quality grade below standard and they were removed from this analysis.

Data analyzed for performance and carcass trends included 70,196 steers and 30,965 heifers harvested from 2002 through 2018. Any animals with missing data for performance or carcass traits were removed from this study. Performance measurements in this study included arrival weight, average daily gain, feed:gain, days on feed, and harvest weight. Arrival weight was

recorded within four days of arrival (Busby, 2015). Average daily gain was calculated by subtracting arrival weight from harvest weight and dividing by days on feed. Feed:gain calculated by dividing total kilograms of feed fed by total kilogram of weight gain over the feeding period. Individual feed intake within a pen was determined using the Cornell Net Carbohydrate and Protein Model (Groves, 2020). The Cornell Net Carbohydrate and Protein Model is well described in literature and periodically updated to improve accuracy (Cornell University, 2020). “The Cornell Net Carbohydrate and Protein System was developed to predict requirements, feed utilization, animal performance and nutrient excretion for dairy and beef cattle using accumulated knowledge about feed composition, digestion, and metabolism in supplying nutrients to meet requirements” (Cornell University, 2020). Carcass trait trends evaluated for steers and heifers included calculated yield grade score, fat thickness, hot carcass weight, dressing percentage, kidney pelvic heart fat percentage, marbling score, ribeye area, and carcass value. Carcass value (total dollar value for carcass) was calculated by multiplying the adjusted base carcass weight per 45.36kg by hot carcass weight then divided by 100.

Data analyzed for health trends included 76,118 steers and 34,632 heifers. Morbidity and mortality data were recorded from daily observations collected by feedlot employees or a feedlot veterinarian. Employees that evaluated health were trained by Iowa State University veterinarians (Reinhardt et al., 2009). Health trends for morbidity risk, number of times treated, and mortality risk were evaluated for steers and heifers. An animal documented with at least one morbidity event was considered morbid. Steers and heifers were grouped by not-treated or not-morbid, treated one time, treated two times, or treated three or more times during the feeding period. A mortality event for an animal was recorded if the animal died at any point after arriving to the feedlot.

Statistical Analyses

Linear regression models were developed to quantify the fixed effect of year on the outcomes of interest including arrival weight, average daily gain, feed:gain, days on feed, harvest weight, hot carcass weight, fat thickness, ribeye area, kidney pelvic heart fat percentage, dressing percentage, marbling score, calculated yield grade, and carcass value. The REG procedure of SAS (version 9.4, SAS Institute Inc., Cary, NC) was used for the analyses (SAS Institute Inc., 2020b). A value of $P < 0.05$ was required for a fixed effect to remain in the model.

The Cochran-Armitage trend test was used to determine the presence of an increasing or decreasing trend in the percentage of morbidity, mortality, and number of times treated for steers or heifers, with $P \leq 0.05$ considered significant (SAS Institute Inc., 2020a). The Cochran-Armitage trend test determines trends in binomial proportions for levels of a single variable (SAS Institute Inc., 2020).

Results and Discussion

Data analyzed for performance and carcass traits were collected from 2002 through 2018. There were 70,196 steers and 30,965 included in these analyses. Unadjusted means, standard deviations, median, and range values for continuous variables describing steers and heifers (Table 2.1) finished from 2002 through 2018 were summarized. Regression coefficients, P values, and R^2 values for effect of year on various outcomes of interest for steers and heifers are listed in Table 2.2.

Data analyzed for health trends were collected from 2002 through 2018. There were 76,118 steers and 34,632 heifers included in the health trend analyses. Feedlot cattle included in these analyses had at least one morbidity event.

Performance Trends

The regression coefficients (slope) were significant ($P < 0.10$) for each of these traits over time for both steers and heifers with the exception of feed:gain ($P = 0.59$; Table 2.2). The R^2 for these equations was small, however, indicating that year only accounted for small amount of the variation, and that there was little change in these traits for the duration of the study (Table 2.2; Figure 2.1, Figure 2.2, Figure 2.3, Figure 2.4, Figure 2.5). Surprisingly, harvest weight only increased by 1.2 kg/year for steers and 0.6 kg/year for heifers (Table 2.2). These changes in final weight during this time period were far lower than those seen from other sources. Focus on Feedlots showed an increased in harvest weight from 2002 through 2018 (Waggoner, 2018). Steers increased from 582.4 kg to 634.1 kg (Waggoner, 2018). Heifers increased from 526.6 kg to 577.0 kg (Waggoner, 2018). The United States Department of Agriculture Economic Research Service (2020) historical data also showed an increasing trend in mean harvest weight from 560.2 kg in 2002 and 619.9kg in 2018. The United States Department of Agriculture Economic Research Service (2020) historical data showed an increase of 3.6 kg/year for harvest weight.

Feed:gain was the measure of feed efficiency in this study. Since feed cost comprises about 70% of total costs in a beef cattle operation, feed efficiency is closely related to profitability. Improvement in feed efficiency has been a focus of many in the beef industry to improve profitability through lower input costs. Our results did not show improvement in feed efficiency for feedlot cattle from 2002 through 2018.

Health Trends

Morbidity

The percentage of morbid steers and heifers increased ($P < 0.0001$) from 2002 through 2018 (Figure 2.6). The overall mean morbidity risk for steers was 24% and 20% for heifers.

Number of Times Treated

The percentage of steers receiving no treatment decreased ($P < 0.0001$) from 2002 through 2018 (Figure 2.7). During the same period, the percentage of steers treated one time increased ($P < 0.0001$) from 10 to 21% (Figure 2.7). The percentage of steers treated two times increased ($P < 0.0001$) and percentage of steers receiving treatment three or more times increased ($P < 0.0001$) from 4 to 7% (Figure 2.7). The percentage of heifers not treated decreased ($P < 0.0001$) from 84 to 75% (Figure 2.8). Concurrently, the percentage of heifers treated one, two, or three or more times increased ($P < 0.0001$; Figure 2.8).

Mortality

The mortality percentage for steers and heifers increased ($P < 0.0001$ and $P < 0.001$, respectively; Figure 2.9). The overall mean mortality risk for steers was 1.8% and 1.4% for heifers.

The most common cause of morbidity and mortality in feedlot cattle in the United States is bovine respiratory disease (Loneragan et al., 2001; Brooks et al., 2011; USDA, 2013). Within the dataset used in the present study, specific causes of morbidity and mortality were not consistently reported but for those events that were diagnosed by a veterinarian, the most common cause was respiratory disease. In North American feedlot cattle, a review of veterinary literature found a morbidity risk from 15% to 45% and a mortality risk of 1% to 5% (Kelly and Janzen, 1986).

Focus on Feedlots reports mortality for the nine feedlots included in their data and there was a slightly increase in mortality (Waggoner, 2018). Steers and heifers had an average mortality of 1.4% from 2002 through 2018 (Waggoner, 2018).

Stehle et al. (2018) found steers had an average mortality risk of 1.8% while heifers had average mortality risk of 1.9%. Stehle et al. (2018) also reported differences in mortality risk based

on the arrival weight of cattle. Cattle that arrived at a lighter weight were more likely to die than cattle arriving at a heavier weight (Stehle et al., 2018). They also noted a seasonality difference for mortality risk (Stehle et al., 2018). They found mortality risk peaked in the spring and was lowest during the fall months (Stehle et al., 2018). The cattle represented in our study primarily arrived during the fall months.

The beef industry has had concern for the increase in morbidity and mortality risk over the last several years. Gary Vogel, a technical advisor for Elanco Animal Health, noted “feedlot-based mortalities have increased consistently by 0.05% for the previous 10 years” (Southern Farm Network, 2019). Even with access to better vaccines, treatment methods, and improvement in cattle management, mortalities in the feedlot were still increasing (Maday, 2016; Scott, 2020). While specific causes are unknown, cattle are remaining on feed for more days, which leads to the opportunity to have more cattle die while in the feedlot (Cooper, 2015; Maday, 2016; Scott, 2020).

Carcass Trends

The regression coefficients (slope) were significant ($P < 0.01$) for each of these traits over time for both steers and heifers (Table 2.2). With the exception of carcass value, the R^2 value for these equations was small. This indicates that year only accounted for small amount of the variation, and that there was little change in these traits for the duration of the study (Table 2.2; Figure 2.10, Figure 2.11, Figure 2.12, Figure 2.13, Figure 2.14, Figure 2.15, Figure 2.16, Figure 2.17).

Carcass value had an R^2 value of 0.54 for steers and 0.51 for heifers (Table 2.2). Year accounted for approximately 54% and 51% of the variation of carcass value for steers and heifers, respectively (Figure 2.17). The carcass value for steers increased \$48.09 per year and \$42.06 per year for heifers. According to Tatum et al. (2006), “carcass weight was the single most important

driver of carcass value”. Other factors that influenced carcass value during the time of these data include factors such as cost of feed, supply and demand, stage of cattle cycle, weather events, and unforeseen events globally.

Hot carcass weight only increased by 1.0 kg/year for steers and 0.3 kg/year for heifers (Table 2.2; Figure 2.10). Hot carcass weight for steers ranged from 330 to 354 kg and 304 kg to 323 kg for heifers (Figure 2.10). These changes in hot carcass weight during this time period were far lower than those seen from other sources, likely due to the lack of increase in harvest weights. The United States Department of Agriculture Economic Research Service (2020) reported an increase by 2.1 kg/year in hot carcass weight from 2002 through 2018. They reported a range of 338.4 kg to 376.0 kg (USDA, ERS, 2020).

Marbling score for steers increased 2.7 units each year and 4.4 units each year for heifers (Figure 2.15). While the mean marbling score increased within these data, the average carcass would grade as low choice in the current USDA quality grading system (Hale et al., 2013). In the current USDA grading system, a marbling score of 400 is equivalent to Small⁰⁰, which is the minimum marbling required for low choice (Hale et al., 2013; Boykin et al., 2017). Average choice marbling requires a marbling score of 500, equivalent to a Modest⁰⁰ degree of marbling (Hale et al., 2013; Boykin et al., 2017).

Ribeye area in the present study were smaller than those reported by the National Beef Quality Audit in 2016 (Boykin et al., 2017). The 2016 National Beef Quality Audit reported the average ribeye area 8.4 cm² larger than the present study (Boykin et al., 2017). Ribeye area slightly increased for steers from 78.9 cm² to 81.5 cm² and slightly decreased for heifers from 76.3 cm² to 75.4 cm² (Figure 2.12).

Antagonistic relationships exist between variables of importance in these data. While this study reported an increase in marbling score for both steers and heifers, ribeye area only slightly increased for steers and slightly decreased for heifers. This antagonistic relationship was shown by Johnston et al. (1992) and Bergen et al. (2005), which reported negative genetic correlations for marbling score and ribeye area.

Health and growth performance have also been reported to have negative genetic correlations. Gardner et al. (1999) found finishing steers that were treated for any disease had lower average daily gain than steers without morbidity. Reinhardt et al. (2009) reported cattle treated for bovine respiratory disease had reduced average daily gain and harvest weight. Reinhardt et al. (2012) found steers treated for any disease had lower average daily gain than steers not treated. In the present study, morbidity risk increased for steers and heifers over time, while average daily gain did not change from 2000 through 2018. This study, however, did not evaluate the relationship between morbidity risk and average daily gain.

Applications

The steers and heifers represented in these data are harvested at a lighter mean weight than the industry average, thus have a lighter hot carcass weight and smaller ribeye area; however, similar to industry trends, marbling score increased, and hot carcass weight and ribeye area increased slightly. Morbidity risk, number of times treated, and mortality risk increased over time in these data, although we do not have specific insights about timing of illness onset within the feeding period or the cause. These data may not entirely reflect commercial feedlots as 66% of the calves in this analysis arrived from September through December. These are primarily “calf feds” and not likely representative of yearling cattle going on feed. This study focused on overall trends

for steers and heifers finished through the Tri-County Steer Carcass Futurity Cooperative. It was outside the scope of the study to evaluate specific levels within a factor that may influence trends presented in this analysis.

Acknowledgements

The authors gratefully acknowledge the Tri-County Steer Carcass Futurity Cooperative, Lewis, IA, for providing the data and their cooperation for this research.

Literature Cited

- Bergen, R., S. P. Miller, and J. W. Wilton. 2005. Genetic correlations among indicator traits for carcass composition measured in yearling beef bulls and finished feedlot steers. *Can. J. Anim. Sci.* 85:463-473. doi.org/10.4141/A05-013
- Boykin, C. A., L. C. Eastwood, M. K. Harris, D. S. Hale, C. R. Kerth, D. B. Griffin, A. N. Arnold, J. D. Hasty, K. E. Belk, D. R. Woerner, R. J. Delmore Jr., J. N. Martin, D. L. VanOverbeke, G. G. Mafi, M. M. Pfeiffer, T. E. Lawrence, T. J. McEvers, T. B. Schmidt, R. J. Maddock, D. D. Johnson, C. C. Carr, J. M. Scheffler, T. D. Pringle, A. M. Stelzleni, J. Gottlieb, and J. W. Savell. 2017. National Beef Quality Audit – 2016: Survey of carcass characteristics through instrument grading assessments. *J. Anim. Sci.* 95:3003-3011. doi: 10.2527/jas2017.1544
- Brooks, K.R., K.C. Raper, C.E. Ward, B.P., Holland, C.R. Krehbiel, and D.L. Step. 2011. Economic effects of bovine respiratory disease on feedlot cattle during backgrounding and finishing phases. *Prof. Anim. Sci.* 27:195-203. doi.org/10.15232/S1080-7446(15)30474-5
- Cooper, D. 2015. Feedyard data reveals higher death losses. *Progressive Cattleman*. Accessed October 10, 2020. <https://www.progressivecattle.com/topics/herd-health/feedyard-data-reveals-higher-death-losses>
- Cornell University. 2020. Cornell net carbohydrate and protein system. Accessed October 10, 2020. <https://blogs.cornell.edu/cncps/>

Gardner, B. A., H. G. Dolezal, L. K. Bryant, F. N. Owens, and R. A. Smith. 1999. Health of finishing steers: effects on performance, carcass traits, and meat tenderness. *J. Anim. Sci.* 77:3168-3175. DOI: 10.2527/1999.77123168x

Groves, M. 2020. Personal communication. Manager Tri-County Steer Carcass Futurity Cooperative. June 10, 2020.

Hale, D.S., K. Goodson, and J.W. Savell. 2013. USDA Beef quality and yield grades. Accessed May 23, 2020. <https://meat.tamu.edu/beefgrading/>

Johnston, D. J., L. L. Benyshek, J. K. Bertrand, M. H. Johnson, and G. M. Weiss. 1992. Estimates of genetics parameters for growth and carcass traits in Charolais cattle. *Can. J. Anim. Sci.* 72:493-499. doi.org/10.4141/cjas92-061.

Kelly, A. P. and E. D. Janzen. 1986. A review of morbidity and mortality rate and disease occurrence in North American feedlot cattle. *Can. Vet. J.* 27: 496-500.

Loneragan, G.H., D.A. Dargatz, P.S. Morley, and M.A. Smith. 2001. Trends in mortality ratios among cattle in U.S. feedlots. *JAVMA.* 219:1122-1127. DOI: 10.2460/javma.2001.219.1122

Maday. 2016. The feedlot death conundrum. Drovers CattleNetwork, Ag Web. Accessed October 10, 2020. <https://www.agweb.com/article/the-feedlot-death-loss-conundrum-NAA-drovers-cattlenetwork>

Reinhardt, C. D., W. D. Busby, and L. R. Corah. 2009. Relationship of various incoming cattle traits with feedlot performance and carcass traits. *J. Anim. Sci.* 87:3030-3042. doi:10.2527/jas.2008-1293

Reinhardt, C. D., M. L. Hands, T. T. Marston, J. W. Waggoner, and L. R. Corah. 2012. Relationships between feedlot health, average daily gain, and carcass traits of Angus steers. *Prof. Anim. Sci.* 28:11-19. doi.org/10.15232/S1080-7446(15)30311-9

SAS Institute Inc. 2020a. Cochran-Armitage Trend Test. Accessed May 12, 2020. https://support.sas.com/documentation/cdl/en/statug/63347/HTML/default/viewer.htm#statug_freq_sect032.htm

SAS Institute Inc. 2020b. The REG Procedure. Accessed November 7, 2020. https://support.sas.com/documentation//cdl/en/statug/68162/HTML/default/viewer.htm#statug_reg_syntax01.htm

Schneider, M. J., R. G. Tait, M. V. Ruble, W. D. Busby, and J. M. Reecy. 2010. Evaluation of fixed sources of variation and estimation of genetic parameters for incidence of bovine

respiratory disease in preweaned calves and feedlot cattle. *J. Anim. Sci.* 88:1220-1228.
doi:10.2527/jas.2008-1755

Scott, K. 2020. Lots to learn about mid-feeding period mortality. *High Plains Journal*. Accessed October 13, 2020. https://www.hpj.com/livestock/lots-to-learn-about-mid-feeding-period-morbidity/article_4e184c5a-04b1-11eb-9be2-4b2e76c31f45.html

Snowder, G. D., L. D. Van Vleck, L. V. Cundiff, G. L. Bennett, M. Koohmaraie, and M. E. Dikeman. 2007. Bovine respiratory disease in feedlot cattle: Phenotypic, environmental, and genetic correlations with growth, carcass, and longissimus muscle palatability traits. *J. Anim. Sci.* 85:1885-1892. doi: 10.2527/jas.2007-0008

Stehle, A., D. S. Peel Breedlove, and J. M. Riley. 2018. A profile of cattle feeding: Beyond the averages. *W. Econ. Forum.* 16:62-77.

Southern Farm Network. 2019. Rising mortality rates on feedlots. Southern Farm Network. Accessed October 10, 2020. <http://sfntoday.com/rising-mortality-rates-on-feedlots/>

Tatum, J. D., K. E. Belk, T. G. Field, J. A. Scanga, and G. C. Smith. 2006. Relative importance of weight, quality grade, and yield grade as drivers of beef carcass value in two grid-pricing systems. *Prof. Anim. Sci.* 22: 41-47. DOI: 10.15232/S1080-7446(15)31059-7

Tri-County Steer Carcass Futurity Cooperative. 2020. TCSCF Rules and Regulations. Accessed September 21, 2020. <http://www.tcscf.com/>

United States Department of Agriculture (USDA). 2013. Types and costs of respiratory disease treatments in U.S. feedlots. USDA—APHIS—VS—CEAH—NAHMS. Fort Collins, CO. #671.0513

United States Department of Agriculture, Economic Research Service (USDA ERS). 2020. Livestock and Meat Domestic Data. Accessed September 13, 2020. <https://www.ers.usda.gov/data-products/livestock-meat-domestic-data/>

United States Department of Agriculture, National Agricultural Statistics Service (USDA, NASS). 2020a. Charts and Maps. Accessed November 7, 2020. https://www.nass.usda.gov/Charts_and_Maps/Cattle/bcow.php

United States Department of Agriculture, National Agricultural Statistics Service (USDA, NASS). 2020b. Quick Stats, Beef. Slaughter-Production. Accessed November 7, 2020. https://quickstats.nass.usda.gov/results/5B2AC4F5-CEBE-3589-9156-713979373C11?pivot=short_desc

Waggoner, J. 2018. Focus on Feedlots. Kansas State University Research and Extension. Accessed May 02, 2020. <https://www.asi.k-state.edu/about/newsletters/focus-on-feedlots/>

Figures and Tables

Table 2.1 - Non-adjusted means, medians, and ranges for continuous variables describing 70,196 steers and 30,965 heifers finished through the Tri-County Steer Carcass Futurity Cooperative from 2002 through 2018

Variable	Mean \pm SD	Median	Range
<u>Steers</u>			
Arrival Weight (kg)	304.2 \pm 54.2	302.1	62.6 to 453.1
Average Daily Gain (kg/day)	1.53 \pm 0.27	1.52	0.13 to 3.86
Feed to Gain (kg/0.4536 kg gain)	3.09 \pm 0.41	3.04	0.62 to 11.0
Days on Feed	169 \pm 29	167	54 to 333
Harvest Weight (kg)	560.2 \pm 54.3	557.9	318.4 to 809.8
Hot Carcass Weight (kg)	343.1 \pm 35.0	341.6	182.8 to 503.5
Fat Thickness (cm)	1.16 \pm 0.35	1.14	0.05 to 4.19
Ribeye Area (cm ²)	81.8 \pm 8.2	80.6	48.4 to 130.3
Kidney, Pelvic, Heart Fat (%)	2.2 \pm 0.4	2.0	0.3 to 5.0
Dressing Percentage	61.5 \pm 1.7	61.5	48.9 to 76.9
Marbling Score	430 \pm 81	430	100 to 946
Calculated Yield Grade	2.9 \pm 0.6	2.9	0.1 to 6.0
Carcass Value (\$)	1,261.19 \pm 318.90	1,175.02	406.42 to 2,761.75
<u>Heifers</u>			
Arrival Weight (kg)	288.2 \pm 56.9	283.9	90.7 to 452.7
Average Daily Gain (kg/day)	1.39 \pm 0.26	1.38	0.36 to 4.16
Feed to Gain (kg/0.4536 kg gain)	3.21 \pm 0.46	3.14	1.01 to 10.79
Days on Feed	163 \pm 34	160	54 to 368
Harvest Weight (kg)	510.0 \pm 48.3	503.5	309.4 to 754.5
Hot Carcass Weight (kg)	313.5 \pm 30.6	309.8	194.1 to 474.9
Fat Thickness (cm)	1.27 \pm 0.38	1.27	0.12 to 3.81
Ribeye Area (cm ²)	77.7 \pm 7.6	77.4	49.0 to 127.7
Kidney, Pelvic, Heart Fat (%)	2.3 \pm 0.4	2.5	1.0 to 5.5
Dressing Percentage	61.5 \pm 1.8	61.6	44.3 to 71.4
Marbling Score	460 \pm 95	446	200 to 982
Calculated Yield Grade	3.0 \pm 0.6	3.0	0.5 to 6.0
Carcass Value (\$)	1,154.59 \pm 277.15	1,087.01	376.16 to 2,477.90

Table 2.2 - Regression coefficients, P values, and R² values for effect of year on outcomes of interest for steers and heifers finished through the Tri-County Steer Carcass Futurity Cooperative from 2002 through 2018

Outcome	Steers			Heifers		
	Regression coefficient	<i>P</i> value	R ²	Regression coefficient	<i>P</i> value	R ²
Arrival Weight (kg)	0.59	< 0.0001	0.0028	0.22	< 0.001	0.0003
Average Daily Gain (kg/day)	0.00	< 0.10	0.0000	0.00	< 0.0001	0.0008
Feed to Gain (kg/0.4536 kg gain)	0.00	= 0.59	0.0000	0.00	= 0.95	0.0000
Days on Feed	0.36	< 0.0001	0.0035	0.90	< 0.05	0.0002
Harvest Weight (kg)	1.15	< 0.0001	0.0106	0.63	< 0.0001	0.0037
Hot Carcass Weight (kg)	0.95	< 0.0001	0.0176	0.31	< 0.0001	0.0023
Fat Thickness (cm)	0.02	< 0.0001	0.0507	0.02	< 0.0001	0.0523
Ribeye Area (cm ²)	0.18	< 0.0001	0.0120	-0.06	< 0.0001	0.0014
Kidney Pelvic Heart Fat (%)	0.01	< 0.0001	0.0163	0.01	< 0.0001	0.0034
Dressing Percentage	0.00	< 0.01	0.0001	-0.01	< 0.0001	0.0014
Marbling Score	2.69	< 0.0001	0.0258	4.38	< 0.0001	0.0471
Calculated Yield Grade	0.02	< 0.0001	0.0192	0.03	< 0.0001	0.0372
Carcass Value (\$)	48.09	< 0.0001	0.5383	42.06	< 0.0001	0.5082

Figure 2.1 - Arrival weight trend for steers and heifers finished through the Tri-County Steer Carcass Futurity Cooperative from 2002 through 2018

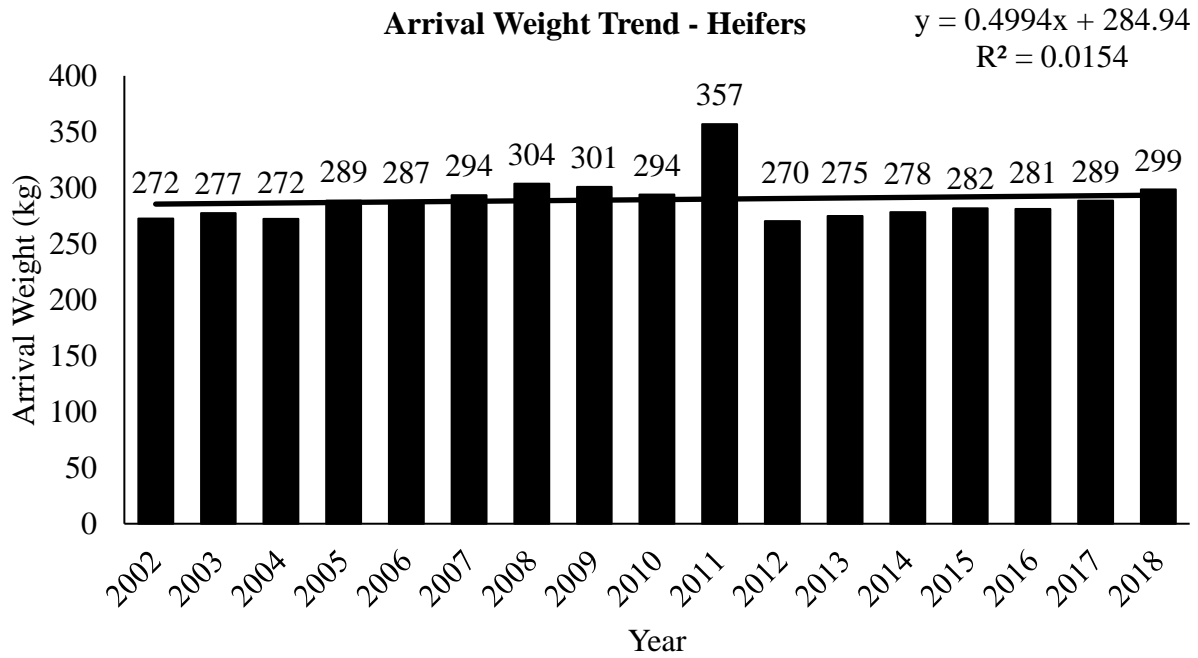
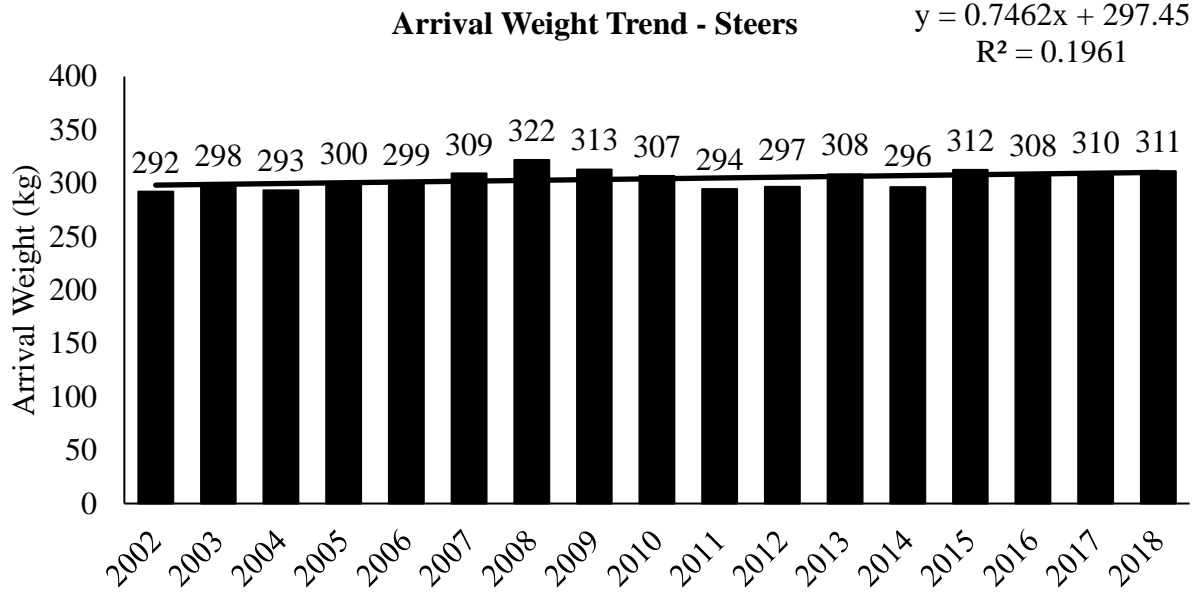

Figure 2.2 - Average daily gain trend for steers and heifers finished through the Tri-County Steer Carcass Futurity Cooperative from 2002 through 2018

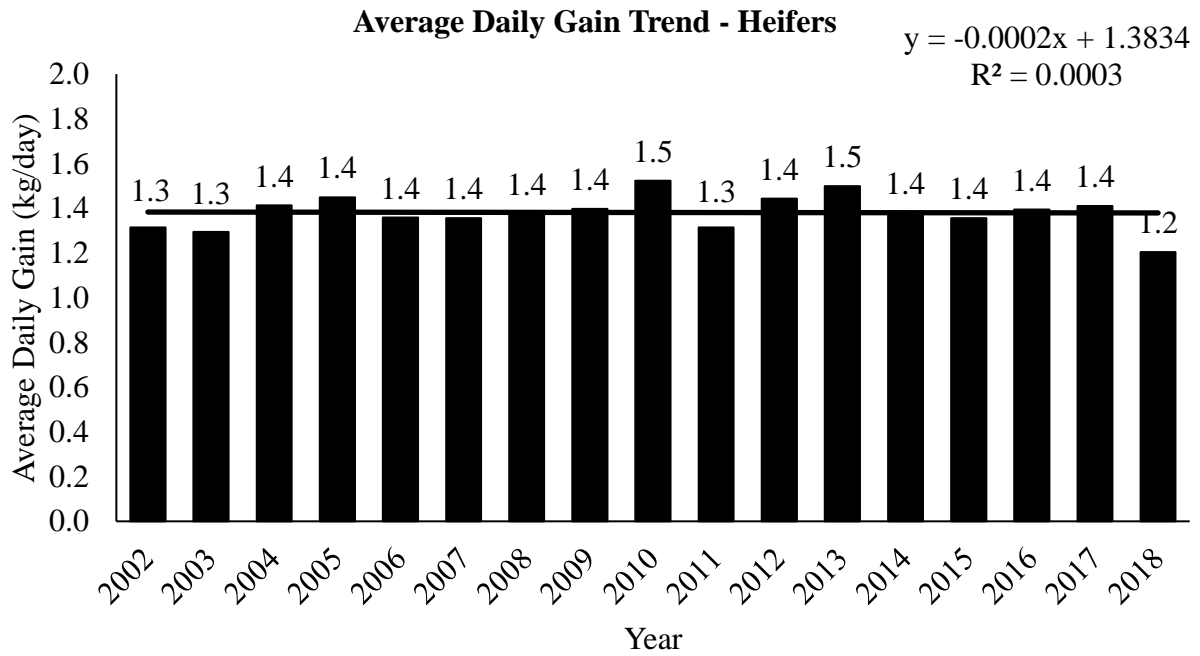
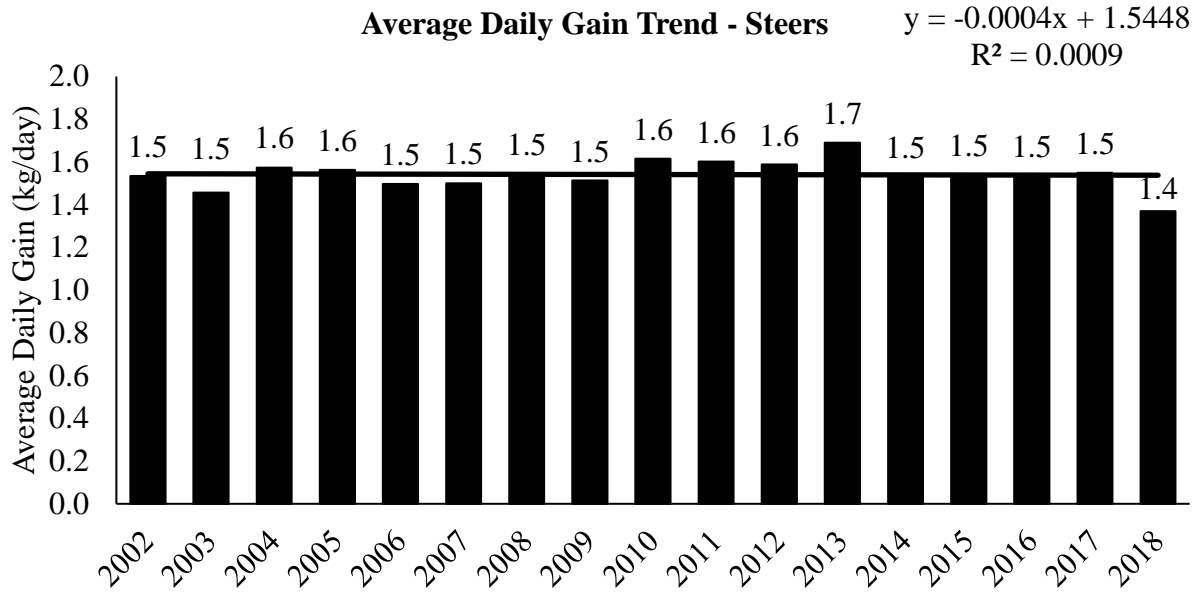

Figure 2.3 - Feed to gain trend for steers and heifers finished through the Tri-County Steer Carcass Futurity Cooperative from 2002 through 2018

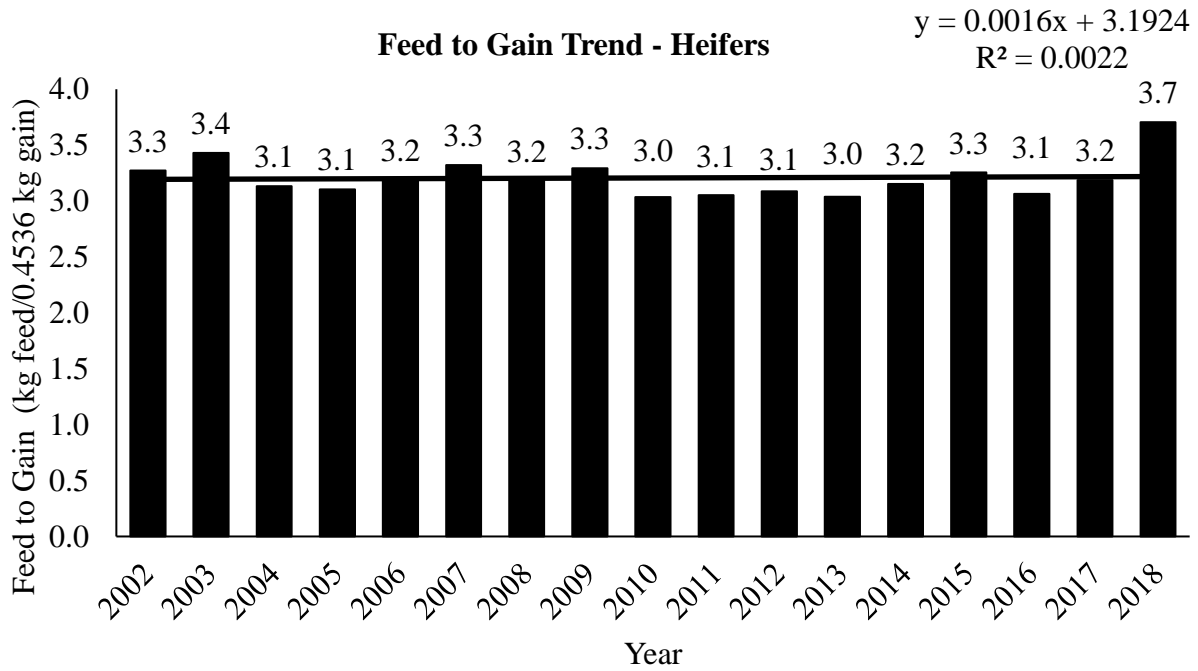
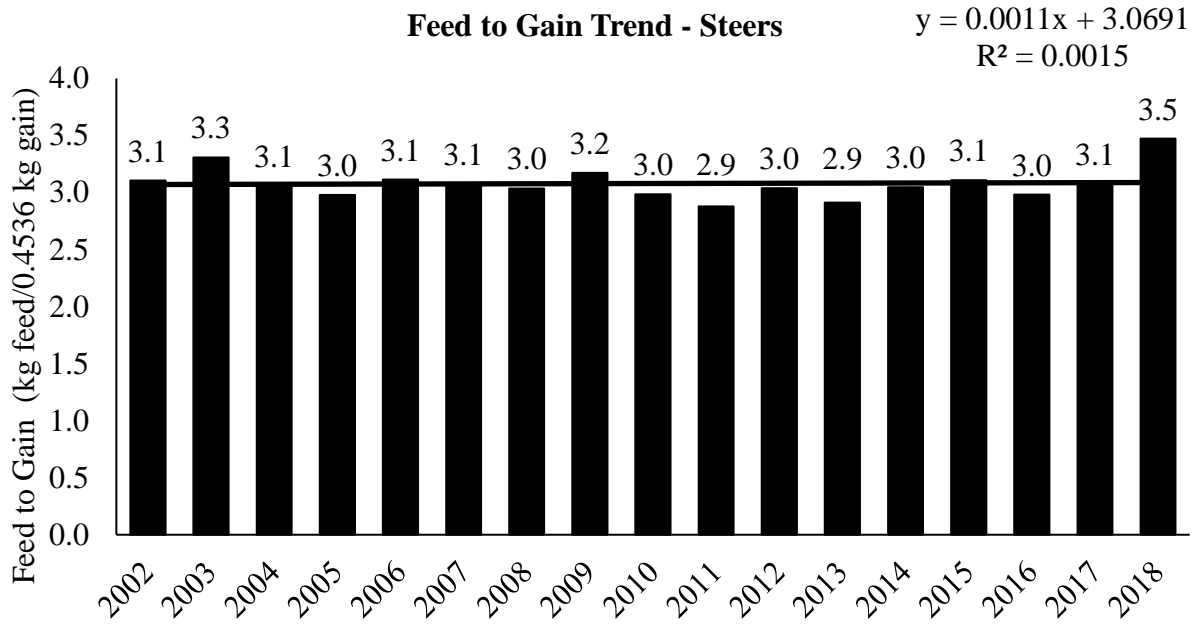

Figure 2.4 - Days on feed trend for steers and heifers finished through the Tri-County Steer Carcass Futurity Cooperative from 2002 through 2018

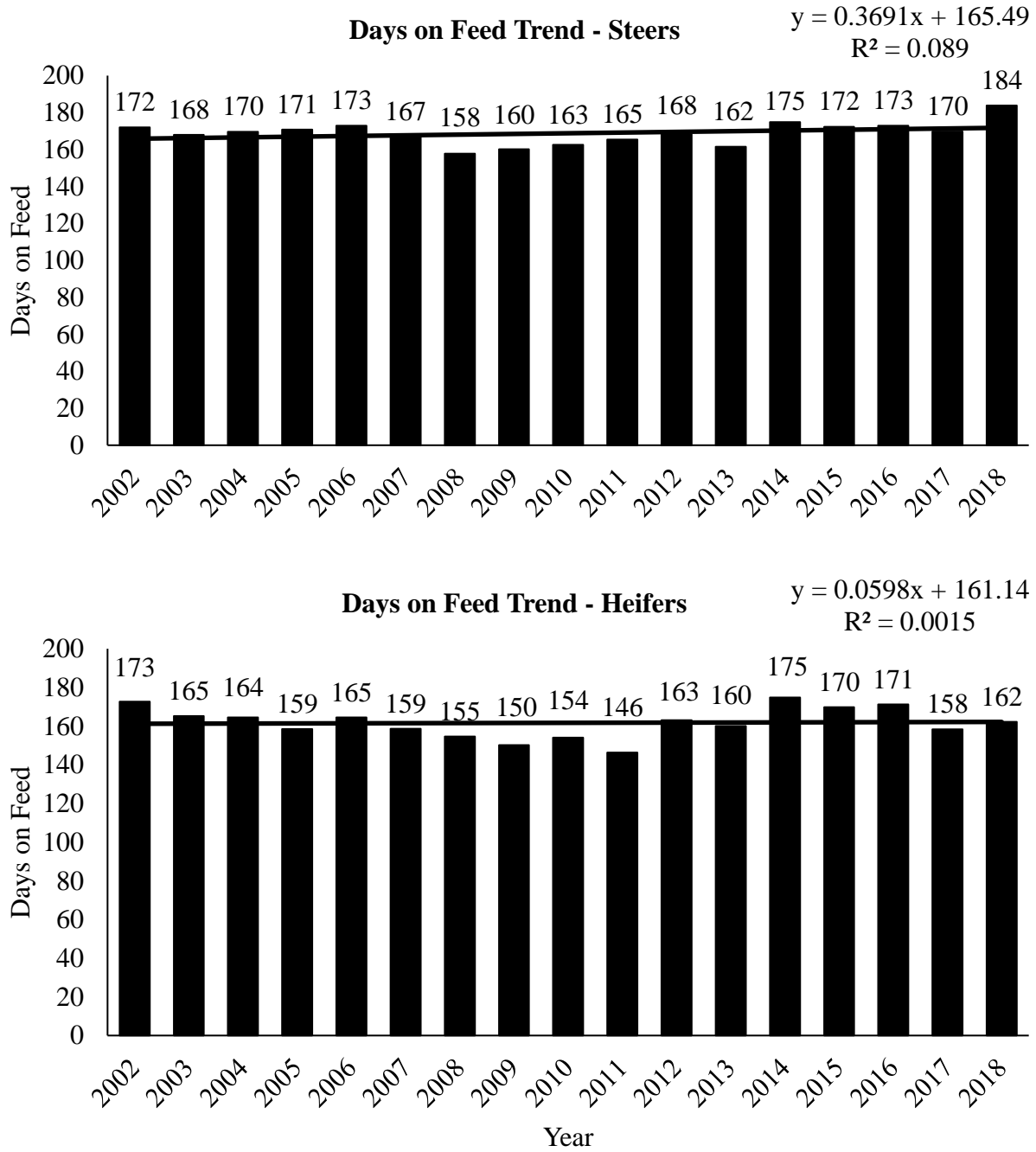

Figure 2.5 - Harvest weight trend for steers and heifers finished through the Tri-County Steer Carcass Futurity Cooperative from 2002 through 2018

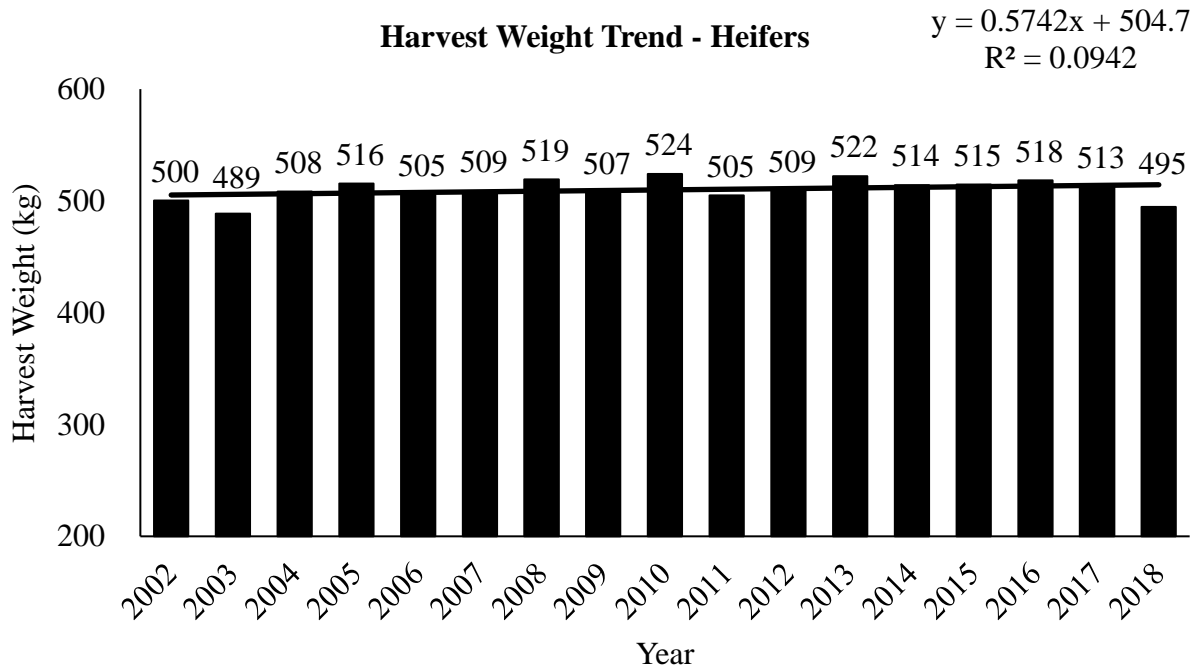
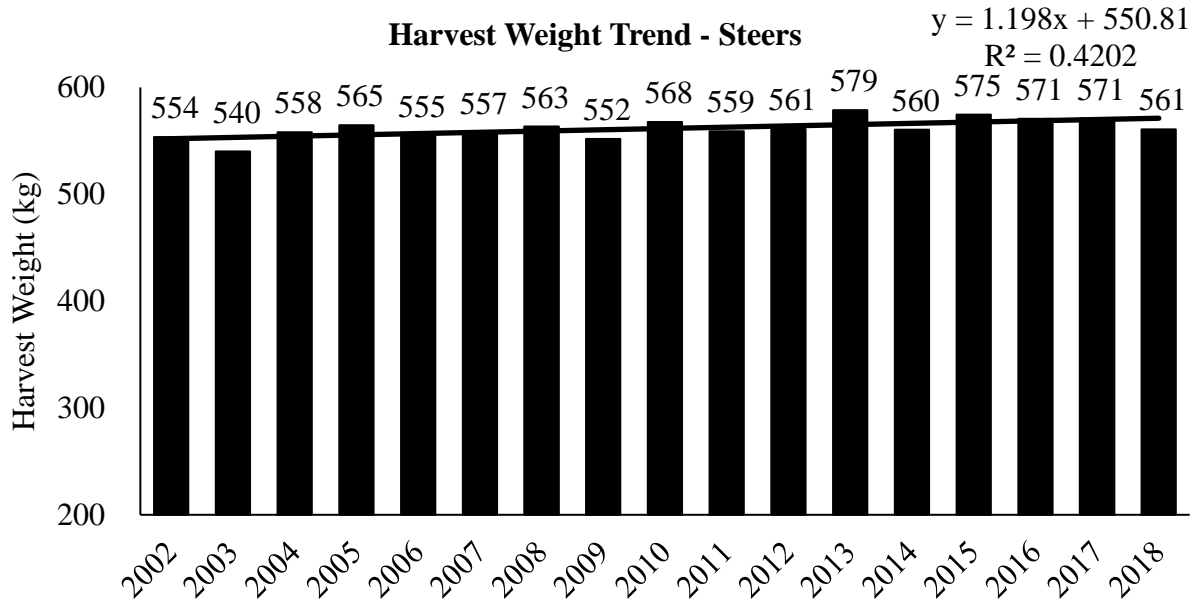
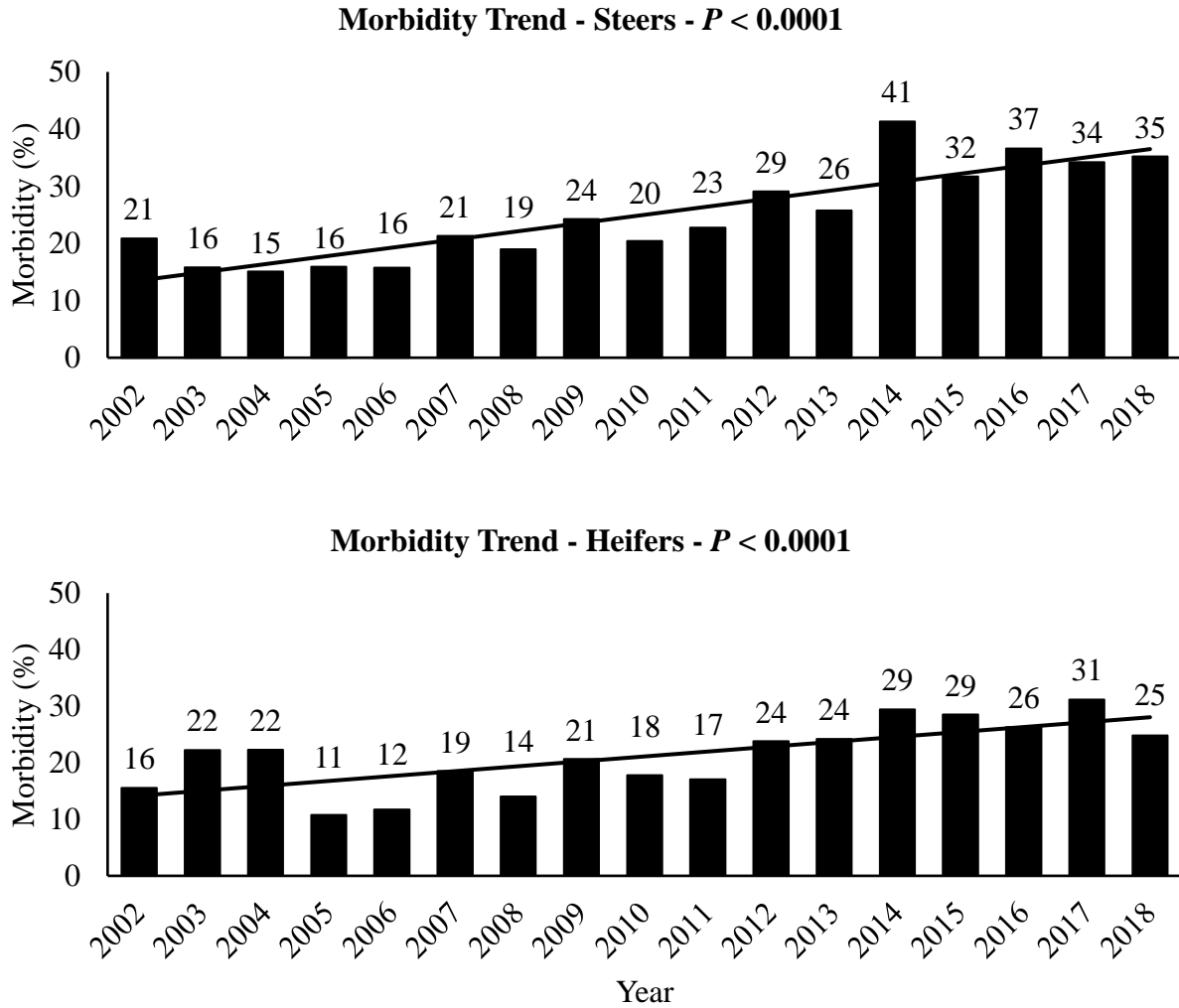
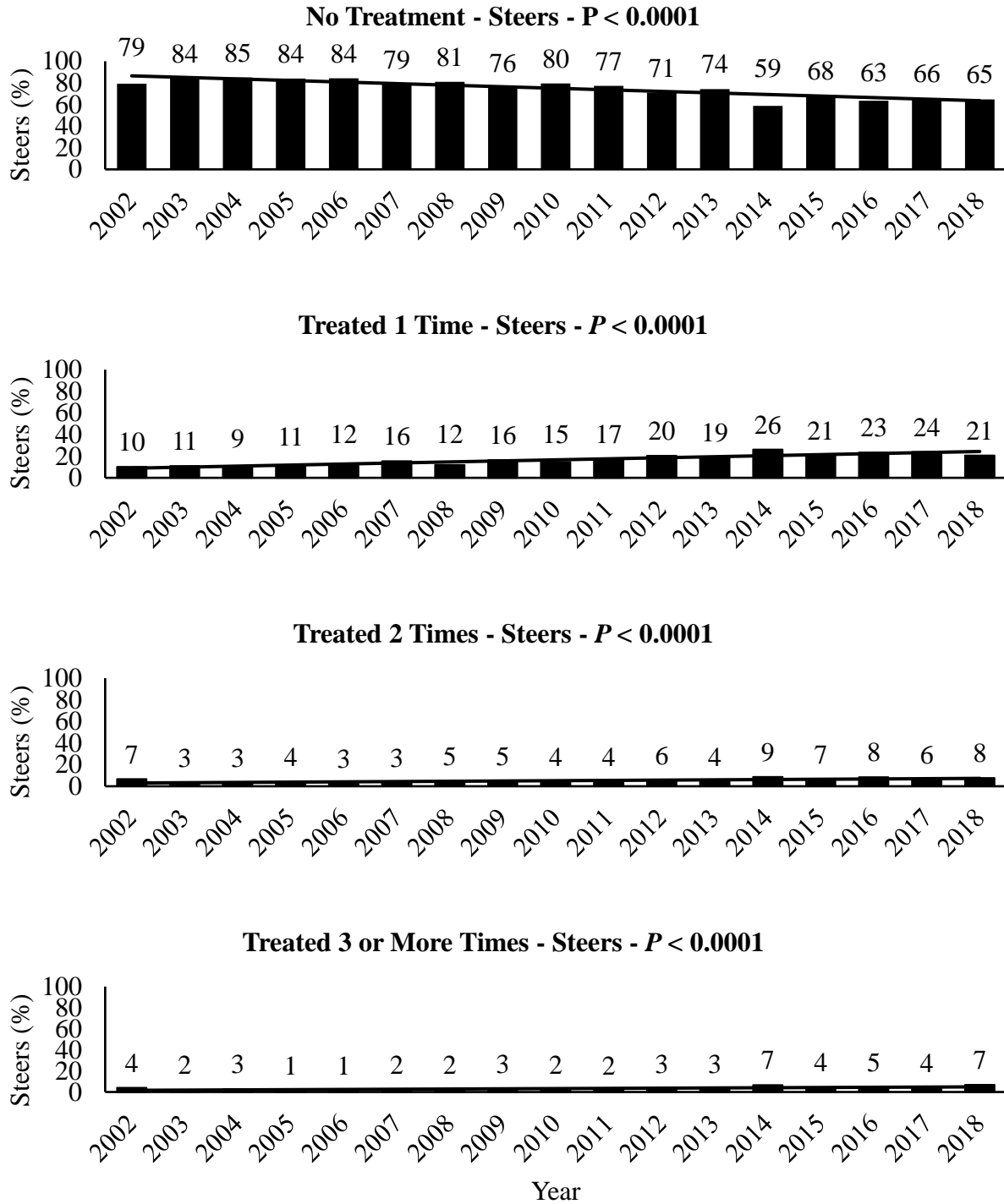

Figure 2.6 - Trend in morbidity risk for steers and heifers finished through Tri-County Steer Carcass Futurity Cooperative from 2002 through 2018



The P value represents an increasing or decreasing trend for steers or heifers.

Figure 2.7 - Trend in number of times treated for steers finished through Tri-County Steer Carcass Futurity Cooperative from 2002 through 2018



The P value represents an increasing or decreasing trend for steers.

Figure 2.8 - Trend in number of times treated for heifers finished through Tri-County Steer Carcass Futurity Cooperative from 2002 through 2018

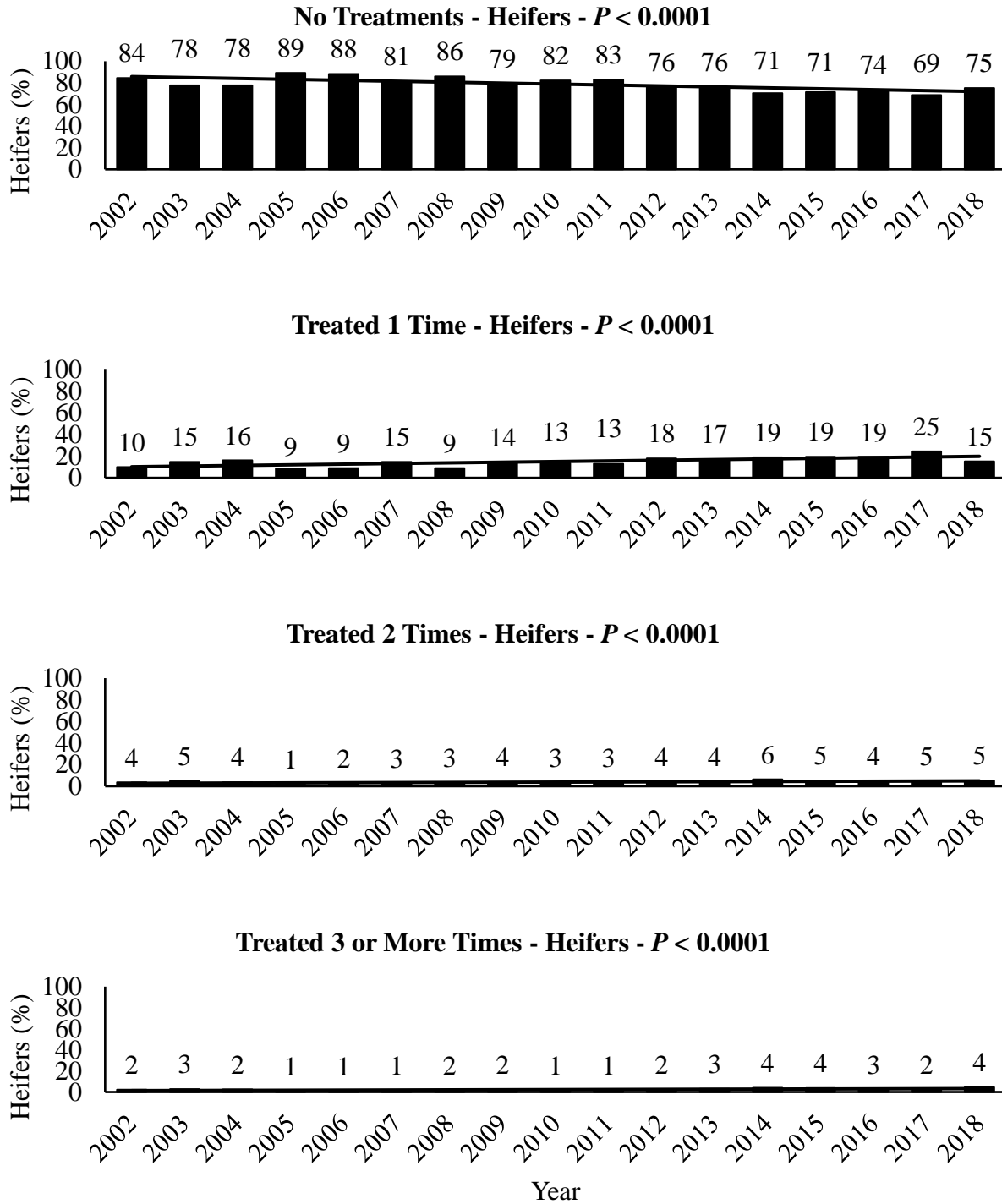

The P value represents an increasing or decreasing trend for heifers.

Figure 2.9 - Trend in mortality risk for steers and heifers finished through Tri-County Steer Carcass Futurity Cooperative from 2002 through 2018

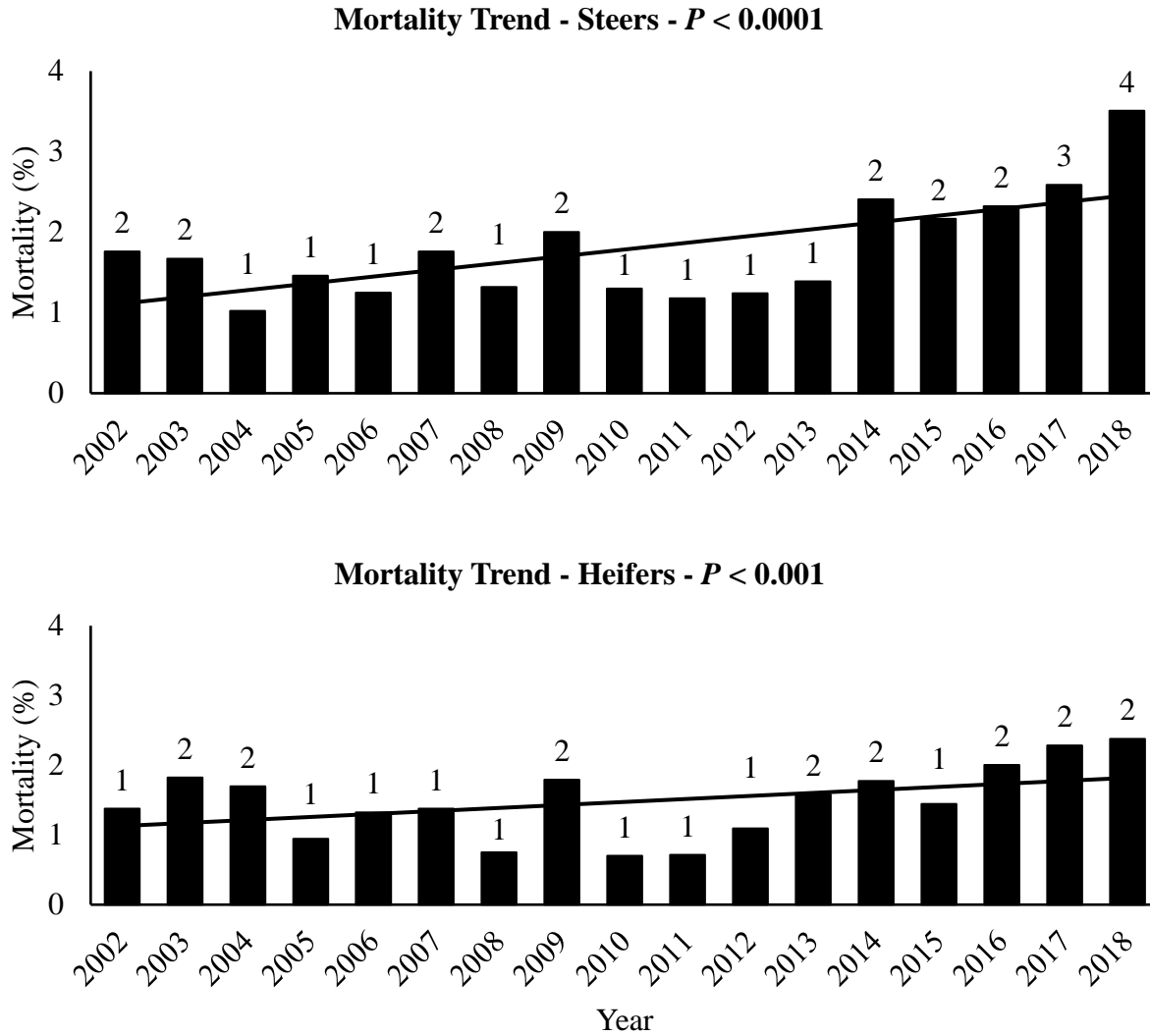

The P value represents an increasing or decreasing trend for steers or heifers.

Figure 2.10 - Hot carcass weight trend for steers and heifers finished through the Tri-County Steer Carcass Futurity Cooperative from 2002 through 2018

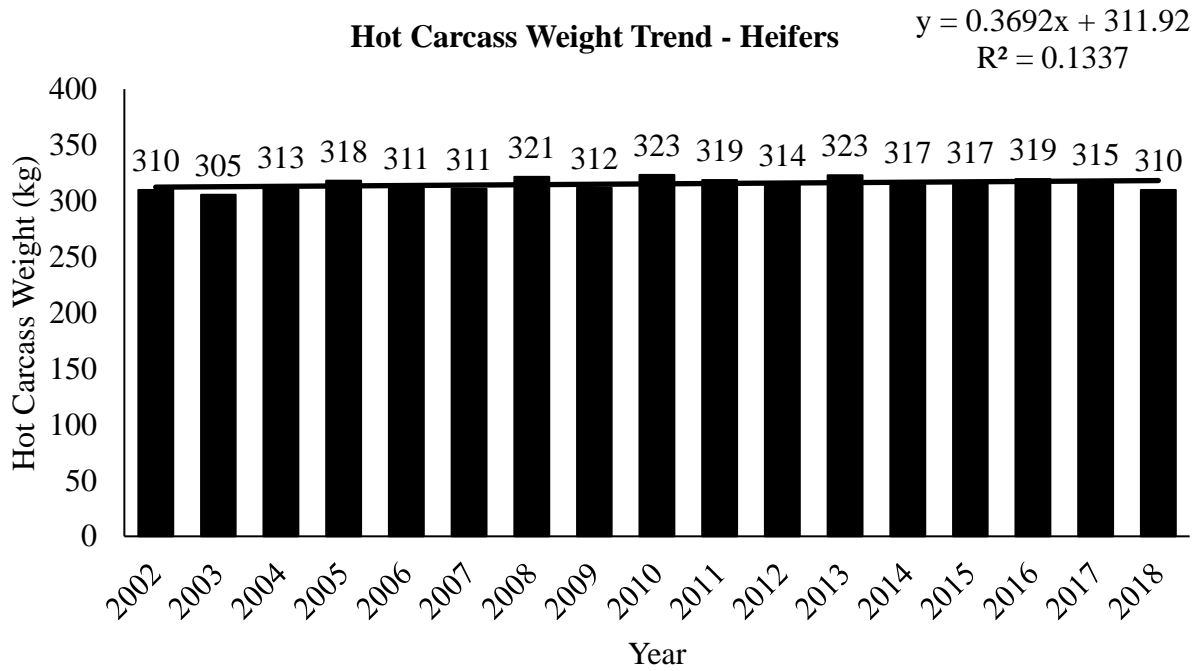
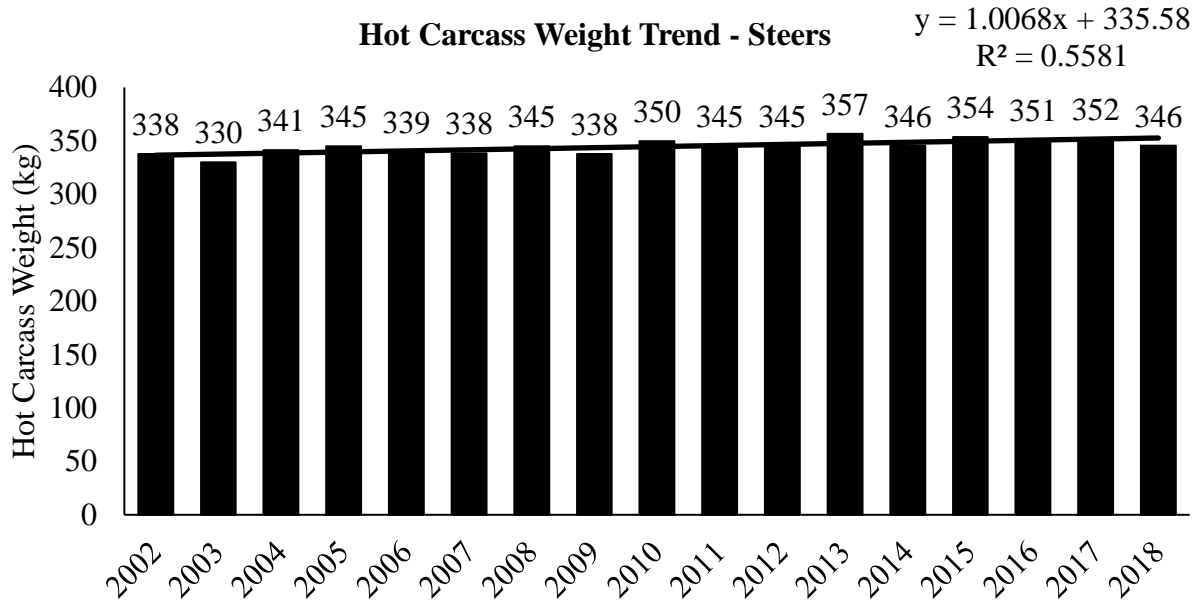

Figure 2.11 - Fat thickness trend for steers and heifers finished through the Tri-County Steer Carcass Futurity Cooperative from 2002 through 2018

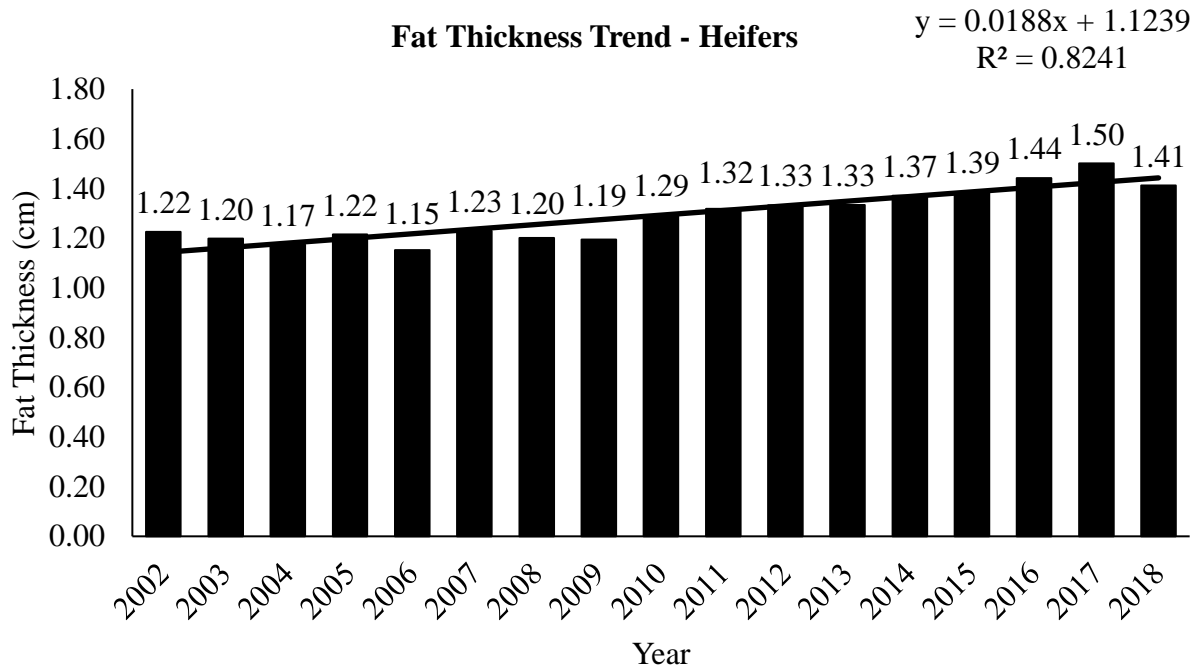
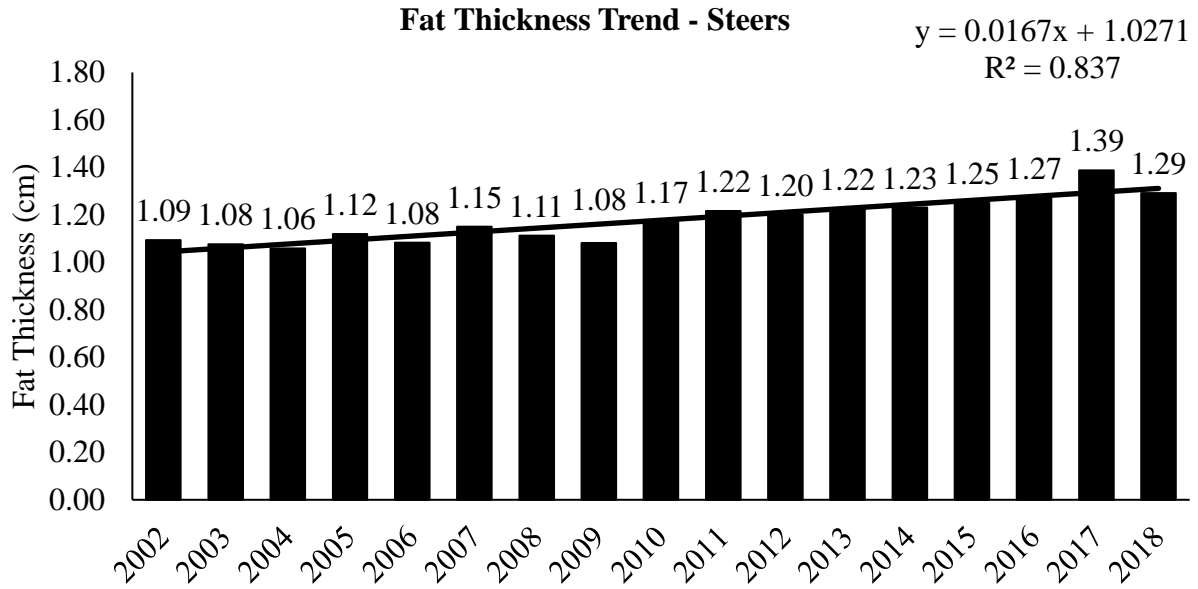

Figure 2.12 - Ribeye area trend for steers and heifers finished through the Tri-County Steer Carcass Futurity Cooperative from 2002 through 2018

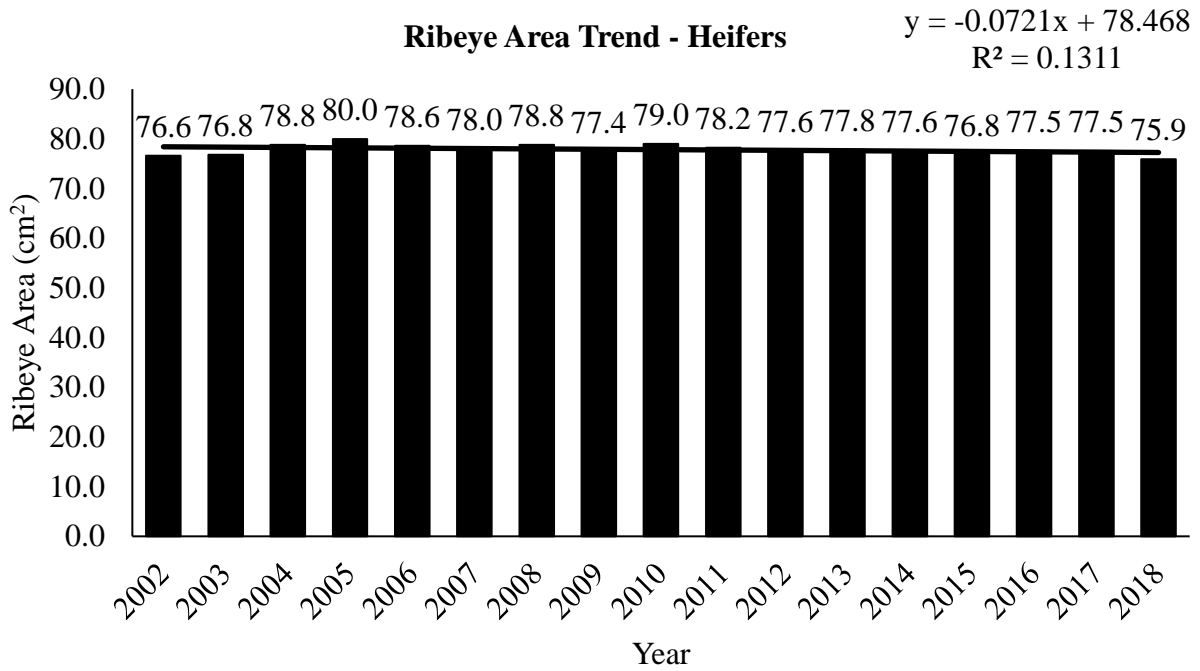
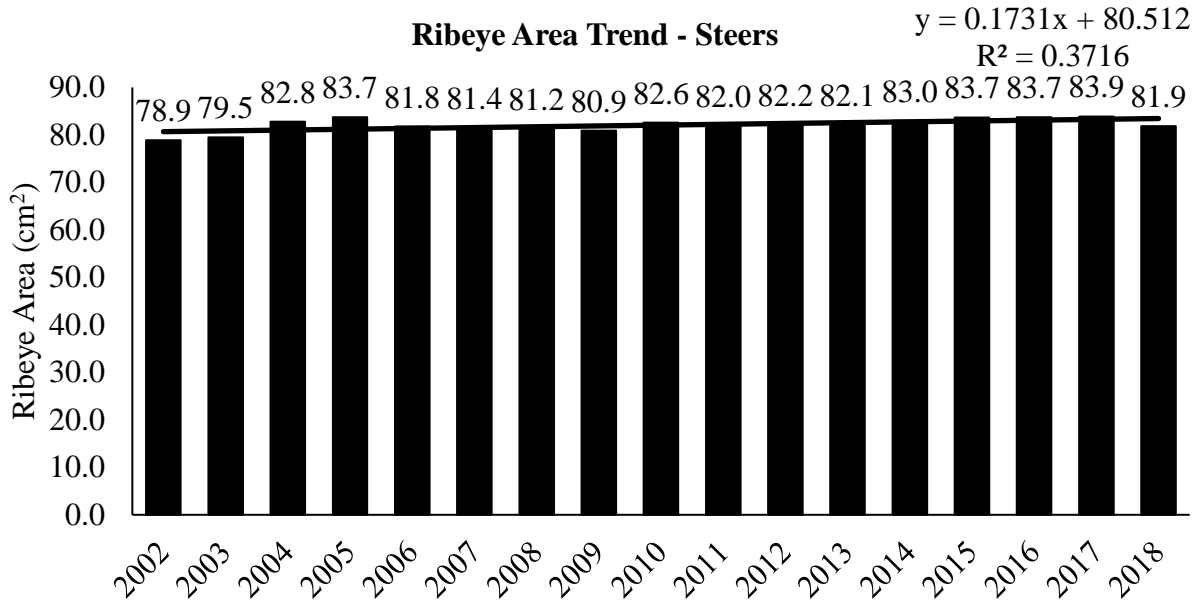

Figure 2.13 - Kidney, pelvic, heart fat percentage trend for steers and heifers finished through the Tri-County Steer Carcass Futurity Cooperative from 2002 through 2018

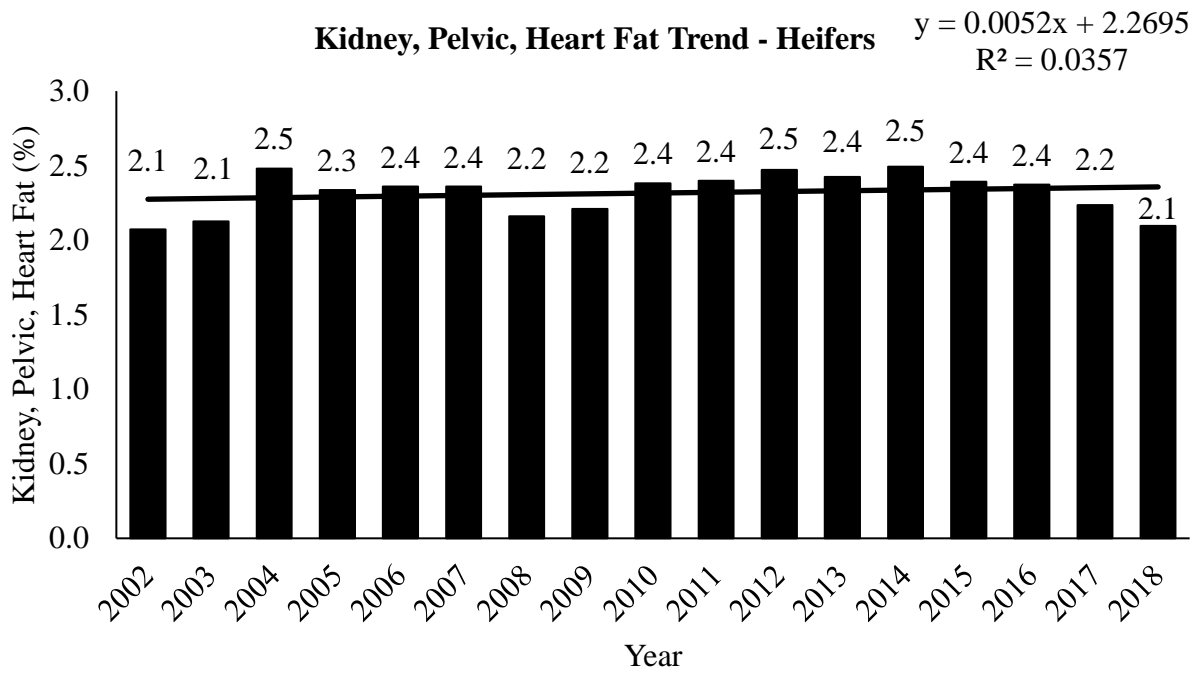
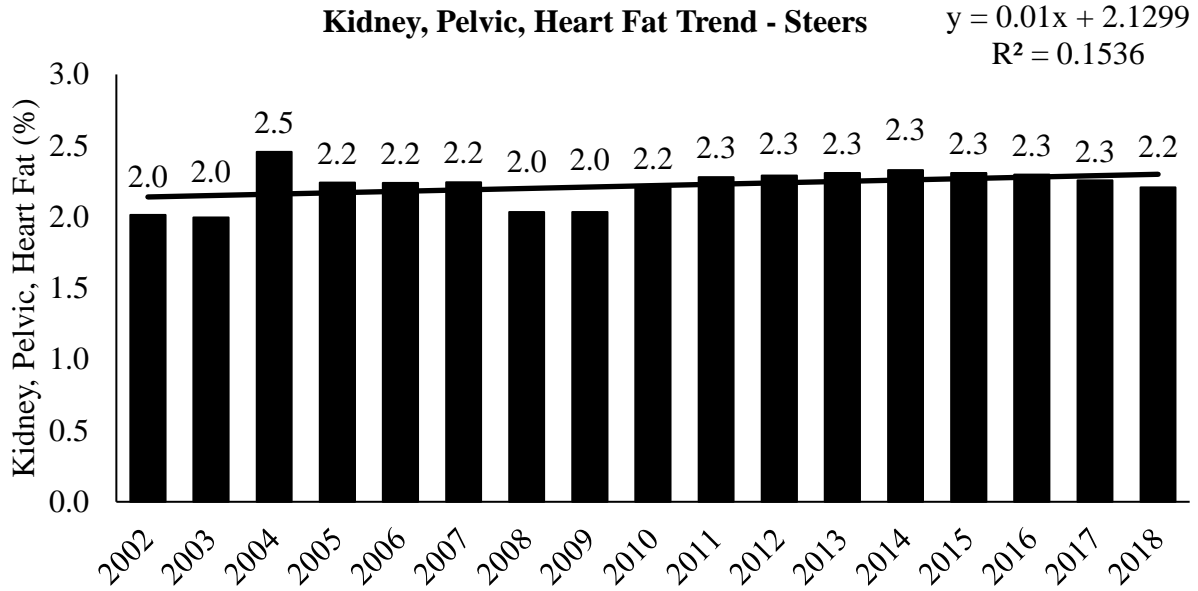

Figure 2.14 - Dressing percentage trend for steers and heifers finished through the Tri-County Steer Carcass Futurity Cooperative from 2002 through 2018

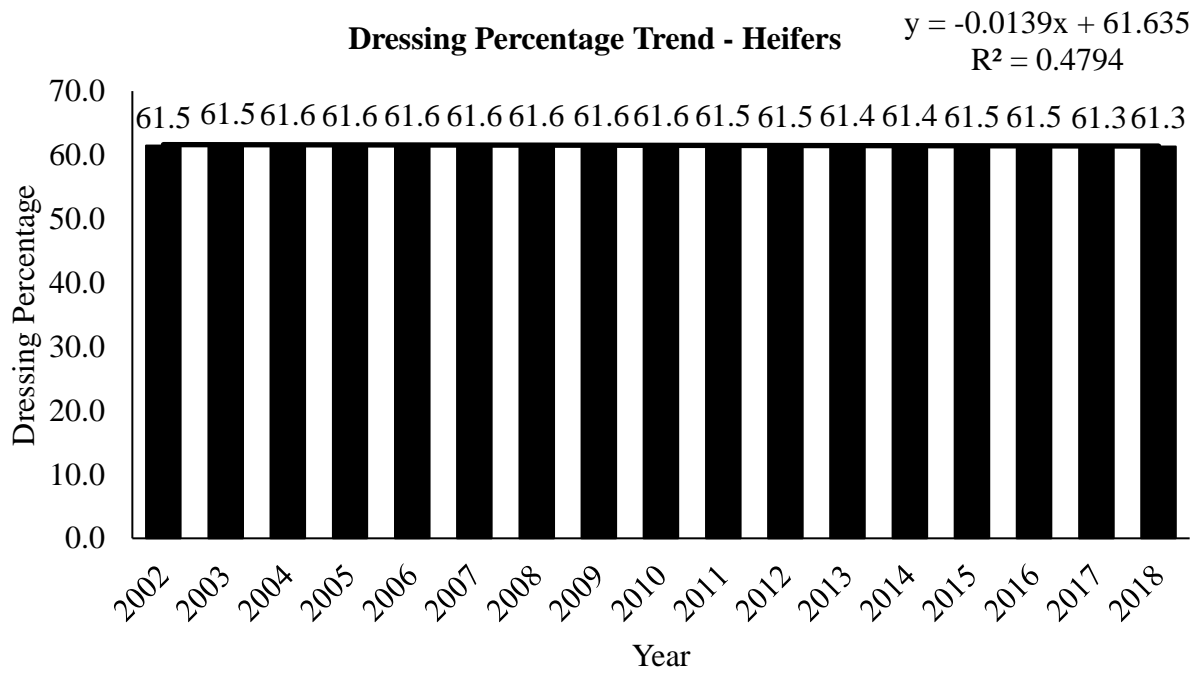
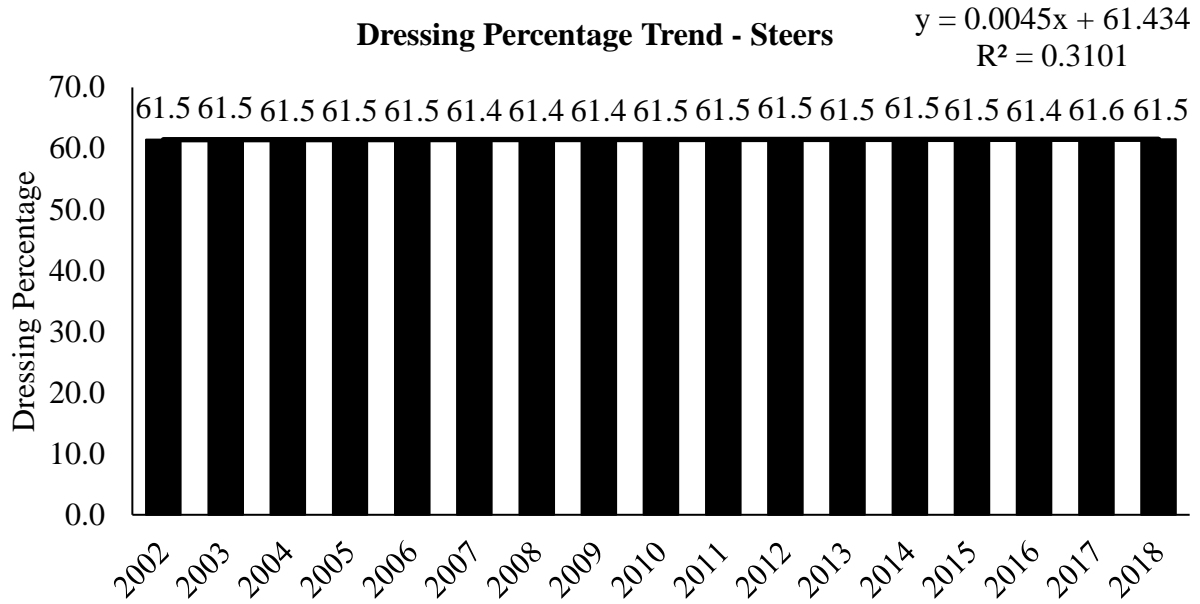
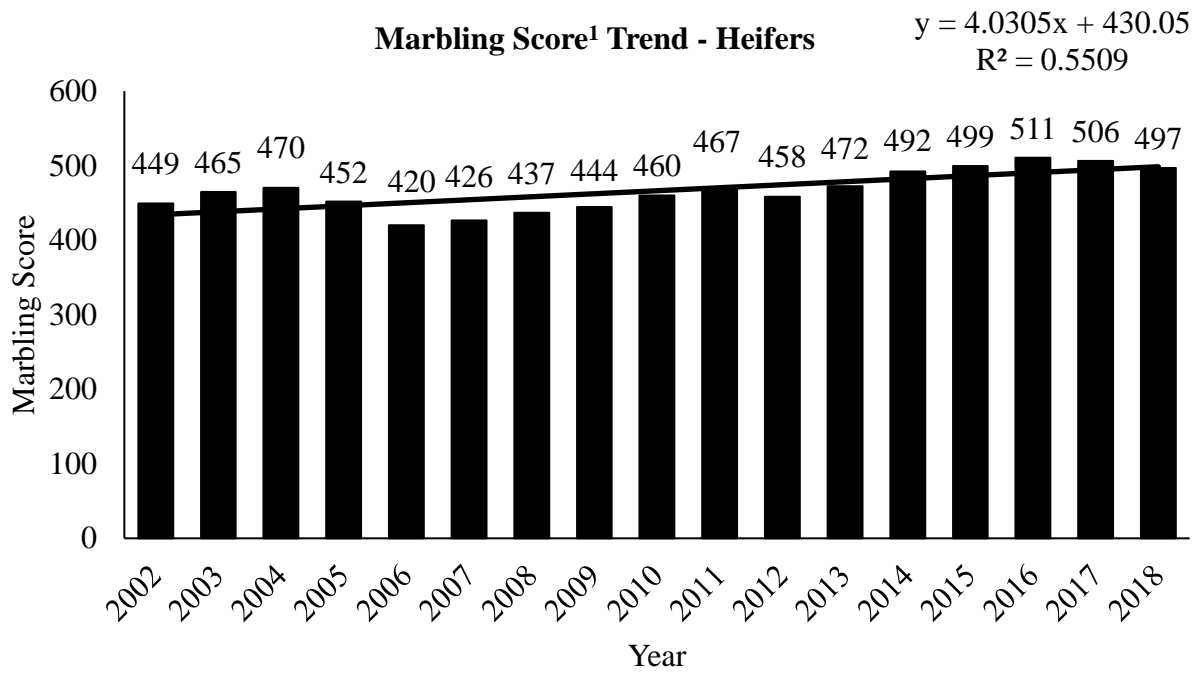
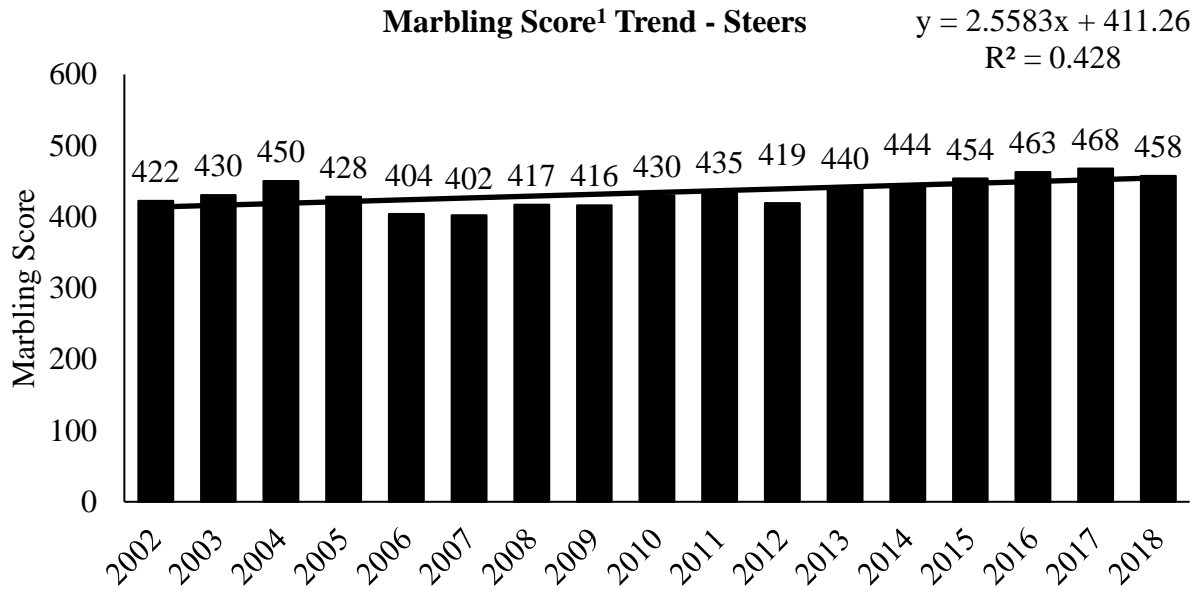

Figure 2.15 - Marbling score¹ trend for steers and heifers finished through the Tri-County Steer Carcass Futurity Cooperative from 2002 through 2018



¹100 = Practically devoid⁰⁰; 300 = Slight⁰⁰; 400 = Small⁰⁰; 500 = Modest⁰⁰; 700 = Slightly Abundant⁰⁰; 900 = Abundant⁰⁰

Figure 2.16 - Calculated yield grade trend for steers and heifers finished through the Tri-County Steer Carcass Futurity Cooperative from 2002 through 2018

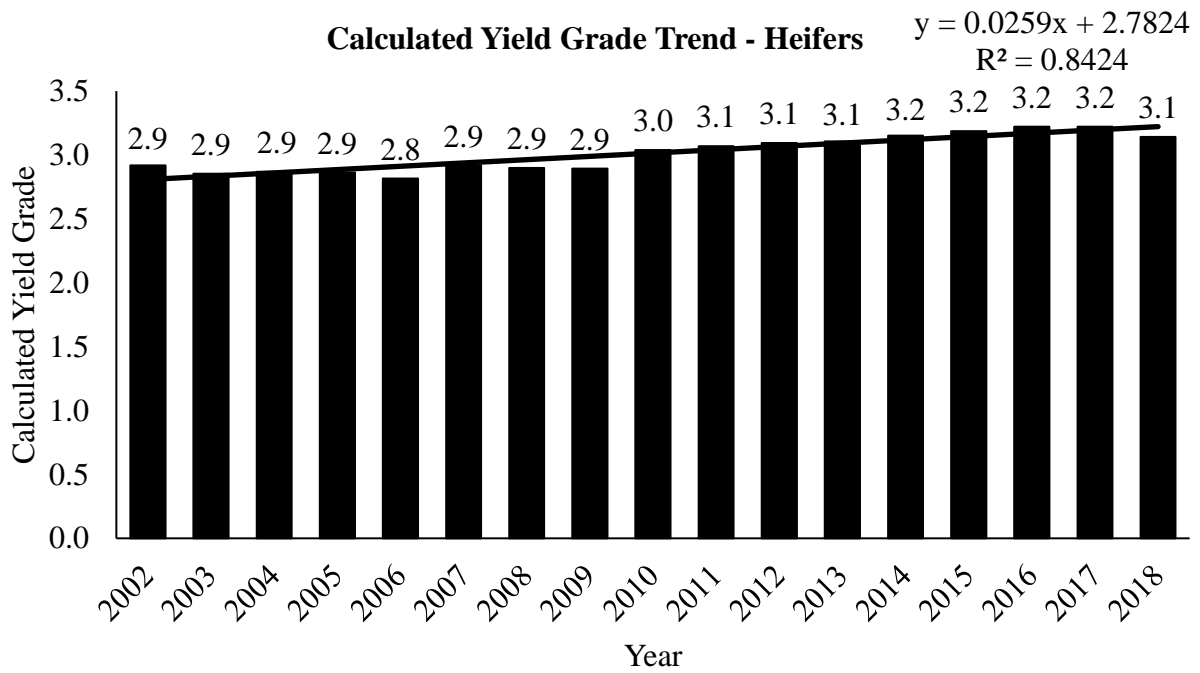
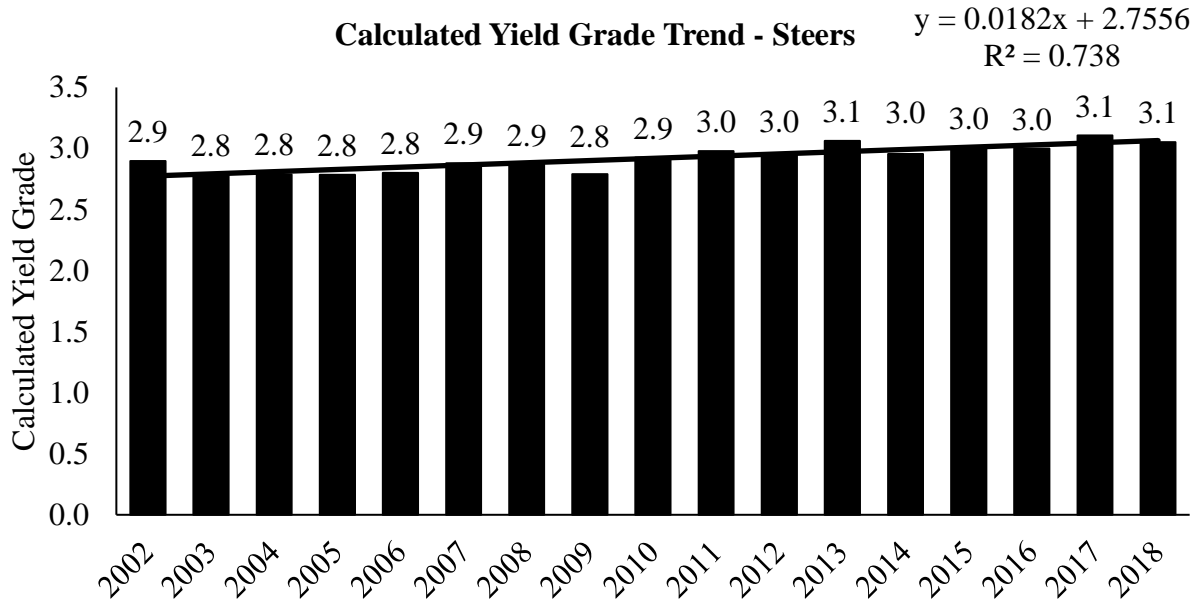
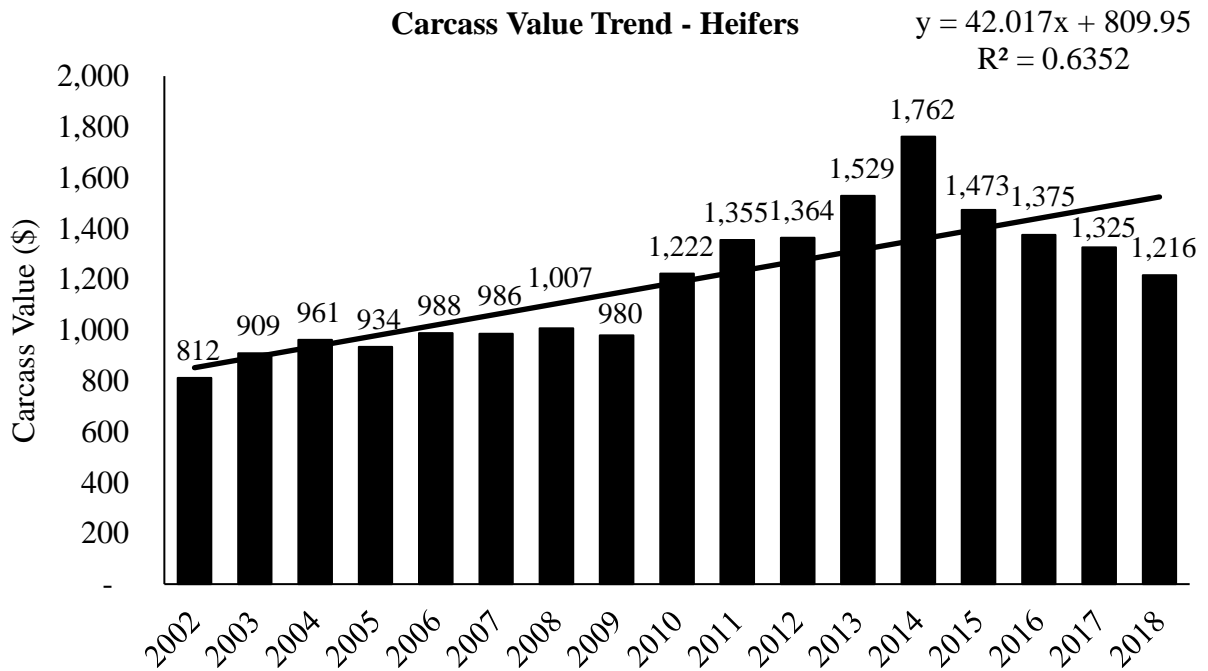
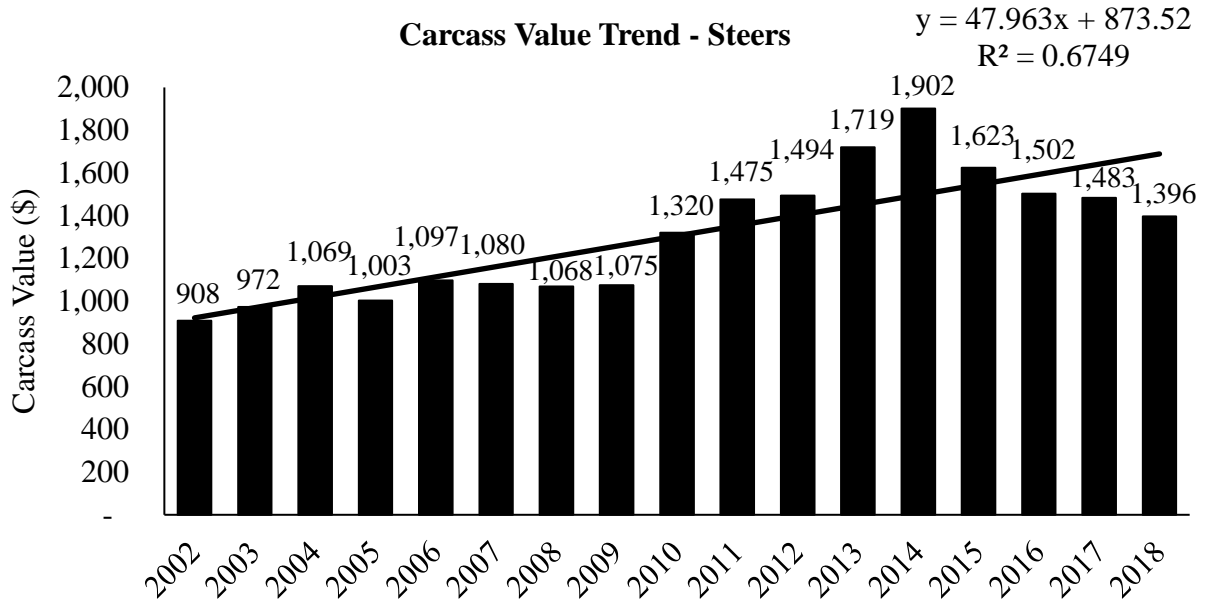

Figure 2.17 - Carcass value trend for steers and heifers finished through the Tri-County Steer Carcass Futurity Cooperative from 2002 through 2018



**Chapter 3 - Effect of sire breed on performance, health, and carcass
traits for steers and heifers finished through Tri-County Steer
Carcass Futurity Cooperative from 2002 through 2018**

E. D. McCabe*, M. E. King*, M. Groves[†], J. Waggoner*, K. E. Fike*, and K. G. Odde*

*Department of Animal Sciences and Industry, Kansas State University, Manhattan, KS, 66506;

[†]Tri-County Steer Carcass Futurity Cooperative, Lewis, IA, 51544

Abstract

The objective was to evaluate the effect of sire breed, year group, and sex on performance, health, and carcass traits for steers and heifers finished through the Tri-County Steer Carcass Futurity Cooperative. Information describing factors about steers and heifers finished through Tri-County Steer Carcass Futurity Cooperative (Lewis, IA) were collected for steers and heifers fed at 23 Iowa feedlots from 2002 through 2018. Sire-breeds with at least 50 head each year were included in the analyses. This included Angus-sired, Red Angus-sired, Hereford-sired, Charolais-sired, and Simmental-sired cattle. A multiple regression model was developed using a backwards selection procedure to quantify the effects of sire breed, sex, and year group on the outcomes of interest. Odds ratios were calculated for morbidity and mortality. Sire-breed, sex, and year group affected arrival weight, average daily gain, harvest weight, days on feed, feed to gain, feed cost, feed consumed, hot carcass weight, dressing percentage, fat thickness, ribeye area, calculated yield grade, and overall carcass value. Sire-breed, sex, and year group were significant in the odds ratio for morbidity. Sire-breed was not significant for mortality odds. This analysis did not include the cause or timing within the feeding period for morbidity or mortality, only if an event occurred. Producers should consider their operational goals and select the sire breed(s) that best meet their needs and the needs of their customers.

Introduction

There are numerous factors that impact the bottom line for cattle production. Many of these factors are influenced by other factors for a feedlot animal. While some factors can be more easily managed than others, there are a variety of factors that affect performance, health, and carcass traits. Many of these factors have been researched previously.

Breed composition affects animal feedlot performance and carcass traits (DeRouen et al., 2000; Reinhardt et al., 2009; Trejo et al., 2010; Parish et al., 2014). British breeds are typically smaller framed, mature at a younger age, have higher quality grades, and lower cutability carcasses compared with Continental breeds. Continental breeds were imported to the United States in the 1960's and 1970's to improve growth rate and create leaner cattle (Minish and Fox, 1979).

The most common cause of morbidity and mortality in feedlot cattle in the United States is bovine respiratory disease (Loneragan et al., 2001; Brooks et al., 2011; USDA, NAHMS, 2013b). There is little evidence for differences among breeds for bovine respiratory disease, but Hereford cattle were generally more susceptible (Snowder et al., 2006).

The structure of the current United States commercial beef industry limits the amount of traceable data for an individual beef animal. An animal born on a cow-calf operation may change ownership three (i.e. cow-calf, backgrounder, feedlot) times prior to harvest, which makes retaining lifetime records on an animal difficult. The Tri-County Steer Carcass Futurity Cooperative provided data containing performance, health, and carcass traits for individual cattle finished from 2002 through 2018. This dataset provides the opportunity to evaluate a variety of relationships among traits of feedlot cattle. The objective was to evaluate the effect of sire breed, year group, and sex on performance, health, and carcass traits for steers and heifers finished through the Tri-County Steer Carcass Futurity Cooperative.

Materials and Methods

Data Collection

Approval for this research by an Institutional Animal Care and Use Committee was not needed given the nature of the records and data used for analyses.

Information describing factors about steers and heifers finished through Tri-County Steer Carcass Futurity Cooperative (Lewis, IA) was obtained in an electronic format. These data were collected for steers and heifers fed at 23 Iowa feedlots from 2002 through 2018. Not all feedlots participated all years. Detailed requirements for the program were available at www.tscsf.com.

The health protocol was listed at www.tscsf.com. Calves enrolled in the program were to be weaned at least 30 days prior to delivery. Bulls were castrated prior to arrival and was suggested to be performed prior to weaning. Calves needed to be treated for internal and external parasites. Horns were removed prior to arrival and was suggested to be performed prior to weaning. All cattle were to receive two doses of modified live viral vaccine, preferably preweaning and at weaning, respectively. Cattle were required to receive two doses of a 7-way blackleg prior to arrival. Tri-County Steer Carcass Futurity Cooperative encouraged consignors to work with their veterinarian to develop a complete herd health program.

The Tri-County Steer Carcass Futurity Cooperative primary objective was to provide producers participating in the program with performance and carcass data on enrolled steers and heifers. Steers and heifers fed through the Tri-County Steer Carcass Futurity Cooperative were typically spring-born calves. The majority of calves in the program were delivered to the feedlot in Iowa during September, October, November, or December (10, 21, 22, and 13%, respectively). Steers or heifers weighing greater than 453.1 kg upon arrival were removed from analysis. From 2002 through 2018, on average, 6,599 steers or heifers were enrolled in the program annually. Steers comprised 69% and heifers 31% of animals enrolled in the program during this time. A modest implant program was used in these steers and heifers. All feedlots participating in the program were fed a common dietary energy level. A warm-up ration was fed for 28 days prior to starting test (Tri-County Steer Carcass Futurity Cooperative, 2020).

Pens of steers and (or) heifers were harvested on at least two different dates approximately five weeks apart based on visual appraisal determined by the Tri-County Steer Carcass Futurity Board. These cattle were primarily harvested during the months of March, April, May, or June (10, 23, 21, and 11%, respectively) and marketed on a grid. Steers and heifers were weighed at least four times including arrival weight, start of test, time of re-implant, and prior to harvest. Carcass data were collected at time of slaughter. Cattle were harvested in Denison, IA from 2002 through 2014, and in Dakota City, NE from 2015 through 2018. Instrument grading was used for carcass trait measurement starting in 2015.

Sire-breeds of steers and heifers were provided by the consignor to the feedlot. Sire-breeds of steers and heifers with more than 50 head each year were included in the analysis. The sire-breeds included in this analysis were Angus, Charolais, Hereford, Red Angus, and Simmental. There were 51,938 total head (37,993 steers and 13,945 heifers) included in analyses of performance traits, feed variables, and carcass traits. Any animals with missing data for performance or carcass traits were removed from this study. Information included in these analyses about individual animals were sire breed, year group, sex, arrival weight, average daily gain, occurrence of morbidity or mortality, harvest weight, days on feed, feed:gain, feed cost, total feed consumed, hot carcass weight, dressing percent, fat thickness, ribeye area, calculated yield grade, marbling score, and carcass value.

In order to account for year variation, years were combined into five groups. These year groups included: 1) 2002 – 2005, 2) 2006 – 2009, 3) 2010 – 2012, 4) 2013 - 2015, and 5) 2016 – 2018. The first two year-groups each include four years, the last three year-groups include three years each. In each year grouping, the percentage of cattle with a sire breed provided by the consignor decreased. From 2002 to 2005, 84% of cattle had a sire breed reported. From 2016 to

2018, 45% of cattle had a sire breed reported. It is unknown why there were fewer sire breeds reported in the later years of the data.

Average daily gain was calculated by subtracting arrival weight from harvest weight and dividing by days on feed. Feed:gain ratio was calculated by dividing total kilograms of feed fed by total kilogram of weight gain over the feeding period. Feed cost was calculated by the total feed cost divided by total pounds of dry matter multiplied by total feed consumed. Total Feed Consumed was calculated by total kg of feed consumed on a DM basis using the Cornell Net Carbohydrate and Protein System Model (Cornell University, 2020). Individual feed intake within a pen is determined using the Cornell Net Carbohydrate and Protein Model (Groves, 2020). The Cornell Net Carbohydrate and Protein Model is well described in literature and periodically updated to improve accuracy and software (Cornell University, 2020). “The Cornell Net Carbohydrate and Protein System was developed to predict requirements, feed utilization, animal performance and nutrient excretion for dairy and beef cattle using accumulated knowledge about feed composition, digestion, and metabolism in supplying nutrients to meet requirements” (Cornell University, 2020). Carcass value (total dollar value for carcass) was calculated by multiplying the adjusted base carcass weight per 45.36kg by hot carcass weight then divided by 100.

Data analyzed for health traits were collected from 2002 through 2018. There were 56,320 total head (40,883 steers and 15,437 heifers) included in the morbidity and mortality analyses. Employees that evaluated health were trained by Iowa State University veterinarians (Reinhardt et al., 2009). Morbidity incidence data was considered binomial and an animal was considered morbid with at least one morbidity event at some point throughout the feeding period. Mortality incidence was considered as binomial data and an animal that died at any point in the feeding period had a mortality incidence.

Statistical Analysis

A multiple regression model was developed using a backwards selection procedure to quantify the fixed effects of sire breed, sex, and year group on various outcomes including arrival weight, average daily gain, morbidity risk, mortality risk, harvest weight, days on feed, feed to gain, feed cost, total feed consumed, hot carcass weight, dressing percent, fat thickness, ribeye area, calculated yield grade, marbling score, and carcass value. The MIXED procedure of SAS (version 9.4, SAS Institute Inc., Cary, NC) was used for the analyses (SAS, 2020b). A value of $P < 0.05$ was required for a fixed effect to remain in the model.

Odds ratios were calculated using the GENMOD procedure of SAS (version 9.4, SAS Institute Inc., Cary, NC) (SAS, 2020a). Estimates and confidence limits results were converted to odds ratios by taking the exponent of the values.

Results and Discussion

Data analyzed for performance traits, feed variables, and carcass traits were collected from 2002 through 2018. Unadjusted means, standard deviations, median, and range values for continuous variables describing steers (Table 3.1) and heifers (Table 3.2) finished from 2002 through 2018 were summarized.

Data analyzed for health traits were collected from 2002 through 2018. The overall morbidity risk was 22.9% (12,879/56,320). The overall mortality risk was 1.6% (903/56,320).

Performance Traits

Arrival Weight

Sire-breed ($P < 0.0001$), sex ($P < 0.0001$), and year-group ($P < 0.0001$) affected arrival weight of feedlot cattle (Table 3.3). Red Angus-sired cattle were the lightest ($P < 0.05$) weight at

arrival (282.7 kg of BW). Angus-sired cattle had the second lightest ($P < 0.05$) arrival weight at 294.6 kg of BW. The heaviest ($P < 0.05$) arrival weights were Charolais-sired (300.3 kg of BW), Hereford-sired (299.9 kg of BW), and Simmental-sired (297.5 kg of BW). Heifers were lighter ($P < 0.05$) weight than steers at arrival (286.7 kg of BW and 303.3 kg of BW, respectively). Arrival weight was the lightest ($P < 0.05$) in year-group 2002 to 2005 (283.8 kg of BW) compared with other year-groups. Arrival weights were the heaviest ($P < 0.05$) in year-group 2016 to 2018 at 303.8 kg of BW.

Average Daily Gain

Sire-breed ($P < 0.0001$), sex ($P < 0.0001$), and year-group ($P < 0.0001$) affected average daily gain of feedlot cattle (Table 3.3). Angus-sired cattle had the greatest ($P < 0.05$) average daily gain compared with all other sire breeds at 1.49 kg/day. Simmental-sired (1.46 kg/day) and Red Angus-sired (1.45 kg/day) cattle had similar ($P > 0.05$) and the second greatest ($P < 0.05$) average daily gain. Red Angus-sired cattle also had a similar ($P > 0.05$) average daily gain to Hereford-sired cattle (1.44 kg/day). Charolais-sired cattle had the lowest ($P < 0.05$) average daily gain at 1.39 kg/day. Heifers had a lower ($P < 0.05$) average daily gain than steers (1.37 kg/day and 1.52 kg/day, respectively). Year-group 2010 to 2012 had the greatest ($P < 0.05$) average daily gain compared with all other year-groups (1.51 kg/day). The lowest ($P < 0.05$) average daily gain was in year-group 2016 to 2018 (1.38 kg/day).

Harvest Weight

Sire-breed ($P < 0.0001$), sex ($P < 0.0001$), and year-group ($P < 0.0001$) affected harvest weight for feedlot cattle (Table 3.3). Red Angus-sired cattle had the lightest ($P < 0.05$) harvest weight compared with all other sire breeds at 526.0 kg of BW. Angus-sired (533.5 kg of BW) and Hereford-sired (532.4 kg of BW) cattle had similar ($P > 0.05$) harvest weights. Charolais-sired and

Simmental-sired cattle had similar ($P > 0.05$) and the heaviest ($P < 0.05$) harvest weight compared with all other sire breeds (541.8 kg of BW and 544.0 kg of BW, respectively). Steers had a heavier ($P < 0.05$) harvest weight than heifers (560.4 kg of BW and 510.7 kg of BW). Year-group 2002 to 2005 had the lightest ($P < 0.05$) harvest weight (528.2 kg of BW). The heaviest ($P < 0.05$) harvest weight was 2013 to 2015 (540.1 kg of BW).

DeRouen et al. (2000) mated four sire breeds to F₁ Brahman-Hereford dams and collected performance and carcass traits for the steers from these matings. Angus-sired and Gelbvieh-sired steers were 29 kg heavier ($P < 0.01$) than Brangus-sired and Gelbray-sired steers entering the feedlot (DeRouen et al., 2000). Angus-sired and Gelbvieh-sired steers were also heavier ($P < 0.01$) at harvest than the other sire breeds (DeRouen et al., 2000). Trejo et al. (2010), however, did not find differences in arrival weight, average daily gain, or final adjust body weight among Angus-sired, Simmental-sired, SimAngus-sired, or 75% Simmental-sired steers.

Sire-breed variations in performance parameters in our study showed British-sired (Angus, Red Angus, and Hereford) cattle were lighter weight at arrival and lighter weight at harvest than Continental-sired (Charolais and Simmental) cattle. While Charolais-sired cattle were among the heaviest at arrival and slaughter, they had the lowest average daily gain compared with all other sire breeds. Year-groups showed cattle were heavier at arrival in 2016 to 2018 than 2002 to 2005. Cattle were harvested at the lightest weight in 2002 to 2005 and heaviest harvest weight in 2013 to 2015. Industry trends have also shown an increase in harvest weight during this time (Waggoner, 2018; USDA, ERS, 2020).

Feed Variables

Days on Feed

Sire-breed ($P < 0.0001$), sex ($P < 0.0001$), and year-group ($P < 0.0001$) affected days on feed for feedlot cattle (Table 3.4). Angus-sired cattle were on feed the fewest ($P < 0.05$) days compared with all other sire breeds at 162.1 days. Hereford-sired cattle were on feed the second fewest ($P < 0.05$) days (164.2 days). Red Angus-sired and Simmental-sired cattle were on feed a similar ($P > 0.05$) number of days (169.2 days and 170.8 days, respectively). Charolais-sired cattle were on feed the most ($P < 0.05$) days compared with all other sire breeds (174.9 days). Steers were on feed more ($P < 0.05$) days than heifers (170.9 days and 165.6 days, respectively). The fewest ($P < 0.05$) days on feed was year-group 2010 to 2012 (161.4 days). Year-group 2006 to 2009 was the next fewest ($P < 0.05$) days on feed (165.0 days). The most ($P < 0.05$) days on feed were year-groups 2002 to 2005 and 2016 to 2018 ($P > 0.05$, 172.2 days and 172.6 days, respectively).

Feed to Gain

Sire-breed ($P < 0.0001$), sex ($P < 0.0001$), and year-group ($P < 0.0001$) affected feed:gain of feedlot cattle (Table 3.4). Simmental-sired (3.05 kg) cattle were the most feed efficient ($P < 0.05$) compared with all other sire breeds. Red Angus-sired (3.10 kg) cattle were the second most feed efficient ($P < 0.05$) sire breed. Angus-sired and Charolais-sired cattle had a similar ($P > 0.05$) feed efficiencies (3.13 kg and 3.14 kg, respectively), which was more efficient ($P < 0.05$) than Hereford-sired cattle (3.21 kg). Steers were more feed efficient ($P < 0.05$) than heifers (3.07 kg and 3.18 kg respectively). The most efficient ($P < 0.05$) year-groups for feed:gain were 2010 to

2012 and 2013 to 2015 ($P > 0.05$, 3.03 kg and 3.03 kg, respectively) compared with all other year-groups. The poorest ($P < 0.05$) feed:gain year-group was 2016 to 2018 at 3.24 kg.

Feed Cost

Sire-breed ($P < 0.0001$), sex ($P < 0.0001$), and year-group ($P < 0.0001$) affected feed cost for feedlot cattle (Table 3.4). Charolais-sired cattle had the lowest ($P < 0.05$) feed cost per head compared with all other sire breeds (\$311.26). Angus-sired cattle had the second lowest ($P < 0.05$) feed cost per head at \$314.86. Hereford-sired (\$322.03) and Simmental-sired (\$322.20) cattle had similar ($P > 0.05$) feed costs, which was less ($P < 0.05$) than Red Angus-sired cattle (\$327.22). Heifers had a lower ($P < 0.05$) feed cost than steers (\$305.17 and \$333.86, respectively). Year-group 2002 to 2005 had the lowest ($P < 0.05$) feed cost per head compared with all other year-groups (\$192.22). The greatest ($P < 0.05$) feed cost per head was year-group 2010 to 2012 at \$433.85.

Feed Consumed

Sire-breed ($P < 0.001$), sex ($P < 0.0001$), and year-group ($P < 0.0001$) affected feed consumed for feedlot cattle (Table 3.4). Angus-sired (1,618.8 kg of DM), Charolais-sired (1,626.8 kg of DM), Hereford-sired (1,612.6 kg of DM), and Red Angus-sired (1,627.9 of DM) cattle consumed a similar ($P > 0.05$) amount of feed. Angus-sired and Hereford-sired cattle consumed less feed ($P < 0.05$) than Simmental-sired cattle (1,635.7 kg of DM). Red Angus-sired cattle consumed a similar ($P > 0.05$) amount of feed as Simmental-sired cattle. Simmental-sired and Charolais-sired (1,626.8 kg of DM) cattle consumed similar ($P > 0.05$) amounts of feed. Steers consumed more ($P < 0.05$) feed than heifers (1,704.0 kg of DM and 1,544.7 kg of DM, respectively). The greatest ($P < 0.05$) feed consumption was in year-groups 2002 to 2005 and 2016 to 2018 ($P > 0.05$; 1,671.7 kg of DM and 1,661.9 kg of DM, respectively). Year-group 2016 to

2018 was similar ($P > 0.05$) to 2013 to 2015 (1,658.3 kg of DM). The lowest ($P < 0.05$) feed consumption was 2006 to 2009 (1,542.0 kg of DM).

Continental-influenced cattle typically produce a lean, high cutability carcass but they usually spend more days on feed. DeRouen et al. (2000) reported Gelbvieh-sired and Gelbray-sired steers had a tendency for more days on feed than Angus-sired and Brangus-sired steers. Our results show similar findings where Charolais-sired cattle spent more days on feed than Angus-sired, Hereford-sired, and Red Angus-sired cattle. Year-grouping variation for feed variables showed when cattle spent fewer days on feed, the feed:gain was more efficient. In 2010 to 2012, cattle spent the fewest days on feed, were the most efficient, and had the highest feed cost. While similar feed rations were fed between feedlots in a given year, changes in rations between years was not included in the study.

Health Traits

Morbidity

Sire-breed ($P < 0.0001$), sex ($P < 0.0001$), and year-group ($P < 0.0001$) affected morbidity odds in feedlot cattle (Table 3.5). Hereford-sired, Charolais-sired, Red Angus-sired, and Simmental-sired cattle had increased ($P < 0.0001$) odds of morbidity than Angus-sired cattle. Steers had increased ($P < 0.0001$) odds of having a morbidity event than heifers. Each year-group increased ($P < 0.001$) the odds of morbidity.

Mortality

Sire-breed did not affect ($P = 0.67$) mortality odds in feedlot cattle (Table 3.6). Sex ($P < 0.001$) and year-group ($P < 0.0001$) affected mortality odds in feedlot cattle (Table 3.6). Steers had increased ($P < 0.0001$) odds of mortality than heifers. Year-group 2016 to 2018 had the greatest odds ($P < 0.001$) of mortality.

There is little evidence in the literature for breed differences for morbidity and mortality risk. The most common cause of morbidity and mortality in feedlot cattle in the United States is bovine respiratory disease (Loneragan et al., 2001; Brooks et al., 2011; USDA, NAHMS, 2013b). Snowder et al. (2006) found Hereford cattle were generally more susceptible to bovine respiratory disease (Snowder et al., 2006). Our analysis, however, did not include specific cause or timing within the feeding period for morbidity or mortality.

Kelly and Janzen (1986) reviewed veterinary literature for morbidity and mortality risk in North American feedlot cattle. They found most literature reported a morbidity risk between 15% and 45% (Kelly and Janzen, 1986). Our study had an overall morbidity risk of 22.9%. Kelly and Janzen (1986) found most literature reported a mortality risk of 1% to 5%. United States Department of Agriculture. National Animal Health Monitoring System Feedlot studies reported a death loss of approximately 1% for both the 1999 study and the 2011 study (USDA, NAHMS, 2013a). Our study had an overall mortality risk of 1.6%. Morbidity and mortality trend increased in these data from 2002 through 2018, which is reflected in the year-group odds ratios. We are unsure of the cause of the increase in morbidity and mortality for these data.

Snowder et al. (2006) reported steers were higher risk than heifers for bovine respiratory disease infection. Loneragen et al. (2001) reported, however, heifers had an increased risk for bovine respiratory infection compared with steers. Sanderson et al. (2008) found no difference in respiratory disease risk for steers and heifers, but cattle in mixed pens (steers and heifers) were at a greater risk than single gender (only steers or only heifer) pens.

Focus on Feedlots reported close out information for the nine feedlots included their data (Waggoner, 2018). Focus on Feedlots reported a slight increase in mortality risk from 2002

through 2018 (Waggoner, 2018). Focus on Feedlots reported an average mortality risk of 1.4% from 2002 through 2018 for both steers and heifers (Waggoner, 2018).

While this study evaluated morbidity and mortality at the feedlot, the health of the animal is dependent on more than feedlot management. While outside the scope of this study, there are many other factors including the performance and health of an animal in the feedlot, including the nutrition of the dam during gestation, herd health and management, quality and quantity of colostrum received, nutrition of calf prior to weaning, and management of calf prior to weaning.

Carcass Traits

Hot Carcass Weight

Sire-breed ($P < 0.0001$), sex ($P < 0.0001$), and year-group ($P < 0.0001$) affected hot carcass weight for feedlot cattle (Table 3.7). Red-Angus sired cattle had the lightest ($P < 0.05$) hot carcass weight compared with all other sire breeds (321.8 kg). Hereford-sired cattle had the second lightest ($P < 0.05$) hot carcass weight (324.9 kg). Angus-sired (327.7 kg) cattle had a lighter ($P < 0.05$) hot carcass weight than Charolais-sired and Simmental-sired cattle, which had similar ($P > 0.05$) hot carcass weights (333.6 kg and 334.8 kg, respectively). Steers had a heavier ($P < 0.05$) hot carcass weight than heifers (343.0 kg of BW and 314.1 kg of BW, respectively). The lightest ($P < 0.05$) hot carcass weights were in year-group 2002 to 2005 and 2006 to 2009 ($P > 0.05$, 322.8 kg and 323.3 kg, respectively). The next lightest ($P < 0.05$) hot carcass weight was 2010 to 2012 at 330.4 kg. The heaviest ($P < 0.05$) hot carcass weight was 2013 to 2015 at 334.1 kg.

Dressing Percentage

Sire-breed ($P < 0.0001$), sex ($P < 0.0001$), and year-group ($P < 0.01$) affected dressing percent for feedlot cattle (Table 3.7). Hereford-sired cattle had the lowest ($P < 0.05$) dressing percent compared with all other sire breeds (61.2%). Red Angus-sired cattle had the second lowest

($P < 0.05$) dressing percent at 61.3%. Angus-sired (61.5%) and Simmental-sired (61.5%) had similar ($P > 0.05$) dressing percentages, which was less ($P < 0.05$) than Charolais-sired cattle (61.8%). Steers had a lower ($P < 0.05$) dressing percent than heifers (61.4% and 61.5%, respectively).

Fat Thickness

Sire-breed ($P < 0.0001$), sex ($P < 0.0001$), and year-group ($P < 0.0001$) affected fat thickness for cattle carcasses (Table 3.7). Charolais-sired cattle had the least ($P < 0.05$) fat thickness compared with all other sire breeds at 1.04 cm. Simmental-sired cattle had the second smallest ($P < 0.05$) fat thickness at 1.08 cm. Red Angus-sired cattle were the third leanest ($P < 0.05$) compared with all other sire breeds (1.21 cm). Angus-sired cattle had the second greatest ($P < 0.05$) fat thickness at 1.31 cm. Hereford-sired cattle had the greatest ($P < 0.05$) fat thickness compared with all other sire breeds (1.38 cm). Steers were leaner ($P < 0.05$) than heifers (1.14 cm and 1.26 cm, respectively). Year-groups 2002 to 2005 and 2006 to 2009 had similar ($P > 0.05$) and were the leanest ($P < 0.05$) compared to all other year-groups (1.11 cm and 1.12 cm, respectively). Year-group 2010 to 2012 (1.21 cm) was the next leanest ($P < 0.05$). Year-group 2013 to 2015 was the second greatest ($P < 0.05$) fat thickness (1.24 cm). The greatest ($P < 0.05$) fat thickness was in year-group 2016 to 2018 at 1.32 cm.

Ribeye Area

Sire-breed ($P < 0.0001$), sex ($P < 0.0001$), and year-group ($P < 0.0001$) affected ribeye area for feedlot cattle (Table 3.7). Charolais-sired and Simmental-sired cattle had similar ($P > 0.05$) and the largest ($P < 0.05$) ribeye area compared with all other sire breeds (83.9 cm² and 84.3 cm², respectively). Red Angus-sired animals had a ribeye area of 79.5 cm², which was smaller ($P < 0.05$) than Charolais-sired and Simmental-sired cattle. Angus-sired cattle had the second smallest

($P < 0.05$) ribeye area at 78.6 cm². Hereford-sired cattle had the smallest ($P < 0.05$) ribeye area compared with all other sire breeds at 77.5 cm². Steers had a larger ($P < 0.05$) ribeye area than heifers (82.8 cm² and 78.7 cm², respectively). Year-groups 2013 to 2015 and 2016 to 2018 had similar ($P > 0.05$) and the largest ribeye areas compared with all other year-groups (81.6 cm² and 81.4 cm², respectively). Year-group 2010 to 2012 had the next largest ($P < 0.05$) ribeye area (81.0 cm²). Year-group 2006 to 2009 had the next to smallest ($P < 0.05$) ribeye area (80.2 cm²). Year-group 2005 to 2005 had the smallest ($P < 0.05$) ribeye area compared with all other year-groups (79.6 cm²).

Calculated Yield Grade

Sire-breed ($P < 0.0001$), sex ($P < 0.0001$), and year-group ($P < 0.0001$) affected calculated yield grade for feedlot cattle (Table 3.7). Charolais-sired and Simmental-sired cattle had similar ($P > 0.05$) and the smallest ($P < 0.05$) calculated yield grade compared with all other sire breeds (2.6 and 2.6, respectively). Red Angus-sired cattle had the second smallest ($P < 0.05$) calculated yield grade at 2.9. Angus-sired cattle had the second greatest ($P < 0.05$) calculated yield grade (3.1). Hereford-sired cattle had the greatest ($P < 0.05$) calculated yield grade compared with all other sire breeds (3.2). Steers had a smaller ($P < 0.05$) calculated yield grade than heifers (2.8 and 2.9, respectively). Year-groups 2002 to 2005 and 2006 to 2009 had similar ($P > 0.05$) and the smallest calculated yield grades (2.8 and 2.8, respectively). Year-group 2010 to 2012 and 2013 to 2015 had similar ($P > 0.05$) calculated yield grades (2.9 and 2.9, respectively). The greatest ($P < 0.05$) calculated yield grade was in 2016 to 2018 at 3.0 compared with all other year-groups.

Marbling Score

Sire-breed ($P < 0.0001$), sex ($P < 0.0001$), and year-group ($P < 0.0001$) affected marbling score for feedlot cattle (Table 3.7). Angus-sired cattle had the greatest ($P < 0.05$) marbling score

compared with all other sire breeds (470.4). Red Angus-sired animals had the second greatest ($P < 0.05$) marbling score (444.5). Hereford-sired and Simmental-sired cattle had similar ($P > 0.05$) marbling scores (423.9 and 429.0, respectively). Charolais-sired cattle had the lowest ($P < 0.05$) marbling score compared with all other sire breeds (411.2). Heifers had a greater ($P < 0.05$) marbling score than steers (450.8 and 420.8, respectively). The greatest ($P < 0.05$) marbling score was in year-group 2016 to 2018 (467.2). The second greatest ($P < 0.05$) marbling score was in year-group 2013 to 2015 (446.9). Year-groups 2002 to 2005 and 2010 to 2012 had similar ($P > 0.05$) marbling scores (431.2 and 428.9, respectively). The lowest ($P < 0.05$) marbling score was year-group 2006 to 2009 (404.9).

Carcass Value

Sire-breed ($P < 0.0001$), sex ($P < 0.0001$), and year-group ($P < 0.0001$) affected carcass value for feedlot cattle (Table 3.7). Simmental-sired cattle had the greatest ($P < 0.05$) carcass value compared with all other sire breeds (\$1,336.14). Charolais-sired cattle had the second greatest ($P < 0.05$) carcass value (\$1,319.35). Angus-sired cattle had the next greatest ($P < 0.05$) carcass value (\$1,308.27). Hereford-sired cattle had the second lowest ($P < 0.05$) carcass value (\$1,267.63). Red Angus-sired cattle had the lowest ($P < 0.05$) carcass value compared with all other sire breeds (\$1,250.22). Steers had a greater ($P < 0.05$) carcass value than heifers (\$1,348.84 and \$1,243.80, respectively). The greatest ($P < 0.05$) carcass value was year-group 2013 to 2015 at \$1,725.16. The least ($P < 0.05$) carcass value was year-group 2002 to 2005 (\$935.78).

The carcass trait results in this study agrees with previous literature that Continental-sired cattle had higher cutability while British-sired cattle had more marbling with more external fat. DeRouen et al. (2000) found Gelbvieh-sired steers had a larger ($P < 0.05$) ribeye area than Angus-sired steers. Trejo et al. (2010) showed Simmental-sired, SimAngus-sired, and 75% Simmental-

sired steers had a larger ($P < 0.05$) ribeye area than Angus-sired steers. Wheeler et al. (2005) found similar results, which were that steers from Continental sires (Limousin, Charolais, Simmental, and Gelbvieh) had a larger ($P < 0.05$) ribeye areas than the British-sired steers (Angus, Red Angus, and Hereford). Wheeler et al. (2005) found Limousin-sired, Gelbvieh-sired, and Hereford-sired steers had the lightest ($P < 0.05$) carcass weights compared with all other sire breeds.

DeRouen et al. (2000) found Angus-sired steers had a greater ($P < 0.05$) marbling score than Gelbvieh-sired steers. Trejo et al. (2010) showed Angus-sired steers had a greater ($P < 0.05$) marbling score than Simmental-sired, SimAngus-sired, and 75% Simmental-sired steers. Angus steers were also found to have the greatest marbling by Parish et al. (2014). Baker et al. (2001), however, found no difference in marbling between Angus-sired and Hereford-sired animals. In 2005, it was reported Angus-sired and Red Angus-sired cattle produced greater marbling scores than Hereford-sired cattle (Wheeler et al., 2005).

Angus-sired, Hereford-sired, and Red Angus-sired steers had a greater ($P < 0.05$) adjusted fat thickness than Charolais-sired, Limousin-sired, Simmental-sired, and Gelbvieh-sired steers (Wheeler et al., 2005). Trejo et al. (2010) found Angus-sired steers had the most ($P < 0.05$) backfat compared with all other sire breeds (Simmental, SimAngus, and 75% Simmental).

DeRouen et al. (2000) found Gelbvieh-sired steers had a lower ($P < 0.05$) yield grade than Angus-sired steers. Continental-influenced steers had lower yield grades than British-influenced steers (DeRouen et al., 2000). Similar, Trejo et al. (2010) found Angus-sired steers had the highest ($P < 0.05$) calculated yield grade compared with all other sire breeds.

Few studies report an overall calculated carcass value. According to Tatum et al. (2006), “carcass weight was the single most important driver of carcass value”. While not included in the scope of our study, Tatum et al. (2006) noted depending on the Choice-Select spread, the

importance of quality grade changed. When the Choice-Select spread was less than \$10, 70 to 90% of the total revenue variation was attributed to carcass weight (Tatum et al., 2006). The results in our study aligned with Tatum et al. (2006). The sire-breeds with the heavier hot carcass weights had the greatest carcass value, as these were cattle sold on a grid.

Discounts for yield grade 4 and 5 are typical in the beef industry. Tatum et al. (2006) found when the Choice-Select spread was greater, the value of increased quality grade was greater than the discounts associated with a poorer, discounted yield grade. The cattle included in these analyses were selected for harvest based on visual appraisal for a targeted backfat thickness that limited likelihood of cattle reaching numerically greater and undesirable yield grades of 4 and 5. In these analyses, yield grade 4 represented 4.0% (2,084/51,941 head) and yield grade 5 represented 0.1% (59/51,941 head) of cattle. The 2011 National Beef Quality Audit reported 8.6% yield grade 4 and 1.6% yield grade 5 (Moore et al., 2012). In comparison to the 2016 National Beef Quality Audit that reported 12.0% yield grade 4's and 2.5% yield grade 5's, the cattle in our study had fewer yield grade 4 and 5's (Boykin et al., 2017). The National Beef Quality Audits from 2011 and 2016 showed a greater percentage of cattle received yield grade 4 and 5's at slaughter in 2016 than 2011.

Our analysis found steers were heavier at arrival and at harvest than heifers. Heifers had a lower average daily gain, fewer days on feed, and a higher feed:gain than steers. Steers had a heavier hot carcass weight, lower dressing percent, less backfat, larger ribeye area, lower calculated yield grade, lower marbling score, and an overall greater carcass value than heifers. Steers had increased odds of a morbidity or mortality occurrence than heifers.

Overall, these results showed Angus-sired, Hereford-sired, and Red-Angus cattle arrived at a lighter weight, harvested at a lighter weight, spent fewer days on feed to reach the targeted

backfat thickness, had more backfat even though the cattle were targeted for the same fat thickness, had more marbling, and less cutability than Charolais-sired and Simmental-sired cattle. Angus-sired cattle spent the fewest days on feed, had the highest average daily gain, and the most marbling compared with all other sire breeds. Red Angus-sired cattle were the lightest at arrival, lightest at harvest, lightest hot carcass weight, and had the lowest carcass value compared with all other sire breeds. Hereford-sired cattle were the least feed efficient and had the lowest dressing percentage, most backfat, smallest ribeye area, and the highest calculated yield grade compared with all other sire breeds. Charolais-sired cattle had the least average daily gain, spent the most days on feed, highest dressing percentage, least backfat (although all cattle were targeted for the same fat thickness end point), and the lowest marbling score compared with all other sire breeds. Simmental-sired cattle had the greatest harvest weight, were the most feed efficient, and had the highest carcass value compared with all other sire breeds. Charolais-sired and Simmental-sired cattle had similar and the greatest hot carcass weight, largest ribeye area, and lowest calculated yield grades compared with all other sire breeds.

Applications

Results from this study found Continental-sired (Charolais and Simmental) cattle produced a heavier, leaner, less marbled carcass while spending more days on feed than British-sired (Angus, Red Angus, and Hereford) cattle. Hereford-sired, Red Angus-sired, Charolais-sired, and Simmental-sired cattle had increased odds of a morbidity event than Angus-sired cattle. Sire-breed was not significant for mortality odds. Additional information is needed to determine the cause of morbidity and mortality. Producers should consider their operational goals and select the sire breed(s) that best meet their needs and the needs of their customers.

Acknowledgements

The authors gratefully acknowledge the Tri-County Steer Carcass Futurity Cooperative, Lewis, IA, for providing the data and their cooperation for this research.

Literature Cited

- Baker, J. F., S. E. Williams, and R. C. Vann. 2001. Effects of Tuli, Brahman, Angus, and Polled Hereford sires on carcass traits of steer offspring. *Prof. Anim. Sci.* 17:154-159. doi.org/10.15232/S1080-7446(15)31616-8
- Boykin, C. A., L. C. Eastwood, M. K. Harris, D. S. Hale, C. R. Kerth, D. B. Griffin, A. N. Arnold, J. D. Hasty, K. E. Belk, D. R. Woerner, R. J. Delmore Jr., J. N. Martin, D. L. VanOverbeke, G. G. Mafi, M. M. Pfeiffer, T. E. Lawrence, T. J. McEvers, T. B. Schmidt, R. J. Maddock, D. D. Johnson, C. C. Carr, J. M. Scheffler, T. D. Pringle, A. M. Stelzleni, J. Gottlieb, and J. W. Savell. 2017. National Beef Quality Audit – 2016: Survey of carcass characteristics through instrument grading assessments. *J. Anim. Sci.* 95:3003-3011. doi: 10.2527/jas2017.1544
- Brooks, K.R., K.C. Raper, C.E. Ward, B.P., Holland, C.R. Krehbiel, and D.L. Step. 2011. Economic effects of bovine respiratory disease on feedlot cattle during backgrounding and finishing phases. *Prof. Anim. Sci.* 27:195-203. doi.org/10.15232/S1080-7446(15)30474-5
- Busby, D. 2015. Lessons learned from 32 years of retained ownership – TCSCF summary. Driftless Region Beef Conference, Dubuque, IA.
- Cornell University. 2020. Cornell net carbohydrate and protein system. Accessed October 10, 2020. <https://blogs.cornell.edu/cncps/>

- DeRouen, S. M., W. E. Wyatt, T. D. Binder, and M. A. Persica. 2000. Feedlot and carcass performance of Angus-, Brangus-, Gelbvieh-, and Gelbray-sired crossbred steers. *Prof. Anim. Sci.* 16:6-12. DOI: 10.15232/S1080-7446(15)31654-5
- Groves, M. 2020. Personal communication. Manager Tri-County Steer Carcass Futurity Cooperative. June 10, 2020.
- Kelly, A. P. and E. D. Janzen. 1986. A review of morbidity and mortality rate and disease occurrence in North American feedlot cattle. *Can. Vet. J.* 27: 496-500.
- Loneragan, G.H., D.A. Dargatz, P.S. Morley, and M.A. Smith. 2001. Trends in mortality ratios among cattle in U.S. feedlots. *JAVMA.* 219:1122-1127. DOI: 10.2460/javma.2001.219.1122
- Minish, G. L., and D. G. Fox. 1979. *Beef Production and Management*. 1st ed. Reston Publ. Co. Inc., Reston, VA.
- Moore, M. C., G. D. Gray, D. S. Hale, C. R. Kerth, D. B. Griffin, J. W. Savell, C. R. Raines, K. E. Belk, D. R. Woerner, J. D. Tatum, J. L. Igo, D. L. VanOverbeke, G. G. Mafi, T. E. Lawrence, R. J. Delmore Jr., L. M. Christensen, S. D. Shackelford, D. A. King, T. L. Wheeler, L. R. Meadows, and M. E. O'Connor. 2012. National Beef Quality Audit – 2011: In-plant survey of targeted carcass characteristics related to quality, quantity, value, and

marketing of fed steers and heifers. *J. Anim. Sci.* 90:5143–5151. doi:10.2527/jas.2012-5550

Parish, J. A., B. B. Karisch, R. C. Vann, and D. G. Riley. 2014. Effects of steer breed composition on feedlot performance and carcass traits. *Prof. Anim. Sci.* 30:43-50. doi.org/10.15232/S1080-7446(15)30081-4

Reinhardt, C. D., W. D. Busby, and L. R. Corah. 2009. Relationship of various incoming cattle traits with feedlot performance and carcass traits. *J. Anim. Sci.* 87: 3030-3042. doi:10.2527/jas.2008-1293

Sanderson, M. W., D. A. Dargatz, and B. A. Wagner. 2008. Risk factors for initial respiratory disease in United States' feedlots based on producer-collected daily morbidity counts. *Can. Vet. J.* 49:373-378.

SAS Institute Inc. 2020a. The GENMOD Procedure. Accessed 07 August 2020. https://documentation.sas.com/?docsetId=statug&docsetTarget=statug_genmod_syntax01.htm&docsetVersion=14.3&locale=en

SAS Institute Inc. 2020b. The MIXED Procedure. Accessed 17 July 2020. https://documentation.sas.com/?docsetId=statug&docsetTarget=statug_mixed_syntax01.htm&docsetVersion=14.3&locale=en

Snowder, G. D., L. D. Van Vleck, L. V. Cundiff, and G. L. Bennett. 2006. Bovine respiratory in feedlot cattle: Environmental, genetic, and economic factors. *J. Anim. Sci.* 84: 1999-2008. doi:10.2527/jas.2006-046

Tatum, J. D., K. E. Belk, T. G. Field, J. A. Scanga, and G. C. Smith. 2006. Relative importance of weight, quality grade, and yield grade as drivers of beef carcass value in two grid-pricing systems. *Prof. Anim. Sci.* 22: 41-47. DOI: 10.15232/S1080-7446(15)31059-7

Trejo, C. O., D. B. Faulkner, A. Shreck, J. W. Himm, T. G. Nash, S. L. Rodriguez-Zas, and L. L. Berger. 2010. Effects of co-products and breed of sire on the performance, carcass characteristics, and rates of ultrasound backfat and marbling deposition in feedlot cattle. *Prof. Anim. Sci.* 26: 620-630. doi.org/10.15232/S1080-7446(15)30659-8

Tri-County Steer Carcass Futurity Cooperative. 2020. TCSCF Rules and Regulations. Accessed September 21, 2020. <http://www.tcscf.com/>

United States Department of Agriculture, National Animal Health Monitoring System (USDA, NAHMS). 2013a. Part III: Trends in health and management practices on U.S. feedlots, 1994-2011. USDA—APHIS—VS—CEAH—NAHMS. Fort Collins, CO. #673.0713

United States Department of Agriculture, National Animal Health Monitoring System (USDA, NAHMS). 2013b. Types and costs of respiratory disease treatments in U.S. feedlots. USDA—APHIS—VS—CEAH—NAHMS. Fort Collins, CO. #671.0513

United States Department of Agriculture, Economic Research Service (USDA ERS). 2020. Livestock and Meat Domestic Data. Accessed September 13, 2020. <https://www.ers.usda.gov/data-products/livestock-meat-domestic-data/>

Waggoner, J. 2018. Focus on Feedlots. Kansas State University Research and Extension. Accessed May 02,2020. <https://www.asi.k-state.edu/about/newsletters/focus-on-feedlots/>

Wheeler, T. L., L. V. Cundiff, S. D. Shackelford, and M. Koohmaraie. 2005. Characterization of biological types of cattle (Cycle VII): Carcass, yield, and longissimus palatability traits. *J. Anim. Sci.* 83:196-207. DOI: 10.2527/2005.831196x

Tables

Table 3.1 - Unadjusted mean, SD, median, and range values for continuous variables for steers¹ finished through Tri-County Steer Carcass Futurity Cooperative, Lewis, IA from 2002 through 2018

Variable	Mean \pm SD	Median	Range
Arrival Weight (kg)	302.7 \pm 51.1	300.3	117.9 to 453.1
Average Daily Gain (kg/day)	1.5 \pm 0.3	1.5	0.1 to 3.1
Harvest Weight (kg)	556.4 \pm 52.0	553.4	318.4 to 771.1
Days on Feed	166.9 \pm 27.2	166.0	66.0 to 305.0
Feed to Gain (kg)	3.1 \pm 0.4	3.0	0.6 to 10.9
Feed Cost (\$)	292.5 \pm 105.20	277.31	66.73 to 992.39
Total Feed Consumed (kg of DM)	1,689.5 \pm 282.2	1,680.9	471.6 to 3,112.3
Hot Carcass Weight (kg)	340.0 \pm 33.3	338.8	182.8 to 471.7
Dressing Percent	61.4 \pm 1.7	61.5	47.0 to 70.4
Fat Thickness (cm)	1.3 \pm 0.3	1.3	0.0 to 3.0
Ribeye Area (cm ²)	81.3 \pm 7.7	80.0	48.4 to 130.3
Calculated Yield Grade	2.9 \pm 0.6	3.0	0.2 to 5.4
Marbling Score	435.0 \pm 81.7	430.0	100.0 to 946.0
Carcass Value (\$)	1,213.00 \pm 305.68	1,123.3	406.42 to 2,622.60

¹There were 37,993 steers included in these analyses.

Table 3.2 - Unadjusted mean, SD, median, and range values for continuous variables for heifers¹ finished through Tri-County Steer Carcass Futurity Cooperative, Lewis, IA from 2002 through 2018

Variable	Mean \pm SD	Median	Range
Arrival Weight (kg)	286.8 \pm 54.5	281.2	108.8 to 452.6
Average Daily Gain (kg/day)	1.4 \pm 0.3	1.4	0.4 to 2.8
Harvest Weight (kg)	506.7 \pm 47.0	501.1	309.3 to 728.8
Days on Feed	161.4 \pm 32.1	161.0	62.0 to 333.0
Feed to Gain (kg)	3.2 \pm 0.4	3.1	1.6 to 10.8
Feed Cost (\$)	265.80 \pm 91.09	252.47	59.76 to 768.50
Total Feed Consumed (kg of DM)	1,524.6 \pm 279.3	1,519.8	483.0 to 3,205.2
Hot Carcass Weight (kg)	311.2 \pm 29.4	307.9	194.1 to 474.8
Dressing Percent	61.5 \pm 1.8	61.6	48.3 to 70.0
Fat Thickness (cm)	1.3 \pm 0.3	1.3	0.0 to 3.6
Ribeye Area (cm ²)	76.8 \pm 7.1	76.8	49.0 to 127.7
Calculated Yield Grade	3.0 \pm 0.6	3.0	0.5 to 6.0
Marbling Score	462.2 \pm 93.2	450.0	200.0 to 982.0
Carcass Value (\$)	1,102.97 \pm 266.25	1,029.68	371.16 to 2,457.31

¹There were 13,945 heifers included in these analyses.

Table 3.3 - Effect of sire breed, sex, and year-group for arrival weight, average daily gain, and harvest weight in feedlot cattle finished through Tri-County Steer Carcass Futurity Cooperative, Lewis, IA from 2002 through 2018

Factor	Number of head	Least squares mean	Regression coefficient	P value of factor
<u>Arrival weight (kg of BW)</u>				
Sire Breed				<0.0001
Angus	38,153	294.6 ^a	-2.9	
Hereford	3,445	299.9 ^b	2.4	
Red Angus	2,648	282.7 ^c	-14.8	
Charolais	3,273	300.3 ^b	2.7	
Simmental	4,419	297.5 ^b	0.0	
Sex				<0.0001
Steers	37,993	303.3 ^a	16.5	
Heifers	13,945	286.7 ^b	0.0	
Year-Group				<0.0001
2002 to 2005	15,992	283.8 ^a	-20.0	
2006 to 2009	19,823	301.3 ^b	-2.5	
2010 to 2012	5,008	295.9 ^c	-8.0	
2013 to 2015	5,139	290.3 ^d	-13.5	
2016 to 2018	5,976	303.8 ^e	0.0	
<u>Average daily gain (kg/day)</u>				
Sire Breed				<0.0001
Angus	38,153	1.49 ^a	0.04	
Hereford	3,445	1.44 ^b	-0.02	
Red Angus	2,648	1.45 ^{bc}	0.00	
Charolais	3,273	1.39 ^d	-0.07	
Simmental	4,419	1.46 ^c	0.00	
Sex				<0.0001
Steers	37,993	1.52 ^a	0.15	
Heifers	13,945	1.37 ^b	0.0	
Year-Group				<0.0001
2002 to 2005	15,992	1.43 ^a	0.05	
2006 to 2009	19,823	1.40 ^b	0.02	
2010 to 2012	5,008	1.51 ^c	0.13	
2013 to 2015	5,139	1.50 ^c	0.12	
2016 to 2018	5,976	1.38 ^d	0.00	
<u>Harvest weight (kg of BW)</u>				
Sire Breed				<0.0001
Angus	38,153	533.5 ^a	-10.4	
Hereford	3,445	532.4 ^a	-11.6	
Red Angus	2,648	526.0 ^b	-18.0	
Charolais	3,273	541.8 ^c	-2.2	
Simmental	4,419	544.0 ^c	0.0	
Sex				<0.0001
Steers	37,993	560.4 ^a	49.7	

Table 3.3 Continued

Heifers	13,945	510.7 ^b	0.0	
Year-Group				<0.0001
2002 to 2005	15,992	528.2 ^a	-12.0	
2006 to 2009	19,823	530.0 ^b	-10.2	
2010 to 2012	5,008	536.6 ^c	-3.6	
2013 to 2015	5,139	542.8 ^d	2.7	
2016 to 2018	5,976	540.1 ^e	0.0	

^{a,b,c,d,e}Values within a factor without a common superscript differ (P < 0.05).

Table 3.4 - Effect of sire breed, sex, and year-group for days on feed, feed to gain, feed cost, and feed consumed in feedlot cattle finished through Tri-County Steer Carcass Futurity Cooperative, Lewis, IA from 2002 through 2018

Factor	Number of head	Least squares mean	Regression coefficient	P value of factor
<u>Days on feed</u>				
Sire Breed				<0.0001
Angus	38,153	162.1 ^a	-8.7	
Hereford	3,445	164.2 ^b	-6.6	
Red Angus	2,648	169.2 ^c	-1.6	
Charolais	3,273	174.9 ^d	4.1	
Simmental	4,419	170.8 ^c	0.0	
Sex				<0.0001
Steers	37,993	170.9 ^a	5.4	
Heifers	13,945	165.6 ^b	0.0	
Year-Group				<0.0001
2002 to 2005	15,992	172.2 ^a	-0.4	
2006 to 2009	19,823	165.0 ^b	-7.5	
2010 to 2012	5,008	161.4 ^c	-11.2	
2013 to 2015	5,139	170.1 ^d	-2.5	
2016 to 2018	5,976	172.6 ^a	0.0	
<u>Feed to gain (kg)</u>				
Sire Breed				<0.0001
Angus	38,153	3.13 ^a	0.08	
Hereford	3,445	3.21 ^b	0.16	
Red Angus	2,648	3.10 ^c	0.05	
Charolais	3,273	3.14 ^a	0.09	
Simmental	4,419	3.05 ^d	0.00	
Sex				<0.0001
Steers	37,993	3.07 ^a	-0.12	
Heifers	13,945	3.18 ^b	0.00	
Year-Group				<0.0001
2002 to 2005	15,992	3.18 ^a	-0.06	
2006 to 2009	19,823	3.16 ^b	-0.08	
2010 to 2012	5,008	3.03 ^c	-0.21	
2013 to 2015	5,139	3.03 ^c	-0.21	
2016 to 2018	5,976	3.24 ^d	0.00	
<u>Feed cost (\$)</u>				
Sire Breed				<0.0001
Angus	38,153	314.86 ^a	-7.34	
Hereford	3,445	322.03 ^b	-0.17	
Red Angus	2,648	327.22 ^c	5.02	
Charolais	3,273	311.26 ^d	-10.92	
Simmental	4,419	322.20 ^b	0.00	
Sex				<0.0001
Steers	37,993	333.86 ^a	28.69	

Table 3.4 Continued

Heifers	13,945	305.17 ^b	0.00	
Year-Group				<0.0001
2002 to 2005	15,992	192.22 ^a	-132.84	
2006 to 2009	19,823	280.98 ^b	-44.08	
2010 to 2012	5,008	433.85 ^c	108.79	
2013 to 2015	5,139	365.47 ^d	40.41	
2016 to 2018	5,976	325.06 ^e	0.00	
		<u>Feed consumed (kg of DM)</u>		
Sire Breed				=0.0003
Angus	38,153	1,618.8 ^a	-16.9	
Hereford	3,445	1,612.6 ^a	-23.1	
Red Angus	2,648	1,627.9 ^{ab}	-7.8	
Charolais	3,273	1,626.8 ^{ac}	-8.9	
Simmental	4,419	1,635.7 ^{bc}	0.0	
Sex				<0.0001
Steers	37,993	1,704.0 ^a	159.3	
Heifers	13,945	1,544.7 ^b	0.0	
Year-Group				<0.0001
2002 to 2005	15,992	1,671.7 ^a	9.8	
2006 to 2009	19,823	1,542.0 ^b	-119.9	
2010 to 2012	5,008	1,587.7 ^c	-74.2	
2013 to 2015	5,139	1,658.3 ^d	-3.6	
2016 to 2018	5,976	1,661.9 ^{ad}	0.0	
^{a,b,c,d,e} Values within a factor without a common superscript differ (P < 0.05).				

Table 3.5 - The effect of sire breed, sex, and year-group on the morbidity risk of feedlot cattle finished through Tri-County Steer Carcass Futurity Cooperative, Lewis, IA from 2002 through 2018

Factor	Number of head with at least one morbidity event	Total number of head	Morbidity risk (%)	Odds ratio ¹	95% CI of odds ratio ²	P value
Sire Breed³						
Hereford	1,251	3,695	33.86	1.65	1.52 to 1.77	< 0.0001
Red Angus	811	2,906	27.91	1.26	1.15 to 1.37	< 0.0001
Charolais	860	3,426	25.10	1.39	1.28 to 1.51	< 0.0001
Simmental	1,197	4,724	25.34	1.21	1.13 to 1.30	< 0.0001
Angus	8,760	41,569	15.55	1.00	1.00 to 1.00	Referent
Sex⁴						
Steers	9,713	40,883	23.76	1.19	1.14 to 1.25	< 0.0001
Heifers	3,166	15,437	20.51	1.00	1.00 to 1.00	Referent
Year-Group⁵						
2002 to 2005	2,810	16,386	17.15	0.37	0.34 to 0.39	< 0.0001
2006 to 2009	3,921	20,278	19.34	0.43	0.41 to 0.46	< 0.0001
2010 to 2012	2,072	8,217	25.22	0.61	0.57 to 0.66	< 0.0001
2013 to 2015	1,796	5,253	34.19	0.90	0.84 to 0.98	< 0.01
2016 to 2018	2,280	6,186	36.86	1.00	1.00 to 1.00	Referent

¹The odds ratio for each factor was the odds of feedlot cattle within each factor having at least one morbidity event compared with the reference population.

²The 95% confidence intervals for the odds ratio.

³Sire breed was significant ($P < 0.0001$) for morbidity risk.

⁴Sex was significant ($P < 0.0001$) for morbidity risk.

⁵Year-group was significant ($P < 0.0001$) for morbidity risk.

Table 3.6 - The effect of sire breed, sex, and year-group on the mortality risk of feedlot cattle finished through Tri-County Steer Carcass Futurity Cooperative, Lewis, IA from 2002 through 2018

Factor	Number of head with a mortality event	Total number of head	Mortality risk (%)	Odds ratio ¹	95% CI of odds ratio ²	P value
Sire Breed³						
Hereford	69	3,695	1.87	1.07	0.83 to 1.38	= 0.61
Red Angus	51	2,906	1.75	0.98	0.73 to 1.31	= 0.90
Charolais	52	3,426	1.52	0.96	0.72 to 1.28	= 0.80
Simmental	67	4,724	1.42	0.84	0.65 to 1.08	= 0.18
Angus	664	41,569	1.60	1.00	1.00 to 1.00	Referent
Sex⁴						
Steers	695	40,883	1.70	1.24	1.06 to 1.45	< 0.01
Heifers	208	15,437	1.35	1.00	1.00 to 1.00	Referent
Year-Group⁵						
2002 to 2005	257	16,386	1.57	0.60	0.49 to 0.73	< 0.0001
2006 to 2009	306	20,278	1.51	0.58	0.48 to 0.71	< 0.0001
2010 to 2012	94	8,217	1.14	0.44	0.34 to 0.57	< 0.0001
2013 to 2015	86	5,253	1.64	0.62	0.48 to 0.81	< 0.001
2016 to 2018	160	6,186	2.59	1.00	1.00 to 1.00	Referent

¹The odds ratio for each factor was the odds of feedlot cattle within each factor having a mortality event compared with the reference population.

²The 95% confidence intervals for the odds ratio.

³Sire breed was not significant ($P = 0.67$) for mortality risk.

⁴Sex was significant ($P < 0.01$) for mortality risk.

⁵Year-group was significant ($P < 0.0001$) for mortality risk.

Table 3.7 - Effect of sire breed, sex, and year-group for carcass traits in feedlot cattle finished through Tri-County Steer Carcass Futurity Cooperative, Lewis, IA from 2002 through 2018

Factor	Number of head	Least squares mean	Regression coefficient	P value of factor
<u>Hot carcass weight (kg)</u>				
Sire Breed				<0.0001
Angus	38,153	327.7 ^a	-7.2	
Hereford	3,445	324.9 ^b	-9.9	
Red Angus	2,648	321.8 ^c	-13.0	
Charolais	3,273	333.6 ^d	-1.3	
Simmental	4,419	334.8 ^d	0.0	
Sex				<0.0001
Steers	37,993	343.0 ^a	28.9	
Heifers	13,945	314.1 ^b	0.0	
Year-Group				<0.0001
2002 to 2005	15,992	322.8 ^a	-9.4	
2006 to 2009	19,823	323.3 ^a	-8.9	
2010 to 2012	5,008	330.4 ^b	-1.8	
2013 to 2015	5,139	334.1 ^c	1.9	
2016 to 2018	5,976	332.2 ^d	0.0	
<u>Dressing percentage (%)</u>				
Sire Breed				<0.0001
Angus	38,153	61.5 ^a	0.0	
Hereford	3,445	61.2 ^b	-0.3	
Red Angus	2,648	61.3 ^c	-0.2	
Charolais	3,273	61.8 ^d	0.2	
Simmental	4,419	61.5 ^a	0.0	
Sex				<0.0001
Steers	37,993	61.4 ^a	-0.1	
Heifers	13,945	61.5 ^b	0.0	
Year-Group				=0.0080
2002 to 2005	15,992	61.4 ^a	-0.1	
2006 to 2009	19,823	61.4 ^{ab}	0.0	
2010 to 2012	5,008	61.5 ^{ac}	0.0	
2013 to 2015	5,139	61.5 ^{bc}	0.0	
2016 to 2018	5,976	61.5 ^{ab}	0.0	
<u>Fat thickness (cm)</u>				
Sire Breed				<0.0001
Angus	38,153	1.31 ^a	0.23	
Hereford	3,445	1.38 ^b	0.30	
Red Angus	2,648	1.21 ^c	0.13	
Charolais	3,273	1.04 ^d	-0.04	
Simmental	4,419	1.08 ^e	0.00	
Sex				<0.0001
Steers	37,993	1.14 ^a	-0.12	

Table 3.7 Continued

Heifers	13,945	1.26 ^b	0.00	
Year-Group				<0.0001
2002 to 2005	15,992	1.11 ^a	-0.21	
2006 to 2009	19,823	1.12 ^a	-0.20	
2010 to 2012	5,008	1.21 ^b	-0.11	
2013 to 2015	5,139	1.24 ^c	-0.09	
2016 to 2018	5,976	1.32 ^d	0.00	
		<u>Ribeye area (cm²)</u>		
Sire Breed				<0.0001
Angus	38,153	78.6 ^a	-5.8	
Hereford	3,445	77.5 ^b	-6.8	
Red Angus	2,648	79.5 ^c	-4.9	
Charolais	3,273	83.9 ^d	-0.4	
Simmental	4,419	84.3 ^d	0.0	
Sex				<0.0001
Steers	37,993	82.8 ^a	4.2	
Heifers	13,945	78.7 ^b	0.0	
Year-Group				<0.0001
2002 to 2005	15,992	79.6 ^a	-1.8	
2006 to 2009	19,823	80.2 ^b	-1.2	
2010 to 2012	5,008	81.0 ^c	-0.4	
2013 to 2015	5,139	81.6 ^d	0.2	
2016 to 2018	5,976	81.4 ^d	0.0	
		<u>Calculated yield grade</u>		
Sire Breed				<0.0001
Angus	38,153	3.1 ^a	0.5	
Hereford	3,445	3.2 ^b	0.6	
Red Angus	2,648	2.9 ^c	0.3	
Charolais	3,273	2.6 ^d	0.0	
Simmental	4,419	2.6 ^d	0.0	
Sex				<0.0001
Steers	37,993	2.8 ^a	-0.1	
Heifers	13,945	2.9 ^b	0.0	
Year-Group				<0.0001
2002 to 2005	15,992	2.8 ^a	-0.2	
2006 to 2009	19,823	2.8 ^a	-0.2	
2010 to 2012	5,008	2.9 ^b	-0.1	
2013 to 2015	5,139	2.9 ^b	-0.1	
2016 to 2018	5,976	3.0 ^c	0.0	
		<u>Marbling score¹</u>		
Sire Breed				<0.0001
Angus	38,153	470.4 ^a	41.4	
Hereford	3,445	423.9 ^b	-5.1	
Red Angus	2,648	444.5 ^c	15.5	
Charolais	3,273	411.3 ^d	-17.6	

Table 3.7 Continued

Simmental	4,419	429.0 ^b	0.0	
Sex				<0.0001
Steers	37,993	420.8 ^a	-30.0	
Heifers	13,945	450.8 ^b	0.0	
Year-Group				<0.0001
2002 to 2005	15,992	431.2 ^a	-36.0	
2006 to 2009	19,823	404.9 ^b	-62.3	
2010 to 2012	5,008	428.9 ^a	-38.3	
2013 to 2015	5,139	446.9 ^c	-20.2	
2016 to 2018	5,976	467.2 ^d	0.0	
		<u>Carcass value (\$)</u>		
Sire Breed				<0.0001
Angus	38,153	1,308.27 ^a	-27.87	
Hereford	3,445	1,267.63 ^b	-68.51	
Red Angus	2,648	1,250.22 ^c	-85.92	
Charolais	3,273	1,319.35 ^d	-16.79	
Simmental	4,419	1,336.14 ^e	0.00	
Sex				<0.0001
Steers	37,993	1,348.84 ^a	105.04	
Heifers	13,945	1,243.80 ^b	0.00	
Year-Group				<0.0001
2002 to 2005	15,992	935.78 ^a	-504.46	
2006 to 2009	19,823	1,036.69 ^b	-403.56	
2010 to 2012	5,008	1,343.73 ^c	-96.52	
2013 to 2015	5,139	1,725.16 ^d	284.91	
2016 to 2018	5,976	1,440.25 ^e	0.00	

^{a,b,c,d,e}Values within a factor without a common superscript differ (P < 0.05).

¹100 = Practically devoid⁰⁰; 300 = Slight⁰⁰; 400 = Small⁰⁰; 500 = Modest⁰⁰; 700 = Slightly Abundant⁰⁰; 900 = Abundant⁰⁰.

**Chapter 4 - Effect of Holstein and beef-dairy cross breed description
on the sale price of lots of steers sold through Superior Livestock
Auction video sales**

E. D. McCabe*, M. E. King*, K. E. Fike*, G. M. Rogers[†], and K. G. Odde*

*Department of Animal Sciences and Industry, Kansas State University, Manhattan, KS, 66506;

[†]Grassy Ridge Consulting, Aledo, TX 76008

Abstract

The objectives of this study were to determine 1) the relative value of Holstein feeder steer lots compared with the steer lots of other breed descriptions, and 2) the value of beef-dairy crosses compared with other breed combinations on the sale price of lots of calves sold through Superior Livestock Auction video auctions. Data were available on 14,075 lots of feeder steers sold via 211 video auctions from 2010 through 2018. Data were available in 589 lots of weaned steer calves sold via six video auctions during the summer of 2020. Separate multiple regression models using backwards selection were developed for feeder cattle lots and weaned steer calf lots. Lots were categorized into one of five breed groups: English-English crossed, English-Continental crossed, Brahman influenced, Holstein, and Beef-dairy crossed (calves only). Breed description of lots of feeder steers and weaned steer calves affected sale price ($P < 0.0001$). The mean weight for feeder steers was 363.2 ± 50.6 kg. Among feeder steer lots, Holstein sold for the lowest ($P < 0.05$) sale price (\$110.56/45.36 kg of BW) compared with all other breed descriptions. The mean weight for weaned steer calves was 277.5 ± 60.1 kg. Among weaned steer calf lots, Holstein sold for the lowest ($P < 0.05$) sale price (\$113.21/45.36 kg of BW). Beef-dairy crossed sold for the second lowest ($P < 0.05$) sale price (\$153.07/45.36 kg of BW), but were only \$15.21/45.36 kg of BW below English-English crossed. The beef-dairy cross had more value than the Holstein steer and may indicate an opportunity for more value in the beef chain.

Introduction

Dairy bull calves are often viewed as a byproduct of dairy production. Dairy calves are typically discounted compared with beef calves because of value comparisons, such as inefficiency in the feedyard (Ledbetter, 2018). Dairy-type animals, however, have a significant impact in

United States beef production. In 2018, fed dairy steers contributed 12.6% or 3.37 billion pounds to beef production (Boetel, 2019). Dairy-type carcasses often receive high quality grades, are uniform and consistent (Fairbairn and Felix, 2020), and provide a year-around supply of beef. Finishing dairy-type steers, however, have challenges compared with beef steers. Challenges include poorer feed efficiency, a lower dressing percentage, gut health issues, as well as carcasses that are light muscled and often too large (Grant et al., 1993). For these reasons, dairy-type steers are often undesirable for feedlots and packers. In December 2016, a major packer of Holsteins announced a decision to no longer harvest Holstein fed steers (Jibben, 2017; Schwehofer, 2017), furthering to decrease the value of the Holstein steer.

Advancements in technologies, such as sexed semen, allow producers to selectively produce replacement females from genetically superior females (Holden and Butler, 2018). This allows producers flexibility for breeding decisions for the remaining females in the herd. Some dairy producers are using beef semen to inseminate genetically inferior females, creating a beef-dairy cross animal, to potentially add value to the calves entering the beef chain (Gould and Lindquist, 2018; Scanavez and Mendonça, 2018; Penhorwood, 2019).

There have been developments by semen companies and breed associations to identify the ideal bulls as mates for dairy cows. Many of these programs focus selection criteria on fertility, calving ease, growth traits, and value indices (ABS, 2020; Alta, 2020; Genex, 2020; Select Sires, 2019). In 2019, Holstein USA and the American Simmental Association partnered to create a marketing program, HOLSIm, for Holstein, Simmental crossed calves (Bechtel, 2020). During the summer of 2020, the American Angus Association released two value indices ranking Angus bulls for use on either Holstein or Jersey cows (American Angus Association, 2020). The use of beef semen in dairy cows is resulting in unprecedented changes in both the dairy and beef industries.

As more beef-dairy calves enter the market, opportunities to measure the value of the beef-dairy cross calves exist. The objectives of this study were to determine 1) the relative value of Holstein feeder steer lots compared with the steer lots of other breed descriptions, and 2) the value of beef-dairy crosses compared with other breed combinations on the sale price of lots of calves sold through Superior Livestock Auction video auctions.

Materials and Methods

Data Collection

Approval for this research by an Institutional Animal Care and Use Committee was not needed given the nature of the records and data used for analyses.

Feeder Steer Lots

Information describing factors about feeder steer lots sold through a livestock video auction service (Superior Livestock Auction, Fort Worth, TX) was obtained from the auction service in an electronic format. Data obtained included descriptions of the lots of feeder steers provided by the seller and a representative of the livestock auction service. These data were collected for lots of feeder steers sold from 2010 through 2018. The seller and sales representative determined the type of steers in a lot (calves vs. feeders).

Descriptive information available for each lot of feeder steers were auction year, area of the United States where lot originated, breed description of lot, health protocol administered to the lot, the amount of weight variation within the lot, frame score of the lot, flesh score of the lot, implant status, Source and Age Verification, freight adjustment status, whether the steers had horns, lot size, base weight of the lot, the number of days between auction and forecasted delivery dates, and sale price of the lot (\$/45.36 kg). The specific and current requirements of each of the

video auction service's special health and management programs are available at www.SuperiorLivestock.com.

Data provided by the livestock auction service included breed descriptions for each lot. A lot breed description was developed between the seller and a representative for the auction service. We subsequently categorized each lot of feeder steers into one of four breed groups: 1) English-English cross with no Brahman influence, 2) English-Continental cross with no Brahman influence, 3) Brahman influenced, and 4) Holstein. Single gender lots of feeder steers were included in the analyses. Lots of mixed gender or lots of heifer feeder cattle were excluded from the analysis because of the lack of mixed gender and heifer-only Holstein lots.

To determine potential change in relative value of Holstein feeder steer lots from 2010 through 2018, data were analyzed in three-year increments. The year increments included 1) 2010 to 2012, 2) 2013 to 2015, and 3) 2016 to 2018.

Steer Calf Lots

Information describing lots of weaned steer calves sold during the summer of 2020 was collected via the sale catalogs provided by the auction service. The sale price of the lot was collected by viewing the sale results on the auction service's Internet site and recording the sale price of each lot. Lots of beef calves were sold in the auction services video auctions. Lots of Holstein steers were sold through a special video sale, Holstein steer and dairy auctions. Holstein steer auctions that were either one week prior or one week after the catalog sales were used to obtain the data for the Holstein steers in the 2020 study.

The descriptive pieces of information collected for each lot of weaned steer calves were auction date, number of calves, base weight, geographical region of the United States where the lot originated, breed description, value-added health protocol used, weight variation within the lot,

frame score of the calves, flesh score of the calves, presence of horns, whether the calves had been implanted with a growth-promoting implant, qualified for the Verified Natural Beef program, whether the lot qualified for a USDA approved Age and Source Verification program, whether the lot qualified for one of the Superior Natural programs, the slide type and weight stop combination, if the lot was considered an oversized lot, whether the lot met the requirements for Beef Quality Assurance, qualified for the Global Animal Partnership GAP 4 program, qualified for the Black Angus Verified Beef program, whether the lot qualified for BeefCare, if enrolled in Superior Progressive Genetics program, whether the calves were tested to be free of being persistently infected with bovine viral diarrhea, the number of days between auction and planned delivery, if qualified for Top Dollar Angus program, whether the lots qualified for VitaFerm Raised program, and the sale price of the lot (\$/45.36 kg).

Data provided by the livestock auction service included breed descriptions for each lot. A lot breed description was determined by the seller working with a representative for the auction service. We subsequently categorized each lot of weaned steer calves into one of five breed groups: 1) English-English cross with no Brahman influence, 2) English-Continental cross with no Brahman influence, 3) Brahman influenced, 4) Beef-dairy cross, and 5) Holstein. Single-gender lots of weaned steer calves were included in the analyses. Mixed gender and heifer calf lots were excluded from the analysis because few mixed gender and heifer-only Holstein lots were sold. Only weaned steers were included in the analysis because the beef-dairy cross lots and Holstein lots were weaned.

Statistical Analyses

Analyses were performed within lot type, feeder steers or steer calves, and steer lot was the unit of study.

The fixed effects for feeder steer lots included in the original multiple regression models were 1) auction year, 2) geographical region of lot origin, 3) health protocol administered to the lot, 4) amount of weight variation within the lot, 5) breed description, 6) frame score, 7) flesh score, 8) presence of horns, 9) implant status, 10) Source and Age Verification, 11) freight adjustment status, 12) size of lot (linear term), 13) size of lot (quadratic term), 14) base weight (linear term), 15) base weight (quadratic term), and 16) number of days between auction and planned delivery.

The fixed effects for weaned steer calf lots included in the original multiple regression model were 1) auction date, 2) geographical region of lot origin, 3) health protocol administered to the lot, 4) amount of weight variation within the lot, 5) breed description, 6) frame score, 7) flesh score, 8) presence of horns, 9) implant status, 10) Source and Age Verification, 11) Bovine Viral Diarrhea Persistently Infected Free program, 12) qualified for one of the Superior Natural programs, 13) BeefCare program, 14) Beef Quality Assurance program, 15) Superior progressive Genetics status, 16) slide and weight stop combination, 17) Top Dollar Angus program, 18) VitaFerm Raised program, 19) freight adjustment status, 20) Verified Natural Beef program, 21) Global Animal Partnership GAP 4 program, 22) Black Angus Verified Beef program, 23) size of lot (linear term), 24) size of lot (quadratic term), 25) base weight (linear term), 26) base weight (quadratic term), and 27) number of days between auction and planned delivery. Non-Hormone Treated Cattle program was not included in the original model because it was almost totally confounded with Verified Natural Beef program.

Separate multiple-regression models were developed using a backward selection procedure to quantify the effects of factors on the sale price of either feeder steer lots or lots of calves (Kleinbaum et al., 1988). At each step of the backward selection procedure, the variable with the

largest nonsignificant P -value was removed from the model. The MIXED procedure of SAS (version 9.4, SAS Institute Inc., Cary, NC) was used for the analyses. The feeder steer model was adjusted for the random effect of auction date nested within auction year. A value of $P < 0.05$ was required for a fixed effect to remain in the model. To prevent multicollinearity between the linear and quadratic terms (base weight and number of head), each of these two factors was centered at zero by subtracting the overall means of the factor from the value of that factor for each lot (King et al., 2006).

Results and Discussion

Non-adjusted means, standard deviations, medians, and ranges of continuous variables describing lots of feeder steers and lots of steer calves are summarized in Table 4.1 and Table 4.2, respectively. The effect of breed description on the sale price of lots of feeder steers is presented in Table 4.3. The non-adjusted mean sale price of Holstein feeder steer lots and the percentage discount for three-year increments is presented in Table 4.4. The effects of breed description on the sale price of lots of weaned steers are presented in Table 4.5.

Feeder Steer Lots

Data were analyzed from 14,075 lots of feeder steers sold via 211 video auctions through Superior Livestock Auction from 2010 through 2018. Mean weight and number of steers in lots analyzed were 363.2 ± 50.6 kg of BW and 121.1 ± 110.3 head, respectively (Table 4.1).

Of the 16 fixed effects, 15 were significant and included in the final model for lots of feeder steers sold from 2010 through 2018. The presence of horns did not affect sale price ($P = 0.43$).

From 2010 through 2018, English-English cross feeder steer lots sold for the greatest ($P < 0.05$) sale price (\$152.39/45.36 kg of BW; Table 4.3). English-Continental cross feeder steer lots

sold for the second greatest ($P < 0.05$) sale price (\$150.61/45.36 kg of BW). Brahman influenced feeder steer lots sold for the third greatest ($P < 0.05$) sale price (\$148.75/45.36 kg of BW). Holstein lots of feeder steers sold for the lowest ($P < 0.05$) sale price (\$110.56/45.36 kg of BW).

To determine potential change in relative value of Holstein feeder steer lots from 2010 through 2018, data were analyzed in three-year increments. A separate analysis was performed for each three-year increment. For 2010 through 2012, of the 16 fixed effects, 14 were significant and included in the final model. Implant status ($P = 0.68$) and freight adjustment status ($P = 0.14$) did not affect sale price for lots sold from 2010 through 2012. For the second three-year increment, 2013 through 2015, of the 16 fixed effects, 13 were significant and included in the final model. The presence of horns ($P = 0.27$), frame score ($P = 0.07$), and freight adjustment status ($P = 0.054$) did not affect sale price in the second-year increment. The third-year increment, 2015 through 2018, included 8 fixed effects in the final model. Health protocol ($P = 0.16$), presence of horns ($P = 0.08$), frame score ($P = 0.13$), implant status ($P = 0.88$), freight adjustment status ($P = 0.21$), the quadratic effect of base weight ($P = 0.93$), and number of days between auction and planned delivery ($P = 0.33$) did not affect sale price for year increment 2015 through 2018.

In all three-year increments, Holstein feeder lots sold for the lowest ($P < 0.05$) sale price compared to the other breed descriptions of beef steer lots (Table 4.3). The mean discount of Holstein feeder steer lots relative to other breed descriptions was \$33.19/45.36 kg of BW in 2010 through 2012, \$42.96/45.36 kg of BW in 2013 through 2015, and was the greatest in 2016 through 2018 at a mean discount of \$46.24/45.36 kg of BW.

In each successive three-year increment, there was a greater relative price discount for Holstein feeder steer lots than the previous year group. Evaluation of the mean sale price based on a percentage discount revealed in lower market prices, lots of Holstein feeders were discounted a

greater percentage than when market prices were higher. From 2010 through 2012, the mean sale price for lots of feeder steers was \$123.21/45.36 kg of BW and lots of Holstein feeder steers were discounted 26.9% (Table 4.4). From 2013 through 2015, the mean sale price was \$176.62/45.36 kg of BW and lots of Holstein feeder steers were discounted 24.3%. From 2016 through 2018, the mean sale price was \$139.13/45.36 kg of BW and a 33.2% discount for lots of Holstein feeder steers.

As the supply for beef increases, buyers have the ability to be more selective with their purchases, meaning there can be a greater discount for cattle with less demand such as the Holstein steer. Holstein steers have historically had a lower value than beef steers because of inefficiency in the feedyard (Ledbetter, 2018). Holstein steers are less feed efficient, have a six to eight percent lower dressing percentage, and spend more days on feed to a final end point than beef steers (Grant et al., 1993). Holstein steers also have a heavier mature weight and larger frame size, resulting in a larger carcass, which is undesired by feedyards and packers (Grant et al, 1993). In December 2016, a major packer announced a decision to no longer harvest Holstein steers (Jibben, 2017; Schweihofer, 2017) which lead to further devaluation. Industry decisions like this influence many segments of beef production, and likely is related to the relative price discounts of Holstein feeder steer compared with beef steers.

Advancements in technologies, such as sexed semen, allow producers to selectively produce replacement females from genetically superior females (Holden and Butler, 2018). This allows producers flexibility for breeding decisions for the remaining females in the herd. The discount for Holstein lots and the lessening interest in feeding dairy-type steers has resulted in many dairy producers utilizing beef semen in lower quality dairy cows (Gould and Lindquist, 2018; Scanavez and Mendonça, 2018; Penhorwood, 2019). Domestic beef semen sales drastically

increased by 59% from 2017 to 2018, primarily as a result of use in dairy cows and heifers (Geiger, 2019). By inseminating genetically inferior dairy cows with beef semen, the offspring is a beef-dairy cross, potentially adding value to the calves entering the beef chain compared to a traditional Holstein steer (Gould and Lindquist, 2018; Scanavez and Mendonça, 2018; Penhorwood, 2019).

Steer Calf Lots

Data were analyzed from 589 lots of steer calves sold via six video auctions through Superior Livestock Auction in the summer of 2020. Mean weight and number of steer calves in lots analyzed was 277.52 ± 60.1 kg of BW and 121.4 ± 71.0 head, respectively (Table 4.2).

Of the 27 fixed effects, 11 were considered significant and included in the final model for lots of steer calves sold during the summer of 2020. Bovine Viral Diarrhea Persistently Infected Free program ($P = 0.86$), region of origin ($P = 0.85$), if qualified for one of the Superior Natural programs ($P = 0.71$), BeefCare program ($P = 0.71$), freight adjustment status ($P = 0.61$), Beef Quality Assurance program ($P = 0.61$), value-added health protocol ($P = 0.58$), Superior Progressive Genetics status ($P = 0.57$), Source and Age Verified ($P = 0.41$), slide and weight stop combination ($P = 0.37$), presence of horns ($P = 0.37$), implant status ($P = 0.37$), Top Dollar Angus program status ($P = 0.24$), flesh score ($P = 0.24$), VitaFerm Raised ($P = 0.18$), and the quadratic effect of lot size ($P = 0.19$) did not affect the sale price of lots of weaned steer calves.

During the summer of 2020, English-English cross lots of steer calves sold for the greatest ($P < 0.05$) sale price (\$168.28/45.36 kg of BW) compared with all other breed descriptions (Table 4.5). English-Continental cross steer calf lots sold for the second greatest ($P < 0.05$) sale price at \$164.01/45.36 kg of BW). Brahman-influenced lots of steer calves sold for the third greatest ($P < 0.05$) sale price (\$160.30/45.36 kg of BW) compared with all other breed descriptions. Beef-dairy cross lots of steer calves for a greater ($P < 0.05$) sale price (\$153.07/45.36 kg of BW) than Holstein

lots of steers calves, which sold for the lowest ($P < 0.05$) sale price (\$113.21/45.36 kg of BW) compared with all other breed descriptions.

The value of the beef-dairy cross steer lots was \$39.86/45.36 kg of BW greater than a Holstein steer lots. This indicates there is additional value for a beef-dairy cross steer compared with a Holstein steer. There have been estimations reported of the perceived value of a beef-dairy cross animal (Heslip, 2020; Myers, 2020), although there are no values reported in the literature for lots of weaned steers sold through video auction. The estimations of added value for a beef-dairy cross compared with a Holstein reported in popular press range from approximately \$100 to \$150 per head (Heslip, 2020; Myers, 2020).

As the beef-dairy cross segment of the industry continues to develop, there will be more research supporting the ideal beef breed, or type of bull, for dairy cows. There have been developments by semen companies and breed associations to identify the ideal bulls as mates for dairy cows. Many of these programs focus selection criteria on fertility, calving ease, growth traits, and value indices (ABS, 2020; Alta, 2020; Genex, 2020; Select Sires, 2019). During the summer of 2020, the American Angus Association released two value indices ranking Angus bulls for use on either Holstein or Jersey cows (American Angus Association, 2020).

There is also a marketing aspect to the beef-dairy cross. Many semen companies have created a branded program for calves produced from bulls in their lineup (ABS, 2020; Alta, 2020; Genex, 2020; Select Sires, 2019). In 2019, Holstein USA and the American Simmental Association partnered to create a marketing program, HOLSIm, for Holstein, Simmental cross calves (Bechtel, 2020).

The sire breed of the beef-dairy cross calves should be investigated in future studies. The animals included in these analyses represented semi-truck load lots as they were sold through a

video auction service. The value of the beef-dairy cross in this study represents a steer approximately at the weight of weaning for a traditional beef breed steer. The value of the beef-dairy cross at other stages of production need further investigation.

Applications

The use of beef semen in dairy cows is resulting in unprecedented changes in both the dairy and beef industries. The ideal criteria for a beef bull to be selected for mating to a dairy cow remains unclear. More research is needed to understand how the beef-dairy cross animal will perform through all segments of modern beef production. This study, however, found lots of beef-dairy cross steers not only had greater value than lots of Holstein steers, but were much closer in value to the traditional beef combinations. The fact that beef-dairy cross were close in value to beef breed combinations is likely to drive additional use beef semen in dairies.

Literature Cited

ABS. 2020. Beef InFocus. Accessed October 5, 2020. <https://www.absglobal.com/services/beef-infocus/>

Alta. 2020. Alta BULLSEYE. Accessed October 5, 2020. <https://us.altagenetics.com/beef/bullseye/>

American Angus Association. 2020. Angus-On-Dairy \$Value Indexes. Angus Genetics Inc. Accessed October 7, 2020. <http://www.angus.org/DairyIndex/DairyIndexSearchCriteria.aspx>

Bechtel, W. 2020. Holstein, Simmental Associations partner with beef-dairy cross program. Holstein Association USA. Accessed October 7, 2020. <http://www.holsteinusa.com/holsim/index.jsp>

Boetel, B. 2019. In the cattle markets: beef contribution in 2018 from dairy cattle. Drovers. Accessed October 5, 2020. <https://www.drovers.com/article/cattle-markets-beef-contribution-2018-dairy-cattle>

Fairbairn, C. A. and T. L. Felix. 2020. Crossbreeding dairy cattle to fit the beef market. PennState Extension. Accessed October 20, 2020. <https://extension.psu.edu/crossbreeding-dairy-cattle-to-fit-the-beef-market>

Geiger, C. 2019. Beef-on-dairy semen sales skyrocketed in 2018. Accessed October 7, 2020.
<https://hoards.com/article-25428-beef-on-dairy-semen-sales-skyrocketed-in-2018.html>

Genex. 2020. SHIFT beef x dairy program. Accessed October 7, 2020.
<https://genex.coop/dairy/beef-x-dairy/>

Gould, K., and J. Lindquist. 2018. Cross-breeding to optimize dairy beef production. Accessed October 5, 2020. <https://www.michfb.com/MI/cross-breeding-to-optimize-dairy-beef-production/>

Grant, R. J., R. Stock, and T. L. Mader. 1993. G93-1177 Feeding and managing Holstein steers. Historical Materials from University of Nebraska-Lincoln Extension. 444.

Heslip, N. 2020. Dairy beef cross market still developing. Brownfield Ag News for America. Accessed October 7, 2020. <https://brownfieldagnews.com/news/dairy-beef-cross-market-still-developing/>

Holden, S. A., and S. T. Butler. 2018. Review: Applications and benefits of sexed semen in dairy and beef herds. *Animal* 12:97-103. doi: 10.1017/S1751731118000721

Jibben, B. 2017. Large Holstein steer discounts seen as packers reduce slaughter. AG Web. Accessed October 7, 2020. <https://www.agweb.com/article/large-holstein-steer-discounts-seen-as-packers-reduce-slaughter-NAA-betsy-jibben>

- King, M. E., M. D. Salman, T. E. Wittum, K. G. Odde, J. T. Seeger, D. M. Grotelueschen, G. M. Rogers, and G. A. Quakenbush. 2006. Effect of certified health programs in the sale price of beef calves marketed through a livestock video auction service from 1995 through 2005. *J. Am. Vet. Med. Assoc.* 229:1389–1400. <https://doi.org/10.2460/javma.229.9.1389>
- Kleinbaum, D. G., L. L. Kupper, and K. E. Muller. 1988. Multiple regression analysis. Pages 102–123 in *Applied Regression Analysis and Other Multivariable Methods*. 2nd ed. PWS-Kent Publ. Co., Boston, MA.
- Ledbetter, K. 2018. Beef influence on dairy cattle could improve marketing options, profit. *Dairy Herd Management*. Accessed October 5, 2020. <https://www.dairyherd.com/article/beef-influence-dairy-cattle-could-improve-marketing-options-profit>
- Myers, V. G. 2020. Beef brings dairy a profit boost. *Progressive Farmer*. Accessed October 7, 2020. <https://www.dtnpf.com/agriculture/web/ag/news/article/2020/04/24/beef-dairy-cross-helps-increase-2>
- Penhorwood, J. 2019. Dairy a growing competitor for beef genetics. *Ohio Country Journal*. Accessed October 7, 2020. <https://www.ocj.com/2019/03/dairy-a-growing-competitor-for-beef-genetics/>

Scanavez, A. L. and L. G. Mendonça. 2018. Gestation length and overall performance in the subsequent lactation of dairy cows conceiving to Holstein, Jersey, or Angus semen: An observational study. Kansas Agricultural Experiment Station Research Reports 4:50-55. doi:10.4148/2378-5977.7713

Schweihofer, J. P. 2017. Comparing Holstein and beef breed cattle cutouts. Drovers. Accessed October 6, 2020. <https://www.drovers.com/article/comparing-holstein-and-beef-breed-cattle-cutouts>

Select Sires. 2019. Breeding to feeding. Accessed October 7, 2020. <http://selectsires.com/programs/breedingtofeeding.html?version=20180803>

Tables

Table 4.1 - Non-adjusted means, medians, and ranges for factors describing single-gender lots of feeder steers sold through 211 Superior Livestock Auction video sales from 2010 through 2018

Factor	Mean \pm SD	Median	Range
Number of steers in the lot	121.1 \pm 110.3	70	17 to 1,680
Base weight of the lot (kg)	363.2 \pm 50.6	374.2	99.8 to 580.6
Number of days from auction to forecasted delivery	30.8 \pm 38.2	15	0 to 287
Price per 45.36 kg (\$)	145.80 \pm 33.77	141.00	68.00 to 333.00

Table 4.2 - Non-adjusted means, medians, and ranges for factors describing weaned steer calf lots originating in either the Rocky Mountain/North Central or the South Central region that sold through six Superior Livestock Auction video sales in the summer of 2020

Factor	Mean \pm SD	Median	Range
Number of steers in the lot	121.4 \pm 71.0	95	31 to 600
Base weight of the lot (kg)	277.5 \pm 60.1	283.5	113.4 to 442.3
Number of days from auction to forecasted delivery	68.3 \pm 49.0	76	0 to 205
Price per 45.36 kg (\$)	151.52 \pm 19.93	152.00	81.00 to 228.00

Table 4.3 - Sale price of Holstein feeder steer lots relative to other breed descriptions sold through 211 Superior Livestock Auction video sales from 2010 through 2018

Breed Description	Number of lots	Least squares mean of sale price, \$/45.36 kg of BW	Regression coefficient
<u>2010 to 2018</u>			
English-English cross	3,829	152.39 ^a	41.83
English-Continental cross	4,310	150.61 ^b	40.05
Brahman Influenced	4,945	148.75 ^c	38.19
Holstein	991	110.56 ^d	0.00
<u>2010 to 2012</u>			
English-English cross	1,252	128.10 ^a	34.47
English-Continental cross	1,562	126.81 ^b	33.18
Brahman Influenced	2,185	125.56 ^c	31.93
Holstein	282	93.63 ^d	0.00
<u>2013 to 2015</u>			
English-English cross	1,171	182.43 ^a	44.82
English-Continental cross	1,485	180.46 ^b	42.85
Brahman Influenced	1,630	178.83 ^c	41.22
Holstein	373	137.61 ^d	0.00
<u>2016 to 2018</u>			
English-English cross	1,465	145.62 ^a	47.84
English-Continental cross	1,359	144.47 ^b	46.69
Brahman Influenced	1,283	141.97 ^c	44.19
Holstein	360	97.78 ^d	0.00

Breed description affected sale price ($P < 0.0001$).

^{a,b,c,d}Prices without a common superscript differ ($P < 0.05$) within years.

The models were adjusted for the random effect of auction date nested within auction year.

Table 4.4 - Non-adjusted mean sale price of Holstein feeder steer lots and the percentage discount as compared with English-English cross, English-Continental cross, and Brahman influenced steer lots for each three-year increment

Year Increment	Non-Adjusted Mean Sale Price (\$/45.36 kg)	Mean Discount (\$/45.36 kg)	Percentage Discount (%)
2010 to 2012	123.41	33.19	26.9
2013 to 2015	176.62	42.96	24.3
2016 to 2018	139.13	46.24	33.2

Table 4.5 - Effect of breed description on the sale price of weaned steer calf lots originating in either the Rocky Mountain/North Central or the South Central region that sold through six Superior Livestock Auction video sales in the summer of 2020

Breed Description	Number of lots	Least squares mean of sale price, \$/45.36 kg of BW	Regression coefficient
English-English cross	209	168.28 ^a	55.07
English-Continental cross	148	164.01 ^b	50.80
Brahman Influenced	95	160.30 ^c	47.09
Beef-Dairy cross	59	153.07 ^d	39.86
Holstein	78	113.21 ^e	0.00

^{a,b,c,d,e}Means within a factor without a common superscript differ (P < 0.05).

Appendix A - Tri-County Steer Carcass Futurity Cooperative – Rules and regulations, and health requirements

Tri-County Steer Carcass Futurity Cooperative Rules and Regulations

http://www.tcscf.com/2019_Iowa_Recruiting_Letter_Ver_1.pdf

1. Open to cow-calf producers throughout the United States of America. Sire or sire breed groups will be identified. Individual steer/heifer entries will be accepted which may be either home-raised or purchased. A farm may make as many entries as they would like.
2. An advance of half the value of the animal up to \$400 per head is available for a ten head minimum. Interest incurred will be the responsibility of the consignor. The TCSCF administrative office will need to be notified if an advance is requested by a consignor and the advance can be issued any time after the cattle are delivered. On a case by case basis we will consider additional amount after the on-test weights are collected, the health and performance of the consignment is acceptable. The total advance will not exceed 50% of the initial market value of the cattle.
3. At delivery, all steers/heifers will be double tagged. The original owner's ear tag will be documented and may be removed.
4. No bulls or stags allowed. No horns allowed.
5. Ownership will be transferred to TCSCF for \$5 per animal. All ownership rights are thus conveyed to, and steers/heifers become the property of TCSCF. This eliminates the need for a feed deposit. Death will be a loss to TCSCF and the former owner. Upon close out the \$5 fee will be returned to TCSCF and \$20 pen reservation fee will be returned to the producer along with all proceeds from sale of the calf less expenses.

6. Steers/heifers will be fed a warm-up ration for 28 days. They will be weighed on test at the end of warm-up. Steers/heifers will be placed on approximately 80% concentrate ration as soon as possible.
7. Steers/heifers will be weighed individually at least 4 times: upon delivery, start of test period, time of re-implant, and prior to harvest.
8. Steers/heifers will be harvested on at least two different dates five weeks apart, determined by the TCSCF Board.
9. The TCSCF Board reserves the right to disqualify any animal at any time if a problem arises with a steer/heifer entered in the program. Animals may be sold or returned to original owner upon reimbursement for expenses.
10. Calves should be born Feb 1 to June 15.
11. TCSCF would like to document birthdates, sire registration numbers, breed of sire and breed of dam.
12. Calves will be frame and muscle scored by USDA Market Reporter upon delivery.
13. The weight, sex, USDA muscle score & USDA frame score will be used to establish a beginning value of the calf.
14. Risk management is available upon request.

Health Protocol for Tri-County Steer Carcass Futurity Cooperative.

http://www.tcscf.com/Health_Protocol.pdf

Entries shall meet the following standards:

1. All calves shall be weaned a minimum of 30 days or more by the date of delivery
2. All bulls shall be castrated by knife or band (producers are encouraged to castrate preweaning)
3. All calves shall be treated for internal and external parasites (injectable anthelmintics or a combination of oral and injectable treatment are encouraged; preferably after weaning to avoid reinfection)
4. All cattle shall have horns removed (Producers are encouraged to dehorn preweaning)
5. All cattle should receive a total of two doses of modified live viral vaccine given preferably preweaning and at weaning, respectively.
 - a. Modified Live Virus
 - i. IBR-(Infectious Bovine Rhinotracheitis)
 - ii. BVD-(Bovine Viral Diarrhea Virus 2 types)
 - iii. PI3-(Parainfluenza) Not an important pathogen but always in virals)
 - iv. BRSV-(Bovine Respiratory Syncytial Virus)

Examples of viral vaccine are as follows: Express 5, Bovishield Gold 5, Pyramid 5, Vista 5, etc. Please consult your veterinarian before using MLV vaccine on calves nursing pregnant cows.
6. Pasteurella (Pasteurella multocida and Mannheimia hemolytica) vaccination is encouraged but not required and it is recommend to be administered preweaning. Please consult with your veterinarian about using these vaccines or vaccine combinations.

- a. Examples of Mannheimia - Pasteurella combination vaccines include: Presponse HM, Pulmoguard PHM-1, One Shot, etc.
7. 7-way blackleg with or without histophilus (2 doses required)
- a. Examples of Blackleg vaccine are as follows: Ultrabac7, Barvac7, Vision 7, etc.
Optional procedures/Biologicals
8. Not required for entry
- a. BVD Persistent Infection Ear Notch
 - i. Pen arrangements may be made prior to arrival of the cattle.
 - ii. Nasalgen, TSV-2, Inforce 3 intranasal at weaning

The best management plan is to work with your veterinarian to develop a complete herd health program.

Appendix B - Tri-County Steer Carcass Futurity Cooperative

Database

Description of the Iowa State University Tri-County Steer Carcass Futurity

Data 2002 through 2019

Source of data

Individual animal data were obtained from the ISU Tri-County Steer Carcass Futurity for beef calves that were harvested between 8/8/2002 and 7/23/2019. New records were added several times since the database was first created.

Total number of records

A total of 112,958 records are available in the database. Records that were deleted for analysis were those animals with one or more of the following criteria: on-test weight > 1000 pounds, sex equal to Cow, and Quality Grade equal to Commercial.

Live and carcass data 2002 through 2019

<u>Variable name</u>	<u>Variable description</u>
Order (LI)	Unique record ID number
RecordID (LI)	Unique record ID number assigned by TCSCF
Year (LI)	Year of study
Feedlot (T)	Name of the feedlot
FeedlotC (I)	Numeric code for each feedlot
Group (T)	Name of the feeding group – gives state(s), feedlot name, arrival month, and group sex
GroupC (LI)	Numeric code for each group
OState (T)	State or states of origin
OStateC (I)	Numeric code for state of origin
Producer (T)	Producer's name
ProdCode (T)	Numeric code for each producer assigned by TCSCF

Owner (T)	Name of the owner
SexC (I)	Numeric code for sex 1=steers 2=heifers 3=bull 4=cow 5=replacement heifer
TagColor (T)	Color of futurity ear tag
FTag (T)	Futurity tag number
SBreed (T)	Breed description of sire
SBreedC (I)	Numeric code for sire breed 1 = English, English crosses 2 = Continental, Continental crosses 3 = English-Continental crosses 4 = English crosses with Brahman influence 5 = Continental crosses with Brahman influence 6 = English-Continental crosses with Brahman influence 7 = Primarily Brahman 8 = Longhorn or Corriente crosses 9 = Dairy crosses 10 = Black and BWF 11 = Red and RWF 12 = Mixed colors 14 = Black and BWF with Brahman influence 15 = Red and RWF with Brahman influence 17 = Angus 18 = Hereford 19 = Red Angus 20 = Charolais 21 = Simmental 22 =SimAngus
SireBRD (I)	Used to identify specific sire breeds. 1=AN, 2=SM, 3=GV, 4=CH, 5=BN, 6=AR, 7=HE, 8=LM, 9=Eng X, 10=Cont X, 11=Eng X Cont, 12=Eared breeds, 13=Dairy X
SireID (T)	ID number or name of sire
SireName (T)	Name of the calf's sire
PANSire (S)	Percent Angus of sire based on SBreed
PARSire (S)	Percent Red Angus of sire based on SBreed
DBreed (T)	Breed description of dam
DamID (T)	ID number of dam

DBreedC (I)	Numeric code for dam breed 1 = English, English crosses 2 = Continental, Continental crosses 3 = English-Continental crosses 4 = English crosses with Brahman influence 5 = Continental crosses with Brahman influence 6 = English-Continental crosses with Brahman influence 7 = Primarily Brahman 8 = Longhorn or Corriente crosses 9 = Dairy crosses 10 = Black and BWF 11 = Red and RWF 12 = Mixed colors 14 = Black and BWF with Brahman influence 15 = Red and RWF with Brahman influence 17 = Angus 18 = Hereford 19 = Red Angus 20 = Charolais 21 = Simmental
PANDam (S)	Percent Angus of dam based on DBreed
PARDam (S)	Percent Red Angus of dam based on DBreed
Color (T)	Calf hide color
ColorC (I)	Calf hide color codes 1=Black, 10=BWF, 2=Red, 20=RWF, 3=White, 4=Grey or GWF, 5=Brown or BRNWF, 6=Tan, 7=Yellow, 50=Other
Breed (I)	Numeric code for calf breed 1 = English, English crosses 2 = Continental, Continental crosses 3 = English-Continental crosses 4 = English crosses with Brahman influence 5 = Continental crosses with Brahman influence 6 = English-Continental crosses with Brahman influence 7 = Primarily Brahman 8 = Longhorn or Corriente crosses 9 = Dairy crosses 10 = Black and BWF 11 = Red and RWF 12 = Mixed colors 14 = Black and BWF with Brahman influence 15 = Red and RWF with Brahman influence 17 = Angus 18 = Hereford 19 = Red Angus 20 = Charolais 21 = Simmental

SCBREED	If a calf is straight bred or cross bred 1 = straight bred 2 = crossbred
PANgus (S)	Percent Angus of calf ($[PANSIRE] + [PANDAM] / 2$)
PAnGroup (I)	Percent Angus of calf classes 1=0 to 25, 2= 26 to 50, 3=51 to 75, 4= 76 to 100
PAR (S)	Percent Red Angus of calf ($[PARSire] + [PARDam] / 2$)
ARGroup (I)	Groups based on percent Red Angus of the calf 1 = 0 to 24% 2 = 25 to 49% 3 = 50 to 74% 4 = 75 to 100%
BirthD (Date)	Calf birth date
WDate (Date)	Weaning date
DDate (Date)	Delivery date
DYear (LI)	Delivery year
DelMonth (I)	Delivery month
OnTDate (Date)	On-test date
RIDate (Date)	Reimplant date
LWDate (Date)	Last weigh date or harvest date
HDate (Date)	Harvest date
HYear (LI)	Harvest year
HMonth (I)	Harvest month
S1Date (Date)	Date of first slaughter sort
S2Date (Date)	Date of second slaughter sort
S3Date (Date)	Date of third slaughter sort
S4Date (Date)	Date of fourth slaughter sort
HWeight (D)	Home weight
DWeight (D)	Delivery weight
Shrink (D)	Shrink from home to test as a decimal $([DWeight] - [HWeight]) / [HWeight]$
OTWeight (D)	On-test weight (for analysis, I deleted all with >1000 pounds)
RIWeight (D)	Reimplant weight
H1Weight (D)	Weight at 1 st harvest
H2Weight (D)	Weight at 2 nd harvest
H3Weight (D)	Weight at 3 rd harvest
H4Weight (D)	Weight at 4 th harvest
FWeight (D)	Actual final weight
Reason (T)	Combined reason for sorting calf at slaughter Fat cover was primary reason for sort (C) Frame was primary reason for sort (F) Gain was primary reason for sort (G) Heavy was primary reason for sort (H) Light was primary reason for sort (L) Disposition was primary reason for sort (D) There were other reasons and combinations of reasons for sort

KGroup (D)	1 = First kill group 2 = Second kill group 3 = Third kill group 4 = Fourth kill group 5 = Feeder 6 = Home 7 = Locker 8 = Insurance 9 = Locker from 2002 through 2014, = Breeding stock in the most recent data 10 = Dead 11 = Condemned There are other decimal values that I am not sure what they mean
WeanAge (S)	Age in days at weaning, [WDate]-[BirthD]
DelAge (S)	Age in days at delivery, [DDate]-[BirthD]
OtestAge (S)	Age in days at start of test, [OnTDate]-[BirthD]
HAge (S)	Age in days at harvest, [HDate]-[BirthD]
Frame (T)	Frame score description
FrameC (LI)	Frame score codes
Muscle (T)	Muscling score description
MuscleC (LI)	Muscling score codes
DBCS (D)	Delivery body condition score of calf
Mud1(D)	Mud score of the calve at first slaughter sort 1 = No tag, clean hide 2 = Small lumps attached to the hide in limited areas of the legs and underbelly 3 = small and large lumps attached to the hide covering larger areas of the legs, side and underbelly 4 = small and large lumps of manure attached to the hide in even larger areas along the hind quarter, stomach, and front shoulder 5 = lumps of manure attached to the hide continuously on the underbelly and side of the animal from brisket to rear quarter
Mud2 (D)	Mud score of the calve at second slaughter sort
Mud3 (D)	Mud score of the calve at third slaughter sort
MudFS (D)	Mud score of the calve at final sort
MudA (D)	Average mud score of the calf
DispOT (D)	Disposition on-test (1=gentle to 6=wild)
DispRI (D)	Disposition at reimplant
DispFS (D)	Disposition at first sort
Disp2K (D)	Disposition at second kill
DispFK (D)	Disposition at final kill
DispAve (S)	Average disposition score
Docile (B)	Average disposition score < 3 0 = No 1 = Yes

Wild (B)	Average disposition score ≥ 3 and < 5 0 = No 1 = Yes
Aggres (B)	Average disposition score ≥ 5 0 = No 1 = Yes
DaysWean (D)	The number of days weaned at delivery, [DDate]-[WDate]
Wean30 (B)	Were calves weaned less than 30 days at delivery 0 = No 1 = Yes
Wean3060 (B)	Were calves weaned between 30 and 60 days at delivery 0 = No 1 = Yes
Wean61 (B)	Were calves weaned greater than 60 days at delivery 0 = No 1 = Yes
DOnFeed (S)	A calculated variable = [HDate]-[DDate], calculates days on feed for those calves that finished the study and were slaughtered
DOnTest (S)	A calculated variable = [HDate]-[OnTDate], calculates days on test for those calves that finished the study and were slaughtered
WarmADG (D)	Warm-up ADG
TestADG (D)	Test period ADG
OADG (D)	Overall ADG
RealOADG (D)	Actual ADG ($[FWeight] - [DWeight] / [DonFeed]$)
FtoG (D)	Pounds of feed per pound of gain
CostOG (D)	Total cost (\$) per 100 pounds of gain
FeedCOG (D)	Total cost of feed (\$) per 100 pounds of gain
RCost (D)	Ration cost (\$/ton of dry matter)
DWPDA (S)	Weight per day of age at delivery, $[DWeight] / [DelAge]$
OTWPDA (S)	Weight per day of age at start of test, $[OTWeight] / [OTestAge]$
HWPDA (S)	Weight per day of age at harvest, $[FWeight] / [HAge]$
WPDA (D)	AFWEIGHT/AGE (at harvest), similar to HWPDA, TCSCF calculated the adjusted final weight (AFWEIGHT)
TRT (I)	Number of treatments for disease conditions
TRTGroup (I)	Number of treatments for disease classes 0 = no treatments 1 = 1 treatment 2 = 2 or more treatments
Morb (B)	Morbidity 0 = no morbidity 1 = one or more cases of morbidity
ITRTRCost (D)	Individual animal treatment cost for disease conditions
CostPTRT (D)	Individual animal treatment cost per treatment $[ITRTRCost] / [TRT]$ for animals that were treated at least one time

GTRTCost (D)	Group health cost (implants, vaccinations, Optaflexx, parasite control)
MedCost (S)	Total medical cost, [ITRTCOST] + [GTRTCOST]
Mortal (B)	Mortality during the test 0 = No 1 = Yes
Disease (T)	Name of the disease or condition that caused death or leaving the futurity
CABLiveC (B)	Did calf qualify for CAB based on hide color 0 = No 1 = Yes
CABNew (B)	Did the carcass qualify for CAB based on the new CAB criteria CABLiveC = 1 HotCWT < 1000 Fat < 1.0 REA between 10.0 and 16.0 MarbAdj >= 500 DCutter = 0 Hbone = 0 0 = No 1 = Yes
HotCWT (D)	Hot carcass weight
CWTC (I)	Variable to categorize hot carcass weight 1 = <600 2 = 600 to 699 3 = 700 to 799 4 = 800 to 899 5 = 900 to 999 6 = >999
DPercent (D)	Dressing percent, multiply values by 100 to convert decimal to percent
DPClass (I)	Classes for dressing percent 1 = < 57 2 = >=57 and < 58 3 = >= 58 and < 59 4 = >= 59 and < 60 5 = >= 60 and < 61 6 = >= 61 and < 62 7 = >= 62 and < 63 8 = >= 63
Fat (D)	Carcass back fat

FatClass (I)

Classes for fat

- 1 = < .20
- 2 = .20 to .24
- 3 = .25 to .29
- 4 = .30 to .34
- 5 = .35 to .39
- 6 = .40 to .44
- 7 = .45 to .49
- 8 = .50 to .54
- 9 = .55 to .59
- 10 = .60 to .64
- 11 = .65 to .69
- 12 = .70 to .74
- 13 = .75 to .79
- 14 = .80 to .84
- 15 = .85 to .89
- 16 = .90 to .94
- 17 = .95 to .99
- 18 = >= 1.0

REA (D)

Ribeye area

REAClass (I)

Classes for REA

- 1 = < 7.0
- 2 = 7.0 to 7.9
- 3 = 8.0 to 8.9
- 4 = 9.0 to 9.9
- 5 = 10.0 to 10.9
- 6 = 11.0 to 11.9
- 7 = 12.0 to 12.9
- 8 = 13.0 to 13.9
- 9 = 14.0 to 14.9
- 10 = 15.0 to 15.9
- 11 = 16.0 to 16.9
- 12 = 17.0 to 17.9
- 13 = 18.0 to 18.9
- 14 = 19.0 to 19.9
- 15 = > 19.9

REACWT (D)

Ribeye area/100 pounds hot carcass weight, [REA]/[HotCWT]*100

REACWTC (I)

Categorize REACWT (REA per 100 pounds of hot carcass weight)

- 1 = <1.39
- 2 = >= 1.39 to <1.49
- 3 = >= 1.49 to < 1.59
- 4 = >= 1.59 to < 1.69
- 5 = >= 1.69 to < 1.79
- 6 = >= 1.79 to < 1.89
- 7 = >= 1.89 to < 1.99
- 8 = >= 1.99

KPH (D)	Percent kidney, pelvic, and heart fat
CYG (D)	Calculated yield grade
CYGClass (I)	YGs 1-5 based on calculated yield grade
USDAYG (I)	Called USDA Yield Grade
RProduct (D)	Percent retail product
PlantQG (T)	Plant Quality Grades A=Prime, B=Choice, C=Select, D=B maturity (>30 months), E=Standard, F=Commercial (hard bone), G=Standard, I=Dark cutters, J=Blood shots (calves that were stunned incorrectly and died before they were bled and had bloodshot in the ribeye)
Marbling (T)	Text description of marbling score
MNumber (D)	Marbling number
MarbADJ (D)	Adjusted marbling score to conform to TIPS values [MNumber] – 600
QGrade (T)	Text description of USDA Quality Grade
QGradeC (I)	Quality Grade codes 1=P+, 2=P, 3=P-, 4=Ch+, 5=Ch, 6=Ch-, 7=Sel+, 8=Sel-, 9= Std+, 10=Std, 11=Std-, 12=Comm
Prime (B)	Prime, 1=Yes 0=No, based on QGradeC
UChoice (B)	Upper 2/3 Choice, 1=Yes 0=No, based on QGradeC
LChoice (B)	Lower 1/3 Choice, 1=Yes 0=No, based on QGradeC
AllCH (B)	All Choice, 1 = Yes 0 = No, based on QGradeC
CHandUP (B)	Low Choice and above, 1 = Yes 0 = No based on QGradeC
SelectT (B)	Select, 1=Yes 0=No, based on QGradeC
Stand (B)	Standard, 1=Yes 0=No, based on QGradeC
OffGrade (B)	Was the carcass a Hardbone but given an inappropriate QG 0 = No 1 = Yes
DCutter (B)	Dark cutters where PlantQG = B/I or I, 0=No, 1=Yes
HBone (B)	Hard bone where PlantQG=F, 0=No, 1=Yes
Condemn (B)	Was the carcass condemned 0 = No 1 = Yes
YG12 (B)	Yield Grade 1 or 2, 1=Yes 0=No, based on CYGClass
YG3 (B)	Yield Grade 3, 1=Yes 0=No, based on CYGClass
YG45 (B)	Yield Grade 4 or 5, 1=Yes 0=No, based on CYGClass
TrimCode (B)	Was tissue trimmed from the carcass 0 = No 1 = Yes
Trim (D)	Pounds of trim – based on Defects
TrimCost (D)	Dollar value loss of pounds of trim
CDel (T)	Comments at delivery
COnTest (T)	Comments on-test
CRImplant (T)	Comments at reimplant
C1Kill (T)	Comments at first kill
C2Kill (T)	Comments at second kill

C3Kill (T)	Comments at third kill
Defects (T)	Carcass defects
LungSCR (T)	Some kind of a lung scoring scale (need to check with Matt about what the values mean)
FleshSCR (T)	Some kind of a flesh scoring scale (need to check with Matt about what the values mean)
SDark (B)	Was the carcass slightly dark 0 = No 1 = Yes
Swab (B)	Was a swab taken (not sure what was swabbed) 0 = No 1 = Yes
Lung (B)	Did calf have lung lesions – based on Defects 0 = No 1 = Yes
Dairy (B)	Did calf have dairy conformation – based on Defects 0 = No 1 = Yes
RatTail (B)	Did calf have a rat tail – based on Defects and comment variables 0 = No 1 = Yes
BadEyes (B)	Did calf have bad eyes – based on Defects and comment variables 0 = No 1 = Yes
Horns (B)	Did the calf have horns 0 = No 1 = Yes
Over30M (B)	Was the calf over 30 months of age at the time of harvest 0 = No 1 = Yes
Preg (B)	Was the calf pregnant at the time of harvest 0 = No 1 = Yes
Blood (B)	Did the carcass have bloodshot in ribeye 0 = No 1 = Yes
REAOOut (B)	Was the REA outside of the CAB standards 0 = No 1 = Yes
Death (T)	Variable to record deaths and reasons the animal left the futurity early based on information in the HDate field of the original Excel file
Insure (B)	Was insurance money paid for calf 0 = No 1 = Yes

Locker (B)

Did calf go to locker for harvest

0 = No

1 = Yes

Feeder (B)

Was calf sold before end of test to a sale barn or locker

0 = No

1 = Yes

Additional variables and costs 2002 through 2019

<u>Variable name</u>	<u>Variable description</u>
Order (LI)	Unique record ID number
RecordID (LI)	Unique record ID number assigned by TCSCF
Year (LI)	Year of study
DMonth (T)	Month that the calf was delivered
Riskmgmt(T)	1=Yes 2=No There are other values that I am unsure what they mean
SireGroup (I)	Breed of sire of the calf 1 = Angus sired 2 = Red Angus sired 3 = All other sire breeds
PAngus2 (B)	Groups based on percent Angus of the calf 1 = 0 to 49 2 = 50 3 = 51 to 100
DAge (D)	Age of dam
DamWT (D)	Weight of dam
DFrame (T)	Frame score of dam
DamBCS (D)	Body condition score of dam
DCI (D)	Dam calving interval
GBirthD (Date)	Birth date of a group
Age (D)	Calf age in days at harvest, same as HAge with a few exceptions
DOF (D)	Days on feed DOF and DOT may not be accurate since several delivery dates and on-test dates were not correct. Use DOnFeed and DOnTest instead.
DOT (D)	Days on test
ADGRatio (D)	ADG ratio
WPDAR (D)	Weight per day of age ratio
LotNumb (T)	Lot number
PlantID (T)	Packing plant ID number
ABCPrice (D)	Average base carcass price (\$/cwt)
YGP1(D)	Yield grade premium 1 (\$/cwt)
CABP1(D)	CAB premium 1 (\$/cwt)
PrimeP1(D)	Prime premium 1 (\$/cwt)
ACPrice (D)	Average carcass price – sum of the above four values (\$/cwt)
CABPYN (B)	CAB premium 0 = No 1 = Yes
RVDOT (D)	Retail value/days on test
RVDOTR (T)	Retail value/days on test rank
RVDOA (D)	Retail value/day of age
RVDOAR (T)	Retail value/day of age rank

BCPrice (D)	Base carcass price (\$/cwt)
YGP2 (D)	Yield Grade premium2 (\$/cwt)
CABP2 (D)	CAB premium 2 (\$/cwt)
PrimeP2 (D)	Prime premium 2 (\$/cwt)
AVCPrice (D)	Actual carcass price – sum of above four values (\$/cwt)
CHP (D)	Certified Hereford premium (\$/cwt)
Income (D)	?Amount received for carcass or animal
PenFee (D)	Pen fee
RiskMI (D)	Risk management income
TFeed (D)	Calculated total pounds of feed consumed on DM basis
FeedCost (D)	Feed cost
ITRTCost (D)	Individual animal treatment cost for disease conditions
GTRTCost (D)	Group health cost (implants, vaccinations, Optaflexx, parasite control)
MedCost (S)	Total medical cost, [ITRTCost] + [GTRTCost]
Yardage (D)	Yardage cost
MiscCost (D)	Interest, tags, insurance
Trucking (D)	Trucking to Iowa
THarvest(D)	Trucking to harvest, insurance, checkoff
PPrice (D)	?Cost associated with purchase of animal
DataFee (D)	Data collection fee
AandI (D)	Advance and interest
TDue (D)	Amount due
DValue (D)	Gross value/CWT on delivery day
DPrice (D)	Market price/CWT on delivery day
DTVValue (D)	Market value/head on delivery day
Profit (D)	Profit or loss for calf during the test
CostOG (D)	Total cost (\$) per 100 pounds of gain
FeedCOG (D)	Total cost of feed (\$) per 100 pounds of gain
EID (T)	E-ID of the calf
ARTag (T)	Red Angus ear tag number
IMarbling (T)	Initial marbling score
Grader (T)	Name of the grader and other information about the carcass
State (T)	State of origin, only one state is recorded for groups that originated from several states
SireBRC (I)	1= Angus, 2= other English breeds, 3= Continental breeds, 4= eared breeds, 5= dairy X
NoTreat (B)	Calf was never treated for a disease condition 0 = No 1 = Yes
Treat1 (B)	Calf was treated once for a disease condition 0 = No 1 = Yes
Treat2 (B)	Calf was treated two or more times for a disease condition 0 = No 1 = Yes

RCost (D)	Ration cost (\$/ton of dry matter)
TrimCost (D)	Dollar value loss of pounds of trim
RtoCow (D)	The amount of money returned to the cow
CostPTRT (D)	Individual animal treatment cost per treatment [ITRTCost]/[TRT] for animals that were treated at least one time
Profit2 (D)	A second measure of the profit of the calf

Appendix C - Superior Livestock Auction - History of the project 1995 through 2020

History of the Superior Livestock Auction project 1995 through 2020

In 1995, Pfizer Animal Health in cooperation with Colorado State University began collecting and storing data in a computer database that described lots of beef cattle that were offered for sale in the Superior Livestock Auction's video sales. A separate database was created for each year of the study. Initially, these data were obtained from the Superior Livestock Auction's sales catalogs that provided a detailed written description of each lot of cattle consigned to each video auction, and these data were entered manually into the databases from 1995 through 2009. Pfizer Animal Health funded this project from 1995 through 2012.

The primary objective at the beginning of the project was to quantify the effects of the health protocols of Superior Livestock Auction's Value-Added Calf (VAC) health program on the sale price of beef cattle while adjusting for all other factors that significantly affected the price of the cattle. Initially, the VAC health program consisted of four health protocols: VAC 24, VAC 34, VAC 45, and VAC PreCon. In 2008, the VAC 34+ protocol was added to the program. The VAC 45+ protocol was added in 2012. The management and vaccination requirements for each of these health protocols have remained essentially the same throughout the study years with only minor changes being made. The current requirements for each health protocol are available at www.superiorlivestock.com/value-added-programs/superior-vaccination-programs.

Superior Livestock Auction has been an industry leader in developing health and management programs designed to increase the value of beef cattle. They have also identified in their sale catalogs lots of cattle that qualified for programs created by other groups. The Certified Natural program was introduced by Superior in 2004. For a lot of cattle to qualify for this program,

the seller of the cattle must complete and sign a Certified Natural consignment affidavit verifying that the cattle have never received and will not receive the following: A. Ionophores-Rumensin, Bovatec, Cattlyst, or Gain-Pro, B. Antibiotics and/or Sulfas fed or injected-Aureomycin, Nuflor, Draxxin, CTC, or Albon, C. Growth promoting hormones/steroids fed, oral, or injected-Revalor, MGA, Lutalyse, Ralgro, or Dexamethasone, D. Beta Adrenoceptor-agonist fed or injected-Optaflexx, and E. Any type of animal by-product in feedstuffs, mineral supplements, or feed tubs- fish oil, milk replacers, animal fat, feather meal, poultry litter, yellow grease, or any type of by-product from fish, birds, or mammals. This list of prohibited products was not limited to only the examples given. The seller must review all feedstuffs, minerals, and supplements for actual ingredient content before signing the affidavit. The seller must also certify that he/she/it was the original owner of the consigned cattle or supply a signed “all natural” certification from the original owner. Any cattle that received therapeutic treatment must be individually identified and not shipped without the buyer’s permission.

Lots of beef cattle that were Source and Age Verified were first identified in the Superior catalogs in 2005. In order for lots of cattle to qualify for this program, the seller had to complete and sign an affidavit certifying that the cattle were enrolled in a USDA approved Source and Age Verification program and have program compliant ear tags. The name of the Source and Age Verification program was recorded in the databases.

Superior offered two new programs to their consignors in 2008: the Bovine Viral Diarrhea-Persistently Infected (BVD-PI) Free and the Non-Hormone Treated Cattle (NHTC) programs. For a lot of cattle to be identified as being in the BVD-PI Free program, the cattle had to be documented to be Bovine Viral Diarrhea-Persistently Infected free through laboratory testing. The NHTC program is a USDA approved, non-biased, third-party audit that verifies the source, age, and non-

hormone treated status of cattle. Carcasses from cattle qualifying for the NHTC program are eligible for export to the European Union.

The Superior Progressive Genetics program began in 2009. For a lot of cattle to qualify for this program, the consignor must have purchased enough bulls from a qualified Superior Progressive Genetics seedstock producer to sire an entire lot of cattle.

Lots of cattle that qualified for the Verified Natural Beef program were first identified in the 2010 sale catalogs. This program was almost completely confounded with the NHTC program in each year of the study. Thus, this variable was not included in any of the statistical analyses.

In 2013, Merck Animal health began funding this project, and Kansas State University was responsible for managing the study. At this time, Superior Livestock Auction began providing sale and delivery data in an electronic format (Excel spreadsheet) for all of their cattle sale types: video auctions, Country Page, private treaty, Internet auctions, dairy video auctions, and Superior Select video auctions. Data were available for all cattle types in both single- and mixed-gender lots. Superior has provided the sale and delivery data in an electronic format for the years 2010 through 2017.

Superior Livestock Auction began having special video auctions for breeding cattle in 2014, and these auctions were called Superior Select sales. These sales typically occurred on the same day as a regular video auction, but a separate sale catalog was printed for each sale type. The description of the lots offered for sale in the Superior Select sales contained additional information that pertained to breeding cattle: probable calving period, cattle age, description of the condition of the teeth of the breeding cattle, GeneMax score, HD50K score, and a description of the breeding program.

Superior introduced the Certified Natural Plus program in 2014. This program had the same basic requirements as the Certified Natural program with the additional requirement that these cattle

must also qualify for another natural program (Meyer Natural, JBS & 5 Rivers Natural, etc.). The consignor must sign the necessary paperwork for these programs.

In 2015, Superior announced a new method of calculating the value of lots of cattle that were heavier than the forecasted base weight. This pricing method was called Superior RightSlide. Lots of cattle that qualified for the Reputation Feeder Cattle and the Top Dollar Angus programs were first identified in the 2015 sale catalogs.

The 2 Way Slide was introduced by Superior Livestock Auction in 2016. In this slide method the price per cwt was calculated the same as a conventional side for lots that were from 1 to 25 pounds lighter or heavier than the forecasted delivery weights. Lots of cattle that qualified for the VitaFerm Raised and the Gain Smart programs were first identified in 2016.

In lots of cattle with a Weight Stop, the buyer pays the contracted price up to the Weight Stop. Any pounds above the Weight Stop are free. Information on lots with weight stops was printed in the sale catalogs from 2010 through 2016, but these lots were not easily identified. The entire description of the Slide section of the lot description had to be read to determine if the lot had a weight stop. Lots with weight stops were first identified with a weight stop stamp that looked like a stop sign in the March 7, 2014 sale catalog. The number of pounds of the weight stop was first printed inside the weight stop stamp in the September 26, 2014 sale catalog.

For addition information on the requirements of each of these value-added programs offered by Superior Livestock Auction, visit their web site at www.superiorlivestock.com.

Brief description of each year of the study

1995

Sale data were recorded for only seven video auctions that occurred between June 30 and September 30, 1995. Only single-gender lots of beef calves (non-weaned and weaned) that actually sold during these sales were included in this year's data. Lots of feeder cattle and lots of beef calves that did not sell were not included in the 1995 data

1996

Sale data from all 22 video auctions were recorded in the database. Data describing lots of single-gender calves and feeder cattle that did or did not sell were included. Superior Livestock Auction began identifying lots of cattle that were primarily composed of a single breed, and this piece of information was added to the database. The name of the implant administered to lots of cattle began to be entered into the database.

1997

Sale data from all 23 video auctions were recorded that included all lots of single-gender calves and feeder cattle offered for sale.

1998

Sale data from all 24 video auctions describing all single-gender lots of calves and feeder cattle offered for sale were recorded.

1999

Sale data from all 23 video auctions describing all single-gender lots of calves and feeder cattle were entered into the database. New breed classes were added to identify English cross

cattle that were at least 90% black or black white faced and lots that were at least 90% Angus. These new breed classes were added at the request of Certified Angus Beef.

2000

Sale data from all 23 video auctions describing all single-gender lots of calves and feeder cattle were recorded. For lots that were not in a value-added health protocol, those that received two vaccinations against respiratory tract viruses began to be identified. A new variable was added to the database to record the percentage of black-hided cattle in the lot.

2001

Sale data from all 21 video auctions describing all single-gender lots of calves and feeder cattle were recorded.

2002

Sale data from all 23 video auctions describing all single-gender lots of calves and feeder cattle were recorded.

2003

Sale data from all 22 video auctions describing all single-gender lots of calves and feeder cattle were recorded.

2004

Sale data from all 22 video auctions describing all single-gender lots of calves and feeder cattle were recorded. The Certified Natural program began, and lots that met the requirements for this program were identified in the database.

2005

Sale data from all 23 video auctions describing all single-gender lots of calves and feeder cattle were recorded. Lots that were Source and Age Verified began to be identified, and this information was added to the database. Since the effect of Bangs vaccination on sale price of heifers was not quantified in any of the previous years of the study, Bangs vaccination status was not recorded in 2005.

2006

Due to the large increase in the number of lots offered for sale in the Superior Livestock video auctions during the previous 11 years of the project and data describing feeder cattle were not being utilized, a decision was made to only record data describing lots of beef calves from the six to eight largest calf sales. These sales typically occurred between the end of May and the end of September.

Sale data from seven video auctions describing all single-gender lots of calves were recorded. The sale dates were between May 18 and September 22, 2006. Lots that qualified for the AngusSource program were first identified in the database. The Bangs vaccination status of heifer lots was not recorded.

2007

Sale data from seven video auctions describing single-gender lots of calves were recorded. The auction dates ranged from May 18 to September 20, 2007. Superior Livestock Auction added the Pfizer SelectVAC vaccination protocols to their Value-Added Calf health program, and these protocols were identified in the database. The name of the Source and Age Verification program was added to the database. The Bangs vaccination status of heifer lots was not recorded.

2008

Sale data from seven video auctions describing single-gender lots of calves were recorded. The auction dates ranged from June 4 to September 26, 2008. The VAC 34+ health protocol was introduced and was recorded in the database. Two new value-added programs were introduced by Superior Livestock Auction during this year, the BVD-PI Free and the NHTC programs. The status of each lot for each of these programs was added to the database. Since almost no lots of heifer calves were spayed, this variable was eliminated from the 2008 data. The Bangs vaccination status of heifer lots was again recorded in the 2008 database.

2009

Sale data from seven video auctions describing single-gender lots of calves were recorded. The sale dates were from June 2 to September 25, 2009. Superior Livestock Auction introduced the Superior Progressive Genetics program, and the status for this program for each lot was recorded. The Bangs vaccination status of heifer lots was recorded, but whether lots of heifers were or were not spayed was not included in the 2009 data.

2010

Sale and delivery data were obtained in an electronic format for all marketing methods (Country Page, Private treaty, Internet sales, Superior Select sales, and catalog video auctions) and animal types (non-weaned calves, weaned calves, feeder cattle, replacement heifers, bred heifers, spayed heifers, open cows, bred cows, cow/calf pairs, breeding bulls, exposed heifers, milking cows, open feeder heifers, springer heifers, exposed cows, weigh cows, and cull bulls) and were imported into an Access database. All lots of both single- and mixed gender that were offered for sale were included. Due to the small number of lots in the non-weaned, non-viral vaccinated health protocol, this group was no longer used as the reference population for health protocols and was

excluded from the analyses. The new reference population for the health protocol variable was changed to lots that were non-weaned and received a respiratory viral vaccination at some time. An additional health protocol was also added in 2010: lots of weaned, viral-vaccinated cattle. Lots that qualified for the Verified Natural Beef program or had Weight Stops were first recorded in the database. For lots of cattle that were sired by one breed, the sire breed for the lot was first recorded.

2011

Sale and delivery data were obtained in an electronic format for all marketing and animal types and were imported into an Access database. All lots of both single- and mixed gender that were offered for sale were included.

2012

Sale and delivery data were obtained in an electronic format for all marketing and animal types and were imported into an Access database. All lots of both single- and mixed gender that were offered for sale were included. The VAC 45+ health protocol was added.

2013

Sale and delivery data were obtained in an electronic format for all marketing and animal types and were imported into an Access database. All lots of both single- and mixed gender that were offered for sale were included. The reference population for the health protocol variable was changed to VAC 24.

2014

Sale and delivery data were obtained in an electronic format for all marketing and animal types and were imported into an Access database. All lots of both single- and mixed gender that were offered for sale were included.

Superior Select video auctions for breeding cattle started in 2014. New variables that applied to lots of breeding cattle were: projected calving period, age of the cattle, description of teeth condition, GeneMax score, HD50K score, and type of breeding program.

Other new programs that were introduced in 2014 were the Certified Natural Plus program and the Merck Prime VAC program.

Lots that were documented to be BVD-PI free by the Gold Standard Lab were also identified.

Lots with a weight stop were identified with a Stop Sign shaped stamp.

2015

Sale and delivery data were obtained in an electronic format for all marketing and animal types and were imported into an Access database. All lots of both single- and mixed gender that were offered for sale were included.

New programs that began in 2015 were: Reputation Feeder Cattle, Top Dollar Angus, and Superior RightSlide.

2016

Sale and delivery data were obtained in an electronic format for all marketing and animal types and were imported into an Access database. All lots of both single- and mixed gender that were offered for sale were included.

Superior Livestock Auction introduced the 2 Way Slide program. Lots of cattle that qualified for the VitaFerm Raised or the Gain Smart programs were recorded in the database.

2017

Sale and delivery data were obtained in an electronic format for all marketing and animal types and were imported into an Access database. All lots of both single- and mixed gender that were offered for sale were included.

2018

Sale and delivery data were obtained in an electronic format for all marketing and animal types and were imported into an Access database. All lots of both single- and mixed gender that were offered for sale were included.

Beginning in 2018 and going back to 2010, a heterosis score was assigned to each lot where the dam and sire breeds were clearly identified.

The Verified GrassFed program was added in 2018. The Reputation Feeder Cattle program ended during 2018.

2019

Superior livestock auction provided sale and delivery data in an electronic format for all marketing and animal types from January 1 through May 23, 2019. All lots of both single- and mixed gender that were offered for sale were included. No additional sale and delivery data were provided in 2019, thus, no statistical analyses were performed on the 2019 data.

2020

Data were entered into an Access database directly from the Superior Livestock Auction's sales catalogs. Only data describing single-gender lots of calves (both unweaned and weaned)

from seven summer sales were recorded. Prices for these lots were obtained from Superior's Internet site after each day of the auction. A new animal type was added in 2020, beef-dairy crosses. These lots were out of either Holstein or Jersey dams and sired by beef bulls, primarily Angus, Limousin, and Lim-Flex. Data on Holstein steer calves were obtained from Superior video sales called "Holstein steer and Dairy auctions" that occurred either a week prior to or a week after the regular summer catalog sales. No delivery data were available in 2020.

The following new programs were identified in the 2020 sale catalogs with a special stamp: Black Angus Verified Beef, International Genetic Solution's Feeder Profit Calculator, Beefmaster Breeders United, Integrity Beef Alliance, Cattle Feeder Preferred, BeefCare, Diamond V, Charolais Advantage, Balancer Edge, and Non-GMO.

1995 to 2020 Superior Master Database

All data in the individual databases for each year were combined into a single database called the Superior Master Database.

Appendix D - Superior Livestock Auction – History and description of variables in database 1995 through 2020

History of the variables available for the Superior Livestock Auction data

1995 through 2020

<u>Variable</u>	<u>When available in the database</u>
Auction date	All years
Lot size	All years
Lot gender	All years for single-gender lots, mixed-gender lots were included beginning in 2010 when data were sent electronically
Base weight	All years
Weaning status	All years
Region of origin	All years
Breed description	All years
Frame score	All years
Flesh score	All years
Health protocol	All years
Weight variation within lot	All years
Horn status	All years
Implant status	All years
Bangs vaccinated (heifers)	All years except 2005 through 2007
BVD-PI free	Beginning in 2008
Source and age verified	Beginning in 2005
Days between sale and delivery dates	All years
Delivered in oversized truck loads	Beginning in 2016
Sale price	All years

Superior Livestock Auction programs

VAC	All years
Certified Natural	Beginning in 2004
Certified Natural Plus	Beginning in 2014
Superior Progressive Genetics	Beginning in 2009
Superior RightSlide	Beginning in 2015
2 Way Slide	Beginning in 2016
VitaFerm Raised	Beginning in 2016
GainSmart	Beginning in 2016
Heterosis scores	I went back to 2010 and assigned heterosis scores to lots where the dam and sire breeds were clearly identified

Programs that are not Superior Livestock Auction programs

Non-Hormone Treated Cattle	Beginning in 2008
Verified Natural Beef	Beginning in 2010, this program was never used in any analyses since it was almost totally confounded with NHTC
Global Animal Partnership	Beginning in 2014
Reputation Feeder Cattle	Beginning in 2015, This program ended sometime in 2018
Top Dollar Angus	Beginning in 2015
AngusLink	Beginning in 2018
Hereford Advantage	Beginning in 2017
Beef Quality Assurance	I went back and filled this variable beginning in 2010 but this variable was only used in the 2018 and 2020 models
Black Angus Verified Beef	Beginning in 2020
International Genetic Solution's	
Feeder Profit Calculator	Beginning in 2020
Beefmaster Breeders United	Beginning in 2020
Integrity Beef Alliance	Beginning in 2020
Cattle Feeder Preferred	Beginning in 2020
BeefCare	Beginning in 2020
Diamond V	Beginning in 2020
Charolais Advantage	Beginning in 2020
Balancer Edge	Beginning in 2020
Non-GMO	Beginning in 2020

Other Programs

Verified GrassFed Program	Beginning in 2018
Maternal Advantage Program	Beginning in 2018

Even though data were available on these Superior Livestock Auction and other independent programs, some of the programs had too few lots to be included in the analyses.

Description of the Superior Livestock Auction master database 1995 through 2018

Source of data

Data describing lots of cattle offered for sale in Superior Livestock Auction's sales were obtained from existing databases and combined into a single database. The years represented in this database are 1995 through 2018. From 1995 through 2009, data were manually entered into the databases from video auction sale catalogs. During these years, information describing some or all of the lots of non-weaned calves, weaned calves, and feeder cattle in single-gender lots was recorded. Beginning in 2010, sale and delivery data were provided by Superior Livestock Auction in an electronic format for all lots of cattle offered for sale in video auctions, Superior Select (breeding cattle) video auctions, dairy video auctions, Internet auctions, on the Country Page, and by private treaty.

During this 24-year period, new information describing the lots of cattle were added, and new variables were created in the databases to record this information. For these new variables, all values are null in the years prior to the year the variable was created.

<u>Variable name</u>	<u>Variable description</u>
SYear (LI)	The year that the cattle were offered for sale in a Superior sale. The years included in this database range from 1995 through 2016.
LotID (LI)	A unique ID number for each record in the database. A record represents a lot of cattle.
LotIDO (LI)	The Lot ID number from the original database, these numbers are unique for single-gender lots in each year. For mixed lots, there are duplicate LotID's in each year.
Sale (T)	The name of the sale for video, Internet, Superior Select, and dairy auctions. Video auction names start with the letter V followed by the year followed by the sale number. For example, V201801 was the first video sale in 2018. Superior Select, Internet, and dairy auction names follow the same pattern but begin with BV, I, or DV, respectively.

Summer (B)	Was the lot included in summer sales analyses? 0 = No 1 = Yes
SaleDate (Date)	The date the cattle were offered for sale through a Superior auction.
SMonth (I)	Numeric code for the month of the year that the lot was sold. Used the DatePart function to fill this variable.
SaleDateN (LI)	The sale date converted into a number.
SaleType (T)	Text codes for the type of auction. CP = Country Page PT = Private Treaty I = Internet auction DV = Dairy video auction SV = Supplemental lots added to a video auction after the sale catalog was printed V = Video auction (lots in the sale catalog) BV = Superior Select video auction (for breeding cattle)
ConType (B)	Numeric code for contract type. 1 = Non-Breeding 2 = Breeding or Superior Select 3 = Dairy
Lot (T)	The lot number assigned by Superior. Lots in video auction begin with 1001 Lots in Country Page begin with C Lots in Dairy sales begin with D Lots in Stampede Internet sales begin with N Lots sold private treaty begin with PT Supplemental lots in video auctions begin with S Lots in Superior Select video auctions begin with R
Mixed (B)	Was the lot composed of mixed-gender cattle? 0 = No 1 = Yes
Head (LI)	The number of head of cattle in the lot.
Sex (I)	Numeric code for the gender of the cattle in the lot. 1 = Steers 2 = Heifers 3 = Cows 4 = Bulls 5 = Pairs

AType (I)	Numeric code for the type of cattle in the lot. 0 = non-weaned calves 1 = weaned calves 2 = feeders 3 = replacement heifers 4 = bred heifers 5 = spayed heifers 6 = open cows 7 = bred cows 8 = cow/calf pairs 9 = breeding bulls 10 = exposed heifers 11 = milking cows (dairy) 12 = open feeder heifers 13 = springer heifers (dairy) 14 = exposed cows 15 = weigh cows 16 = cull bulls
WT (D)	The forecasted base weight of the lot in pounds.
DelWT (D)	Actual mean delivery weight of the lot in pounds.
WTDiff (D)	The difference between the actual mean delivery weight and the forecasted base weight of the lot in pounds [DelWT] – [WT].
DateDiff (I)	The number of days between the actual delivery date and the forecasted delivery date [ADDDate] – [PDDate].
Price (D)	The price paid for the cattle in the lot – most prices are on a \$/cwt basis, some prices are on a per head basis.
WTStopLB (D)	Number of pounds over the forecasted lot base weight where all additional pounds are free; a high percentage of the lots have a 25 pound weight stop
WTStopYN (B)	Did the lot have a weight stop? 0 = No 1 = Yes
NoSale (B)	Was the lot a no-sale? 0 = No 1 = Yes
Scratch (B)	Was the lot scratched prior to the auction? 0 = No 1 = Yes
PDDate (Date)	The forecasted delivery date of the lot, used the first date in the range in delivery dates.
PDDateN (LI)	The forecasted delivery date converted to a number.
PDDMonth (I)	Numeric code for the month of the year that the lot was forecasted to be delivered. Used the DatePart function to fill this variable.
PDDiff (LI)	The number of days between the sale date and the predicted delivery date [PDDate]-[SaleDate].
ADDiff (LI)	The number of days between the sale date and the actual delivery date [ADDDate]-[SaleDate].

City (T)	The city where the lot originated.
State (T)	The state abbreviation where the lot originated.
OZip (LI)	The zip code for the city of origin.
OZipN (LI)	The zip code for the city of origin based on the zip codes provided by Nathan Bean on 5/23/2016.
SArea (I)	The region of the U.S. where the lot originated. 1 = West Coast (AK, CA, HI, ID, NV, OR, UT, and WA) 2 = Rocky Mountain/North Central (CO, IA, IL, IN, MI, MN, MT, ND, NE, SD, WI, and WY) 3 = South Central (AZ, KS, MO, NM, OK, and TX) 4 = North East (CT, DE, MA, MD, ME, NH, NJ, NY, OH, PA, RI, VT, and WV) 5 = South East (AL, AR, FL, GA, KY, LA, MS, NC, SC, TN, and VA)
SAreaN (I)	The region of the U.S. where the lot originated. Some of the regions were changed for evaluating the change in the percentage of lots with Brahman influence over time. 1 = West Coast (AK, CA, HI, ID, NV, OR, UT, and WA) 2 = Rocky Mountain/North Central (CO, IA, IL, IN, MI, MN, MT, ND, NE, SD, WI, and WY) 3 = South Central (AZ, KS, MO, NM, and OK) 4 = Texas (TX) 5 = Coastal (AL, FL, GA, LA, MS, and SC) 6 = Sub-Coastal (AR, KY, NC, TN, VA, and WV) 7 = North East (CT, DE, MA, MD, ME, NH, NJ, NY, OH, PA, RI, and VT)

Special (I)

Numeric code for the breed stamp.

- 0 = No stamp
- 1 = Angus
- 2 = Red Angus
- 3 = Limousin
- 4 = Gelbvieh
- 5 = Charolais
- 6 = Salers
- 7 = Brangus
- 8 = Beefmaster
- 9 = Montana Angus
- 10 = Hereford
- 11 = Maine Anjou
- 12 = Branvieh
- 13 = Simmental
- 14 = Angus Source Genetics
- 15 = Lim-Flex
- 16 = SimAngus
- 17 = Top Dollar Angus
- 18 = Gelbvieh/Balancer
- 19 = Wagyu
- 20 = Brahman
- 21 = Santa Gertrudis
- 22 = Braford

Breed (I)

Numeric code for breed description of the lot.

1 = English, English cross with less than 90% black hided

2 = Continental, Continental cross

3 = English-Continental cross

4 = English with ear

5 = Continental with ear

6 = English-Continental with ear

7 = > 50% Brahman

8 = Longhorn, Corriente cross

9 = Dairy cross

10 = Black, BWF – at least 90% black

11 = Red, RWF

12 = Mixed colors

13 = Mexican

14 = Black, BWF with ear – at least 90% black

15 = Red, RWF with ear

16 = mixed colors with ear

17 = Primarily Angus – at least 90% Angus

18 = Hereford

19 = Red Angus

20 = Charolais

21 = Simmental

22 = Gelbvieh

23 = Limousin

24 = Brangus

25 = Shorthorn

26 = Maine Anjou

27 = Salers

28 = Beefmaster

29 = Holstein

30 = Jersey

31 = SimAngus

32 = Braford

33 = Dairy-Beef crosses

PBlack (S)

The percentage of black-hided cattle in the lot.

SireBRD (I)	<p>Sire breed of the lot.</p> <p>1 = Angus</p> <p>2 = Red Angus</p> <p>3 = Charolais</p> <p>4 = Brangus</p> <p>5 = Limousin</p> <p>6 = Hereford</p> <p>7 = Gelbvieh</p> <p>8 = Beefmaster</p> <p>9 = Maine Anjou</p> <p>10 = Simmental</p> <p>11 = Sim-Angus</p> <p>12 = Branveih</p> <p>13 = Salers</p> <p>14 = Other composites</p> <p>15 = Brahman</p> <p>16 = Lim-Flex</p> <p>17 = Balancer</p> <p>18 = Power Genetics</p> <p>19 = Profit Makers</p> <p>20 = Braford</p> <p>50 = All other individual breeds with small numbers of lots</p> <p>99 = Multiple sire breeds</p>
Origin (T)	<p>Numeric code for the origin of the cattle.</p> <p>1 = Home raised</p> <p>2 = Purchased</p> <p>3 = Both home raised and purchased</p>
Frame (T)	<p>Numeric code for frame score of the cattle in the lot.</p> <p>1 = Small</p> <p>2 = Small-Medium</p> <p>3 = Medium</p> <p>4 = Medium-Medium Large</p> <p>5 = Medium Large</p> <p>6 = Medium Large-Large</p> <p>7 = Large</p>
Flesh (T)	<p>Numeric code for flesh score of the cattle in the lot.</p> <p>1 = Light</p> <p>2 = Light Medium</p> <p>3 = Light Medium-Medium</p> <p>4 = Medium</p> <p>5 = Medium-Medium Heavy</p> <p>6 = Medium Heavy</p> <p>7 = Heavy</p>

Horns (T)	Numeric code for horned status of the lot. 0 = No 1 = Yes 2 = Some 3 = Tipped
WTVar (T)	Numeric code for weight variation of the cattle within the lot. 1 = Even 2 = Fairly even 3 = Uneven 4 = Very uneven
Slide (S)	The amount of the slide used to calculate the adjusted delivery price.
Vac (S)	Numeric code for the vaccination program administered to cattle in the lot. 1 = VAC 24 21 = Pfizer or Merck PrimeVAC 24 2 = VAC 34 22 = Pfizer or Merck PrimeVAC 34 2.1 = VAC 34+ 22.1 = Pfizer or Merck PrimeVAC 34 Premium 3 = VAC 45 23 = Pfizer or Merck PrimeVAC 45 3.1 = VAC 45+ 23.1 = Pfizer or Merck PrimeVAC 45 Premium 4 = VAC PreCon 24 = Pfizer or Merck Prime VAC PreCon 25 = Merck PrimeVAC Heifer 5 = respiratory viral vaccine at branding 6 = respiratory viral vaccine at weaning 7 = respiratory viral vaccine at both branding and weaning 8 = respiratory viral vaccine at an unknown time 9 = no respiratory viral vaccine 10 = Had all shots or good vaccination program 58 = two respiratory viral vaccines, one at branding and one at an unknown time 66 = two respiratory viral vaccines at weaning 77 = three respiratory viral vaccines, one at branding and two at weaning 86 = two respiratory viral vaccines, one at an unknown time and one at weaning 88 = two respiratory viral vaccines, both at an unknown time 99 = no respiratory viral vaccine but was vaccinated against Pasteurella
Impl (B)	Were the cattle in the lot implanted? 0 = No 1 = Yes 2 = Some 3 = Not by this owner
ImplN (LI)	Numeric code for the type on implant used (see the table Implant Name Codes).

Bangs (T)	Were females Brucellosis vaccinated? 0 = No 1 = Yes 2 = Some
SellByH (T)	Were cattle in the lot sold on a per head basis? 0 = No 1 = Yes
FrADJ (T)	Was a freight adjustment offered for the lot? 0 = No 1 = Yes
Country (T)	The country where the cattle originated. USA, Mexico, or Canada
Natural (B)	Did the cattle in the lot qualify for the Certified Natural program? 0 = No 1 = Yes
NatPlus (B)	Did the cattle in the lot qualify for the Certified Natural Plus program? 0 = No 1 = Yes
NatComb (B)	Combination of the Certified Natural and the Certified Natural Plus programs. 0 = No (did not qualify for either Natural programs) 1 = Yes (Natural = 1 or NatPlus = 1)
ASVer (B)	Were the cattle in the lot Source and Age Verified? 0 = No 1 = Yes
ASVerP (I)	Numeric code for the Source and Age Verification program (see table Age Source Verification Program).
PIFree (B)	Were the cattle in the lot documented to be BVD-PI free? 0 = No 1 = Yes 2 = test done at Gold Standard Lab
NHTC (B)	Did the cattle in the lot qualify for the Non-Hormone Treated Cattle program? 0 = No 1 = Yes
SPG (B)	Did the cattle in the lot qualify for the Superior Progressive Genetics program? 0 = No 1 = Yes
VNB (B)	Did the cattle in the lot qualify for the Verified Natural Beef or Never Ever 3 program? Almost all lots in the VNB program are also in the NHTC program so there is almost complete confounding between these two variables. 0 = No 1 = Yes
ADDdate (Date)	Actual delivery date of the lot.

ADDateN (LI)	The actual delivery date converted to a number.
ADMonth (I)	Numeric code for the month of the year that the lot was delivered. Used the DatePart function to fill this variable.
DYear (LI)	The year the lot was delivered.
DCity (T)	The city where the lot was delivered.
DState (T)	The state where the lot was delivered.
DArea (I)	The region of the U.S. where the lot was delivered (same codes and states as for SArea).
DZip (LI)	The zip code for the city of destination.
DZipN (LI)	The zip code for the city of destination based on the zip codes provided by Nathan Bean on 5/23/2016.
DDistance (D)	The driving distance in miles between the city of origin and the city of destination.
SDistance (D)	The straight line distance in miles between the city of origin and the city of destination.
GeneMax (B)	Were the GeneMax scores available? The overall GeneMax score ranges from 1 to 99 and is an economically weighted value for the combination of marbling score and ADG score. There are individual scores for marbling and ADG that range from 1 to 5 with 5 being in the top 20%. Only for Angus cattle. 0 = No 1 = Yes
HD50K (B)	Were HD50K scores available? High-density DNA panel to identify more than 50,000 DNA markers in Angus cattle. Provides genomic enhanced EPDs as well as parentage of the animal. 0 = No 1 = Yes
GapStep (T)	The level of the Global Animal Partnership program.
GAP (B)	Numeric code for level of the GAP Step program 0 = not in program 1 = GAP 1 4 = GAP 4
GAP1 (B)	Did the lot qualify for GAP Step 1 (no cages, no crates, no crowding)? 0 = No 1 = Yes
GAP4 (B)	Did the lot qualify for GAP Step 4 (pasture centered)? 0 = No 1 = Yes
Merck (B)	Did the lot qualify for one of the Merck PrimeVAC health protocols? 0 = No 1 = Yes

OverUnder (I)	Numeric code for the relationship between the actual and the forecasted base weight. 1 = Over the base weight 2 = Under the base weight 3 = RightSlide program 4 = 2 Way Slide program 5 = Any lbs. over base weight are free
RFeeders (B)	Did the lot qualify for the Reputation Feeder Cattle program? 0 = No 1 = Yes
TopAN (B)	Did the lot qualify for the Top Dollar Angus program? 0 = No 1 = Yes
CHB (B)	Did the lot qualify for the Certified Hereford Beef program? 0 = No 1 = Yes
MAdvantage (B)	Did the lot qualify for the Maternal Advantage program? 0 = No 1 = Yes
AngusLink (B)	Did the lot qualify for the AngusLink program? 0 = No 1 = Yes
RSlide (B)	Did the lot use the RightSlide program? 0 = No 1 = Yes
SlideType (I)	Type of slide program 1 = Conventional slide 2 = RightSlide program 3 = 2 Way Slide program
Organic (B)	Was the lot in the Organic program? 0 = No 1 = Yes
OverSize (B)	Was the lot delivered in oversized truck load? 0 = No 1 = Yes
VANutr (T)	The name of the value-added nutrition program. VitaFerm Raised or Gain Smart
VANutrYN (B)	Was the lot in a value-added nutrition program? 0 = No 1 = Yes
VFerm (B)	Did the lot qualify for the VitaFerm Raised program? 0 = No 1 = Yes
GSmart (B)	Did the lot qualify for the Gain Smart program? 0 = No 1 = Yes

GrassFed (B)	<p>Did the lot qualify for the Certified GrassFed program?</p> <p>0 = No</p> <p>1 = Yes</p>
ARGroup (B)	<p>Numeric code for groups of Red Angus influenced cattle.</p> <p>1 = Lot was enrolled in the Red Angus Allied Access Program</p> <p>2 = Lot was enrolled in the Red Angus Feeder Cattle Certification Program (FCCP)</p> <p>3 = Lot was enrolled in the Red Angus Feeder Cattle Certification Program (FCCP) and had dangle tags</p> <p>4 = Lots of calves in this group were not enrolled in either the Red Angus Allied Access Program or the Red Angus FCCP, but were determined to be Red Angus influenced by one or more of the following criteria: the lot was classified as primarily Red Angus based on the breed description of the lot, the lot was sired solely by Red Angus bulls, or the lot description contained the Superior Red Angus stamp.</p>
BQA (B)	<p>Did the lot meet Beef Quality Assurance requirements?</p> <p>This variable was coded by searching the following variables for BQA or Beef Quality Assurance: BreedT, WCond, FeedProg, Comment, and VacProd.</p> <p>0 = No</p> <p>1 = Yes</p>
Heterosis (B)	<p>Heterosis score</p> <p>1 = same dam and sire breed</p> <p>2 = mostly the same dam and sire breeds</p> <p>3 = some dam and sire breeds were the same</p> <p>4 = mostly different dam and sire breeds</p> <p>5 = completely different dam and sire breeds</p>
NatAll (B)	<p>Was the lot in one or more of the following natural programs: Superior Certified Natural, Superior Certified Natural Plus, Verified Natural Beef, or Non-Hormone Treated Cattle</p> <p>0 = No</p> <p>1 = Yes</p>

Description of the 2020 Superior Livestock Auction database

Source of data

Summer sale catalogs for 2020 Superior Livestock Auction's video sales.

<u>Variable name</u>	<u>Variable description</u>
LotIDO (AUTO)	Lot ID number, these numbers are unique.
SYear (LI)	The year of the auction
Sale (T)	The name of the video sale. Video auctions start with a V then 2020 then sale number: V202001.
Summer (Byte)	Was the video auction one of the big summer calf sales? The dates of these video auctions range from June 10 through September 9, 2020. 0 = No 1 = Yes
SaleDate (Date)	The date of the auction
SMonth (I)	Numeric code for the month of the auction. Used DatePart function to fill this variable.
SaleDateN (LI)	The sale date converted into a number
SaleType (T)	Text codes for the type of auction V = Video Sale (lots in the sale catalog)
Lot (T)	Lot number as recorded in the sale catalog
Mixed (Byte)	Was the lot composed of mixed-gender calves 0 = No 1 = Yes
Head (LI)	The number of calves in the lot
Sex (I)	Numeric code for the gender of the calves 1 = Steers 2 = Heifers
AType (I)	Numeric code for the type of calves in the lot 0 = non-weaned calves 1 = weaned calves 17 = beef dairy cross
WT (D)	The forecasted base weight of the lot in pounds
Price (D)	The price of the lot – prices are on a \$/100 pounds basis
WTStopLB (D)	The number of pounds above the base weight where the additional pounds are free
WTStopYN (B)	Did lot have a weight stop? 0 = No 1 = Yes
PDate (Date)	The predicted delivery date of the lot, used the first date in the range in dates
PDMonth (I)	Numeric code for the forecasted delivery month

PDDateN (LI)	The predicted delivery date converted to a number
PDDiff (LI)	The number of days between the sale date and the predicted delivery date [PDDate]-[SaleDate]
State (T)	The state abbreviation where the lot originated
StateCode (I)	The numeric code for the state of origin
SArea (I)	The numeric code for the area of origin
Special (I)	Numeric code for the breed stamp
	0 = No stamp
	1 = Angus
	2 = Red Angus
	3 = Limousin
	4 = Gelbvieh
	5 = Charolais
	6 = Salers
	7 = Brangus
	8 = Beefmaster
	9 = Montana Angus
	10 = Hereford
	11 = Maine Anjou
	12 = Braunvieh
	13 = Simmental
	14 = Angus Source Genetics
	15 = Lim-Flex
	16 = SimAngus
	17 = Top Dollar Angus
	18 = Gelbvieh/Balancer
	19 = Wagyu
	20 = Brahman
	21 = Santa Gertrudis
	22 = Braford

Breed (I)

Numeric code for breed composition

1 = English, English cross with less than 90% black hided

2 = Continental, Continental cross

3 = English-Continental cross

4 = English with ear

5 = Continental with ear

6 = English-Continental with ear

7 = > 50% Brahman

8 = Longhorn, Corriente

9 = Dairy cross

10 = Black, BWF – at least 90% black

11 = Red, RWF

12 = Mixed colors

13 = Mexican

14 = Black, BWF with ear – at least 90% black

15 = Red, RWF with ear

16 = mixed colors with ear

17 = Primarily Angus – at least 90% Angus

18 = Hereford

19 = Red Angus

20 = Charolais

21 = Simmental

22 = Gelbvieh

23 = Limousin

24 = Brangus

25 = Shorthorn

26 = Maine Anjou

27 = Salers

28 = Beefmaster

29 = Holstein

30 = Jersey

31 = SimAngus

32 = Braford

33 = Holstein cows-beef bulls

34 = Dairy cross cow-beef bulls

35 = Jersey cows-beef bulls

PBlack (Single)

The percentage of black-hided calves in the lot

SireBRD (I)	<p>Sire breed of the lot</p> <p>Null = sire breed could not be accurately determined from the information given</p> <p>1 = Angus</p> <p>2 = Red Angus</p> <p>3 = Charolais</p> <p>4 = Brangus</p> <p>5 = Limousin</p> <p>6 = Hereford</p> <p>7 = Gelbvieh</p> <p>8 = Beefmaster</p> <p>9 = Maine Anjou</p> <p>10 = Simmental</p> <p>11 = SimAngus</p> <p>12 = Braunvieh</p> <p>13 = Salers</p> <p>14 = Other composites</p> <p>15 = Brahman</p> <p>16 = Lim-Flex</p> <p>17 = Balancer</p> <p>18 = Power Genetics</p> <p>19 = Profit Makers</p> <p>20 = Braford</p> <p>21 = ABS InFocus beef sires</p> <p>50 = All other individual sire breeds</p> <p>99 = Multiple sire breeds</p>
Heterosis (B)	<p>Heterosis score</p> <p>1 = same dam and sire breed</p> <p>2 = mostly the same dam and sire breed</p> <p>3 = mostly different dam and sire breed</p> <p>4 = completely different dam and sire breed</p>
Origin (T)	<p>Numeric code for the origin of the cattle</p> <p>1 = Home raised</p> <p>2 = Purchased</p> <p>3 = Both home raised and purchased</p>
Frame (T)	<p>Numeric code for frame score</p> <p>1 = Small</p> <p>2 = Small-Medium</p> <p>3 = Medium</p> <p>4 = Medium-Medium Large</p> <p>5 = Medium Large</p> <p>6 = Medium Large-Large</p> <p>7 = Large</p>

Flesh (T)	Numeric code for flesh score 1 = Light 2 = Light Medium 3 = Light Medium-Medium 4 = Medium 5 = Medium-Medium Heavy 6 = Medium Heavy 7 = Heavy
Horns (T)	Numeric code for horned status 0 = No 1 = Yes 2 = Some 3 = Tipped
WTVar (T)	Numeric code for weight variation 1 = Even 2 = Fairly even 3 = Uneven 4 = Very uneven
Slide (S)	Amount of slide in comparison to base weight
Vac (Single)	Numeric code for the vaccination program administered to the calves in lot 1 = VAC 24 2 = VAC 34 2.1 = VAC 34+ 3 = VAC 45 3.1 = VAC 45+ 3.5 = VAC 60 4 = VAC PreCon 5 = respiratory viral vaccine at branding 6 = respiratory viral vaccine at weaning 7 = respiratory viral vaccine at both branding and weaning 8 = respiratory viral vaccine at an unknown time 9 = no respiratory viral vaccine 10 = Had all shots or good vaccination program 58 = two respiratory viral vaccines, one at branding and one at an unknown time 66 = two respiratory viral vaccines at weaning 77 = three respiratory viral vaccines, one at branding and two at weaning 86 = two respiratory viral vaccines, one at an unknown time and one at weaning 88 = two respiratory viral vaccines, both at an unknown time 99 = no respiratory viral vaccine but was vaccinated against Pasteurella
Impl (B)	Were the calves in the lot implanted? 0 = No 1 = Yes 2 = Some 3 = Not by this owner

ImplN (LI)	Numeric code for the type on implant used, see the table Implant Name Codes
Bangs (T)	Were heifers Bangs vaccinated? 0 = No 1 = Yes 2 = Some
Natural (Byte)	Did the calves in the lot qualify for the Certified Natural program? 0 = No 1 = Yes
NatComb (Byte)	Combination of the Certified Natural and the Certified Natural Plus programs 0 = No (did not qualify for either Natural programs) 1 = Yes (Natural = 1 or NatPlus = 1)
ASVer (Byte)	Were the calves in the lot Age and Source Verified? 0 = No 1 = Yes
ASVerP (I)	Numeric code for the Age and Source Verification program See table Age Source Verification Program
PIFree (Byte)	Were the calves in the lot documented to be BVD PI free? 0 = No 1 = Yes
ANVB (Byte)	Were the calves in the Black Angus Verified Beef program? 0 = No 1 = Yes
NHTC (Byte)	Did the calves in the lot qualify for the Non-Hormone Treated Cattle Program? 0 = No 1 = Yes
VNB (Byte)	Did the calves in the lot qualify for the Verified Natural Beef or Never Ever 3 program? 0 = No 1 = Yes
SPG (Byte)	Did the calves in the lot qualify for the Superior Progressive Genetics Program? 0 = No 1 = Yes
NatPlus (Byte)	Did the calves in the lot qualify for the Certified Natural Plus program? 0 = No 1 = Yes
Gap1 (B)	Was lot in the GAP1 program? (no crates, no cages, no crowding) 0 = No 1 = Yes
Gap4 (B)	Was lot in the GAP4 program? (raised in a pasture centered environment) 0 = No 1 = Yes

TopAN (B)	Did the lot qualify for the Top Dollar Angus program? 0 = No 1 = Yes
CHB (B)	Did the lot qualify for the Hereford Advantage program? 0 = No 1 = Yes
AngusLink (B)	Did the lot qualify for the AngusLink program? 0 = No 1 = Yes
SlideType (I)	Type of slide used to calculate the final price of calves in the lot? 1 = Conventional slide 2 = RightSlide 3 = 2 Way Slide 4 = Calf Ranch slide
OverSize (B)	Was the weight of the load over 50,000 pounds? 0 = No 1 = Yes
VFerm (B)	Was the lot in the VitaFerm Raised program? 0 = No 1 = Yes
GSmart (B)	Was the lot in the GainSmart program? 0 = No 1 = Yes
GrassFed (B)	Was the lot in the Verified GrassFed program? 0 = No 1 = Yes
ARGroup (B)	Numeric code for groups of Red Angus influenced cattle. 1 = Lot was enrolled in the Red Angus Allied Access Program (ASVerP = 555) 2 = Lot was enrolled in the Red Angus Feeder Cattle Certification Program (FCCP, ASVerP = 560) 3 = Lot was enrolled in the Red Angus Feeder Cattle Certification Program (FCCP) and had dangle tags (ASVerP = 561) 4 = Lots of calves in this group were not enrolled in either the Red Angus Allied Access Program or the Red Angus FCCP, but were determined to be Red Angus influenced by one or more of the following criteria: the lot was classified as primarily Red Angus based on the breed description of the lot (Breed = 19), the lot was sired solely by Red Angus bulls (SireBRD = 2), or the lot description contained the Superior Red Angus stamp (Special = 2).
BQA (B)	Did the lot meet Beef Quality Assurance requirements? 0 = No 1 = Yes

NatAll (B) Was lot in one or more of the following natural programs: Superior Certified Natural, Superior Certified Natural Plus, Verified Natural Beef, or Non-Hormone Treated Cattle?
0 = No
1 = Yes

IGS (B) Was lot in the International Genetic Solution's Feeder Profit Calculator Program?
0 = No
1 = Yes

BMBreeder (B) Was lot in the Beefmaster Breeders United program?
0 = No
1 = Yes

IntegrityB (B) Was lot in the Integrity Beef Alliance program?
0 = No
1 = Yes

CFP (B) Was lot in the Cattle Feeder Preferred program?
0 = No
1 = Yes

BeefCare (B) Was lot in the BeefCARE program?
0 = No
1 = Yes

DiamondV (B) Was lot in the Diamond V program?
0 = No
1 = Yes

CHADV (B) Was lot in the Charolais Advantage Program?
0 = No
1 = Yes

BalEdge (B) Was the lot in the Balancer Edge Program?
0 = No
1 = Yes

NonGMO (B) Was the lot in the Non-GMO program?
0 = No
1 = Yes

Breed2 (I) Breed groups combining breeds in the variable Breed
1 = English and English crosses
3 = English-Continental crosses
25 = Beef-dairy crosses
29 = Holsteins
50 = Brahman influenced

Appendix E - Imitating the dynamic bovine cervix with 3D printing technology to teach artificial insemination in cattle

E. D. McCabe^{*}, L. P. Sorell[†], M. Zhang[†], A. R. Hartman^{*}, K. E. Fike^{*}, K. G. Odde^{*}, and D. M. Grieger^{*}

^{*}Department of Animal Sciences and Industry, Kansas State University, Manhattan, KS 66506; and [†]Department of Industrial and Manufacturing Systems Engineering, Kansas State University, Manhattan, KS 66506

2020. J. Anim. Sci. Suppl. 3. 98:147

The process of artificial insemination in cattle is commonly taught using excised reproductive tracts. Excised reproductive tracts can be difficult to collect, and often require freezing and thawing prior to use; however, they are an effective tool to teach artificial insemination (AI) techniques. As an alternative tool, 3D printed cervixes were created using NinjaFlex filament in a Flashforge Creator Pro Dual Extrusion Printer. Designs of cervixes were created with a 3D CAD software while MATLAB was used to generate the random placement of the cervical ring openings to model biological diversity. The objective was to determine the effectiveness of using a 3D printed cervix compared with an excised reproductive tract to teach AI in cattle. Data were collected via surveys for 120 students from 2016 through 2019. Students were divided in two groups prior to entering live animals: 1) Excised reproductive tract and 2) 3D cervix. The excised reproductive tracts were previously collected, preserved, and confirmed passable by instructors. The 3D cervix group included 3D cervixes mounted in a bovine pelvis inside a box. Overall, 88% of students had success passing the cervix in the cow by the third day. Eighty-seven percent of students thought the excised tracts felt somewhat similar to a live cow, compared with 54% who thought the 3D cervixes alone felt similar to a live cow. When the 3D cervixes were mounted in the box, 17/20 students thought they felt similar to a live cow. For learning AI techniques, 12/21 students thought the excised tracts were more helpful than the 3D cervixes alone (5/21); however, when the 3D cervixes were mounted in the pelvic boxes, 11/21 students preferred this setup compared with the excised tracts (6/21 students). Student feedback suggests the 3D cervixes mounted in pelvic boxes are a useful tool for teaching artificial insemination techniques.

Figure E.1 - Flashforge Creator Pro Dual Extrusion Printer printing a 3D cervix using NinjaFlex filament

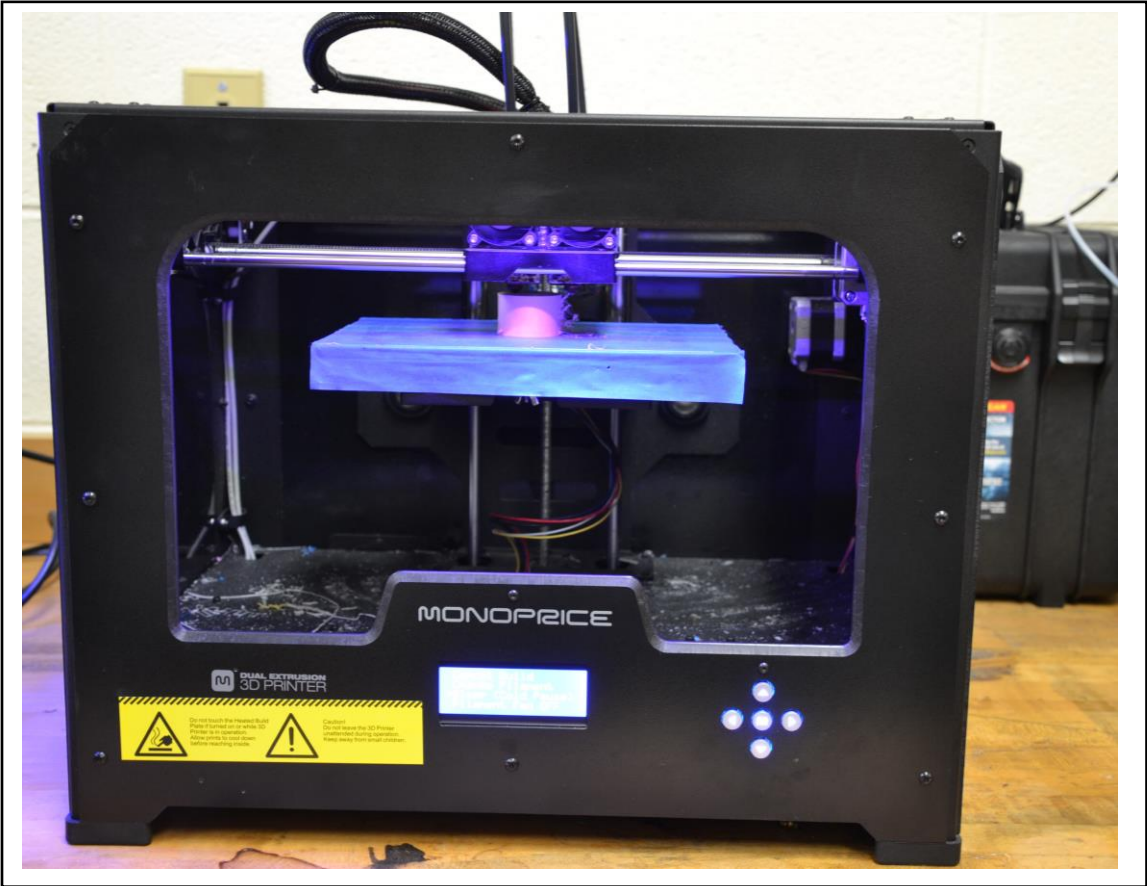
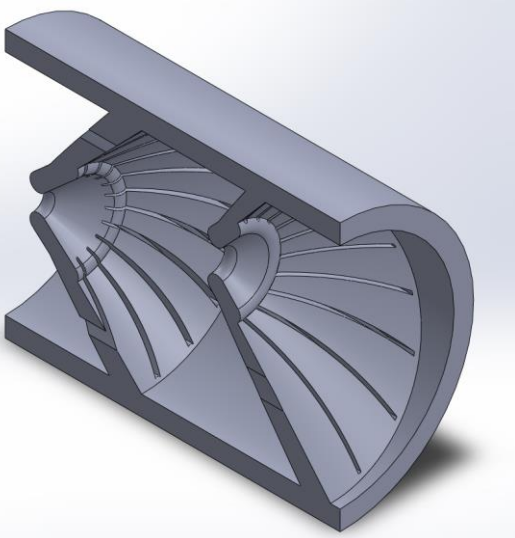

Figure E.2 - Prototypes of 3D printed cervix, half angle and section views, from Kansas State University Industrial Engineering

Half Angle View



Section View

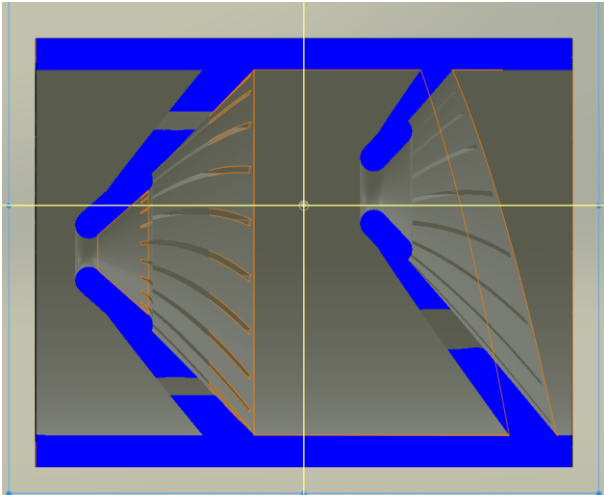

Figure E.3 - Various types of 3D printed cervices representing both cow and heifer cervices

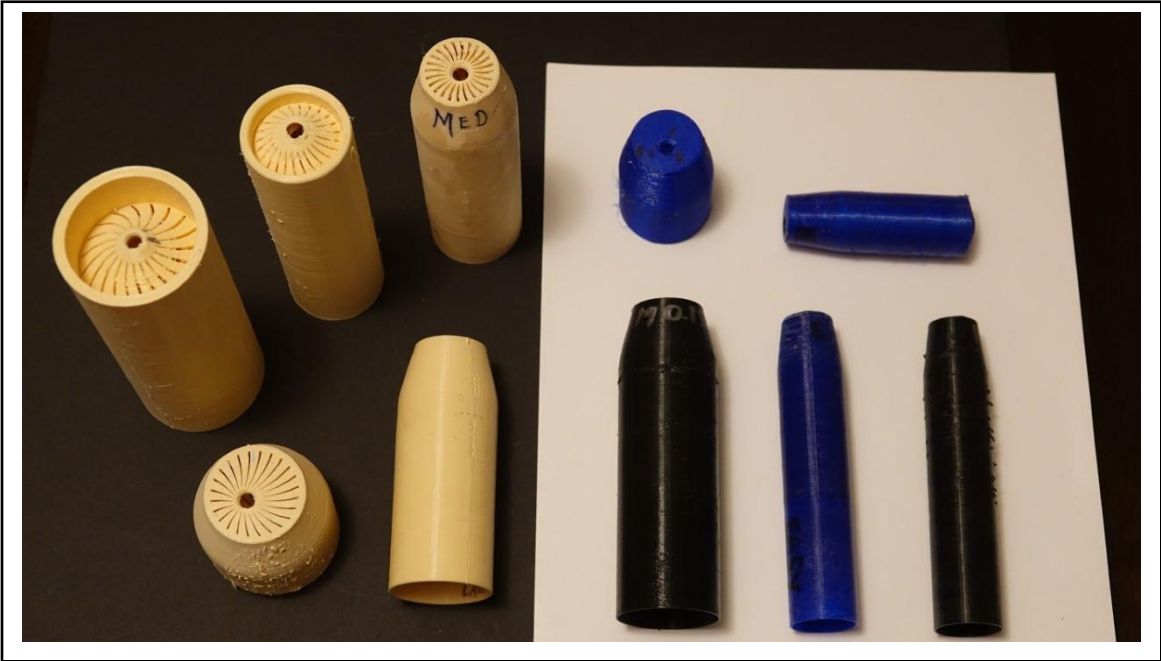

Figure E.4 - The 3D printed cervix assembled in the pelvic box from the top view



Figure E.5 - The 3D printed cervix assembled in the pelvic box from the rear view

