

**SYSTEMATICS AND REPRODUCTIVE BIOLOGY OF THE  
GENUS *MORUS* L. (MORACEAE)**

by

**MADHAV P. NEPAL**

B.Sc., Tri-Chandra College, Tribhuvan University, Kathmandu, Nepal, 1995  
M.Sc., Central Department of Botany, Tribhuvan University, Kathmandu, Nepal, 1997  
M.S., University of Northern Iowa, Cedar Falls Iowa, USA, 2003

AN ABSTRACT OF A DISSERTATION

submitted in partial fulfillment of the requirements for the degree

**DOCTOR OF PHILOSOPHY**

Division of Biology  
College of Arts and Sciences

KANSAS STATE UNIVERSITY  
Manhattan, Kansas

**2008**

## ABSTRACT

*Morus* L. (Moraceae) is a temperate and subtropical genus of ten to 15 species distributed in Asia, Africa, Europe, North, Central and South America. Despite its broad distribution and economic importance, it has received little attention from systematic botanists. Two species of this genus, the native *M. rubra* and the exotic *M. alba*, co-occur in eastern North America including the Flint Hills region of the Central Plains. In my dissertation research, I have conducted both species level and population level studies to obtain insights into the diversification of *Morus*. At the species level, my objectives were to re-evaluate the taxonomy and reconstruct the phylogeny of *Morus*. Based on herbarium and literature study as well as some field study, I recognize 13 species: eight species occurring in Asia, one in Africa and four in the New World. I used sequence data from the internal transcribed spacer (ITS) region of the nuclear ribosomal DNA and the *trnL-trnF* region of the chloroplast DNA to reconstruct the evolutionary history of *Morus*. The phylogenies were congruent and indicate a) a monophyletic core group of *Morus* with two well-supported geographical clades (one containing Asian taxa and one of New World taxa); and b) that *Morus*, as currently circumscribed, is non-monophyletic. At the population level, I studied sex expression pattern variation between the *Morus* native-exotic pair in the Flint Hills region, and assessed hybridization between these species at Konza Prairie Biological Station (KPBS). Both species are subdioecious, and Flint Hills populations exhibit significantly male-biased sex ratios, with sex expression being size independent. Approximately 10% of individuals of each species changed sex annually. In the population study at KPBS, I applied randomly amplified polymorphic DNA (RAPD) markers

and microsatellites. The *Morus* species were moderately ( $\theta^{\text{II}} = 0.079$ ; RAPD data) to highly differentiated genetically ( $F_{\text{ST}} = 0.233$ ; microsatellite data). Analysis of genetic structure suggested interspecific gene flow and indicated the presence of later generation hybrids. The presence of the exotic congener may affect the existence and genetic integrity of the native species. Overall, these studies contribute to our understanding of diversity in this interesting plant study system.

**SYSTEMATICS AND REPRODUCTIVE BIOLOGY OF THE  
GENUS *MORUS* L. (MORACEAE)**

by

**MADHAV P. NEPAL**

B.Sc., Tri-Chandra College, Tribhuvan University, Kathmandu, Nepal, 1995  
M.Sc., Central Department of Botany, Tribhuvan University, Kathmandu, Nepal, 1997  
M.S., University of Northern Iowa, Cedar Falls Iowa, USA, 2003

A DISSERTATION

submitted in partial fulfillment of the requirements for the degree

**DOCTOR OF PHILOSOPHY**

Division of Biology  
College of Arts and Sciences

KANSAS STATE UNIVERSITY  
Manhattan, Kansas

**2008**

Approved by:

Major Professor

**Dr. Carolyn J. Ferguson**

## ABSTRACT

*Morus* L. (Moraceae) is a temperate and subtropical genus of ten to 15 species distributed in Asia, Africa, Europe, North, Central and South America. Despite its broad distribution and economic importance, it has received little attention from systematic botanists. Two species of this genus, the native *M. rubra* and the exotic *M. alba*, co-occur in eastern North America including the Flint Hills region of the Central Plains. In my dissertation research, I have conducted both species level and population level studies to obtain insights into the diversification of *Morus*. At the species level, my objectives were to re-evaluate the taxonomy and reconstruct the phylogeny of *Morus*. Based on herbarium and literature study as well as some field study, I recognize 13 species: eight species occurring in Asia, one in Africa and four in the New World. I used sequence data from the internal transcribed spacer (ITS) region of the nuclear ribosomal DNA and the *trnL-trnF* region of the chloroplast DNA to reconstruct the evolutionary history of *Morus*. The phylogenies were congruent and indicate a) a monophyletic core group of *Morus* with two well-supported geographical clades (one containing Asian taxa and one of New World taxa); and b) that *Morus*, as currently circumscribed, is non-monophyletic. At the population level, I studied sex expression pattern variation between the *Morus* native-exotic pair in the Flint Hills region, and assessed hybridization between these species at Konza Prairie Biological Station (KPBS). Both species are subdioecious, and Flint Hills populations exhibit significantly male-biased sex ratios, with sex expression being size independent. Approximately 10% of individuals of each species changed sex annually. In the population study at KPBS, I applied randomly amplified polymorphic DNA (RAPD) markers

and microsatellites. The *Morus* species were moderately ( $\theta^{\text{II}} = 0.079$ ; RAPD data) to highly differentiated genetically ( $F_{\text{ST}} = 0.233$ ; microsatellite data). Analysis of genetic structure suggested interspecific gene flow and indicated the presence of later generation hybrids. The presence of the exotic congener may affect the existence and genetic integrity of the native species. Overall, these studies contribute to our understanding of diversity in this interesting plant study system.

## TABLE OF CONTENTS

LIST OF FIGURES .....	x
LIST OF TABLES .....	xiii
ACKNOWLEDGEMENTS .....	xv
DEDICATION .....	xvii
PREFACE .....	xviii
CHAPTER 1 - INTRODUCTION .....	1
LITERATURE CITED .....	5
CHAPTER 2 - A TAXONOMIC STUDY OF THE GENUS <i>MORUS</i> L. (MORACEAE) .....	9
ABSTRACT .....	9
INTRODUCTION .....	10
Taxonomic History .....	11
Breeding system in <i>Morus</i> .....	14
MATERIALS AND METHODS .....	15
RESULTS .....	17
Taxonomy .....	17
Key to the species of <i>Morus</i> .....	18
Species Description .....	20
ACKNOWLEDGEMENTS .....	40
LITERATURE CITED .....	41
Appendix 1-1 History of major taxonomic treatments of <i>Morus</i> . .....	45
CHAPTER 3 - PHYLOGENY OF THE GENUS <i>MORUS</i> L. (MORACEAE LINK.) .....	46
ABSTRACT .....	46

INTRODUCTION .....	47
MATERIALS AND METHODS.....	50
RESULTS .....	53
DISCUSSION.....	56
ACKNOWLEDGEMENTS.....	62
LITERATURE CITED .....	63
 CHAPTER 4 - SEX EXPRESSION PATTERNS IN <i>MORUS RUBRA</i> AND <i>M. ALBA</i>	
(MORACEAE) IN THE FLINT HILLS REGION OF KANSAS.....	82
ABSTRACT.....	82
INTRODUCTION .....	84
MATERIALS AND METHODS.....	88
RESULTS .....	91
Sex ratio variation in <i>Morus</i> .....	92
Subdioecy in <i>Morus</i> .....	95
Plasticity of sex expression.....	96
Sex ratios, plant size and nearest neighbor distances .....	98
Aggregation of the sexes.....	100
Reproductive strategies for the <i>Morus</i> native-invasive pair .....	101
ACKNOWLEDGEMENTS.....	103
LITERATURE CITED .....	104
 CHAPTER 5 - NATIVE-EXOTIC HYBRIDIZATION IN <i>MORUS</i> .....	
ABSTRACT.....	144
INTRODUCTION .....	145



MATERIALS AND METHODS.....	147
Study area .....	147
Sample collection and DNA isolation .....	147
RAPD marker amplification and scoring.....	148
Microsatellite markers amplification and scoring .....	148
Data analysis .....	149
RESULTS .....	151
The RAPD and microsatellite polymorphism.....	151
Inferring hybridization.....	152
Population structure .....	153
DISCUSSION .....	153
Hybridization and genetic variation.....	153
Implications for systematics .....	155
Ecological effect .....	156
ACKNOWLEDGEMENTS.....	157
LITERATURE CITED .....	158

## LIST OF FIGURES

- Figure 3.1 Diagrammatic representation of amplified portion of a) the ITS region of the nuclear ribosomal DNA, and b) the *trnL-trnF* region of the chloroplast. .... 71
- Figure 3.2 Strict consensus of 80 most parsimonious trees based on the ITS data set with gaps coded as missing data. The numbers above the branches are bootstrap values based on 20,000 replicates. The maximum likelihood tree was in agreement in topology with slight change in resolution. .... 72
- Figure 3.3 Strict consensus of four most parsimonious trees based on the ITS data set with gaps coded as a new state. The numbers above the branches are bootstrap values based on 20,000 replicates. .... 73
- Figure 3.4 Single most parsimonious tree based on the *trnL-trnF* data set with gaps coded as missing. The numbers above the branches are bootstrap values based on 20,000 replicates. [The tree topology when analyzed gap as new state (5 parsimonious trees) remained the same.] ..... 74
- Figure 3.5 Single most parsimonious tree based on the combined data set. Numbers above the branches are bootstrap values based on 20,000 replicates and numbers below the branches are the posterior probabilities from Bayesian analysis. Maximum likelihood analysis yielded the same tree topology. The style length character (short style = ss, long style = ls) is indicated in parentheses after the taxon name. .... 75
- Figure 3.6 Parsimony informative characters in *Morus* ITS (ITS1 and ITS2) and *trnL-trnF* (*trnL* intron and *trnL-trnF* intergenic spacer) sequences. GmTotal and GnTotal indicate total

number of variable characters for gaps treated as missing and for gaps treated as new state, respectively. ....	76
Figure 4.1 Mapped <i>Morus alba</i> (▲) and <i>M. rubra</i> (●) trees in different populations of Flint Hills region of Kansas (M = male, F = female and H = hermaphrodite).....	114
Figure 4.2 Percentage of hermaphrodite and unisexual <i>Morus</i> trees in populations studied the Flint Hills region of Kansas. A = <i>M. alba</i> , and B= <i>M. rubra</i> . ....	127
Figure 4.3 Sex ratio deviation in <i>Morus</i> in the Flint Hills region of Kansas. 95% confidence intervals are indicated. The line at 0.5 on Y-axis represents a 1:1 ratio of male to female.	128
Figure 4.4 Sex ratio variation with 95% confidence intervals across 13 populations of <i>Morus alba</i> in the Flint Hills region of Kansas. ....	129
Figure 4.5 Sex ratio variation with 95% confidence intervals across nine populations of <i>Morus rubra</i> in the Flint Hills region of Kansas. ....	130
Figure 4.6 Size dependence of sexes in <i>Morus</i> in the Flint Hills region of Kansas. The symbols represent mean DBH with 95% confidence intervals. ....	131
Figure 4.7 Size (DBH) class distribution in <i>M. alba</i> . ....	132
Figure 4.8 Size (DBH) class distribution in <i>M. rubra</i> . ....	133
Figure 4.9 Relationship between nearest neighbor distance and size (DBH) in <i>Morus alba</i> . ...	134
Figure 4.10 Relationship between nearest neighbor distance and size (DBH) in <i>Morus rubra</i> .	135
Figure 4.11 Relationships between the nearest neighbor distance (NND) and sex types in <i>Morus</i> . The symbols denote mean with 95% confidence intervals. ....	136
Figure 4.12 The spatial distribution of male and female trees of <i>Morus alba</i> and <i>M. rubra</i> using a bivariate Ripley's K spatial analysis. Distance is on the x-axis, and L (d) on the Y-axis. Solid lines show the test statistic L(d); dashed lines show 99% confidence envelopes. ....	137

Figure 5.1 Distribution of <i>Morus</i> trees along Kings Creek area at KPBS.....	162
Figure 5.2 Bayesian clustering of <i>Morus</i> trees based on RAPD and microsatellite data. The proportion of inferred ancestry to be included in each cluster is on the y-axis. Each vertical column represents a different individual. Numbers on the x-axis represent sample numbers, followed by an indication of taxon identification in parenthesis: 1 = <i>M. rubra</i> , 2 = potential hybrid (based on morphology) and 3 = <i>M. alba</i> .....	163
Figure 5.3 Frequency distribution of alleles at microsatellite locus Mulstr2 in <i>M. alba</i> and <i>M. rubra</i> .....	164
Figure 5.4 Frequency distribution of alleles at microsatellite locus Multr4 in <i>Morus</i> .....	165
Figure 5.5 Frequency distribution of alleles at microsatellite locus Multr6 in <i>Morus</i> .....	166

## LIST OF TABLES

Table 3.1 Samples included in the phylogenetic study, with information on taxon name, native distribution, voucher information and voucher location.....	77
Table 3.2 Nucleotide sequences (10 bp) at the beginning and end of the amplified portions of ITS and <i>trnL-trnF</i> sequences for <i>Morus</i> . Partial sequences of designated regions are indicated by asterisks.....	78
Table 3.3 Sequence length of ITS and <i>trnL-trnF</i> in <i>Morus</i> . .....	79
Table 3.4 Statistics from parsimony analyses of different data sets. CI values listed are excluding uninformative characters.....	80
Table 3.5 Best substitution models with parameter values for <i>Morus</i> sequences, as determined using ModelTest. R (a) = [A-C], R(b) = [A-G], R(c) = [A-T], R(d) = [C-G], R(e) = [C-T]& R(f) = [G-T]. .....	81
Table 4.1 Inter-year sex ratio variation with 95% confidence intervals in <i>Morus</i> at KPBS. Similar letters denote non-significant values of p, and different letters denote significant p values. The hermaphrodites were not included in the analysis. Those with an asterisk have the sex ratio significantly deviated from unity. ....	142
Table 4.2 Change of sexual status in <i>Morus</i> at KPBS during 2005, 2006 and 2007. M = male, F = female, MF = hermaphrodite with mixed catkins, and M+F = hermaphrodite tree with male and female catkins on separate branches.....	143

Table 5.1 Randomly amplified polymorphic DNA (RAPD) primers, primer sequences and number of polymorphic loci in 45 individuals of *M. alba* and *M. rubra*. The numbers in parentheses represent species specific loci for *M. alba* and *M. rubra*, respectively..... 167

Table 5.2 Microsatellites primer sets (from Aggarwal et al., 2004) successfully amplified for *M. alba* and *M. rubra*. An asterisk shows the position where a sequence tag, M13 of 18 bp (5'-ACGACGTTGTAAAACGAC-3'), was added to the 5' end of the forward primer. .... 168

Table 5.3 Parental species and potential hybrids based on the proportion of inferred ancestry ( $q_i$ ) with *M. rubra* obtained from two different data sets. The value of  $q_i$  in between the mean values for *M. alba* and *M. rubra* was inferred for the potential hybrids. Those with an asterisk were identified as potential hybrids based on both data sets. .... 169

Table 5.4 Comparison of the four models tested in analysis of population genetic structure of *M. alba* and *M. rubra* at KPBS. (DIC = deviance information criterion, analogue of AIC;  $f$  = estimate of  $F_{IS}$ ;  $\theta^{II}$  = estimate of  $F_{ST}$ ). Values shown are the posterior means with their 95% credible intervals (in parentheses)..... 170

Table 5.5 Microsatellite loci used in the present study, including number of individuals scored ( $N$ ), number of alleles, observed ( $H_o$ ) and expected ( $H_e$ ) heterozygosities. .... 171

## ACKNOWLEDGEMENTS

I am very much grateful to my co-advisors, Drs. Carolyn J. Ferguson and Mark H. Mayfield, for providing me the opportunity to work with them, for training me as a botanist, and for their continued support, guidance and help in the laboratory, in the Herbarium and in the field. I would like to thank the other members of my supervisory committee, Drs. Karen Garrett, David Hartnett and Mark Ungerer, for their valuable time, support, and insights, and external chair Dr. Gerard Kluitenberg for conducting the final examination.

I appreciate the help of many people who assisted my research and I have acknowledged them at the end of each chapter. Many people have made my stay in the Division of Biology productive. I thank faculty, staff and graduate students of the Division of Biology (KSU), whose company has greatly enhanced my graduate experience.

I gratefully acknowledge support from the Konza Prairie Biological Station LTER program, the Kansas State University Herbarium (KSC; Division of Biology and Kansas Agricultural Experiment Station), and National Science Foundation (NSF) grant DBI-0544980 to Drs. Carolyn J. Ferguson and Mark H. Mayfield. Additional support was provided through an American Society of Plant Taxonomists (ASPT) Graduate Student Research Award, a Rotary Club International Graduate Student Research Award (Manhattan, KS, chapter), travel grants from the Terry C. Johnson Center for Basic Cancer Research (KSU) and a KSU Biology Graduate Student Association Graduate Research and Finishing Up Grant.

I thank my parents (Mr. Yoga Raj Nepal and Mrs. Yashoda Devi Nepal), sister (Sumitra Lamsal), brother (Hari Nepal) and our family friend Dr. Virginia Berg, who have provided valuable

support throughout my educational experience. Most importantly, I would like to thank my wife Kopila Nepal and my children Samyok (now five) and Sampada (two) for their love and support.



## **DEDICATION**

I dedicate this dissertation to my sister Sumitra Nepal (Lamsal).

## **PREFACE**

Each chapter is presented in the format of a journal manuscript. Therefore, some information is shared among chapters.

## CHAPTER 1 - INTRODUCTION

*Morus* L. (tribe Moreae Gaudich.; family Moraceae Link.) is a genus of ten to 15 species of trees (Berg, 2006) with a wide distribution in Asia, Europe, Africa, and North, Central and South America. Most of the taxa occur in the temperate regions of the Northern Hemisphere, with the greatest diversity in China. Only three species occur in the Southern Hemisphere: two in the montane forest of the Neotropics and one in tropical Africa. *Morus* species are economically important to the silk industry, as they are the only host plants for the silkworm (*Bombyx mori* L.) larvae (Watanabe, 1958). Additionally, species have been cultivated in many parts of the world for their edible fruits and as ornamental trees. The species have been described as dioecious or monoecious (Berg, 2001; A. Whittemore, Flora of Missouri treatment in prep., pers. comm), and are deciduous (except *M. mesozygia* in tropical Africa, which is evergreen in moist habitats and deciduous in drier habitats; Berg, 2005). Species exhibit cauducous stem apices, a catkin inflorescence, staminate flowers with inflexed stamens, pistillate flowers with almost equally branched stigmas, a fleshy perianth in the fruit, and an edible berry-like syncarp. Members of the genus are wind pollinated (Berg, 2001) and seeds are dispersed by birds (Stapanian, 1982). The base chromosome number is  $X = 14$  (Janaki-Ammal, 1948; Chen, 1993; Sandhu and Mann, 1988) and polyploids with counts as high as  $2N = 308$  (probably in cultivars; e.g. Basavaiah et al., 1990; Azizan and Sonboli, 2001) have been reported. *Morus* is an intriguing system for study because of its worldwide distribution, interesting breeding system, taxonomic uncertainty within the group, interspecific hybridization (Burgess et al., 2005), naturalization in areas remote from native ranges (Tojyo, 1985) and invasiveness of some taxa in novel habitats (e.g. *M. alba* in the United States; Hoffman and Kearn, 1997; Uva et al., 1997; Weber, 2003).

I have conducted both species level (Chapters 2 and 3) and population level studies (Chapters 4 and 5) to obtain insights into the diversification of this genus. Each of these studies has been written as a manuscript for future publication and compiled into the dissertation. Major objectives of each of these studies are presented below.

Taxonomy of *Morus* has been unstable, with great variation in the numbers of species recognized by different workers. For example, Linnaeus (1753) established the genus with seven species, Bureau (1873) recognized only five species, and Koidzumi (1917), who provided the most recent genus-wide treatment, recognized 24 species. The taxonomic difficulties in *Morus* may be due in part to its very wide distribution, overlapping ranges of distribution of some taxa, morphological plasticity and hybridization. The objective of **Chapter 2** was to re-evaluate taxonomy of the genus *Morus*. I studied herbarium specimens and conducted field observations in order to evaluate the existing taxonomic treatments and provide a framework toward monographic treatment of the genus.

Phylogenetic relationships within *Morus* have not been extensively explored although *Morus* has been included in several recent studies at higher taxonomic levels (Sytsma et al., 2002; Datwyler and Weiblen, 2004; Zerega et al., 2005). In **Chapter 3**, the main objectives were to employ nuclear and chloroplast DNA sequence data to reconstruct the phylogeny of *Morus* and apply that phylogeny to questions of biogeography, character evolution and taxonomy. For example, catkin size and style length as discussed in the treatments by Bureau (1873) and Koidzumi (1917) were considered, and the phylogeny enables evaluation of the utility of these characters in constructing a natural classification.

The genus also presents interesting questions at the population level. Two species of *Morus* occur in the United States: *M. rubra*, which is native to North America, and the

introduced *M. alba*, which is native to China but now occurs as a naturalized and sometimes invasive species (Hoffman and Kearn, 1997; Uva et al, 1997; Weber, 2003) throughout the range of *M. rubra*. Both *M. alba* and *M. rubra* are reported to be dioecious or monoecious (Berg, 2001; A. Whittemore pers. comm.). Characterization of the reproductive biology of *M. alba* as compared to that of the native *M. rubra* may be important to understanding success of the former in North America. I have addressed questions about breeding systems and the variation of sex expression patterns of the *Morus* native-invasive pair in **Chapter 4**. I conducted intensive fieldwork at Konza Prairie Biological Station (KPBS), a site at which two species co-occur in the tallgrass prairie ecosystem of the Flint Hills of Kansas, and also collected census data from an additional eight populations of *M. rubra* and 12 populations of *M. alba* in the region. My objectives were to rigorously assess breeding system and sex expression patterns (including any deviation from a male to female ratio of 1:1, with study over time and across populations in the larger region).

Interspecific hybridization can affect genetic identity and evolutionary history of hybridizing taxa (Anderson, 1949; Arnold, 1997). Such hybridization is of particular interest when it occurs naturally between a native species and its introduced naturalized congener. Hybridization of a native species with an exotic congener can induce invasiveness (Ellstrand and Schierenbeck, 2000), and pose a potential threat to the native through demographic swamping (see Burgess et al., 2006) and/ or genetic swamping (Arnold, 1997). Hybridization between the introduced *M. alba* and the native *M. rubra* has been documented in southern Ontario, Canada (Burgess et al., 2005), and I was able to cross individuals from KPBS. The main objective of **Chapter 5** was to use molecular markers including randomly amplified polymorphic DNA

(RAPD) and microsatellites to assess interspecific hybridization of *M. alba* and *M. rubra* at KPBS.

Overall, my dissertation research provides valuable insights into diversity of the genus *Morus* as well as interesting baseline data on dynamics at the population level, including breeding system, sex expression pattern variation and interspecific hybridization in eastern North America.

## LITERATURE CITED

- ANDERSON, E. 1949. Introgressive hybridization. Wiley, New York, USA.
- ARNOLD, M. L. 1997. Natural hybridization and evolution. Oxford series in ecology and evolution, Oxford University Press.
- AZIZAN, D. AND A. SONBOLI. 2001. Chromosome counts for five species of Moraceae from Iran. *Iranian Journal of Botany* 9: 103-106.
- BASAVAIHAH, S., B. DANDIN, A. DHAR AND K. SENGUPTA. 1990. Meiosis in natural docosaploid (22x) *Morus nigra* L. *Cytologia* 55: 505-510.
- BERG, C. C. 2006. *Morus*. Pp. 23-27 in Moraceae- genera other than *Ficus* C. C. Berg, E. J. H. Corner and F. M. Jarrett (eds.). Flora Malesiana. Volume 17. National Herbarium Nederland. Universiteit Leiden branch, Leiden, Austria.
- BERG, C. C. 2005. Moraceae diversity in a global perspective. Proceedings of an international symposium on plant diversity and complexity patterns; local, regional, and global dimensions at Royal Danish Academy of Science, Copenhagen, Denmark. *Biologiske Skrifter* 55: 423-440.
- BERG, C. C. 2001. Moreae, Artocarpeae, and Dorstenia (Moraceae) with introductions to the family and *Ficus* and with additions and corrections to Flora Neotropica Monograph 7. New York Botanical Garden Press, New York, USA.

BUREAU, E. 1873. Moraceae. Pp. 211-288 in *Prodromus systematis naturalis regni vegetabilis*.  
Volume 17. A. DeCandolle (ed). Paris, France.

BURGESS, K. S. AND B. C. HUSBAND. 2006. Habitat differentiation and the effect of  
hybridization on establishment of red mulberry (*Morus rubra* L.) in Canada. *Journal of  
Ecology* 94: 1061-1069.

BURGESS, K. S., M. MORGAN, L. DEVERNO AND B. C. HUSBAND. 2005. Asymmetrical  
introgression between two *Morus* species (*M. alba*, *M. rubra*) that differ in abundance.  
*Molecular Ecology* 14: 3471-3483.

CHEN, R.Y. 1993. Chromosome atlas of Chinese fruit trees and their close wild relatives.  
Chromosome atlas of Chinese principal economic plants. Volume 1. International  
Academic Publishers.

DATWYLER, S. L. AND G. D. WEIBLEN. 2004. On the origin of the fig: phylogenetic  
relationships of Moraceae from *ndhF* sequences. *American Journal of Botany* 91: 767-  
777.

ELLSTRAND, N. C. AND K. SCHIERENBECK. 2000. Hybridization as a stimulus for the  
evolution of invasiveness in plants? *Proceedings of the National Academy of Sciences* 97:  
7043-7050.

HOFFMAN, R. AND K. KEARNS. 1997. Wisconsin manual of control recommendations for  
ecologically invasive plants. Wisconsin Department of Natural Resources. Madison,  
Wisconsin.



- JANAKI-AMMAL, E. K. 1948. The origin of black mulberry. *Journal of the Royal Horticultural Society* 73: 117-120.
- KOIDZUMI, G. 1917. Taxonomy and phytogeography of the genus *Morus*. *Bulletin of Sericultural Experimental Station (Tokyo)* 3: 1-62.
- LINNAEUS, C. 1753. *Morus*. Species plantarum. Volume 2. Stockholm, Sweden. P.968.
- SANDHU, P. S. AND S. K. MANN. 1988. SOCGI plant chromosome number reports VIII. *Journal of cytology and genetics* 24: 179-183.
- STAPANIAN, M. A. 1982. A model for fruiting display: seed dispersal by birds for mulberry trees. *Ecology* 63: 1432-1443.
- SYTSMA, K. J., J. MORAWETZ, J. C. PIRES, M. NEPOKROEFF, E. CONTI, M. ZJHRA, J. C. HALL, AND M. W. CHASE. 2002. Urticalean rosids: circumscription, rosid ancestry, and phylogenetics based on *rbcL*, *trnL-F*, and *ndhF* sequences. *American Journal of Botany* 89: 1531-1546.
- TOJYO, I. 1985. Research of polyploidy and its application in *Morus*. *Japan Agricultural Research Quarterly* 18: 222-228.
- UVA, R. H., J. C. NEAL AND J. M. DITOMASO. 1997. Weeds of the Northeast. Cornell University Press. Ithaca, New York.
- WATANABE, T. 1958. Substances in mulberry leaves which attract silkworm larvae (*Bombyx mori* L.). *Nature* 182: 325-326.

WEBER, E. 2003. Invasive plant species of the world: a reference guide to environmental weeds.  
CAB International.

ZEREGA, N. J. C., W. L. CLEMENT, S. L. DATWYLER AND G. D. WEIBLEN. 2005.  
Biogeography and divergence times in the mulberry family (Moraceae). *Molecular  
Phylogenetics and Evolution* 37: 402-416.

## **CHAPTER 2 - A TAXONOMIC STUDY OF THE GENUS *MORUS* L. (MORACEAE)**

### **ABSTRACT**

*Morus* L. (Moraceae) is a temperate and sub-tropical genus distributed in Asia, Africa, Europe, North, Central and South America. Despite its broad distribution and economic importance (with a long history of cultivation for sericulture and edible fruits), species delimitation within *Morus* is poorly understood. The main goal of this study was to re-evaluate the taxonomy of the genus *Morus*, which I achieved by studying the relevant literature, examining herbarium specimens for morphology (particularly characters of the bud, leaf, inflorescence, style and infructescence), and conducting field observations. Based on these studies, 13 species are found to be easily recognized in the genus *Morus*: eight of these occur in Asia, one in Africa and four in the New World. Thirteen species is almost half of the number that was recognized in the most recent genus-wide treatment by Koidzumi (1917). The history of taxonomic studies on *Morus* is discussed, a key to the species recognized is provided, and the species are briefly described with information on type specimens, synonymy, distributions and a list of selected specimens examined. The presented information on the taxonomic history of the genus as well as the morphological data provides a taxonomic framework for the phylogenetic studies in this work and will facilitate future revision within this interesting genus.

Keywords: Moraceae, *Morus*, taxonomy.

## INTRODUCTION

*Morus* L. (Moraceae Link.) is a small genus of approximately ten to 15 species (Berg, 2006) distributed in the temperate and subtropical regions worldwide. A majority of the species occur in Asia, two species each in North America and in the subtropical/tropical montane forest of Central and South America, and one species in continental tropical Africa (Berg, 2005). Species such as *M. alba* L., *M. australis* Poiret. and *M. nigra* L. have been cultivated for centuries because the leaves are used to feed silkworm (*Bombyx mori* L.) larvae (Watanabe, 1958). Additionally, they have been cultivated in many parts of the world for their edible fruits and as ornamental trees; they have become naturalized in several regions throughout the world. Artificial hybridization between introduced *M. nigra* and the native species was very common in East Asia (Tojyo, 1985) for improving cultivars for the silkworm industry. Recently, natural hybridization between the introduced *M. alba* and the native *M. rubra* in North America has been documented (see Chapter 4; Burgess et al., 2005).

Natural interspecific hybridization can pose challenges to taxonomic investigation in groups such as *Morus*. Taxonomic confusion in *Morus* is also likely in part due to the fact that species can exhibit a great deal of variation in characters, with character states overlapping among taxa. Bureau (1873) seemed to have faced this challenge, and he "sunk" dozens of taxonomic entities previously recognized at the species level to the levels of varieties and sub-varieties within *M. alba*.

There are only two genus-wide revisions since the genus *Morus* was established by Linnaeus in 1753: those of Bureau (1873) and Koidzumi (1917). Some species, however, have been treated regionally in floras more frequently (e.g. Berg, 1998; Berg, 2001; Wunderlin, 1997; Zhou and Gilbert, 2003; Berg, 2006).

Throughout this chapter, herbaria are discussed using their internationally recognized acronyms following Index Herbariorum (Holmgren et al., 1990): A: Arnold Arboretum; GH: Gray Herbarium, Harvard University; MO: Missouri Botanical Garden; KSC: Kansas State University; NY: New York Botanical Garden; P: Herbier National de Paris (National Herbarium of Paris); LINN: Herbarium of the Linnaean Society of London; B: Berlin Herbarium.

## **Taxonomic History**

Taxonomy of the genus *Morus* has been unstable, with great variation in the numbers of species recognized. An overview of taxonomic recognition in *Morus* is presented in Appendix 1 (wherein authorities are provided for all taxa). Linnaeus (1753) established the genus with seven species: *M. alba*, *M. indica*, *M. nigra*, *M. papyrifera*, *M. rubra*, *M. tartarica* and *M. tinctoria*. Two of these, *M. papyrifera* and *M. tinctoria*, were later moved to *Broussonetia* and *Maclura*, respectively. Linnaeus discussed the characters of fruit color, leaf shape and leaf hairs and gave a short diagnosis of each species. The first comprehensive treatment of the genus *Morus* was presented by Bureau (1873) and was primarily based on features of the leaves and pistillate catkins. He recognized five species with 19 varieties and 13 sub-varieties. Varieties within *M. alba* were classified into two informal groups: one of varieties with oblong and short cylindric pistillate catkins and syncarps and the other of varieties with long cylindric pistillate catkins and syncarps. He further divided the former group of varieties into two subgroups: one of varieties with short styles (<1 mm) and the other of varieties with long styles (>1 mm). The relevant names and groupings are presented in Appendix 1.

Bureau recognized dozens of previously recognized species, including the Linnaean species *M. tatarica* and *M. indica*, as varieties of *M. alba*. The four other species he recognized were: *M. nigra* (recognizing an additional variety, var. *laciniata*), *M. rubra* (including var. *incisa*

and var. *tomentosa*), *M. celtidifolia* and *M. insignis*. Greene (1910) studied *Morus* in the southwestern United States, and split *M. microphylla* sensu Buckley (1862) into 14 species (i.e. *M. albida*, *M. arbuscula*, *M. betulifolia*, *M. canina*, *M. goldmanii*, *M. confines*, *M. crataegifolia*, *M. grisea*, *M. microphilyra*, *M. microphylla*, *M. pandurata*, *M. radulina*, *M. vernonii*, *M. vitifolia*). Schneider (1917) studied E. H. Wilson's collection of *Morus* from China housed at A. He described one new species, *M. notabilis*, upgraded Bureau's *M. alba* var. *mongolica* to the species level, and enumerated *M. alba*, *M. acidosa* and *M. cathayana* based on this collection.

Koidzumi (1917) presented the most recent genus-wide treatment and recognized 24 species in two sections: *Dolichostylae* Koidz. and *Macromorus* Koidz. These sections were recognized based on the character of the style length: the former with the long style and the latter section with the short style. In his classification, Koidzumi promoted some of Bureau's varieties to the level of species. Leroy (1949) classified *Morus* into three subgenera: *Eumorus* J.F. Leroy, including all Asian and North and Central American *Morus*, *Gomphomorus* J.F. Leroy, including South American species, and *Afromorus* A. Chev., which includes African species.

In addition to traditionally employed characters in *Morus*, several attempts have been made to identify additional taxonomically useful characters that would enable workers to better distinguish the species. For example, Hotta (1954) studied variation in shape and position of leaf cystolith cells in *M. alba*, *M. australis* and *M. mongolica*. Katsumata (1971) studied size and shape variation of leaf ideoblast and used this character to classify several races of *M. alba* and *M. australis*. However, their results showed that these characters were variable and often transcended the species boundaries. Venkataramana (1982), in his review article on wood phenolics of the family Moraceae, discussed three types of bark flavonoids present in *M. rubra* but absent in Asian species examined (*M. alba*, *M. serrata*, *M. laevigata* and *M. indica*). He

further showed that some other flavonoids in the bark such as mulberrin, mulberrochromene, cyclomulberrin, cyclomulberrochromene and three other unnamed pigments present in Asian species were absent in *M. rubra*. There were five other wood phenolics found to be present in different concentrations in Asian species and absent in *M. rubra*. If phenolic differences are consistent within species (infraspecific variation, if assessed, was not discussed), it may be useful to explore these chemical characters as potential taxonomic characters.

Recent taxonomic work on *Morus* includes description of new species such as: *M. deqinsis*, *M. liboensis* and *M. jimpinensis* and *M. barkamensis* by Chang (1984), *M. mongolica* var. *hopeiensis* and *M. australis* var. *incisa* by Wu and Chang (1989) and *M. gongshanensis* and *M. mongolica* var. *longicaudata* by Cao (1991). Revision and lectotypification have been accomplished for: *M. nigra* L. (Bhopal and Chaudri, 1977), *M. alba* L. (Browicz, 1982; Rao and Jarvis, 1986), *M. indica* L. and *M. tatarica* L. (Rao and Jarvis, 1986), *M. insignis* (Berg, 1998) and *M. rubra* (Reveal, 2007). Recent regional taxonomic work on *Morus* also includes revision of *Morus* in Africa by Berg (1988), in North America by Wunderlin (1997), in the Neotropics by Berg (2001), and in China by Zhou and Gilbert (2003). Zhou and Gilbert (2003) recognized 12 species in China alone; most of these species had been recognized by Koidzumi (1923), and the new species of Chang (1984), Wu and Chang (1989), and Cao (1991) were also included. Berg (2001) studied the genus *Morus* in the Neotropics, and recognized *M. insignis* and *M. celtidifolia* from Central and South America. Berg (2005) estimated the number of species worldwide as ca. 12 (eight in Asia, one in Africa and three in the New World), and later estimated the worldwide number at 10-15 (Berg, 2006); however, he did not provide a list of all recognized species in either of these publications. Currently, the International Plant Names Index (IPNI, accessed through the Global Biodiversity Information Facility [GBIF] data portal, <http://data.gbif.org>

[/datasets /resource/40](#), 26 February 2008), which endeavors to list all validly published names, contains 257 names in *Morus*, most of which are either synonyms or names of infrataxa.

Species including *M. alba*, *M. australis*, and *M. nigra* have long been subjects of domestication and artificial selection. Their introductions to several countries in the world, domestication, escape from cultivation (with seeds in the millions dispersed by birds and bats; see Tang et al., 2007) and establishment in the natural habitat of other species may have contributed to taxonomic confusion and may present challenges for conservation of the native species. Hybridization between two species, the native North American *M. rubra* and the introduced *M. alba*, has been well documented in Canada (Burgess et al., 2005). Interspecific hybridizations of *M. alba* with *M. australis* and *M. serrata* have also been shown to produce a high percentage (>80%) of fertile seeds (whereas a cross between *M. alba* and *M. macroura* produced no fertile seeds; Das and Krishnaswami, 1965). According to Tojyo (1985), *M. nigra* (2N=308), introduced to Japan from western Asia, had been hybridized with the native species to produce varieties exhibiting several ploidy levels. Many introduced *Morus* species including *M. alba* are easily and vegetatively propagated and can be opportunistically apomictic (Griggs and Iwakiri, 1973), which may increase their adaptability in the novel habitats. Considering these facts, clarification of taxonomy of the native species is an important step toward protection of native species.

Overall, the taxonomic history of this interesting genus makes *Morus* an excellent candidate for a genus-wide taxonomic treatment.

### **Breeding system in *Morus***

Species in the genus *Morus* have been known to be either dioecious or monoecious (Berg, 2001, Whittemore, Flora of Missouri treatment in prep, pers. Comm.; Wunderlin, 1997;



Zhou et al., 2003). As discussed in Chapter 4, a detailed study of the breeding systems of *M. alba* and *M. rubra* in the Flint Hills region of Kansas (United States) demonstrates subdioecy in these species. Populations of each species have a strongly male-biased sex ratio with approximately 10% of the individuals switching their sex from a given year to the next. Subdioecy is a breeding system characterized by the majority of the individuals in a population being unisexual, with some being hermaphrodite and some that are inconstant for sex expression. Based on that study, in my species description I have described the breeding system of *M. rubra* and *M. alba* as subdioecious. The breeding system description for other species is reported based on study of the specimen and label data.

My main objective in this study was to re-evaluate the taxonomic status of members of the genus *Morus* worldwide using available resources (herbarium specimens, online databases and field observations). It is likely that the diversity of *Morus* in remote areas of Asia and the broad geographic distribution of the genus as a whole have hindered thorough taxonomic treatment. Although I was also limited in my abilities to thoroughly study the group (e.g. I conducted field work only in the central United States: I studied material only from US herbaria), the taxonomic overview presented here forms a strong basis for monographic work.

## **MATERIALS AND METHODS**

Over 1300 specimens were examined (801 from GH, 350 from MO, and 174 from KSC). I used morphological characters of the bud (size, bud-scale banding), of the leaf (base, petiole, hair distribution, size, venation, margin and apex), of the inflorescence (shape, size, number and type of unisexual flowers), of the style (length) and of the infructescence (shape, size, color) for species identification and description.

*Morus alba* and the native *M. rubra* co-occur in many plant communities in the Flint Hills region. Field observation of 13 populations of *M. alba* and nine populations of *M. rubra* complemented herbarium study for these species. All herbarium specimens collected were deposited at KSC.

For all material studied, morphological characters of the stem, stipule, bud, bark, branch, leaf, inflorescence, style and fruit were thoroughly examined. Flowering and fruiting time were obtained from the specimen label data. Some features that were not revealed by the specimens were adopted from various authors such as information on habit and bark (Bureau, 1873; Berg, 1977; Zhou and Gilbert, 2003); bud scales (Wunderlin, 1997; Zhou and Gilbert, 2003); and chromosome numbers.

Consultation of floras from regions around the world, personal communication with experts and online resources (herbarium databases) all greatly facilitated this study. Photographs or drawings of some type specimens were directly downloaded from the websites of different herbaria (US, <http://www.nmnh.si.edu/botany>; MO, <http://www.mobot.org>; NY, [http://sweetgum.nybg.org/vh/specimen\\_list.php](http://sweetgum.nybg.org/vh/specimen_list.php), P, <http://www.mnh.n.fr>; LINN, [http://www.linnean-online.org/view/plants\\_alpha/morus.html](http://www.linnean-online.org/view/plants_alpha/morus.html)) or obtained directly from herbarium personnel. All images and drawings examined were deposited at KSC.

The species recognition in this study was based on the literature review and study of herbarium specimens available in the western herbaria. This study had a limited access to the specimens from Asia, and many of the taxa were not observed in the field by the author. An intensive study of Asian taxa in the future will be necessary to complement the findings from the present study for an improved understanding of the taxonomic diversity in the genus.

## RESULTS

### Taxonomy

In total, 13 species of the genus *Morus* are recognized by the present study. A brief description of the genus, a key to the species recognized, and a short description of each species are presented below.

*Morus* Linnaeus in *Species Plantarum* 2: 986 (1753); Bureau in DC, *Prodromus* 17: 237 (1873). Koidzumi, *Bulletin of Sericultural Experimental Station* (Tokyo) 3:1 (1917). Nakai, *Journal of Arnold Arboretum* 8:234 (1927). Berg, *Flora Neotropica Monograph* 83: 25 (2001). *Flora Malesiana* 17:23 (2006). [Type species: *M. nigra* L. Lectotypes: designated by Britton and Brown, *Flora of the Northern United States*. Second ed., 1: 631 (1913); by Bhopal and Chaudhri, *Pakistan Systematics* 1(2): 29 (1977)].

Dioecious, subdioecious or monoecious shrubs to trees, with milky sap. Terminal bud in the stem dies. Bud conical or ovoid with outer bud scales pubescent with a dark, brown or white apical margin. Stipules caducous to semi-persistent, pubescent. Leaves alternate, stipulate, cauducous. Leaf blade ovate to lanceolate, unlobed or lobed, margin serrate to dentate to crenate; primary veins usually 3, secondary veins pinnate. Inflorescences pedunculate, axillary, with 1-5 catkins produced per bud; staminate catkins, cylindric; pistillate catkins oblong to capitate. Flowers: staminate and pistillate on the same or different catkins or sometimes even on different branches or often in different plants. Staminate flowers: with four perianth parts; imbricate; stamens inflexed in bud; anthers dithecos, introse and dorsifixed; pistillode present. Pistillate flowers: with four perianth parts; imbricate; ovary superior; style long/short/absent; stigma 2-branched. Infructescence oblong or cylindric of sub-drupaceous fruits each enclosed by enlarged

succulent perianth. Base chromosome number (X) = 14, 2N varies from 28, 42, 56, 42, 84 to 308 (Janaki-Ammal, 1949; Azizan, 2001).

**Distribution:** Broad in temperate and subtropical regions, montane forests in the tropics and subtropics and lowlands of tropical Africa.

**Key to the species of *Morus***

- 1. Leaf ovate to orbicular, secondary venation (from the mid-rib) less prominent and scalariform except two to three pairs towards the leaf apex. Peduncle longer than inflorescence .....**7. *M. mesozygia***
- 1. Leaf ovate to lanceolate, secondary venation prominent and not scalariform. Peduncle shorter or equal to inflorescence (2)
  - 2(1). Pistillate flowers with distinctly long style (>1 mm) (3)
  - 2. Pistillate flowers with no or short style (<1 mm) (5)
  - 3(2). Leaf margin with acute dentation characterized with a short to long seta.....  
.....**9. *M. mongolica***
  - 3. Leaf margin without seta as mentioned above (4)
  - 4(3). Infructescence elongated, < 2 cm (excluding peduncle), leaf shape variable .....  
.....**2. *M. australis***
  - 4. Infructescence cyndric, 2-4 cm, leaf broadly ovate with cordate base.....  
.....**11. *M. notabilis***
  - 5(2). Infructescences longer than 2 cm (excluding peduncle) (6)
  - 5. Infructescences less than 2 cm. (8)
  - 6(5). Infructescences 2-5 cm. ....**3. *M. cathayana***
  - 6. Infructescence 5 -16 cm or longer. (7)

- 7(6). Axillary bud minute, petiole 1- 2.5 cm, leaf blade usually lanceolate to elliptic, margin minutely serrate to subentire, peduncle <0.5 cm.....**5. *M. insignis***
7. Axillary bud larger, petiole 2.5-6 cm, leaf blade ovate to broadly ovate, margin sub-entire to minutely serrate, peduncle >0.5 cm.....**6. *M. macroura***
- 8(5). Leaf blade usually bright green, adaxially usually glabrous, abaxially sparse pubescent along the veins, leaf margin irregularly dentate, leaf apex usually obtuse.....  
.....**1. *M. alba***
8. Leaf blade usually dull green, adaxially slightly scabrous, abaxially pubescence all over, leaf margin with acute serrations, leaf apex acute to subcaudate.( 9)
- 9(8). Leaf margin with regularly spaced triangular teeth, bud scales and stipules semi persistent  
.....**13. *M. serrata***
9. Leaf margin not as above, bud scales and stipules immediately cauducous (10)
- 10(9). Leaves broadly cordate at base, glabrous adaxially or slightly scabrous, sparsely pubescent along the veins abaxially, the leaf margin with wider teeth. Infructescence oblong, 1.5-2.5 cm wide, up to 2.5 cm; stigma long pubescent.....**10. *M. nigra***
10. Leaves deeply cordate at base, densely pubescent along the veins adaxially, sparsely pubescent in the interveinal areas. Infructescence cylindric, 0.5-2 cm wide, up to 2 cm; stigma short pubescent (11)
- 11(10). Leaf blade abaxially pubescent, adaxially usually scabrous. Stem branches are horizontally spread in a characteristic pattern. Fruits compactly arranged in a fleshy cylindrical infructescence .....**12. *M. rubra***
11. Leaf blade adaxially slight to harsely scabrous, fruits loosely arranged, globose or capitate, not as fleshy as in *M. rubra* (12)

- 12(11). Shrub to small tree, mature leaf blade less than 6 cm, ovate to ovato-lanceolate, abaxially scabrous or pubescent, infructescence small (ca. 0.5 cm; excluding the peduncle) adaxially harshly scabrous .....**8. *M. microphylla***
12. Small to big tree, mature leaf up to 4-20 cm, abaxially harshly pubescent to scabrous, oblong to lanceolate, base usually unequal to cordate, adaxially glabrous to slightly scabrous. Infructescence 1-2 cm sometime longer .....**4. *M. celtidifolia***

## Species Description

1. ***Morus alba*** Linnaeus in *Species Plantarum* 2: 986 (1753). [Bureau in DC, *Prodromus* 17:238 (1873), Koidzumi, *Bulletin of Sericultural Experimental Station* (Tokyo) 3: 1 (1917). Nakai, *Journal of Arnold Arboretum* 8:234 (1927). Berg in *Flora Neotropica Monograph* 83: 25 (2001), Zhou and Gilbert in *Flora of China* (2003). Berg in *Flora Malesiana* 17:23 (2006).] (Lectotype: Herb. Linn. No. 1112.1 (LINN), upper left specimen by Rao and Jarvis, *Taxon* 35: 705 [1986]).

**Synonyms.** *M. pendula* Sudw., *M. alba* Sudw., *M. atropurpurea* Roxb., *M. alba* var. *vulgaris* Bur., *M. arabica* Koidz., *M. bullata* Balb. ex Loud., *M. byzantina* Sieber ex Steud., *M. colombassa* Hort. ex Dippel, *M. constantinopolitana* Hort. ex Poir., *M. cucullata* Bonaf., *M. dulcis* Royle, *M. fastigiata* Hort. ex dippel, *M. furcata* Hort. ex Steud., *M. guzziola* Hort. ex Steud., *M. heterophylla* Loud., *M. hispanica* Hort. ex Loud., *M. italica* Poir. ex Lam., *M. japonica* Audib. ex Ser., *M. kaki* Hort. ex Lavalley, *M. laciniata* Audib. ex Loisel., *M. latifolia* Hort. ex Spach, *M. levasseurei* Hort. ex Lavalley, *M. lhou* Koidz., *M. lucida* Hort. ex Loud., *M. macrophylla* Hort. ex Steud., *M. mariettii* Hort. ex Steud., *M. mauritiana* Jacq., *M. membranacea* Hort. ex Steud., *M. moretti* Audib. ex Bur., *M. multicaulis* Raf., *M. nana* Audib. ex Loisel., *M.*

*nigriformis* Koidz., *M. patavia* Audib. ex Dippel, *M. patavina* Hort. ex Spach., *M. pumila* Balb., *M. romana* Lodd. ex Spach, *M. rubra* Lour., *M. serotina* Mart. ex Bur., *M. sinensis* Hort. ex Loud., *M. stylosa* Ser., *M. subalba* Hort. ex Steud., *M. venassaini* Hort. ex Steud., *M. venosa* Delile ex Spach.

**Description.** Subdioecious, trees up to 12m. **Bark:** gray, shallow smooth, shallowly furrowed with thick and solid ridges with reddish tan or yellow. **Branches:** irregular or diffused, shorter or slightly condensed in bushy trees, finely pubescent to densely pubescent when young. **Buds:** terminal buds on the stem and branches shed. Axillary buds reddish brown, 1-4 mm, ovoid, greenish white to creamy with white band on the apical margin, pubescent. **Leaves:** leaf scar slightly raised, almost circular. Stipulate, stipules greenish white to whitish brown, cauducous, thin pubescent, lanceolate to linear, 2-3.5 cm. Petiole densely pubescent, 0.5-5 cm. Leaf tri-nerved, two lateral veins running to 1/3- 2/3 of the lamina, the secondary veins runs acute (30-60°) to the mid-veins, blade, ovate to broadly ovate, lobed (1-5 sinuses) or unlobed, 2-20 cm x 1.5-18 cm, base rounded to ± cordate, margins crenate, serrate to dentate, often irregularly tapering to obtuse tiny lobe, dentate to doubly dentate, sometime sparsely serrate, teeth blunt, apex usually obtuse sometime acute. Adaxial surface glabrous and bright green, abaxial pubescent along the veins often much contrasting and dull green. **Inflorescence:** catkins; staminate catkins (1-7/node) with 5-30 pedunculate flowers, peduncle 0.5-2 cm, pendulous, 1-5 cm, pubescent with white hairs. Pistillate catkins (1-5/node) with 3-20 pedunculate flowers, peduncle 1-3 cm, pubescent, 1-3 cm. **Flowers:** staminate flowers whitish or greenish yellow: perianths pale green, broadly elliptic; filaments inflexed in bud; anthers globose to reniform. Pistillate flowers greenish white: perianths ovoid, oblong; style absent to up to 0.7 mm; stigma branched, longer stigmas in shrubby strains with lobed leaves. **Fruits:** infructescence loose to

tightly arranged in an oblong structure, white/dark red/pink/purple/black when mature. Ovoid or ellipsoid, 1-3 cm (excluding peduncle). **Fowering:** March-May. **Fruiting:** April- July.

**Distribution.** Native to South and Central China. Cultivated in several countries worldwide.

**Economic importance.** The leaves provide food for silkworms, the bark fiber is used for textiles and paper, and the bark is also used for medicine.

**Specimens examined.** CHINA. –Nanking: Chekiang, *Ho* 985 (GH), April 22, 1932. Shantung: *Cheo and Yen* 175 (GH), 1936. Western Hupei: *Wilson* 3308 (GH), May 1907. –Hong Kong: *Hu* 5015 (GH), March 9, 1968. –Hupei: without date and number (GH). –Kwanf Tung: Honam Island, *Levine* 329 (GH), February 10, 1917. –Southern Shansi: *Tang* 680 (GH), May 3, 1929. –Szechuan: *Chengtu* 5927 (GH), April 21, 1937. –Tibet: Tali range, *Bulley et al.* 4732 (GH), July 1907. –Yunnan: Likiang, *Rock* 8489 (GH), 1923. –Yunnan: *Tsiang and Wang* 16221 (GH), May 1939. –Yunnan: *Ten* 49 (GH), March 10, 1916. USA. –Kansas: KPBS (39.1036 °N and 96.597 °W), *Nepal* 642 (KSC), April 19, 2005. **Images examined.** LINN 1112.1 (LINN).

2. *Morus australis* Poiret. in *Encycl. (Lamarck)* 4: 380. 1797. [Type : P]

**Synonyms.** *M. acidosa* Griffith, *M. alba* L. var. *indica* Bur., *M. alba* var. *nigriformis* Bur., *M. alba* var. *stylosa* Bur., *M. atropurpurea* Roxb., *M. australis* var. *hachijoensis* (T. Hotta) S. Kitamura, *M. australis* var. *hastifolia* (Z. Y. Cao) Z. Y. Cao, *M. australis* var. *incisa* C. Y. Wu, *M. australis* var. *inuitata*, (Levl.) C. Y. Wu, *M. australis* var. *linearipartita* Z. Y. Cao, *M. australis* var. *oblongifolia* Z. Y. Cao, *M. australis* var. *trilobata* S. S. Chang, *M. bombycis* Koidz., *M. bombycis* Koidz. var. *flexuosa* Hotta, *M. bombycis* Koidz. var. *ikuchuensis* Hotta, *M. bombycis* Koidz. var. *mikamiana* Hotta, *M. bombycis* Koidz. var. *saishuensis* Hotta, *M. bombycis*



var. *tiliifolia*, Koidz., *M. formosensis* Hotta, *M. hachijoensis* Hotta, *M. hastifolia* Wang & Tang ex Z. Y. Cao, *M. inusitata* H. Lev., *M. kagayamae* Koidz., *M. longistylus* Diels, *M. tiliaefolia* Makino, *M. trilobata* (S. S. Chang) Z. Y. Cao, *M. wallichiana* Koidz.

**Description.** Dioecious, shrubs or small trees up to 7 m. **Bark:** usually gray or brown. Lenticels both round and elliptic. **Branches:** gray or brown, glabrous, rarely pubescent, fewer than *M. alba*, longer internodes. **Buds:** conical to cylindrical with broader base to tapering tip, 0.5-2 mm, usually incurved, bud scale brown with white band on the apical margin. **Leaves:** leaf scars shallow, circular and not as distinct as in *M. alba*. Stipulate, stipules pubescent, 0.5-1 cm, lanceolate to linear lanceolate, petiole pubescent, 0.5-1.5 cm. Leaf blade lanceolate to broadly ovate, simple or lobed with 3-5 sinuses, 1-7 x 0.4-4 cm, leaf base cordate or rounded, margins usually regularly serrated, apex subcaudate to acuminate; surfaces abaxially pubescent all over but more along the veins, adaxially slightly to strongly scabrous. Leaf blade, tri-nerved, the lateral veins run 1/3 to 2/3 of the leaf blade, secondary veins fewer well-spaced at 30-60° with the mid-vein. Veins abaxially more prominent. **Inflorescence:** catkins; staminate catkins pedunculate, peduncle 0.2-0.9 cm, 1 per node, 1-1.5 cm, 5-20 flowers; pistillate catkins globose to cylindrical, pedunculate, peduncle 0.2-0.5 cm, shorter than pistillate catkin, 1 per node, 0.5-1 cm, 3-10 flowers. **Flowers:** staminate flowers: perianths green, ovate; anther yellow. Pistillate flowers: perianths dark oblong, style long, 0.2-0.8 cm, bifid stigma. **Fruits:** infructescences globose, oblong, green, white, red or dark purple, 0.5-1.5 cm x 0.5 cm, achenes yellowish brown. **Flowering:** March-April. **Fruiting:** April-May.

**Distribution.** China (Hupei, Pingtang), Bhutan, India, Japan, Korea, Myanmar and Nepal.

**Economic importance.** In China, the bark fibers are used for making paper and the fruit are edible (Zhou and Gilbert, 2003).

**Specimens examined.** CHINA. –Hupei, *Wilson 3301* (GH), May-June, 1907. –Szechuan: *Yu 622* (GH), May 3, 1932. –Chekiang: *Chen 1240* (GH), April 30, 1933. –Kwangsi: *Chung 81558* (GH), May 12, 1936. –Tsingchen: *Teng 90376* (GH), May 28, 1936. NEPAL. –Eastern Nepal: Dharapani-Sanguri Bhanjyang, *Kanai et al.* (without number) (GH), without date. –Namochee: *Rukma 1626* (GH), October 5, 1965. TAIWAN. –Hsiang: *Liu 104* (GH), March 25, 1993. JAPAN. –Okinawa: Kadena, *Moran 4965* (GH), March 5, 1955. –Tohoku, *Yateishi et al. 15613* (GH), May 6, 1991.

**3. *Morus cathayana*** Hemsley in *J. Linn. Soc., Bot.* 26: 456 (1894). [Type: K, GH]

**Synonyms.** *M. cathayana* var. *gongshanensis* (Z. Y. Cao) Z. Y. Cao, *M. cathayana* var. *japonica* (Makino) Koidz., *M. chinlingensis* C. L. Min, *M. gongshanensis* Z. Y. Cao, *M. rubra* L. var. *japonica* Makino, *M. tilaefolia* Makino.

**Description.** Dioecious or monoecious, shrubs or small trees up to 7 m. **Bark:** gray to dark brown. **Branches:** young branches pubescent with oblong lenticels, internodes longer. **Buds:** oblong to subglobose, brown, up to 4 mm, bud scale with white band on the apical margin, acute apex, narrowly supported. Buds differ from *M. alba* with relatively larger size, and dark-brown apical margin in the budscale. **Leaves:** stipulate, stipules lanceolate, up to 1.5 cm. Petiole 1-3.5 cm, pubescent. Leaf blade broadly ovate, broadly ovate to ± orbicular, sometimes lobed (2-3 sinuses), 8-20 x 6-15 cm, base cordate to truncate, margins serrate to serrate-crenate, serrations spaced out, apex acute to acuminate; surfaces abaxially pubescent with densely white hairs all over, adaxially scabrous, and interveinal areas pubescent. Lateral veins running up to ½

of the leaf, the secondary veins at 45-75 ° to the mid-rib. **Inflorescence:** catkins; staminate catkins: pedunculate, 1.5-3.5 cm, 3-6 cm (excluding peduncle), one to two catkins/node; pistillate catkins: pedunculate, 1-1.5 cm, 2.5-5 cm, cylindric, one catkin/node. **Flowers:** staminate flowers: 35 to 40 per catkin, perianth ovate, stamens 4; pistillode small. Pistillate flowers: 15 to 35 per catkin, perianths obovate, styles short; stigmas 2-branched. **Fruits:** mature infructescence red, dark purple or white, 2.5-4 cm. **Flowering:** March-May. **Fruiting:** April-June.

**Distribution.** China, Japan and Korea.

**Specimens examined.** CHINA. – Huangshan: Tan Krou, *Deng and Yao 79132* (GH), May 15, 1979. –Hupei: *Chow 231* (GH), 1934; *Dong 686* (MO), May 10, 1995; *Henry 6378* (GH); 1885-88; *Wilson 365* (GH), April, 1900; *Xia and Ren 123* (GH), June 7, 1999. –Szechuan: *Wang 20742* (GH), May 10, 1930; *Wilson 9310* (GH), May 22, 1908. –Tschen-Keou-Tin: *Farges 1477* (GH), May 1899. JAPAN – Hongsu: *Dequichi amd Tsugaru 3779* (GH), May 19, 1983. – Tsushima, *Ohashi and Sohma 10666* (GH), June 26, 1968.

**Notes.** In the original description of *M. cathayana*, Hemsley listed A. Henry's collection numbers 5543, 5860 and 6378 as the type specimens. He also mentioned four other specimens (Fortune 35, and collection numbers 1409, 5435 and 5487 of A. Henry from Hupei, China) which he suggested may belong to a different species. I examined *Henry 6378* and *1409* (GH), and found all of these specimens to be indistinct from the other specimens listed by Hemsley in the original description.

Some specimens collected by H. T. Tsai in 1933 from Yunnan, and those collected by Hu and Hu in 1969 from Hong Kong, showed intermediacy between *M. alba* and *M. australis*,

particularly in leaf margin, venation and the style length characters. Hybridization between these two species should be assessed.

4. *Morus celtidifolia* Kunth in Humboldt and Bonpland, *Nov. Gen. Sp. Sp.* 2: 27 (1817). [Type: P]

**Synonyms.** *M. corylifolia* Kunth., *M. mexicana* Benth.

**Description.** Dioecious or monoecious trees up to 10 m. **Bark:** grayish white, lenticels circular to elliptic. **Branches:** gray or dark brown, usually with longer internodes, glabrous or sparsely pubescent. **Buds:** smaller to big <1 mm-1.2 cm, conical or ovoid, bud scale white with brown band or brown with white band on the apical margin. **Leaves:** leaf scar circular, deeply concave, and almost circular. Stipulate, stipules pubescent, lanceolate, up to 1 cm. Petiole pubescent, 1-4 cm. Leaf blade lanceolate to oblong elliptic, rarely lobed (3-5 sinuses) 4-25 cm x 1-8 cm, base truncate to  $\pm$  cordate, margin serrate, apex usually acuminate, sometimes subcaudate. Lateral veins run up to two-third of the leaf blade, often look converging towards the apex, secondary veins at  $45^\circ$  with the mid-rib. Adaxial surface usually glabrous with few hairs, abaxial surface pubescent along the veins and the veins are more prominent, often yellow. **Inflorescence:** catkins: unisexual, or cosexual; staminate: pedunculate, peduncle 0.5- 2.5 cm, 2.5-3 cm, two/node, numerous; pistillate: pedunculate, peduncle 0.5-2 cm, 1-4.5 cm, one/node, fewer, cylindric. Staminate flowers: 10-30 per catkins, widely spaced, sometime bud scale retained, perianth ovate to elliptic; pistilode present. Pistillate flowers: 15-20 per catkin, widely spaced, perianths ovoid, style very short or absent; stigma branched. **Fruits:** infructescence dark red or brown when mature, oblong with loosely arranged fruits; appearing drier than in other species, 1-4 cm (excluding the peduncle). **Flowering:** March-April. **Fruiting:** April-July.

**Distribution.** Mexico to Honduras. The occurrence in the Andes is perhaps due to the introduction of these trees for fruits (Berg, 2001).

**Notes.** Berg (2001) studied the type specimens of *Morus* from the southwestern United States (including types of *M. albida*, *M. arbuscula*, *M. betulifolia*, *M. canina*, *M. confinis*, *M. crataegifolia*, *M. goldmanii*, *M. grisea*, *M. microphylla*, *M. pandurata*, *M. radulina*, *M. vernonii*, *M. vitifoila* sensu Green [1910]) and concluded these are synonyms of *M. celtidifolia*. They are recognized here as synonyms of *M. microphylla*.

**Specimens examined.** GUATEMALA. *Steyermark 50515a* (GH), August 13, 1942. MEXICO. –Chiapas: *Breedlove 50802* (GH) from, April 11, 1981. –Nanchitita: *GBH 3627* (GH), March 20, 1933. –Other localities: *Caranza 1560* (GH), 1989. *Dodge 44* (GH), July 1891. *GBH 1336* (GH), July 16, 1898. *GBH 3843* (GH), March 20, 1933. *Lundell 5471* (GH), July-August, 1934. *Matuda 1384* (GH), May 1937. *Matuda 30675* (GH), April 11-12, 1945. *Palmer 158* (GH), Feb 1 - April, 1907. *Palmer 563* (GH), April 11, 1905. *Pringle 6791* (GH), April 23, 1898. *Sargent 5 & 8* (GH), 1887. *Sharp 45308* (GH), 1945. –Sonora: *Gentry 3641* (GH), April 14, 1938.

5. *Morus insignis* Bureau in De Candolle, *Prodromus* 17: 247 (1873). [Type: P, BM, F, G, K]

**Synonyms.** *Morus peruviana* Planch. ex Koidz., *M. trianae* Leroy, *M. marmollii* Legname.

**Description.** Dioecious trees to 10 m. **Bark:** brown or gray with elliptical lenticels. **Branches:** coppery red or brown, sparsely pubescent. **Buds:** small, 0.2-0.5 cm x 0.2 cm, brown, ovoid, bud scale brown with dark band on the apical margin. **Leaves:** stipulate, stipules brown, thin pubescent, lanceolate, 0.5-1 cm x 0.2-0.5 cm. Petiole pubescent, 0.5-2.5 cm, sparsely

pubescent. Leaf blade elliptic to oblong, 5-20 x 3-15 cm, base unequal, obtuse, margin shallowly serrate to dentate, apex acuminate. Veins not as prominent as in other *Morus* species. Lateral veins, run up to the ½ to 2/3 of the leafblade. Adaxial surface glabrous to scabrous, abaxial surface pubescent with short white hairs. **Inflorescence:** catkins; staminate, pedunculate, peduncle 0.2-0.5 cm, 6-12 cm, two per node; pistillate pedunculate, 0.1-0.3 cm, 3-15 cm, 1-2/node. **Flowers:** staminate flowers: 30-100/catkin, bud scale still intact, perianth ovoid. Pistillate flowers: 20-60/catkin, perianth ovoid, style less than <1 mm, stigma branched. **Fruits:** infructescence with fruit loosely arranged, 5-15 cm. **Flowering:** February-April (Central America); xxx (South America). **Fruiting:** May (Central America); September, November (South America).

**Distribution:** Cloud forests of Southern Mexico to Central America, Ecuador, Colombia, Argentina, and Venezuela.

**Specimens examined.** COLOMBIA. –Antiqua: *MacDoughal and Roldan 3563* (MO), January 29, 1989. COSTA RICA. –Las Nubes San Jose: *Standley 38808* (GH), March 20-22, 1924. –San Jose de la Montana: *Fosberg et al. 47800* (MO), May 17, 1996. ECUADOR. –Bolivar: *Gray and Tippas 12497* (MO), July 19, 1993. *Zak and Jarmillo 2705* (GH), September 3, 1987. –Napó: *Palacios 5982* (MO), October 1990. –Other: *Palacios 6228* (MO), October 12, 1990. PERU. –Bangara: *Smith and Vasquez 4900* (MO), September 2, 1983. –Oxapama: *Smith and Pretel 8027* (MO), July 25, 1984. –Piura: *Gentry et al. 74981* (MO). September 22, 199. VENEZUELLA. –Bocono: *Dorr and Barnett 7523* (MO), October 31, 1990. –Other: *Weberbauer 7040* (GH), August 1914.

6. *Morus macroura* Miquel in *Pl. Jungh.* 1: 42 (1851). [Type: B?]

**Synonyms.** *M. alba* var. *laevigata* Wall. ex Bur., *M. laevigata* Wall. ex Brand., *M. liboensis* S. S. Chang, *M. wallichiana* Koidz., *M. wittiorum* Handel-Mazzetti, *M. wittiorum* var. *mawu* Koidz., *M. jinpingensis* S. S. Chang.

**Description.** Dioecious, trees to 20 m. **Bark:** dark brown. **Branches:** young branches pubescent at nodes. **Buds:** small to big, 0.2-1 cm x 0.5 cm, ovoid, brown or white and pubescent, bud scale with white band on the apical margin. **Leaves:** leaf scar slightly raised, semi-circular and extrose, stipules 0.5 to 3 cm, pubescent, usually linear. Petiole pubescent, ca. 1 cm. Leaf blade broadly ovate, unlobed, 5-20 x 3-7 cm, base rounded, rarely cordate, margins usually minutely serrate to almost entire, apex acute to shortly acuminate. Lateral veins run to  $\frac{1}{2}$  to  $\frac{2}{3}$  of the leaf, secondary veins 45-75° to the mid-rib. Adaxial surface glabrous to sub-scabrous, abaxial suglabrous with sparse hairs along the veins. **Inflorescence:** catkins; staminate, pedunculate, 1-2.5 cm, 4-16 cm, 1-2 per node; pistillate, pedunculate, ca. 1 cm, long cylindric, 6-16 cm, two per node. **Flowers:** staminate flowers: 30-150/catkin, perianths ovate, pubescent; anther globose. Pistillate flowers: 20-80/catkin, perianths oblong; style absent; stigma branched and pubescent. **Fruits:** infructescence yellowish white when mature, long cylindric, 6-16 cm, fruits often dry and spaced out. **Flowering:** March-April. **Fruiting:** April-May.

**Distribution.** Tropical montane forests of China, Nepal, Bhutan, Indochina, Malaysia, Myanmar, India, Thailand, Indonesia.

**Economic importance.** This species is used for papermaking and the wood and leaves are used in dyeing.

**Notes.** *Morus wittiorum* and *M. liboensis* are recognized as separate species in the Flora of China (Zhou and Gilbert, 2003), but are treated here within *M. macroura*. The present

recognition was based on a limited number of specimens (of *M. wittiorum* and *M. liboensis*); the taxa showed minor differences in the leaf morphology, and distribution ranges were overlapping. Future study of an increased number of specimens, field observation and possibly molecular study will be helpful in resolving the diversity of this group.

**Specimens examined.** BURMA. –North Burma: *Kingdom-Ward 476* (GH), April 2, 1939.–Tangkhal: *Kingdom-Ward 22049* (GH), March 21, 1953. BHUTAN. –Gaylegphung: *Grierson and Long 4106* (GH), March 19, 1982. CHINA. – Hainan: *Lau 25825* (GH), March 21, 1936. – *Kaifu 2426* (MO), May 16, 1980. – Kwansi: Ping Nan, *Wang 39218* (GH), May 21, 1936. –Kwangtung: Chaapung village, *Taam 693* (GH), May 1-24, 1938. –Kwangtung: *Tsang 26442* (GH), May 21-30, 1936. –Yunan: *Henry 12019A* (GH), (without date). Thailand. –Chiang Mai: *Maxwell 90-272* (GH), February 28, 1990. –Lampoon: *Maxwell 94-296* (GH), March 2, 1994. – Other: *Dickason 7118* (GH), March 1938. – Sutep, Siam, “Native” *S436* (GH), April 11, 1949.

7. *Morus mesozygia* Stapf ex A. Chev. in *Vegt. Ut. Afr. Trop. Fr.* 5 : 263 (1909). [Type : P, K]

**Synonyms.** *Celtis lactea* Sim., *Morus lactea* (Sim.) Mildbr., *M. mesozygia* var. *lactea* (Sim.) A. Chev.

**Description.** Dioecious or monoecious trees reported to be up to 35 m. **Bark:** gray or brown with densely distributed short elongated lenticels. **Branches:** gray, glabrous. **Buds:** small, brown, ovoid bud scale with gray band on the apical margin. **Leaves:** stipulate, stipules lanceolate 1cm x 0.5 cm, sparsely pubescent. Petioles 0.5-2.5 cm. Leaf blade elliptic, oblong, lanceolate or suborbicular, 6-12 cm x 5-8 cm, acuminate to caudate, leaf base truncate or cordate; margin crenate to serrate. Surfaces abaxially pubescent in the axils of the veins, adaxially



glabrous, tri-nervate, 2-5 distinct secondary veins at 60-75° to the mid-rib, the secondary veins below them not prominent, and at almost 90° with the mid-rib, scalariform, secondary veins are > 60° with the lateral veins towards the margin. **Inflorescence:** catkins; staminate, pedunculate, peduncle 1-2.5 cm, 1-2 per node; pistillate catkins, pedunculate 1.5-2.5 cm, subglobose, 0.5-1 cm, two per node. Staminate flowers: 15-20 per catkins, crowded. Pistillate flowers: 5-10 flowers per catkins, perianths ovoid, style short <1 mm; stigma branched. **Fruits:** infructescence, subglobose to globose, 0.5-2.5 cm x 0.5 cm. **Flowering:** April-September. **Fruiting:** March-August.

**Distribution.** Native to tropical Africa, Senegal, Nigeria, Congo, North-western Angola, south-western Ethiopia, Republic of South Africa.

**Economic importance.** Fruits are edible and wood as timber in Africa (Berg, 1977).

**Selected Specimens examined.** MOZAMBIQUE. *Safala 3163* (MO), July 23 1941. NIGERIA.—Ibadan: *Okafor OL455* (MO), August 7, 1967. —Oyo: *Daramola 330* (MO), September 27, 1993. UGANDA. *Egglig 1183* (MO), without date. SIERRA LEONE. *Georges 22886* (MO), December 30, 1965. SOUTH AFRICA. 0.2°22'N and 16° 09' E, *Gentry and Harris 62776* (MO), without date. ZAIRE. 1° 26' N, 28° 33' E, *Hart 1342* (MO), August 1, 1966. —Other. Guine Portugusa: *Espirito 1961* (MO), April 25, 1945. Reserve de Lamto, *Par and Gautier-Begum 1105* (MO), March 2, 1989.

8. *Morus microphylla* Buckley in *Proc. Acad. Nat. Sci. Philadelphia*. 14: 8 (1862). [Type: PH]

**Synonyms.** *M. albida* Greene, *M. arbuscula* Greene, *M. betulifolia* Greene, *M. canina* Greene, *M. cavaleriei* H. Lev., *M. confinis* Greene, *M. crataegifolia* Greene, *M. goldmanii*

Greene, *M. grisea* Greene, *M. microphilyra* Greene, *M. mollis* Rusby, *M. pandurata* Greene, *M. radulina* Greene, *M. vernonii* Greene, *M. vitifolia* Greene.

**Description.** Dioecious or monoecious, shrubs or trees up to 5 m. **Bark:** usually gray or yellowish gray with densely distributed elongated lenticels. **Branches:** internodes of flowering branches relatively more condensed and pubescent, gray. **Buds:** elliptic or ovoid with acute apex, 1-3 mm, bud scale brown or white with dark band on the apical margin. **Leaves:** leaf scar, nearly circular, deeply concave, upwards facing. Stipulate, stipules pubescent, 3-5 mm, linear – lanceolate. Petiole pubescent, 0.2 -1 cm. Leaf blades lanceolate to ovate, unlobed or lobed (3-5 sinuses), 1-6 x 0.6-3 cm, base usually cordate, sometimes round, margins usually regularly serrated, apex acuminate, sometimes subcaudate; surfaces adaxially harshly scabrous, abaxial surface pubescent and scabrous. **Inflorescence:** catkins; staminate, pedunculate, 0.2-0.5 cm, 0.5-0.8 cm, one per node; pistillate, pedunculate ca 0.5 cm, pubescent, 0.5-0.8 cm. **Flowers:** staminate flowers: 5-10 per catkins, crowded, perianth ovoid. Pistillate flowers 3-8 per catkins, perianth ovoid: Style absent, stigma 2. **Fruits:** infructescences red or deep purple to black, short cylindrical or globose, 0.5-1 cm; fleshy to dry. **Flowering:** March-April. **Fruiting:** April-June.

**Distribution.** USA (Arizona, Texas, New Mexico), Mexico, Costa Rica.

**Specimens examined.** USA. –Arizona: Graham Co, *Maguire 10531* (GH), April 6, 1935; *McKelvey 11999* (GH), June 1, 1929; Tanque verde Canyon, *Brass 14281* (GH), April 6, 1940. –Texas: Calahan Co, *Palmer 13681* (GH), May 26, 1918; Edwards Co, *Cory 18983* (GH), May 20, 1936; El Paso Co, *Franks 6630* (GH), August 20 1996; New Braunfels, Comanche Spring, *Lindheimer 1166* (GH), May 1849; San Antonio, *Schulz 64* (GH), April 17, 1922. –New Mexico: near Silver City, *Eastwood 8448* (GH), May 6, 1999.

**Notes.** Berg (2001) recognized several *Morus* species sensu Green (1910) from the southwestern United States (Texas, Arizona and New Mexico) as *Morus celtidifolia*. The present study recognizes them as synonyms of *M. microphylla*. There are many specimens from North-East Mexico, which lie in the continuum between *M. microphylla* and *M. celtidifolia*. Further assessment of hybridization between these two species in their range might help us to understand this taxonomic confusion.

**9. *Morus mongolica*** (Bureau) C. K. Schneider in Sargent, *Pl. Wilson.* 3: 296 (1916). [Type: P]

**Synonyms.** *M. alba* var. *mongolica* Bur., *M. barkamensis* S. S. Chang, *M. deqinensis* S. S. Chang, *M. mongolica* var. *barkamensis* (S. S. Chang) C. Y. Wu & Z. Y. Cao, *M. mongolica* var. *diabolica* Koidz., *M. mongolica* var. *hopeiensis* S. S. Chang & Y. P. Wu, *M. mongolica* var. *longicaudata* Z. Y. Cao, *M. mongolica* var. *pubescens* S. C. Li & X. M. Liu, *M. mongolica* var. *rotundifolia* Y. B. Wu, *M. mongolica* var. *vestita* Rehder, *M. mongolica* var. *yunnanensis* (Koidz.) C. Y. Wu & Z. Y. Cao, *M. yunnanensis* Koidz.

**Description.** Dioecious, shrubs or small trees to 6 m. **Bark:** gray, brown or brown black. Lenticels light colored and elliptic. **Branches:** gray, redish (coppery) to brown black. **Buds:** often small and conical, sometime ovoid, 1-3 mm, grayish brown with dark band on the apical margin of bud scale. **Leaves:** stipulate, stipules pubescent, 1.5-4 cm, usually linear to lanceolate, petiole pubescent, 1-3.5 cm. Leaf blade lanceolate to broadly ovate, unlobed or lobed with 3-5-sinuses, 6-15 x 5-8 cm, base usually cordate, margins usually regularly serrate with each tooth tapering into a hair like seta (0.8-3 mm), apex acuminate; surfaces adaxially glabrous, abaxially sparsely pubescent along veins. Veins in the mature leaf reddish brown or whitish yellow, lateral veins run to 1/3 to 1/2, secondary veins 45-60° to the midrib. **Inflorescence:** catkins; staminate

catkins pedunculate, peduncle 1-2 cm, cylindric, 1 per node, 2-5 cm; pistillate catkins pedunculate, peduncle shorter than that of male, 1.5-3 cm. cylindric, few, 1 per node, 1-2 cm. **Flowers:** staminate flowers: 15-30 per catkins, perianths ovate. Pistillate flowers: 10-20, perianths oblong, style long (2-6 mm); bifid stigma. **Fruits:** infructescence red, purple or white when mature, 1-1.5 cm excluding the stalk. **Flowering:** March-April. **Fruiting:** April-July.

**Distribution.** China, Japan, Korea and Mongolia.

**Notes:** Schneider (1916) listed seven specimens collected in 1907 by E. H. Wilson (collection numbers 8<sup>a</sup>-8<sup>f</sup>) from Western Hupeh, China. There are also other specimens mentioned such as those collected by A. Von Rosthorn (without number and date), J. G. Jack in 1905, and specimens discussed by E. E. Maire in his description of *M. mongolica*. Several of these reference specimens are at GH and were observed as part of the present study.

**Specimens examined.** CHINA. –Beijing: *Wang et al 21* (MO), April 4, 1986. –Chihly: *Smith 958* (MO), 1928. –Chihly: *Hers 2218* (GH), without date. –Guizhou: *Dancheen, Liu 20538* (MO), May 15, 1996. –Hubei: *Dang Yang, Jiang and Tao 117* (MO), April 26, 1982. –Kunming: *Fanan 1537* (MO), Guilin, May 27, 1980. –Pu Kecheng: *Liu and Zheng 1473* (MO), June 28, 1984. –Shaansi: *Smith 6417* (GH), without date. –Shaanxi: *Zhang 19360* (MO), June 12, 1983. –Shansi: *Smith 6329* (MO), July 1924. –Sichuan: *Longkon, Dai 100715* (MO), May 30, 1958. –Hupei: *Wilson (8<sup>a</sup>-8<sup>f</sup>)* (GH), June 1907-1908. –Yunnan: *Chu 1217* (MO), May 14, 1988. –Yunnan: *Rock 2861* (GH), without date. –Yunnan: *Maire 527* (GH), without date.

**10. *Morus nigra* L.** in *Species Plantarum* 2: 986 (1753). [Type: LINN]

**Synonyms.** *M. atrata* Raf., *M. cretica* Raf., *M. laciniata* Mill., *M. petiolaris* Raf., *M. scabra* Moretti, *M. siciliana* Mill.

**Description.** Subdioecious, trees to 10 m. **Bark:** gray or dark brown. **Branches:** brown, pubescent. **Buds:** grayish brown, and ovoid, 0.5 x 0.2 cm. bud scale brown with white apical margin. **Leaves:** leaf scar slightly raised cupoid. Stipulate, pubescent, 2.0-3.0 cm, usually lanceolate. Petiole pubescent, 2-6 cm. Leaf blade broadly ovate, unlobed or lobed (2-3 sinuses), 4-22 x 3-14 cm, base usually cordate, margins usually regularly serrate, apex acute to shortly acuminate. Adaxial surface glabrous to slightly scabrous, abaxial surface pubescent along the veins. **Inflorescence:** catkins; staminate, pedunculate, 0.5 cm, pubescent, one per node; pistillate, pedunculate, 0.5 cm, one per node. **Flowers:** staminate, 15-25/catkin, perianth ovate. Pistillate 15-35/catkin, perianth oblong with ciliate margin, style very short (<1 mm), stigma branched. **Fruits:** infructescence purple to black, elliptic to ovoid, 1-2.5 x 1-2 cm. **Flowering:** April-May. **Fruiting:** May-June.

**Distribution.** Native to West of Iran and Italy, introduced to several countries worldwide.

**Specimens examined.** BERMUDA. *Manuel 652* (GH), January 2, 1964. CHINA. Yunnan, *Yu 5271* (GH), without date. COSTA RICA. *Condeez 17451* (GH), 1909. CUBA. *Shafer 8816* (GH), February 16, 1911; Harvard Tropical Garden Soledad, *Jack 5004* (GH), March 26, 1927. EL SALVADOR. *Cardenson 288* (GH), November 1921. SOUTHWEST AFRICA. *Rodin 9215* (GH), without date. USA. Hawaii. *Neal 1236* (GH), May 8, 1944. WEST INDIES. *Procter 18232* (GH), April 4-June 12, 1958. **Images examined.** LINN 1112.3 (LINN).

**11. *Morus notabilis*** C. K. Schneider in Sargent, *Pl. Wilson.* 3: 293 (1916). [Type: MO]

**Description.** Dioecious trees of 4-15 m. **Bark:** grayish to dark brown. Lenticels round (dot like) or sometime elliptic, white light colored. **Branches:** white or dark brown, sparsely

spreading, internodes long, glabrous or pubescent with short and sparse hairs. **Buds:** small to large, 1-6 mm, grayish brown, conical or ovoid, bud scale apical margin with dark banding. **Leaves:** stipulate, stipules pubescent, 1.5-3.0 cm, usually linear to lanceolate, petiole pubescent, 3-5 cm. Leaf scar nearly circular to circular, shallow on the surface. Leaf blade broadly ovate to orbicular, usually unlobed, 7-25 x 6-20 cm, base mostly cordate, margins usually regularly (spaciously) dentate with acute tip, apex acuminate to obtuse; lateral veins run up to 2/3 of the leaf, secondary veins converge together by the margin, at 45-75° with the mid-rib, surfaces adaxially glabrous, sparsely pubescent abaxially. **Inflorescence:** catkins; staminate catkins pedunculate, peduncle 2-3 cm, usually two per node, 3-7 cm; pistillate catkins, pedunculate, 3-4 cm, one per node, flowers crowded, 3-5 cm (excluding the peduncle). **Flowers:** staminate flowers: 30-50 Flowers/catkin, perianths ovate, pistillode present. Pistillate flowers: 25-45 flowers/catkins perianths oblong, style long (0.5-1 cm), bifid stigma. **Fruits:** infructescence white or purple red when mature, 2.5-4 cm. **Flowering:** April-June. **Fruiting:** May-August.

**Distribution.** Sichuan and Yunnan of China.

**Specimens examined.** CHINA. –Jing Chikeng-Shan: Anhiu, *Wang Shilong A178* (MO), without date. –Sichuan: Emei, *Honggui 5380* (MO), June 13, 1995. *Honggui 5708* (MO), without date. –Szechuan: Ma-pien Hsian, *Wang 23074* (GH), May 29, 1931. *Wilson 919* (MO), 1907.–Tibet: 28°24' N and 98°28' E, *Forrest 20241* (GH), September 1921. –Yunnan: Shang-pa, *Tsai 58727* (MO) without date. –Zhejiang: Anji Longwang, *Fang and Deng 975071* (MO), May 8, 1997.

**12. *M. rubra*** L. in *Species Plantarum* 2: 986 (1753). [Type: LINN]

**Synonyms.** *M. canadensis* Poir., *M. caroliniana* Hort. ex Moretti, *M. microphylla* Buckl., *M. missouriensis* Audib. ex Moretti, *M. pensylvanica* Nois. ex Loud., *M. reticulata* Raf., *M. scabra* Willd., *M. tomentosa* Raf., *M. virginica* Duham. ex Dippel.

**Description.** Subdioecious, tree up to 15 m. **Bark:** usually gray with orange tint, relatively thinner with flattened ridges, furrows shallow. **Branches:** young branches pubescent, mature glabrous, mature trees with characteristic spreading branching orientation, gray to reddish brown. **Buds:** ovoid to conical with pointed apex, bud scale gray with dark or brown band on the apical margin, 0.5-0.8 cm. **Leaves:** leaf scar circular, slightly raised. Stipulate, stipule linear ca 1 cm densely pubescent. Petiole 1-3 cm, pubescent. Leaf blade broadly ovate, sometimes irregularly lobed (3-5 sinuses), 5-30 cm x 3-22 cm, base usually cordate, sometimes unequal to truncate, margins regularly serrated, apex acuminate, sometimes subcaudate; surfaces abaxially sparsely to densely pubescent, adaxially slightly scabrous. **Inflorescence:** catkins, unisexual or cosexual; staminate, pedunculate, peduncle 1-1.5, catkin 2.5 cm, 1-5 per node; pistillate, pedunculate, peduncle 2 cm, catkin 1-1.5 cm, one per node. **Flowers:** staminate flowers: 10-35/catkin, perianth ovoid purplish green; pollen 20-25 x 17-20  $\mu$ m. Pistillate flowers: Style very short <0.5 mm, stigma branched. **Fruits:** infructescences red or deep purple to black, cylindric, 1-2.5 cm excluding the stalk; fleshy; achenes compactly arranged. **Flowering:** March-May. **Fruiting:** April-July.

**Distribution.** Eastern North America up to the eastern margin of the Great Plains, and as far north as southern Ontario, Canada.

**Economic importance.** Stem bark, root and tree sap were medicinally used by Native Americans (Wunderlin, 1997). Threatened in Connecticut and Massachusetts, endangered in Vermont and in Michigan (USDA PLANTS Database, 2007).

**Specimens examined.** USA. –Georgia: *McDuffie, Bartlett 2647* (KSC), April, 1884. – Illinois: Peoria, *Chase 14403*, May 9, 1957. – Kansas: Osage Co., *Hitchcock* (without collection number), 1895; Decatur Co, *Gates 18045*, May 22, 1935; Riley: Konza, 39.10521° N and 96.6021° W, *Nepal 706*, May 25, 2005; Saline Co, *Hancin 60*, February 3, 1893. –Kentucky, *Kellerman* (without number), Fayette, May 19, 1882. –Oklahoma *Goodman 7130*, May 13, 1961; Payne, *Waugh* (without number), Jan 30, 1935. –Pennsylvania: Franklin Co, *Smith 38*, July 5, 1936 (all these are KSC specimens). **Images examined.** LINN 1112.6 (LINN).

**13. *Morus serrata*** Roxburgh in *Fl. Ind.*, ed. 3: 596 (1832). [Type: P]

**Synonyms.** *Morus alba* var. *serrata* (Roxb.) Bur., *M. altissima* Miq., *M. gyirongensis* S. S. Chang, *M. pabularia* Decne., *M. vicorum* Jacquem.

**Description.** Dioecious, trees to 15 m. **Bark:** dark brown with almost circular lenticels. **Branches:** young branches are densely pubescent. **Buds:** ellipsoid to ovoid, 0.2-1 cm x 0.1-0.5 cm, bud scale (persistent) brown to chocolate with white apical margin, pubescent. **Leaves:** leaf scar slightly raised, semi-circular. Stipulate, stipules thin pubescent, Linear -lanceolate, 0.5-2 cm x 0.2-0.5 cm. Petiole densely pubescent, 4-6 cm. Leaf blade broadly ovate, unlobed or lobed (1-3 sinuses), 5-20 x 3-14 cm, base usually cordate, margins dentate to doubly dentate, sometime sparsely serrate, apex acute to shortly caudate. Lateral veins run up to the half of the leafblade, Adaxial surface glabrous to slightly scabrous, abaxial surface densely pubescent, veins abaxially more prominent, yellowish. **Inflorescence:** catkins; staminate, pedunculate, 0.5-1 cm, 3-6 per



node, 2-6 cm; pistillate, pedunculate, 0.5-1 cm, cylindric, 1-2.5 cm, 1-4 per node. **Flowers:** staminate flowers: 10-30/catkin, perianths ovate. Pistillate flowers: 5-20/ catkin perianths oblong; style absent; stigma branched and pubescent. **Fruits:** infructescence red/white/pink when mature. Cylindric, 1.5-2 cm. **Flowering:** April-May. **Fruiting:** May-June.

**Distribution.** Mountain forests of China, Nepal and India.

**Economic importance.** Leaves of this species are used as fodder in Nepal, and fruits are edible.

**Specimens examined.** INDIA. –Dehra Dun: *Beli 115* (GH), June 16, 1922. *Singh 91* (GH), November 5, 1912. –Kumaon: *Strachey and Winterbottom 4* (GH), without date. –Punjab: Kulu, *Koelz 4788* (GH), June 1-5, 1933. *Stewart 1958* (MO), May 23, 1917.–Uttar Pradesh: Musoorie, *Fleming 417* (GH), April 30, 1948. NEPAL. –Dhahanu: *Bisram 195* (GH), April 1, 1929. – Doti, *Bisram 297* (GH), April 23, 1929. PAKISTAN. – Kashmir: *Stewart and Hasiu 25506* (GH), April 25, 1953; *Stewart 27326*, April 21, 1954. – Punjab: *Parker 2850* (GH), May 17, 1928.

## ACKNOWLEDGEMENTS

I thank curators of Missouri Botanical Garden Herbarium (MO) and Harvard University Herbarium (GH) for making loans of herbarium specimens for this study. I appreciate valuable suggestions from C.C. Berg from Linden Austria, C.Y. Wu from the Herbarium of Kunming Institute of Botany (KUN), and Michael Gilbert from Kew Botanical Garden Herbarium about working with *Morus*. I benefitted from online access to the digital images of type specimens from the herbarium of Linnaean Society of London (LINN), Harvard University Herbarium (GH), Missouri Botanical Garden Herbarium (MO), and National Herbarium of Paris (P). Drs. Mark Mayfield and Carolyn Ferguson trained me for taxonomic research and helped me in several ways in the field and in the Herbarium. I thank Caroline Delandre, who translated a paper in French to English, and Fan Fu and Ying Zhen who helped me read labels that were in Chinese. This project was supported by Kansas State University Herbarium (KSC) through support from the Division of Biology and Kansas Agricultural Experiment Station.

## LITERATURE CITED

- AZIZAN, D. AND A. SONBOLI. 2001. Chromosome counts for five species of Moraceae from Iran. *Iranian Journal of Botany* 9: 103-106.
- BERG, C. C. 2006. Moraceae- genera other than *Ficus*. Pp. 23-27 in Flora Malesiana. Ser. I, Volume 17/Part 1.
- BERG, C. C. 2005. Moraceae diversity in a global perspective. Proceedings of an international symposium on plant diversity and complexity patterns; local, regional, and global dimensions at Royal Danish Academy of Science, Copenhagen, Denmark. *Biologiske Skrifter* 55: 423-440.
- BERG, C. C. 2001. Moreae, Artocarpeae, and Dorsteniae (Moraceae) with introductions to the family and *Ficus* and with additions and corrections to Flora Neotropica Monograph 7. New York Botanical Garden Press, New York, USA.
- BERG, C. C. 1998. Moraceae (excluding *Ficus*). Pp. 1-126 in Flora of Ecuador Volume 60. G. Harling and L. Anderson (eds.). Göteborg University, Sweden.
- BUREAU, E. 1873. Moraceae. Pp. 211-288 in *Prodromus Systematis Naturalis Regni Vegetabilis* Volume 17. A. De Candolle (ed.). Paris, France.
- BURGESS, K. S. AND B. C. HUSBAND. 2004. Maternal and paternal contributions to the fitness of hybrids between red and white mulberry (*Morus*, Moraceae). *American Journal of Botany* 91: 802-808.

- CAO, Z. Y. 1991. New taxa of *Morus* (Moraceae) from China. *Acta Phytotaxonomica Sinica* 29: 264-267.
- CHANG, S. S. 1984. New taxa of Moraceae from China and Vietnam. *Acta Phytotaxonomica Sinica* 22: 64-76.
- GREENE, E. L. 1910. Some southwestern mulberries. Pp. 112-121 in *Leaflets of Botanical Observation and Criticism* Volume 2. eds. E.L. Greene. Washington D.C., USA.
- HOLMGREN, P. K., N. H. HOLMGREN AND L. C. BARNETT. 1990. Index herbariorum, I. The herbaria of the world. Edition 8th. New York Botanical Garden, Bronx, NY.
- HOTTA, T. 1954. Fundamentals of *Morus* plants classification (in Japanese). *Kinugasa Sanpo* 390: 13-21.
- JANAKI-AMMAL, E. K. 1948. The origin of black mulberry. *Journal of the Royal Horticultural Society* 73: 117-120.
- KATSUMATA, F. 1971. Shape of idioblasts in mulberry leaves with special reference to the classification of mulberry trees. *Journal of Sericultural Science of Japan* 40: 313-322.
- KOIDZUMI, G. 1917. Taxonomy and phytogeography of the genus *Morus*. *Bulletin of Sericultural Experimental Station* (Tokyo) 3: 1-62.
- LEROY, J. F. 1949. Les Mcriers sauvages et cultivds. La sericulture sous les tropiques. *Revue Internationale de Botanique aaplique'e et d'agriculture Tropicale* 29: 481-496.
- LINNAEUS, C. 1753. *Morus*. P. 968 in *Species Plantarum* Volume 2. C. Stockholm, Sweden.

- MORETTI, G. 1841. Prodrómo di una monografía delle specie del genere *Morus*. 1-22
- RAO, C. K. AND C. E. JARVIS. 1986. Lectotypification, taxonomy and nomenclature of *Morus alba*, *M. tatarica* and *M. indica* (Moraceae). *Taxon* 35: 705-708.
- REVEAL, J. 2007. *M. rubra* L. P. 686 in *Order out of chaos*. Index of Linnean plant names and specimens. Charlie Jarvis (eds).
- ROHWER, J. G. 1993. Moraceae. Pp 438-453 in *The families and genera of vascular plants II. Flowering plants. Dicotyledons. Magnoliid, Hamamelid and Caryophyllid families*. K. Kubitzki, J. G. Rohwer and V. Bittrich (eds.). Springer-Verlag, Berlin, Germany.
- SEYMOUR, F. C. 1952. Notes on Moraceae and Ulmaceae. *American Midland Naturalist* 48: 249-250.
- TOJYO, I. 1985. Research of polyploidy and its application in *Morus*. *Japan Agricultural Research Quarterly* 18: 222-228.
- VEINKATARAMAN, K. 1972. Wood phenolics in the chemotaxonomy of the Moraceae. Review article. *Phytochemistry* 2: 1571-1586.
- WU, C. Y. AND S. S. CHANG. 1989. Taxa Nova nonnulla Moracearum Sinensium. *Acta Botanica Yunanica* 11: 24-34.
- WUNDELIN, R. P. 1997. Moraceae. Pp.388-399 in *Flora of North America* Volume 3. Flora of North America Editorial Committee (eds.). Oxford University Press, New York, USA.

WATANABE, T. 1958. Substances in mulberry leave which attract silkworm larvae (*Bombyx mori* L.). *Nature* 182: 325-326.

ZHOU, Z. AND M. G. GILBERT. 2003. Moraceae. Pp. 21-73 in *Flora of China* Volume 5. Z. Wu, P. H. Raven and D. Hong (eds.). Science Press, Beijing, China.



## CHAPTER 3 - PHYLOGENY OF THE GENUS *MORUS* L. (MORACEAE LINK.)

### ABSTRACT

The genus *Morus* L. (tribe Moreae Gaudich.; Moraceae) consists of ca. ten to 15 species of trees, and has a geographical distribution from Asia to Africa, Europe, and North, Central and South America. The broad geographical distribution, overlapping ranges of many taxa and putative hybridization between some taxa present interesting questions of taxonomy and biogeography of the genus. In this study, I used sequence data from the internal transcribed spacer (ITS) region of the nrDNA and the chloroplast *trnL-trnF* intergenic spacer region to study phylogenetic relationships. Sequence data were analyzed using parsimony, maximum likelihood and Bayesian approaches. Phylogenies based on separate data sets as well as the combined data are congruent and reveal a) a monophyletic core group of *Morus* with two well-supported geographical clades, one including Asian taxa and one of North American taxa, b) partly resolved relationships among Asian taxa and c) surprising relationships for *M. mesozygia* (Africa) and *M. insignis* (Central and South America), where they fall outside of the core clade with some samples of close relatives of *Morus* (i.e., members of *Trophis*). These findings suggest that *Morus*, as currently circumscribed, is non-monophyletic, and further work within the tribe will be necessary to clarify natural relationships.

Key words: Moraceae, *Morus*, phylogeny, *trnL-trnF*, ITS.



## INTRODUCTION

The genus *Morus* L. belongs to the tribe Moreae of family Moraceae (Rohwer, 1993), one of seven families of “Urticalean Rosids” following recent phylogenetic studies (Sytsma et al., 2002). *Morus* is distributed in Asia, Africa, Europe and North, Central and South America, and many species have overlapping ranges of distribution. Members of the genus have been cultivated in Asia and Europe for sericulture and fruits, and others are of ethnobotanical or economic value (e.g., timber, paper, medicines; Berg 2001). The genus *Morus* is defined by a suite of characters including cauducous stem apices, catkin inflorescence, staminate flowers with imbricate perianth and inflexed stamens, pistillate flowers with valvate perianth and  $\pm$  equally branched stigmas, fleshy perianth in the fruit, and an edible berry-like syncarp. Species are wind pollinated (Berg, 2001) and seeds are dispersed by birds (Stapanian, 1982). Characters including morphology of the leaf, winter bud, bark, pistil and syncarp have generally been employed in species recognition. The basic chromosome number for *Morus* is  $X=14$ , and ploidy level varies from  $2X$  to  $22X$  (Janaki-Ammal, 1948; Azizan and Sonboli, 2001). The genus *Morus* is interesting for systematic study because of its worldwide distribution, overlapping ranges of many taxa, morphological plasticity (Gray and Gray, 1987), interspecific hybridization (see Burgess et al., 2005), long history of domestication, and introduction and naturalization in the areas remote from their native ranges (Tojyo, 1985).

Taxonomy of *Morus* has been unstable, with great variation in the number of species recognized. Linnaeus (1753) established the genus by describing seven species: *M. alba*, *M. indica*, *M. nigra*, *M. papyrifera*, *M. rubra*, *M. tartarica* and *M. tinctoria*. *Morus papyrifera* and *M. tinctoria* were later moved to the genera *Broussonetia* and *Maclura*, respectively. Bureau (1873) recognized and additional five species, and also described 21 varieties and 13

subvarieties. Within *M. alba*, he classified taxa into two infraspecific groups: one of varieties with oblong and short cylindrical pistillate catkins and the other of varieties of long cylindrical pistillate catkins. Green (1910) treated *Morus* in the southwestern United States, dividing *M. microphylla* sensu Bureau (1873) into 13 species. Koidzumi (1917), who presented the most recent genus-wide treatment, recognized 24 species under two major sections: Dolichostylae Koidz. (species with long styles; >1 mm) and Macromorus Koidz. (species with short styles; <1 mm). Thus, in his classification, Koidzumi promoted some of Bureau's varieties to species (and some of Bureau's conspecific varieties became members of separate sections within the genus). This past emphasis on particular reproductive characters (e.g., the length of the style) poses interesting questions for evaluation in light of phylogeny. Leroy (1949) divided the genus into three subgenera, each with geographic integrity: *Eumorus* J.F. Leroy (including all Asian and North and Central American *Morus*; see Chapter 1), *Gomphomorus* J.F. Leroy (the Central and South American species *M. insignis* and *M. trianae*), and *Afromorus* A. Chev. (African species *M. mesozygia* and *M. lactea*). Hotta (1954) studied variation in shape and position of leaf cystolith cells in *M. alba*, *M. australis* and *M. mongolica*. Katsumata (1971) studied size and shape of leaf ideoblast character and used these data to classify several races of *M. alba* and *M. australis*. Other important taxonomic studies on *Morus* include description of new species from China (Chang, 1984; Wu et al., 1989; Cao, 1991), lectotypification of *M. alba* by Rao and Jarvis (1986), an overview of *Morus* distribution by Sanjappa (1989) and revision of *Morus* in Flora of China (Zhou et al., 2003). Zhou et al. recognized 12 species in China alone, although workers outside of China have generally not concurred with recognition of such great diversity at the species rank. Recently Berg (2005) put forth an estimation of the number of species in *Morus* as 12 (eight in Asia, one in Africa and three in the New World); however, he did not enumerate

those species, and further suggested the need for taxonomic revision of the genus to clarify species diversity of the group.

Phylogenetic relationships within *Morus* have not been extensively explored although there have been some recent studies of relationships at higher taxonomic levels (e.g., Sytsma et al., 2002; Datwyler and Weiblen, 2004; Zerega et al., 2005); these studies have shown complexity of relationships in the tribe Moreae, consistently indicating non-monophyly of the tribe and highlighting the need for further work to clarify natural relationships. Within *Morus*, Weiguo et al. (2005) used ITS and *trnL* intergenic spacer sequences to study phylogeny of Asian taxa. In their phylogeny (developed using the Neighbor-Joining method), they found Asian species to form a monophyletic group. However, their sampling did not include taxa outside Asia (i.e., included *M. alba*, *M. australis*, *M. mongolica*, *M. macroura* and other infraspecific taxa). Molecular markers typically used in population genetic studies (i.e., Randomly Amplified Polymorphic DNA [RAPD] and Inter Simple Sequence Repeat [ISSR]) have been employed recently to study patterns of genetic relationships between varieties and also within and among species of Asian *Morus* (e.g., Sharma et al., 2000; Bhattacharya and Awasthi et al., 2004; Vijayan et al., 2006; Weiguo et al., 2007). These studies focused on the cultivated species in Asia with an aim toward improving cultivars for the silkworm industry. More than thirteen microsatellite markers have recently been developed for some Asian *Morus* species (see Aggarwal et al., 2004; Tani et al., 2005), which can be employed in addressing many population level questions in *Morus*.

The main objective of the present study was to develop a phylogeny to further taxonomic and biogeographic study of this interesting genus. For this purpose, the internal transcribed spacer (ITS) region of the nrDNA and the chloroplast *trnL-trnF* intergenic spacer region were

sequenced and employed in phylogeny development using a variety of phylogenetic inference methods.

## MATERIALS AND METHODS

### Taxon sampling and outgroup selection

Thirteen species of *Morus* (Chapter 1) and two species of *Trophis* (*T. racemosa* [L.] Urb. and *T. involucrata* W.C. Burger) were sampled as ingroup taxa, and *Sorocea affinis* Hemsl. was used for the outgroup. In higher taxonomic level studies in Moraceae, Datwyler and Weiblen (2004) and Zerega et al. (2005) found a clade of *Trophis* (*T. involucrata* and *T. racemosa*) to be sister to *Morus* (with *M. nigra* L. and *M. alba* L. sampled). I surveyed samples representing several taxa of the tribe Moreae sensu Rohwer (1993), including *Broussonetia*, *Maclura*, *Streblus*, *Trophis* and *Sorocea* (the latter is being moved from tribe Artocarpeae to tribe Moreae, W. Clement, pers. comm.) and considered ease of alignment and preliminary relationships prior to making final sampling decisions. Sampling information for all samples involved in this study is presented in Table 3.1.

### DNA isolation and PCR amplification

Total DNA was extracted from leaf material (dried in silica gel or from herbarium specimens) following the CTAB protocol of Loockerman and Jansen (1996; modified from that of Doyle and Doyle [1987]) or using a DNeasy Plant Mini kit (Qiagen Corp., Valencia CA). The ITS region of the nuclear ribosomal DNA and the chloroplast intergenic spacer *trnL-trnF* (partial *trnL*<sub>UAA</sub> intron, *trnL* gene, intergenic spacer between *trnL*<sub>UAA</sub> and *trnF* and partial *trnF*, hereafter called *trnL-trnF*) were amplified by Polymerase Chain Reaction (PCR). The ITS region (illustrated in Fig. 3.1a) was amplified with the primers ITS4 (White et al; 1990) and modified

ITS5 (Downie and Katz-Downie, 1996). PCR was conducted in a reaction mixture of 50  $\mu$ l containing ~25ng genomic DNA, 2mM of PCR buffer, 0.4  $\mu$ M of primer, and 1 unit of *Taq* polymerase with other components as follows: 1) for ITS: 1.25 mM MgCl<sub>2</sub>, 0.1 mM of each dNTP and 2) for *trnL-trnF*: 2.5 mM MgCl<sub>2</sub> and 0.2 mM of each dNTP. The *trnL-trnF* region as (Fig. 3.1b) was amplified using forward primer 'c' and the reverse primer 'f' of Taberlet et al. (1991). The PCR conditions in PTC-200 DNA engine (MJ Research Inc., MA, USA) were: 1) for ITS amplification: initial denaturation at 94°C for 5 minutes followed by 1 minute at 72°C during which time *taq* polymerase was added; and 35 cycles of 1 minute denaturation at 94°C, 1 minute annealing at 50°C, and 2 minutes elongation at 72°C; and a final elongation of 5 minutes at 72°C; and 2) for *trnL-trnF*: initial denaturation at 94°C for 5 minutes followed by 1 minute at 72°C during which time *taq* polymerase was added, and 28 cycles of 1 minute denaturation at 94°C, 1 minute annealing at 55°C, and 2 minutes elongation at 72°C; and a final elongation of 10 minutes at 72°C. Electrophoresis of the PCR product was conducted on 1.2% agarose gels, which were stained with ethidium bromide and visualized using UV light. The PCR product was purified using a QIAquick Purification Kit (Qiagen).

## **Sequencing and alignment**

Sequencing reactions in both directions were performed in the PCR machine (PTC-200 DNA engine) using Big Dye V3.1 kit (Applied Biosystems Inc., Framingham, MA; following the manufacturer's instructions, except that quarter reactions were used). The sequencing reaction conditions were as follows: 96°C for 2 minutes; followed by 25 cycles of 96°C for 15 seconds, 50°C for 1 second, and 60°C for 4 minutes; and subsequent storage at 4°C. Sequenced reactions were purified through Sephadex (Sigma, St. Louis, MO) columns, dried using a vacuum-centrifuge, and sent to the DNA Sequencing and Synthesis Facility at Iowa State University

where gels were run using an ABI 3700 automated sequencer. The ITS and *trnL-trnF* sequences were obtained electronically, edited using Sequencher 4.5 (Gene Codes Corp., Ann Arbor, MI), and aligned manually using Se-Align v2.0a11 Carbon (Rambaut, 2002).

## **Phylogenetic analyses**

Data sets were analyzed using maximum parsimony (MP), maximum likelihood (ML) and Bayesian analyses (BA). MP and ML analyses were performed in PAUP\* 4.0b10 (Swofford, 2002) using branch and bound searches. All characters were treated as equally weighted and unordered. Parsimony analyses were performed treating gaps as both missing and as a new character state. Portions of the sequence with ambiguous alignments in the ITS data set were excluded from the analysis. Bootstrapping (Felsenstein, 1985) was performed to obtain a measure of support for branches (branch and bound; 20,000 replicates).

***Model test.*** ModelTest version 3.06 (Posada and Crandall, 1998) was used to determine the substitution model that best fit the *Morus* sequence data. Maximum likelihood was used to estimate the likelihood score for each of 56 candidate models, and they were analyzed and ranked in ModelTest. The parameters of the best model under the Akaike information criterion (AIC) were used in maximum likelihood and Bayesian analyses (see Posada and Buckley, 2004).

***Bayesian analysis.*** Bayesian analyses were performed in MrBayes ver. 3.1.2 (Huelsbeck and Ronquist, 2001) with the model parameters for the best model selected by ModelTest under Akaike's information criterion (AIC). Each analysis was run with two independent replicates of four (three heated and one cold) Markov chain Monte Carlo (MCMC) iterations for 2 million generations starting from a random tree. The number of generations required to bring the standard deviation of split frequencies between runs below 0.01 was identified as the minimum number of generations required for the analysis. Trees were saved

every 100 generations, producing 20,000 trees. Majority rule consensus trees and posterior probabilities (PP) for each node were calculated from the trees after the first 25% of the trees were discarded as the ‘burn-in’ (i.e., trees sampled before the chains had reached ‘stationarity’).

***Incongruence test and combined data analysis.*** A combined data matrix of ITS and *trnL-trnF* was constructed, and the incongruence length difference (ILD) test (Farris et al., 1994) was performed to assess the congruence between these two data sets. The ILD test was conducted using the partition homogeneity test as implemented in PAUP\* using a heuristic search with 200 replicates. The ILD test showed insignificant incongruence between the data sets, and analyses of the combined data set and estimation of branch support were performed as described above.

## RESULTS

### Data matrices

There were 650 characters in ITS data matrix, 948 in the *trnL-trnF* and 1598 in the combined data matrix. Sequences at 5’ and 3’ of each gene/intron/spacer are presented in Table 3.2. The sequence lengths of the ITS region (ITS1, 5.8S and ITS2) and *trnL-trnF* region across the genus *Morus* are summarized in Table 3.3.

Analysis of the ITS data matrix reveals that ITS1 and ITS2 are equally variable, but ITS1 has more parsimony informative characters than ITS2 (Table 3.4, Figure 3.5). The 5.8S region within most of *Morus* is not variable, but there are 12 variable sites in the data matrices for the *Morus-Trophis* complex and seven of them are parsimony informative. The *trnL-trnF* data matrix shows that the *trnL* intron has fewer variable sites than the *trnL-F* spacer, but the former

has slightly more informative sites than the latter, which is in contrast to findings for these regions in most taxa finding (Shaw et al., 2005).

## **Phylogenetic analyses**

***Parsimony analysis.*** Statistics for the MP analyses are presented in Table 3.4. MP analysis of the ITS data set resulted in 80 and four most parsimonious trees, with gaps treated as missing and as a new state, respectively. The tree topology in the latter case didn't change except in the additional resolution of a clade containing *M. australis* and *M. notabilis*. Overall bootstrap [BS] support was also higher with gaps coded as a new state. Strict consensus trees are presented in Figures 3.2 and 3.3. MP analysis of *trnL-trnF* data set yielded a single most parsimonious tree when gaps were treated as missing, but yielded five most parsimonious trees when gaps were treated as new state. The strict consensus trees in both cases were identical in topology (Figure 3.3).

***Model Test:*** The substitution models for each data set differed under the hierarchical likelihood ratio testing (hLRT) and the Akaike information criterion (AIC). These models are summarized in Table 3.5. When these different models (for a single data set) were used in Bayesian analyses, a congruent tree topology was obtained with just slight changes in posterior probabilities. Some workers have preferred models under the AIC (see Posada and Buckley, 2004), and these models were used for final analyses in the present study.

***Maximum Likelihood analysis:*** ML analyses of each data set with the corresponding substitution model (Table 3.5) yielded trees with congruent topologies to those trees resulting from MP analyses (ML trees not shown).

***Bayesian analysis:*** For each data set, the 95% majority-rule consensus BA tree exhibited a topology congruent to those of the corresponding MP trees (BA trees not shown). The posterior



probabilities for the tree resulting from analysis of the combined data set are reported on the MP tree (Figure 3.5).

***Incongruence test and combined data analysis:*** The ILD showed that there was no significant conflict (p-value = 0.97) between the ITS and *trnL-trnF* data sets, and the two data sets were subsequently combined into a large data matrix. MP analysis of the combined data set yielded 77 most parsimonious trees when gaps were treated as missing and a single most parsimonious tree with gaps treated as a new state. The topologies remained the same in both cases but support for branches was higher in the latter case. The tree is presented in Figure 3.5. Relevant statistics from the MP analyses are summarized in Table 3.4.

***Phylogenetic relationships.*** The phylogenetic trees based on ITS and *trnL-trnF* resulting from MP, ML and BA analyses were congruent in topology, which in turn were congruent to the tree based on the combined data set. General findings are discussed with reference to the combined tree (Fig. 3.5). Several findings are interesting:

1) Asian taxa form a monophyletic group with strong support (100% BS, PP 1.0) , although within-clade relationships remain unresolved. Within this group, a close relationship between *M. australis* and *M. notabilis* is weakly supported (52% BS, PP 0.53); and one between *M. cathayana* and *M. macroura* also weakly supported (64% BS, PP 0.97).

2) The clade of New World species except *M. insignis* is moderately well supported (86% BS, PP 0.93). *Morus microphylla* and *M. celtidifolia* are sister species (98% BS, PP 1.0), and the clade is sister to *M. rubra*. Introduced *M. alba*, although capable of hybridization with *M. rubra* in North America (Burgess et al., 2005), is not closely related to *M. rubra*.

3) The Asian clade and New World clade (as discussed above, without inclusion of *M. insignis*) exhibit a sister relationship with strong support (100% BS, PP 1.0). This clade is herein discussed as the "core" *Morus* clade.

4) A surprising sister relationship of the core *Morus* clade with a clade including *T. involucrata* and *T. racemosa* is strongly supported (100% BS, PP 1.0), making *M. insignis* and *M. mesozygia* basal to the clade of *Morus* and *Trophis* together.

## DISCUSSION

### Phylogeny of *Morus* and its taxonomic implications

The thirteen species of *Morus* included in the phylogeny are morphologically distinct from one another (see taxonomy of the genus *Morus*, Chapter 1), and correspond to most of the species recognized by Bureau (1873), Koidzuimi (1923) and Leroy (1949). The phylogeny is consistent with the subgeneric classification of Leroy (1949), which has strong geographic divisions. Leroy's *Eumorus* was a large subgenus that corresponds to our "core" *Morus* clade. His Neotropical *Gomphomorus* included *M. insignis* and his *Afromorus* included *M. mesozygia*; these species are grouped as sister and separate from the "core" *Morus* clade in the phylogeny.

### Clade of New World species

Three New World species *M. rubra*, *M. microphylla* and *M. celtidifolia* form a moderately well supported clade (86% BS, PP 0.93). *Morus microphylla* and *M. celtidifolia* are sister species (98% BS, PP 1.0), and this clade is sister to *M. rubra*. Introduced *M. alba*, although capable of hybridization with *M. rubra* in North America (Burgess et al., 2005), is not closely related to *M. rubra*. Several species recognized by Green (1910) in Texas and its vicinities could not be assessed by this study because of limited sampling. Based on study of herbarium

specimens, it is suggested that the different taxa he described all correspond to *M. microphylla* (with discussed differences attributable to morphological plasticity and putative hybridization between *M. rubra* and *M. microphylla*; see Chapter 2). Further sampling and phylogeographic study using more variable sequence regions would be interesting to discern variation and diversification in southwestern North America.

### **Clade of Asian species**

Three Asian *Morus* species, *M. australis*, *M. mongolica* and *M. notabilis*, are characterized by a long style, and the remaining ten Asian species by a short style; the long-styled taxa are not supported as a group in the present phylogeny. In *M. mongolica*, leaf margin serration has a long pointed apiculum while it is absent in both *M. australis* and *M. notabilis* which differ from each other in leaf shape, leaf apex and infructescence length characters. The sister relationship between the latter two, both with long styles, is weakly supported (52% of BS, PP 0.85; Figure 3.5). Interestingly, all of the taxa in the Asian clade correspond to only two species sensu Bureau (1873), who would have recognized *M. nigra* and *M. alba*, with our other recognized taxa being varieties of the latter.

Relationships relative to variation in ploidy levels (from 2X to 22X; Janaki-Ammal, 1948; Azizan and Sonboli, 2001) in *Morus* ( $X = 14$ ) could not be assessed in the present phylogeny because this variation occurs among Asian species in the unresolved part of the tree (Figure 3.5). Similarly, classification of *Morus* based on style length (Koidzumi, 1917; Zhou et al., 2003) and based on leaf cystolith cells (Hotta, 1954) could not be fully evaluated with the present phylogeny because relationships among Asian species were not resolved. Weiguo et al. (2005) used ITS and *trnL-F* sequence data to infer relationship among some Asian taxa. *Morus alba* occurred in various places in their neighbor joining tree, and this may have been due to the

effect of hybridization. However, parsimony analysis of their sequences (obtained from GenBank; data not shown) yielded unresolved relationships.

Besides sequence data, several other types of molecular markers have been employed to study relationships between several genotypes, varieties and even to explore interspecific relationships. Sharma et al. (2000) conducted cluster analyses based on amplified fragment length polymorphism (AFLP) data from samples belonging to a wide range of species. They suggested that African and New World *Morus* were closely related except that North American *M. rubra* was closer to Asian species. Bhattacharya and Ranade (2001) used randomly amplified polymorphic DNA (RAPD) and directed amplification of minisatellite-region DNA (DAMD) profiles to study genetic differences among “*Morus* varieties” in India, although it is not clear whether the sampled varieties belong to a single or multiple species. Vijayan et al. (2006b) used inter simple sequence repeat (ISSR) data to study genetic distinctiveness among 20 genotypes from *M. alba*, *M. australis* and *M. macroura*. The phenograms showed that *M. alba* and *M. australis* were closely clustered, and *M. macroura* was genetically distant. This distinctiveness of *M. macroura* corresponds to the leaf and syncarp morphology (e.g. *M. macroura* has catkins and infructescence that are two to three longer than those of any other Asian species). Awasthi et al. (2004) used RAPD and ISSR data to explore relationships between cultivated and wild *Morus* species. They showed through UPGMA cluster analysis that the wild species such as *M. macroura* and *M. serrata* were more distantly clustered than the cultivated species among themselves. These findings were similar to Weiguo et al. (2007), who used ISSR and microsatellite markers to examine genetic variation among wild and cultivated *Morus* species in China. They found that *M. cathayana*, *M. nigra*, *M. mongolica*, and *M. macroura* (our recognition) were genetically distant from varieties of cultivated species of *Morus* such as *M.*

*alba* and *M. australis*. The phylogenetic relationships among Asian species were unresolved in our analysis. It is important to note that phenograms depicting genetic distance may not correspond to phylogenetic relationships (Felsenstein, 2004); furthermore, ascertaining evolutionary relationships was not an aim of most of these studies--rather, the focus was generally on genetic similarity, often for breeding purposes. Rigorous phylogenetic investigation using additional and/or more variable sequence regions is called for in the Asian clade.

### **The Trophis-Morus complex outside the "core" *Morus* clade**

The phylogeny based on ITS and *trnL-trnF* data shows interesting patterns of relationships, particularly with regard to the relationships outside of the "core" *Morus* clade (100% BS, PP 1.0; Figure 3.5). The two included samples of *Trophis* in the present study form a clade sister to the "core" *Morus* clade, with the remainder of sampled *Morus* taxa forming a more basal clade. Relationships with regard to *Trophis* and other genera of Moraceae are discussed below.

*Morus mesozygia* has a well-defined natural distribution (Africa) and distinct leaf and syncarp morphology. Leroy (1949) had classified this species in the subgenus *Afromorus*. Similarly, *M. insignis*, which was classified by Leroy into subgenus *Gomphomorus*, is another genetically distant species relative to the "core" *Morus* clade and likewise has distinctive leaf and syncarp morphology. Both Old World *M. macroura* and New World *M. insignis* are characterized by a long syncarp, apparently due to parallel evolution.

A broader scale phylogeny of the "Urticalean Rosids" by Sytsma et al. (2002) suggested that the tribe Moreae is non-monophyletic within Moraceae, leading Berg (2005) to assert a conflict between molecular data and traditional concepts of what he considers a distinct natural group. The findings of Datwyler and Weiblen (2004) and Zerega et al. (2005) were consistent

with those of Sytsma et al. (2002), and had expanded sampling. Both of these studies found *Morus* (represented by two samples in each case) to group with *Trophis*, with *Sorocea* sister to a *Morus-Trophis* clade. The genus *Trophis*, with ca. ten species distributed in both the New World and the Old World, has been divided into six sections (Rohwer, 1993). Some of the taxa have morphological features that often result in confusion with taxa of *Streblus*. The genus *Streblus*, with ca. 24 species distributed in the Old World, has been divided into five sections. Three of these sections closely resemble *Trophis* (as indicated in part by their names, including *Paratrophis*, *Pseudotrophis* and *Taxotrophis*), and sometimes the sections are difficult to distinguish (Berg, 1988). The genera *Trophis* and *Streblus* are complex in terms of variation in morphology, and have more unstable taxonomic histories than does *Morus*. Previous studies at higher taxonomic levels have indicated that both *Trophis* and *Streblus*, as traditionally circumscribed, are non-monophyletic.

Thus, this focused study on *Morus* has brought to light phylogenetic confusion at higher taxonomic levels, perhaps indicative of Moraceae taxonomy as a whole. Thus at a time when taxonomy of the genera in the tribe Moreae is not fully understood (Berg, 2005), the sister genus to *Morus* is still in question. This can be an interesting avenue for further research. Our data complementing the previous studies further demonstrate that the tribe Moreae is taxonomically problematic, and further investigation of the tribe will be interesting.

## **Biogeography**

Mapping of the present distribution of *Morus* on to the phylogeny suggests a strong geographical patterning (Fig. 3.5). The genus has at least two centers of diversity: one in Asia, one in the Central and North America (Sanjappa, 1965; Leroy 1949). The biogeographical patterning in the phylogeny is not particularly revealing in terms of hypotheses of geographical

origins of the genus due to the questions of monophyly involving *Morus* and closely related genera (e.g., *Trophis*, *Streblus*, possibly *Sorocea*). Even if *Trophis* were to be subsumed with *Morus* (and sampling here is highly limited), the sister clade to the *Morus-Trophis* clade includes *M. insignis* and *M. mesozygia*, which occur in South America and Africa, respectively. Zerega et al. (2005) hypothesized an origin for the family in South America followed by migration worldwide. Origins of the genus *Morus* (and close relatives) remain unclear. Several particularly noteworthy points are demonstrated and highlighted by the present ITS/*trnL-trnF* phylogeny: the genus *Morus*, as currently circumscribed, is non-monophyletic; relationships of the species exhibit strong geographical patterning; and the relationships of the Asian taxa are not resolved. Additional phylogenetic study of *Morus* (with consideration of other potential close relatives and potentially additional gene regions) will be required to further investigate these issues. The phylogenetic information in the present study is an important step in understanding relationships of *Morus*, and complements the growing body of systematic work in the Moraceae.

## ACKNOWLEDGEMENTS

I gratefully acknowledge support from the Division of Biology, Konza Prairie Biological Station, the Kansas State University Herbarium (KSC), an American Society of Plant Taxonomists (ASPT) Graduate Student Research Grant (2007), and the Rotary Club International Graduate Student Research Award (2006). I thank Missouri Botanical Garden Herbarium (MO) and Gray Herbarium (GH) for granting permission to sample material from herbarium specimens for molecular work; George Weiblen and Wendy Clement (University of Minnesota) for providing DNA samples of *Trophis* and *Sorocea*; and T.N. Bhattarai (Nepal) and Sharada Krishnan (Denver Botanical Garden) for sending samples of *M. serrata* and *M. nigra*, respectively. I thank Drs. Mark Mayfield, David Hartnett, Mark Ungerer, Karen Garrett and Shannon Fehlberg for their support and useful discussion.



## LITERATURE CITED

AGGARWAL, R. K., D. UDAYKUMAR, P. S. HENDRE, A. SARKAR, AND L. I. SINGH.

2004. Isolation and characterization of six novel microsatellite markers for mulberry (*Morus indica*). *Molecular Ecology Notes* 4: 477-479.

AWASTHI, A. K., G. M. NAGARAJA, G. V. NAIK, S. KANGINAKUDRU, K.

THANGAVELU AND J. NAGARAJU. 2004. Genetic diversity and relationships in mulberry (genus *Morus*) as revealed by RAPD and ISSR marker assays. *BMC Genetics* 5: 1-9.

AZIZAN, D. AND A. SONBOLI. 2001. Chromosome counts for five species of Moraceae from

Iran. *Iranian Journal of Botany* 9: 103-106.

BERG, C. C. 2005. Moraceae diversity in a global perspective. Proceedings of an international

symposium on plant diversity and complexity patterns: local, regional, and global dimensions at Royal Danish Academy of Science, Copenhagen, Denmark. *Biologiske Skrifter* 55: 423-440.

BERG, C. C. 2001. Moreae, Artocarpeae, and Dorstenia (Moraceae) with introductions to the family and *Ficus* and with additions and corrections to Flora Neotropica Monograph 7.

New York Botanical Garden Press, New York, New York, USA. .

BERG, C. C. 1989. Systematics and phylogeny of the Urticales. Pp. 193-220 in Evolution,

systematics, and fossil history of the Hamamelidae Volume 2. P. R. Crane and S. Blackmore (eds.). Clarendon Press, Oxford, UK.

- BERG, C. C. 1988. The genera *Trophis* and *Streblus* (Moraceae) remodeled. *Proceedings of the Koninklijke Nederlandse Akademie van Wetenschappen, Amsterdam, the Netherlands, series C* 91: 345-362
- BHATTACHARYA, E. AND S. A. RANADE. 2001. Molecular distinction amongst varieties of Mulberry using RAPD and DAMD profiles. *BMC Plant Biology* 1: 1-8.
- BUREAU, E. 1873. Moraceae. Pp. 211-288 in *Prodromus systematis naturalis regni vegetabilis*. Volume 17. A. DeCandolle (ed.). Paris, France.
- BURGESS, K. S., M. MORGAN, L. DEVERNO AND B. C. HUSBAND. 2005. Asymmetrical introgression between two *Morus* species (*M. alba*, *M. rubra*) that differ in abundance. *Molecular Ecology* 14: 3471-3483.
- CAO, Z. Y. 1991. New taxa of *Morus* (Moraceae) from China. *Acta Phytotaxonomica Sinica* 29: 264-267.
- CHANG, S. S. 1984. New taxa of Moraceae from China and Vietnam. *Acta Phytotaxonomica Sinica* 22: 64-76.
- DATWYLER, S. L. AND G. D. WEIBLEN. 2004. On the origin of the fig: phylogenetic relationships of Moraceae from *ndhF* sequences. *American Journal of Botany* 91: 767-777.
- DOWNIE, S. R. AND D. S. KATZ-DOWNIE. 1996. A molecular phylogeny of Apiaceae Subfamily Apioideae: evidence from nuclear ribosomal DNA internal transcribed spacer sequences. *American Journal of Botany* 83: 234-251.

- DOYLE, J. J. AND J. L. DOYLE. 1987. A rapid DNA isolation procedure for small quantities of fresh leaf tissue. *Phytochemical Bulletin* 19: 11-15.
- FARRIS, J. S., M. KALLERSJO, A. G. KLUGE AND C. BULT. 1995. Constructing a significance test for incongruence. *Systematic Biology* 44: 570-572.
- FARRIS, J. S., M. KALLERSJO, A. G. KLUGE AND C. BULT. 1994. Testing significance of incongruence. *Cladistics* 10: 315-319.
- FELSENSTEIN, J. 2004. Inferring phylogenies. Sinauer Associates, Inc., Sunderland, Massachusetts.
- FELSENSTEIN, J. 1988. Phylogenies from molecular sequences: Inference and reliability. *Annual Review of Genetics* 22: 521-565.
- FELSENSTEIN, J. 1985. Confidence limits on phylogenies: an approach using the bootstrap. *Evolution* 39: 783-791.
- GRAY, E. AND R. E. GRAY. 1987. Leaf lobation patterns in mulberry. *Castanea* 52: 216-224.
- GREEN, E. L. 1910. Some southwestern mulberries. Leaflets of botanical observation and criticism Volume 2. Washington D.C. Pp. 112-121.
- HOTTA, T. 1954. Fundamentals of *Morus* plants classification (in Japanese). *Kinugasa Sanpo* 390: 13-21.
- HUELSENBECK, J. P. AND F. RONQUIST. 2001. MRBAYES: Bayesian inference of phylogeny. *Bioinformatics* 17: 754-755.

- JANAKI-AMMAL, E. K. 1948. The origin of black mulberry. *Journal of the Royal Horticultural Society* 73: 117-120.
- KATSUMATA, F. 1971. Shape of idioblasts in mulberry leaves with special reference to the classification of mulberry trees. *Journal of Sericultural Science of Japan* 40: 313-322.
- KOIDZUMI, G. 1917. Taxonomy and phytogeography of the genus *Morus*. *Bulletin of Sericultural Experimental Station (Tokyo)* 3: 1-62.
- LEROY, J. F. 1949. Les Mcriers sauvages et cultivds. La sericulture sous les tropiques. *Revue Internationale de Botanique aaplique'e et d'agriculture Tropicale* 29: 481-496.
- LINNAEUS, C. 1753. *Morus*. Species plantarum. Volume 2: Stockholm, Sweden. P. 968.
- LOOCKERMAN, D. J. AND R. K. JANSEN. 1996. The use of herbarium material for DNA studies. Pp. 205-220 in *Sampling the Green World*, eds. Stuessy T. F. and S. J. Sohmer. Oxford, Columbia University Press.
- POSADA, D. AND K. CRANDALL. 1998. MODELTEST: testing the model of DNA substitution. *Bioinformatics* 14: 817-818.
- POSADA, D. AND T. R. BUCKLEY. 2004. Model selection and model averaging in phylogenetics: advantages of the AIC and Bayesian approaches over likelihood ratio tests. *Systematic Biology* 53: 793-808
- RAMBAUT, A. 2002. Se-AI v2.0a11 Carbon. University of Oxford, UK.

- RAMESH, S. R. AND BASAVAIHAH. 1989. Systematic position of the genus *Morus* L. Pp. 43-48 in Genetic resources of mulberry and utilization, eds. K. Sengupta and S. B. Dandin. CSRTI, Mysore, India.
- RAO, C. K. AND C. E. JARVIS. 1986. Lectotypification, taxonomy and nomenclature of *Morus alba*, *M. tatarica* and *M. indica* (Moraceae). *Taxon* 35: 705-708.
- ROHWER, J. G. 1993. Moraceae. Pp 438-453 in The families and genera of vascular plants. Volume 2. Flowering plants. Dicotyledons. Magnoliid, Hamamelid and Caryophyllid families. K. Kubitzki, J. G. Rohwer, and V. Bittrich (eds.). Springer-Verlag, Berlin, Germany. .
- SEYMOUR, F. C. 1952. Notes on Moraceae and Ulmaceae. *American Midland Naturalist* 48: 249-250.
- SANJAPPA, M. 1989. Geographical distribution and exploration of the genus *Morus* L. (*Moraceae*). Pp. 4-7 in Genetic resources of mulberry and utilization. K. Sengupta and S. B. Dandin (eds.). CSRTI, Mysore, India.
- SHARMA, A., R. SHARMA AND H. MACHII. 2000. Assessment of genetic diversity in a *Morus* germplasm collection using fluorescence-based AFLP markers. *Theoretical and Applied Genetics* 101: 1049-55.
- SHAW, J., E. B. LICKY, J. T. BECK, S. B. FARMER, W. LIU, J. MILLER, K. C. SIRIPUN, C. T. WINDER, E. E. SCHILLING AND R. L. SMALL. 2005. The tortoise and the hare

- II: relative utility of 21 non-coding chloroplast DNA sequences for phylogenetic analysis. *American Journal of Botany* 92: 142-166.
- STAPANIAN, M. A. 1982. A model for fruiting display: seed dispersal by birds for mulberry trees. *Ecology* 63: 1432-1443.
- SWOFFORD, D. 2002. PAUP\*. Phylogenetic analysis using parsimony (\* and other methods), Version 4. Sinauer, Sunderland, MA, USA.
- SYTSMA, K. J., J. MORAWETZ, J. C. PIRES, M. NEPOKROEFF, E. CONTI, M. ZJHRA, J. C. HALL AND M. W. CHASE. 2002. Urticalean rosids: circumscription, rosid ancestry, and phylogenetics based on *rbcL*, *trnL-F*, and *ndhF* sequences. *American Journal of Botany* 89: 1531-1546.
- TABERLET, P., L. GIELLY, G. PAUTOU AND J. BOUVET. 1991. Universal primers for amplification of three non-coding regions of chloroplast DNA. *Plant Molecular Biology* 17: 1105-1109.
- TANI, N., T. KAWAHARA AND H. YOSHIMARU. 2005. Development and diversity of microsatellite markers for endangered species, *Morus boninensis* Koidz., to establish conservation program. *Molecular Ecology Notes* 5: 398-400.
- TIKADER, A. AND A. RAO. 2001. Analysis of divergence in mulberry species through different clustering technique. *Sericologia* 41: 109-116.
- VEINKATARAMAN, K. 1972. Wood phenolics in the chemotaxonomy of the Moraceae. Review article. *Phytochemistry* 2: 1571-1586.

VIJAYAN, K., P. K. KAR, A. TIKADER, P. P. SRIVASTAVA, A. K. AWASTHI, K.

THANGAVELU AND B. SARATCHANDRA. 2004. Molecular evaluation of genetic variability in wild populations of mulberry (*Morus serrata* Roxb.). *Plant Breeding* 123: 568-572.

VIJAYAN, K., P. P. SRIVASTAVA, C. V. NAIR, A. K. AWASTHI, A. TIKADER, B.

SREENIVASA AND S. R. URS. 2006. Molecular characterization and identification of markers associated with yield traits in mulberry using ISSR markers. *Plant Breeding* 125: 298-301.

WEIGUO, Z., X. MIAO, S. JIA, Y. PAN AND Y. HUANG. 2005. Isolation and characterization of microsatellite loci from the mulberry, *Morus L.* *Plant Science* 168: 519-525.

WEIGUO, Z., Y. PAN, Z. ZHANG, S. JIA, X. MIAO AND Y. HUANG. 2005. Phylogeny of the genus *Morus* (Urticales: Moraceae) inferred from ITS and *trnL-F* sequences. *African Journal of Biotechnology* 4: 563-569.

WHITE, T. J., T. BRUNS, S. LEE AND J. TAYLOR. 1990. Amplification and direct sequencing of fungal ribosomal RNA genes for phylogenetics. Pp. 315-322 in PCR protocols: a guide to methods and applications. M. Innis, D. Gelfand, J. Snisky and T. J. White (eds.). Academic Press, San Diego, USA.

WUNDELIN, R. P. 1997. Moraceae. Pp.388-399 in Flora of North America Volume 3. Flora of North America Editorial Committee (eds.). Oxford University Press, New York, USA.

WU, C. Y. AND S. S. CHANG. 1989. Taxa nova nonnulla Moracearum sinensium. *Acta Botanica Yunanica* 11: 24-34.

ZEREGA, N. J. C., W. L. CLEMENT, S. L. DATWYLER AND G. D. WEIBLEN. 2005. Biogeography and divergence times in the mulberry family (Moraceae). *Molecular Phylogenetics and Evolution* 37: 402-416.

ZHOU, Z. AND M. G. GILBERT. 2003. Moraceae. Pp. 21-73 in Flora of China. Volume 5. Z. Wu, P. H. Raven and D. Hong (eds.). Science Press, Beijing, China.



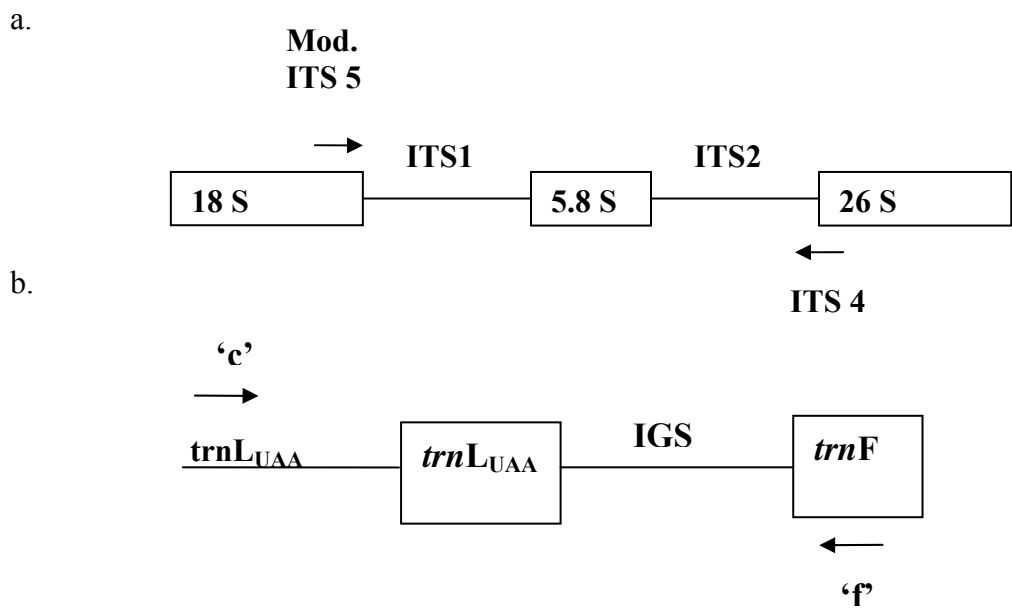

**Figure 3.1** Diagrammatic representation of amplified portion of a) the ITS region of the nuclear ribosomal DNA, and b) the *trnL-trnF* region of the chloroplast.

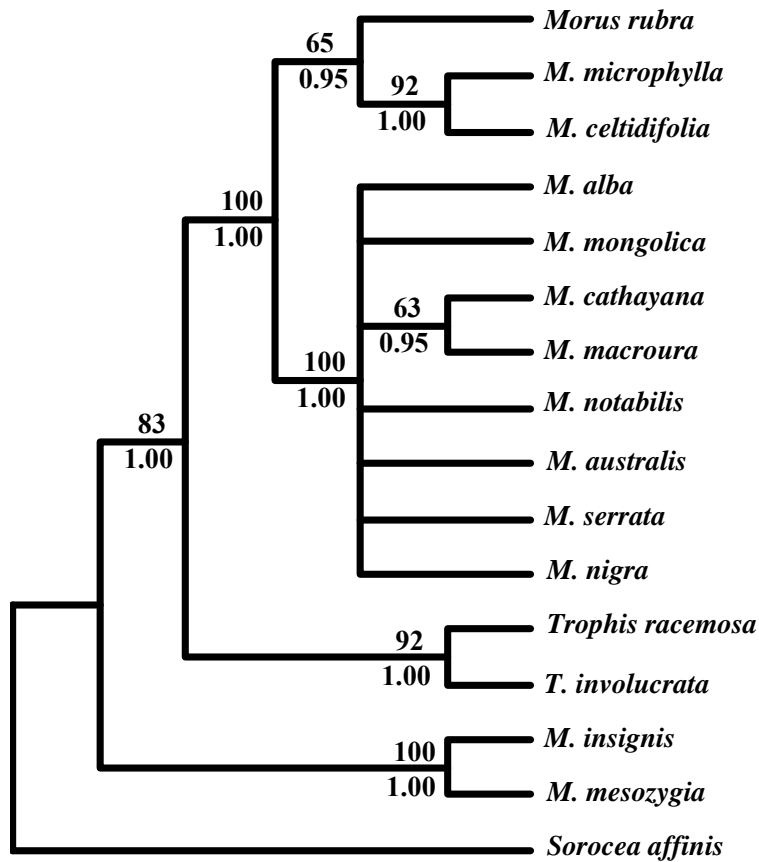

Figure 3.2 Strict consensus of 80 most parsimonious trees based on the ITS data set with gaps coded as missing data. The numbers above the branches are bootstrap values based on 20,000 replicates. The maximum likelihood tree was in agreement in topology with slight change in resolution.

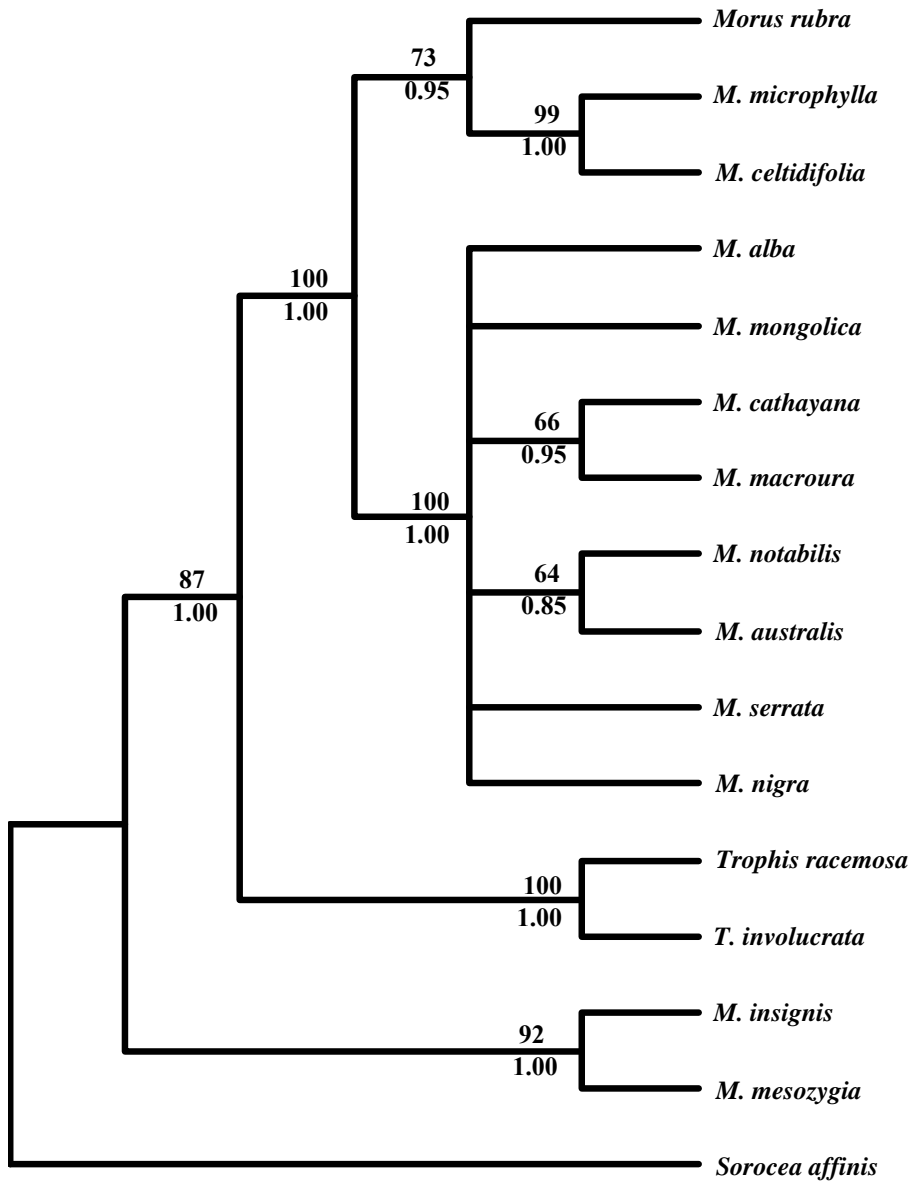

Figure 3.3 Strict consensus of four most parsimonious trees based on the ITS data set with gaps coded as a new state. The numbers above the branches are bootstrap values based on 20,000 replicates.

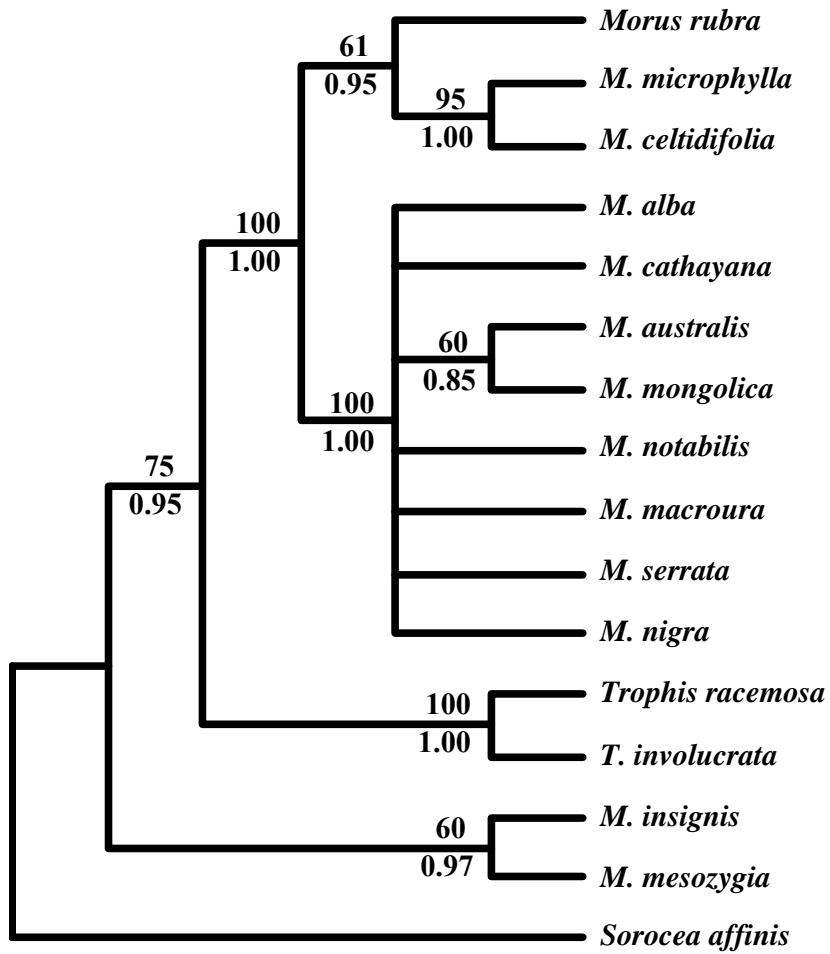

Figure 3.4 Single most parsimonious tree based on the *trnL-trnF* data set with gaps coded as missing. The numbers above the branches are bootstrap values based on 20,000 replicates. [The tree topology when analyzed gap as new state (5 parsimonious trees) remained the same.]

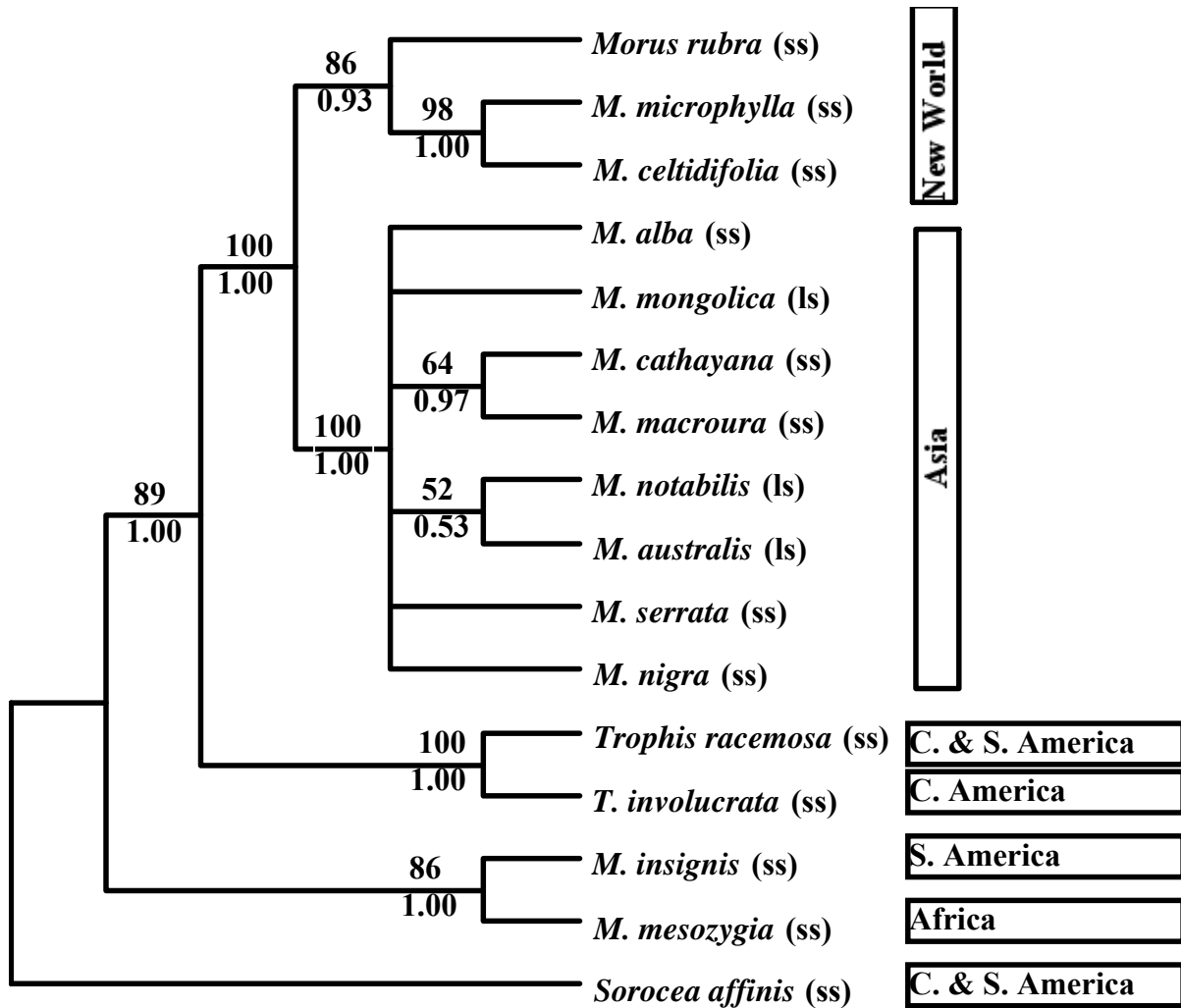
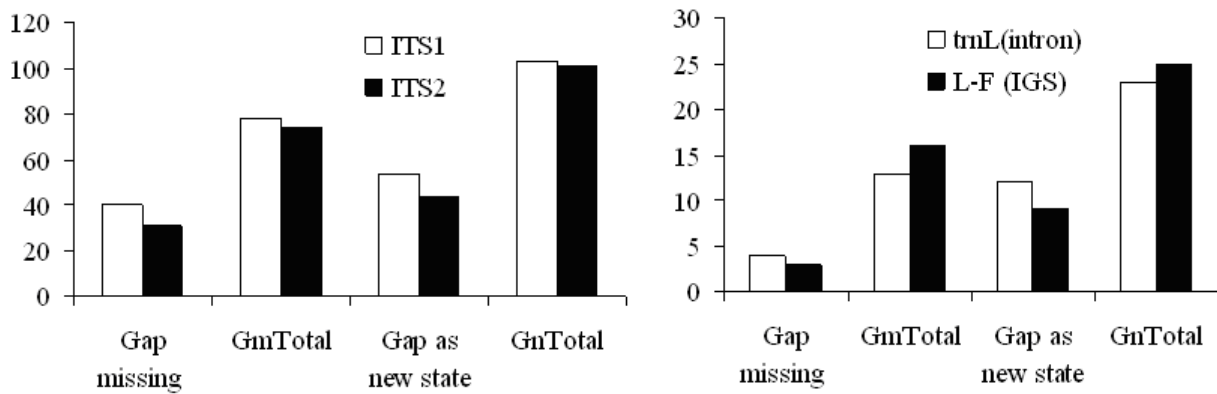

Figure 3.5 Single most parsimonious tree based on the combined data set. Numbers above the branches are bootstrap values based on 20,000 replicates and numbers below the branches are the posterior probabilities from Bayesian analysis. Maximum likelihood analysis yielded the same tree topology. The style length character (short style = ss, long style = ls) is indicated in parentheses after the taxon name.



**Figure 3.6** Parsimony informative characters in *Morus* ITS (ITS1 and ITS2) and *trnL-trnF* (*trnL* intron and *trnL-trnF* intergenic spacer) sequences. GmTotal and GnTotal indicate total number of variable characters for gaps treated as missing and for gaps treated as new state, respectively.

**Table 3.1 Samples included in the phylogenetic study, with information on taxon name, native distribution, voucher information and voucher location.**

<b>Taxon</b>	<b>Distribution</b>	<b>Locality information</b>	<b>Herbarium</b>
<i>Morus alba</i> L.	South and Central China	Nepal MN396, Kansas, United States	KSC
<i>M. australis</i> T. Hotta	Japan, China, Korea, Nepal India	Murata 71055, Kyushu, Japan	MO
<i>M. cathayana</i> Z.Y. Cao	China, Korea, Japan	Bufford 26210, Yunnan, China	MO
<i>M. celtidifolia</i> Kunth	Mexico to Honduras	Carrazana 823, Mexico	MO
<i>M. insignis</i> Bureau	S. Mexico to Northern S. America	Homeier 615, Zamora-Chinchipe, Ecuador	MO
<i>M. macroura</i> Miq.	Southern China to S. and E. Asia	Dao 90-272, Thailand	MO
<i>M. mesozygia</i> Stapf.	Tropical Africa	ATBT 639, Uganda	MO
<i>M. microphylla</i> Buckley	North and Central America	Merello1989, Arizona, United States	MO
<i>M. mongolica</i> C.K. Schneid.	China, Taiwan Japan, Korea	Liu and Zheng 202, Gansu, China	MO
<i>M. nigra</i> L.	Western Iran	Krishnan 813, Colorado, United States	KHD
<i>M. notabilis</i> C.K. Schneid,	South and Central China	Heng 11734, Yunnan, China	GH
<i>M. rubra</i> L.	Eastern USA to Ontario Canada	Nepal MN701, Kansas, United States	KSC
<i>M. serrata</i> Roxb.	India, Nepal, China	Bhattarai 1, Ilam, Nepal	KSC
<i>Trophis racemosa</i> (L) Urban	Mexico through Argentina	Weiblen 1400, Costa Rica	MIN
<i>T. involucrata</i> W. Burger	Costa Rica	Weiblen 1405, Costa Rica	MIN
<i>Sorocea affinis</i> Hemsl.	Costa Rica to Panama	Weiblen 1437, Costa Rica	MIN

**Table 3.2 Nucleotide sequences (10 bp) at the beginning and end of the amplified portions of ITS and *trnL-trnF* sequences for *Morus*. Partial sequences of designated regions are indicated by asterisks.**

<b>Region amplified</b>	<b>Sequence starts with</b>	<b>Sequence ends at</b>
<b>18S (partial)</b>	<b>**TTT CCG TAG G</b>	<b>AGG ATC ATT G</b>
<b>ITS1</b>	<b>TCG AAA CCT G</b>	<b>GTT TAA GTC T</b>
<b>5.8 S</b>	<b>AAA ATG ACT C</b>	<b>GGG CGT CAA(C) A</b>
<b>ITS2</b>	<b>ACC G(T/A)T GCC C</b>	<b>A(C/T)T ( G/A)AT G (T/C)G A</b>
<b>26S</b>	<b>CCC CAG GTC A</b>	<b>CTG AGT TTA A**</b>
<b><i>trnL</i><sub>UAA</sub> (intron)</b>	<b>**ATG AGC TTG G</b>	<b>TAG TAA GAG G</b>
<b><i>trnL</i><sub>UAA</sub></b>	<b>AAA ATC CGT C</b>	<b>CCC CAA AAA G</b>
<b><i>TrnL-F</i> (IGS)</b>	<b>GTC CAT CTG A</b>	<b>GTG AGG AAT G</b>
<b><i>trnF</i></b>	<b>GTC GGG ATA G</b>	<b>AGA GCA GAG G**</b>



**Table 3.3 Sequence length of ITS and *trnL-trnF* in *Morus*.**

Taxon	ITS				<i>trnL-trnF</i>				
	ITS1	5.8S	ITS2	Total	<i>trnL</i> <sub>UAA</sub>	<i>trnL</i> <sub>UAA</sub>	L-F	<i>trnF</i>	Total
				length	(intron)	(exon)	(spacer)	(exon)	length
<i>Morus rubra</i>	240	159	235	634	487	54	373	28	942
<i>M. microphylla</i>	239	159	236	634	487	54	373	28	942
<i>M. celtidifolia</i>	239	159	236	634	487	54	373	28	942
<i>M. alba</i>	227	159	233	619	481	54	373	28	936
<i>M. mongolica</i>	225	159	233	617	482	54	373	28	937
<i>M. cathyana</i>	225	159	233	617	481	54	373	28	936
<i>M. notabilis</i>	226	159	233	618	481	54	373	28	936
<i>M. australis</i>	226	159	233	618	483	54	373	28	938
<i>M. macroura</i>	226	159	233	618	481	54	373	28	936
<i>M. insignis</i>	240	159	232	631	487	54	373	28	942
<i>M. mesozygia</i>	242	159	218	619	487	54	373	28	942
<i>Trophis racemosa</i>	241	159	239	639	487	54	373	28	942
<i>T. involucrata</i>	241	159	238	638	487	54	373	28	942
<i>M. serrata</i>	228	159	233	620	481	54	373	28	936
<i>M. nigra</i>	228	159	233	620	481	54	373	28	936
<b>Average length</b>	<b>233</b>	<b>159</b>	<b>233</b>	<b>625</b>	<b>484</b>	<b>54</b>	<b>373</b>	<b>28</b>	<b>939</b>

**Table 3.4 Statistics from parsimony analyses of different data sets. CI values listed are excluding uninformative characters.**

<b>Gap handling</b>	<b>Description</b>	<b>ITS (ITS1, 5.8S, ITS2) data set</b>	<b><i>trnL-trnF (trnL intron, IGS) data set</i></b>	<b>Combined data set</b>
<b>Gaps as missing</b>	<b>Variable sites</b>	154 (78, 12, 74)	29 (13,16)	183
	<b>Potentially informative sites</b>	78 (40, 7, 31)	7 (4,3)	85
	<b>Number of most parsimonious trees</b>	80	1	77
	<b>Tree lengths</b>	252	73	325
	<b>CI</b>	0.74	0.97	0.75
<b>Gaps as new state</b>	<b>Variable sites</b>	216 (103, 12, 101)	48 (23, 25)	264
	<b>Potentially informative sites</b>	104 (54, 7, 43)	24 (12,9)	132
	<b>Number of most parsimonious trees</b>	4	5	1
	<b>Tree lengths</b>	309	102	421
	<b>CI</b>	0.77	0.79	0.78

**Table 3.5 Best substitution models with parameter values for *Morus* sequences, as determined using ModelTest. R (a) = [A-C], R(b) = [A-G], R(c) = [A-T], R(d) = [C-G], R(e) = [C-T] & R(f) = [G-T].**

<b>Data set</b>	<b>Model under hLRT</b>	<b>Model under AIC, -lnL, K &amp; AIC values</b>	<b>Base frequencies A, C, G &amp; T</b>	<b>Rate matrix: R (a), R (b), R (c), R (d), R (e) &amp; R (f)</b>	<b>Invariable sites (I)</b>	<b>Gamma shape (G)</b>
<b>ITS</b>	TIM+G	GTR+G , 2075.57, 38 & 4227.14	0.22, 0.29, 0.29 & 0.20	0.73, 2.52, 0.78, 0.13, 4.74 & 1.00	0	0.4115
<b><i>trnL-trnF</i></b>	HKY	K81uf, 1494.20, 34 & 3056.42	0.35, 0.18, 0.18 & 0.29	1.00, 2.86, 0.35, 0.35, 2.8 & 1.00	0	0
<b>Combined</b>	TIM+G	TIM+I+G, 3725.24, 37 & 7524.49	0.29, 0.23, 0.23 & 0.28	1.0, 2.78, 0.42, 0.42, 5.2 & 1.00	0.533	0.7884

# **CHAPTER 4 - SEX EXPRESSION PATTERNS IN *MORUS RUBRA* AND *M. ALBA* (MORACEAE) IN THE FLINT HILLS REGION OF KANSAS**

## **ABSTRACT**

Striking arrays of sex expression patterns are present in angiosperms: this variation has not been well explored in many species, and can have important effects on reproductive success. These patterns are of particular interest when considered in the context of a native and an invasive species. In this study, patterns of sex expression were examined in populations of two congeneric tree species in north-central Kansas: the native *Morus rubra* and the introduced *M. alba*. Sex expression was assessed for 13 populations (nine of *M. rubra* and 13 of *M. alba*) during the 2007 flowering episode, and one population was studied during three flowering episodes (2005, 2006 and 2007). Both species were found to exhibit subdioecy (leaky dioecy), with the ratio of unisexual to hermaphrodite trees being approximately 8:1 in each species. There was no detected size dependence of sex expression. All populations of each species exhibited a male-biased sex ratio with the native *M. rubra* being slightly more male-biased. Within a species, sex ratio did not vary significantly among populations. Interestingly, hermaphroditism was statistically more common in trees growing at a greater distance from neighboring conspecific trees. The three-year study documented year to year changes in sex expression in ca.

10% of the individuals. These findings provide an interesting comparison of the sex expression patterns between the native *M. rubra* and the invasive *M. alba*.

Keywords: *Morus*, subdioecy, sex ratio, sex change, invasive species

## INTRODUCTION

Flowering plants exhibit an intriguing array of sexual systems i.e. breeding systems (defined as the distribution of sexual parts within and between individuals; Delph and Wolf, 2005), along a continuum from hermaphroditism (male and female parts on the same individual) to dioecy (male and female parts on separate individuals). Sex expression patterns in plants are interesting as they present evidence of evolution of breeding system, and provide insights about various aspects of ecology and evolutionary biology including: reproductive success, inbreeding depression, expression and fixation of recessive deleterious mutations (reviewed in Charlesworth, 2006) and plasticity of sex expression (Delph and Wolf, 2005). The breeding systems of many plant species have not been extensively explored (Charlesworth, 2006). The study of breeding system and sex expression patterns is of particular interest when comparison can be made between a native species and an invasive congener, because it can yield insights about the reproductive success of the latter.

Dioecious species constitute ca. 6% of angiosperms (Renner and Ricklefs, 1995), and are believed to have evolved from hermaphrodite ancestors to avoid effects of inbreeding (Charlesworth and Charlesworth, 1978; Thomson and Barrett, 1981), and to make the resource allocation mechanism efficient (Bawa, 1980; Ainsworth, 2000). Subdioecy (three sexual morphs: male, female and hermaphrodite) is a transition in the hermaphroditism-dioecy continuum, and has been documented in several plant species (e.g. reviewed in Case et al., 2008). Subdioecy has evolved from hermaphroditism through two common pathways: 1) through the spread of sterility mutation (e.g., through gynodioecy or the less common androdioecy, and 2) through the breakdown of dioecy (considered less common; reviewed in Delph and Wolf, 2005). In order to

obtain insights about the mechanisms of evolution of breeding systems, it is important to understand the sex ratio dynamics of plant species.

A sex ratio (male/female) of 1:1 is expected in a stable population of a dioecious species if the reproductive cost of males is equal to that of females (Fisher, 1930). Plants are immobile and have developed several evolutionary strategies for reproductive assurance, which can result in a sex ratio deviation. The amount and pattern of deviation can vary from species to species, among flowering episodes and across populations along environmental gradients (see Queenborough et al., 2007). Although several studies have documented sex ratio variation between flowering episodes (e.g., Thomas and LaFrankie, 1993; Nicotra, 1998; Morellato, 2004, Yamasita and Abe, 2004), fewer studies have observed the same individuals for more than two flowering episodes (Yamasita and Abe, 2004; Wheelwright and Logan, 2004), and still fewer studies have included more than one species (Thomas and LaFrankie, 1993, Queenborough et al., 2007). Sex expression studies over multiple flowering episodes are important for providing information on flowering frequency, size dependence, and stability of sex expression (e.g. Nanami et al., 2004; Yamasita and Abe, 2004).

Spatial distribution of individuals in a population is an important factor in successful survival and reproduction of a species (House, 1992; Stacy et al., 1996). For example, individuals of a wind-pollinated dioecious species may experience pollen limitation in areas distant from other individuals. Ashman et al. (2004) proposed to consider pollen limitation in the context of other life history traits, Allee effects and effects of disturbance on plant population. Aggregation of males and females may facilitate pollen transfer (Bawa and Opler, 1977). This works well if the habitat is homogeneous in terms of resources. Some species exhibit spatial segregation of the sexes (SSS), where individuals are partitioned along a resource gradient with

females predominately in the resource rich habitats and males in relatively resource poor habitats (Lloyd and Webb, 1977; Bierzychudek and Eckhart, 1988). There are other factors related to spatial distribution that affect the reproduction of dioecious species such as distance between males and females (Mack, 1997), flowering frequency (Bawa, 1980), effective population size (Nunney, 1995), and pollinator abundance and flight behavior (Stacy et al., 1996). Strategies such as leaky dioecy, and parthenocarpy have been suggested for reproductive assurance (e.g., Baker and Cox, 1984; Venkatasamy et al., 2007). Production of fleshy fruits (Bawa, 1980), woody perennial habit, multi-seeded fruits, and dispersal by birds (Baker and Cox, 1984) are commonly associated with dioecy (Baker and Cox, 1984).

Size-dependent sex expression occurs when male and female individuals exhibit differential reproductive costs (Lloyd and Bawa, 1984). Because of the cost for the formation of fruits and for future survival and reproduction (Charnov, 1982; Lloyd and Bawa, 1984), females generally have higher reproductive costs than those of males, and are usually larger in size. In wind pollinated dioecious plants, fewer studies have shown a higher cost of reproduction in females (Smith, 1981; Murakami and Maki, 1993). These studies also indicated that resource rich environment favors the females and resource poor/stressful habitat favors the males. However, other studies have found a positive correlation between the male investment and plant size facilitating the dispersal of pollen (e.g. Freeman et al., 1980; Barker et al., 1982; Solomon, 1989).

*Morus rubra* L. is distributed in eastern North America from the east coast to the eastern margin of the Great Plains, and it extends to southern Ontario (Canada), and occurs in isolated patches of woodlands (Wunderlin, 1997). *Morus alba*, a native to China, was introduced into North America in the 1600s in attempts to establish a silkworm industry in the United States, and



it is now used widely as an ornamental and fruit tree. After escaping cultivation, *M. alba* has successfully naturalized (Gleason, 1952). It co-occurs with the native *M. rubra* often in forests, and also occurs commonly in open areas, and is considered ecologically invasive (Hoffman and Kearns, 1997; Uva et al., 1997; Weber, 2003). Relative to the native species, *M. alba* has much higher pollen production (Burgess et al., 2008), higher capacity of seed production and better quality of fruits for dispersal by birds (Stapanin, 1982). The invasive success of *M. alba* remains relatively unexplored, and may in part be attributable to reproductive behavior. *Morus* species have been treated as dioecious or monoecious in the existing floras (Berg, 2001; Whittmore pers. comm.) and sexual systems in *Morus* have not been extensively explored. Both species produce unisexual flowers in catkins, and the catkins can be unisexual or bisexual. Taxonomic descriptions of each species are given in Chapter 1, and additional information is in Chapter 5.

My main objectives in this research were to document the breeding systems of *M. alba* and *M. rubra*, and to investigate the patterns of sex ratio variation of these species to gain insights into the differences in reproductive strategies between the introduced species and the native species. Introduced species may become invasive and adversely affect the natural ecosystems (Vitousek et al., 1987); however, how these species become successful remains poorly understood (Barrett 2000). Understanding reproductive behavior of an introduced species with reference to its native congener is an important step towards obtaining insights about the mechanism of invasion (Barrett et al., 2008). In the present study, I used census data collected for the native-invasive pair of *Morus* in the Flint Hills of region of Kansas to address the following questions. What breeding systems do *M. alba* and in *M. rubra* exhibit? Do sex ratios deviate from 1:1? Do the sex ratios of each species remain constant from a given year to the next? Does sex ratio vary from population to population? Is there any evidence of segregation of

sexes? Does sex expression depend on size? Is hermaphroditism associated with remoteness or isolation?

## **MATERIALS AND METHODS**

### **Site description**

The present study was conducted in multiple locations in the Flint Hills region of Kansas. The Flint Hills region extends throughout an area of 29,600 km<sup>2</sup> in eastern Kansas and northern Oklahoma, and is a distinct grassland ecoregion in the Great Plains (see Klinkenberg, 2007). Although largely dominated by C<sub>4</sub> grasses (with dominants including *Andropogon gerardii*, *Sorghastrum nutans*, *Panicum virgatum* and *A. scoparius*), riparian areas are wooded and dominated by *Celtis occidentalis* and *Quercus* spp. The present study was conducted at several locations in the Flint Hills: Kings Creek and Shane Creek areas of Konza Prairie Biological Station (KPBS); Pottawattamie Lake No.1 and No. 2; Timber Creek and Farnum Creek areas of Milford Lake; Slough Creek Park area of Perry Lake; Annenberg Park and the Linear Park area of Manhattan Kansas, south-east and west sections of Tuttle Creek Lake, and the Three Miles Creek area of Fort Riley Military reservation. The KPBS was studied during three flowering episodes (2005, 2006 and 2007). KPBS is a tallgrass prairie preserve owned by The Nature Conservancy, operated by Kansas State University, and managed for ecological research. A distribution map of *Morus* in each location is given in Figure 5.1.

### **Study of sex expression and sexual systems**

Sex expression of *Morus* in thirteen areas (nine in which the species co-occur and four areas in which *M. alba* only occurs; 22 populations total). *Morus* trees were exhaustively located within each area, and Global Positioning System (GPS) coordinates (longitude/latitude) were

recorded using a hand-held Garmin® GPS 12 Personal Navigator™ (Garmin International, Inc.). Inflorescences were observed from the ground, and binoculars, a pole-pruner and a ladder, were also used as when needed. While assessing hermaphrodite individuals, the proportion of male and female flowers was estimated. For each tree, nearest neighbor distance was estimated and diameter at breast height (DBH) was measured. Juvenile individuals (less than 0.5 m in height) were very rare, and were not included in this study. Representative voucher specimens were collected and deposited at the Kansas State University Herbarium (KSC).

In order to study inter-year variation in sex expression, a site along Kings Creek of KPBS was chosen and studied during three flowering episodes (2005, 2006 and 2007). All trees were tagged with a unique number (tree number) using 2.5 cm anodized aluminum tags (Ben Meadows Company). Each tag was placed on the north side of the tree at the DBH level with a thin galvanized steel nail. Male and female trees were also marked with red and yellow flagging tapes, respectively. Ten to twelve flowering branches growing at varying heights were assessed for sex expression. Voucher specimens were collected with the information on tree number, species, sex expression and GPS coordinates. Subsequent observations were made during the flowering episodes of 2006 and 2007.

In order to study within season variation in sex expression, 55 individual trees were selected (generally ten trees per species of each sex type: male, female and hermaphrodite although only five hermaphrodite trees of *M. alba* were available in the study site). Ten branches from different heights and different directions were marked and assigned a branch number. These branches were observed for sex expression during early, peak and late flowering times. The flowering time was defined “early” when the buds had just started opening and the first flowering was observed. After about one to two weeks, most of the buds (90-100%) had opened,

and this time was defined “peak”, and when some staminate catkins started senescing and approximately 50% or more pistillate catkins were in young fruiting stage, the time was defined as “late” flowering. Thus, each tree was thoroughly observed thrice during the flowering time, with sex expression recorded.

## **Data analysis**

The breeding system was expressed as a cumulative ratio of the number of unisexual trees to the number of hermaphrodite trees across all populations. Sex ratio was expressed as a proportion (males/[males + females]; see Wilson and Hardy, 2002). Deviations of sex ratios from 1:1 were tested using  $\chi^2$  statistics. Inter-year variation in sex ratio was analyzed using GENMOD procedure of Statistical Analysis System 9.0 (SAS Institute Inc., Cary, NC, USA) with proportion of males as response variable. To compare proportion of males between the two species, generalized linear models were used with binomial distribution and the logit link function (Crawley 1993) in the GENMOD procedure of SAS. Variation of sex ratio within each species was analyzed across the populations and also compared between two species.  $\chi^2$  statistics were also used to test whether the proportion of males is the same between species, and whether it is same between populations of a species, with degree of freedom equal to the number of populations (or species) minus one. To determine whether there were differences in size between sexes, a GENMOD procedure of SAS with gamma distribution was used. Log link function was used with the DBH as a response variable. Parameter estimates were analyzed by maximum likelihood and p-values were calculated using  $\chi^2$  statistics with a degree of freedom equal to the number of categories minus one. Similar analyses were performed in SAS to analyze the relationship between distance and sex expression as hermaphroditism. The relationships between

DBH and NND were analyzed using REG procedure in ANOVA with DBH as the response variable.

Spatial association between the distributions of the two sexes was tested by bivariate second-order spatial pattern analysis based on Ripley's K- function (Ripley, 1976) implemented in the program R (R-Development Core Team, 2005). Ripley's K analysis uses distance between all possible pairs of plants in a population, and identifies the scales over which a non-random distribution occurs. The analysis produces an output score  $L(d)$  with a confidence envelopes for each distance analyzed. For *Morus* data, the confidence envelope was generated using 1000 Monte Carlo simulations and analyses were performed for both number of males around each female, and the number of females around each male. Only the results from the analysis of males around each female are presented here, because the analysis of females around each male produced similar results. Two sexes were inferred to be aggregated if the  $L(d)$  of the test statistics exceeded the confidence envelopes in a positive direction; inferred random if the test statistics lied within the envelopes; and inferred to be segregated if the test statistic exceeded the envelopes in the negative direction. All figures except for the analysis of Ripley's K-function were developed in SigmaPlot (Systat Software Ltd.). The figures from the analysis of Ripley's K-function were developed using the program R.

## RESULTS

### Breeding system

Out of 408 *M. rubra* trees studied across nine populations, 42 trees (10.3%) were hermaphrodite, and out of 261 *M. alba* trees across thirteen populations, 32 trees (12.3%) were hermaphrodite (Fig. 4. 2). There were 75 trees of *M. rubra* and 38 trees of *M. alba* in the Kings

Creek area of KPBS studied for inter-year sex ratio variation (2005, 2006 and 2007).

Approximately 10% of the individuals of each species changed their sexual status on an annual basis (Table 4.2), indicating the presence of subdioecy in *Morus*.

### **Sex ratio variation in *Morus***

The sex ratio for each species differed from 1:1 with the proportion of males greater than that of females ( $\chi^2_1 = 17.36$  for *M. alba*, and  $\chi^2_1 = 44.99$  for *M. rubra*, and  $p < 0.0001$  for each species; Figure 4.3). The cumulative sex ratio between the two species didn't differ significantly ( $\chi^2_1 = 1.26$ ,  $p = 0.2623$ ), but was more strongly male-biased in *M. rubra*.

**Inter-year variation in sex ratio.** Inter-year sex ratio variation was not significant within each species ( $\chi^2_2 = 1.71$ ,  $p = 0.4262$  for *M. alba*;  $\chi^2_2 = 0.06$ ,  $p = 0.9701$  for *M. rubra*; Table 4.1), however, the interspecific difference in sex ratio was significant ( $\chi^2_1 = 11.26$ ,  $p = 0.001$ ). The sex ratios were consistently male-biased for both species for all the three years.

**Sex ratio variation across populations.** The sex ratio didn't vary statistically from population to population ( $\chi^2_{12} = 7.70$ ,  $p = 0.86$  for *M. alba*;  $\chi^2_8 = 5.60$ ,  $p = 0.69$  for *M. rubra*). The sex ratio was male-biased for all populations for both species (Fig. 4.3). As shown in Figure 4.4, two *M. alba* populations such as at Kings Creek area of KPBS and Pottawatomie Lake No. 1 were significantly male-biased ( $\chi^2_1 = 4.80$ ,  $p < 0.05$  and  $\chi^2_1 = 6.03$ ,  $p < 0.05$ , respectively), and five *M. rubra* populations were significantly male-biased (Fig. 4.5): Fort Riley ( $\chi^2_1 = 4.69$ ,  $p < 0.05$ ), Kings Creek of KPBS ( $\chi^2_1 = 14.20$ ,  $p < 0.001$ ), Shane Creek area of KPBS ( $\chi^2_1 = 8.86$ ,  $p < 0.01$ ), Pottawatomie Lake No. 2 ( $\chi^2_1 = 7.69$ ,  $p < 0.05$ ), Slough Creek area of Perry Lake ( $\chi^2_1 = 6.54$ ,  $p < 0.05$ ). Other populations were also male-biased but this was not statistically significant ( $p > 0.05$ ). When compared between species, the sex ratio of *M. rubra* was consistently more strongly male-biased than that of *M. alba* (Fig. 4.4 and 4.5).

***Change in sexual status.*** Out of 75 *M. rubra* trees observed at KPBS for three years (2005, 2006 and 2007), 66 trees in 2006 and 68 trees in 2007 were consistent in their sexual status from the previous year. Among the nine trees (12%) that changed sexual status in 2006, one hermaphrodite tree changed to female, three females to hermaphrodites, one hermaphrodite tree to male, and the remaining five hermaphrodites without mixed catkins the previous year produced mixed catkins in addition (Table 4.2). In 2007, out of seven trees (9.3%) that changed sexual status, three hermaphrodites changed to females, two females to hermaphrodites, one male to hermaphrodite, and one hermaphrodite with mixed catkins the previous year produced no mixed catkins (in fact, tree number 62 switched back to its 2005 status). Of those trees that changed sexual status in 2007, three trees (tree numbers 62, 76 and 100) had also changed sexual status in 2006. Among 38 *M. alba* trees, 35 trees (92.1%) did not change their sexual status from year to year, and three trees (7.9%) changed sexual status in both 2006 and 2007. Out of the three trees that changed sexual status in 2006: one hermaphrodite changed to male, one hermaphrodite to female, and one female changed to hermaphrodite. Similarly in 2007, one male changed to hermaphrodite, one female to hermaphrodite, and one female changed to male. Of those three trees that changed sexual status in 2007, the same two trees (tree numbers 264 and 267) had also changed sexual status in 2006.

***Within season variation in sex expression.*** Sex expression was not observed to change in within males or females within the flowering period. Out of ten hermaphrodite *M. rubra* trees observed for within season variation, one tree (tree no. 77) produced male catkins throughout whole season. One tree (tree no. 85) had unisexual and mixed catkins, and the proportion didn't change throughout the flowering season. Three trees (tree no. 76, 88 and 99) had male catkins in some branches and female catkins in other branches. Five trees (tree no. 45, 46, 69, 86 and 97)

produced only unisexual catkins throughout. Generally these trees produced female catkins on basal branches, male catkins on the apical branches and no mixed catkins at all. The proportion of male catkins varied from 40 to 60% for different hermaphrodite trees. Out of five hermaphrodite *M. alba* trees observed for within season variation, one tree (tree no.264 which had produced male, female and mixed catkins in the previous year) produced only male catkins throughout. Similarly one tree (tree no. 267; which had produced male, female and mixed catkins in the previous year) produced only female catkins. Three trees (tree no. 42, 269 and 291) had slightly more mixed catkins than unisexual catkins developed in the late flowering season. The proportion of male catkins varied from 40 to 60% in *M. alba* as well.

***Size dependence of sex expression.*** The size distribution of male, female and hermaphrodite plants in both species is shown in Figures 4.6. No significant differences in size occurred between male, female and hermaphrodite individuals of each species ( $\chi^2_2 = 1.41$ ,  $p = 0.49$  for *M. alba*;  $\chi^2_2 = 3.12$ ,  $p = 0.21$  for *M. rubra*). Individuals of *M. alba* were statistically larger for males and females than those of *M. rubra* (Fig. 4.6). In *M. alba*, the sex ratio did not differ from 1:1 in the smaller size classes (DBH <20 cm), but differed significantly at higher size classes and were male-biased (Fig. 4.7). In *M. rubra*, the sex ratios differed from 1:1 in all size classes and were also male-biased (Fig.4. 8).

***Tree size and the nearest neighbor distance.*** Regression analysis of the size (DBH) and the nearest neighbor distance (NND) showed no association between the size of the tree and the nearest neighbor distance for both *M. alba* ( $r^2 = 0.0032$ ,  $p = 0.52$ ; Fig. 4.9) and *M. rubra* ( $r^2 = 0.0013$ ,  $p = 0.46$ ; Fig. 4.10).

***Sex expression and the nearest neighbor distance.*** There was a strong relationship between nearest neighbor distance and occurrence of hermaphroditism in both species. The



nearest neighbor distance for hermaphrodites was significantly higher than that for males and females ( $\chi^2_2 = 28.91$ ,  $p < 0.0001$  for *M. alba*;  $\chi^2_2 = 51.41$ ,  $p < 0.0001$  for *M. rubra*). The nearest neighbor distance did not differ between males and females within each species, nor between the two species (Fig. 4.11).

***Males and females aggregated, randomly distributed or segregated?*** Analysis using Ripley's *K* function showed evidence of aggregation of the sexes at some spatial scales for both species. Five of 13 populations of *M. alba* showed aggregation of males around female at varying scales (Fig.4.12: D, G, I, K, and T), and the remaining showed random distribution. Similarly, seven of nine populations of *M. rubra* showed aggregation at varying scales (Fig.4.12: A, C, H, L, N, P and S), random above those scales and no segregation of sexes. There was no detected evidence of spatial segregation of sexes (Fig.12: A-U). Similar results were obtained when data were analyzed for the number of females around each male.

## DISCUSSION

### Subdioecy in *Morus*

The present study documents complicated and intriguing patterns of sex expression in *M. alba* and *M. rubra*, previously considered monoecious or dioecious in floras (Berg, 2001; Whittmore, Flora of Missouri treatment in prep., pers. comm.), are subdioecious. The unisexual individuals were far more numerous compared to hermaphrodites (Fig. 4.1). While the majority of the trees consistently expressed the same sex from a given year to the next, and some (ca. 10%) in each population changed their sexual status year to year. These species are therefore not strictly dioecious but are subdioecious. There was no unidirectional change in sex expression (i.e., male and female both were changing to hermaphrodites and hermaphrodites were switching back to unisexuals; Table 4.2). Most of the changes were within the hermaphrodite individuals

themselves and fewer were changing from and to unisexual individuals. This could serve as a strategy in *Morus* species for adjusting the proportion of male and female functions and maintaining sex ratios within populations.

Subdioecy as a breeding system represents a transition in the hermaphroditism-dioecy continuum, and is considered an adaptive strategy for reproductive assurance by opportunistic selfing, benefiting sexual specialization and avoiding the effect of inbreeding (reviewed in Case et al., 2008). The evolution of dioecy from hermaphroditism is believed to take place through two common pathways: the first through the spread of a sterility mutation (e.g. through gynodioecy: spread of male-sterility; or through androdioecy: spread of female-sterility), and the second through a monoecy-parodioecy pathway, where individuals in the population evolve in such a way that one becomes increasingly male and the other becomes increasingly female by gradual divergence (reviewed in Delph and Wolf, 2005). Subdioecy in *Morus* might have evolved through a monoecy-parodioecy pathway, and further investigation is required to infer the mechanism in detail.

## **Plasticity of sex expression**

Both *M. alba* and *M. rubra* individuals exhibited changes in their sexual status. Such a reproductive strategy is not very common in woody perennials, although it is very common in herbaceous dioecious species (Korpelainen, 1998). Some examples of tree species with plasticity in sex expression include *Myristica insipida* (Armstrong, 1989), *Acer rubrum* (Sakai, 1990), *Hebe subalpina* (Delph and Llyod, 1991), *Clusia nemorosa* (Lopes and Machado, 1998), *Thymelaea hirsuta* (El-Keblawy and Freeman, 1999), *Dombeya delislei* (Humeau et al., 1999), *Dombeya ciliata* (Humeau et al., 2000), *Acer rufinerve* (Nanami et al., 2004) and *Bischofia javanica* (Yamashita and Abe, 2002). Effects of environmental factors were highlighted in all of

these studies except in the case of *A. rufinerve*, where deteriorating plant health resulted in a change from male to female, the potential strategy being to reproduce before the death of the individual. In a majority of cases males have been found to be inconstant (e.g., *Dombeya ciliata* [Humeau et al., 2000], *D. delislei* [Humeau et al., 1999] and *Clusia nemorosa* [Lopes and Machado, 1998]). In *Morus*, both males and females were inconstant from a given year to the next. These findings are similar to some findings on other species (e.g. *Thymelaea hirsuta* [El-Keblawy and Freeman, 1999], *Bischofia javanica* [Yamashita and Abe, 2002]), wherein both sexes can be inconstant. Fewer individuals of both sexes in *Morus* are inconstant while the majorities are unisexual, ensuring outcrossing and the maintenance of genetic variation within populations.

In some subdioecious species, studies have found that sex expression is determined by both genetics and by genotype by environment interactions. McArthur et al. (1994) found that, in the subdioecious species *Atriplex canescens*, sex of the majority of unisexual individuals was fixed as male or female, while sex varied in other individuals, ranging from unisexual individuals to hermaphrodites with various proportions of male and female flowers. Their treatment with irrigation, time, and irrigation x time interaction showed that sex expression in the hermaphrodites was a result of the combined effects of genotype and the environment. They concluded that the magnitude of sex change was a product of the interaction of genetics and environment. In dioecious *Rumex nivalis*, sex determination was found to be controlled largely by genetics, but sex ratios in the progeny were influenced by pollination intensity (i.e. the closer the males and females were, the stonger was the female biased sex ratio; Stehlik et al., 2008). Ehlers and Bataillon (2007) predicted that genotypes exhibiting labile sex expression may be selectively maintained in populations for two reasons: the presence of hermaphrodites at low

density in a population would save the population from extinction when pollen limitation is severe, and labile sex expression may also have important consequences for the distribution of the species among different habitat types. The importance of labile sex expression in relation to the abiotic environment has been addressed by several authors (reviewed in Delph and Wolf, 2005). In *Morus*, as the majority of the individuals are consistently unisexual and some are inconstant, there may be a similar situation to that of *Atriplex* (McArthur et al., 1994); i.e., sex expression must be controlled by both genetics and the environment. Further study on the effects of environmental factors on sex expression in this system is warranted.

### **Sex ratios, plant size and nearest neighbor distances**

In the present study, both species exhibited significant deviations in their sex ratios from unity. The populations were male-biased, and the results were consistent with results on other tree species (e.g. House, 1992; Thomas and LaFrankie, 1993; Nicotra, 1998). These studies have provided possible proximate causes of male-biased sex ratios as precocious male flowering, more frequent flowering of males than females (Thomas and LaFrankie, 1993; Nicotra, 1998), higher female mortality (Bierzychudek and Eckhart, 1988), etc. For most of the dioecious species for which sex ratios have been documented, the majority are consistently male-biased (reviewed in Delph, 1999). Species such as *Compsoneara spucei* (Bullock, 1982), *Myristica insipida* (Armstrong and Irvine, 1989), *Rhamnus alaternus* (Guitian, 1995) have stable sex ratio (i.e., 1:1), while some other species such as *Rumex acetosa* (Korpelainen, 1991), *Silene latifolia* (Delph and Meagher, 1995) and *Salix cinerea* (Alliende and Harper, 1989) have female-biased sex ratios. *Acer nugundo* showed male-biased sex ratios in drier habitats and female-biased sex ratios in mesic habitat (Jing and Coley, 1990). Unlike in *Morus*, Yamashita and Abe (2004) showed significant inter-year variation in sex ratios in *Bischofia javanica* because of the large

number of individuals were switching their sex. The observed inter-year variation in *Morus* is very minimal (which is not statistically significant), and is due to sexual plasticity. Within season variation was also very minimal in *Morus*: only some hermaphrodite *Morus* trees produced more mixed catkins in the late flowering season. Similar findings were documented by Sakai and Weller (1991) for *Schiedea globosa*.

Size dependent sex expression has been documented in several dioecious species. For example, in *Bischofia javanica* (Yamasita and Abe, 2004), the smallest trees were males, medium sized trees were inconstant and the largest trees were females. There was no size dependence of sex expression in the studied species of *Morus*. The smaller trees were males, females and hermaphrodites, as were the larger ones. In *M. alba*, however, the frequency of males at the higher size class was higher than those at the smaller size classes (Fig. 4.6). If male and female individuals differ in reproductive costs, allocation will be greater in the sex with higher reproductive costs, resulting into size difference in the sexes (Lloyd and Bawa, 1984). Absence of inter-sex difference in size in *Morus* indicates that male and female individuals do not differ in the reproductive costs suggesting the cost of pollen production in males is comparable relative to the production of female flowers and fruits. The present results were similar to those for *Schiedea globosa* (Sakai and Weller, 1991). In order to gain insights into reproductive allocation for *Morus*, further studies—including identifying the resources that drive expression of one sex versus the other—are needed. Stehlik et al. (2008) demonstrated that the proximity of male and females affected the sex ratios in *Rumex nivalis*: the closer the males and females, the stronger were the female biased sex ratios. In *Morus*, tree size and the nearest neighbor distance are not associated (Fig. 4.9). The *Morus* trees are mostly understory trees with patchy a distribution, and they may be experiencing pollen limitation rather than pollen excess

(see Ashman et al, 2004). Male biased sex ratios in these species may therefore ensure sexual reproduction and reduce the cost of reproduction caused through wind pollination and their unpredictable heterogenous environment

### **Aggregation of the sexes**

We found no strict spatial segregation of the sexes (SSS) in *Morus* in all populations under this study. We excluded hermaphrodite individuals during the analysis because of their small sample size. In species that do have SSS such as *Acer negundo* (Freeman et al. 1997), and *Juniperus virginiana* (Lawton and Cothran, 2000), females often dominate resource rich habitat, and the males are common in the resource poor habitats (Lloyd and Webb, 1977). Since *Morus* species are sparsely distributed understory trees and pollen movement from tree to tree is essential for reproductive success, the individuals of the same species are not competing for some limiting resources, and the species is less likely to undergo selection for SSS that would further reduce the offspring output. This may be the reason why individuals are aggregated to some spatial scale. One other reason might be that the understory light environments for *Morus* are highly variable during the day and at different height and direction of the plant. It is also important to consider the random dispersal of seeds by birds and growth of *Morus* trees in the areas away from the main populations. The findings are similar to those for *Silene grandiflora*, an understory tree that did not exhibit SSS (Bawa and Oppler, 1977). Some studies have suggested several factors related to spatial distribution that affect the reproduction of dioecious species such as distance between males and females (Mack, 1997), flowering frequency (Bawa, 1980), effective population size (Nunney, 1995), pollinator abundance and their flight behavior (Stacy et al., 1996) etc. Some strategies of plants such as woody perennial habit (Baker and Cox 1984), production of fleshy fruits (Bawa, 1980), production of multi-seeded fruits and dispersal

by birds (Baker and Cox 1984), leaky dioecy, and parthenocarpy (Venkatasamy et al., 2007) for reproductive assurance have been suggested. The two species of *Morus*, which are subdioecious, are woody perennials, parthenocarpic (Barbour, 1973), and produce multi-seeded fleshy fruits that are dispersed by birds—all potential strategies for reproductive assurance.

### **Reproductive strategies for the *Morus* native-invasive pair**

Both species are very similar in various aspects of reproductive biology despite the fact that they are not closely related within the genus (see Chapter 3). Sex expression patterns have not been reported for other members of the genus. Both *M. alba* and *M. rubra* species are subdioecious, with the ratio of unisexual individuals to hermaphrodites being approximately 8:1. Approximately 10% of the trees of both species changed their sexual status annually (Table 4.2), and cumulative sex ratios for both species differed from 1:1. The sex ratio was male-biased in both species and inter-year sex ratio variation was not significant. The percentage of male and female catkins in hermaphrodites varied from 40 to 60% in both species. No size dependence of sex expression was detected in the two species. The NND and DBH were not associated, but the NND and the expression of hermaphrodites were associated. This association between the nearest neighbor distance and hermaphroditism in *Morus* at least based on the current sample size suggests that remotely growing trees experiencing pollen limitation may express hermaphroditism to ensure sexual reproduction. This finding is new, and needs to be tested in the future with larger sample sizes across multiple populations. The nearest neighbor distance did not differ between sexes within each species nor between species (Fig. 4.11). Analysis using Ripley's *K* showed evidence of aggregation of the sexes at some spatial scales <400 m for both species and randomly distributed at a greater distance, and no evidence of spatial segregation of

sexes. It is surprising that such a great similarity exists between these two non-sister species (see Chapter 3).

The two species differ obviously in morphology, and the potential hybrid individuals were assigned to one or other species based on similarities. *M. rubra* had a more strongly male-biased sex ratio than *M. alba*. There were more hermaphrodites with mixed catkins in *M. alba* than in *M. rubra*. There were fewer *M. alba* individuals in co-occurring populations, and *M. rubra* was completely absent in four populations included in this study. No *M. rubra* tree was found in the forested areas around Milford Lake (the Farnum Creek and Timber Creek areas), the Linear Park (West of Manhattan), and Pottawatomie Lake No.1. All four wooded areas represent secondary forests, and other nine populations represent the primary forests. Although all the individuals growing in each population were included in this study, the confidence intervals of the sex ratio of *M. alba* for some populations (Fig. 4.4) are wider because of smaller sample sizes. The males and females of *M. alba* were larger than those of *M. rubra* (Fig.4 6). The size class distribution for *M. alba* was skewed towards a larger size, while *M. rubra* had a normal distribution (Fig. 4.7).

Overall, both species of *Morus* (which are non-dominant understory trees with patchy distribution in the Flint Hills region of the Central Plains) displayed interesting sex expression patterns, reflected various strategies adapted to wind pollination and exhibited plasticity of sex expression potentially enabling the species to deal with heterogeneous and stressful environmental conditions. Females of the invasive species are more abundant and larger compared to those of the native, consistent with the findings of Burgess et al. (2008), which showed that *M. alba* had much greater pollen production better fruit quality. Thus, the invasive species has many advantages in sexual reproduction relative to the native species.



## ACKNOWLEDGEMENTS

This section of my dissertation was supported by the graduate student research grant from the American Society of Plant Taxonomists (ASPT), the Kansas State University Herbarium (KSC), Division of Biology, Konza Prairie LTER program and the Kansas Agricultural Experimental Station.

I thank John Barbur from Fort Riley's Conservation and Restoration Branch for locating *Morus* trees and helping me with data collection from the “Three Miles Creek” area of Fort Riley Military Reservation, and Bill Makeley, Marge Makeley and John Hund from Alma who helped me locate a field site and who assisted in the field. I will always remember our scooter driving through the dense woody thickets in search of mulberry trees in Alma. I thank Dr. Valerie Wright, Jim Larkin, Jim Rivers, Chris Hein and Tom Van Slyke for field assistance on Konza. I also thank the Kansas Forest Service staff for providing information about mulberry trees in Kansas.

My sincere thanks go to Dr. Leigh Murray from the department of Statistics, who helped me run various statistical analyses in SAS. I thank Shivakumar Mohandass, Juan Campos and Ron VanNimwegen for discussing issues with ArcGIS and the program R. I like to thank Bob Lehew for technical support, particularly in recovering some data files from my old computer that crashed a midway through my work. Thanks to Drs. Ferguson, Mayfield, Ungerer, Fehlberg, and Susan Rolfsmeir and Ying Zhen for discussion during lab meetings.

## LITERATURE CITED

- AINSWORTH, C. 2000. Boys and girls come out to play: the molecular biology of dioecious plants. *Annals of Botany* 86: 211-221.
- ARMSTRONG, J. 1997. Pollination by deceit in nutmeg (*Myristica insipida*, Myristicaceae): floral displays and beetle activity at male and female trees. *American Journal of Botany* 84: 1266-1274.
- ARMSTRONG, J. AND A. IRVINE. 1989. Flowering, sex ratios, pollen-ovule ratios, fruit set, and reproductive effort of a dioecious tree, *Myristica insipida* (Myristicaceae), in two different rain forest communities. *American Journal of Botany* 76: 74-85
- ASHMAN, T. L., T. M. KNIGHT, J. A. STEETS, P. AMARASEKARE, M. BURD ET AL. 2004. Pollen limitation of plant reproduction: ecological and evolutionary causes and consequences. *Ecology* 85: 2408-2421.
- BAKER, H. G AND P. A. COX. 1984. Further thoughts on dioecism and islands. *Annals of the Missouri Botanical Garden* 71: 244-253.
- BARBOUR, J. R., R. A. READ, AND R. L. BARNES. 1973. Development of seeded and parthenocarpic fruits in mulberry (*Morus rubra* L.). *Journal of Horticultural Science* 48: 83-97.
- BARKER, P., D. C FREEMAN AND K. T. HARPER. 1982. Variation in the breeding system of *Acer grandidentatum*. *Forest Science* 28: 563-572.

- BARRETT, S. C. H., R. I. COLAUTTI AND C. G. ECKERT. 2008. Reproductive systems and evolution during biological invasion. *Molecular Ecology* 17: 373-383.
- BARRETT, S. C. H. 2000. Microevolutionary influences of global change on plant invasions. Pp 115-139 in Mooney, H. A. and R. K. Hobbs (eds). The impact of global change on invasive species. Island Press, Covelo, California, USA.
- BAWA, K. S. AND J. H. BEACH. 1981. Evolution in Sexual systems in flowering plants. *Annals of the Missouri Botanical Garden* 68: 254-274.
- BAWA, K. S. AND P. A. OPLER. 1975. Dioecism in tropical forest trees. *Evolution* 29: 167-179.
- BAWA, K. S., D. R. PERRY AND J. H. BEACH. 1985. Reproductive biology of tropical lowland rain forest trees. Sexual systems and incompatibility mechanisms. *American Journal of Botany* 72: 331-345.
- BAWA, K. S. 1974. Breeding systems of tree species of a lowland tropical community. *Evolution* 28: 85-92.
- BAWA, K. S. 1980. Evolution of dioecy in flowering plants. *Annual Review of Ecology and Systematics* 11: 15-39.
- BERG, C. C. 2001. Moreae, Artocarpeae, and *Dorstenia* (Moraceae) with introductions to the family and *Ficus* and with additions and corrections to Flora Neotropica Monograph 7. New York Botanical Garden Press, New York, USA.

- BIERZYCHUDEK, P. AND V. ECKHART. 1988. Spatial segregation of the sexes of dioecious plants. *American Naturalist* 132: 34-43.
- BULLOCK, S. 1982. Population structure and reproduction in the neotropical dioecious tree *Compsonaura sprucei*. *Oecologia* 55: 238-242.
- BURGESS, K. S., M. MORGAN AND B. C. HUSBAND. 2008. Interspecific seed discounting and the fertility cost of hybridization in an endangered species. *New Phytologist* 177: 276-284.
- CASE, A. L., S. W. GRAHAM, T. D. MACFARLANE, AND S. C. H. BARRETT. 2008. A phylogenetic study of evolutionary transitions in sexual systems in Australasian *Wurmbea* (Colchicaceae). *International journal of plant sciences* 169: 141-156.
- CHARLESWORTH, D. 2006. Evolution of plant breeding systems. *Current Biology* 16: R726-R735.
- CHARLESWORTH, D. 1999. Theories of the evolution of dioecy. In: Geber, M. A, T. E. Dawson and L. E Delph (eds). *Gender and sexual dimorphism in flowering plants*. Springer, New York, USA.
- CHARLESWORTH, B., AND D. CHARLESWORTH. 1978. A model for the evolution of dioecy and gynodioecy. *American Naturalist* 112: 975-997.
- CHARNOV, E. L. 1982. *The theory of sex allocation*. Princeton University Press, Princeton, New Jersey, USA.

- COSTICH, D. E. 1995. Gender specialization across a climatic gradient: experimental comparison of monoecious and dioecious *Ecballium*. *Ecology* 76: 1036-1050.
- DARWIN, C. R. 1877. The different forms of flower on plants of the same species. John Murray, London.
- CRAWLEY, M. J. 1993. GLIM for ecologists. Blackwell Scientific Publishing. Oxford, U.K.
- DELLAPORTE, S. L. AND A. CALDERON-URREA. 1993. Sex determination in flowering plants. *Plant Cell* 5: 1241-1251.
- DELPH, L. F. 1999. Sexual dimorphism in life history. Pp149-173 in Geber, M.A., T. E. Dawson and L. F. Delph (eds). Gender and sexual dimorphism in flowering plants. Berlin: Springer-Verlag,
- DELPH, L. F. AND D. E. WOLF. 2005. Evolutionary consequences of gender plasticity in genetically dimorphic breeding systems. *New Phytologist* 166: 119-128.
- EHLERS, B. K., AND T. BATAILLON. 2007. 'Inconstant males' and the maintenance of labile sex expression in subdioecious plants. *New Phytologist* 174: 194-211.
- EL-KEBLAWY, A. AND C. D. FREEMAN. 1999. Spatial segregation by gender of the subdioecious shrub *Thymelaea hirsuta* in the Egyptian desert. *International Journal of Plant Science* 160: 341-350.
- FISHER, R. A. 1930. The genetical theory of natural selection. Clarendon Press, Oxford, UK.

- FREEMAN, D. C., J. L. DOUST, A. EL-KEBLAWY, K. J. MIGLIA AND E. D. MCARTHUR. 1997. Sexual specialization and inbreeding avoidance in the evolution of dioecy. *Botanical Review* 63: 65-92.
- FREEMAN, D. C., K. T. HARPER AND E. L. CHARNOV. 1980. Sex change in plants: Old and new observations and new hypotheses. *Oecologia* 47: 222-232.
- FRIEDMAN, J. AND S. C. H. BARRETT. 2008. A phylogenetic analysis of the evolution of wind pollination in the Angiosperms. *International Journal of Plant Sciences* 169: 49-58.
- GLEASON, H. A. 1952. The new Britton and Brown illustrated flora of the northeastern United States and adjacent Canada. Volume 3. Hafner Press New York, NY, USA.
- GUITIAN, J. 1995. Sex ratio, reproductive investment and flowering phenology in dioecious *Rhamnus alaternus* (Rhamnaceae). *Nordic Journal of Botany* 15: 139-1995.
- HUMEAU, L., T. PAILLER AND J. D., THOMPSON. 2000. Variation in gender and flower-size dimorphism in the dioecious tree *Dombeya ciliata*, an endemic to La Reunion Island. *Biotropica* 32: 463-472.
- HUMEAU, L., T. PAILLER AND J. D., THOMPSON. 1999. Cryptic dioecy and leaky dioecy in endemic species of *Dombeya* (Sterculiaceae) on La Reunion *American Journal of Botany* 1999 86: 1437-1447.
- HOFFMAN, R. AND K. KEARNS. 1997. Wisconsin manual of control recommendations for ecologically invasive plants. Wisconsin Dept. Natural Resources. Madison, Wisconsin. 102 p.

- HOUSE, S. 1992. Population density and fruit set in three dioecious tree species in Australian tropical rain forest. *Journal of Ecology* 80: 57-69.
- ISABEL, C., A. MACHADO, V. LOPES, AND M. SAZIMA. 2006. Plant sexual systems and a review of the breeding system studies in the Caatinga, a Brazilian tropical dry forest. *Annals of Botany* 97: 277-287.
- KLINKENBORG, V. 2007. "Splendor of the grass: the prairie's grip is unbroken in the Flint Hills of Kansas". *National Geographic* April 2007.
- KORPELAINEN, H. 1998. Labile sex expression in plants. *Biological Reviews* 73: 157-180.
- LAWTON, R.O. AND P. COTHRAN. 2000. Factors influencing reproductive activity of *Juniperus virginiana* in the Tennessee Valley. *Journal of the Torrey Botanical Society* 127: 271-279.
- LLOYD, D. G. 1980. The distribution of gender in four angiosperm species illustrating two evolutionary pathways to dioecy. *Evolution* 34: 123-134.
- LLOYD, D. G. 1979. Parental strategies of angiosperms. *New Zealand Journal of Botany* 17: 595-606.
- LLOYD, D. G AND K. S. BAWA. 1984. Modification of the gender of seed plants in varying conditions. *Evolutionary Biology* 17: 255-3381.
- LLOYD, D. G. AND C. J. WEBB. 1977. Secondary sex characters in seed plants. *Botanical Review* 43: 177-216.

- LOPES, A. V. AND I. C. MACHADO. 1998. Floral biology and reproductive ecology of *Clusia nemorosa* (Clusiaceae) in north-eastern Brazil. *Plant Systematics and Evolution* 213: 71-90.
- MACK, A. L., 1997. Spatial distribution, fruit production, and seed removal of a rare, dioecious canopy tree species (*Aglaia affflavida*) in Papua New Guinea. *Journal of Tropical Ecology* 13: 305-316.
- M<sub>C</sub>ARTHUR, E. C., D. C. FREEMAN, L.S. LUCKINBILL, S. C. SANDERSON AND G. L. NOLLER. 1993. Are trioecy and sexual lability in *Atriplex canescens* genetically based: evidence from clonal studies. *Evolution* 46:1708-1721.
- MORELLATO, L. 2004. Phenology, sex ratio, and spatial distribution among dioecious species of *Trichilia* (Meliaceae). *Plant Biology* 6: 491-497.
- MURAKAMI, N. AND M. MAKI. 1992. Sex allocation ratio in a wind-pollinated self-incompatible tree, *Alnus firma* Sieb. et Zucc. (Betulaceae). *Plant Species Biology* 7: 97-101.
- NANAMI, S., H. KAWAGUCHI AND T. YAMAKURA. 2004. Sex change towards female in dying *Acer rufinerve* trees. *Annals of Botany* 93: 733-740.
- NICOTRA, A. 1998. Sex ratio variation and spatial distribution of *Siparuna grandiflora*, a tropical dioecious shrub. *Oecologia* 115: 102-113.
- NUNNEY, L. 1995. Measuring the ratio of effective population size to adult numbers using genetic and ecological data. *Evolution* 49: 389-392.



- QUEENBOROUGH, S. A, D. F. R. P. BURSLEM, N. C. GARWOOD AND R. VALENCIA.  
2007. Determinants of biased sex ratios and inter-sex costs of reproduction in dioecious tropical forest trees. *American Journal of Botany* 94: 67-78.
- R-DEVELOPMENT CORE TEAM. 2005. R: a language and environment for statistical computing. R Foundation for Statistical Computing, Vienna, Austria.
- RENNER, S. S., AND R. E. RICKLEFS. 1995. Dioecy and its correlates in the flowering plants. *American Journal of Botany* 82: 596-606.
- RICHARDS, A. J. 2003. Apomixis in flowering plants: an overview. *Philosophical Transactions of the Royal Society of London B. Biological Science* 358: 1085-1093.
- RICHARDS, A. J. 1997. Plant breeding systems, 2nd ed. Chapman and Hall, New York, New York, USA.
- ROSS, M. D. 1982. Five evolutionary pathways to subdioecy. *American Naturalist*. 119: 297-318.
- SAKAI, A. K. 1990. Sexual reproduction of red maple (*Acer rubrum*) in northern lower Michigan. *American Midland Naturalist*. 123: 309-318.
- SAKAI A. K. AND S. G. WELLER. 1991. Ecological aspects of sex expression in subdioecious *Schiedea globosa* (Caryophyllaceae). *American Journal of Botany* 78: 1280-1288.
- SAKAI, A. K., AND S.G. WELLER. 1999. Gender and sexual dimorphism in flowering plants: a review of terminology, biogeographic patterns, ecological correlates, and phylogenetic

- approaches. Pp. 1-31 in M. A. Geber, T. E. Dawson, and L. F. Delph, (eds.). Gender and sexual dimorphism in flowering plants. Springer, Berlin.
- SMITH, C. C. 1981. Facultative adjustment of sex ratio in lodgepole pine. *American Naturalist* 118: 297-305.
- SOLOMON, B. P. 1989. Size-dependent sex ratios in the monoecious wind-pollinated annual, *Xanthium strumarium*. *American Midland Naturalist* 121: 209-218.
- STACY, E. A., J. L. HAMRICK, J. D. NASON, S. P. HUBBELL, R. B. FOSTER, AND R. CONDIT. 1996. Pollen dispersal in low-density populations of three Neotropical tree species. *American Naturalist* 148: 275-298.
- STAPANIAN, M. A. 1982. A model for fruiting display: seed dispersal by birds for mulberry trees. *Ecology* 63: 1432-1443
- THOMSON, J. D., AND S. C. H. BARRETT. 1981. Selection for out-crossing, sexual selection and the evolution of dioecy in plants. *American Naturalist* 118: 443-449.
- THOMAS, S. AND J. LAFRANKIE. 1993. Sex, size, and interyear variation in flowering among dioecious trees of the Malayan rain forest. *Ecology* 74: 1529-1537.
- UVA, R.H., J. C. NEAL AND J. M. DITOMASO. 1997. Weeds of the Northeast. Cornell University Press. Ithaca, New York.
- VENKATASAMY, S., G. KHITTOO AND S. KEELEY. 2007. Leaky dioecy in *Diospyros* (Ebenaceae) endemic to the Island of Mauritius. *Plant Ecology* 189: 139-146.

- VITOUSEK, P. M., L. R. WALKER, L. D. WHITEAKER, D. MUELLERDOMBOIS AND P. A. MATSON. 1987. Biological invasion by *Myrica fava* alters ecosystem development in Hawaii. *Science* 238: 802-804.
- WEBB, C. J. 1999. Empirical studies: evolution and maintenance of dimorphic breeding systems. Pp. 61-95 in M. A. Geber, T. E. Dawson and L. F. Delph (eds.) *Gender and sexual dimorphism in flowering plants*. Springer, Berlin.
- WEBER, E. 2003. *Invasive plant species of the world: a reference guide to environmental weeds*. CAB International.
- WHEELWRIGHT, N. AND B. LOGAN. 2004. Previous-year reproduction reduces photosynthetic capacity and slows lifetime growth in females of a neotropical tree. *Proceedings of the National Academy of Sciences (USA)* 101: 8051-8055.
- WILSON K. AND I. HARDY. 2002. Statistical analysis of sex ratios: an introduction. Pp. 48-92 in I. Hardy [ed.] *Sex ratios: concepts and research methods*, Cambridge University Press, Cambridge, UK.
- WUNDERLIN, R. P. 1997. Moraceae. P. 616 in *Flora of North America North of Mexico* (eds. Flora of North America Editorial Committee). Volume 3. Oxford University Press, New York, USA.
- YAMASHITA, N. AND T. ABE. 2002. Size distribution, growth and inter-year variation in sex expression of *Bischofia javanica*, an invasive tree. *Annals of Botany* 90: 599-605.

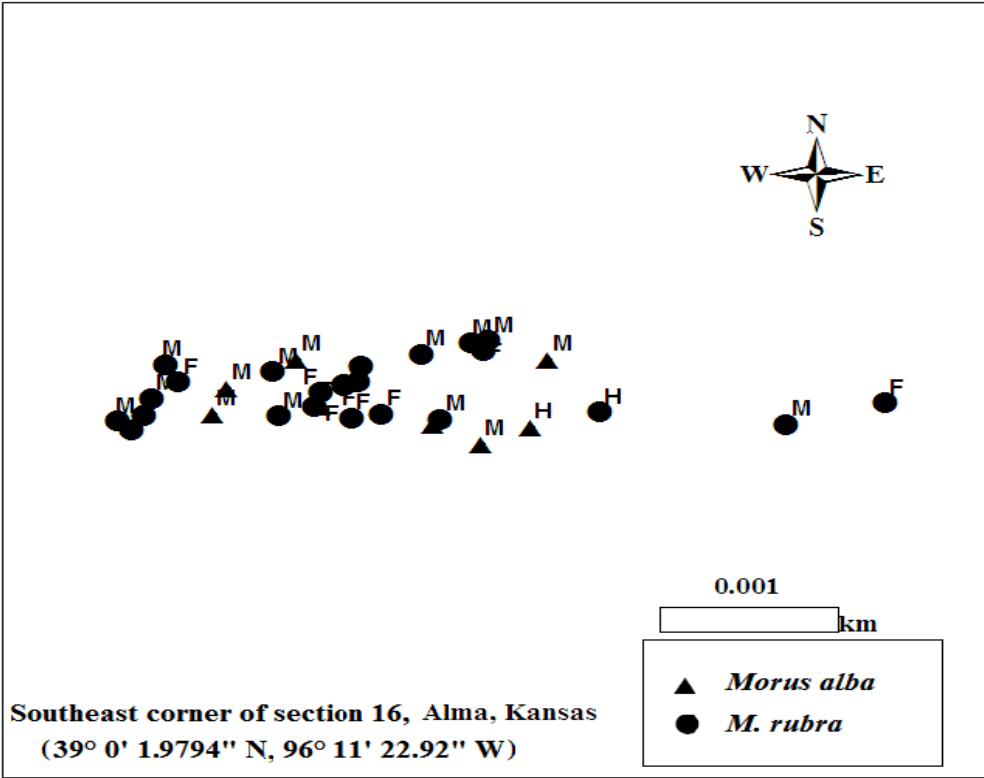

Figure 4.1 Mapped *Morus alba* (▲) and *M. rubra* (●) trees in different populations of Flint Hills region of Kansas (M = male, F = female and H = hermaphrodite).

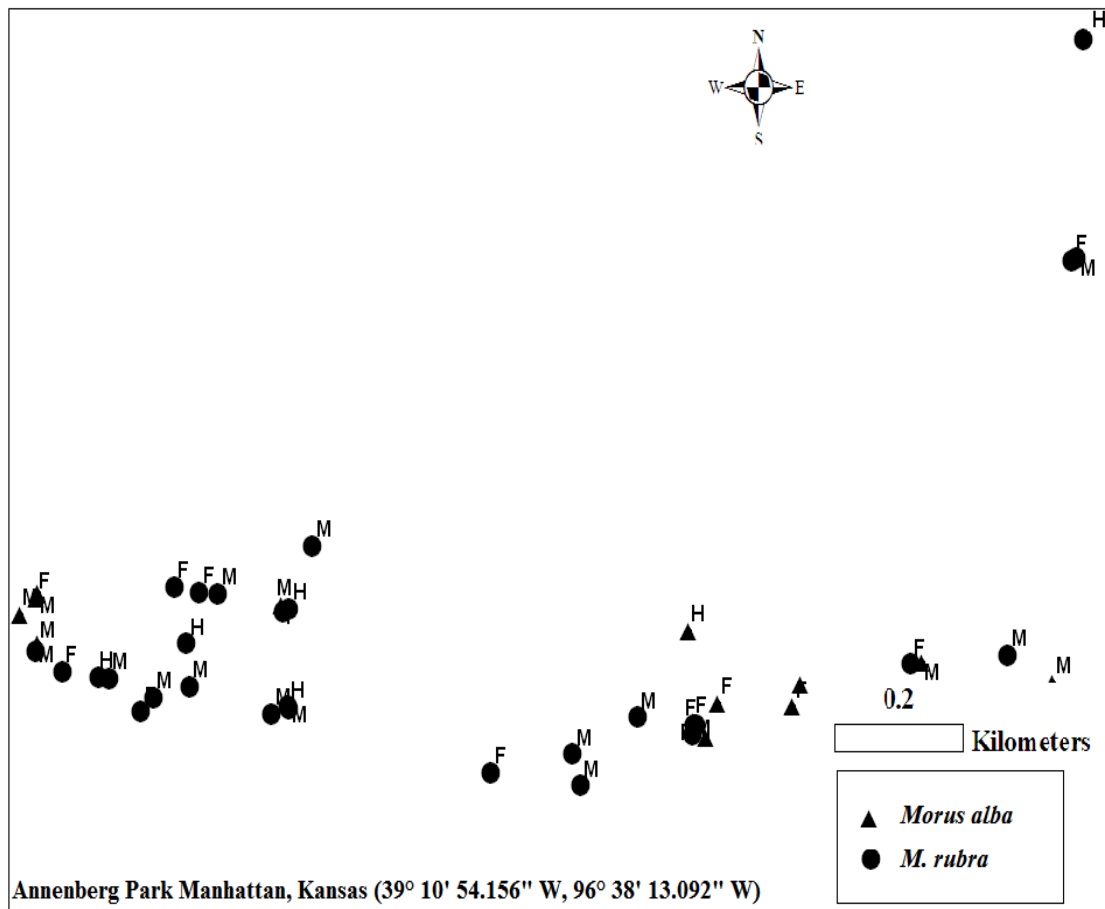

Figure 4.1 Continued.

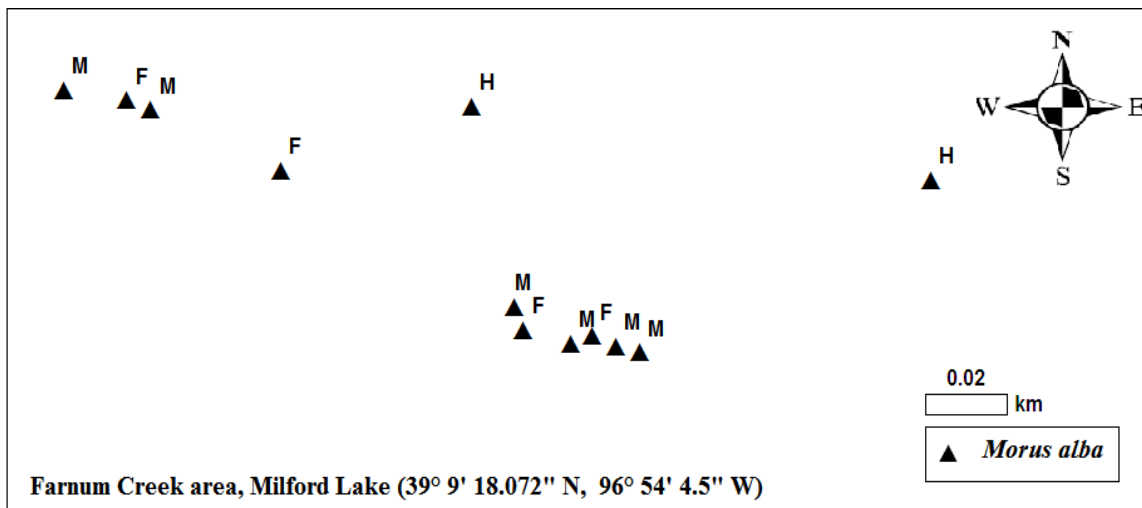

Figure 4.1 Continued.

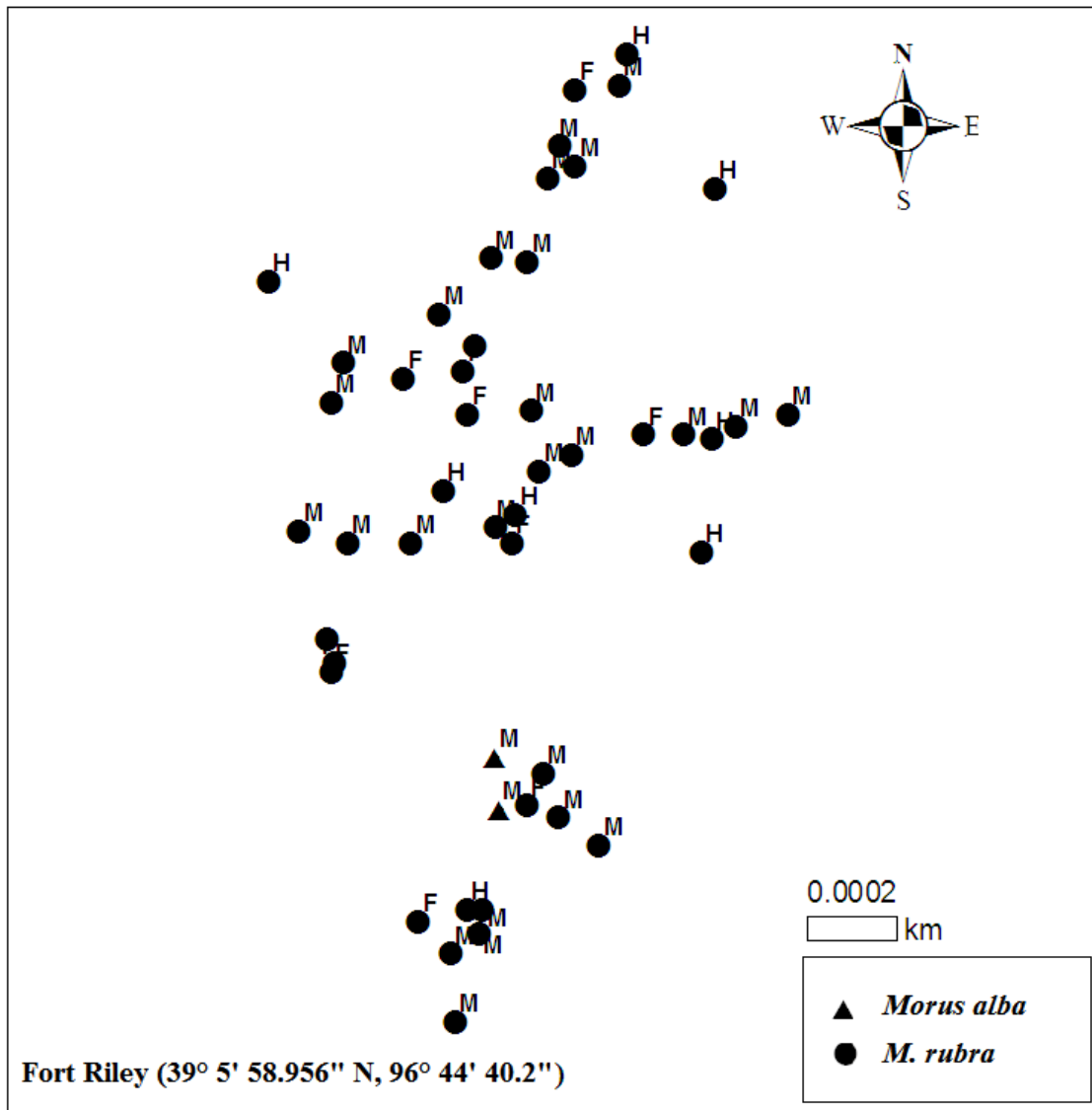

Figure 4.1 Continued.

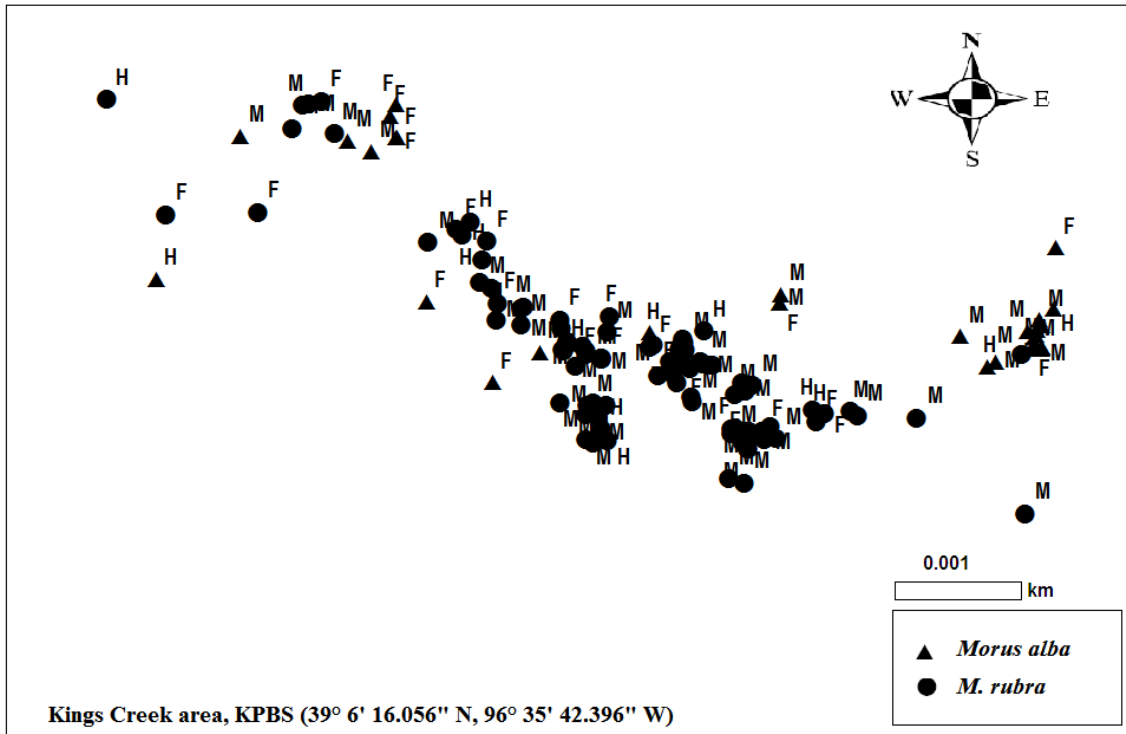

Figure 4.1 Continued.





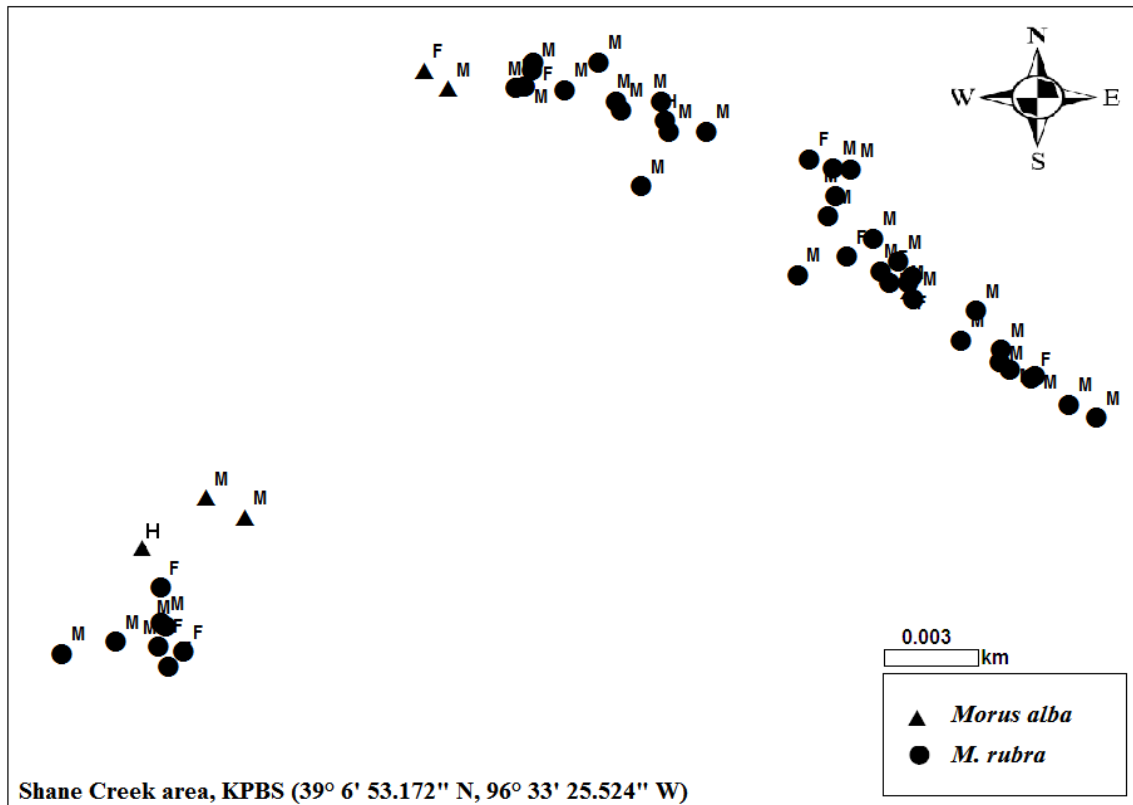

Figure 4.1 Continued.

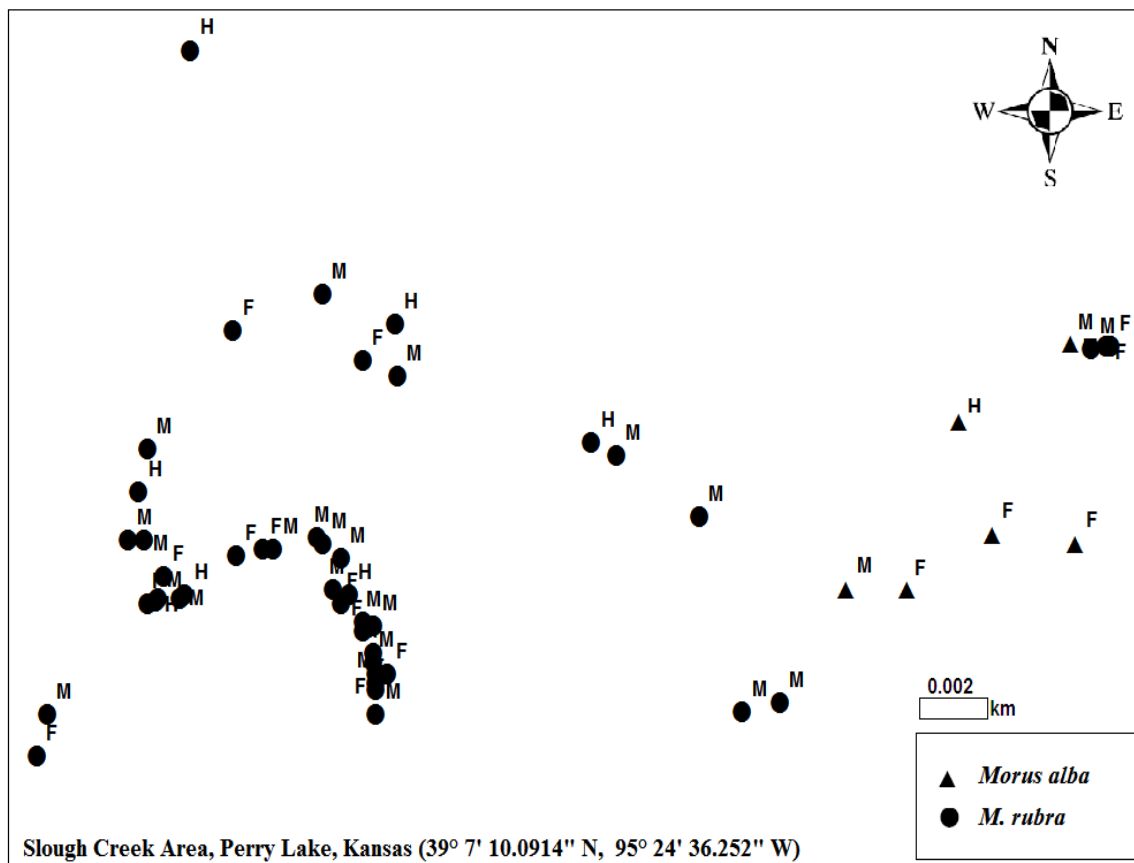

Figure 4.1 Continued.

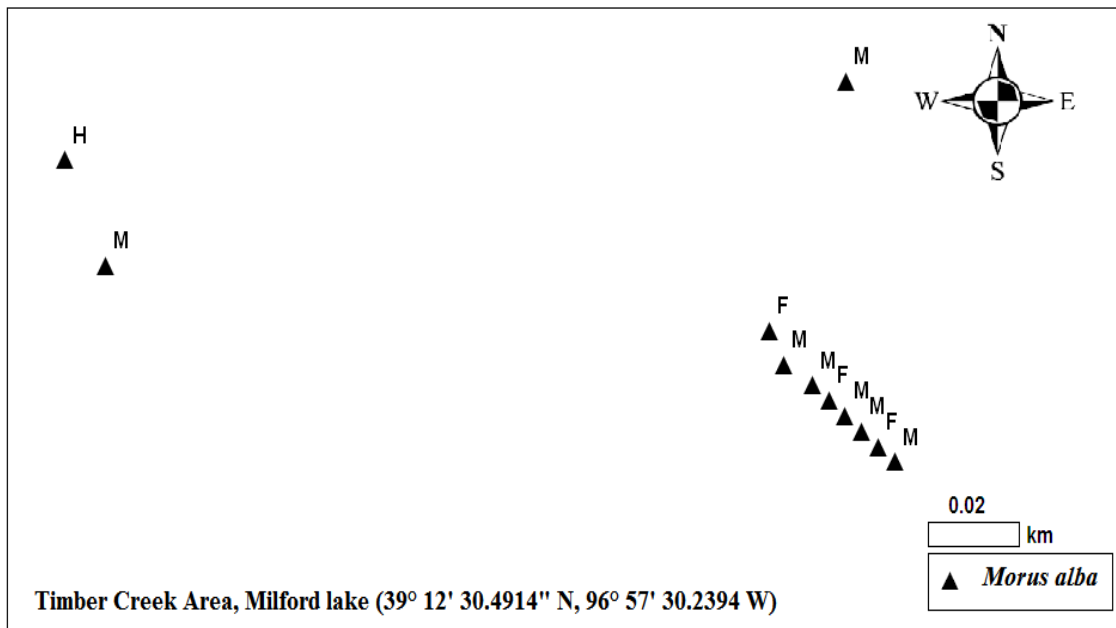

Figure 4.1 Continued.

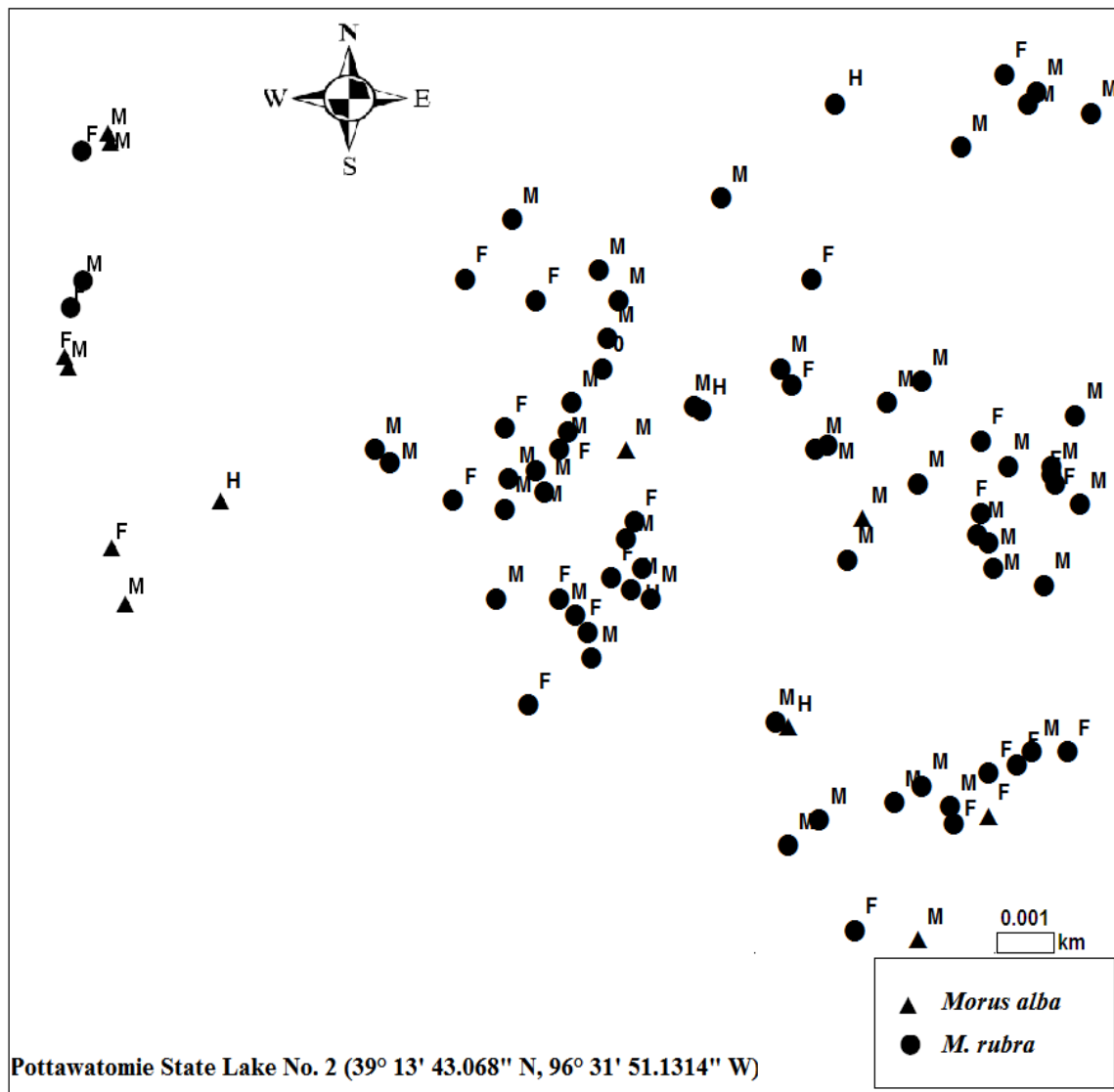

Figure 4.1 Continued.

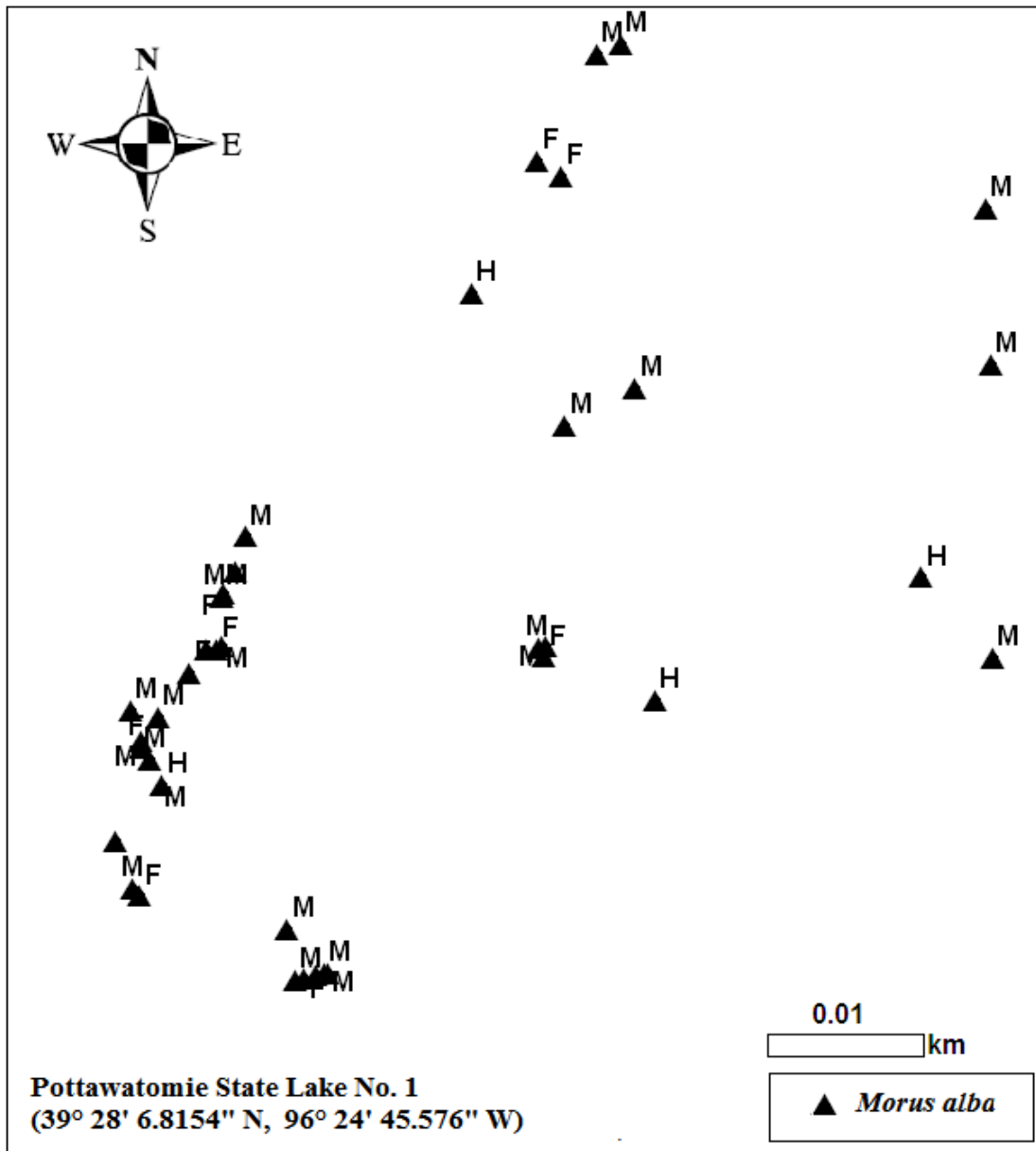

Figure 4.1 Continued.

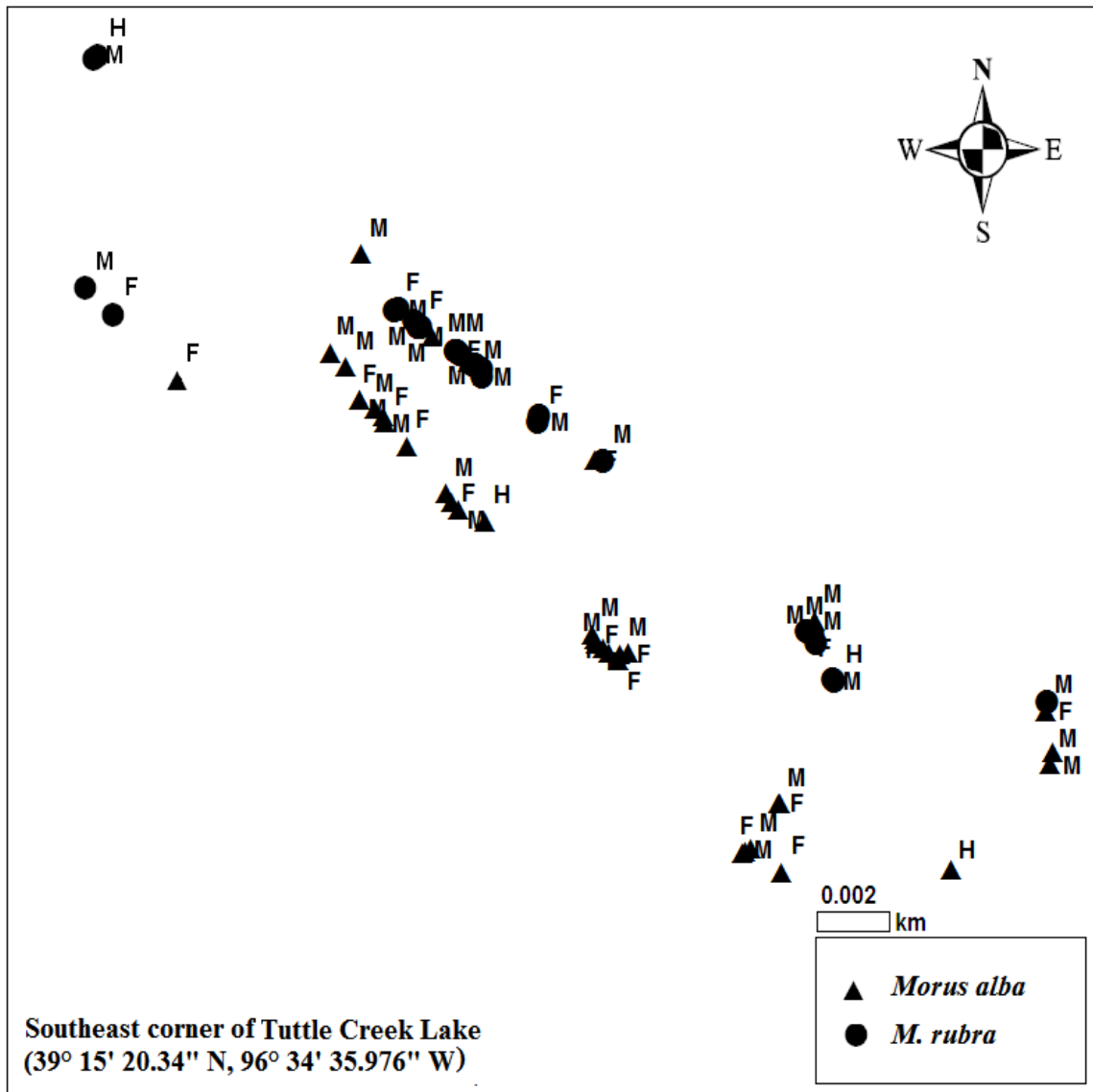

Figure 4.1 Continued.

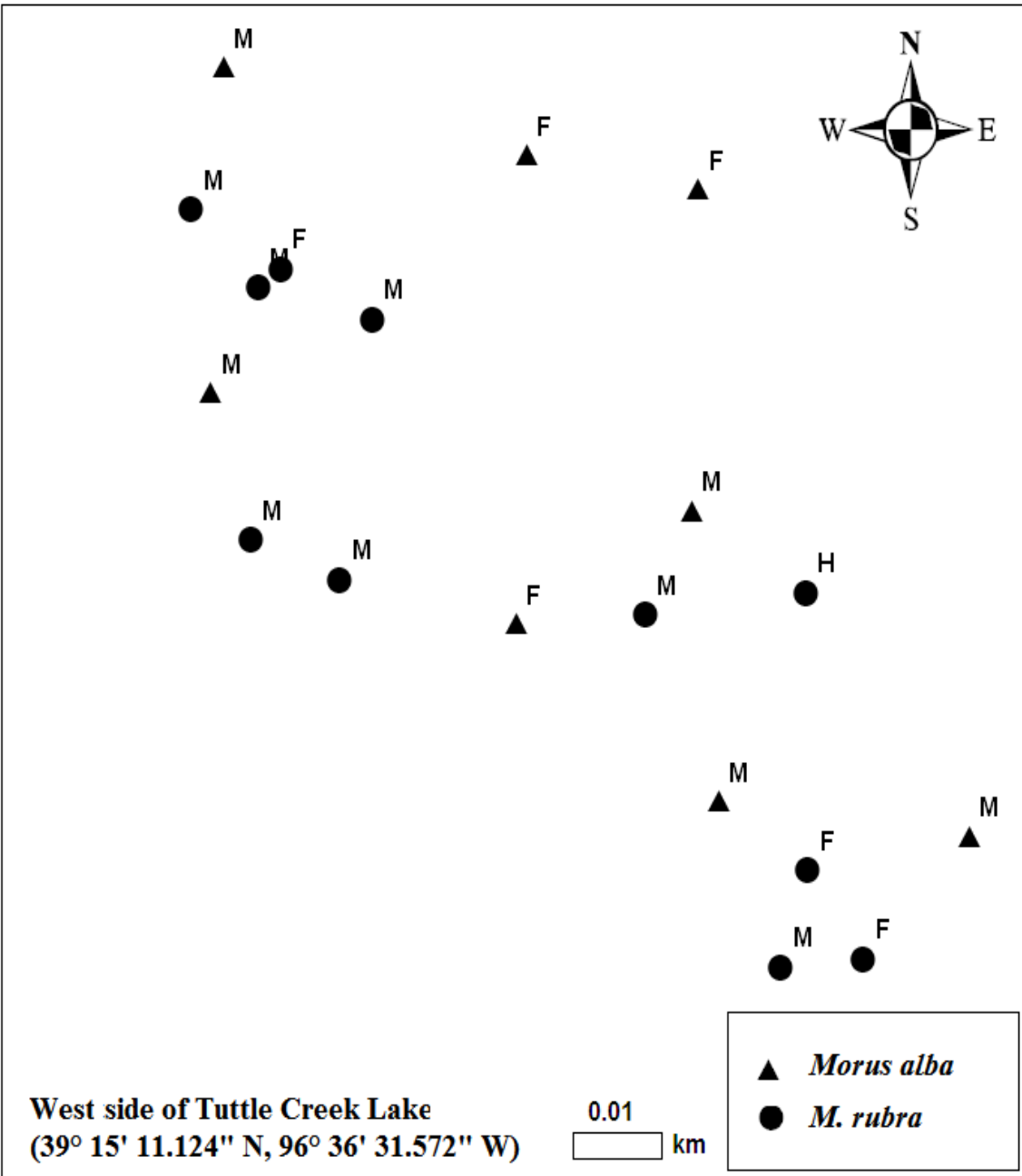
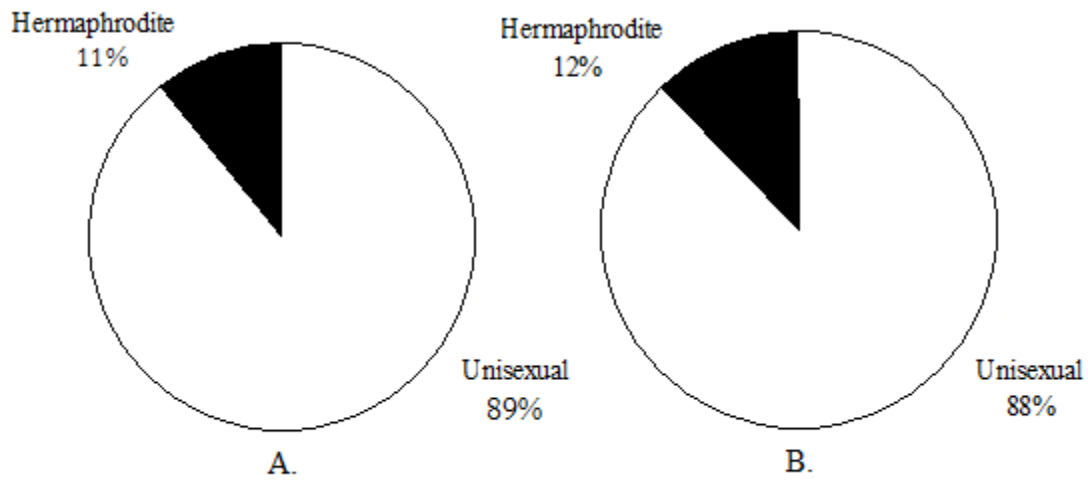
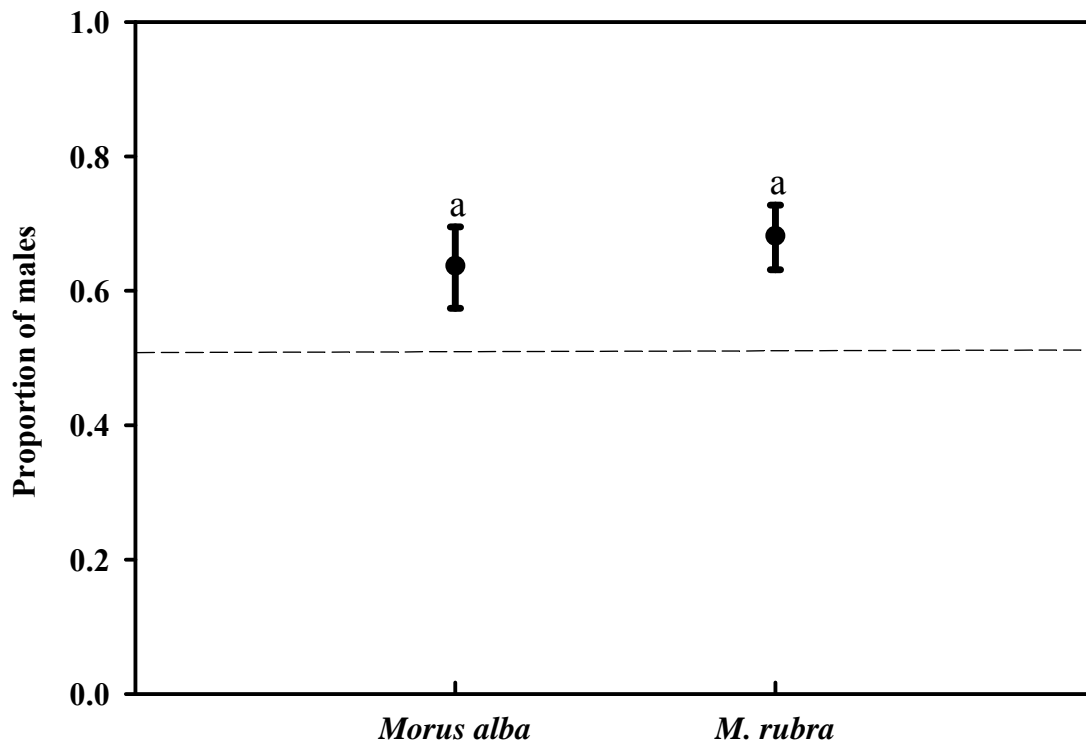

Figure 4.1 continued.





**Figure 4.2** Percentage of hermaphrodite and unisexual *Morus* trees in populations studied the Flint Hills region of Kansas. A = *M. alba*, and B= *M. rubra*.



**Figure 4.3** Sex ratio deviation in *Morus* in the Flint Hills region of Kansas. 95% confidence intervals are indicated. The line at 0.5 on Y-axis represents a 1:1 ratio of male to female.

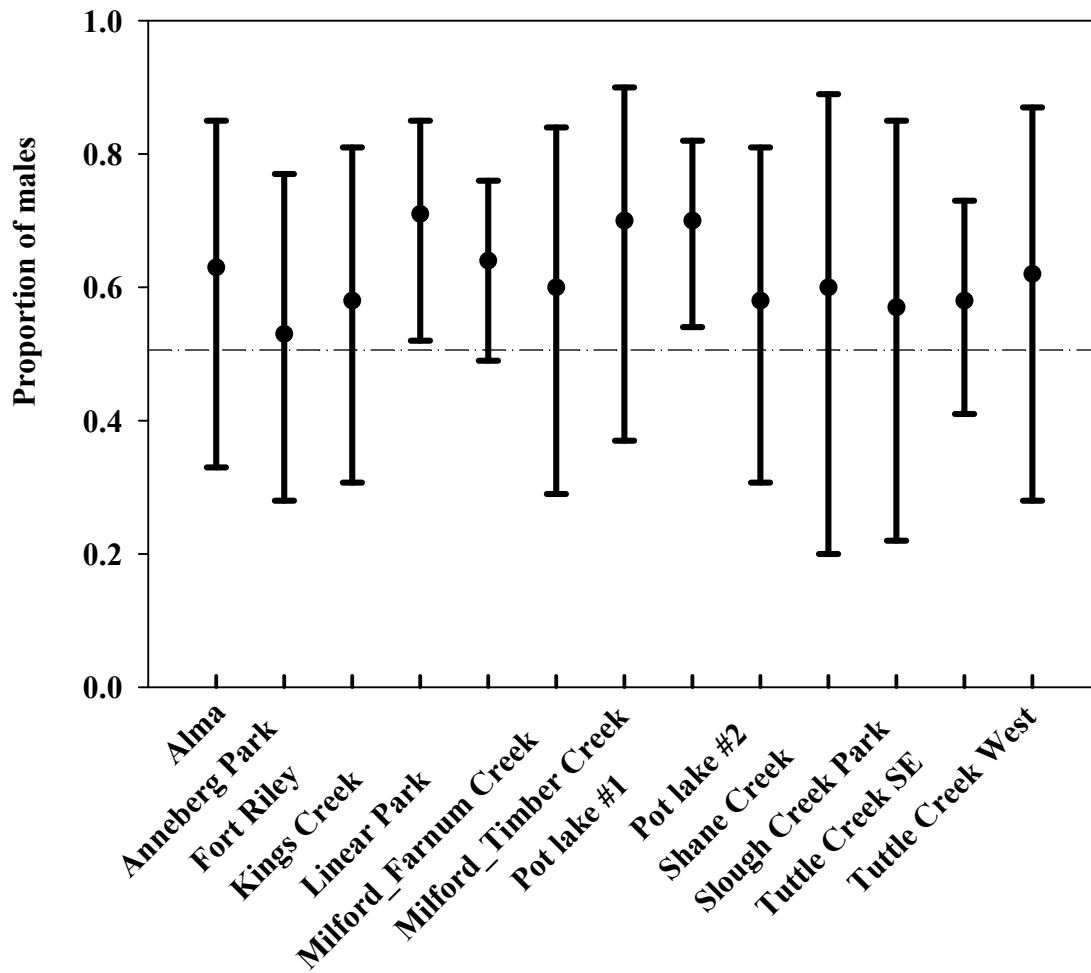

Figure 4.4 Sex ratio variation with 95% confidence intervals across 13 populations of *Morus alba* in the Flint Hills region of Kansas.

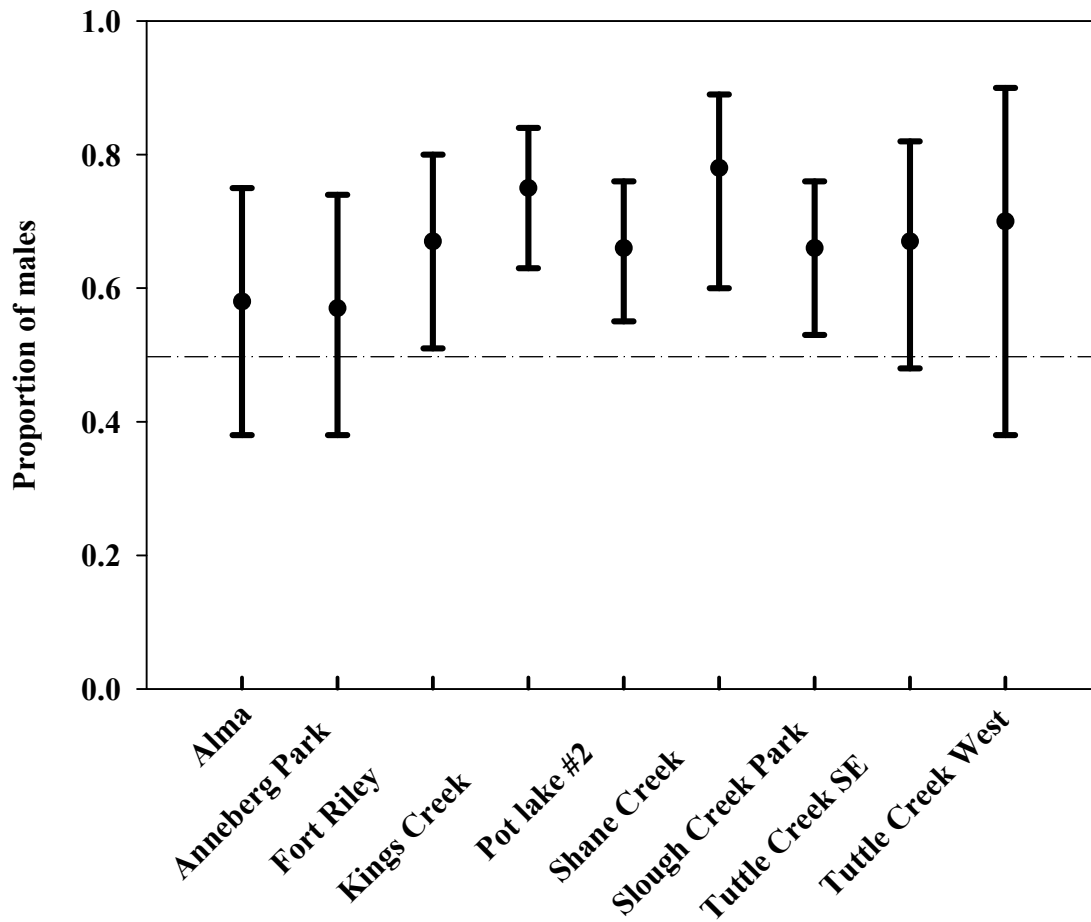

Figure 4.5 Sex ratio variation with 95% confidence intervals across nine populations of *Morus rubra* in the Flint Hills region of Kansas.

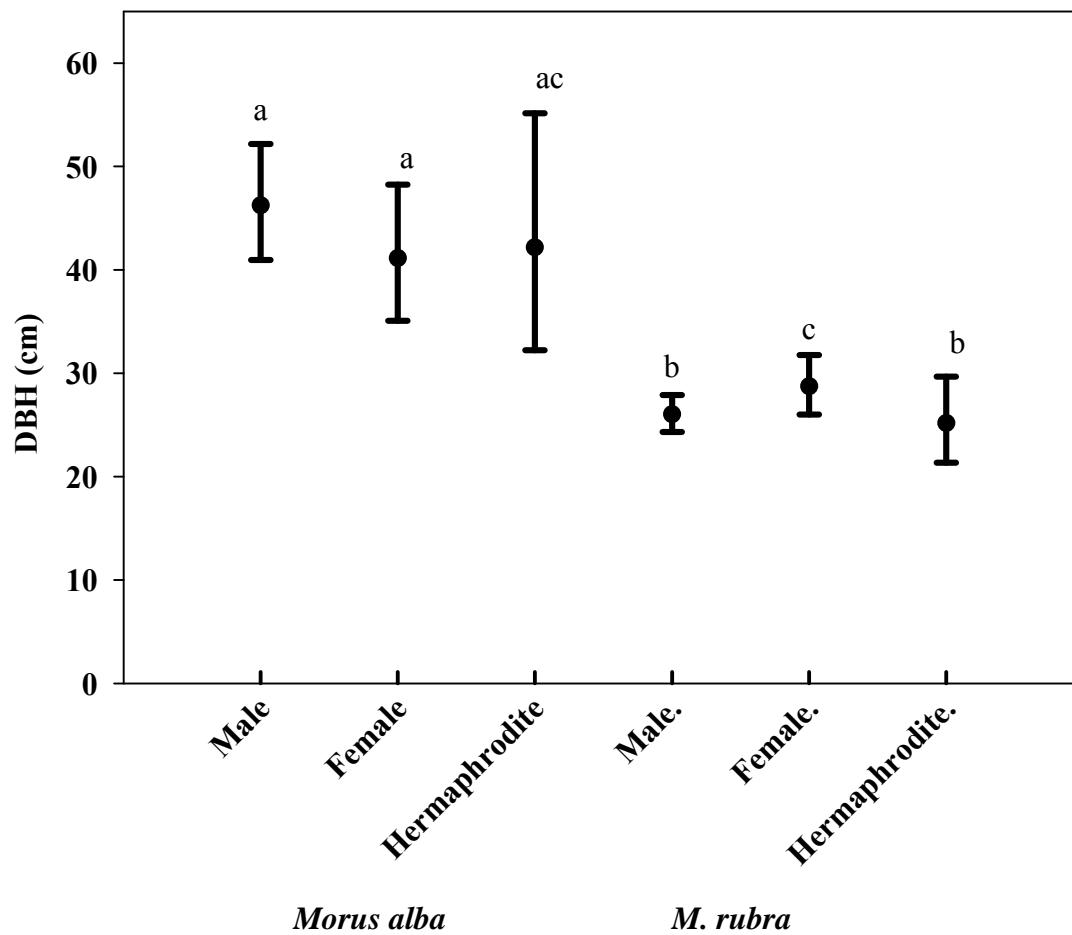

Figure 4.6 Size dependence of sexes in *Morus* in the Flint Hills region of Kansas. The symbols represent mean DBH with 95% confidence intervals.

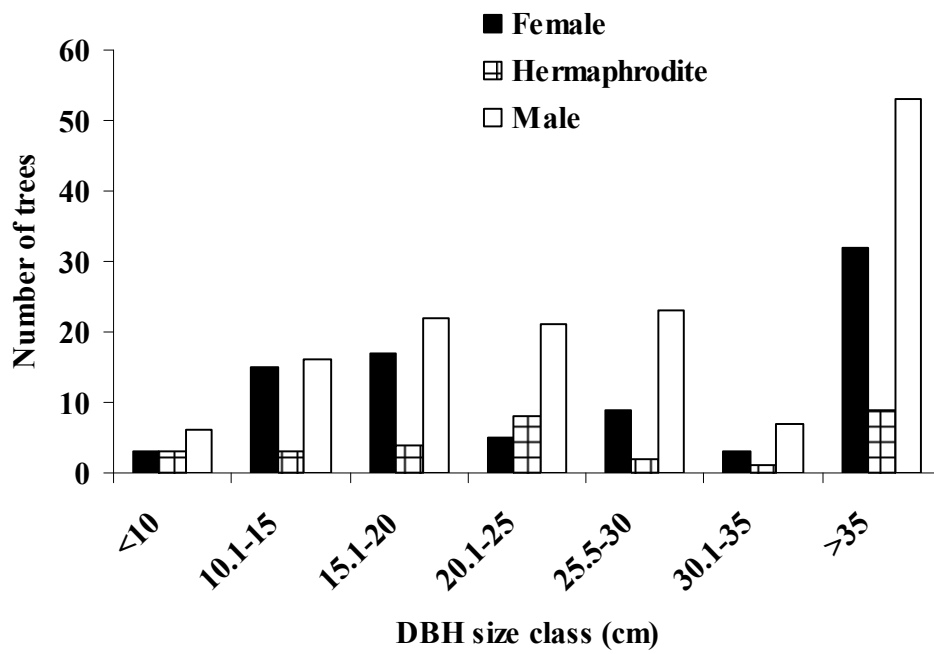

Figure 4.7 Size (DBH) class distribution in *M. alba*.

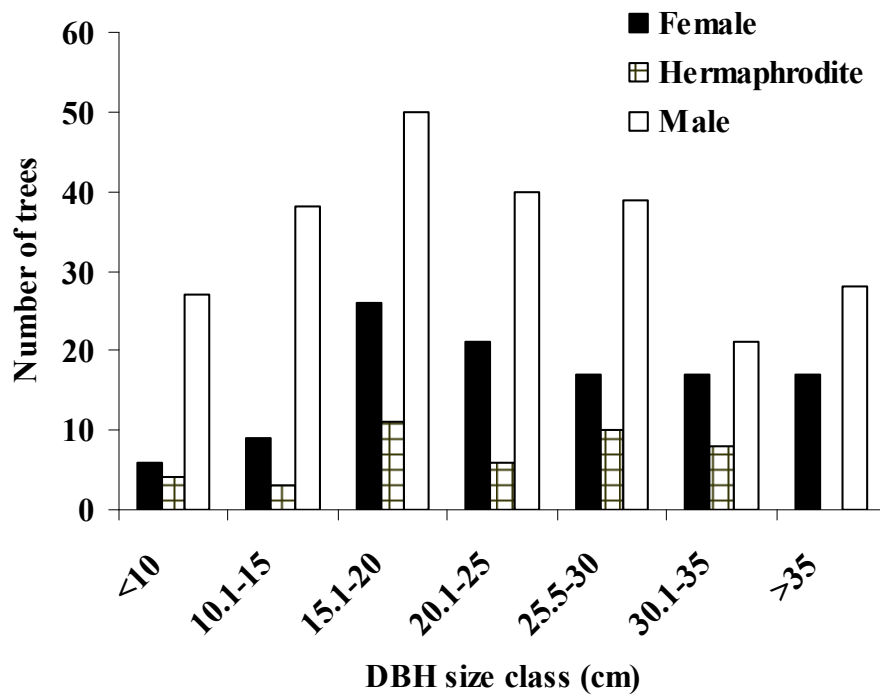

Figure 4.8 Size (DBH) class distribution in *M. rubra*.

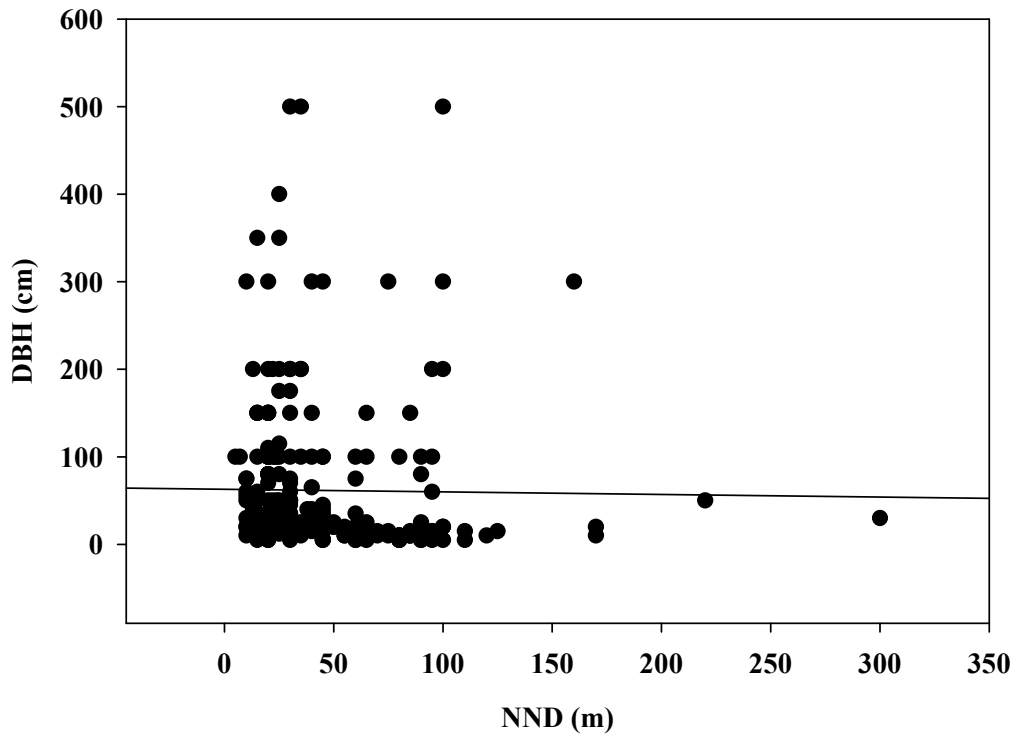

Figure 4.9 Relationship between nearest neighbor distance and size (DBH) in *Morus alba*.



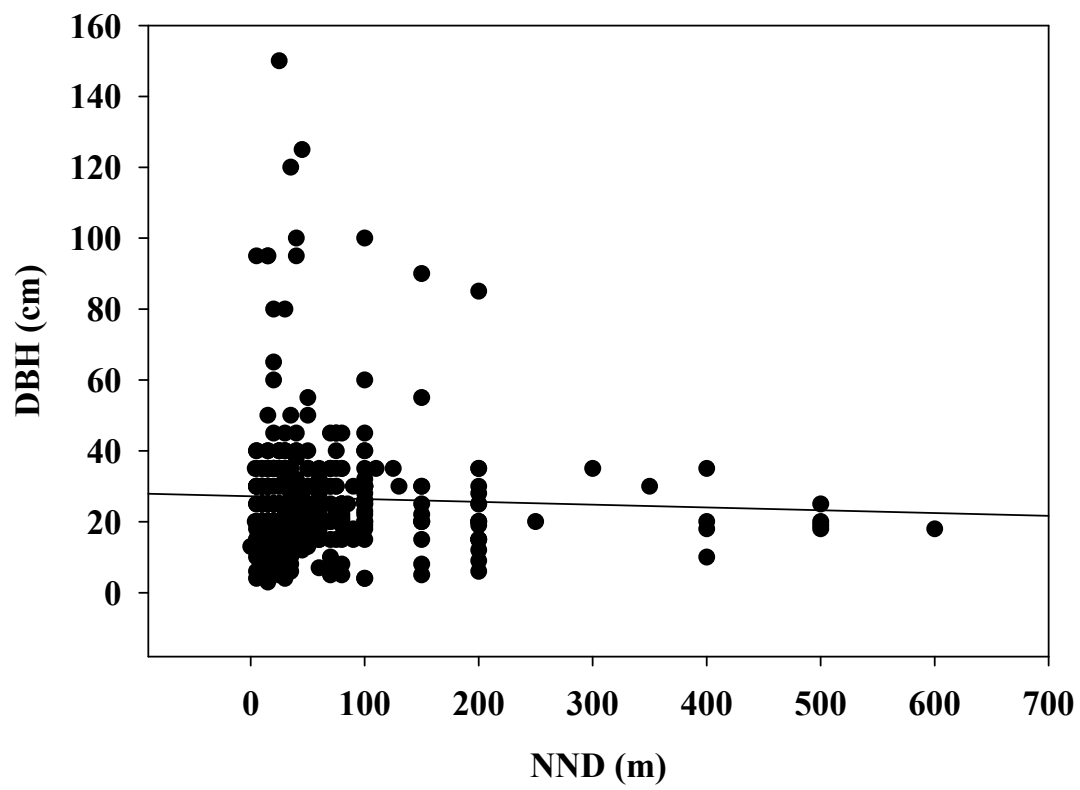

Figure 4.10 Relationship between nearest neighbor distance and size (DBH) in *Morus rubra*.

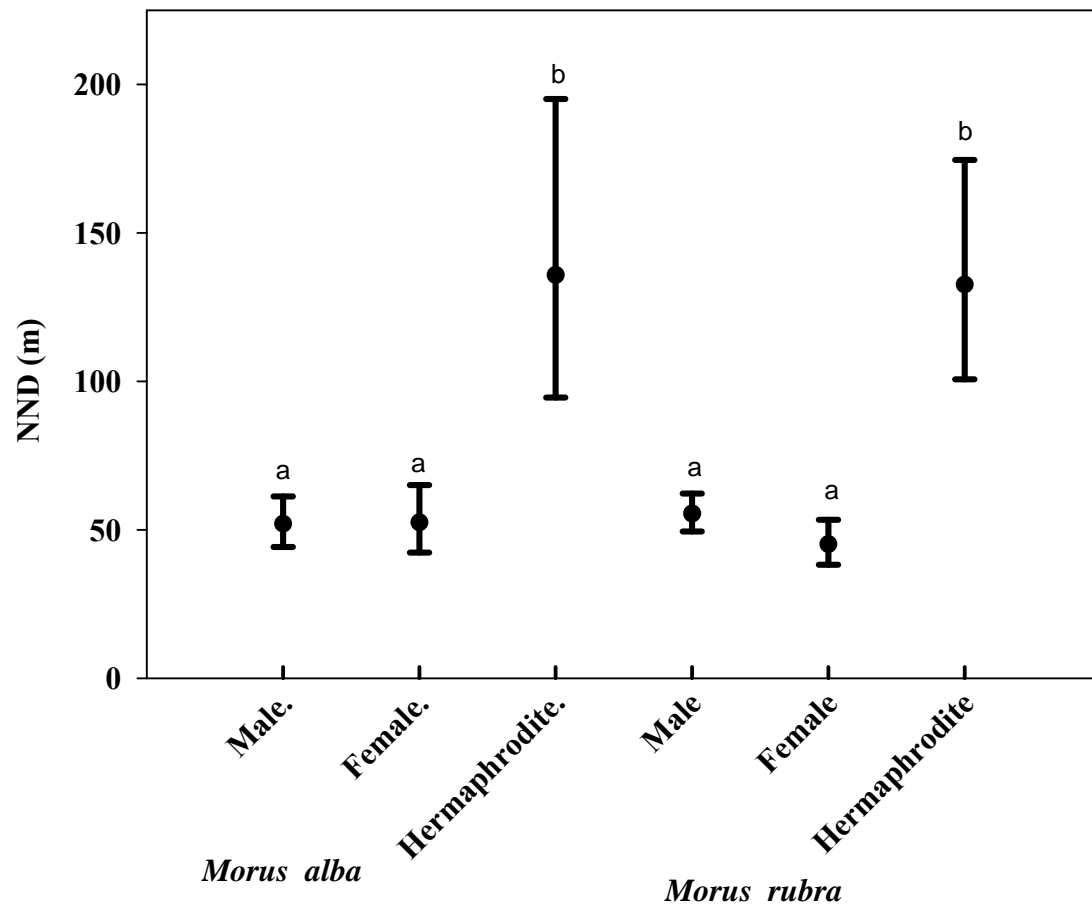
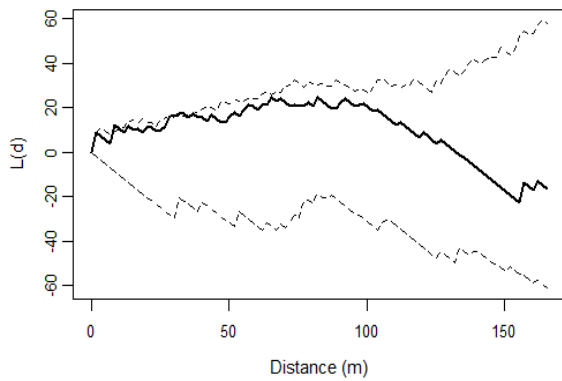
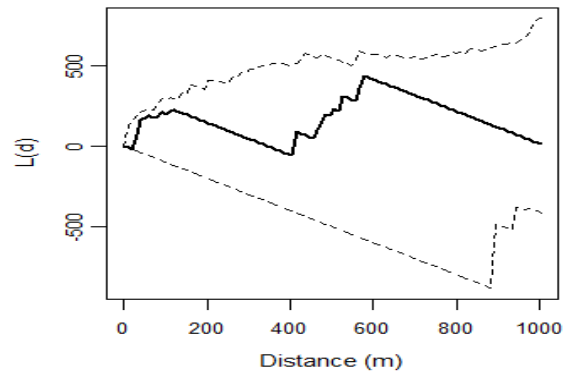

Figure 4.11 Relationships between the nearest neighbor distance (NND) and sex types in *Morus*. The symbols denote mean with 95% confidence intervals.



**A. *M. rubra* at Alma (section 16; aggregation at 35 m)**



**B. *M. alba* at Alma (random)**

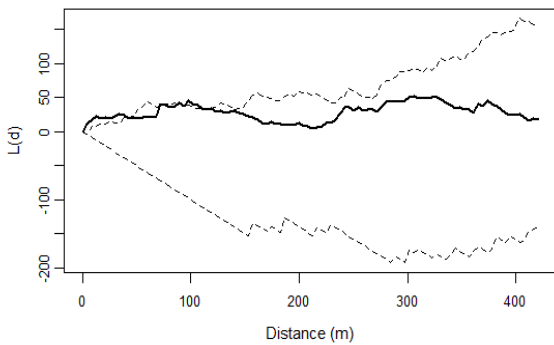

**C. *M. rubra* at Annenberg park (aggregation <100 m)**

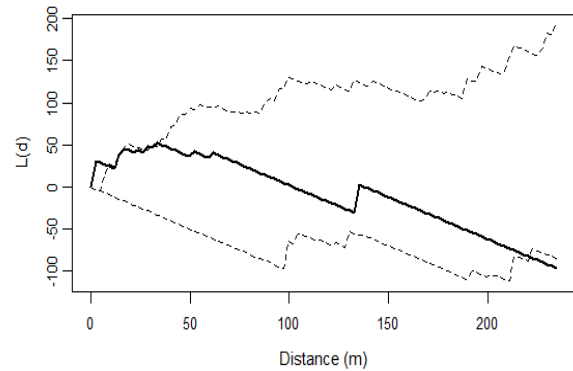

**D. *M. alba* at Annenberg Park (aggregation <15 m)**

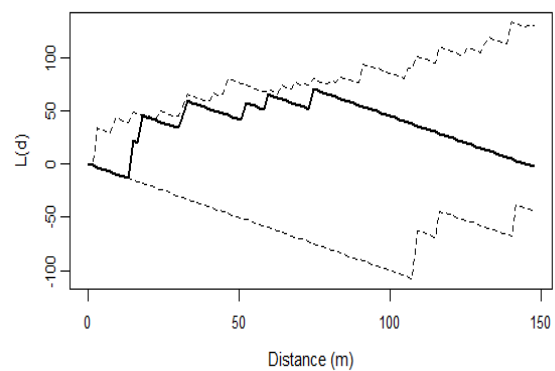

**E. *M. alba* at Farnum Creek Area, Milford Lake (random)**

**Figure 4.12** The spatial distribution of male and female trees of *Morus alba* and *M. rubra* using a bivariate Ripley's K spatial analysis. Distance is on the x-axis, and L (d) on the Y-axis. Solid lines show the test statistic L(d); dashed lines show 99% confidence envelopes.

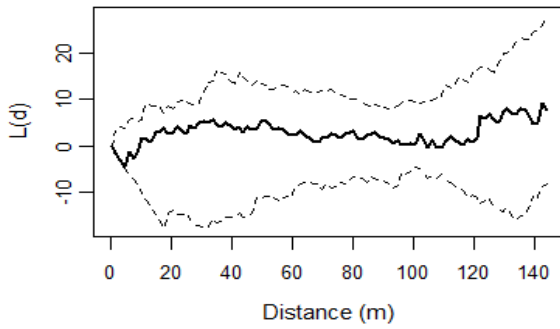

**F. *M. rubra* at Fort Riley (random)**

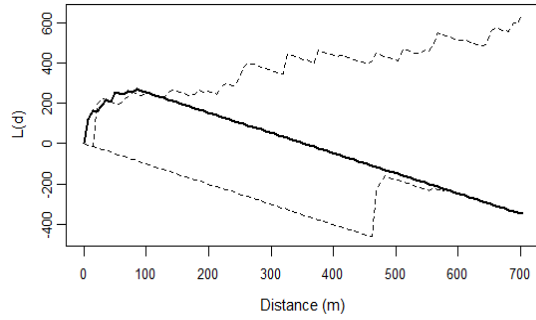

**G. *M. alba* at Fort Riley (aggregation <100 m)**

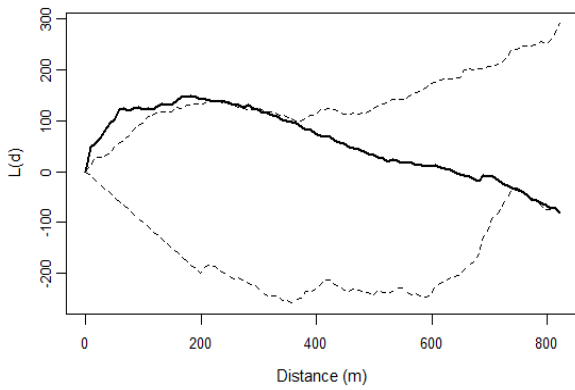

**H. *M. rubra* at KPBS (Kings Creek area), (aggregation <220m)**

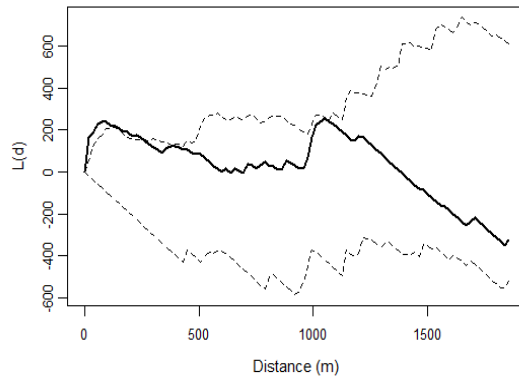

**I. *M. alba* at KPBS (aggregation <400m)**

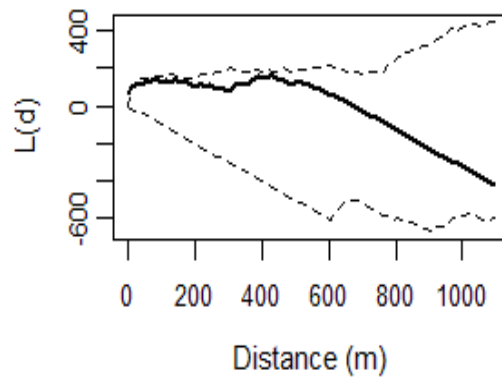

**J. *M. alba* at Linear Park (random)**

**Figure 4.12 Continued.**

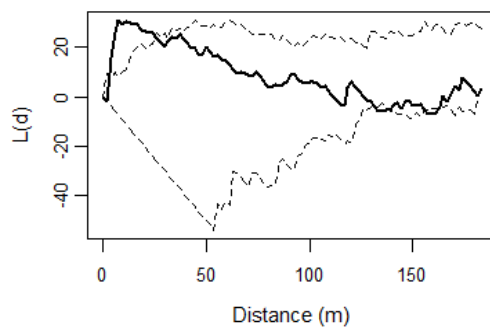

**K. *M. alba* at Pottawatomie State Lake No. 1 (aggregation <30 m)**

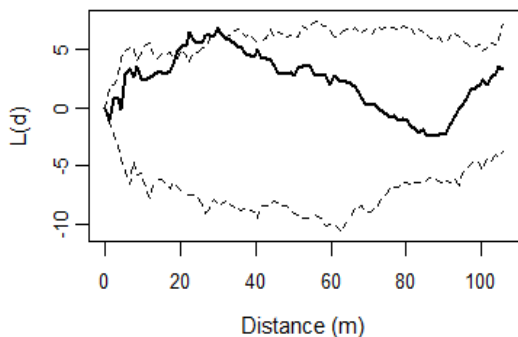

**L. *M. rubra* at Pottawatomie State Lake No. 2 (aggregation <25 m)**

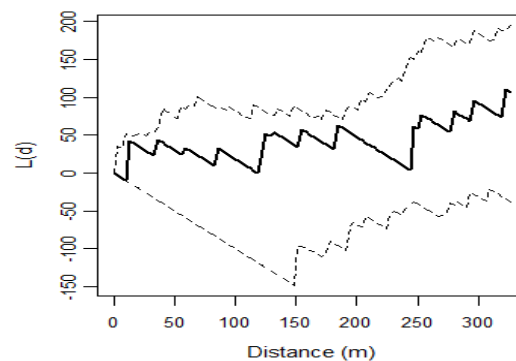

**M. *M. alba* at Pottawatomie State Lake No. 2 (Random)**

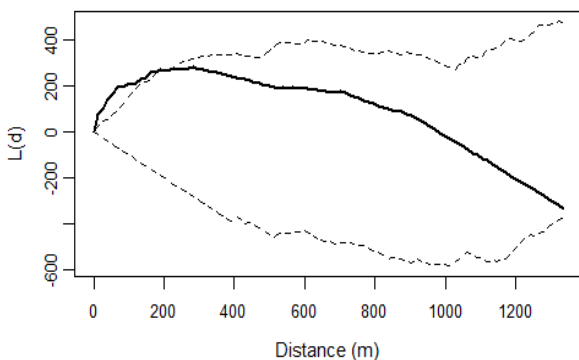

**N. *M. rubra* at KPBS (Shane Creek area, aggregation <150 m)**

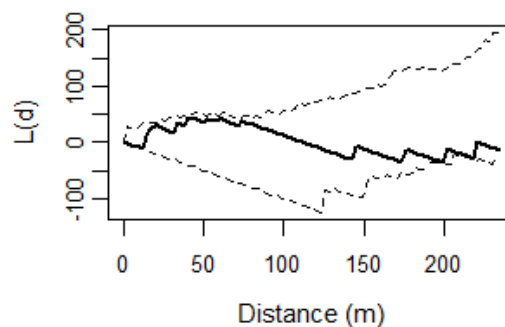

**O. *M. alba* at KPBS (Shane Creek area; random)**

**Figure 4.12 Continued.**

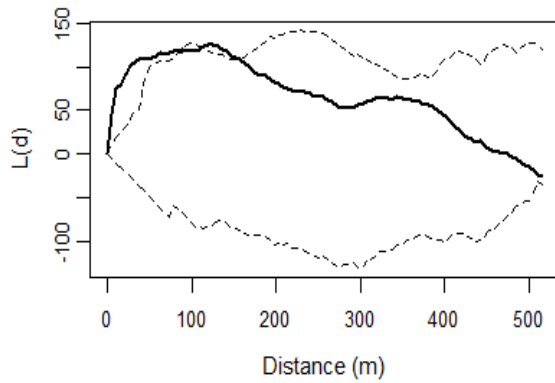

**P. *M. rubra* at Slough Creek Park area (Perry Lake, KS), (aggregation <150 m)**

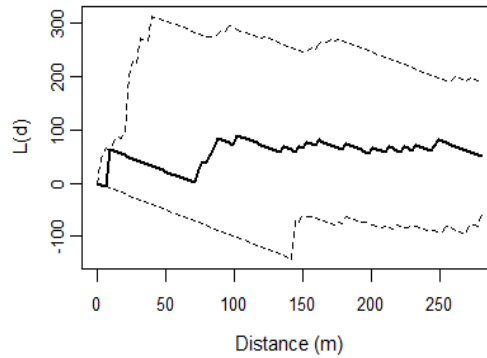

**Q. *M. alba* at Slough Creek Park area (random)**

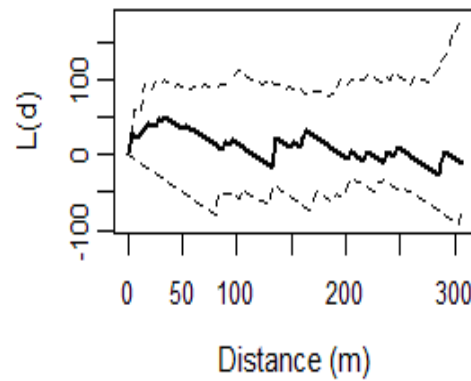

**R. *M. alba* at Timber Creek, Milford Lake (Random)**

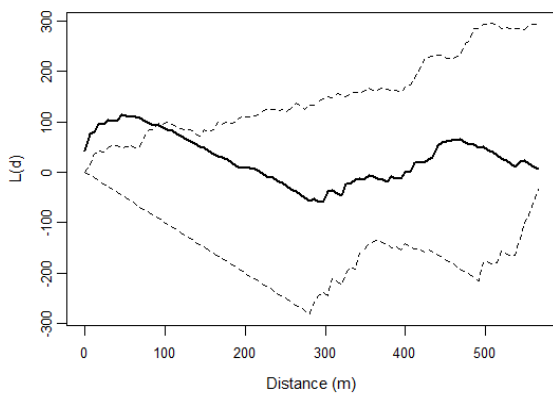

**S. *M. rubra* at Tuttle Creek southeast (aggregation <75 m)**

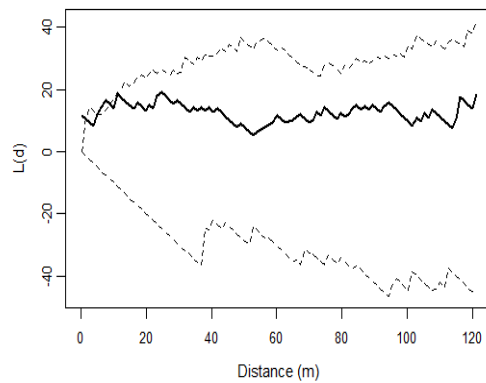

**T. *M. alba* at Tuttle Creek southeast (aggregation <15 m)**

**Figure 4.12 Continued.**

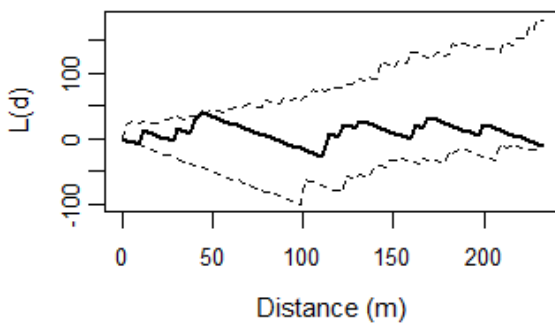

U. *M. rubra* at Tuttle Creek west (random)

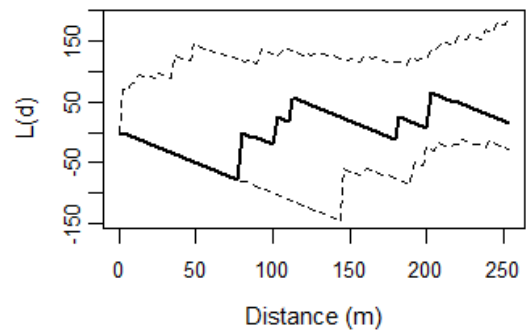

V. *M. alba* at Tuttle Creek west (random)

Figure 4.12 Continued.

**Table 4.1 Inter-year sex ratio variation with 95% confidence intervals in *Morus* at KPBS. Similar letters denote non-significant values of p, and different letters denote significant p values. The hermaphrodites were not included in the analysis. Those with an asterisk have the sex ratio significantly deviated from unity.**

<i>Species</i>	<b>Year</b>			
		<b>2005</b>	<b>2006</b>	<b>2007</b>
<i>Morus alba</i>	<b>Sex ratio</b>	<b>0.5937</b>	<b>0.6060</b>	<b>0.7407</b>
	<b>Upper CL</b>	<b>0.4192</b>	<b>0.4335</b>	<b>0.5471</b>
	<b>Lower CL</b>	<b>0.7474</b>	<b>0.7556</b>	<b>0.8710</b>
	<b>p (<math>\chi^2</math>)</b>	<b>0.2917 b</b>	<b>0.2268 b</b>	<b>0.0168 b*</b>
	<b>df</b>	<b>1</b>	<b>1</b>	<b>1</b>
	<b>N</b>	<b>32</b>	<b>33</b>	<b>27</b>
<i>M. rubra</i>	<b>Sex ratio</b>	<b>0.7666</b>	<b>0.7666</b>	<b>0.7500</b>
	<b>Upper CL</b>	<b>0.6436</b>	<b>0.6436</b>	<b>0.6258</b>
	<b>Lower CL</b>	<b>0.8566</b>	<b>0.8566</b>	<b>0.8433</b>
	<b>p (<math>\chi^2</math>)</b>	<b>&lt;0.0001 a*</b>	<b>&lt;0.0001 a*</b>	<b>0.0002 a*</b>
	<b>df</b>	<b>1</b>	<b>1</b>	<b>1</b>
	<b>N</b>	<b>60</b>	<b>60</b>	<b>60</b>



**Table 4.2 Change of sexual status in *Morus* at KPBS during 2005, 2006 and 2007. M = male, F = female, MF = hermaphrodite with mixed catkins, and M+F = hermaphrodite tree with male and female catkins on separate branches.**

<i>Morus alba</i>	Sexual status change		<i>M. rubra</i>	Sexual status change	
	tree no.	2005 → 2006		2006 → 2007	tree no.
264	M+F+MF → M	M → M+F	5	M	M → M+F
267	M+F+MF → F	F → M	7	M+F → F	F
284	F → M+F	M+F	45	M+F	M+F → F
294	F	F → M+F	49	F	F → M+F
			50	M+F → M+F+MF	M+F+MF
			62	M+ F → MF+M+F	M+F+MF → M+F
			67	F	F → M+F
			76	M+F → M+F+MF	M+F+MF → F
			77	M+F → M	M
			85	M+F → M+F+MF	M+F+MF
			86	M+F	M+F
			88	M+F → M+F+MF	M+F+MF
			92	F → M+F	M+F
			100	F → M+F	M+F → F

## CHAPTER 5 - NATIVE-EXOTIC HYBRIDIZATION IN *MORUS*

### ABSTRACT

Hybridization of an exotic plant species with its native congener can threaten the existence of the native species through genetic assimilation or ecological swamping. Two species of the genus *Morus*, the exotic *M. alba* and the native *M. rubra*, co-occur throughout much of the woodlands of eastern North America, and introgressive hybridization between them has been documented. In the present study, I use a suite of molecular markers including Randomly Amplified Polymorphic DNA (RAPD) markers and microsatellites to assess hybridization between the two species at Konza Prairie Biological Station (KPBS) in north central Kansas. Forty-nine RAPD loci and three microsatellite loci were used in Bayesian clustering of individual trees and analyses of genetic structure of the two species. Two genetically well separated clusters corresponding to species assignment resulted, with some individuals exhibiting admixed patterns (potential hybrids). The species were moderately ( $\theta^{\text{II}} = 0.079$ ; RAPD data) to highly differentiated genetically ( $F_{\text{ST}} = 0.233$ ; microsatellite data) within the site. Analysis of genetic structure of these two species suggests gene flow between them. However, the proportion of hybrids is low relative to another study of the species, possibly due to the relatively natural habitat of KPBS with its healthy population of the native species. Hybridization between this native-exotic pair may affect the taxonomic identity and genetic integrity of the native species given high abundance of the exotic outside KPBS.

Keywords: *Morus*, interspecific hybridization, microsatellites, RAPD

## INTRODUCTION

Hybridization between two taxa can affect their genetic identity and evolutionary trajectories (Anderson, 1949; Arnold, 1997; Burke and Arnold, 2001). Hybridization of a native species with an exotic congener is of particular interest because such hybridization can affect the existence of the native through genetic assimilation or demographic swamping, and can even induce invasiveness in the exotic (Antilla et al., 1998; Ellstrand and Schierenbeck, 2000). New genotypes resulting from hybridization may be better adapted, stable hybrid zones may be formed (Barton and Hewitt, 1985), or hybridization may result in the formation of introgressive races (Anderson, 1949). In the present study, I focus on assessment of interspecific hybridization between two species of the genus *Morus* L. (Moraceae) at Konza Prairie Biological Station (KPBS), in the Flint Hills region of north central Kansas (United States).

*Morus rubra* L. nears the western edge of its distribution in central Kansas, where it is fairly common in rich riparian areas. *Morus alba* L. is native to China and has become naturalized throughout the range of *M. rubra*; it occurs alongside *M. rubra* in riparian forests but also into more xeric uplands and relatively disturbed pastures and secondary growth forests (it is also cultivated). It is considered invasive in some areas (Weber, 2003; Uva et al., 1997 and Hoffman and Kearns, 1997). Hybridization and asymmetrical introgression were recently documented between these species in southern Ontario, Canada using RAPD markers (Burgess et al., 2005, 2006). They found introgression towards *M. alba* as maternal parent was higher than toward *M. rubra*. The exotic species had a significantly higher proportion of pollen production, resulted in seed discounting in the native species (Burgess et al., 2008), and reciprocal transplant

experiments showed no habitat differentiation between the two species (Burgess et al., 2006). They further showed that the native species was less fit than both the hybrids and *M. alba* individuals, and the hybrids with *M. rubra* as the maternal parent were less fit than *M. alba* and the hybrids with *M. alba* as the maternal parent.

In the United States, *M. rubra* is currently listed as endangered in the states of Connecticut and Massachusetts, and as threatened in Michigan and Vermont (USDA PLANTS Database, 2007). Unlike in many places, where *M. rubra* is rare, this species occurs in healthy populations in many riparian habitats in the Flint Hills region of Kansas, including KPBS, a NSF-LTER site. In this context, I am using a suite of molecular markers (RAPDs and microsatellites) for assessing hybridization.

RAPD markers have been widely used in analyses of genetic variation at the population level, mainly because the methods are inexpensive and easy to use (Williams et al. 1990). However, they are dominant markers and have limited application in population structure and differentiation (Hedrick, 1992; Nybom and Bartish, 2000). On the other hand, microsatellites, which have advantages over RAPDs such as co-dominance, hyper-variability and high reproducibility, have been recently used in assessing interspecific hybridization in addition to studying genetic structure of a single species. In this study, I apply both RAPD and microsatellite markers to address the following questions. Does natural hybridization occur between *M. rubra* and *M. alba* at KPBS? Do populations show evidence of introgression? If so, how is gene flow affecting the integrity of *M. rubra*?

## MATERIALS AND METHODS

### Study area

The Kings Creek area of KPBS (Figure 5.1) was selected for the present study. KPBS is a relatively pristine tallgrass prairie remnant and an NSF-LTER site located in the Flint Hills region of Kansas (39°05'N and 96°35'W) extending to an area of 3,487 hectares. It is owned by The Nature Conservancy and Kansas State University (KSU), and is managed for ecological research by the KSU Division of Biology. The site has a continental climate characterized by warm and wet summers, and dry and cold winters. Mean annual rainfall is 835 mm and the mean monthly temperature in January is -4 °C and in July is 27 °C. *Morus rubra* and *M. alba* co-occur in the gallery forests dominated by *Quercus* spp. and *Celtis occidentalis* L. The primary site of this study was a nearly one square kilometer area along Kings Creek, where both species had been exhaustively located, mapped and tagged (see Chapter 4). A pilot study on experimental hybridization (reciprocal artificial crosses) between the two species was conducted in 2005, and crosses were successful in both directions.

### Sample collection and DNA isolation

Fresh leaf samples of 75 *M. rubra* and 38 *M. alba* trees were collected for DNA extraction in 2005. Total DNA was extracted from leaf material dried in silica gel following the CTAB protocol of Loockerman and Jansen (1996; modified from that of Doyle and Doyle [1987]) or using a DNeasy Plant Mini kit (Qiagen Corp., Valencia CA).

## **RAPD marker amplification and scoring**

Initially six samples were screened using five RAPD primers used by Burgess et al. (2005; University of British Columbia [UBC] primer numbers 13,18, 28, 51 and 53) and 105 primers from a UBC “set” (UBC primer numbers 101-200; Nucleic Acid and Protein Service Unit, Biotechnology Laboratory, University of British Columbia, Vancouver, BC, Canada); and PCR was conducted in a reaction mixture of 10µl containing 25 ng genomic DNA, 2mM of PCR buffer, 15ng of primer, and 1 unit of *Taq* DNA polymerase, 25 mM MgCl<sub>2</sub>, 0.2 mM of each dNTP. The PCR amplification conditions in a PTC-200 DNA engine (MJ Research Inc., MA, USA) were 45 cycles of initial denaturation at 94°C for one minute followed by 1 minute annealing at 36°C and two minutes of elongation at 72°C with a final elongation step of seven minutes at 72°C. Electrophoresis of the PCR product was conducted on a 2% agarose gel at 60 V for 3 hours, stained with ethidium bromide, and visualized using UV light. Each sample was amplified and visualized twice to ensure reproducibility. Among those primers, five (Table 1) were polymorphic and consistently amplified across samples (Table 1). These were used in amplification of 45 DNA samples (17 *M. alba* and 28 *M. rubra*). The samples were amplified twice and checked for reproducibility. The electrophoresed PCR product was photographed for the analysis. Each individual was scored for the presence (1) or absence (0) of each RAPD band.

## **Microsatellite markers amplification and scoring**

Six microsatellite primer pairs published by Aggarwal et al. (2004; developed for *M. indica*) and seven primer pairs by Tani et al. (2005; characterized for *M. bonnines*) were screened for 12 samples (six of each species). The PCR was conducted in a reaction mixture of 15µl containing 25 ng template DNA, 1X GoTaq Flexi buffer (Promega), 2.5 mM MgCl<sub>2</sub>, 0.2 mM each dNTP, 0.25 µM forward M13(-18) tagged primer, 0.25 µM reverse primer (see Table

2) and one unit of GoTaq Flexi DNA polymerase (Promega). The PCR conditions were an initial denaturation of 94 °C for two minutes; and then 30 cycles of 45 seconds denaturation at 94 °C, 1 minute annealing at 51 °C, and two minutes elongation at 72 °C; and a final extension of five minutes at 72 °C. The PCR products were visualized using ethidium bromide on a 2.0% agarose gel. Three primer sets (Table 2) were successfully amplified, and consistently polymorphic for both species. These three primer sets were used for the microsatellite amplification for 48 samples collected from 29 *M. rubra* and 19 *M. alba* trees (the same individuals as for the RAPD study, except that two additional individuals of *M. alba* and one individual of *M. rubra* were added).

The PCR protocol used was similar to that described above except a fluorescently labeled primer was added. The forward tagged primer at 0.05 µM, the reverse primer at 0.25 µM, and the fluorescently labeled primer at 0.20 µM were mixed in the reaction mixture, and the amplification was conducted as described above. ROX 500 (Applied Biosystems, Inc., Foster City, CA), an internal size standard, was used for genotyping. The genotyping was carried out using ABI 3730 at the Kansas State University DNA Sequencing and Genotyping Facility. GENEMARKER v. 1.51 (SoftGenetics; State College, PA) was used for editing and scoring alleles at each locus.

## **Data analysis**

The program STRUCTURE (Pritchard et al., 2000) was used to assign individuals to clusters based on the proportion of each individual belonging to one cluster or the other, a process which allows identifying hybrids (individual with admixed patterns). First, the program was used in a cluster analysis of individual trees based on the genotype data alone without using information on taxon identification. This allowed assessment of how the genotypic data were related to

morphological distinctiveness between two species. In the program STRUCTURE, five independent runs were performed with a value of K (population number) from one through ten using a burnin period of 10,000 for an MCMC of 50,000 iterations (microsatellite data set) or a burnin period of 20,000 for the MCMC of 100,000 iterations (RAPD data set). Prior population information was not used for these analyses (USEPOPINFO = 0). The highest likelihood score of the model for both data sets resulted at K= 2, suggesting the presence of two distinct genetic clusters. Secondly, the analyses were also performed using population information (USEPOPINFO = 1) at K = 2, as the two species are clearly distinct. The analyses were performed with GENEBAK = 2 and MIGPRIOR = 0.05, with a burnin period and MCMC iterations as described above. Morphological species information was mapped onto the genetic clusters of each data set, and the mean proportion of inferred ancestry of morphologically distinct individuals (i.e. those which were not listed as potential hybrids based on field identification) was used to construct the range of proportion of inferred ancestry for the hybrids. A similar approach was used by Burgess et al. (2005).

Population genetic parameters such as observed and expected heterozygosities, proportion of polymorphic loci, and fixation index were calculated using GDA Version 1.0 (Lewis and Zaykin, 2001). The program GENEPOP (Raymond and Rousset, 1995) was used to estimate the number of migrants per generation (Slatkin, 1995; Barton and Slatkin, 1986), and to test for homogeneity of allele distributions and deviations from Hardy-Weinberg equilibrium. The analyses were performed with MCMC parameters as demorization = 5000, batches = 5000 and iterations = 50,000. The same program was also used to calculate allele frequencies and an estimate of species differentiation ( $F_{ST}$ ). The  $F_{ST}$  values were estimated as in Weir and Cockerham (1984), and interpreted as in Hartl and Clark (1997). The program Hickory v. 1.1



(Holsinger and Lewis, 2003) was used to analyze RAPD data for the population structure between species. The program allows estimation of  $\theta^H$ , an analogue of  $F_{ST}$  from dominant marker data such as RAPDs without prior information on inbreeding ( $F_{IS}$ ) and without assuming Hardy-Weinberg equilibrium of genotypes (Holsinger et al., 2002). The RAPD data set was analyzed under four different models as implemented in the program. The models were compared using the deviant information criterion (DIC; Table 5.3).

## RESULTS

### The RAPD and microsatellite polymorphism

The five RAPD primers utilized in this study generated 49 scorable RAPD bands in 45 *Morus* samples. The variation in band size ranged from approximately 400 to 2200 bp and the number of RAPD fragments per primer varied from five to 12 (Table 5.1). The highest number of loci amplified was 12 (for UBC 13 and UBC 196), and the lowest number of loci amplified was five (primer UBC 185). All five primers were polymorphic. Nine and eight loci were species specific to *M. alba* and *M. rubra*, respectively (Table 5.1).

The three microsatellite loci included in the present study were polymorphic with mean observed and expected heterozygosities of 0.718 and 0.6424, respectively (Table 5.5). The patterns of microsatellite allele size were variable. Allele sizes ranged from 188 to 203 base pairs (bp) for both species for the Mulstr2 locus (Fig. 5.3). The most common alleles for *M. alba* were 200 and 203 bp, and for *M. rubra* the most common was 200 bp. Similarly, for the Mulstr 4 locus (Fig. 5.4), the most common allele in *M. alba* and *M. rubra* were 142 bp and 139 bp, respectively. The least common allele at this locus was 145 bp in both species. For the Multstr6

locus (Fig. 5.5), the most common allele for *M. alba* was 161 bp while that for *M. rubra* was 149 bp. The least common alleles for *M. alba* was 151 bp, and that for *M. rubra* was 161 bp.

### **Inferring hybridization**

The results from Bayesian analysis of clustering based on RAPD and microsatellite loci were similar. The analyses without using population information resulted into two distinct genetic clusters ( $K=2$ ) with highest  $\ln P[D] = -387$  (among the values for  $K = 1$  through 10) for microsatellite data, and  $-3369$  for the RAPD data. The clustering was improved (Fig. 5.2) when analyses were performed using population information. The mean proportion of inferred ancestry for the *M. rubra* cluster based on microsatellite data was 0.95 and that for *M. alba* was 0.09. Thus, the proportion of inferred ancestry ( $q_i$ ) for hybrids was in between 0.09 and 0.95. Similarly, the range was estimated as 0.31 to 0.97 for the RAPD data set. Within these ranges there were 18 potential hybrids identified by microsatellites and 17 hybrids identified by the RAPD data. Although these two numbers are similar, only eight potential hybrids (numbers 1, 8, 25, 36, 37, 38, 39, and 45) were present in the range of both data sets (Table 5.3). Of the remaining potential hybrids inferred from microsatellite data, nine individuals were previously assigned morphologically to *M. rubra* and one tree to *M. alba*. Out of the nine additional trees in the range of hybrids based on RAPD data, five trees were previously assigned to *M. rubra*, and four trees to *M. alba*. Since the majority of the hybrids had a value of  $q_i$  greater or less than 0.50, most of the hybrids would be suggested to be later generation hybrids. Out of 18 potential hybrids, 73% had a ' $q_i$ ' greater than 0.5 (i.e. introgressed with *M. rubra*) and 27% had a value less than 0.5 (introgressed with *M. alba*).

## Population structure

The RAPD data analyzed in the program Hickory using four models (the “full model”, “ $f = 0$  model”, “ $f$  free model” and the “ $\theta^{\text{II}} = 0$  model”) produced the smallest deviance information criterion for the full model (295.174; Table 5.4). This model showed that the two *Morus* species are moderately differentiated ( $\theta^{\text{II}} = 0.079$  [0.064, 0.087]) with an approximate between-species component of genetic variation of ca. 8%. The observed and expected heterozygosities for *M. alba* were 0.645 and 0.691, and for *M. rubra* were 0.619 and 0.609, respectively. The global test of heterozygosities excess was insignificant for each species ( $p = 0.091$ , and 0.663 for *M. alba* and *M. rubra*, respectively). There were three and eight private alleles in *M. alba* and in *M. rubra* populations, respectively. The two species were highly differentiated ( $F_{\text{ST}} = 0.232$ ).

## DISCUSSION

### Hybridization and genetic variation

In the present study, both RAPD and microsatellite data provide evidence for hybridization between *M. alba* and *M. rubra*. The results from both data sets were similar: 44% of the potential hybrids were identified similarly in each data set, which suggests that the use of a suite of molecular markers provides complementary information and can increase the strength of inference. When information on potential hybrid identity based on morphology was mapped onto the genetic clustering, six of nine such individuals were identified as potential hybrids by one or the other data sets (or both). Morphological identification as a potential hybrid was made based on characters of the leaf, bud and bark; however, this was made based on observation only, and not based on morphometric data. These findings are similar to the findings of *Morus* populations in Ontario, Canada, by Burgess et al. (2005). The number of hybrids inferred in the present study

was ca. 37%, a value smaller than the average number of hybrids in Canada, which was 54%. KPBS has more *M. rubra* individuals than *M. alba*, unlike in Ontario where *M. rubra* is now rare (Burgess et al., 2005), and this may explain the difference.

Introgressive hybridization in *Morus* was documented by Burgess et al. (2005), who showed that introgression towards *M. alba* as the maternal parent occurred at a higher proportion than introgression toward *M. rubra*. They also showed that F<sub>2</sub> or later generation hybrids were more common than F<sub>1</sub> hybrids. These later generations hybrids were both introgressed with *M. alba* and with *M. rubra*. In the present study, more hybrids of later generations were found: 73% of the hybrids introgressed towards *M. rubra* and only 27% towards *M. alba*. These values stand in contrast to the findings of Burgess et al. (2005), where more than 68% of hybrids were introgressed towards *M. alba*. Not surprisingly, the areas in which they had sampled *M. rubra* had more *M. alba* individuals. The greater abundance of *M. alba* would result in production of more *M. alba* pollen and ovules, facilitating more backcrossing toward the introduced *M. alba* than the native *M. rubra*. In contrast, KPBS has more of the native *M. rubra* individuals than the *M. alba* individuals. *Morus* hybridization at KPBS is asymmetrical as in Ontario (Burgess et al., 2005), but differing in that introgression toward *M. rubra* is more frequent, in correspondence with the greater abundance of *M. rubra* at KPBS.

Both microsatellite and RAPD markers indicated that each species has a significant population structure at KPBS. Although F<sub>ST</sub> values are commonly used to interpret population structure within species, they have also been used in the interpretation of genetic structure of hybridizing taxa (e.g. Coyer et al., 2007). The species differentiation between *M. alba* and *M. rubra* with the F<sub>ST</sub> of 0.23 (microsatellites) is smaller than the species differentiation values of 0.63 between two hybridizing *Fucus* species (Coyer et al., 2007) suggesting some degree of gene

flow between species. In addition, each species had private alleles coming from the other species: *M. alba* had 3 private alleles, while *M. rubra* had a total of 8 private alleles, which indicates that the hybridization is asymmetrical. Genetic analyses showed that populations are at equilibrium and have neither homozygote deficiency nor excess. The differentiation between microsatellite loci is very high, suggesting that they could be used to address other population level questions in the future. In addition to employing additional microsatellite loci, study using maternally inherited markers can be useful in obtaining better insights about the mechanism of introgression between the two species.

### **Implications for systematics**

The two species of *Morus* studied are taxonomically well defined (Chapter 2). The present finding of interspecific hybridization between two non-sister species of *Morus* is interesting. There have been cases of specimen misidentification in the region (M. Mayfield, KSU Herbarium, pers. comm.) and morphological characters are sometimes confusing. It is possible that hybridization poses a challenge to taxonomic identification of the species. Based on these findings, we might expect hybridization to yield a reticulating pattern of phylogenetic relationships in the phylogeny of the genus *Morus*. In Chapter 3, only one sample of *M. alba* was included, and it was an individual deemed clearly to be *M. alba*. If *Morus* species native to Asia are hybridizing, this could contribute to poor resolution of the phylogenetic relationships (Chapter 3). There have long been mulberry breeding programs in Asia, with new races developed for silkworm industry that can potentially escape cultivation through wind pollination and seed dispersal by birds. Thus there may be threats to the integrity of the native species there, complicating the taxonomy. *Morus* needs intensive population level studies like the present study to better understand its systematics. This study provides evidence of hybridization of a native-

exotic pair of *Morus* in North America complementary to the findings of Burgess et al. (2005), and will help to yield insights on potential threat of *M. alba* to *M. rubra* in its native habitats.

## **Ecological effect**

*Morus alba* and *M. rubra* have male-biased sex ratios at KPBS (Chapter 4) and *M. alba* trees are generally larger. The larger trees of *M. alba* with much higher pollen production (see Burgess et al. (2008) in close proximity to *M. rubra* may facilitate pollen movement from the exotic to the native, and a similar situation may occur from the F<sub>1</sub> male to *M. rubra* females. This may explain the finding of more hybrids introgressed towards *M. rubra*. This could also result in seed discount due to the effect of heterospecific pollen as documented by Burgess et al. (2008). Burgess et al. (2006), in their reciprocal transplant experiments, showed *M. rubra* was under serious disadvantage during its establishment due to the presence of hybrid and *M. alba* individuals, and *M. rubra* individuals were the least fit individuals. They further showed that the hybrids resulting from *M. rubra* as the maternal parent were less fit than those with *M. alba* as the maternal parent, and the hybrids with *M. alba* as maternal parent. The KPBS *Morus* populations may advance towards a similar situation as in Canada (with *M. rubra* being rare) over time. Population dynamics and ecological studies of these two species at KPBS will be helpful to clarify such issues.

Overall, this study has greatly improved our knowledge on interspecific hybridization in *Morus*, and its implications for systematics of the genus. Sampling of additional populations and including an increased number of microsatellites and maternally inherited markers should help in obtaining better insights.

## **ACKNOWLEDGEMENTS**

This section of my dissertation was supported by Konza Prairie LTER program, Kansas State University Herbarium (KSC), KSU Division of Biology and the American Society of Plant Taxonomists (ASPT). I am very much grateful to Dr. Mark Mayfield for his help in the field and his suggestion for developing this project. I thank Drs. Mark Ungerer, Shannon Fehlberg and Samantha Wisely for useful discussion.

## LITERATURE CITED

- ABBOTT, R. J. 1992. Plant invasions, interspecific hybridization and the evolution of new plant taxa. *Trends in Ecology & Evolution* 7: 401-405.
- ANDERSON, E. 1949. Introgressive hybridization. New York, Wiley.
- ANTTILA, C. K., A. R. KING, C. FERRIS, D. R. AYRES AND D. R. STRONG. 2000. Reciprocal hybrid formation of *Spartina* in San Francisco Bay. *Molecular Ecology* 9: 765-771.
- ARNOLD, M. L. 1997. Natural hybridization and evolution. Oxford University Press, New York.
- BARTON, N. H. AND G. M. HEWITT. 1985. Analysis of hybrid zones. *Annual Review of Ecology and Systematics* 16: 113-148.
- BARTON, N. H. AND M. SLATKIN. 1986. A quasi-equilibrium theory of the distribution of rare alleles in a subdivided population. *Heredity* 56: 409-415.
- BURGESS, K. S., M. MORGAN, L. DEVERNO AND B. C. HUSBAND. 2005. Asymmetrical introgression between two *Morus* species (*M. alba*, *M. rubra*) that differ in abundance. *Molecular Ecology* 14: 3471-3483.
- BURGESS, K. S. AND B. C. HUSBAND. 2006. Habitat differentiation and the effect of hybridization on establishment of red mulberry (*Morus rubra* L.) in Canada. *Journal of Ecology* 94: 1061-1069.



- BURGESS, K.S., M. MORGAN AND B. C. HUSBAND. 2008. Inter-specific seed discounting and the fertility cost of hybridization in Red Mulberry (*Morus rubra* L.). *New Phytologist* 177: 276-284.
- BURKE, J. M. AND M. L. ARNOLD. 2001. Genetics and the fitness of hybrids. *Annual Review of Genetics* 35: 31-52.
- CARNEY, S. E., K. E. GARDNER AND L. H. RIESEBERG. 2000. Evolutionary changes over the fifty-year history of a hybrid population of sunflowers (*Helianthus*). *Evolution* 54: 462-474.
- COYER, J. A., G. HOA RAU, W. T. STAM AND J. L. OLSEN, 2007. Hybridization and introgression in a mixed population of the intertidal seaweeds *Fucus evanescens* and *F. serratus*. *Journal of Evolutionary Biology* 20:2322-2333.
- DOBZHANSKY, T., F. J. AYALA, G. L. STEBBINS AND J. W. VALENTINE. 1977. *Evolution*. W. H. Freeman, San Francisco, California, USA.
- ELLSTRAND, N. C. AND K. A. SCHIERENBECK. 2000. Hybridization as a stimulus for the evolution of invasiveness in plants? *Proceedings of the National Academy of Sciences, USA* 97: 7043-7050.
- GRAY, E. AND R. E. GRAY. 1987. Leaf lobation patterns in mulberry. *Castanea* 52(3): 216-224.
- GREAT PLAINS FLORA ASSOCIATION. 1986. *Flora of the Great Plains*. University of Kansas Press, Lawrence, Kansas, USA.

- HARTL, D. L. AND CLARK, A. G. 1997. Principles of population genetics. Third edition. Sinauer Associates. Sunderland, Massachusetts, USA.
- HEDRICK, P. 1992. Shooting the RAPDs. *Nature* 355: 679-680.
- HOLSINGER, K. E. AND P. O. LEWIS. 2003. HICKORY: v 1.1. A package for analysis of population genetic data, 1.0 edn. Storrs. Department of Ecology and Evolutionary Biology, University of Connecticut.
- HOLSINGER, K. E., P. O. LEWIS AND D. K. DEY. 2002. A Bayesian approach to inferring population structure from dominant markers. *Molecular Ecology* 11: 1157-1164.
- LEWIS, P. O. AND D. ZAYKIN. 2001. Genetic Data Analysis: computer program for the analysis of allelic data. Version 1.0 (d16c). Free program distributed by the authors over the internet from <http://lewis.eeb.uconn.edu/lewishome/software.html>
- LOOCKERMAN, D. J. AND R. K. JANSEN. 1996. The use of herbarium material for DNA studies. Pp. 205-220 in Stuessy T. F. and S. J. Sohmer (eds.). *Sampling the Green World*. Oxford, Columbia University Press.
- NYBOM, H. I. AND V. BARTISH. 2000. Effects of life history traits and sampling strategies on genetic diversity estimates obtained with RAPD markers in plants. *Perspectives in Plant Ecology, Evolution and Systematics* 3: 2 93-114.
- RAMSEY, J. AND D. W. SCHEMSKE. 1998. Pathways, mechanisms, and rates of polyploid formation in flowering plants. *Annual Reviews of Ecology and Evolution* 29: 467-501.

RAYMOND, M. AND F. ROUSSET. 1995. GENEPOP (version 1.2): population genetics software for exact tests and ecumenicism. *Journal of Heredity* 86: 248-249.

SLATKIN, M. 1995. A measure of population subdivision based on microsatellite allele frequencies. *Genetics* 130: 457-462.

WEIR, B. S. AND COCKERHAM, C. C. 1984. Estimating  $F$ -Statistics for the analysis of population structure. *Evolution* 38: 1358-1370.

WILLIAMS, J. G. K, A. R. KUBELIK, K. J. LIVAK. J. A. RAFALSKI AND S. V. TINGEY. 1990. DNA polymorphisms amplified by arbitrary primers are useful as genetic markers. *Nucleic Acids Research* 18:6531-6535.

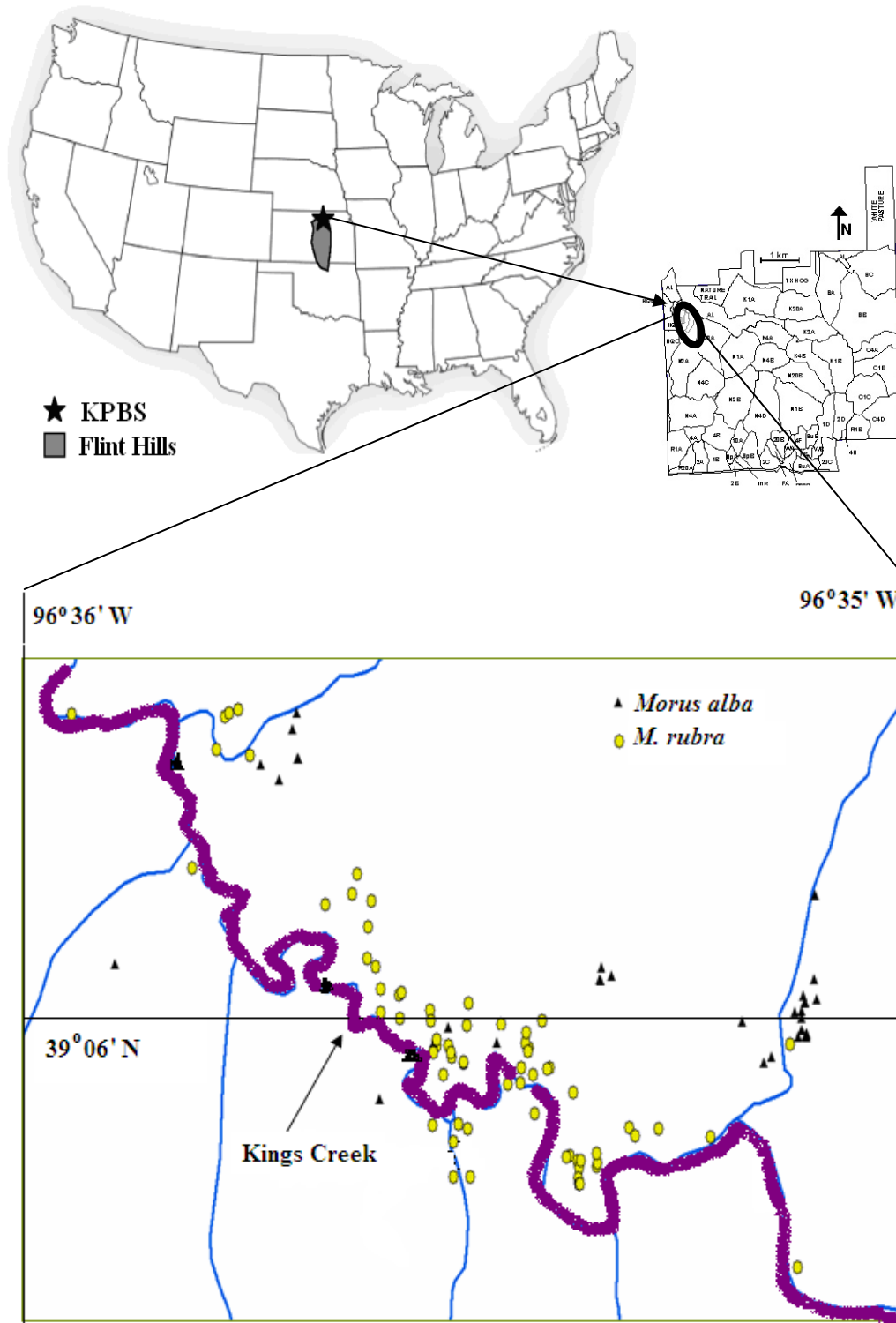
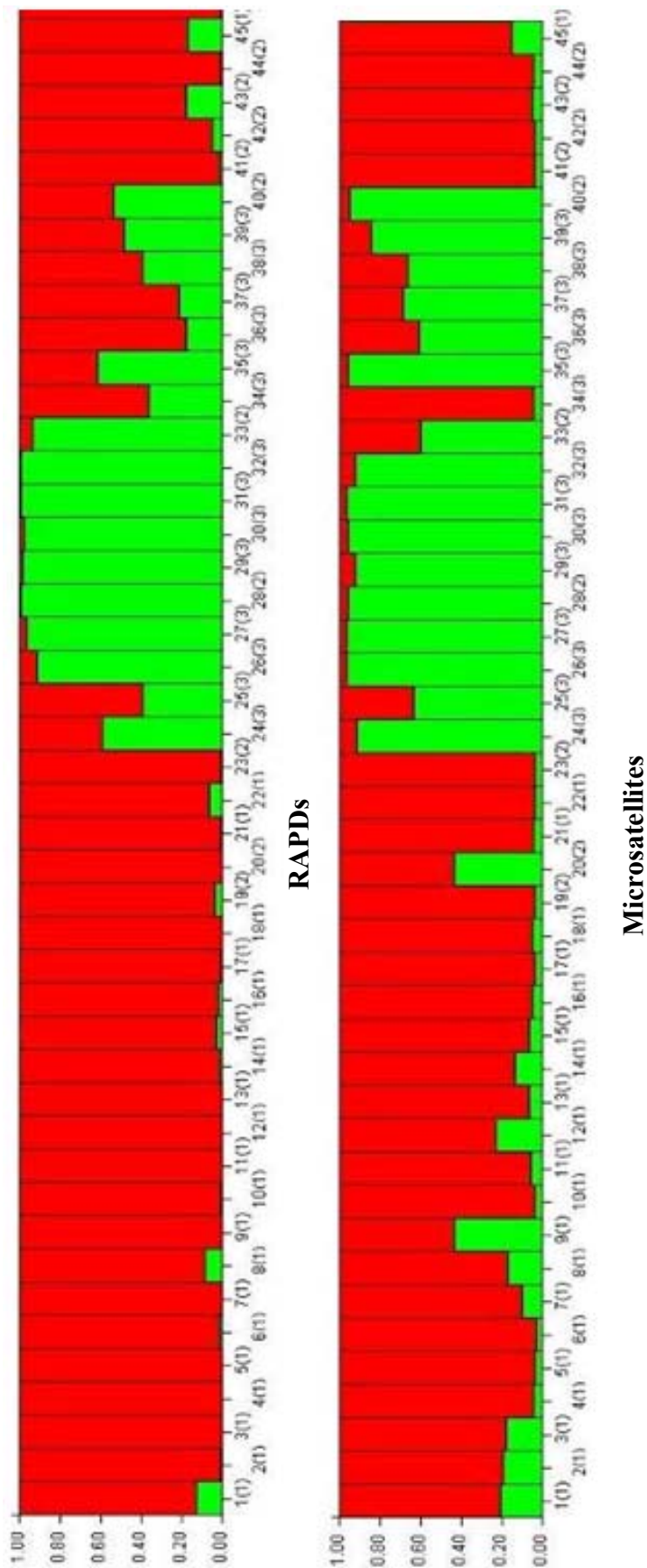
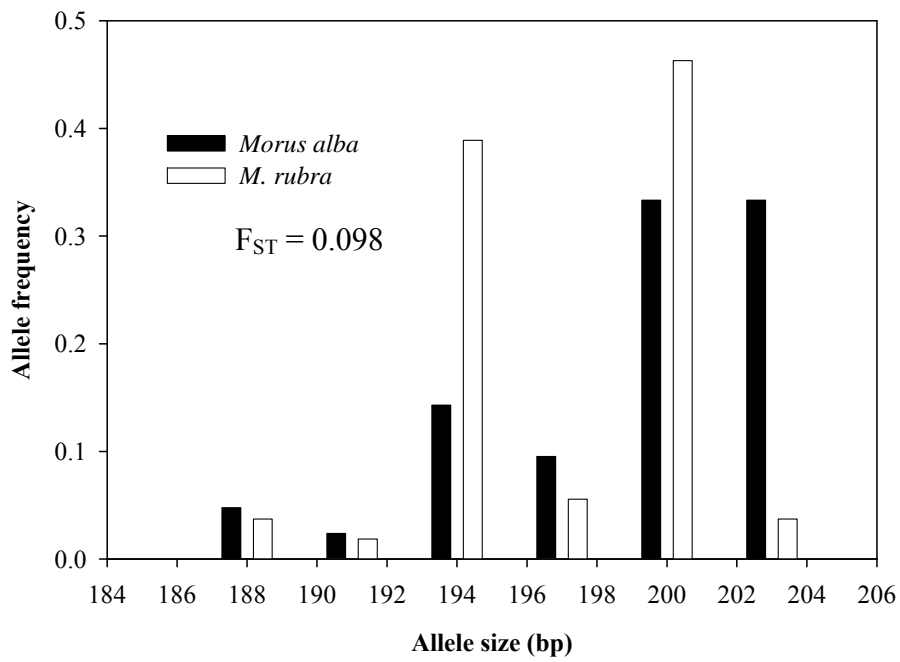

Figure 5.1 Distribution of *Morus* trees along Kings Creek area at KPBS.



**Figure 5.2** Bayesian clustering of *Moritz* trees based on RAPD and microsatellite data. The proportion of inferred ancestry to be included in each cluster is on the y-axis. Each vertical column represents a different individual. Numbers on the x-axis represent sample numbers, followed by an indication of taxon identification in parenthesis: 1 = *M. rubra*, 2 = potential hybrid (based on morphology) and 3 = *M. alba*.



**Figure 5.3** Frequency distribution of alleles at microsatellite locus Mulstr2 in *M. alba* and *M. rubra*.

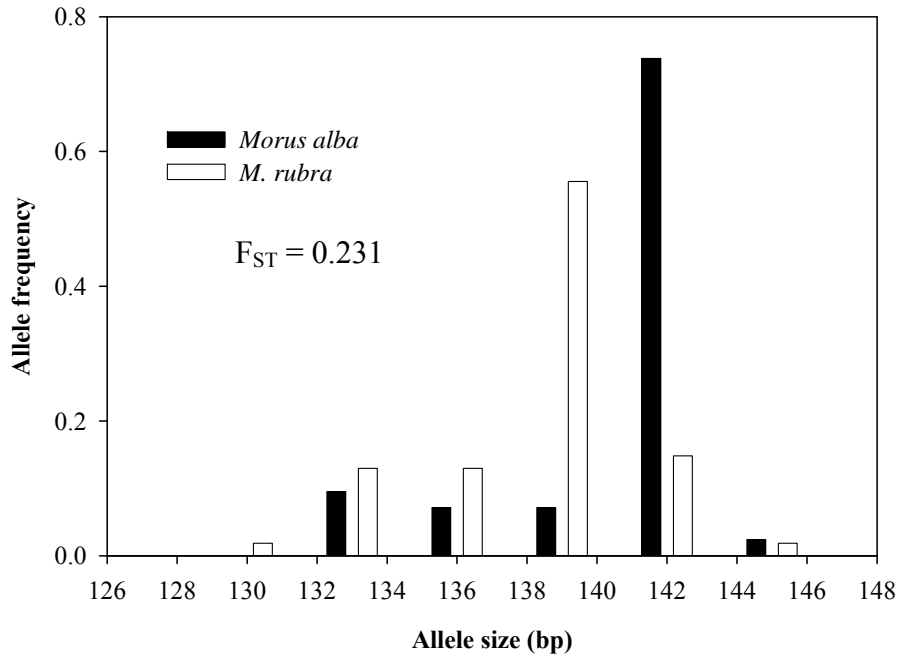

**Figure 5.4** Frequency distribution of alleles at microsatellite locus Multr4 in *Morus*.

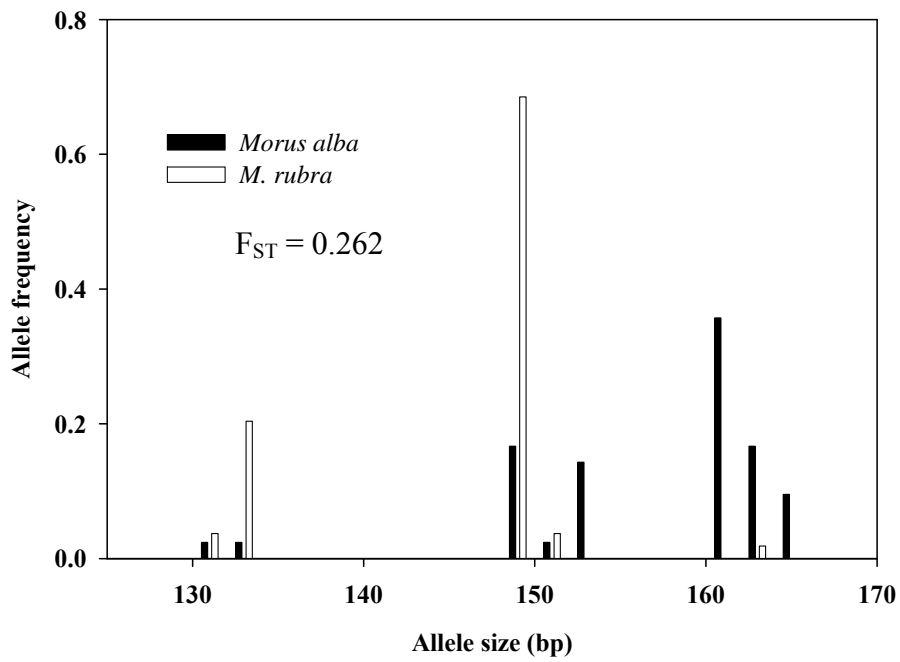

**Figure 5.5** Frequency distribution of alleles at microsatellite locus Multr6 in *Morus*.



**Table 5.1 Randomly amplified polymorphic DNA (RAPD) primers, primer sequences and number of polymorphic loci in 45 individuals of *M. alba* and *M. rubra*. The numbers in parentheses represent species specific loci for *M. alba* and *M. rubra*, respectively.**

<b>Primers</b>	<b>Primer sequence (5' to 3')</b>	<b>Polymorphic loci</b>	<b>Fragment length range (bp)</b>
<b>UBC 13</b>	<b>CCT GGG TGG A</b>	<b>12 (2, 3)</b>	<b>400-2000</b>
<b>UBC 18</b>	<b>GGG CCG TTT A</b>	<b>10 (1, 2)</b>	<b>450-1600</b>
<b>UBC 185</b>	<b>GTG TCT TCA C</b>	<b>5 (1,1)</b>	<b>650-2000</b>
<b>UBC 192</b>	<b>GCA AGT CAC T</b>	<b>10 (2,1)</b>	<b>500-2000</b>
<b>UBC 196</b>	<b>CTC CTC CCC C</b>	<b>12 (3, 1)</b>	<b>450-2200</b>

**Table 5.2 Microsatellites primer sets (from Aggarwal et al., 2004) successfully amplified for *M. alba* and *M. rubra*. An asterisk shows the position where a sequence tag, M13 of 18 bp (5'-ACGACGTTGTAAAACGAC-3'), was added to the 5' end of the forward primer.**

Name	Sequence (5' to 3')	Microsatellite [size in bp]
MulSTR2	F: * CGTGGGGCTTAGGCTGAGTAGAGG R: CACCACCACTACTTCTCTTCTTCCAG	(GTT)11 [163-206]
MulSTR4	F: * GGTC AAGCGCTCCAGAGAAAAG R: CCCTATTA ACTTTTTGGTCACCTCTA	(GAA)6 [112-146]
MulSTR6	F: * TCCTTAGGTTTTTGGGGTCTGTTTACAT R: CCTCATTCTCCTTTCACCTATTGTTG	(GT)15 [119-181]

**Table 5.3 Parental species and potential hybrids based on the proportion of inferred ancestry ( $q_i$ ) with *M. rubra* obtained from two different data sets. The value of  $q_i$  in between the mean values for *M. alba* and *M. rubra* was inferred for the potential hybrids. Those with an asterisk were identified as potential hybrids based on both data sets.**

Microsatellites							RAPDs				
Value of $q_i$	No. trees	Species (text)/ potential hybrid as assigned in the program (number)					Value of $q_i$	No. trees	Species/potential hybrid		
<0.09	13	<i>M. alba</i>					<0.31	8	<i>M. alba</i>		
0.3	5	*37	*38	*25	*36	33	0.37	1	35		
0.55	3	9	20		*39		0.4	1	24		
0.75	1	12					0.46	1	40		
0.78	1	*1					0.5	1	*39		
0.82	4	2	3	*8	*45		0.6	3	*25	*38	34
0.86	3	14	47				0.78	1	*37		
0.9	1	7					0.8	3	43	*36	*45
>0.95	18	<i>M. rubra</i>					0.87	1	*1		
							0.9	1	*8		
							0.94	3	22	42	19
							0.96	1	15		
							>0.97	20	<i>M. rubra</i>		

**Table 5.4 Comparison of the four models tested in analysis of population genetic structure of *M. alba* and *M. rubra* at KPBS. (DIC = deviance information criterion, analogue of AIC;  $f$  = estimate of  $F_{IS}$ ;  $\theta^{II}$  = estimate of  $F_{ST}$ ). Values shown are the posterior means with their 95% credible intervals (in parentheses).**

<b>Model</b>	<b><math>f</math></b>	<b><math>\theta^{II}</math></b>	<b>DIC</b>
Full model	0.622 (0.06-0.984)	0.079 (0.064-0.087)	295.174
$f = 0$	0	0.059 (0.043-0.065)	296.883
$f$ free model	0.49 (0.026-0.975)	0.076 (0.045-0.131)	361.963
$\theta^{II} = 0$	0.880 (0.649-0.997)	0	311.585

**Table 5.5** Microsatellite loci used in the present study, including number of individuals scored ( $N$ ), number of alleles, observed ( $H_o$ ) and expected ( $H_e$ ) heterozygosities.

<b>Species</b>	<b>Locus</b>	$N$	<i>No. alleles</i>	$H_o$	$H_e$
<i>M. alba</i>	Mulstr2	19	5	0.703	0.842
	Mulstr4	19	5	0.4278	0.3889
	Mulstr6	19	8	0.8051	0.8421
<i>M. rubra</i>	Mulstr2	29	6	0.6697	0.7931
	Mulstr4	29	6	0.6739	0.5862
	Mulstr6	29	6	0.5154	0.4483
All loci				0.718	0.6424
<i>M. alba</i> (all)				0.6452	0.6910
<i>M. rubra</i> (all)				0.6196	0.6091