

CONSTRUCTION AND OPERATION OF AN
ELECTRON MICROSCOPE

by

WALTER RAYMOND GUSTAFSON

B. S., Kansas State College
of Agriculture and Applied Science, 1936

A THESIS

submitted in partial fulfillment of the
requirements for the degree of

MASTER OF SCIENCE

Department of Physics

KANSAS STATE COLLEGE
OF AGRICULTURE AND APPLIED SCIENCE

1939

Docu-
ment
LD
2668
T4
1939
G-81
c. 2

TABLE OF CONTENTS

	Page
INTRODUCTION	1
MAGNETOSTATIC FOCUSING	6
Axially Symmetric Magnetostatic Fields	9
Motion of Electron in Axially Symmetric Mag- netostatic and Electrostatic Fields	12
Trajectory of Paraxial Electrons	16
Rotation of Image	18
Pure Magnetostatic Focusing	19
Thin Magnetostatic Lens	20
SIMPLIFIED DERIVATION OF FOCAL LENGTH FOR MAGNETIC LENS	24
CONSTRUCTION	28
Magnetic Lens	34
Fluorescent Screen	37
High Voltage Source	38
Vacuum System	39
Thyratron Controlled Ionization Gauge (7)	40
OPERATION	52
RESULTS	59
ACKNOWLEDGMENT	66
LITERATURE CITED	67

INTRODUCTION

Electron optics deals with the trajectories of electrons in electric and magnetic fields and considers them from the point of view of geometric optics. Although it is possible to account for these trajectories from the standpoint of electron dynamics, the former point of view is taken because of the simplification and clarification which result. This is particularly true of axially symmetric fields.

More than one hundred years ago Sir William Hamilton formulated principles which showed that there existed direct analogies between the path of a ray of light through refracting media and the path of a particle through conservative fields of force. It was with the advent of the electron that these principles were shown to be correct. It has been in the last decade that these principles have been fully developed and expanded into the subject of electron optics.

As an introduction to the study of an electron microscope, it seemed advisable to begin with a survey of the field of electron optics of which the electron microscope is a part. An article written by Leaver (13) was followed.

SURVEY OF ELECTRON OPTICS

Since the publication of a paper by De Broigle in 1925, stating that matter was wave-like in character, numerous investigations have been made concerning the refraction, reflection, and diffraction of matter. Due to the work of Thomson, Davisson, Germer, (Meyer 17, p.363) and others, it has been found that matter possesses all of these properties.

Just as light is refracted when it passes through a region having a high refractive index, so electrons are refracted when they pass through a region of varying electrostatic or magnetic fields. In fact, electrode systems can be easily constructed which diverge or converge beams of electrons just as lenses diverge or converge beams of light. The exact action of an electrode system depends upon its arrangement and upon the potentials that are applied to its various components. For example, if a beam of electrons passes through a small aperture in a large disc, it will be converged if the electrostatic field on the emergent side of the aperture is more positive than the electrostatic field on the incident side, while the beam will be diverged if the field is less intense or negative. Systems of rings or cylinders or a magnetic field such as that formed by a

coil carrying direct current which is placed about the beam, act as converging lenses always, irrespective of the potentials applied or, in the case of the magnetic field, the direction of the current flow.

Just as optical lenses form optical images of a source of light, so electron optical lenses form electron images of a source of electrons. This electron image can be converted into an optical image by placing a fluorescent screen in the image plane. The electron optical images may be many times smaller or many times larger than the source of electrons. Magnifications have been obtained by Ruska (10, 11, 12, 19, 20) which are as large as 12,000 times, while a magnification of 250 is quite easy to realize. Borries and Ruska (1) have constructed a new two-stage electron microscope which is capable of magnifying 30,000 times. Using this instrument they made a photograph of Staphylococcus aureus at a magnification of 20,400, part of which was enlarged to 100,000 times. They also took pictures of a number of common bacilli (2) which showed the superiority of the electron optical system over the optical system.

The parallel between the two systems can be still further extended. The various aberrations such as spherical aberration, coma, astigmatism, and distortion have exact

counterparts in electron optical systems (Maloff 15, p.124). Up to the present time, however, it has not been possible to compensate for these aberrations so adeptly as has been done in optics. Like the designer of optical equipment, the designer of electron optical systems tries to minimize the aberrations as much as possible and then uses a stop or diaphragm to limit the aperture of the lens. Our present knowledge only allows the design of electron lenses with comparatively small usable portions.

Due to the fact that electrons are negatively charged, they mutually repel one another. This introduces an aberration known as space charge (Maloff 15, p.133) which has no counterpart in optics. This aberration due to accumulation of electrons increases with the number of electrons and their proximity. For this reason electron lenses are usually of the accelerating type, so that electrons are removed as fast as possible and the space charge density kept low.

Electron optical systems possess fundamental advantages which far outweigh the limitations found in present day use. One of these advantages is found in the high resolving power (18). Since the ability of an instrument to resolve two objects varies inversely as the wave length, the high resolving power is seen to be true due to the infinitesimal

wave length of an electron. Although this is purely theoretical, electron optical apparatus has shown this at least to be partly true. Thus, the structure of metals can be examined to a degree impossible by other means. The metal can be made to emit electrons or can reflect electrons from another source and then, when focused properly, be made to form an image on a fluorescent screen. If the electrons are emitted by the metal, they are known as "primary electrons" but if they are emitted as a result of bombardment from another source, they are known as "secondary electrons".

In addition to this, electron optical apparatus can act as a frequency converter, for if infra-red or ultra-violet light from some object is allowed to fall upon a photo-sensitive surface, electrons will be emitted. If these electrons are focused by an electron lens upon a fluorescent screen, an image of the object will be reproduced. Thus, invisible light has been converted into the visible range. The color of the emitted light will vary somewhat with the fluorescent material on the screen. (It was interesting to note that where some apiezon oil had seeped through onto our screen, the color was blue, whereas the normal color was green.)

One of the chief uses of electron optics is found in

modern television (15). Every receiver and transmitter makes use of these principles. The tubes used in these instruments, as well as in the oscillograph, are only miniature electron microscopes. In most practical cases, the size of the image in the receiving (cathode ray) tube is limited by aberration rather than the refractive power of the electron lens.

In order to completely determine the properties of an electron lens, it is necessary to know the distribution of potential in the tube. Since this is difficult to do theoretically, it is done experimentally. The results are expressed in a graph known as an equipotential line plot. The same general theory applies to both electrostatic and magnetic fields. However, in the case of an electrostatic field, the motion is along the lines of force while in the magnetic field, it is perpendicular to the lines of force.

Due to the relative simplicity of construction, a magnetic lens system was used in our work in preference to an electrostatic system.

MAGNETOSTATIC FOCUSING

When a direct current is passed through an accurately wound coil having axial symmetry, an axially symmetric magnetostatic field is produced. The action of this type of

field upon an electron is known as magnetostatic focusing. In general, magnetostatic focusing may be accomplished by either long or short coils (Maloff 15, p.150). When the coil is thin, it is known as a short coil, otherwise as a long coil. Figure 3, Plate VII, shows a magnetostatic focusing system using a short coil. Figure 4 in the same plate shows the action of a long coil. Since the theory of the focusing action of a long coil is relatively simple, it will serve as an introduction to the study of the short coil. In Fig. 4, the dots and crosses represent the current in the coil, while the horizontal lines represent the constant magnetic field due to this current. It is now necessary to consider the action of the magnetostatic field upon an electron with a velocity v making an angle α with the field. There will be a component of velocity $v \cos \alpha$ parallel to the field and a component $v \sin \alpha$ perpendicular to the field. It is only the perpendicular component that is affected by the magnetic field, the result being the same as if the parallel component were absent.

The perpendicular component $v \sin \alpha$ tends to make the electron follow a circular path, which would be the case if the parallel component $v \cos \alpha$ were completely absent. However, the presence of the parallel component causes the electron to follow a helical path. Now, by Newton's third

law, the centrifugal force of the electron must be equal and opposite to the radial component of the force due to the magnetic field.

$$\frac{M (v \sin \alpha)^2}{R} = H e (v \sin \alpha) \quad (1)$$

Consequently, the radius R of the circle is

$$R = \frac{v \sin \alpha}{e/m H} \quad (2)$$

where H is the strength of the magnetic field. The time taken by the electron in describing the circle is

$$T = \frac{2 \pi R}{v \sin \alpha} = \frac{2 \pi m v \sin \alpha}{e H v \sin \alpha} = \frac{2 \pi}{e/m H} \quad (3)$$

From this equation, it is seen that the time is independent of v , α , or R and depends only on H , so that for a given H the time taken for any electron in describing a circle is the same.

We may consider the case in which electrons are issuing from a point source on the axis through the coil. If the angles which the electrons make with the magnetic field are small, their cosines may be placed equal to one, and the parallel component $v \cos \alpha$ becomes v . From this it is seen that electrons issuing from a point source have the same velocity v along the lines of force as well as different small speeds $v \sin \alpha$ normal to the lines of force. It has been shown that the time taken for all the electrons in

describing their various circles is the same, so at a distance

$$l = Tv = \frac{2\pi v}{\frac{e}{m} H} \quad (4)$$

from the source, the electrons will meet again. Consequently, l is the distance between the object and the image. From the equation it is seen that l is directly proportional to v and inversely proportional to H . Since the image size is equal to the object size, the magnification is unity. The image is also upright.

In case the angle α is not sufficiently small to justify its cosine being set equal to one, the $\cos \alpha$ may be expanded into a series, then

$$l = Tv \cos \alpha \left(1 - \frac{\alpha^2}{2} + \dots \right) \frac{2\pi v}{\frac{e}{m} H} \quad (5)$$

In this case the lens has longitudinal spherical aberration and all the electrons emitted from one point on the object do not meet at the same point on the image.

Axially Symmetric Magnetostatic Fields

Just as electrostatic fields may be uniquely described by means of a scalar potential, so may magnetostatic fields be described by means of a vector potential provided there are no currents present. In order to describe a magnetostatic field due to currents, it is necessary to introduce

a vector potential A , defined by the following relations
(Slater and Frank 21, p.231; Mason and Weaver 16, p.201)

$$\begin{aligned}\bar{H} &= \text{Curl } \bar{A} \\ 0 &= \text{div } \bar{A}\end{aligned}\quad (6)$$

where \bar{H} is the strength of the magnetic field. The components of H in cylindrical coordinates are

$$\begin{aligned}H_r &= \text{Curl}_r \bar{A} = \frac{1}{r} \left(\frac{\partial A_z}{\partial \theta} - \frac{\partial (r A_\theta)}{\partial z} \right) \\ H_z &= \text{Curl}_z \bar{A} = \frac{1}{r} \left(\frac{\partial (r A_\theta)}{\partial r} - \frac{\partial A_r}{\partial \theta} \right) \\ H_\theta &= \text{Curl}_\theta \bar{A} = \left(\frac{\partial A_r}{\partial z} - \frac{\partial A_z}{\partial r} \right)\end{aligned}\quad (7)$$

In case of axial symmetry

$$A_r = A_z = \frac{\partial A_\theta}{\partial \theta} = 0$$

and eq. (7) becomes

$$\begin{aligned}H_r &= -\frac{1}{r} \frac{\partial (r A_\theta)}{\partial z} \\ H_z &= \frac{1}{r} \frac{\partial (r A_\theta)}{\partial r} \\ H_\theta &= 0\end{aligned}\quad (8)$$

From Maxwell's field equations

$$\text{Curl } \bar{H} = \frac{-4\pi \bar{u}}{c}\quad (9)$$

combining (6) and (9)

$$\text{Curl } \text{Curl } \bar{A} = \frac{-4\pi \bar{u}}{c}\quad (10)$$

It can readily be proved that

$$\text{Curl Curl } \bar{A} = \text{grad div } \bar{A} - \nabla^2 \bar{A} = -\frac{4\pi\bar{u}}{c} \quad (11)$$

and since the $\text{div } \bar{A} = 0$, equation (11) becomes

$$\nabla^2 \bar{A} = -\frac{4\pi\bar{u}}{c} \quad (12)$$

In the electron microscope tube the only currents are those due to the accelerated electrons and these are negligible so that \bar{u} is equal to zero.

$$\nabla^2 \bar{A} = 0 \quad (13)$$

In cylindrical coordinates this equation becomes

$$\frac{1}{r} \frac{\partial}{\partial r} \left(r \frac{\partial \bar{A}}{\partial r} \right) + \frac{1}{r^2} \frac{\partial^2 \bar{A}}{\partial \theta^2} + \frac{\partial^2 \bar{A}}{\partial z^2} = 0 \quad (14)$$

When equation (14) is subjected to the conditions of axial symmetry, it is

$$\frac{\partial^2 A_e}{\partial r^2} + \frac{\partial^2 A_e}{\partial z^2} + \frac{\partial}{\partial r} \left(\frac{A_e}{r} \right) = 0 \quad (15)$$

A_e , being an odd function of r , may be expanded into the series

$$A_e = r f_1(z) + r^3 f_3(z) + r^5 f_5 + \dots \quad (16)$$

After differentiating this series, placing the results into equation (15) and equating the coefficients of equal powers of r to zero,

$$f_3 = -\frac{f_1''}{2 \cdot 4}; f_5 = \frac{f_1^{(4)}}{2 \cdot 4 \cdot 2 \cdot 6}; \dots \quad (17)$$

Then equation (16) becomes

$$A_{\theta}(r, z) = r f_1(z) - \frac{r^3}{2 \cdot 4} f_1''(z) + \frac{r^5}{2 \cdot 4 \cdot 2 \cdot 6} f_1^{(4)}(z) \dots \quad (18)$$

From the expression (8) for the cylindrical components of the magnetic field and equation (18) it follows that

$$H_z(r, z) = \frac{1}{r} \frac{\partial}{\partial r} (r A_{\theta}) \quad (19)$$

and on the axis

$$H_z(0, z) = 2 \quad (z)$$

where H_z is the strength of the magnetic field along the axis.

Then equation (18) may be written as

$$A_{\theta}(r, z) = \frac{r}{2} H(z) - \frac{r^3}{2 \cdot 4} H''(z) + \frac{r^5}{2 \cdot 4 \cdot 2 \cdot 6} H^{(4)}(z) \dots \quad (20)$$

Motion of Electron in Axially Symmetric Magnetostatic and Electrostatic Fields

By the Lorentz law, an electron in a magnetic field moving with a velocity \vec{v} , experiences a force which is equal to the product of the charge, velocity, strength of magnetic field, and sine of the angle between \vec{v} and \vec{H} . The force will be directed along a line perpendicular to the

plane of \bar{v} and \bar{H} .

$$\bar{F} = m \bar{a} = -e(\bar{v} \times \bar{H}) \quad (21)$$

Where \bar{F} is the force, \bar{a} is the acceleration and $\bar{v} \times \bar{H}$ is the vector product of \bar{v} and \bar{H} . When an electrostatic field is present, equation (21) becomes

$$\bar{F} = m \bar{a} = -e \left(-\text{grad } v + (\bar{v} \times \bar{H}) \right) \quad (22)$$

In case of axial symmetry and components written in cylindrical coordinates equation (22) is

$$\begin{aligned} A_r &= \frac{1}{r} - r \dot{\theta}^2 = -\frac{e}{m} \left(\dot{\theta} \frac{\partial}{\partial r} (r A_\theta) - \frac{\partial v}{\partial r} \right) \quad a. \\ A_z &= \frac{1}{r} = -\frac{e}{m} \left(\dot{\theta} \frac{\partial}{\partial z} (r A_\theta) - \frac{\partial v}{\partial z} \right) \quad b. \\ A_\theta &= \frac{1}{r} \frac{d}{dt} (r^2 \dot{\theta}) = -\frac{e}{m} \left(-\frac{1}{r} \frac{d}{dt} (r A_\theta) \right) \quad c. \end{aligned} \quad (23)$$

Equation (23c) integrates into

$$r^2 \dot{\theta} = \frac{e}{m} r A_\theta + C \quad (24)$$

and since $A_\theta = 0$ when $r = 0$; $C = 0$; then

$$r^2 \dot{\theta} = \frac{e}{m} r A_\theta \quad (25)$$

Combining equation (25) with (23a) and (23b) there results the following equations of motion

$$r'' = \frac{e}{m} \frac{\partial}{\partial r} \left(v - \frac{1}{2} \frac{e}{m} A_\theta^2 \right)$$

$$\psi = \frac{e}{m} \frac{\partial}{\partial z} \left(V - \frac{1}{2} \frac{e}{m} \Lambda^2 e \right) \quad (26)$$

It is now necessary to determine the potential distribution of an electrostatic field. This is done by finding the proper solution of:

$$\nabla^2 V = 0 \quad (27)$$

When written in cylindrical coordinates this becomes:

$$\nabla^2 V = \frac{1}{r} \frac{\partial}{\partial r} \left(r \frac{\partial V}{\partial r} \right) + \frac{1}{r^2} \frac{\partial^2 V}{\partial \theta^2} + \frac{\partial^2 V}{\partial z^2} \quad (28)$$

Due to axial symmetry $V(\theta) = C$; $\frac{1}{r^2} \frac{\partial^2 V}{\partial \theta^2} = 0$

and there results

$$\begin{aligned} \frac{1}{r} \frac{\partial}{\partial r} \left(r \frac{\partial V}{\partial r} \right) + \frac{\partial^2 V}{\partial z^2} &= 0 \\ \frac{\partial^2 V}{\partial r^2} + \frac{1}{r} \frac{\partial V}{\partial r} + \frac{\partial^2 V}{\partial z^2} &= 0 \end{aligned} \quad (29)$$

Now let $V(r, z)$ be the required solution. Then owing to axial symmetry $V(r, z)$ can be expanded into an infinite series containing only even powers of r ;

$$V(r, z) = V_0(z) + r^2 V_2(z) + r^4 V_4(z) + \dots + r^{2n} V_{2n}(z) \quad (30)$$

Differentiating equation (30), substituting in equation (29) and equating the coefficients of equal powers of r to zero,

there results:

$$\begin{aligned}
 V(r, z) = & V_0(z) - \frac{r^2}{2^2} V_0''(z) + \frac{r^4}{2^2 \cdot 4^2} V_0^{(4)}(z) \\
 & + \dots + \frac{(-1)^n r^{2n}}{2^2 \cdot 4^2 \cdot \dots \cdot (2n)^2} V_0^{2n}(z) + \dots
 \end{aligned} \tag{31}$$

Where the primes and superscripts in parenthesis indicate differentiation with respect to (z) .

Inserting the expansion for V given in equation (31) along with the expansion for A_θ given in equation (16) into equation (26) it follows that

$$\begin{aligned}
 \ddot{r} = & -\frac{e}{m} \left[\frac{r}{2} \left(V'' + \frac{1}{2} \frac{e}{m} H^2 \right) - \frac{r^3}{2^2 \cdot 4} \left(V^{(4)} + 2 \frac{e}{m} H H'' \right) + \dots \right] \\
 \dot{z} = & \frac{e}{m} \left[V' - \frac{r^2}{2^2} \left(V''' + \frac{e}{m} H H' \right) + \dots \right]
 \end{aligned} \tag{32}$$

When an electron is moving in combined axially symmetric electrostatic and magnetostatic fields, the equations of motion of the electron are given by equation (32). The superscripts in these equations represent the various orders of derivatives with respect to z . H represents the component of the magnetic field along the z axis, while V represents the electrostatic potential along the same axis.

Trajectory of Paraxial Electrons

For paraxial electrons it is assumed that their distances r from the axis and their inclination $\frac{dr}{dz}$ toward the axis are so small that the second and higher powers of r and $\frac{dr}{dz}$ are negligible.

Then equations (32) reduce to,

$$\ddot{r} = \frac{d^2 r}{dt^2} = -\frac{e}{m} \frac{r}{Z} \left(V'' + \frac{1}{Z} \frac{e}{m} H^2 \right) \quad (33)$$

$$\ddot{z} = \frac{d^2 z}{dt^2} = \frac{e}{m} V' \quad (34)$$

Now, the kinetic energy of an electron is equal to the product of its charge by the potential which is necessary to give the electron a velocity v

$$\frac{mv^2}{2} = e V \quad (35)$$

This may be written as

$$\frac{m}{2} \left[\left(\frac{dz}{dt} \right)^2 + \left(\frac{dr}{dt} \right)^2 \right] = \frac{m}{2} \left(\frac{dz}{dt} \right)^2 \left[1 + \left(\frac{dr}{dz} \right)^2 \right] = e V \quad (36)$$

Also

$$\begin{aligned} \frac{d^2 r}{dt^2} &= \frac{d}{dt} \frac{dr}{dt} = \frac{dz}{dt} \frac{d}{dz} \frac{dr}{dz} \frac{dz}{dt} \\ &= \frac{dz}{dt}^2 \frac{d^2 r}{dz^2} + \frac{dr}{dz} \frac{dz}{dt} \frac{d}{dz} \frac{dz}{dt} \end{aligned} \quad (37)$$

$$\frac{d^2z}{dt^2} = \frac{d}{dt} \frac{dz}{dt} = \frac{dz}{dt} \frac{d}{dz} \frac{dz}{dt} \quad (38)$$

substituting (38) in (37)

$$\frac{d^2r}{dt^2} = \left(\frac{dz}{dt}\right)^2 \frac{d^2r}{dz^2} + \frac{dr}{dz} \frac{d^2z}{dt^2} \quad (39)$$

Solving for $\left(\frac{dz}{dt}\right)^2$ and substituting in (36)

$$\frac{\frac{d^2r}{dt^2} - \frac{dr}{dz} \frac{d^2z}{dt^2}}{\frac{d^2r}{dz^2}} = \frac{2 \frac{e}{m} V}{1 + \left(\frac{dr}{dz}\right)^2} \quad (40)$$

$$\frac{d^2r}{dt^2} = \frac{2 \frac{e}{m} V}{1 + \left(\frac{dr}{dz}\right)^2} \frac{d^2r}{dz^2} + \frac{dr}{dz} \frac{d^2z}{dt^2} \quad (41)$$

Substituting (33) and (34) into (41), and noting that for paraxial electrons $\left(\frac{dr}{dz}\right)^2 = 0$

$$-\frac{e}{m} \frac{r}{z} \left(V'' + \frac{1}{z} \frac{e}{m} H^2 \right) = 2 \frac{e}{m} V \frac{d^2r}{dz^2} + \frac{dr}{dz} \frac{e}{m} V' \quad (42)$$

$$2V \frac{d^2r}{dz^2} + \frac{dr}{dz} V' + \frac{r}{z} \left(V'' + \frac{1}{z} \frac{e}{m} H^2 \right) = 0 \quad (43)$$

Differentiating the expansion for V as given in equation (31) and neglecting terms containing powers of r higher than the first

$$V' = \frac{\partial V}{\partial z} = V'(z) \quad (44)$$

$$\frac{d^2 r}{dz^2} + \frac{V'}{2V} \frac{dr}{dz} + \frac{r}{4V} \left(V'' + \frac{1}{2} \frac{e}{m} H^2 \right) = 0 \quad (45)$$

Since this equation is linear, if any two linearly independent solutions $r_1(z)$ and $r_2(z)$, corresponding to two electron trajectories, are known, then any other trajectory may be determined by the relations

$$r(z) = c_1 r_1(z) \text{ and } c_2 r_2(z) \quad (46)$$

Consequently, the focusing action of the combined electrostatic and magnetostatic fields may be determined by solving equation (45).

Rotation of Image

Since θ was eliminated in deriving equation (26), equation (45) really represents the equation for the trace of the paraxial electron trajectory on the r - z plane through the electron. At this point it should be recalled that the actual trajectory of a paraxial electron approximates that of a helix. Consequently, magnetic focusing rotates the image.

From (20) and (25) it follows that

$$\dot{\theta} = z \frac{d\theta}{dz} = \frac{e}{m} \frac{\Lambda e}{r} = \frac{e}{m} \left[\frac{H}{Z} - \frac{r^2}{2Z^2} H'' + \dots \right] \quad (47)$$

For a paraxial electron

$$\frac{d\theta}{dz} = \frac{e}{m} \frac{1}{(2 e m H)^{\frac{1}{2}}} \frac{H}{Z} = \frac{1}{Z} \left(\frac{e}{2m} \right)^{\frac{1}{2}} \frac{H}{V^{\frac{1}{2}}}$$

Then

$$\theta = \frac{1}{Z} \frac{e}{2m} \frac{1}{2} \int_{z_1}^{z_2} \frac{H(z)}{(V(z))^{\frac{1}{2}}} dz \quad (49)$$

Where the limits of the integral represent the region of $H(z)$.

For a given magnetic field and electrostatic potential θ is constant and so is the same for all paraxial electrons. The image is rotated through the angle θ , and is not distorted.

Pure Magnetostatic Focusing

When the electron moves in a pure magnetostatic field, V is constant and by equation (35), is proportional to the square of the constant velocity with which the electron traverses the field. Consequently, after setting $V = V_0$ (a constant), equation (45) becomes

$$\frac{d^2 r}{dz^2} + \frac{e}{8m} \frac{H^2}{V_0} r = 0 \quad (50)$$

This is the differential equation of the trace of an electron's paraxial trajectory in a pure magnetostatic field. As before, the trace is in the r - z plane through the electron in an axially symmetric field.

The optical properties of the lens are determined by solving equation (50) for the electron trajectories.

Now, since $V = V_0$, equation (49) becomes

$$\theta = \frac{1}{2} \left(\frac{e}{2m V_0} \right)^{\frac{1}{2}} \int_{z_1}^{z_2} H(z) dz \quad (51)$$

where θ is the angle through which the image is rotated.

Thin Magnetostatic Lens

In this case $H(z)$, the component of the magnetic field along the z axis, is different from zero for only a narrow region so that r may be placed equal to r_0 (a constant) in this region.

Let

$$P = \frac{1}{r_0} \frac{dr}{dz} \quad (52)$$

then equation (50) reduces to

$$\frac{dP}{dz} + \frac{e}{2m} \frac{H^2}{V_0} = 0$$

Let the magnetostatic field be confined to a narrow range

$a \leq b$, then integrating between these limits

$$P_b - P_a = - \frac{e}{8\pi V_0} \int_a^b H^2 dz \quad (53)$$

To find the focal length, consider an electron in the object space $z = a$ moving parallel to the axis at a distance r_0 from the axis, then at a , the slope is zero and it follows from equation (52) that P_a is also zero. At b the electron issues from the lens still at the distance r_0 from the axis but with the slope $r'(b)$; then

$$P_b = \frac{1}{r_0} r'(b) \quad (54)$$

From the geometry of the trajectory, it is seen that $r'(b)$ is equal to r_0/f and

$$R_b = \frac{1}{f} \quad (55)$$

Then equation (53) becomes

$$\frac{1}{f} = \frac{e}{8\pi V_0} \int_a^b H^2 dz \quad (56)$$

where f is the focal length of the lens.

Equation (56) may be written

$$\frac{1}{f} = \frac{.022}{V} \int_a^b H^2 dz \quad (57)$$

where V is in volts and H is in gauss.

From equation (57) it is seen that a magnetostatic lens is independent of the sign of $H(z)$ and consequently, convergent for current flowing in either direction through the focusing coil. In the course of our investigation this was found to be true experimentally.

For a thin magnetostatic lens, it follows from equation (51) that

$$\theta = \frac{1}{2} \left(\frac{e}{2mV} \right)^{\frac{1}{2}} \int_a^b H \, dz = \frac{.15}{V} \int_a^b H \, dz \quad (58)$$

In the right-hand term V is in volts and H is in gauss.

From the preceding equations it is seen that the characteristics of a thin magnetostatic lens are determined when H , the z component of the magnetostatic field along the axis, is known. H can usually be calculated when there is no iron in the coil. The intensity of the magnetic field on the axis of a circular turn of wire is

$$H = \frac{2\pi R^2 I}{(z^2 + R^2)^{3/2}} \quad (59)$$

where R is the radius of the circle, z is the distance along the z axis, and I is the current flowing in the wire.

The field on the axis of a square coil is given by

$$H = \frac{ni}{2bd} \left[(z + b) \log \frac{(a + d) + \left((z + b)^2 + (a + d)^2 \right)^{\frac{1}{2}}}{(a - d) + \left((z + b)^2 + (a - d)^2 \right)^{\frac{1}{2}}} \right. \\ \left. - (z - b) \log \frac{(a + d) + \left((z - b)^2 + (a + d)^2 \right)^{\frac{1}{2}}}{(a - d) + \left((z - b)^2 + (a - d)^2 \right)^{\frac{1}{2}}} \right] \quad (60)$$

where a is the mean radius and bd is the square cross-sectional area of the coil.

When it is desired to approximate a thin coil as closely as possible, the magnetic field must be confined to as narrow a range as possible. This is accomplished by partially surrounding the coil with iron. In this case H is determined by measurement.

The foregoing discussion makes no attempt to take into consideration the variation of the mass of the electron with velocity. However, these equations have been developed from the viewpoint of relativistic physics by Wallauschek and Bergman (22). Usually the velocities of the electrons never exceed one-tenth that of light. In this case the error introduced by the variation of mass with velocity can be neglected.

SIMPLIFIED DERIVATION OF FOCAL LENGTH
FOR MAGNETIC LENS

Bowers (4) has brought out the fact that the introduction of a vector potential and the complication of an electric field does not show a clear picture of the phenomenon. The following treatment explains in a more elementary manner the convergence of electrons by means of a short coil, calculation of the focal distance of such a coil and also the resulting rotation round the axis. The consideration is similar to that which has been applied for deriving a simple formula for the focal distance in an axial symmetrical field (3,6).

Figure 1, Plate VII shows a diagram of the path of an electron entering a short magnetic lens. The electron has a speed v parallel to the axis and a small radial velocity $v \sin \alpha$. The resultant motion of the electron is a helix which has already been discussed.

As in the previous discussion, paraxial rays are considered so that r_0 is small and since the variation in distance from the axis is assumed negligible, the coil is a thin one.

Now, referring to Fig. 2, Plate VII, let A_2B_2 and A_1B_1 be two similar cross-sections perpendicular to the z axis,

passing through z_1 , and z_2 . (In the drawing the x 's should be z 's). The difference in the number of magnetic lines of force passing through the two sections is $\pi r^2 (H_2 - H_1)$. However, this is the number of lines of force that penetrate the cylinder wall with the surface $\pi h (z_2 - z_1)$. Consequently the mean value of the radial magnetic field is

$$H_r = \frac{r (H_2 - H_1)}{2 (z_2 - z_1)} \quad (61)$$

For an infinitely small distance on the z axis this equation becomes

$$H_r = \frac{r}{2} \frac{dH_z}{dz} \quad (62)$$

Due to this radial magnetic field, an electron which has a component of velocity v parallel to the axis at a distance r from the axis, is acted upon by a force

$$F_v H_r = ev H_r \quad (63)$$

The force due to the radial component of velocity and H_z may be neglected to a first approximation. The acceleration along the z axis is

$$\ddot{S}_z = \frac{F}{m} = \frac{ev H_r}{m} = \frac{evr}{2m} \frac{dH_z}{dz} \quad (64)$$

after placing $dz = v dt$ and integrating between $-\infty$ and z there results

$$\dot{s} = \frac{er}{2m} H_z \quad (65)$$

Since $\dot{s} = r \dot{\theta}$ it follows that

$$\dot{\theta} = \frac{e}{2m} H_z \quad (66)$$

From this equation it is seen that the angular speed of the electron is proportionate to the component of the magnetic field along the z axis.

Substituting $dt = \frac{dx}{v}$ in equation (66) and integrating between infinite limits, there results

$$\theta = \frac{e}{2mv} \int_{-\infty}^{\infty} A_z dz \quad (67)$$

where θ is the angular rotation of the image around the z axis. This formula agrees with equation (58) in the previous discussion and is the same as that derived by Busch (5).

When the electron moves at a constant distance r from the axis, the centrifugal force must be equal to the force $H_z e \dot{s}$ produced by the axial magnetic field and the lateral speed. Therefore

$$\frac{m\dot{s}^2}{r} = H_z e \dot{s} = F \quad (68)$$

Substituting the value of \dot{s} from equation (65) into

equation (68) there results

$$F = \frac{h}{r} \left(\frac{eF}{2m} H_z \right)^2 = \frac{e^2 F}{4m} H_z^2 \quad (69)$$

After combining (68) and (69) it follows that

$$\ddot{r} = \frac{e^2 F}{4m^2} H_z^2 \quad (70)$$

Placing $dt = \frac{dx}{v}$ in (70) and integrating between infinite limits

$$\dot{r} = -\frac{vF}{a} + \frac{e^2 F}{4m^2 v} \int_{-\infty}^{\infty} H_z^2 ds \quad (71)$$

where \dot{r} is the inward speed. The electron will then meet the axis after a time

$$T = \frac{r}{\dot{r}} \quad (72)$$

When the electron enters the coil parallel to the axis a is infinite, the path vT is the focal length. Then

$$f = vT = \frac{vF}{\dot{r}} = \frac{4m^2 v}{e^2 H_z^2} \quad (73)$$

and

$$\frac{1}{f} = \frac{e^2}{4m^2 v} \int_{-\infty}^{\infty} H_z^2 ds \quad (74)$$

which is comparable to equation (56).

CONSTRUCTION

A frame structure of wood, as shown in Plate I was first constructed. This served as a base for mounting the tube, panels, and other equipment necessary for the operation of an electron microscope.

A cenco hvvac forepump was mounted on No. 8 rubber stoppers to prevent vibrations from injuring the glass diffusion pump, and placed on shelf b.

Two storage batteries which furnished the cathode voltage were placed on shelf c. An ammeter and variable carbon resistance were connected in series with the storage batteries and served as a means of controlling the heating current of the cathode.

The high voltage apparatus for maintaining a difference of potential between the copper tube and filament was mounted on shelf a. On this shelf were also mounted supports for the dry ice trap, diffusion pump cooling fan, and apparatus for controlling and furnishing heat for the pump. This consisted of a small hot plate placed below the diffusion pump boiler, an ammeter, and sliding wire-wound resistance.

Plate II shows a detailed drawing of the electron microscope tube. The tube and fittings were all extra heavy

EXPLANATION OF PLATE I

Basic structure for supporting apparatus.

Panel a. Position for switch panel.

Panel b. Position for thyatron panel.

Shelf a. High voltage platform.

Shelf b. Fore pump location.

Shelf c. Storage battery location for
cathode.

Plate I

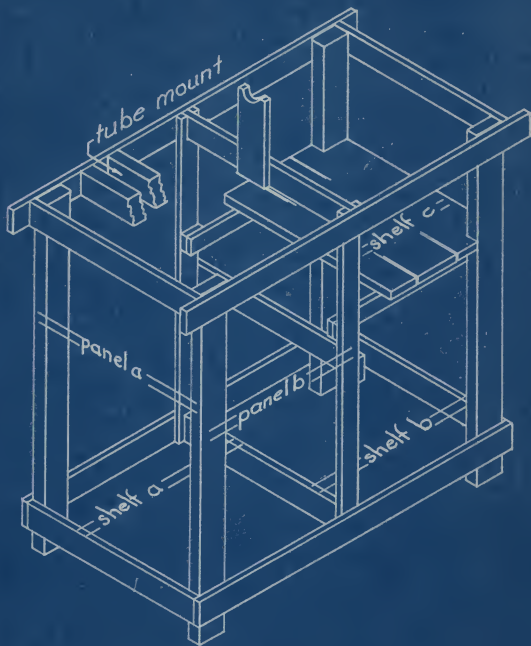

Scale - 1" = 1'

EXPLANATION OF PLATE II

Diagram of electron microscope tube showing position of fluorescent screen, electron gun, and tube support.

Detailed drawing of electron gun.

- A and B. Glass tube.
- C. Copper cylinder.
- D. Copper disc.
- F. Tungsten ground rods.
- P. Platinum strip.

Plate II

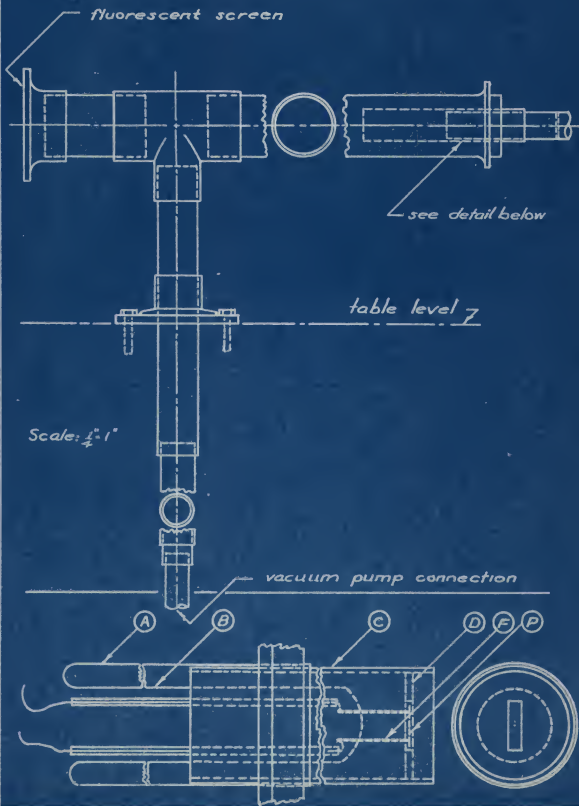

copper. The walls were one-sixteenth inch thick. A reducing tee was used on the main tube into which was run a smaller copper tube for connecting to the diffusion pump. A flange was turned down to allow this side tube to pass through, and fastened to the table to serve as a support for the main tube. Another flange was put on the end of the main tube, separated by a short piece of tube from the tee. This was the flat base to which the fluorescent screen could be sealed with wax.

All copper to copper connections were heated and well sealed with solder. The arrangement was found to be very satisfactory, both from the standpoint of rigidity and ability to hold a vacuum.

In the smaller drawing of Plate II is shown a diagram of the electron gun. A glass tube B was sealed at one end with two small tungsten rods. The other end was then sealed inside a larger and somewhat shorter glass tube A. Copper wires had been previously spot welded to the tungsten rods to serve as lead in wires. A narrow piece of platinum, which served as a carrier for the electron emitting material, was spot welded between the two tungsten rods.

In order to eliminate as much as possible, stray electrostatic lines of force, a copper cylinder C was in-

serted between the two glass tubes. A disc D with a slotted center was pushed into the copper tube slightly in front of the platinum strip and also helped to counteract the same effect.

The electron gun was fitted into a circular piece of brass that had been turned down to fit the main electron microscope tube. The glass tubes were sealed to the brass disc with picein wax. Since the electron gun had to be removed frequently from the apparatus, the brass disc was sealed to the main tube with apiezon sealing compound Q. This is a soft pliable wax well suited for a joint which has to be disconnected frequently.

Magnetic Lens

The magnetic lens consisted of a coil C (see Plate III) mounted on a firm wooden base A. To overcome the difficulty of making a coil with an exact central diameter the following system was used: A wooden cylinder was turned down to the desired size on a lathe. The size was such as to allow the coil to slip over the main tube of the electron microscope with a one-eighth inch clearance. A thin copper band was wound around a cylindrical band. A narrow brass annular ring was next soldered on one end of this band and two one-quarter inch pressed wood rings fitted over the band. Another narrow brass ring was then soldered

EXPLANATION OF PLATE III

Magnetic coil showing support.

- A. Wooden base.
- B. Brass uprights.
- C. Coil.
- P. Pivot.

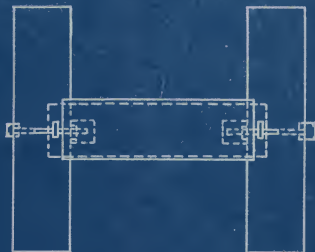
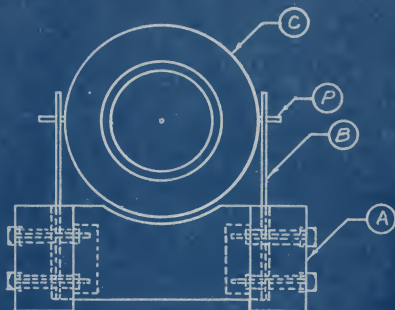

Scale $\frac{1}{8}'' = 1''$

to the other side of the band. The pressed wood pieces were next bolted to the brass rings. The finished spool was placed in a lathe, using the central wooden cylinder as a turning support. Approximately 3000 feet of No. 24 double cotton covered enameled wire was wound on the spool. The wooden cylinder was then removed and the finished coil mounted on two brass uprights in the base A. The brass upright were mounted in grooves so that the coil could be moved vertically. Axial motion was attained by means of the pivots P. The rods in the pivots were soldered to brass bands which had been bolted to the coil. The coil was then slipped over the electron microscope tube with the base on the table top. Horizontal motion along the tube was attained by moving the base.

The resistance of the coil was found to be 156 ohms.

Fluorescent Screen

The fluorescent screen consisted of a ground glass plate on which was spread willemite which had previously been pulverized as finely as possible in an iron mortar. Willemite is zinc orthosilicate with traces of manganese present. Due to the fact that an insufficiently thick layer of willemite was used, the image was not of maximum brightness. The most successful screen (14) was prepared

by placing a piece of round plate glass on the bottom of a large beaker and allowing a suspension of 200 mesh willemite in a weak solution of ammonium carbonate to settle overnight. The presence of the carbonate ions retarded the rate of settling and so produced a more uniform screen. The water was decanted slowly and the plate dried by means of a heater coil, after which it was sealed in place on the copper tube by using apiezon sealing compound Q. This screen, having a thicker layer of fluorescent material, produced much brighter images under the same conditions than the one used previously.

High Voltage Source

The voltage for furnishing the potential difference between the cathode and tube (electron accelerating potential) was obtained by rectifying the output of a step-up transformer. A diagram of the rectifying apparatus is shown in Plate V. A 110 volt transformer with a 3000 volt secondary was used. An 866 A type tube produced half-wave rectification. The filter circuit consisted of two 3000 volt oil condensers whose combined capacity was 8 microfarads. A 0-200 microammeter located on panel a (see Plate I) served as a measure of the accelerating potential. This was accomplished by connecting the meter, in series with a

10 megohm resistance across the condenser output. A rheostat, also mounted on plate a, varied the potential by controlling the transformer's output.

Vacuum System

A cenco hvac fore pump was used which was mounted on shelf b in the wooden structure shown in Plate I. In series with the pump was an oil diffusion pump obtained from the Washington University at St. Louis. The boiler on the diffusion pump was heated with a small electric hot plate. Wrapping the boiler and hot plate with one-quarter inch asbestos cord increased the efficiency of operation. A copper tube in the pump between the boiler and condenser prevented condensation of the oil before reaching the diffusion jet. This was due to the high thermal conductivity of the copper tube. The condenser of the pump was cooled by a small electric fan which operated on 110 volts A. C.

The diffusion pump was connected to the main tube of the electron microscope through a trap which was surrounded by a pyrex vacuum bottle. A mixture of dry ice and normal butyl alcohol furnished the cooling mixture which was placed in the vacuum bottle. A wooden support was placed on the trap to prevent atmospheric pressure from forcing it

into the main tube of the electron microscope.

An additional trap was placed between the diffusion pump and fore pump to catch any foreign material when letting air into the apparatus. A glass stopcock was sealed between the diffusion pump and trap to prevent air from entering the apparatus when the fore pump was not operating. Another glass stopcock was sealed on to the trap to let air in the apparatus.

The above combination has proven very satisfactory and was capable of producing a vacuum around 10^{-6} mm. of mercury.

Thyratron Controlled Ionization Gauge (7)

An open-base type ionization gauge was obtained from Western Electric. It was sealed on to the trap of the diffusion pump, directly beneath the inlet to the main electron microscope tube. It can be seen in Fig. 5.

For convenience in the operation of an ionization gauge it is desirable that a linear relationship exist between the positive ion current and the pressure of a gas. For this to be true it is necessary that K in the equation

$$P = K I_p = \frac{I_p}{I_g}$$

shall be a constant. (In this equation P is the pressure, I_p the plate current, and I_g the grid current). This re-

quires: first, that the pressure shall be below a critical value of about 10 mm., second, that

$$\frac{I_P}{E_G} = 0$$

i.e., the grid voltage should be in the broad maximum of the probability of electron ionization of the gas molecules (different for each gas; about 250-300 volts for air; not critical: 160 volts has been found satisfactory in actual operation) and third, that

$$I_G = \text{constant}$$

i.e., the grid current I_G must not change.

The gauge constant K then depends only on the physical dimensions of the tube, and is usually expressed in millimeters of mercury per ampere of positive ion current.

The grid current may be kept approximately constant by utilizing small variations in its value to control the heating current of the filament. Thus, whenever the grid current rises above the desired constant value, it increase is to be used in some manner to reduce the filament current, which, in turn, reduces the electron emission even to a point slightly lower than the normal value. The lower grid current which results is then used to increase the filament temperature and consequently, the filament

emission; after which the process repeats itself.

In the past it has been customary to use a mechanical relay to accomplish this. The necessity for adjustment of the moving parts of the relay and the noticeable fluctuations in grid current are undesirable. Jaycox and Weinhart (9) have made use of this method. It is possible to avoid these undesirable features by using a saturable core transformer, however, this is inconvenient because a special transformer must be constructed.

In the control method in our apparatus, a controlled rectifier (FG-57 thyatron) was used. The grid current I_G (Plate IV) of the ionization gauge flows through a resistor and produces an IR drop which is impressed upon the grid of A. C. operated thyatron T, controlling its plate current. This plate current which is used to heat the filament of the gauge, is altered in such a manner as to restore the grid current to its normal value. The proper constants are given on the explanation page of Plate IV. It is to be noticed that all voltages are supplied from an A. C. line.

In Plate IV the $I_G R_G$ drop serves as the small negative plate potential of the gauge G and also as the negative bias of the thyatron T. The average value of the plate current of T, and hence of the filament heating current of G, decreases whenever I_G exceeds its normal value (usually

20 ma.) and vice versa.

The potentiometer R_5 is used to adjust I_G to normal value. It was found in operation that proper constants were necessary to make R_5 critical; otherwise there was no effect upon I_G when R_5 was varied.

The gauge filament current could be changed by means of a rheostat R_2 and the use of an auxiliary resistance R_1 .

Due to the occlusion of gases, it is necessary to heat the gauge filament for a short period by using the circuit with S_7 and S_8 turned on. This prevents the current from flowing through the meters. If this is not done, large transient electron and ion currents which are given off suddenly by the gauge filament, may burn out the meters in the circuit.

EXPLANATION OF PLATE IV

Thyratron controlled ionization gauge.

S_1, S_2 , etc., S.P.S. T. toggle switches.

T_1 , transformer: secondary 220 V. (r.m.s.)
each side of center at 20 ma.

T_2 , transformer: secondary 2.5 V. at 5 amps.

I_G , 0-50 D. C. milliammeter, operated at 20 ma.

I_P , 0-100 D. C. microammeter.

I , 0-5 A. C. ammeter.

C_1 , 8 microfarad condenser.

T , thyatron FG-57.

83, mercury vapor full-wave rectifier.

R_1 , two glow coils, 20 ohms each.

R_2 , 0-5 ohms rheostat.

R_4 , 100,000 ohms, 1/2 watt.

R_5 , 500 ohms, potentiometer.

R_6 , 20 ohms, glow coil.

Ionization gauge, open base type.

Plate IV

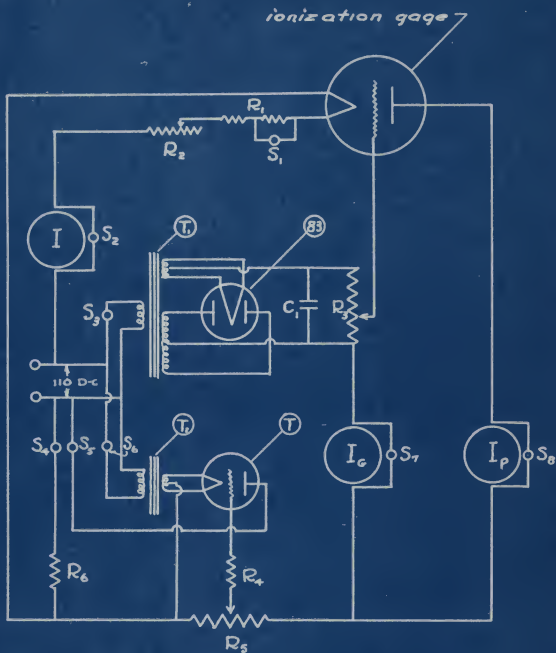

EXPLANATION OF PLATE V

Electron microscope tube showing high voltage and cathode connections.

A. 0-10 D.C. ammeter in series with a variable carbon pressure resistance.

Mu A. 0-200 D.C. Microammeter.

Plate V

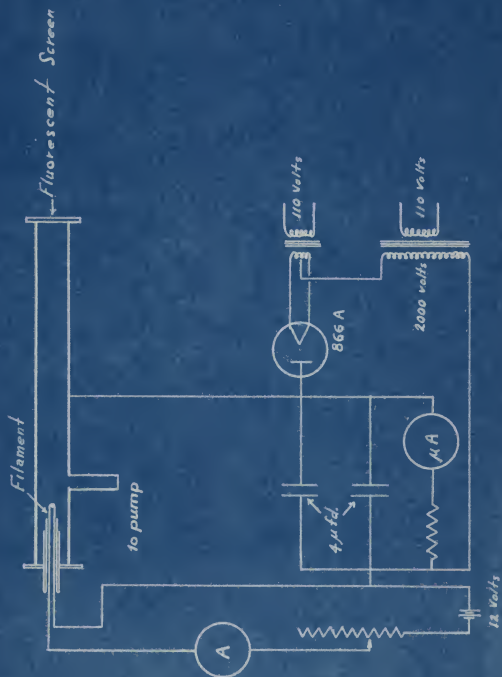

EXPLANATION OF PLATE VI

Graph relating focal length, magnification, and object-lens distance, and showing how observed points follow the curves calculated from the thin lens formula.

K is the object distance divided by the object image distance.

Plate VI

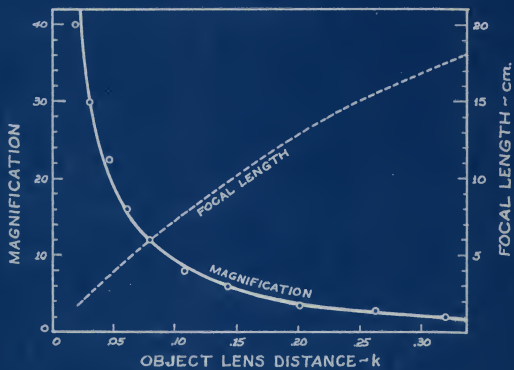

EXPLANATION OF PLATE VII

- Fig. 1. Path of an electron in a short magnetic coil.
- Fig. 2. Magnetic lines of force in a small coaxial cylinder demonstrating the relation between H_p and dH_x/dx .
- Fig. 3. Focusing with a short coil.
- Fig. 4. Focusing with a long coil.



fig 1

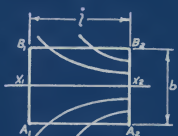

fig 2

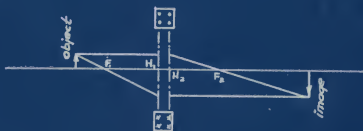

fig 3



fig 4

OPERATION

When the apparatus was completed, it appeared as shown in the various photographs of Figures 5, 6, 7, and 8. The first step in operation was to find any possible leaks in the system. Leaks in the glass were located by means of a small tesla coil and sealed with a hand torch. Fortunately there were no leaks in the metal parts. All apiezon seals were firmly worked over by moulding while picein seals were heated lightly. The pressure in the system was determined by running the fore pump and listening to the sound of the compressor. If there was no change in sound when the stopcock, between the diffusion pump and fore pump trap, was turned off and on the pressure was assumed to be low enough to eliminate the possibility of leaks. The diffusion pump was turned on and found to operate satisfactorily at 1.62 amperes.

The condenser fan was turned on and a mixture of dry ice and normal butyl alcohol placed in the vacuum bottle surrounding the diffusion pump trap.

The cathode current was next turned on to outgas the filament. The current varied from four to six amperes, depending upon the size of the platinum strip and amount of emitting material present.

The pressure was measured by the ionization gauge and if found satisfactory, the high voltage applied between the cathode and tube. A wire between the tube and water pipe served as a ground.

A greenish glow on the fluorescent screen was observed. A D. C. current, furnished by a motor generator set, was next passed through the coil. The magnetic field was varied by changing the current in the coil which was accomplished by a bank of variable wire wound resistances in series with the D. C. circuit. The voltage used was approximately 120 volts. The current, which was measured by an ammeter in the circuit could be varied from .1 to 1.5 amperes (determined by the input voltage and series resistance).

By properly adjusting the accelerating potential, position of coil, intensity of magnetic field, and cathode current, an image of the filament was observed on the fluorescent screen.

Due to the variation of the magnetic field, caused by fluctuation in the D. C. line voltage, the position of the image was not stationary. This was overcome by using a series of storage batteries in place of the voltage supplied by the generator. However, only enough storage batteries could be secured to supply 68 volts. This was considerably under the required voltage necessary to produce an image

comparable to the one previously observed. The image was smaller and less intense than before. It was found necessary to compromise between distortion and intensity of the image, resulting in a fair image of medium brightness. The resulting image was photographed using an Eastman portrait camera and portrait film. At F 4.5 an exposure of thirty seconds was found adequate.



Fig. 5. End view of electron microscope, showing ionization gauge and dry ice trap.

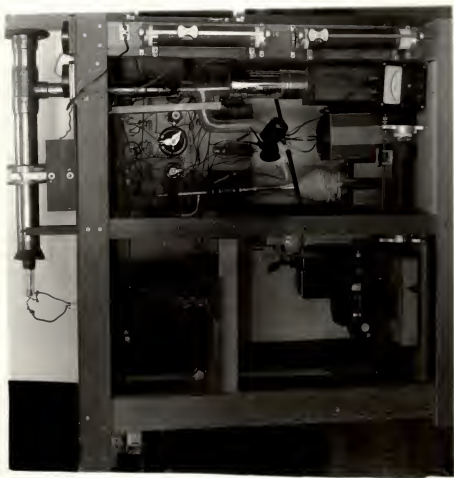

Fig. 6. Side view of electron microscope, showing how diffusion pump is connected to main tube.

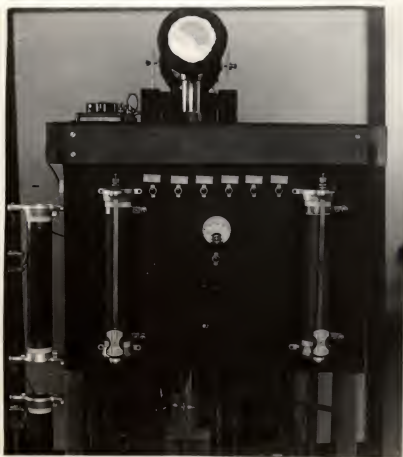

Fig. 7. End view of electron microscope with switch panel in place.

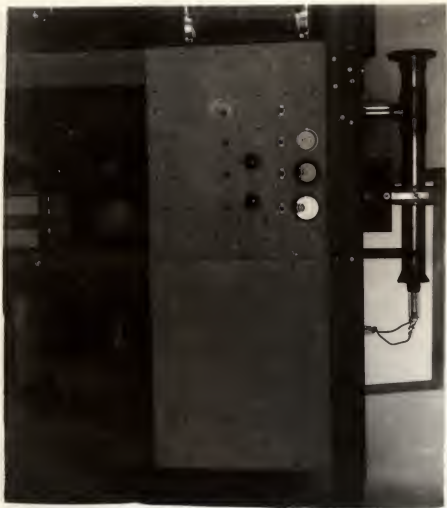

Fig. 8. Side view of electron microscope, showing panel for controlling ionization gauge.

RESULTS

The electron microscope, which was completed, gave very satisfactory results. Images of the cathode, which was covered with a thin layer of a mixture of barium and strontium carbonates, were obtained and photographed as shown in Figs. 9, 10, and 11. It was found by visual observation that the surface structure of the image corresponded to that of the object (cathode). The crater-like formations shown in the photographs of the images were used as a basis for focusing. It can be seen in these photographs that the most intense emission occurred around the edges of the craters, which was to be expected from the fact that the electrostatic lines of force tend to concentrate where the curvature is greatest. From this fact, it was concluded that an electron microscope could be used for the purpose of showing the distribution of electron emission of a surface when heated.

Due to the presence of stray fields in the tube, there was a certain amount of distortion around the edges of the image, as is shown in the figures. Since this distortion was found to increase with the intensity of the image, it was necessary to photograph at as low an intensity as possible. However, the variations in the line voltage for

the coil produced variations in the magnetic field which, in turn, caused corresponding fluctuations in the position of the image. By experiment it was found that the intensity necessary for a one-minute exposure gave the best results. For visual observation most of the distortion could be eliminated by decreasing the intensity of the image.

As has already been mentioned in the section on operation, the fluctuations in the position of the image could be eliminated by using a steady direct current. Since the voltage obtainable was not sufficiently high, the results were not very satisfactory.

It was noted that the images which had the maximum magnification were formed when the magnetic lens was as close as construction permitted, to the object end of the tube.

It was found that for every position of the lens, it was possible to obtain a good image provided the accelerating potential, cathode current, and coil voltage were properly adjusted. Since the distance from the object to the image (distance from cathode to fluorescent screen) was a constant, the object and image distances were determined for a given position of the coil. The relationship between the object distance, image distance, and focal length is given by the following equation:

$$\frac{1}{p} + \frac{1}{q} = \frac{1}{f}$$

where p is the object distance, q the image distance, and f the focal length.

As has already been shown, the focal length is a function of the magnetic field intensity and consequently, it is possible to check the above formula by measuring this intensity. In some cases it is possible to determine $H(z)$, the z component of the magnetic field, mathematically and thus determine the focal length. Although the focal length of our lens has not been determined as yet, it will probably be done before further work with the apparatus is continued.

While experimenting with our electron microscope, the very unusual fact was noted that for one particular position of the lens, all other factors being constant, the magnification was a discontinuous function of the current. In other words, for a certain number of current magnitudes, there was the same number of well-focused images, each of which was larger than the preceding one. This relationship is shown in Fig. 12 where the circles represent the position in which well-focused images were obtained. Since the position of the coil was fixed, it follows from the thin lens law that there should be only one focal length.

However, there were several degrees of magnification, indicating a variable focal length. In order to explain this deviation from the thin lens law, it was assumed that the effective center of the lens shifted with the intensity of the magnetic field, resulting in a changing focal length.

The following table shows the relationship of the various factors mentioned above.

Table 1. The Factors Concerning an Electron Microscope.

Cathode current in amperes	: Coil current in amperes	: Accelerating potential in terms of microamperes	: Width of image in mm.	: Width of object in mm.	: Distance in cm. from center of coil to object end of tube
4.8	: .555	: 45	: 26	: 1	: 22.5
3.5	: .85	: 75	: 24	: 1	: 12.5

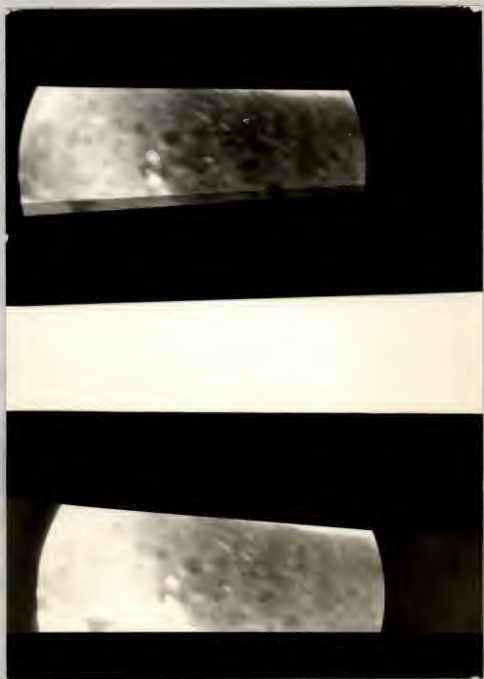

Fig. 10. Images of cathode with peripheral distortion removed in printing.

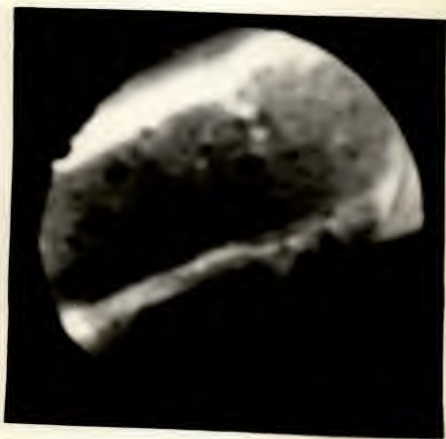

Fig. 9. Image of cathode.

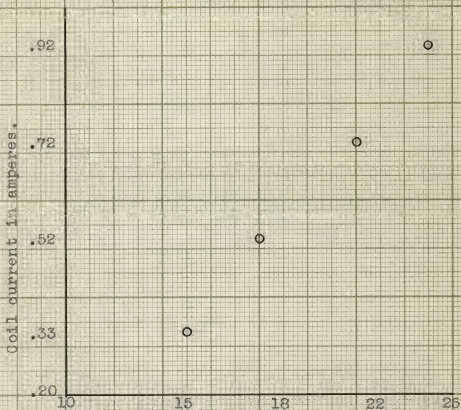

Fig. 12. Magnification, in millimeters, of image to millimeters of object.

ACKNOWLEDGMENT

In conclusion I wish to express my gratitude for the cooperation received from my major instructor, Doctor J. H. McMillen.

I am also obligated to Professor Hudiberg whose advice concerning shop work was very helpful and time-saving.

For efficiency in procuring equipment, I am indebted to Doctor A. B. Cardwell.

LITERATURE CITED

- (1) Borries, B. V. and Ruska, E.
Progress in construction and performance of ultra-
microscopes. *Wiss. Veröff. a. d. Siemens-Werken*,
17(1):99-106. 1938.
- (2) Borries, B. V., Ruska, E. and Ruska, H.
Ultra-microscopic photographs of bacteria.
Wiss. Veröff. a. d. Siemens-Werken, 17(1):107-111.
1938.
- (3) Bouwers, A.
The focusing of narrow electron beams in vacuo.
Physica. 2(3):145. 1935.
- (4) _____
Convergence of electrons by means of magnetic
coils. *Physica*. 4(3):200-206. 1937.
- (5) Busch, H.
Berechnung der Bahn von Kathodenstrahlen in
axialsymmetrischen elektromagnetischen Felde.
Ann. d. Physik, 81:973-974. 1926.
- (6) Coeterier, F. and Teves, M.
An apparatus for the transformation of light of
long wave length into light of wave length.
Physica. 3(9):968. 1936.
- (7) Hoag, J. B. and Smith, N. M.
A thyratron controlled ionization gauge. *Rev. of*
Sci. Insts., 7(12):497-499. 1936.
- (8) Jauncey, G. E. M.
Modern physics. New York. D. Van Nostrand,
602 p. 1937.
- (9) Jaycox and Weinhart.
A new design of an ionization manometer. *Rev. of*
Sci. Insts., 2:401. 1931.
- (10) Knoll, M. and Ruska, E.
Die magnetische Sammelspule für schnelle Elek-
tronenstrahlen. *Zeit. für Tech. Physik*, 12(8):
389. 1932.

- (11) Knoll, M. and Ruska, E.
Das Elektronenmikroskop. Zeit. für. Physik,
78:318-339. 1932.
- (12)

Beitrag zur geometrischen Elektronenoptik.
Ann. d. Physik, 12:607. 1932.
- (13) Leaver, E. W.
Seeing with electrons. Short Wave and Television,
9(2):97. 1938.
- (14) Leverenz, H. W.
Problems concerning the production of cathode-ray
tube screens. Jour. of Optical Soc. of America,
27(1):25-35. 1937.
- (15) Maloff, I. G. and Epstein, D. W.
Electron optics in television. New York.
McGraw-Hill, 299 p. 1938.
- (16) Mason and Weaver.
The electromagnet field. Chicago. Univ. of
Chicago Press, 389 p. 1932.
- (17) Meyer, C. F.
The diffraction of light, X-rays, and material
particles. Chicago. Univ. of Chicago Press,
473 p. 1934.
- (18) Rebsch, R.
Theoretical resolving power of the electron micro-
scope. Ann. d. Physik, 31(6):551-560. 1938.
- (19) Ruska, E.
Über Fortschritte im Bau und in der Leistung des
magnetischen Elektronenmikroskops. Zeit. f.
Physik, 87:581. 1933.
- (20)

Über ein magnetischen Objectiv für das Elek-
tronenmikroskop. Zeit. f. Physik, 89:90. 1935.
- (21) Slater and Frank.
Introduction to theoretical physics. New York.
McGraw-Hill, 576 p. 1933.
- (22) Wallauschek and Bergman.
Für Theorie des Elektronenmikroskops mit Anwen-
dung auf rein magnetische Felder. Zeit. f.
Physik, 94:329. 1935.