

**ANALYSIS OF GRAPHICAL REPRESENTATION
USED BY ARCHITECTS**

by

CHARLES RALPH BISSEY

B. S., Colorado State University, 1957

A THESIS

submitted in partial fulfillment of the

requirements for the degree

MASTER OF ARCHITECTURE

Department of Architecture and Allied Arts

**KANSAS STATE UNIVERSITY
Manhattan, Kansas**

1961

1 D
2668
T4
1961
E57
C.2
Document +

This thesis is dedicated
to those from whom I
have learned

TABLE OF CONTENTS

INTRODUCTION - - - - -	1
PROJECTION THEORY - - - - -	-3
CONCLUSIONS - - - - -	-105
ARCHITECTURAL DRAFTING STANDARDS - - - - -	122
ACKNOWLEDGMENTS - - - - -	-135
LITERATURE CITED - - - - -	136

INTRODUCTION

Graphical representation is a linear language which is understood by visualization and interpretation, and not a language that is written to be read aloud. As our environment becomes more technical and complex, more training is required for those who enter the architectural profession to visualize the complex elements and be able to interpret and transfer the information to drawings. For instance, in the early 1900's, a set of working drawings was considered to be the site plan, floor plans, elevations, and a few large sections through the building. During one period, these drawings were prepared using colored inks to distinguish between different types of lines and materials. The present-day architectural practice requires the architect to prepare very detailed drawings of a structure as it usually consists of a multitude of materials and is complex in it's fabrication. Drawings also act as legal documents upon which accurate project bids are based and act as a legal document in the fact that it is a method by which the client or owner is informing the various contractors of their obligations.

The present-day architect must be able to understand the fundamentals of the graphical language and apply these in the form of drawings and sketches. It is the objective of this thesis to investigate only one phase of this broad area of graphical representation, this being sectional views, particularly the sectional views used in architectural working drawings. The principles of projection drawing is discussed so that the projection of a sectional view is understood. The sectioning methods found in the American Drafting Standards Manual published by the American

Society of Mechanical Engineers is reviewed and the inadequacies of these standards explained in view of the architect's needs.

An architectural drafting standard for sectional views and an indexing method has been devised to fulfill the architectural requirements equivalent to the standards used by the mechanical engineers. This standard consists of written explanations and a partial set of working drawings to illustrate these fundamentals.

PROJECTION THEORY

Graphical representation, related to architecture, may be in the form of a freehand sketch or a refined mechanically constructed drawing. Drawings are made so that information may be passed from one person to another, thus they are a means of graphic communication. This means of graphic communication is nearly as old as man himself. Evidence indicates man constructed drawings on the face of stone and in the sand to aid in his communication with others before he used verbally controlled sounds. This graphic or linear language, is not meant to be read aloud, rather it is one which is understood by a person who is able to visualize a clear image. The simple line drawings, constructed by man centuries ago on the walls of his cave, represented a real thing, something he was able to see in his everyday environment. "A drawing is a graphic representation of a real thing."¹ Although the drawings that man constructs today may be more refined and technical, they still describe his environment and provide a means of graphic communication.

The freehand sketches constructed by the architect might be very rough in character consisting of only a few broad pencil strokes, which usually lack an artistic refinement of many tones and line combinations. These sketches are usually drawn rapidly to convey an idea between two or more persons and is usually drawn pictorially or in a three-dimensional form as this is more easily interpreted by others.

An architect may prepare a refined and more complete pictorial freehand sketch utilizing a wide variety of personal techniques and an

¹Frederick E. Giesecke, Technical Drawing, p. 2.

EXPLANATION OF PLATE I

An Architect's freehand pictorial or three dimensional sketch.

PLATE I

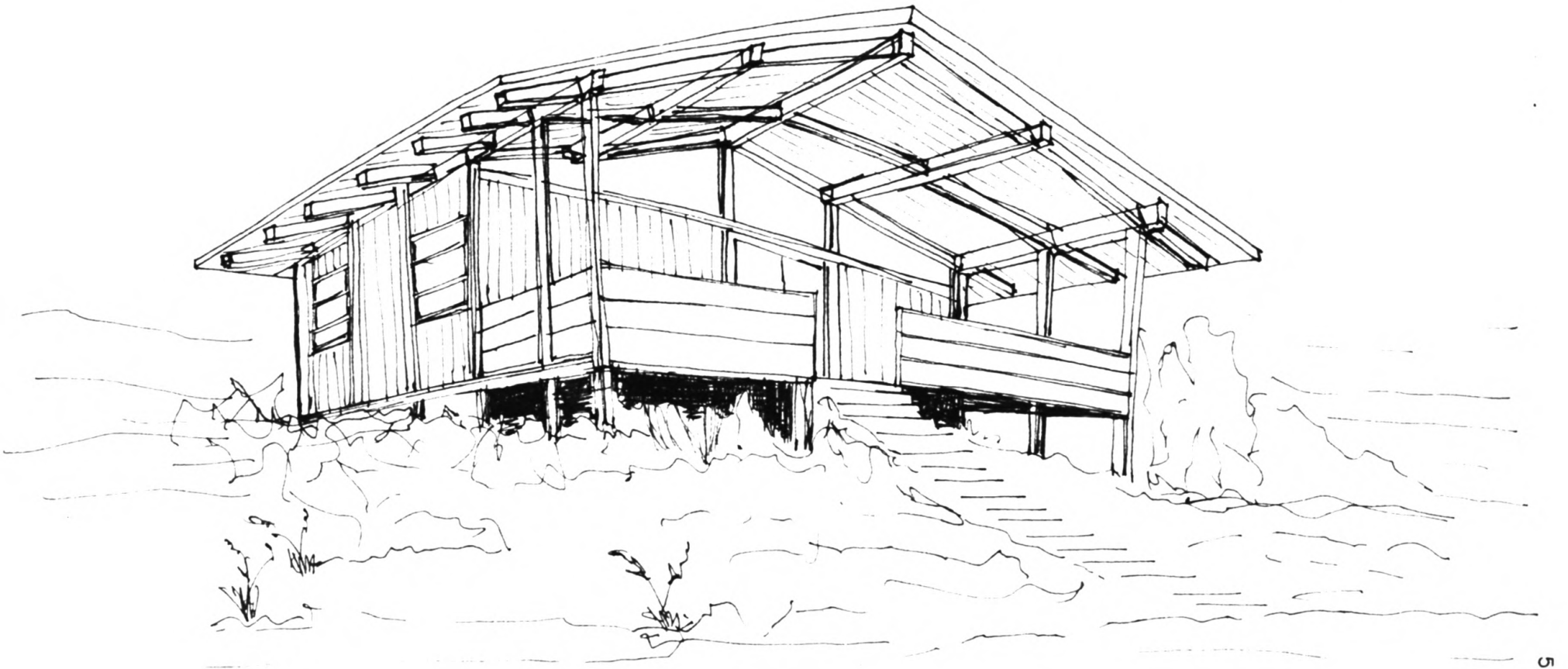

unlimited medium such as pen and ink, watercolor or pencil. This type of pictorial sketch is referred to as a rendering or a delineation and is used for presentation purposes. They may be photographed and published in newspapers or magazines, or displayed for public viewings. In this respect, the architect and the artist are trying to achieve the same goal. Their aim is to use personal techniques to reproduce a scene by means of their creative imagination that will impart to the observer the same mental impression as that conceived by the architect or artist.

A freehand drawing of some object does not necessarily have to be three dimensional or pictorial in nature. It may consist of a defined system of related views of an object. By means of these related views, (top, front, side, etc.) the complexity of any object may be described. These related views will indicate the heights, widths and depths of the over-all object or any of it's parts.

A drawing is said to be mechanically constructed when it has been prepared with the aid of straight edges and drawing instruments. Each element of a mechanically constructed drawing is usually drawn to a definite length or to scale. A pictorial or perspective drawing may be mechanically constructed. An architectural rendering, for instance, is often evolved from a mechanically constructed perspective. After the basic mechanical layout has been prepared, freehand expressions, tones and values are added to complete the rendering.

An architect's set of working drawings consists of a mechanically constructed system of related views that explain how the structure is to be built. To properly understand this system of mechanically con-

EXPLANATION OF PLATE II

An Architect's freehand drawing of an object that consists of a defined system of related views.

PLATE II



TOP

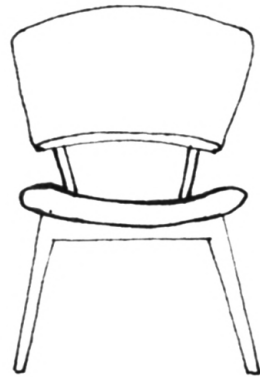

FRONT



SIDE

EXPLANATION OF PLATE III

**A mechanically constructed perspective layout used
when preparing an architect's rendering.**

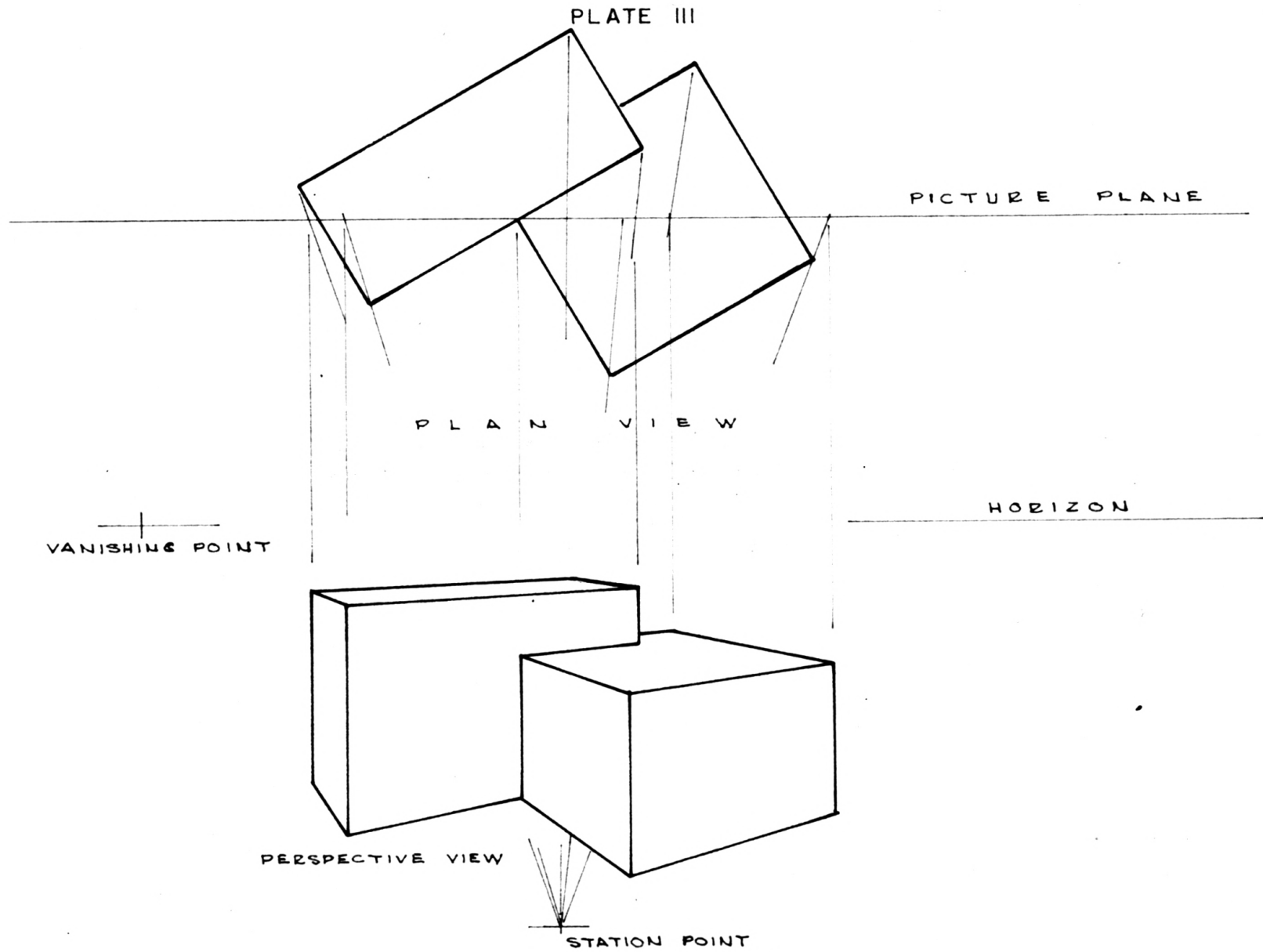

EXPLANATION OF PLATE IV

An Architect's rendering or delination for a proposed structure.

PLATE IV

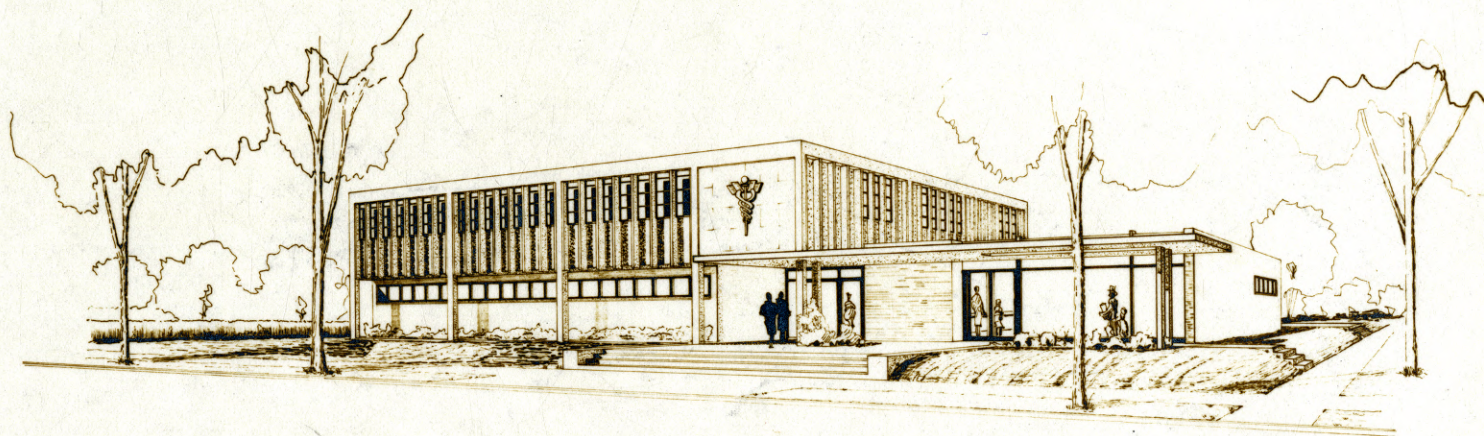

A MEDICAL CLINIC AND PROFESSIONAL BUILDING

FOR
1200 FREEMONT STREET
MANHATTAN, KANSAS

EXPLANATION OF PLATE V

Object being projected onto a projection plane by means of projections that are oblique to the projection plane, and perpendicular to the projection plane.

PLATE V

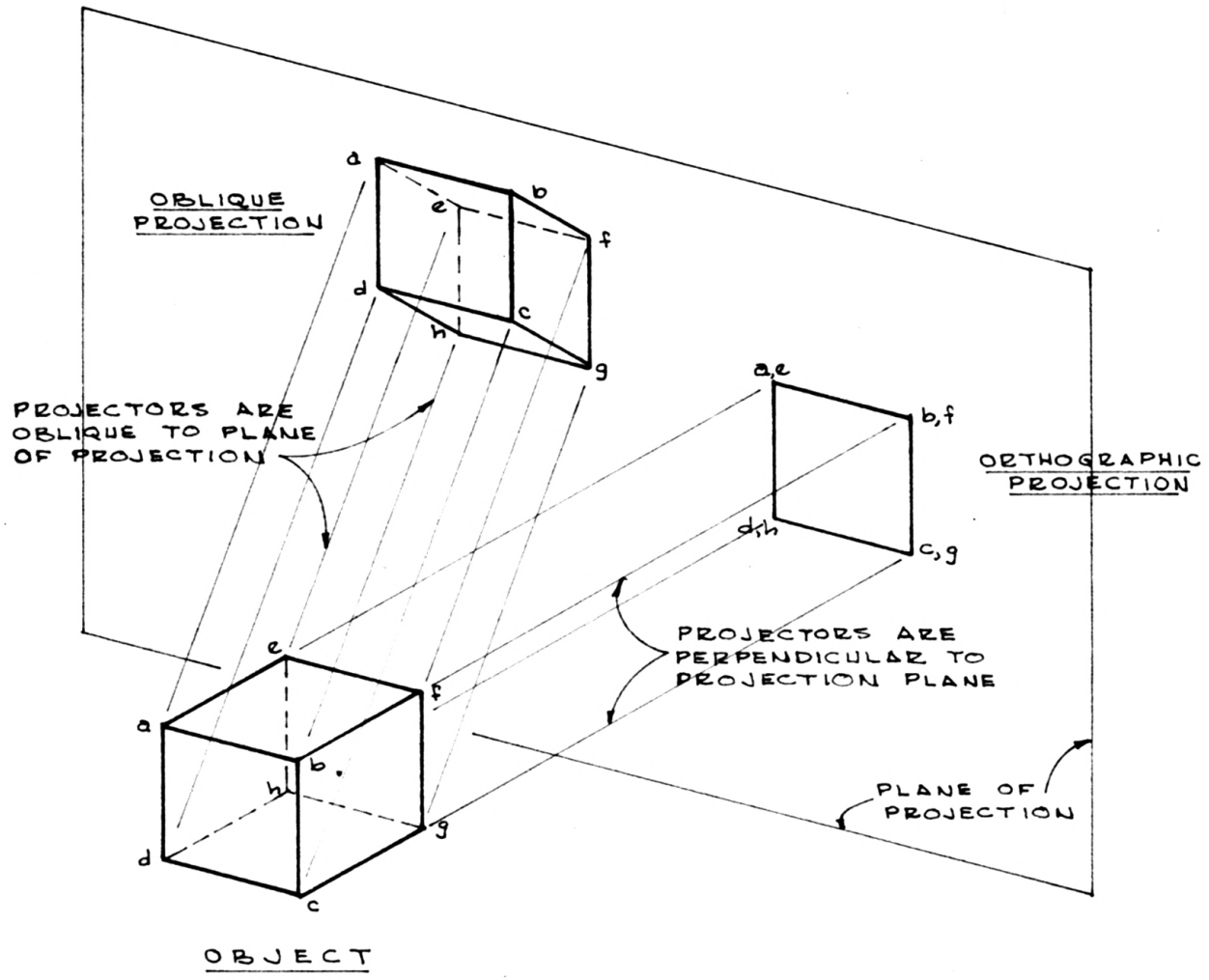

structed related views, a person must be able to project an object onto a projection plane. This must be accomplished both mentally and by means of mechanically constructing the projection. It is noted that the projection lines do not have to be perpendicular to the projection planes, but can be at any angle. However, if a system of related views is used to explain an object, the projection lines must be perpendicular or at right angles to the projection planes. This type of projection drawing is termed "orthographic projection." If the projection lines are perpendicular to the projection planes, they are parallel and the point of observation when constructing the view is assumed to be located at infinity.

To establish a method of projecting the views of an object having a relationship that would be understood by everyone, a quadrant system was devised by using three planes. These planes are positioned to form four quadrants and at the same time have a right angle relationship at their intersections. The projection planes are assumed to be infinite in extent and their intersections forming straight lines known as the coordinate axes. Each plane is termed in accordance with its position and is known as the horizontal, vertical, and profile planes.

The line of intersection of the vertical and the horizontal plane is the X-axis; the line of intersection of the vertical and the profile plane is the Y-axis; and the line of intersection of the horizontal and the profile plane is the Z-axis.²

The intersection of the three axes is termed the origin of co-ordinates.

The four dihedral angles formed by the vertical and the horizontal planes are known, respectively as the 'first,

²Ibid., p. 148.

EXPLANATION OF PLATE VI

An orthographic projection of an object onto a projection plane projects as a view of the object when the observer's viewing point is located at infinity.

PLATE VI

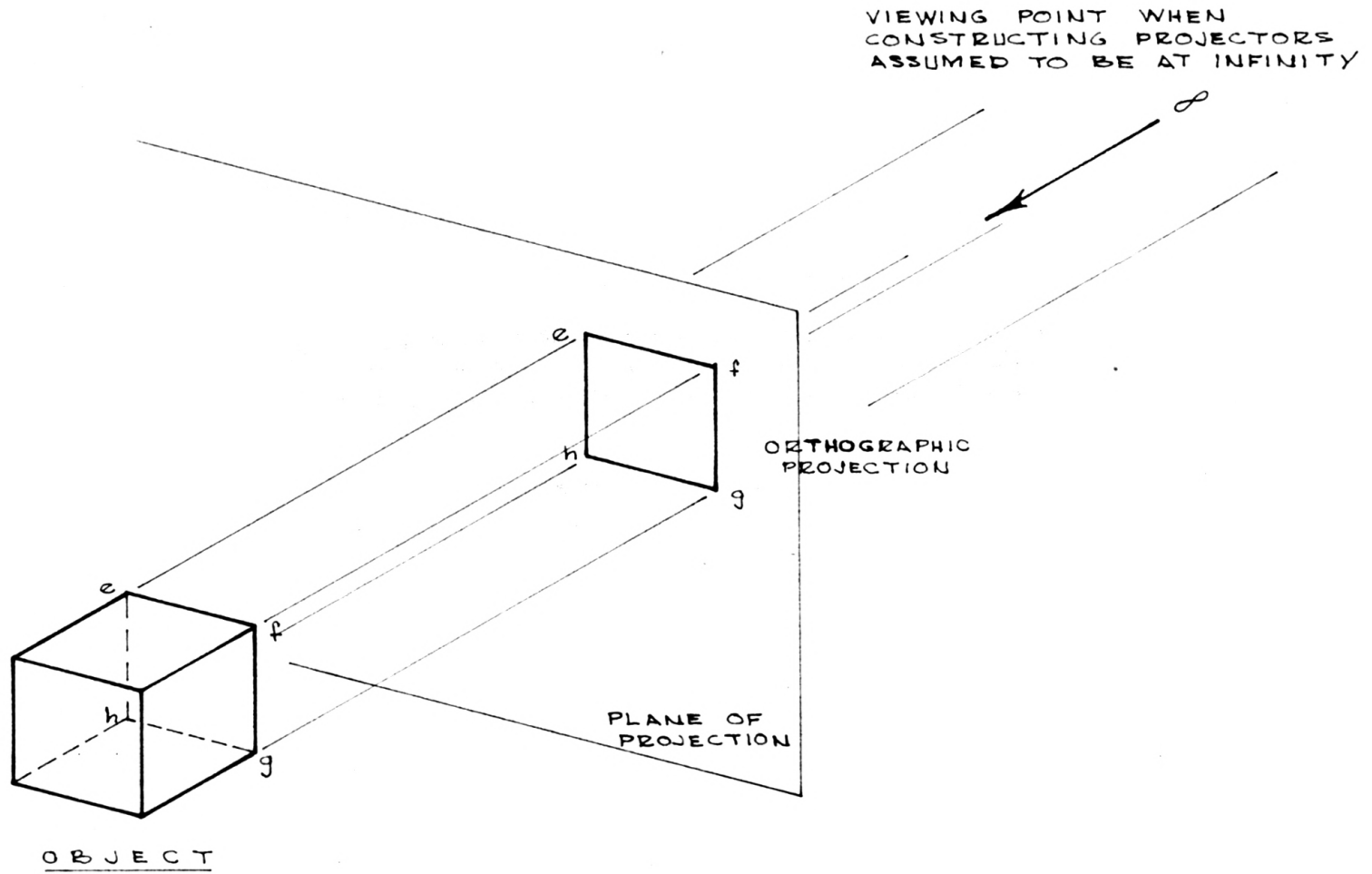

EXPLANATION OF PLATE VII

A drawing showing the horizontal, vertical and profile projection planes positioned to form four quadrants and at the same time have a right angle relationship at their intersections. Each quadrant is a dihedral angle.

PLATE VII

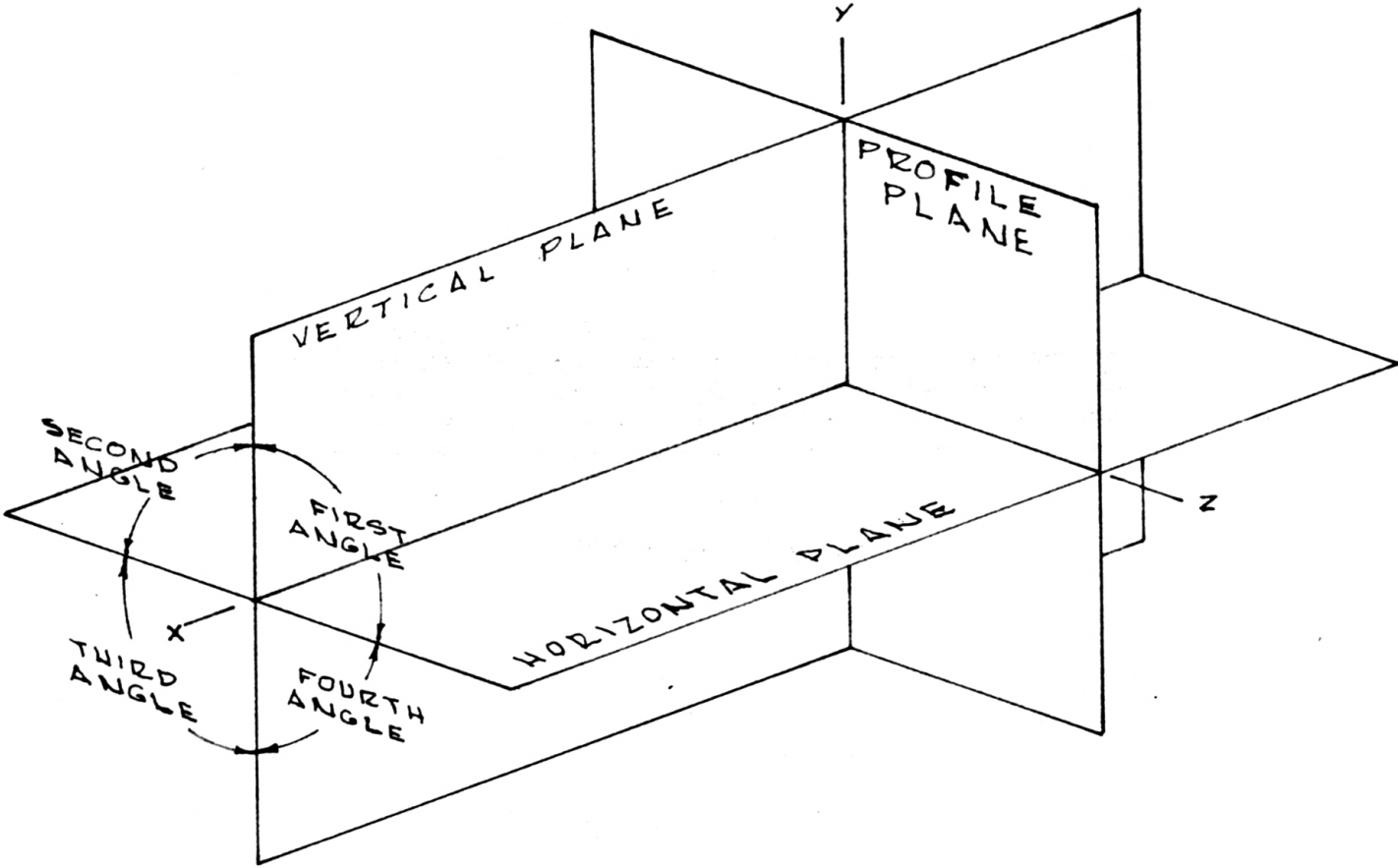

second, third, and fourth angles,³ and the eight spaces formed by the three planes of projection are called 'octants'.³

To construct the view projections of an object, the object is first located in one of the dihedral angles and its projections established on the projection planes. Each projection of the object on a projection plane constitutes a view. After the views have been established on the projection planes, the planes are folded open into one flat plane. The co-ordinate axes act as fold lines.

Prior to the year 1860, in the United States, the first dihedral angle was used to obtain the view projections - thus, the term, first angle projection. To obtain the view projections using the first dihedral angle, the object is positioned so that the back and front faces are parallel to the vertical plane and the top and bottom faces are parallel to the horizontal plane. The side faces will be parallel to the profile plane of projection. The faces and sides of the object will be shown in their true sizes and shapes in their respective projections. These projections are referred to as the top, front and side views. Or the top view may be termed the horizontal projection, the front view a vertical projection and the side view the profile projection of the object.

Having determined the three views of the object on their respective projection planes, two of the planes must be revolved into the third plane so that the three projection planes will be in one flat plane. This flat plane may be the drawing paper or a blackboard and enables the draftsman to construct the necessary views of an object in one plane.

³Loc. cit.

EXPLANATION OF PLATE VIII

View projections obtained when an object is positioned in the first dihedral angle and projected onto the three principal projection planes.

PLATE VIII

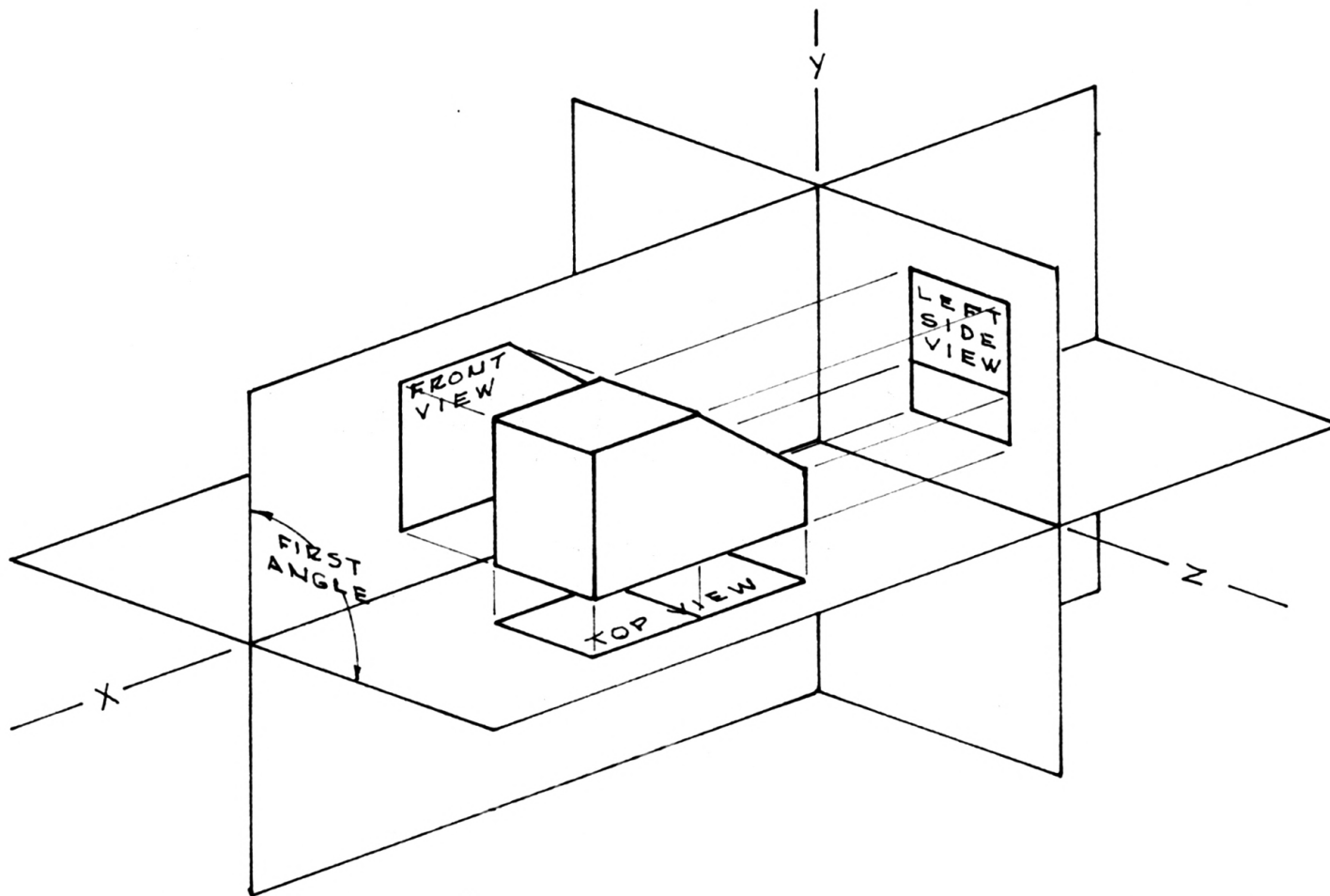

EXPLANATION OF PLATE IX

Revolving two of the principal projection planes
about their co-ordinate axes, or fold lines, into
one flat plane.

PLATE IX

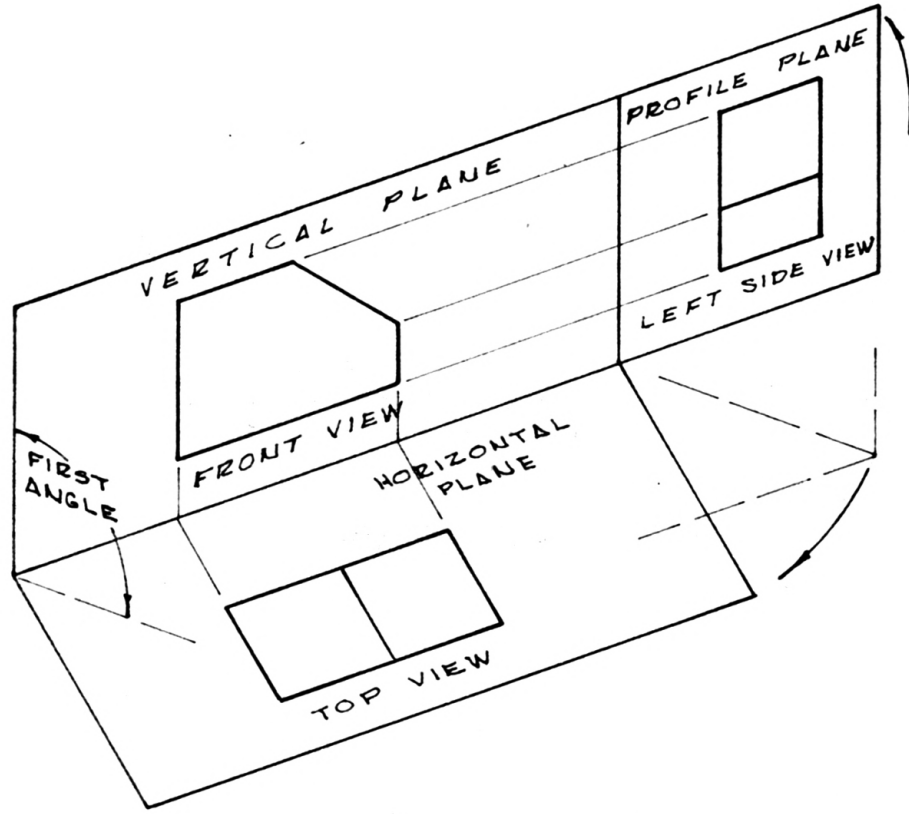

EXPLANATION OF PLATE X

Relationship of the top, front, and left side views of an object obtained when an object is positioned in the first dihedral angle after the principal projection planes have been revolved into one flat plane.

PLATE X

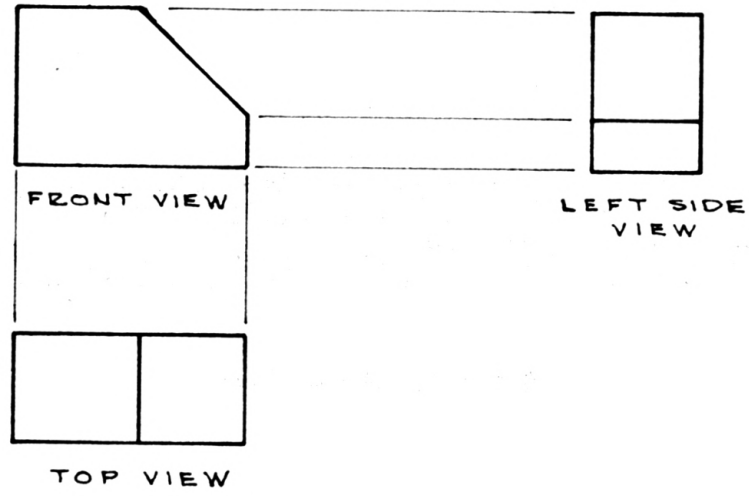

The conventional method of revolving the projection planes is to open or fold them outward, away from the object, using the co-ordinate axes as fold lines or pivot lines about which the planes revolve. It is noted that after the planes have been revolved, the top view or horizontal projection is directly below the front view or vertical projection. The left side view or profile projection is directly to the right of the front view. "This method of projection is known as 'first-angle projection', and is used in practically all European countries!"⁴

When the object is placed in the third dihedral angle with its faces parallel to the projection planes, the true size and shapes of the faces and sides may be projected onto the projection planes, obtaining the top view or horizontal projection, the front view or vertical projection, and the side view or the profile projection. With the three projections of the object established, two of the projection planes are revolved, or folded open away from the object into the third plane so that the three projection planes will lie in one flat plane. The projection planes are revolved about the co-ordinate axes. It is noted that the top view or horizontal projection is directly above the front view or vertical projection, and the right side view or profile projection is directly to the right of the front view.

This method of projection is known as 'third-angle projection' and is universally used for working drawings in the United States and Canada.⁵

A single orthographic view projection of an object onto a projection plane will not completely describe the overall size and shape of the object.

⁴Ibid., p. 150.

⁵Loc. cit.

EXPLANATION OF PLATE XI

View projections obtained when an object is positioned in the third dihedral angle and projected onto the three principal projection planes.

PLATE XI

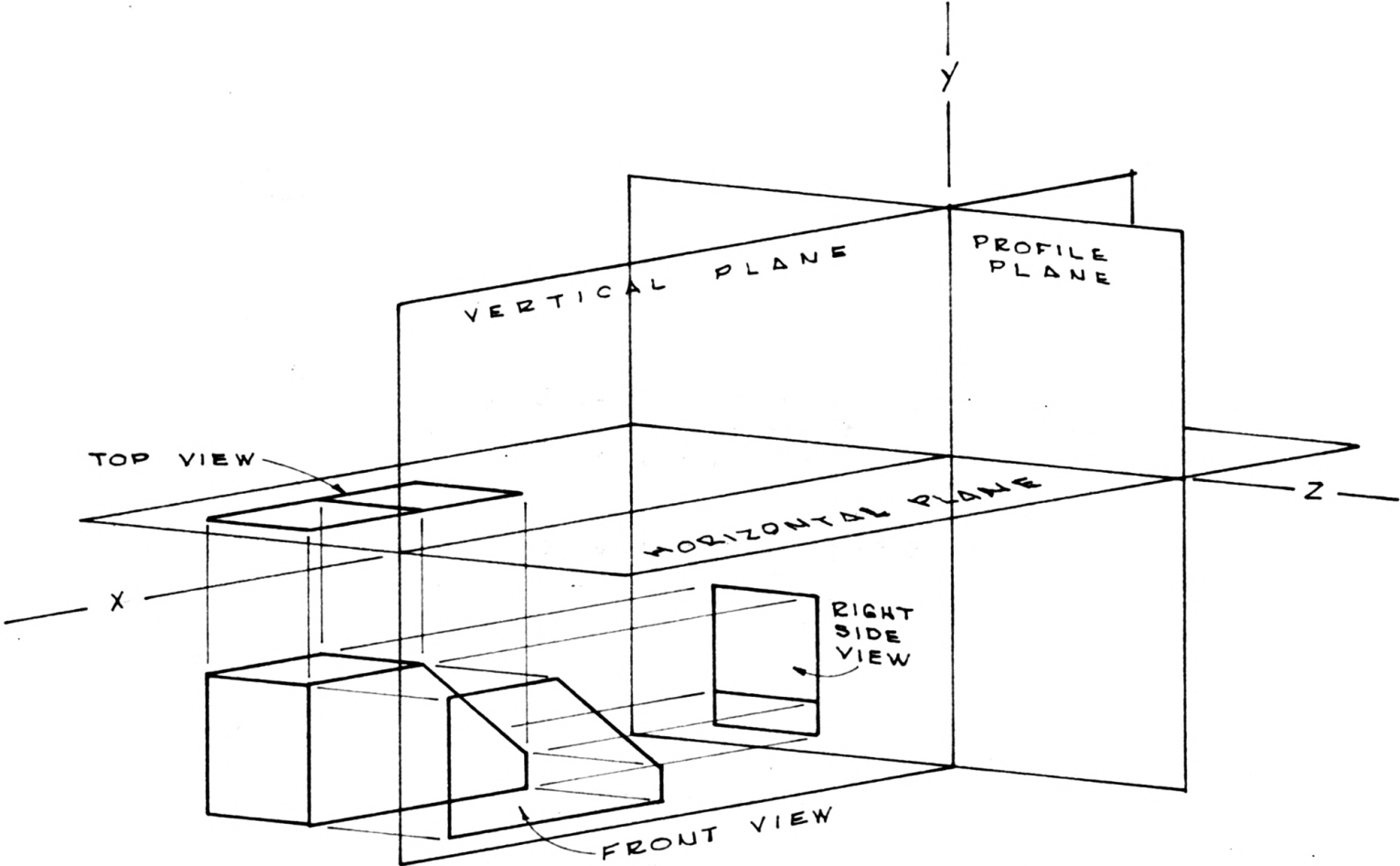

EXPLANATION OF PLATE XII

Revolving two of the principal projection planes about their co-ordinate axes, or fold lines, into one flat plane.

PLATE XII

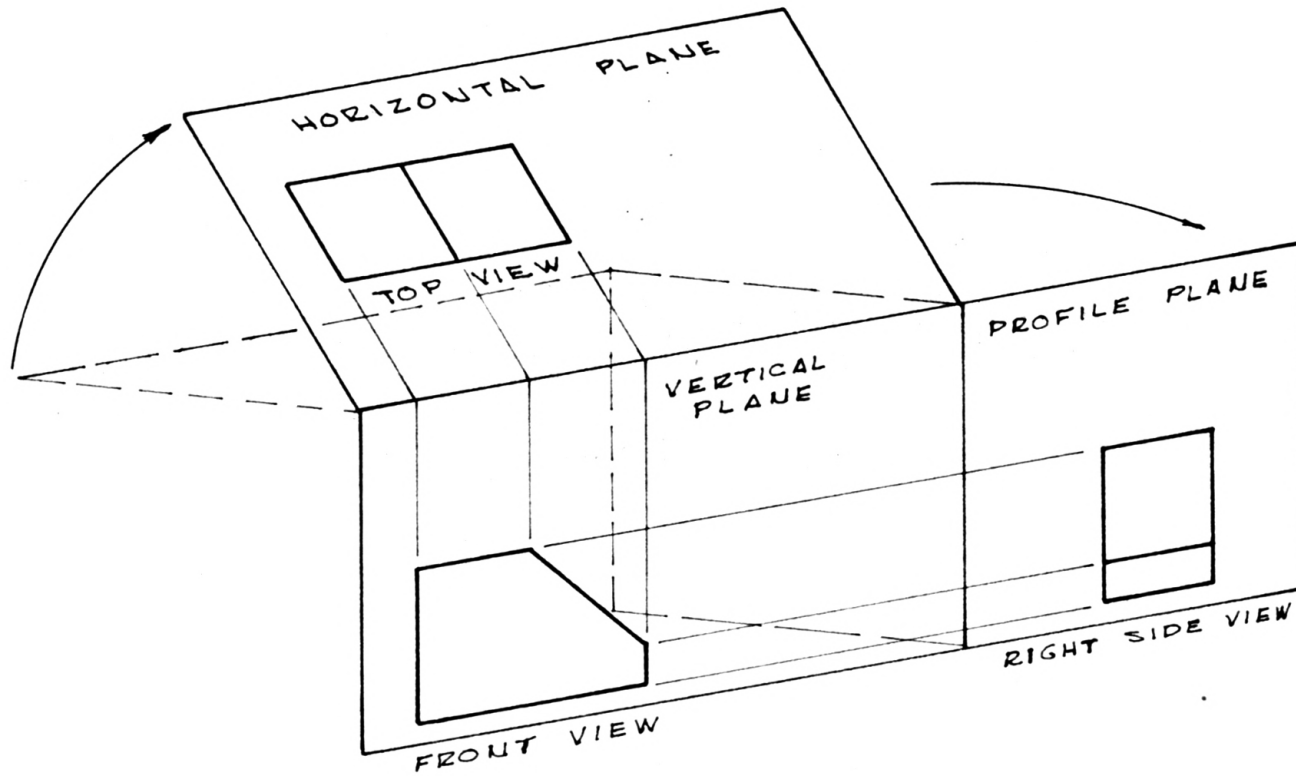

EXPLANATION OF PLATE XIII

Position of the principal projection planes after being revolved into one flat plane with their view projections.

PLATE XIII

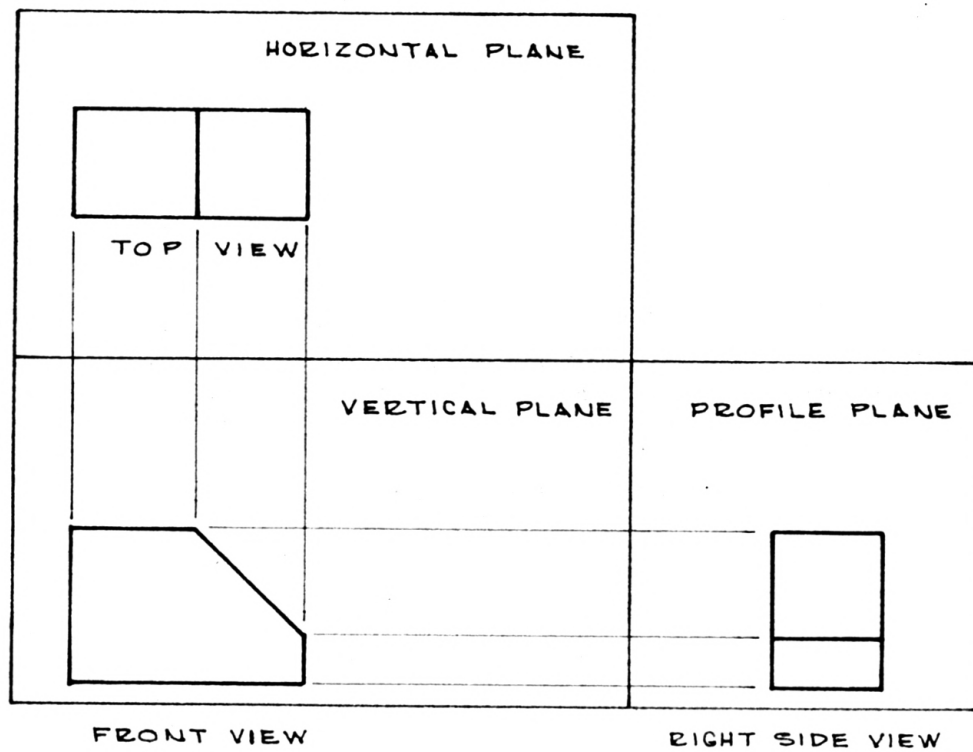

EXPLANATION OF PLATE XIV

Relationship of the top view, horizontal projection, front view, vertical projection, and the right side view, profile projection of an object obtained when an object is positioned in the third dihedral angle after the principal projection planes have been revolved into one flat plane.

PLATE XIV

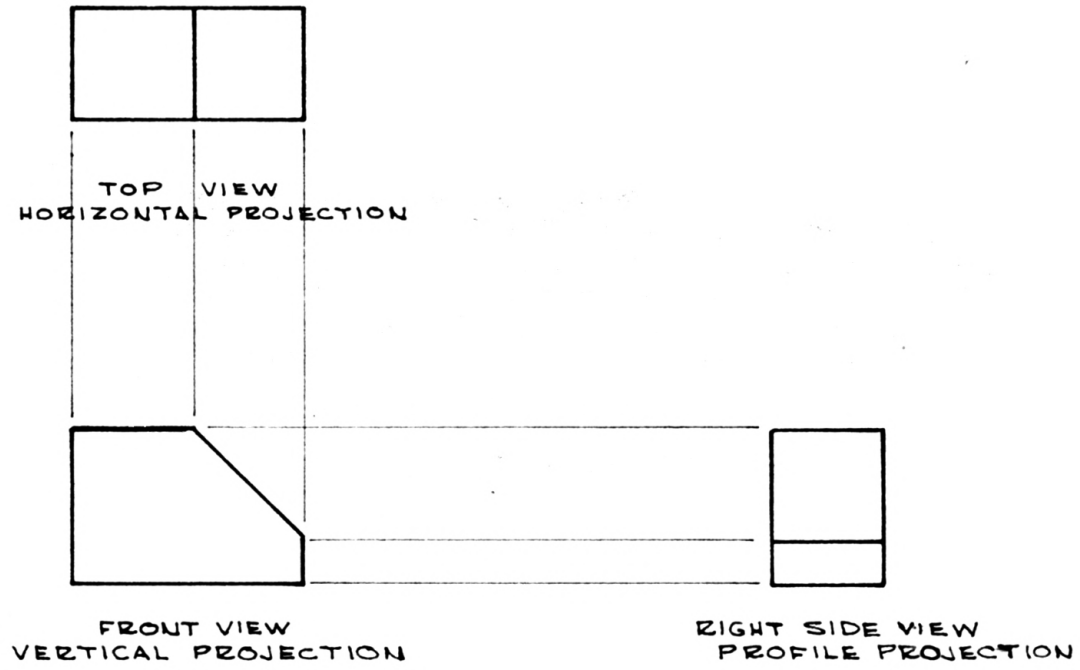

In order to obtain a complete size and shade description, it is necessary to construct two or more view projections. This method of explaining objects by drawings is known as multiview projection.

If three additional projection planes are positioned each respectively parallel to the horizontal projection plane, the vertical projection plane, and the profile projection plane, a box is formed having as it's sides six projection planes. Textbook authors and educators treat these projection planes as resembling transparent planes of glass. Thus, the projection plane arrangement is known as the "glass box."

When an object is placed inside the glass box, six projections of an object may be obtained. The three projection planes forming the third dihedral angle, used in third angle projection, are termed the principal horizontal projection plane, the principal vertical plane, and the principal profile plane. Thus, these three view projections are termed the three principal views: front, top and right side. The three view projections, in addition to the principal views, are obtained by revolving the projection planes about their intersection lines forming the left side view, rear view and the bottom view. These additional views are arranged so that the left side view, or left profile projection, is to the left of the front view, the rear view, or back vertical projection, is to the left of the left side view, and the bottom view, or bottom horizontal projection is directly below the front view.⁶

When preparing a drawing of an object, the draftsman must decide the

⁶The author of this thesis wishes to point out at this time, a conflict found in textbooks concerning the nomenclature of these six view projections. Some authors term all six view projections the principal views. Other authors term only the three view projections,

EXPLANATION OF PLATE XV

A glass box formed by positioning three additional projection planes, each respectfully parallel to the three principal projection planes, and the six view projections of an object on these planes.

PLATE XV

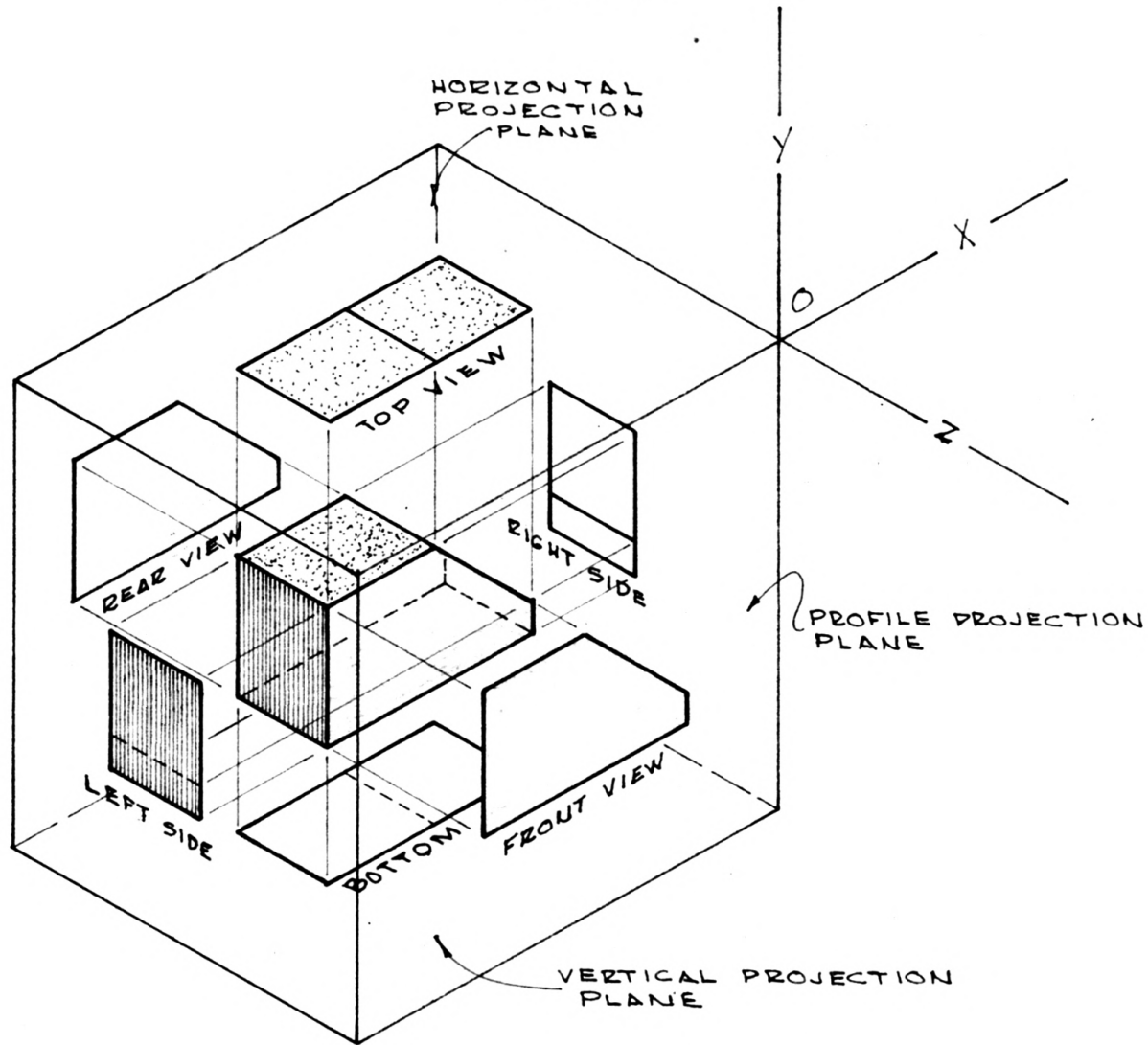

EXPLANATION OF PLATE XVI

Relationship of the six view projections of an object obtained after the projection planes of the glass box have been revolved into one flat plane.

PLATE XVI

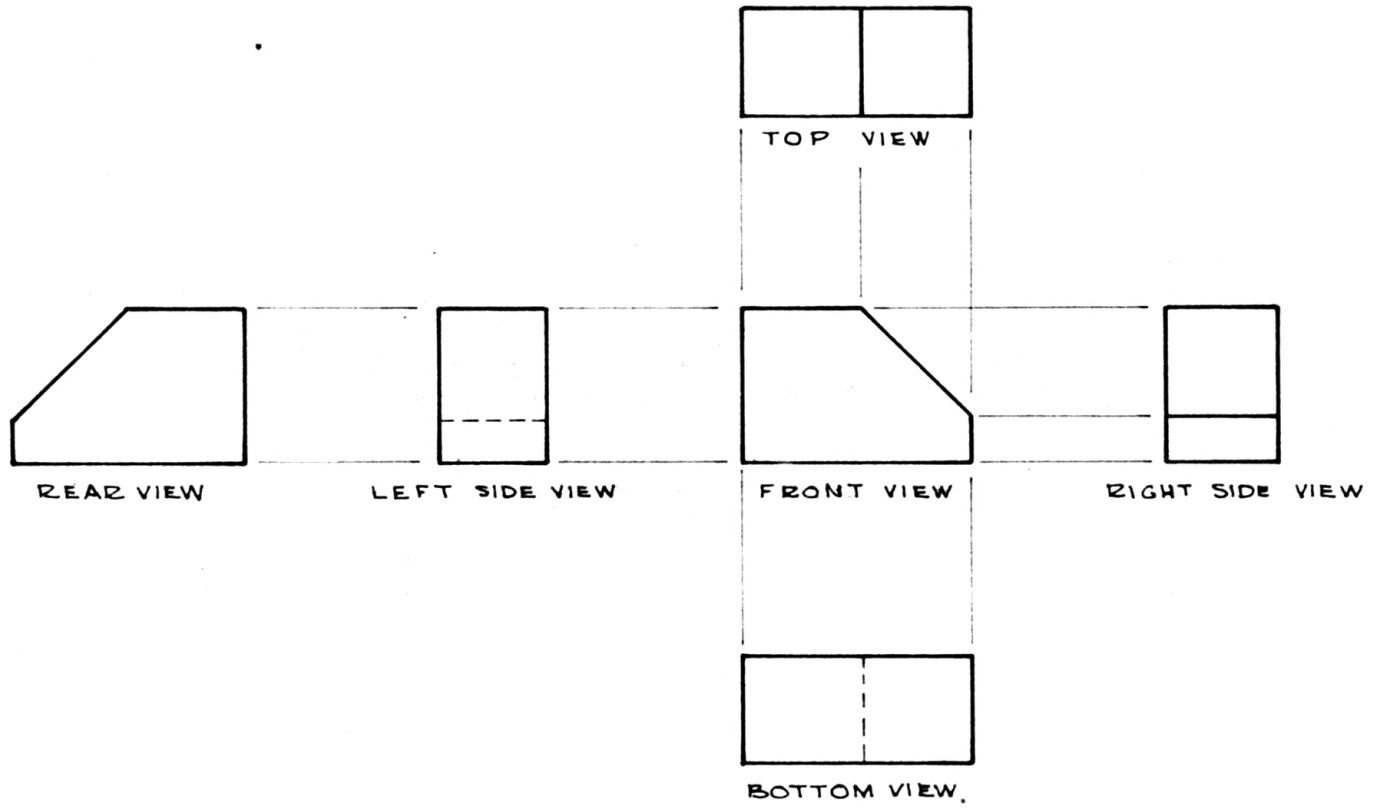

number of views required to sufficiently describe a particular object. If the object is simple in nature, two views will adequately explain the object.

The six view projections obtained when an object is projected onto the six principal projection planes, will not always explain the true size and shape of all parts of a complex object. This can be explained by projecting the views of a line or plane, composing a portion of the complex object, not parallel to any of the six planes of projection. Any line parallel to one of the six projection planes will project in true view or true length on the projection plane. Any plane parallel to one of the six projection planes will project in true view or true size and shape on the projection plane.

A line or plane that is not parallel to any of the principal projection planes is situated in an oblique position. A plane may be in an oblique position even though it is perpendicular to one of the principal projection planes.

In order to construct a view of an oblique line so that it will appear in true length, another type of projection plane must be introduced. This projection plane will be termed an auxiliary plane and will be positioned parallel to the oblique line and at the same time, perpen-

related to the three basic projection planes forming the four dihedral angles, as the principal view projections. For the purposes of this thesis, the latter will be used since this is the opinion expressed by many contemporary authors. Actually the trend of modern day authors and educators is to term all views a method of projecting a view onto a projection plane, taking into consideration the angle the projector makes with the projection plane as to the type of view obtained. The material in this thesis will be limited to views of objects obtained through the method of orthographic projection since this covers nearly all technical drawing.

EXPLANATION OF PLATE XVII

Positions of an auxiliary projection plane as related to the principal horizontal, vertical and profile projection planes.

PLATE XVII

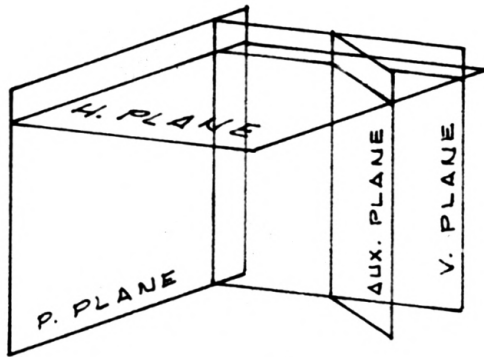

AUXILIARY PROJECTION
PLANE POSITIONED
PERPENDICULAR TO THE
HORIZONTAL PLANE

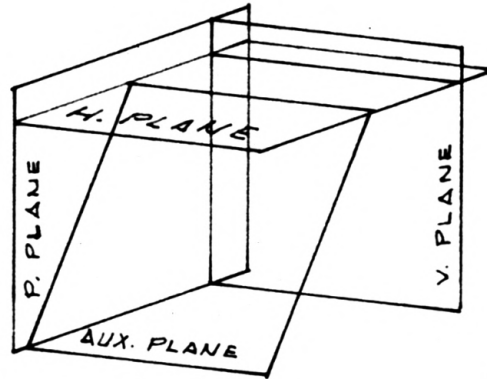

AUXILIARY PROJECTION
PLANE POSITIONED
PERPENDICULAR TO THE
PROFILE PLANE

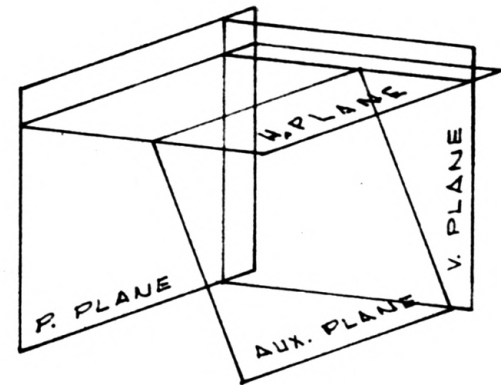

AUXILIARY PROJECTION
PLANE POSITIONED
PERPENDICULAR TO THE
VERTICAL PLANE

EXPLANATION OF PLATE XVIII

View projections obtained when an oblique line is positioned in the third dihedral angle and projected onto the three principal projection planes and onto an auxiliary projection plane situated parallel to the line giving a true length projection of the line.

PLATE XVIII

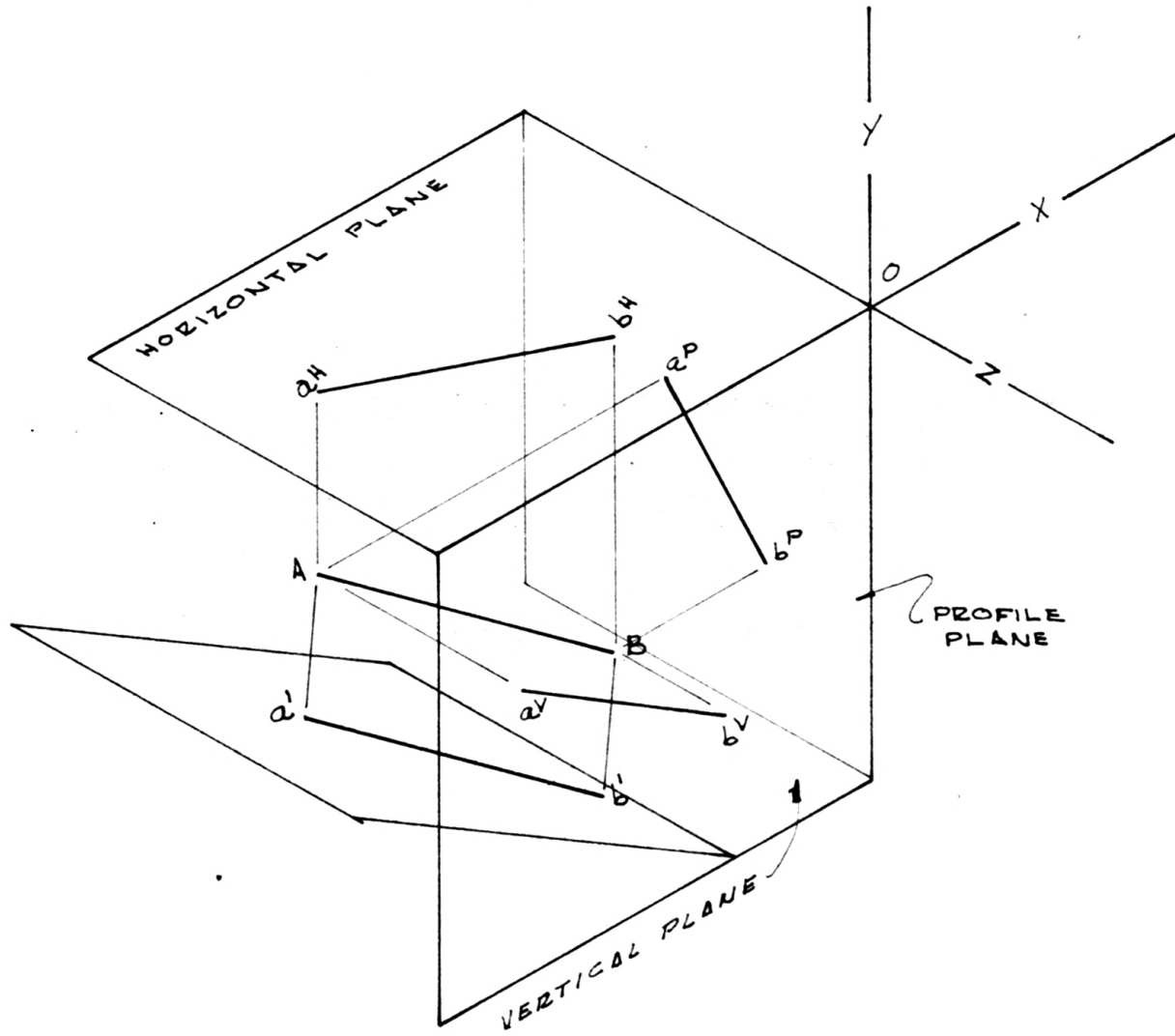

EXPLANATION OF PLATE XIX

Revolving two of the principal projection planes about their co-ordinate axes, or fold lines, and the auxiliary plane about it's intersection line in the vertical plane, into one flat plane.

PLATE XIX

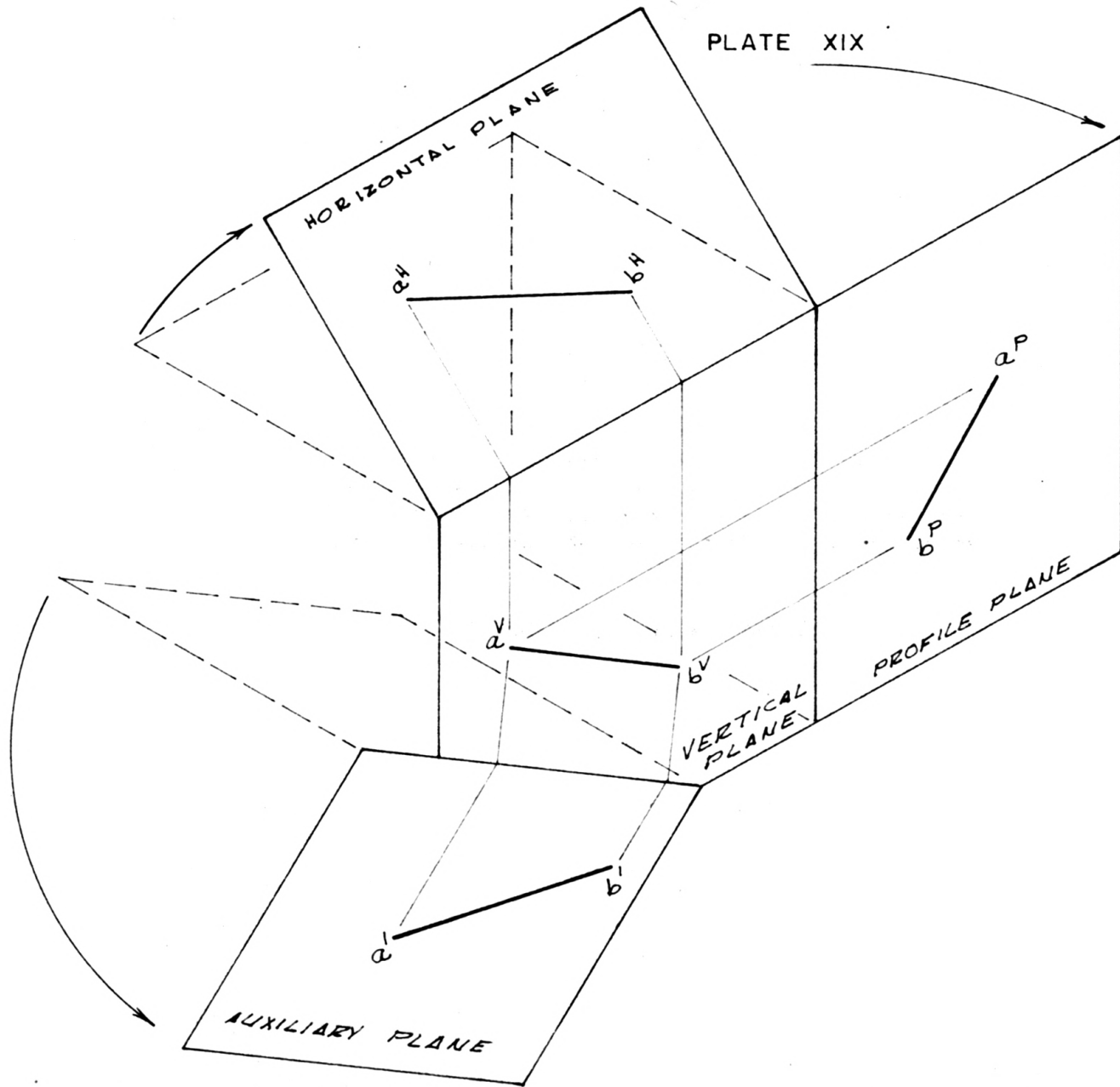

EXPLANATION OF PLATE XX

Position of the horizontal, vertical, profile and auxiliary projection planes after being revolved into one flat plane with their view projections.

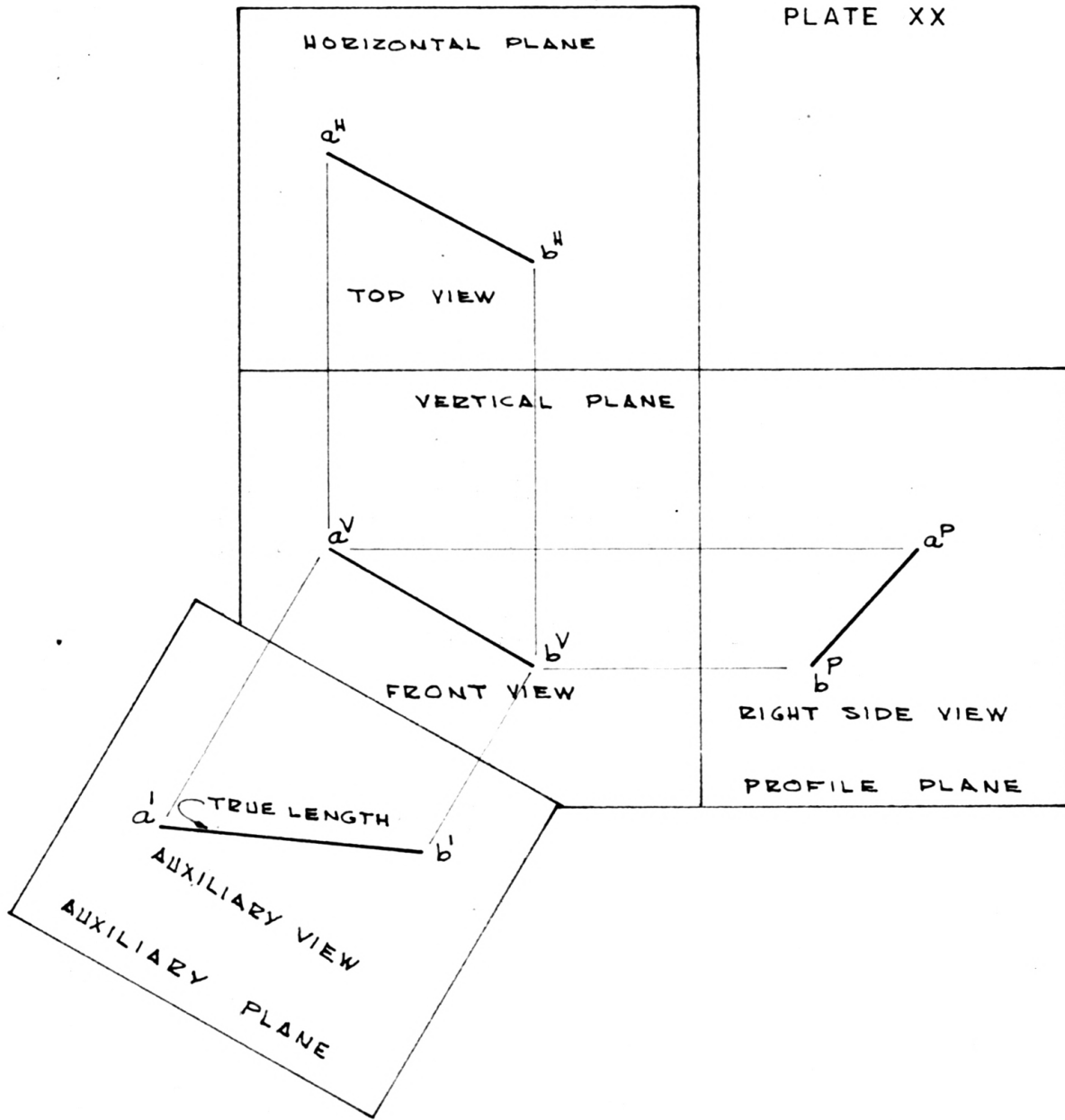



EXPLANATION OF PLATE XXI

Relationship of the view projections of an oblique line obtained when the auxiliary projection plane has been positioned parallel to the line and perpendicular to the vertical projection plane.

PLATE XXI

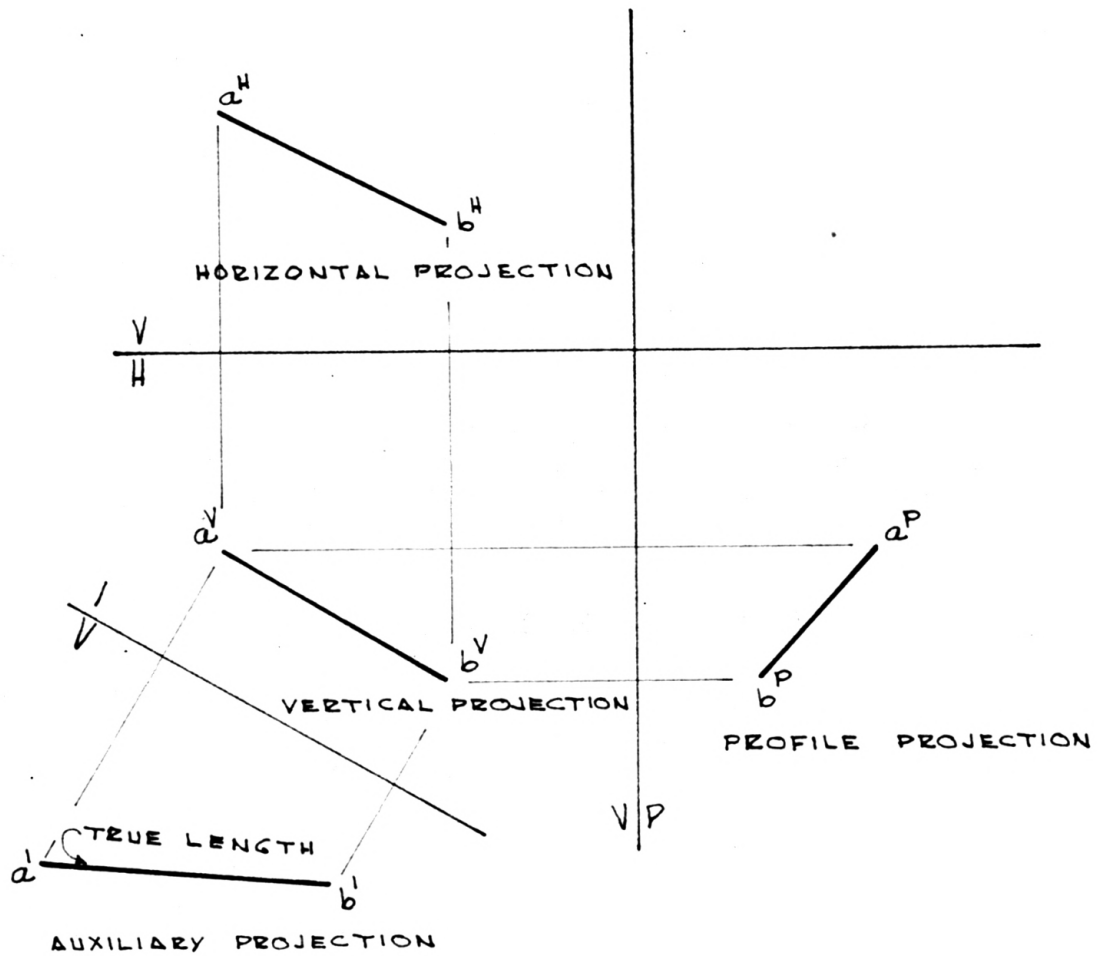

EXPLANATION OF PLATE XXII

Relationship of the view projections of an oblique line obtained when the auxiliary projection plane has been positioned parallel to the line and perpendicular to the horizontal projection plane.

PLATE XXII

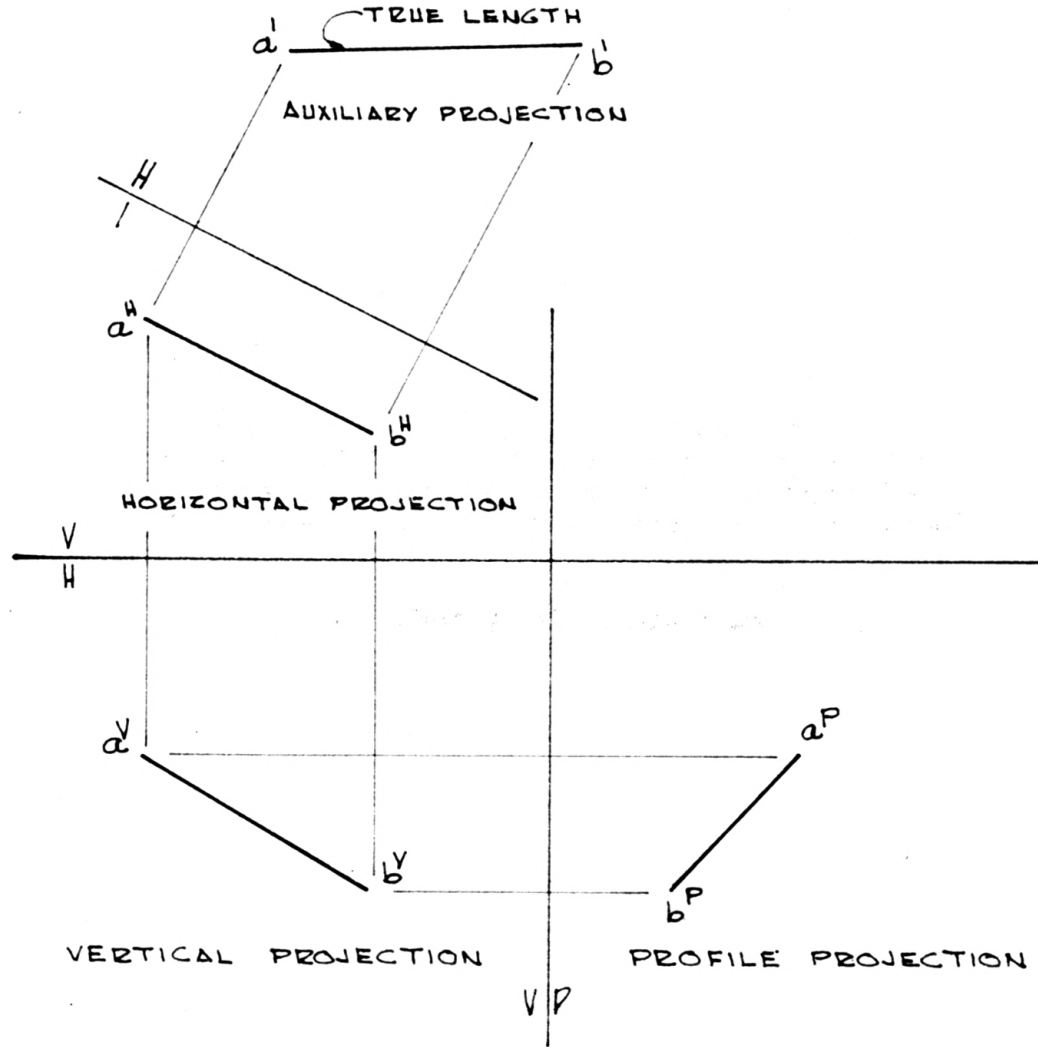

EXPLANATION OF PLATE XXIII

Relationship of the view projections of an oblique line obtained when the auxiliary projection plane has been positioned parallel to the line and perpendicular to the profile projection plane.

PLATE XXIII

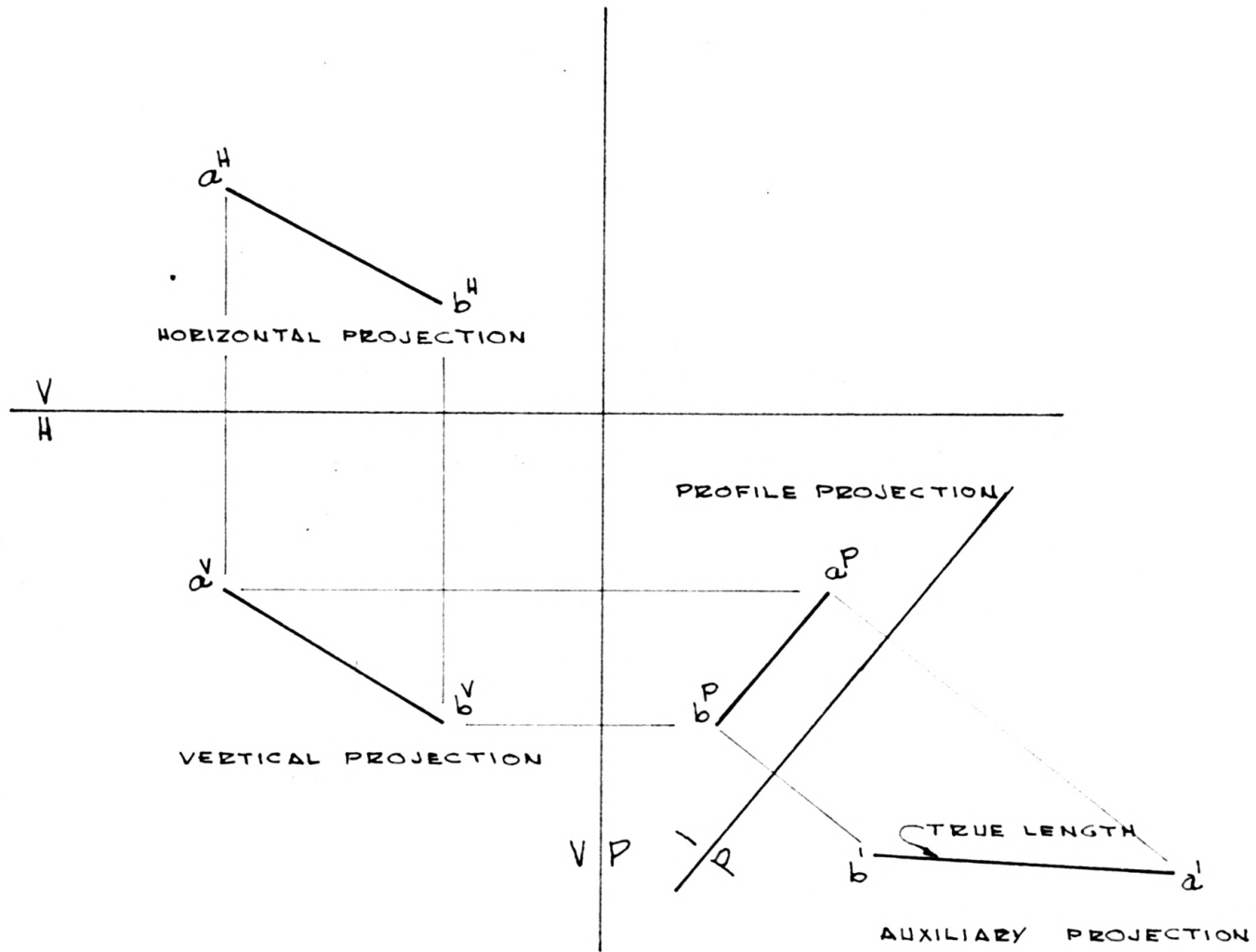

dicular to one of the principal projection planes. A line projects in true length on any plane that is parallel to the line. These two projection planes will intersect along a line of intersection that will act as an axis about which the auxiliary plane will be rotated conventionally into the plane to which it is perpendicular. Again, these two planes will be rotated into the third plane so that the planes will be in one flat plane showing all the view projections in their proper relationship.

An oblique plane which is perpendicular to one of the three projection planes will project in true size and shape onto a plane that is parallel to the oblique plane. Since the oblique plane is perpendicular to a principal projection plane, the auxiliary projection plane will also be perpendicular to one of the principal projection planes. These two projection planes, the auxiliary plane and the principal plane, will intersect along a line that will act as an axis about which the auxiliary plane will be rotated conventionally into the plane to which it is perpendicular. Now these two planes will be rotated into the third plane so that the planes will be in one flat plane showing all the view projections in their proper relationship.

An oblique plane may be so positioned that it is not perpendicular to any of the principal projection planes. To project an oblique plane in this position into a view showing the true size and shape, a view showing the plane on edge must first be drawn. This is accomplished by locating a line in the oblique plane that is parallel to a principal projection plane. This will project as a point onto an auxiliary plane perpendicular to the same principal projection plane to which the line is parallel. This line in the oblique plane may be positioned parallel to the horizontal

EXPLANATION OF PLATE XXIV

Plane of an object that is perpendicular to the principal vertical projection plane projected onto an auxiliary projection plane showing the true size and shape.

PLATE XXIV

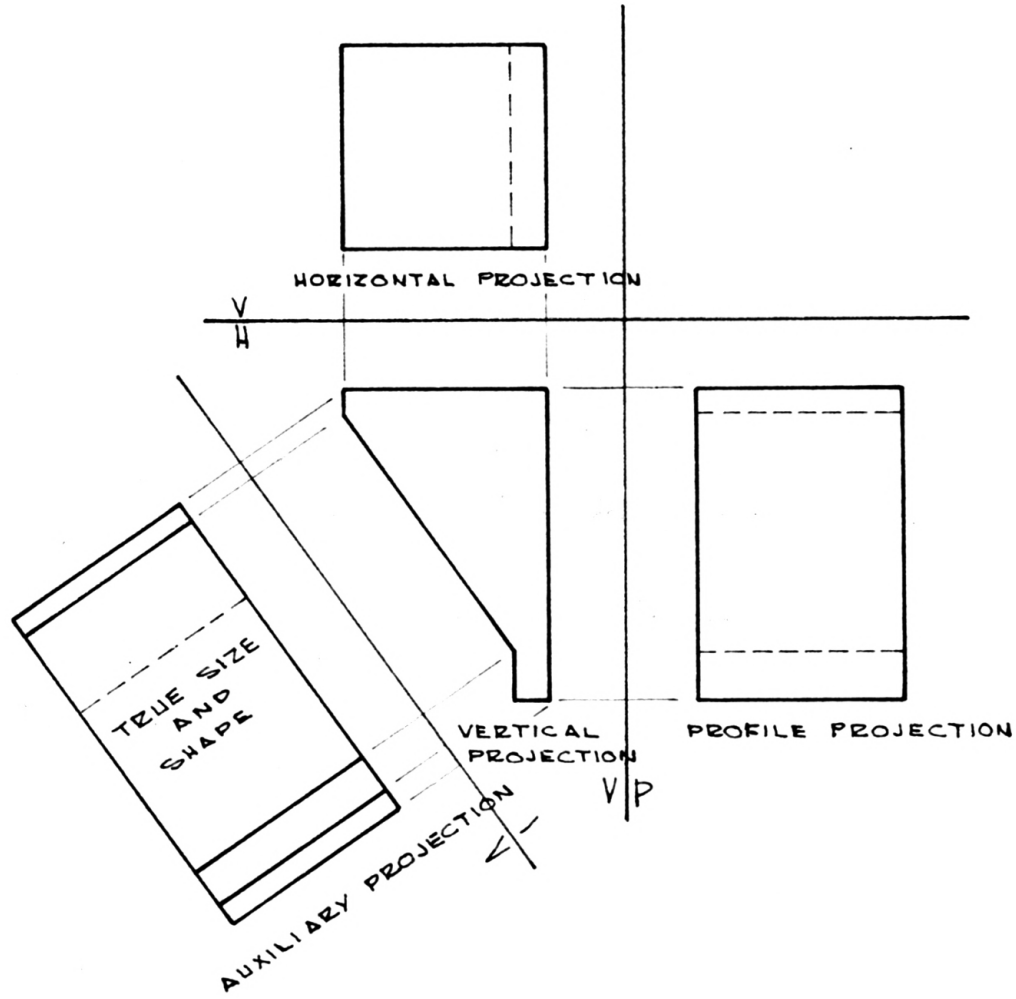

EXPLANATION OF PLATE XXV

Plane of an object that is perpendicular to the principal horizontal projection plane projected onto an auxiliary projection plane showing the true size and shape.

PLATE XXV

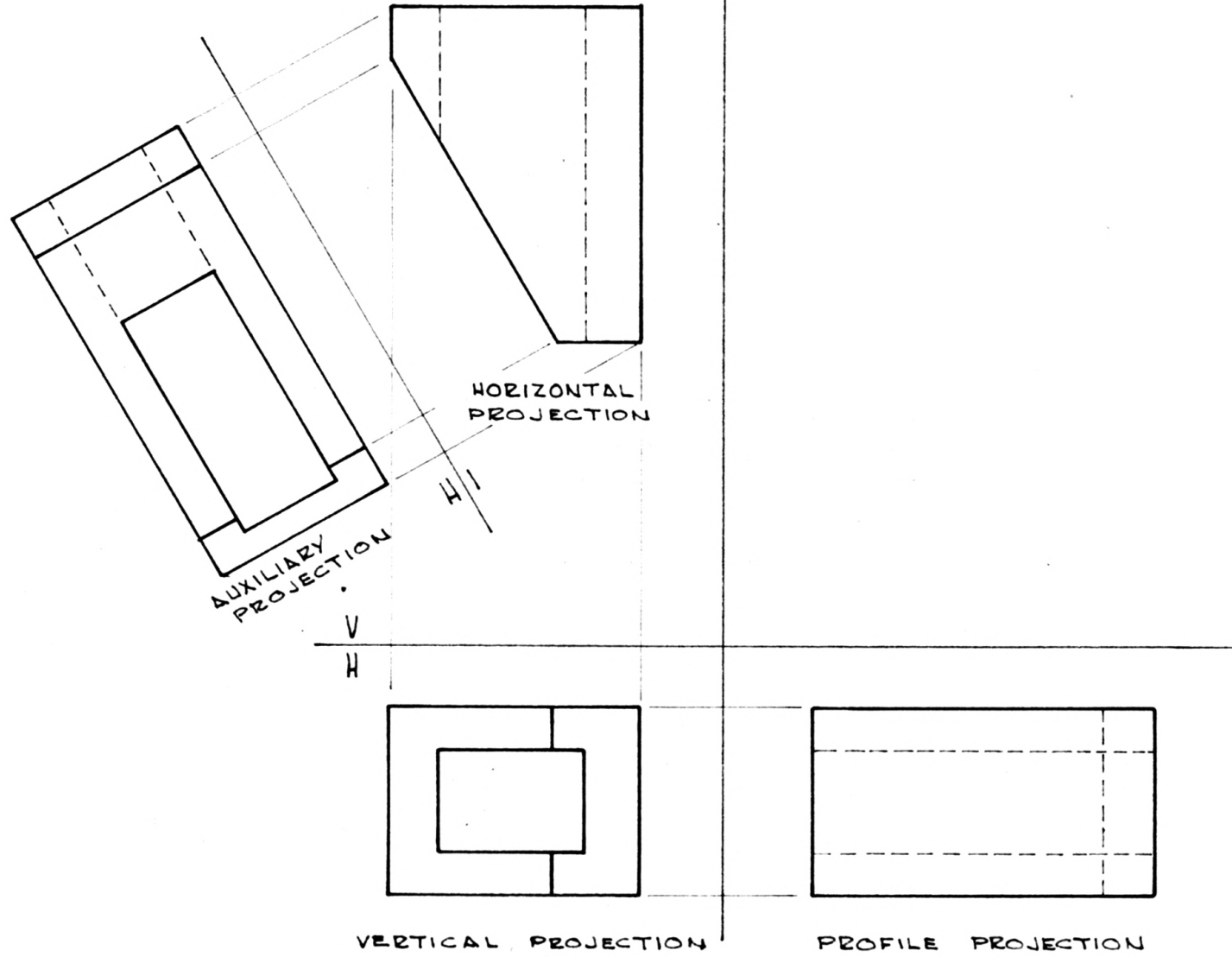

EXPLANATION OF PLATE XXVI

Plane of an object that is perpendicular to the principal profile projection plane projected onto an auxiliary projection plane showing the true size and shape.

PLATE XXVI

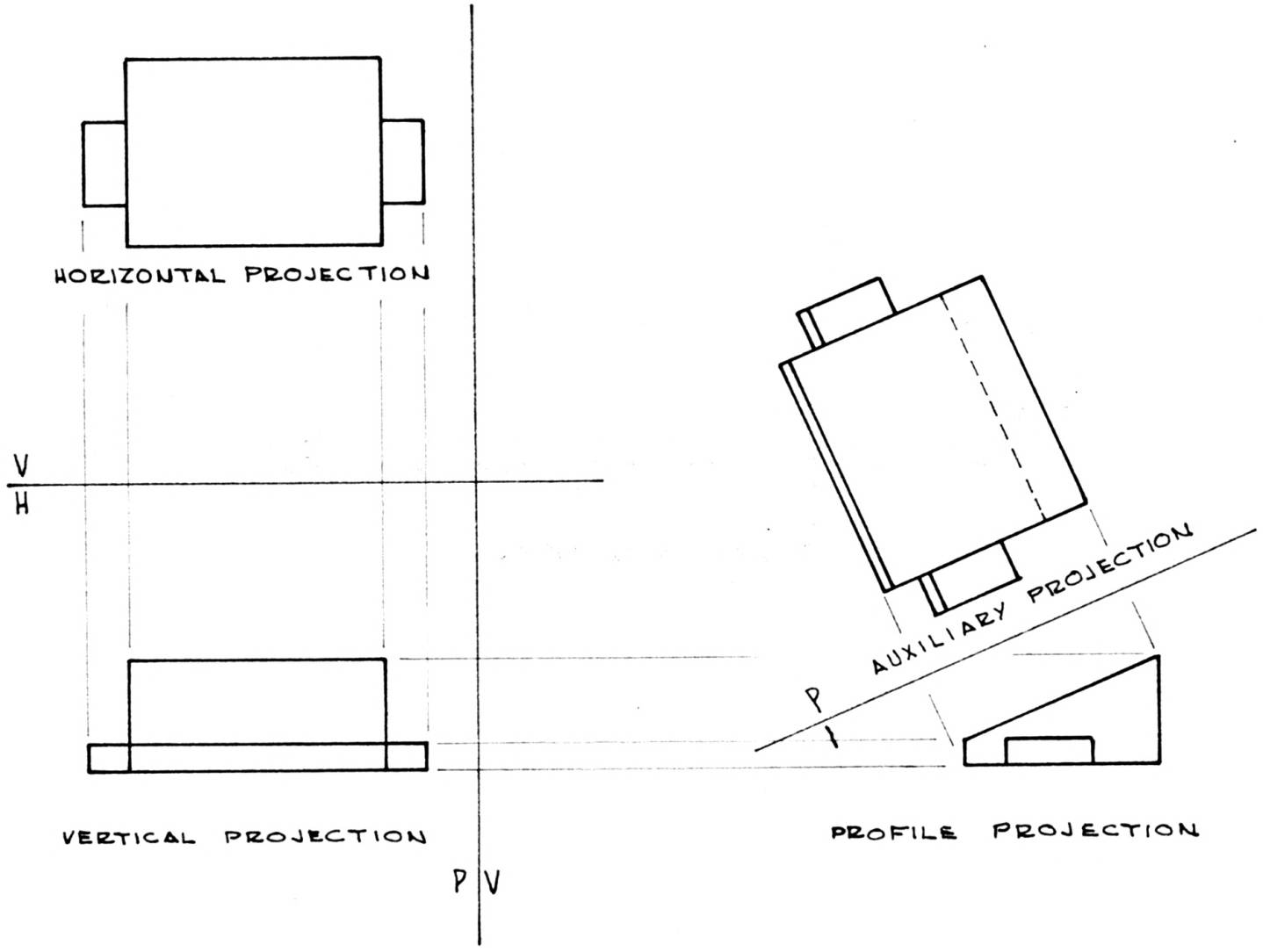

EXPLANATION OF PLATE XXVII

**Position of an oblique, or second auxiliary, projection
plane as related to the first auxiliary projection
plane.**

PLATE XXVII

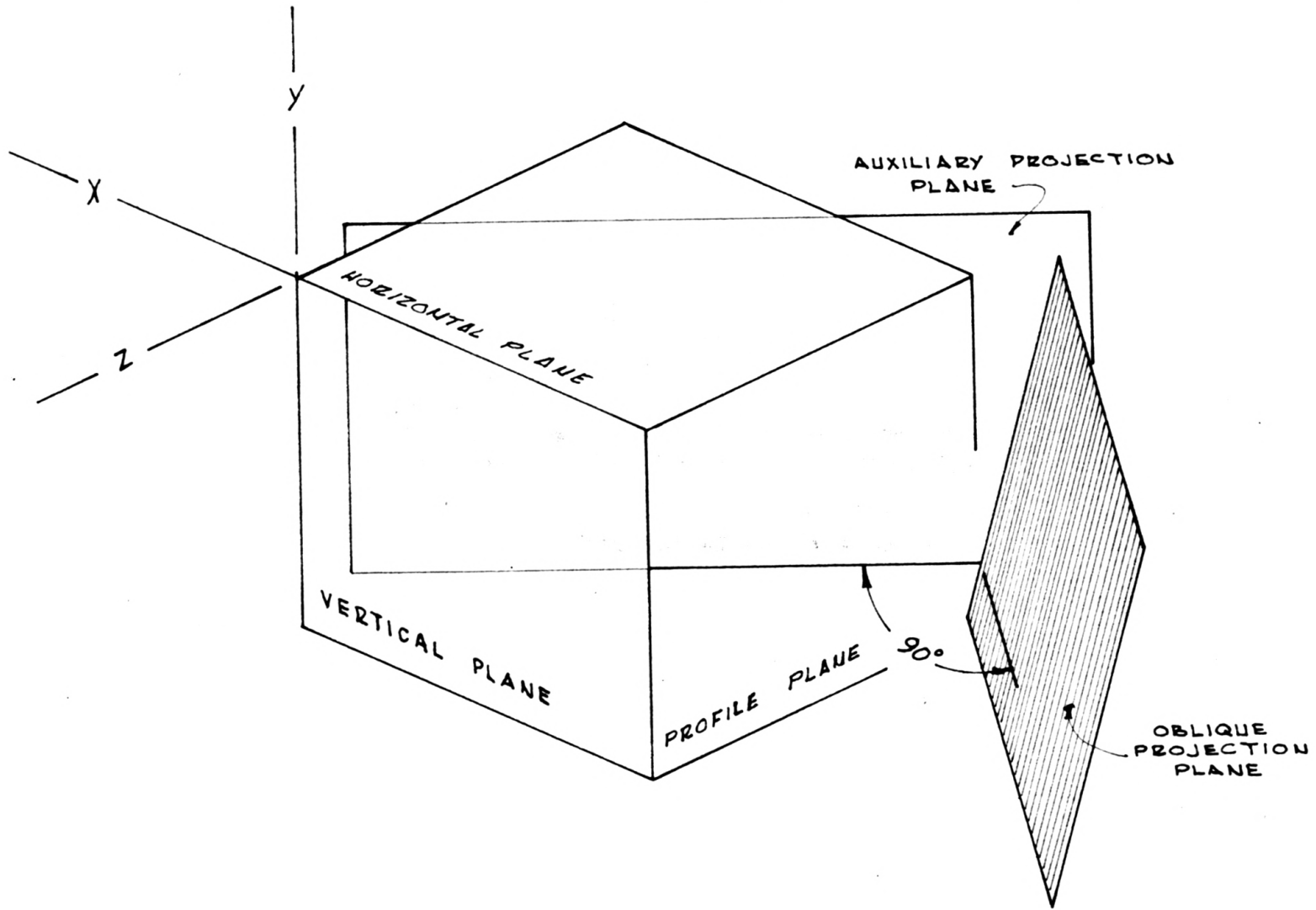

EXPLANATION OF PLATE XXVIII

Revolving the oblique, or second auxiliary, projection plane into the plane to which it is perpendicular, first auxiliary plane, then revolving these two planes into the principal projection planes so all projection planes will be in one flat plane.

PLATE XXVIII

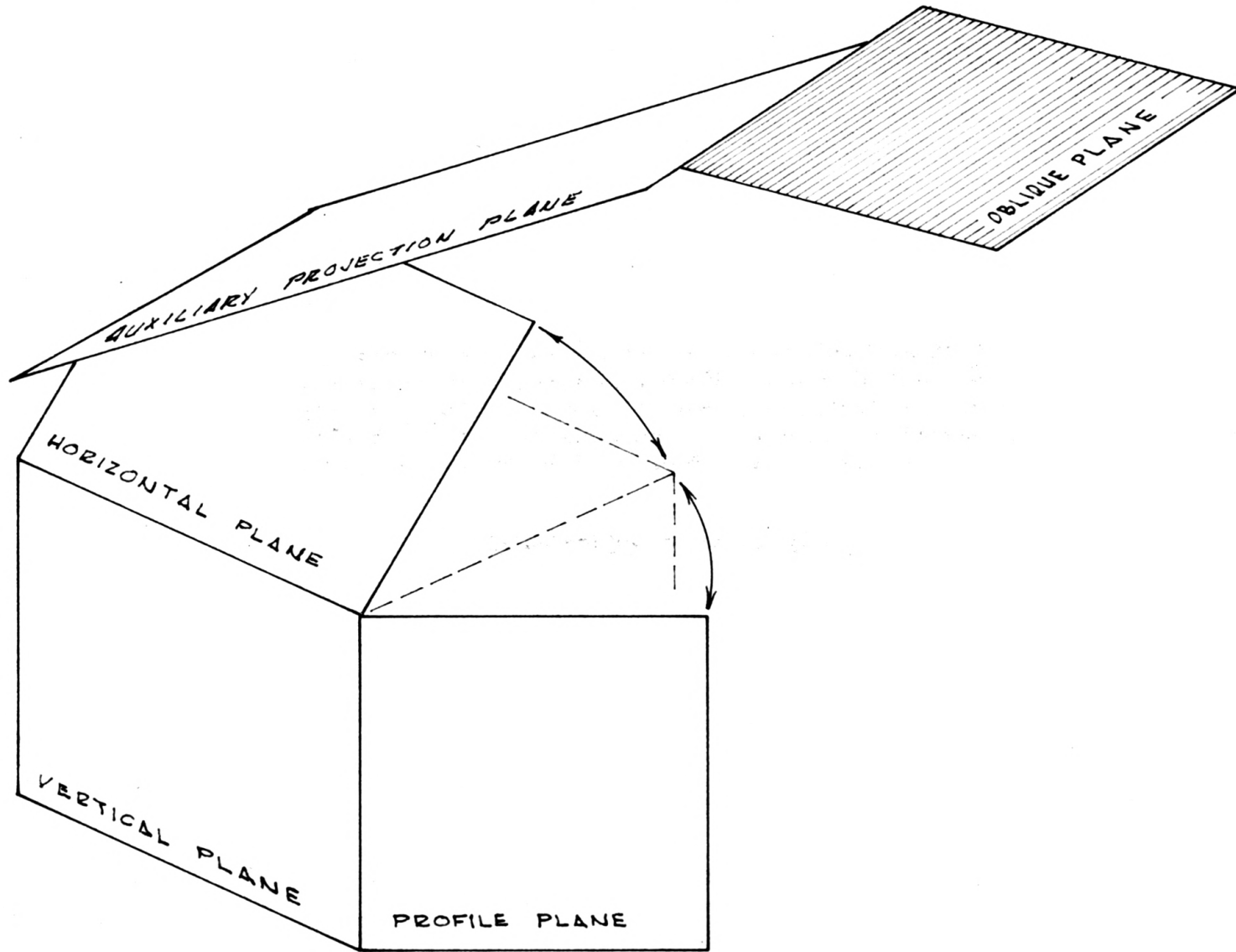

EXPLANATION OF PLATE XXIX

An oblique projection, or a second auxiliary projection, showing the true size and shape of a plane in an oblique position in the three principal view projections.

PLATE XXIX

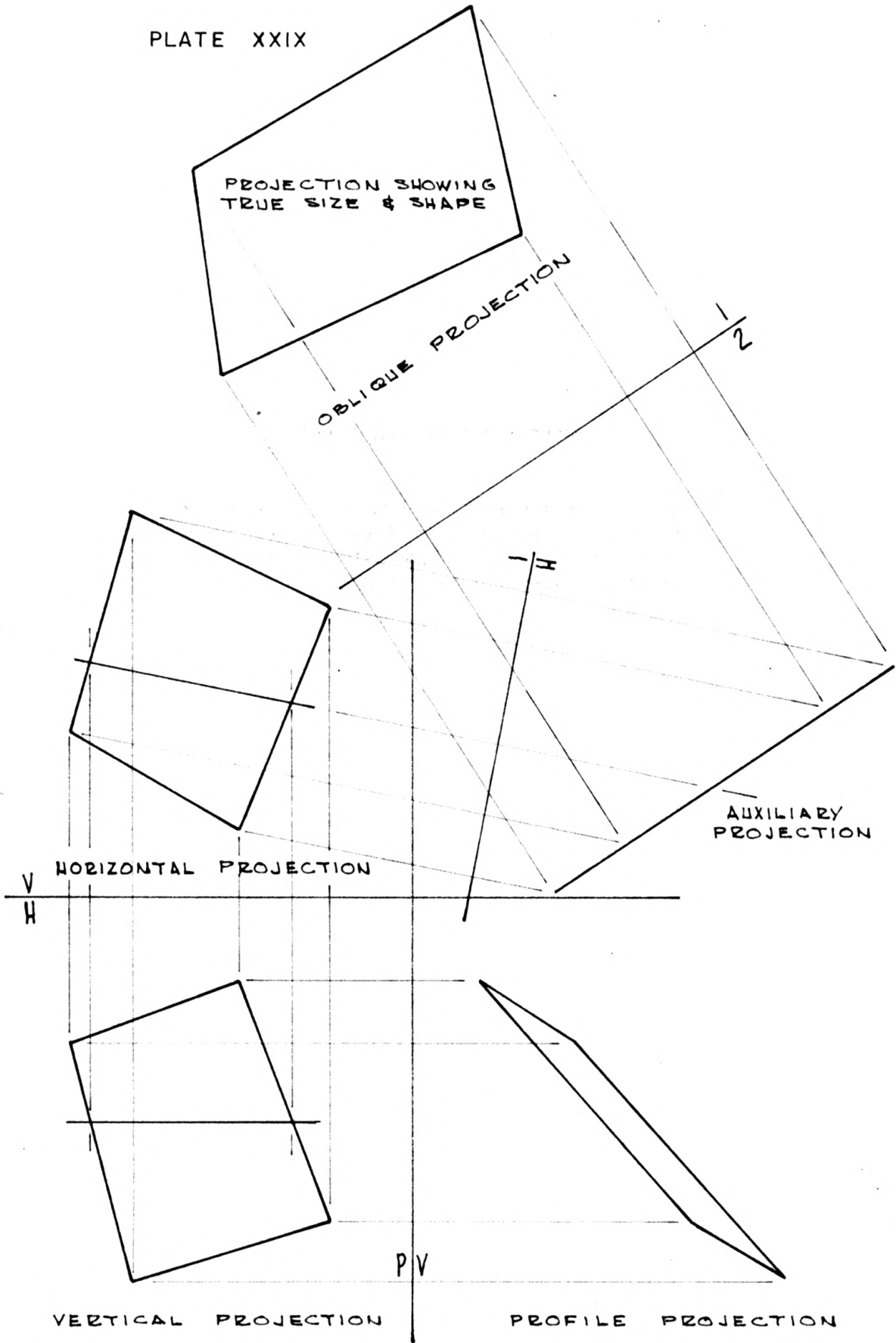

projection plane, parallel to the vertical projection plane, or parallel to the profile projection plane. Thus, the view showing an oblique plane on edge may be projected from any of the principal views. Once the oblique plane is projected into the auxiliary view showing the plane on edge, a projection plane is positioned parallel to the oblique plane on edge and projected onto this projection plane on edge. This projection plane is commonly termed the second auxiliary projection plane or the oblique projection plane. This second auxiliary projection plane is positioned so that it is perpendicular to the first auxiliary projection plane that is again positioned perpendicular to one of the principal projection planes. The second auxiliary projection plane and the first auxiliary projection intersect along a line of intersection that will act as an axis about which the second plane will be rotated conventionally into the plane to which it is perpendicular. Again, these two planes will be rotated into the principal projection planes.

Principal views, auxiliary views, and oblique views include all the types of orthographic views that it is possible to draw. These three types of views require the use of all possible directions in which objects may be observed.⁷

The preceding explanations and drawings describe the exterior size and shape of an object or building using hidden lines to indicate the hidden or interior features. If an object contains many complex features, the exterior views would result in a mass of hidden lines, which are annoying to construct and difficult to decipher. It would also be very difficult to explain the location of any materials with hidden lines.

⁷George J. Hood, Geometry of Engineering Drawing, p. 39.

The position of the walls of a building, for instance, may be indicated by using hidden lines in the roof plan. However, one would become confused if an attempt is made to show the various materials involved or the location of all the special features. To properly describe the interior of an object, one or more views showing the object in section are drawn.

The sectional view is obtained by passing an imaginary cutting plane through the object and constructing a projection showing the portion of the object where the cutting plane passed through. A sectional view of an apple can be constructed by passing a cutting plane through the axis. Now one of the resulting halves of the apple is removed and the exposed interior becomes a sectional view. Since the cutting plane has passed completely through the object, the sectional view is termed a "full section."⁸

The location of the imaginary cutting plane is indicated on a drawing by a cutting plane symbol. This symbol is a line which consists of two short dashes $1/8$ inch in length and one long dash $3/4$ to $1\ 1/2$ inches in length, spaced $1/32$ inch apart, drawn by eye. The complete cutting plane line symbol is heavier and darker than the object lines, and is often drawn with a grade H pencil. The arrows located at the ends of the cutting plane line symbol denotes the direction of sight in which the view is taken. If the cutting plane is passed through the object in the front view, or vertical projection, parallel to the profile projection plane, the arrows are directed away from the profile projection plane. That portion of the object between the cutting plane and the profile projection

⁸American Society of Mechanical Engineers, American Standard Drafting Manual, Section 2, p. 11.

EXPLANATION OF PLATE XXX

A cutting plane passed through an object.

PLATE XXX

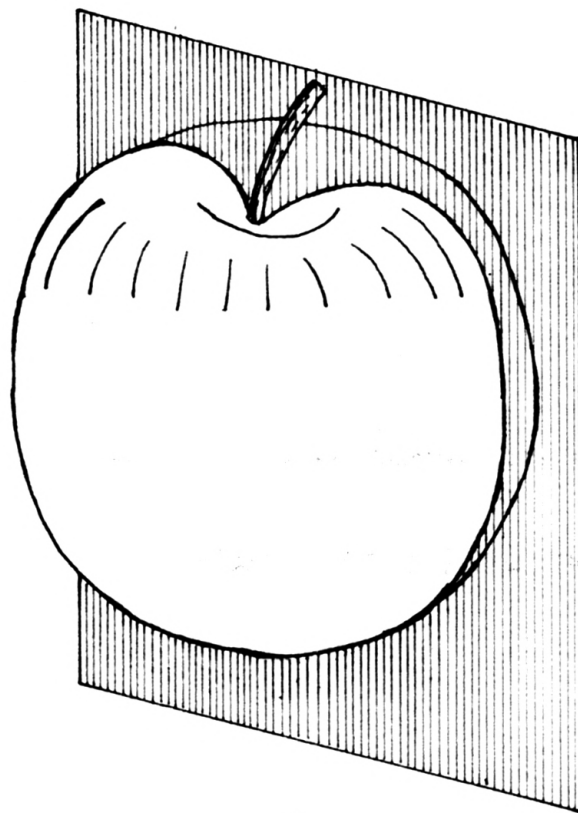

EXPLANATION OF PLATE XXXI

Illustration showing the remaining half of an object exposing the interior construction after the portion between the cutting plane and the observer has been removed.

PLATE XXXI

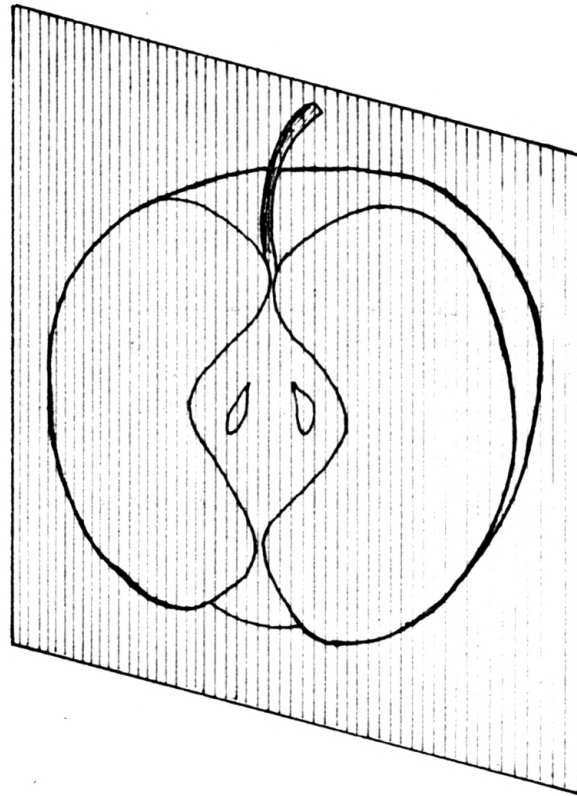

EXPLANATION OF PLATE XXXII

**View showing the observer's direction of sight
and the object after the cutting plane has been
removed.**

PLATE XXXII

DIRECTION OF
SIGHT →

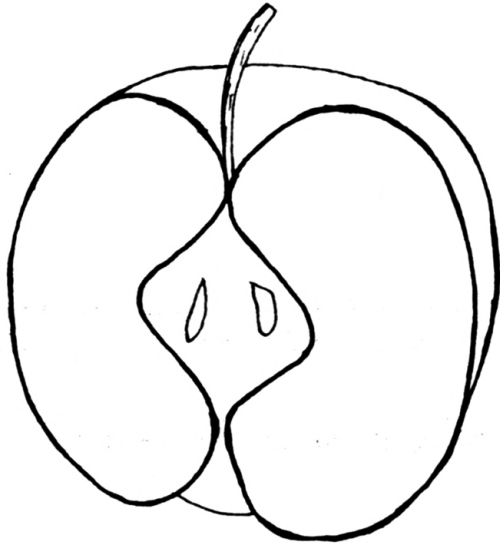

EXPLANATION OF PLATE XXXIII

Cutting-plane line symbols, shown on a drawing to indicate the edge view of the cutting plane's position when passed through an object.

PLATE XXXIII

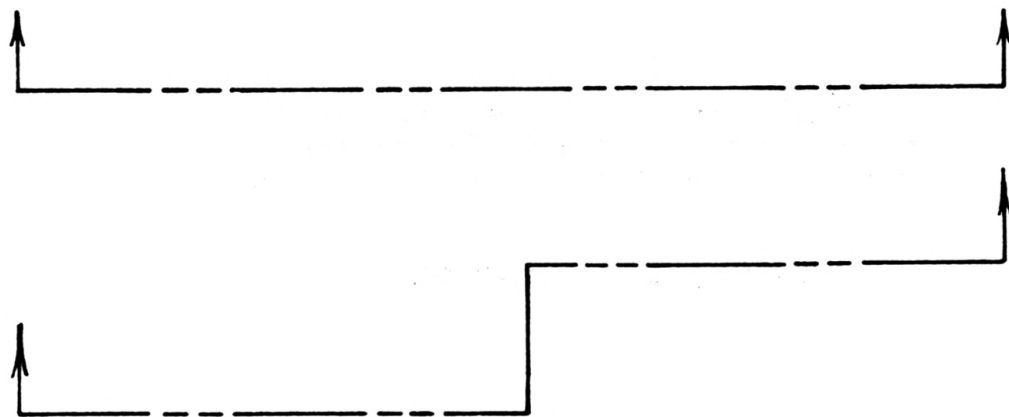

plane is imagined to be removed when the sectional view is constructed. The sectional view is constructed by projecting that portion of the object located on the side of the cutting plane in the direction of the arrows onto the profile projection plane. When the cutting plane is passed through the object in the top view, or horizontal projection, parallel to the vertical projection plane, the arrows are directed away from the vertical projection plane. That portion of the object between the cutting plane and the vertical projection plane is imagined to be removed and the vertical projection of the remaining portion of the object is constructed.

A cutting plane may be passed through an object in any of the principal projections or in any of the auxiliary projections. The sectional view is obtained by projecting the portion of the object in the direction of the cutting plane line arrows, onto a projection plane parallel to the cutting plane. Any sectional view constructed in an auxiliary projection is referred to as an auxiliary section.

The material which the cutting plane passes through is indicated by section lining. Section lining may indicate the various materials from which the object is constructed, or consist of light, fine, evenly spaced lines drawn across the cut surface. These lines are spaced approximately $1/16$ inch by eye and may be constructed at any angle from the horizontal. However, 45° is usually used. In general, the larger the object the greater the space between the section lines. The direction of the section lines should be chosen so they are not parallel or perpendicular to any of the object lines of each part.

Oftentimes, the cutting plane may pass through adjoining parts of the same material or the adjacent materials may be of a different nature. If

EXPLANATION OF PLATE XXXIV

**A full sectional view of an object projected in
it's normal view position with section lining
used to indicate the cut surface.**

PLATE XXXIV

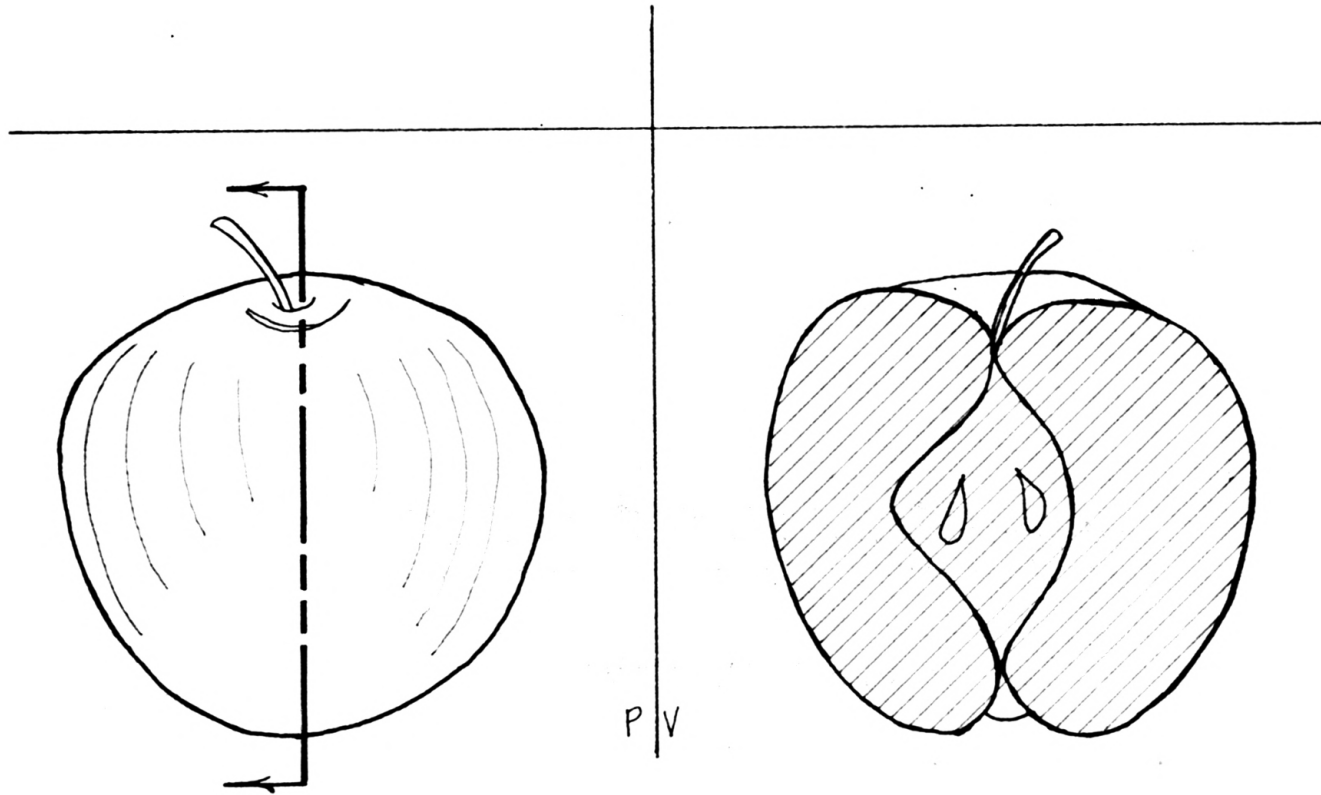

VERTICAL PROJECTION

FULL SECTIONAL VIEW

the parts are of the same material, the slope of the section lining should be changed between adjoining parts. If the adjoining parts are of different materials, standardized symbols may be used to designate each material. A cutting plane may pass through the same part at different locations. When this situation arises, the section lining should have the same slope in each of these locations.

It is accepted practice to pass the cutting plane through the axis of shafts, rods, bolts, nuts, keys and other fasteners. However, these parts will not be shown in section in the sectional view as they have no internal parts. Instead, these items will appear in the sectional view as though they had not been affected by the cutting plane.

On objects having a major center line, the cutting plane may be omitted if it is already clear that the section is taken along that center line.⁹

If the imaginative cutting plane is extended only halfway through the object and one-fourth of the object is removed, the resulting view projection is termed a half section. This sectioning technique is generally applied to objects that are essentially symmetrical and where it is desired to show interior features as well as exterior features in one view projection. The half sectional view maintains the same view relationships as other orthographically projected views. If the cutting plane is positioned halfway through the object in the front view, parallel to the profile projection plane, the arrow on the cutting plane line symbol is directed away from the profile projection plane. The one-fourth portion of the object between the cutting plane and the profile

⁹Ibid., p. 10.

EXPLANATION OF PLATE XXXV

A half sectional view of an object, obtained
when the cutting plane is extended halfway.

PLATE XXXV

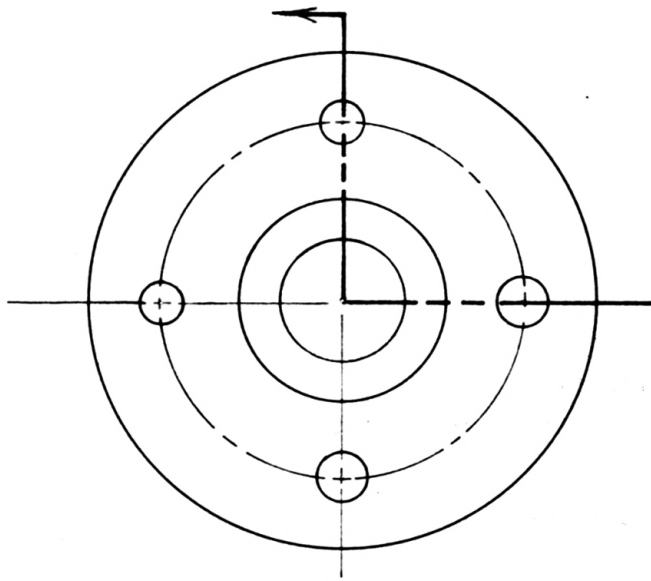

FRONT VIEW

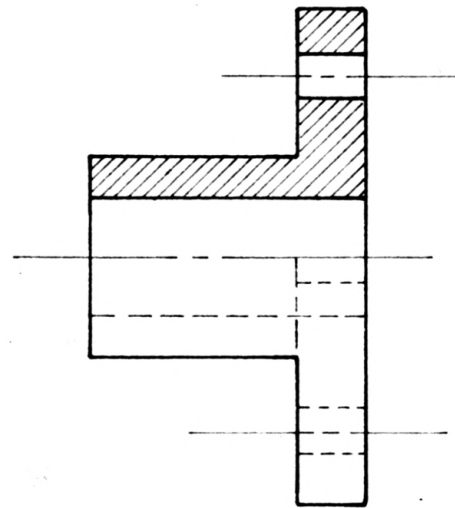

HALF SECTION

projection plane is imagined to be removed when the sectional view is constructed. The half sectional view is constructed by projecting that portion of the object located on the side of the cutting plane in the direction of the arrow onto the profile projection plane along with that portion of the object not affected by the cutting plane onto the profile projection plane and constructing the profile projection. Thus, the projection methods used for obtaining the half sectional view are the same as those used for the exterior views of an object combined with the view projection of a full section. In the half sectional view projection, a center line or a visible line may be used to divide the unsectioned portion from the sectioned portion. Since the cutting plane extends only halfway through the object, one arrow is used with the cutting-plane line symbol to denote direction of sight for the half sectional view. If it is obvious from the half sectional view where the cutting plane has been passed through the object, the cutting-plane line symbol need not be shown on the other view projections.

It is stated in the American Drafting Standards Manual, published by the American Society of Mechanical Engineers, that the cutting plane may be bent or offset in order for the sectional view to more clearly explain the interior features. Many authors refer to this type of sectional view as an offset section. This sectioning method is used where it is desirable to show many interior features of an object that are not located in a straight line. When the cutting plane is stepped or offset, the offsets are made using 90° angles. The offsets are not shown in the sectional view and the sectional view is drawn as if it were in one plane. The methods used in projecting an offset sectional view are the same as for

EXPLANATION OF PLATE XXXVI

A full sectional view obtained when an offset cutting plane is passed through an object; oftentimes referred to as an offset section.

PLATE XXXVI

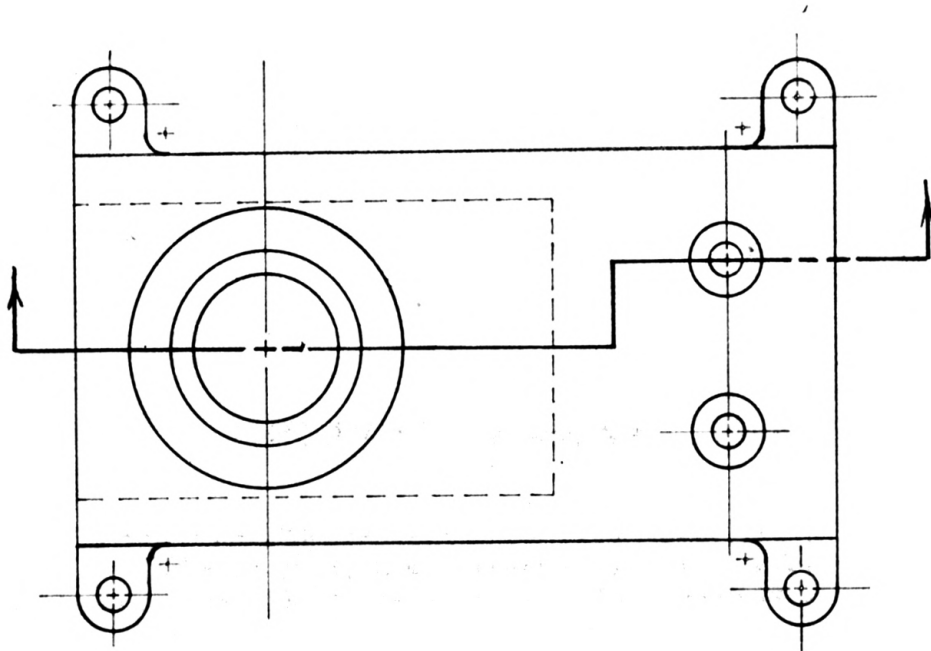

TOP VIEW

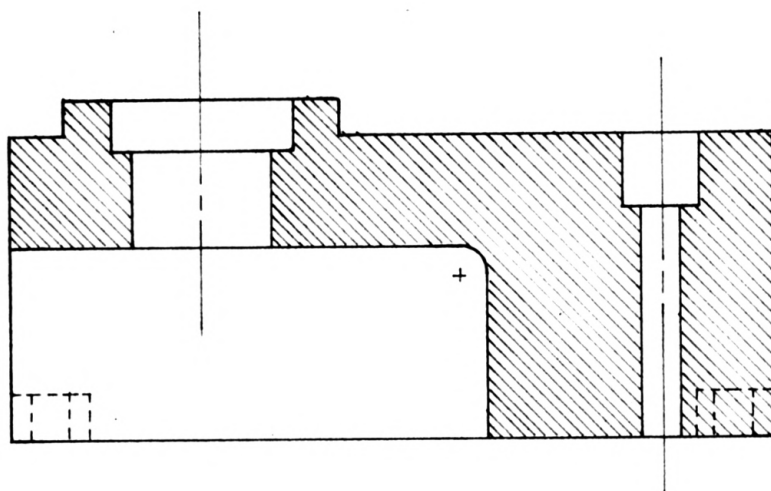

OFFSET SECTIONAL VIEW

EXPLANATION OF PLATE XXXVII

**Revolved sectional views.
(ASA Y14-2-1957)**

PLATE XXXVII

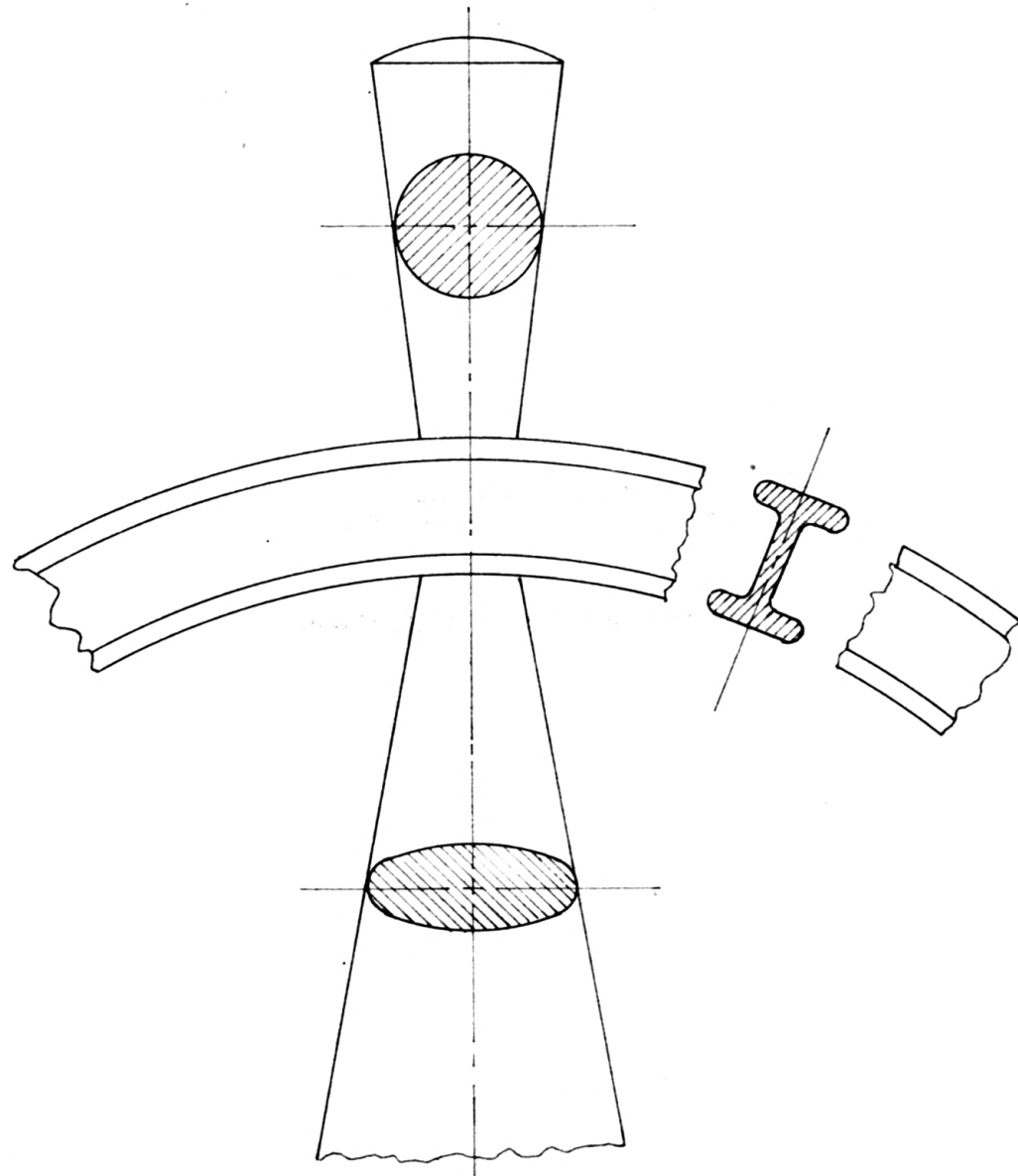

previous sectional views. If it is obvious in the offset sectional view where the cutting plane was located, it need not be shown in the other views of the object.

A sectioning technique referred to as a revolved section is used for elongated objects such as beams, shafts, spokes, or arms and is obtained by passing a cutting plane perpendicular to the axis of the object forming a slice infinitesimal in thickness that is rotated in place 90° about its own axis into the plane of the object's view. The visible lines on each side of the revolved section may be removed or retained. If they are removed, break lines are used to terminate the lines on both sides of the revolved section.

A sectional view does not always have to be drawn in its normal projected view position, ". . . in which case it becomes a removed section."¹⁰ A rotated section may be removed from the view of the object and drawn in another location on the paper, or on a center line extended from the object where the cutting plane is located. In this case, it again becomes a removed section. The advantage of constructing removed sectional views is that these views may be drawn to a larger scale than the views of the object. To maintain clarity throughout the drawing, the removed sectional views should not be rotated but be drawn so that ". . . its edges or center lines are parallel to the corresponding lines in the normal projected position."¹¹

In some instances, a complete sectional view of an object is not

¹⁰Ibid., p. 12.

¹¹Ibid., p. 14.

EXPLANATION OF PLATE XXXVIII

A removed sectional view redrawn to a larger scale.

PLATE XXXVIII

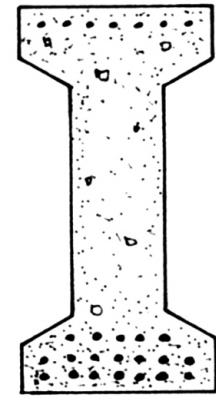
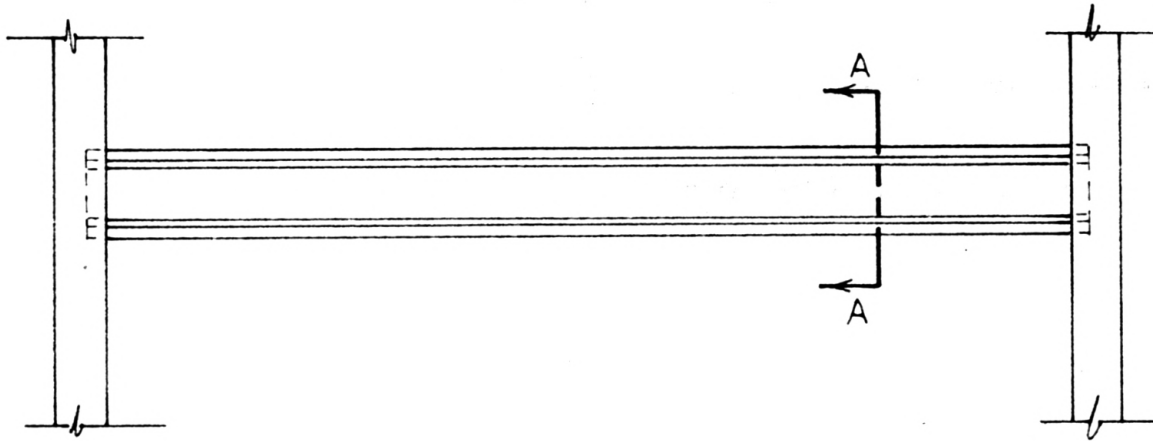

SECTION AA

EXPLANATION OF PLATE XXXIX

**Removed sections located on extended center lines
from the object.**

(ASA Y14-2-1957)

PLATE XXXIX

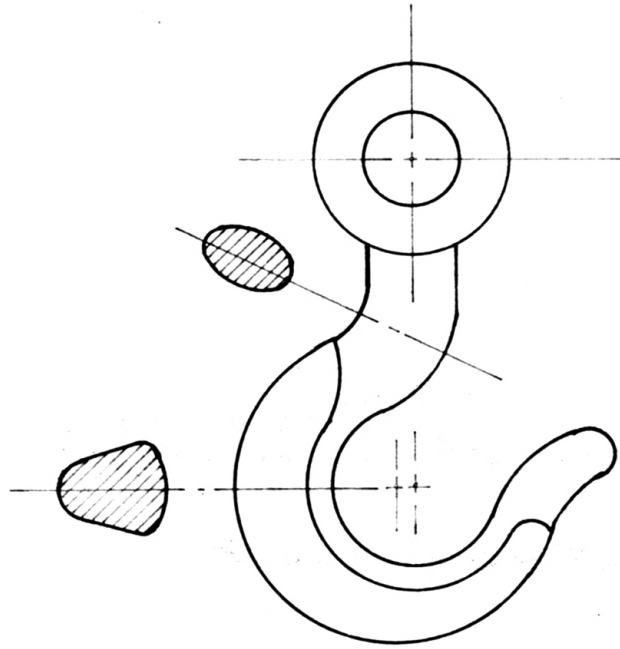

EXPLANATION OF PLATE XL

**A broken-out sectional view showing only a portion
of an object in section.**

PLATE XL

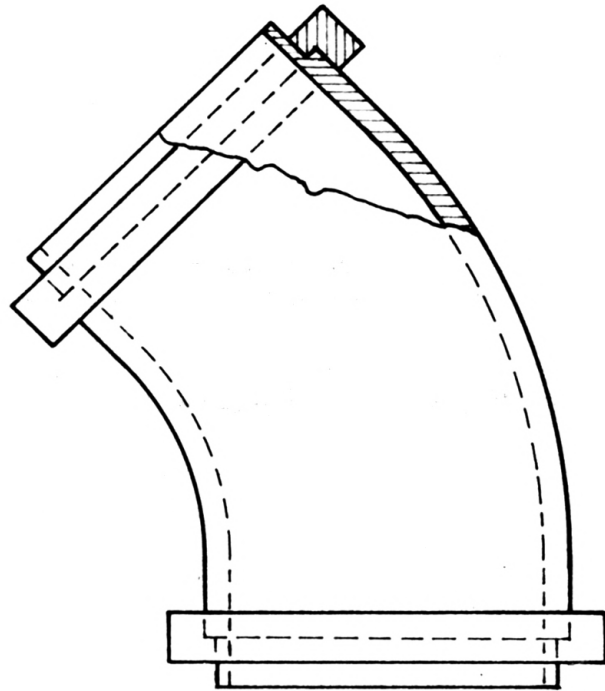

EXPLANATION OF PLATE XLI

A phantom section showing the position of a related object.

PLATE XLI

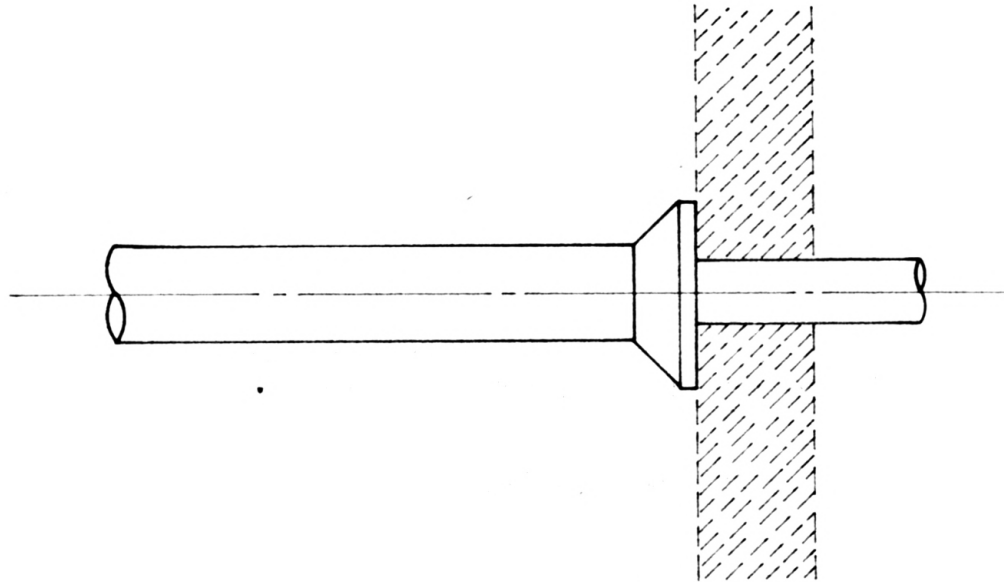

PHANTOM SECTION

necessary, as only a portion of the object in section is needed to fully explain the interior construction. If a small piece of the object is imagined to be removed from a view of the object, and the remaining portion is treated as a sectional view, the view becomes a "broken-out section."¹² The boundary of the break area is shown on the drawing by a break line.

A sectioning technique not discussed in the American Drafting Standards Manual, published by The American Society of Mechanical Engineers but found in many text books, is the phantom section. This type of section is drawn as if it were a hidden feature in a view of the object, but treated as a section. This method may also be used when indicating an adjacent part in connection with a normal projected view of an object.

There are virtually no published organized drafting standards for the architectural profession as compared to the standards set forth by the American Society of Mechanical Engineers. The ASME standards are followed throughout all industry so that drawings may be easily read and understood by any workman. The American Institute of Steel Construction has also set up drafting standards for design drawings which their engineers prepare. These standards include methods of indexing columns and column schedules that may be found in the structural section of a set of architectural working drawings.

The drafting methods used by the present-day architect are found, for the most part, to be evolved from general office practice established

¹²Ibid., p. 12.

by each architectural firm. The overall organization of a set of working drawings seems to be standardized as nearly all contain floor plans, elevations, and detailed sections. A floor plan has become a common drawing to everyone as it is seen in publications and recognized as a basic layout or scheme for a structure. The use of the plan view dates back many centuries when man first began to build structures and was used as a guide to the basic layout of the structure.

While some drawings are common to all people involved in and with the architectural profession, a fundamental approach should be established for instructing the draftsman who prepare working drawings, as well as those who use them, to gain more organization and better interpretation. The basic fundamentals for all drafting work is projection drawing. Once an individual has this knowledge, more extensive training can be developed in the area of architectural working drawings. It is in this area that organization of learning patterns must be established correlating new architectural drafting standards with those already in existence.

Perhaps it should be pointed out why the American Drafting Standards Manual published by the American Society of Mechanical Engineers is not fully adequate for the architectural profession. The general practice of architecture has established some methods of preparing drawings due to the type of work in which the architect is involved. However, some phases of the architect's working drawings are consistent with the ASME standards. For instance, the floor plans, and foundation plans are full sections and are related to the elevation views just as any full sectional view is related to any of the principal view projections. Therefore, it would be correct to locate the cutting-plane line symbol on the elevations to

indicate where the full section, floor plan, was taken. Since it is apparent from the elevation views where the cutting plane was located when the floor plan was drawn, it is established architectural practice not to indicate the cutting-plane line symbol on the elevations. The ASME drafting standards state, "On objects having one major center line, the cutting plane may be omitted if it is already clear that the section is taken along that center line."¹³ Architectural elevations rarely have center lines, so this requirement is inadequate.

A set of architectural working drawings usually contains vertical sectional views, oftentimes referred to as longitudinal or transverse sections, through the entire structure. These sectional views are constructed from the information shown on the plan views, occasionally referred to as a horizontal full section, by imagining a cutting plane being passed through the floor plan. When this large vertical sectional view is drawn, it is constructed as though the cutting plane had been passed completely through the entire building from roof to foundation. Theoretically, when the cutting plane is passed through the floor plan of a one-story structure, only one-fourth of the structure remains when the sectional view is projected. However, the sectional view is projected and drawn as though the entire structure existed above that shown on the floor plan. This is a situation where a sectional view is projected from a view which is a sectional view. This aspect of projecting sectional views is not outlined in the ASME drafting standards. It is

¹³Ibid., p. 10.

also the usual practice for the architect to show the cutting-plane line symbol on the sectional views, such as floor plans, when projecting the vertical full sections. This practice is contrary to the ASME drafting standards which read as follows: "The cutting-plane line preferable should be shown through an exterior view and not through a sectional view."¹⁴ In keeping with the ASME standards, the cutting-plane line symbol should be located in the top view of the building, commonly referred to as the roof plan. This practice would be quite inconvenient for the architect, as the cutting plane must be located in the floor plans, in order for the vertical full sectional view to be properly projected and interpreted by others. This vertical section may, in some cases, be projected from an offset cutting plane. When preparing working drawings, it is necessary to project a sectional view from a view already in section to fully explain the construction detail of the structure.

A person entering the architectural profession or anyone who uses architect's drawings should be trained in visualizing the third dimension of an element from a two dimensional drawing. This is particularly important for the architectural draftsman as a great amount of third dimensional visualization is required when constructing the various view projections.

It is not always possible for the architect to project the many views of the structure or any of it's parts and maintain the normal view relationships as oftentimes only one view may be constructed on one sheet of paper.

¹⁴Ibid., p. 11.

Therefore, the architectural draftsman must be able to visualize each individual view as each view is drawn separately. The views of small elements of the structure may be entirely shown on one sheet of paper maintaining the normal projected view locations.

An indication can be gained from the partial set of working drawings, enclosed herein, of the many views and sections required to fully explain the fabrication of the structure. Due to the fact that many of the views are not in their normal projected location, but found on another sheet, a standardized indexing scheme and a more standardized layout of the complete set of drawings is desirable. This would be a great aid in the drafting room as there are usually several draftsmen involved with each project. If each draftsman is familiar with a standardized layout method and indexing scheme, time will be saved in organizing the information to be shown on the drawings and all individual drawings will have an over-all continuity when assembled into the final set. This would mean all methods for describing sections and other view projections would be constructed with the same technique and symbols for every drawing by all draftsmen.

For those who use the drawings to fabricate the structure, standardized drafting methods would aid these individuals in locating certain information and would lessen errors in interpretation. A standardized indexing system would help an individual to become acquainted with the over-all set as to where each drawing showing certain information would be located in the set. If the same standardized graphical view projection methods and indexes were used in every architect's office, the result would be a graphic language known to everyone who would come in contact with the drawings for the purpose of interpreting information.

Several cutting planes may be located on the same view projection. Thus, some indication must be made on or near the cutting-plane line symbol and the projected sectional view to indicate their relationships. The ASME drafting standards make the following statement:

Bold capital letters such as A-A, B-B, C-C, etc., are used, if necessary, to identify the section. If the section is removed or for any reason needs to be identified, a note is lettered boldly under the view, as SECTION A-A.¹⁵

This reference, or indexing scheme, is adequate when all view projections are on the same sheet, which is seldom the case in architectural working drawings. However, the ASME drafting standards also specify a scheme for this situation.

On multiple-sheet drawings where it is not practicable to place a removed section on the same sheet with the regular views, identification and zoning references should be indicated on related sheets. Below the section title, the sheet number where the cutting-plane line will be found should be given, as:

SECTION B-B
ON SHEET 4, ZONE A3

A similar note should be placed on the drawing where the cutting-plane is shown, with a leader pointing to the cutting-plane line, referring to the sheet where the section will be found.¹⁶

The zone method is inadequate for the architect's working drawings as there seems to be too many view projections on many of the sheets. The note, as specified in the ASME standards, to be located near the cutting-plane line symbol may be confused with the other notes required on the drawings. For this reason, a new symbol should be devised for clarity and over-all organization.

¹⁵Ibid., p. 10.

¹⁶Ibid., p. 12.

CONCLUSIONS

It seems apparent from the information discussed in this thesis, that comprehensive drafting standards outlining the requirements used in the preparation of some phases of architectural graphical representation is desired. The theory of projecting views and view relationships, has been discussed relating to the projection of sectional views, particularly for the sections used for architectural working drawings. The requirements set forth in the American Drafting Standards Manual, published by the American Society of Mechanical Engineers was discussed and the inadequacies of these standards explained in regard to the architectural work.

It is the objective of this thesis to compile a drafting standard for architectural work in the area of sectioning methods and an indexing scheme to be used in working drawings. This would not only act as a reference for the architect's office, but would be of particular value in the training of individuals who prepare working drawings as well as those who use these drawings in the fabrication phases of the structure.

EXPLANATION OF PLATE XLII

Part 1

A photograph of an architectural presentation used for public display showing the elevations and a perspective rendering for a proposed structure.

PLATE XLII

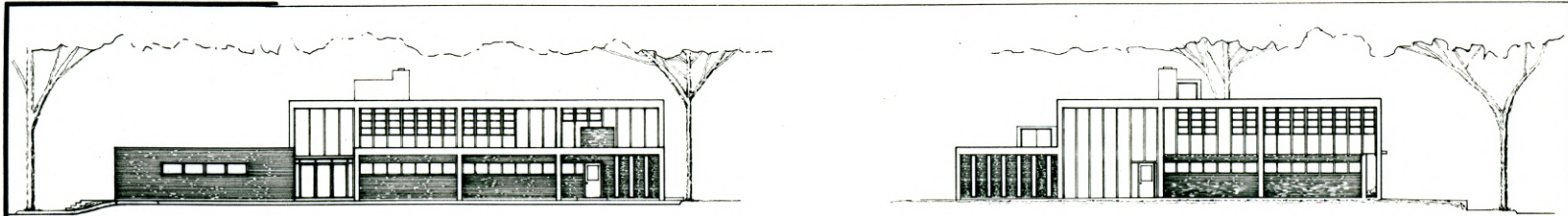

REAR ELEVATION 1/8" = 1'-0"

LEFT ELEVATION 1/8" = 1'-0"

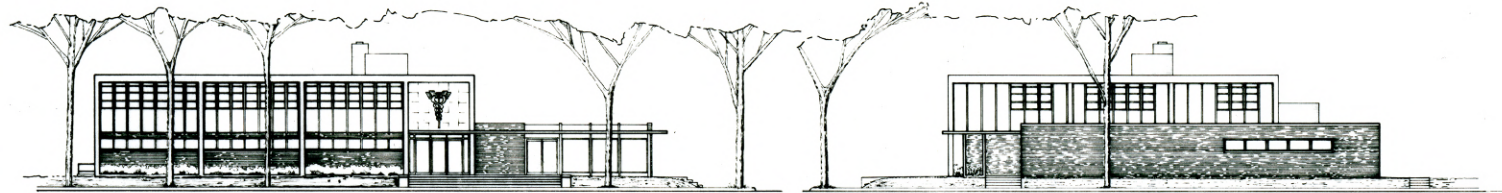

FRONT ELEVATION 1/8" = 1'-0"

RIGHT ELEVATION 1/8" = 1'-0"



A MEDICAL CLINIC AND PROFESSIONAL BUILDING

FOR
1200 FREMONT STREET
MANHATTAN, KANSAS

CHARLES D. BISSEY
STUDENT ARCHITECT
KANSAS STATE UNIVERSITY
MANHATTAN, KANSAS

EXPLANATION OF PLATE XLIII

Part 2

A photograph of an architectural presentation used for public display showing the plan view and site plan for a proposed structure.

EXPLANATION OF PLATE XLIV

A half size blueprint of sheet 3 of a partial set of architectural working drawings showing the basement floor plan.

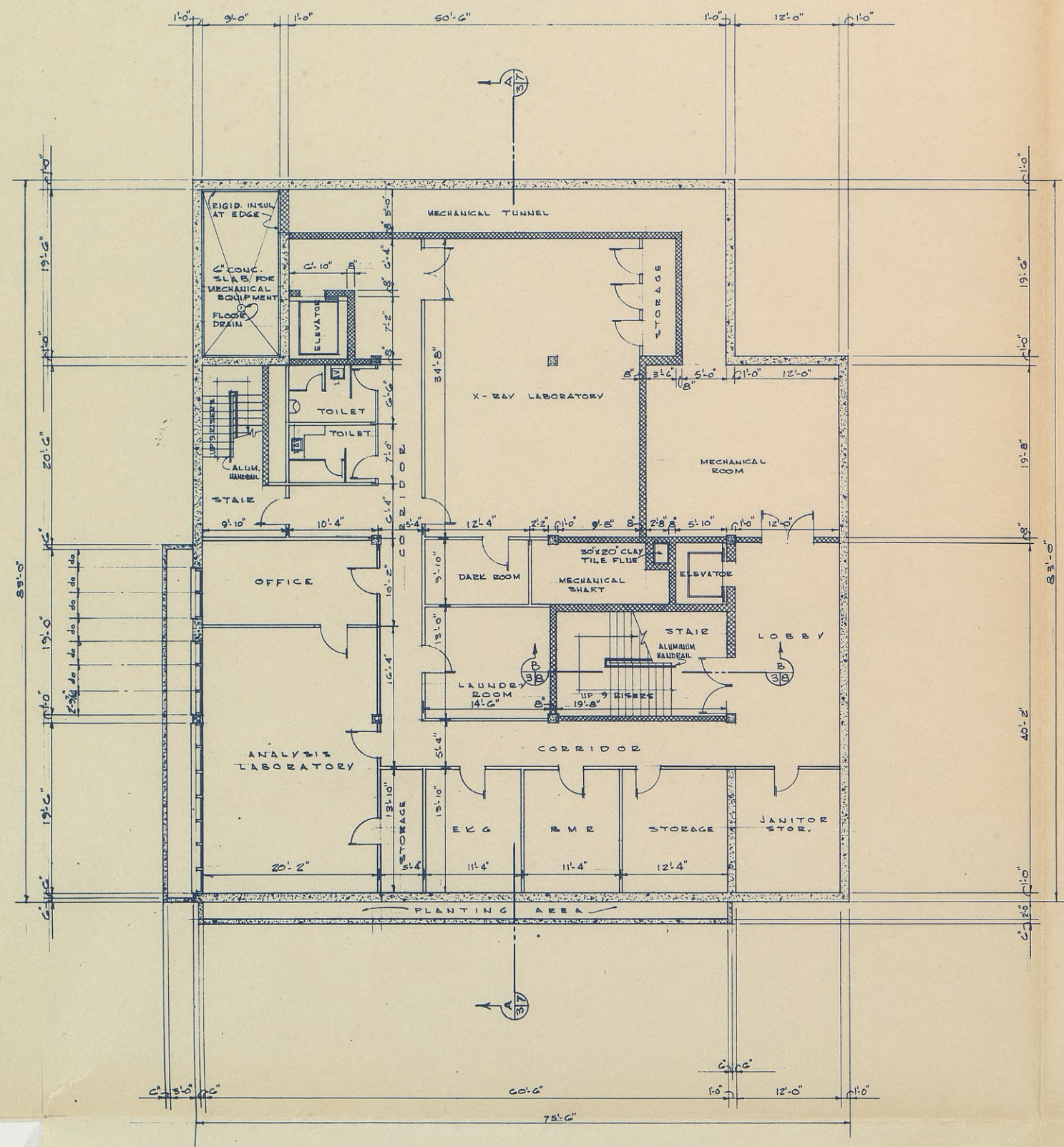

BASEMENT FLOOR PLAN
 SCALE 1/8" = 1'-0"

A MEDICAL CLINIC AND PROFESSIONAL BUILDING
 FOR
 1200 FREMONT STREET
 MANHATTAN, KANSAS

CHARLES E. BISSEY
 STUDENT ARCHITECT
 KANSAS STATE UNIVERSITY
 MANHATTAN, KANSAS

COMM. _____	DRWN. CEB	SHEET NO.
DATE. JUNE 61	CHKD. _____	3
REVS. _____	APP. _____	OF

EXPLANATION OF PLATE XLV

A half size blueprint of sheet 4 of a partial set of architectural working drawings showing the main floor plan.

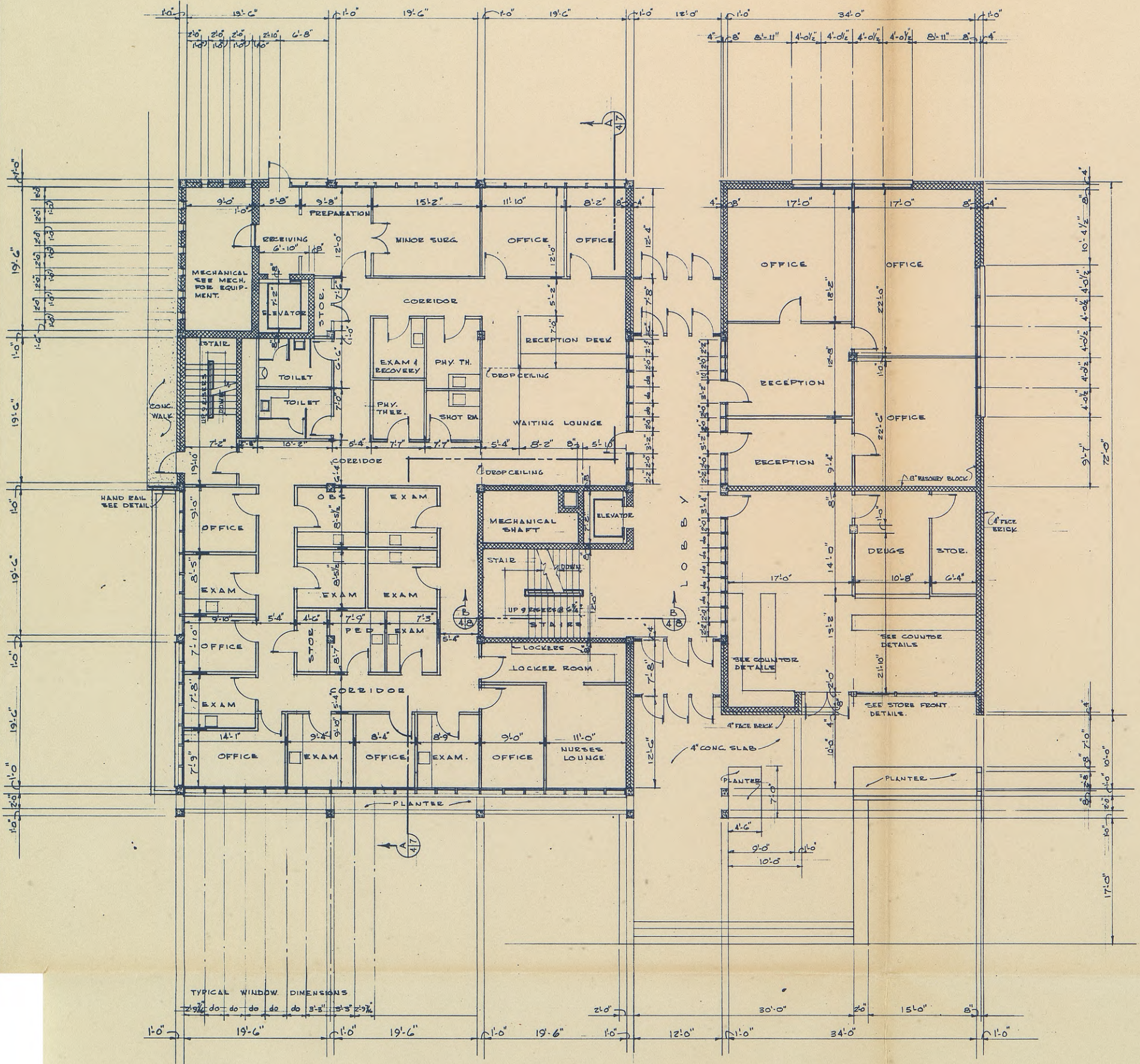

MAIN FLOOR PLAN
SCALE 1/8" = 1'-0"

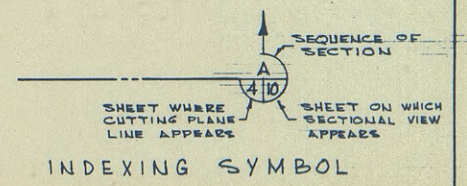

A MEDICAL CLINIC AND PROFESSIONAL BUILDING		
FOR		
1200 FEEBENT STREET		
MANHATTAN, KANSAS		
CHARLES E. BISSEY		
STUDENT ARCHITECT		
KANSAS STATE UNIVERSITY		
MANHATTAN, KANSAS		
COMM. _____	DEWN. CEB _____	SHEET NO.
DATE. JUNE 61	CKD. _____	4
ELVS. _____	APP. _____	OF

EXPLANATION OF PLATE XLVI

A half size blueprint of sheet 5 of a partial set of architectural working drawings showing the second floor plan.

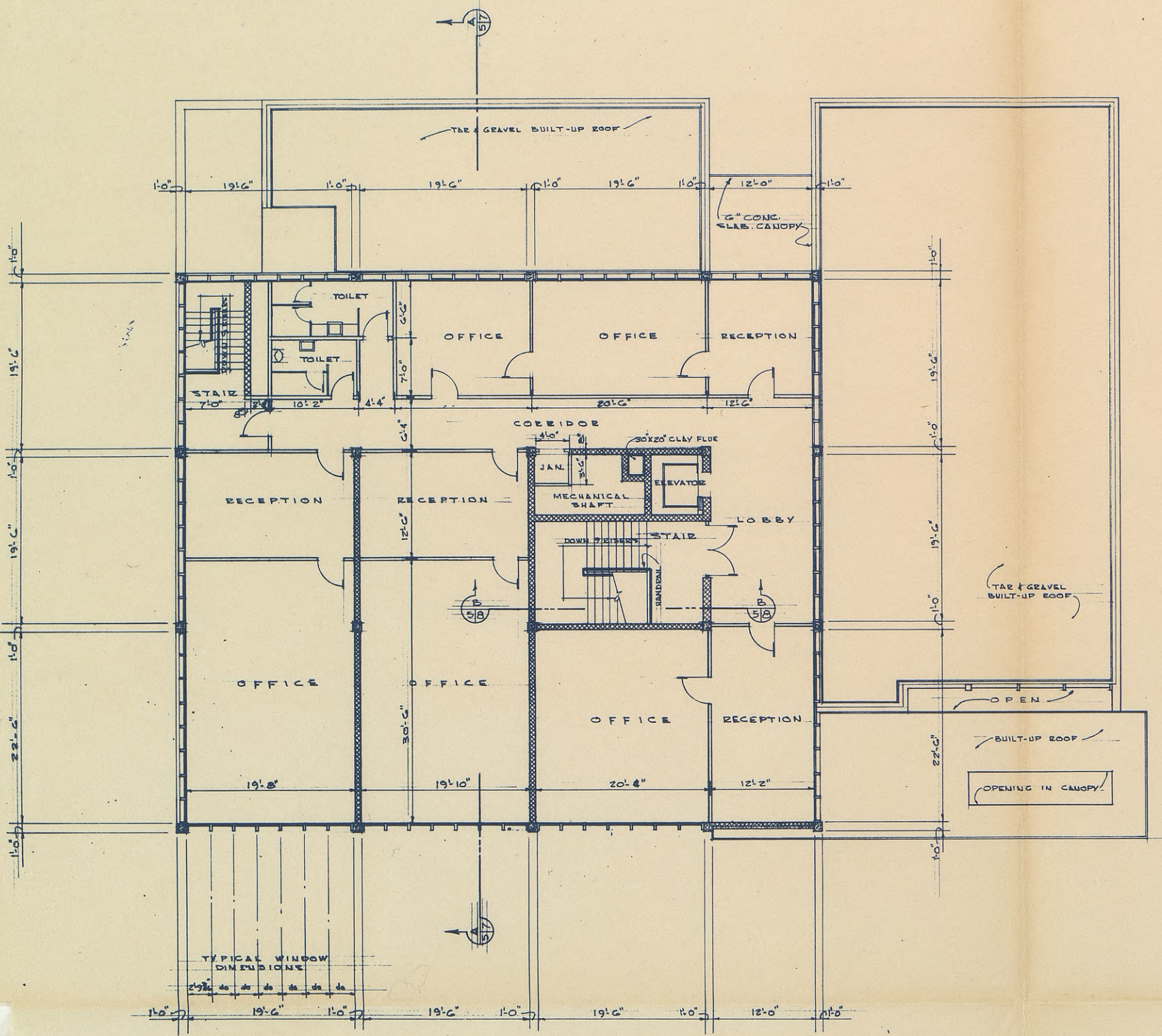

SECOND FLOOR PLAN
SCALE 1/8" = 1'-0"

A MEDICAL CLINIC AND PROFESSIONAL BUILDING		
FOR		
1200 TREMONT STREET		
MANHATTAN, KANSAS		
CHARLES R. BISSEY		
STUDENT ARCHITECT		
KANSAS STATE UNIVERSITY		
MANHATTAN, KANSAS		
COMM.	DEWN. CEB	SHEET NO.
DATE. JUNE 61	CKD.	5
REVS.	APP.	

EXPLANATION OF PLATE XLVII

A half size blueprint of sheet 6 of a partial set of architectural working drawings showing the exterior elevations.

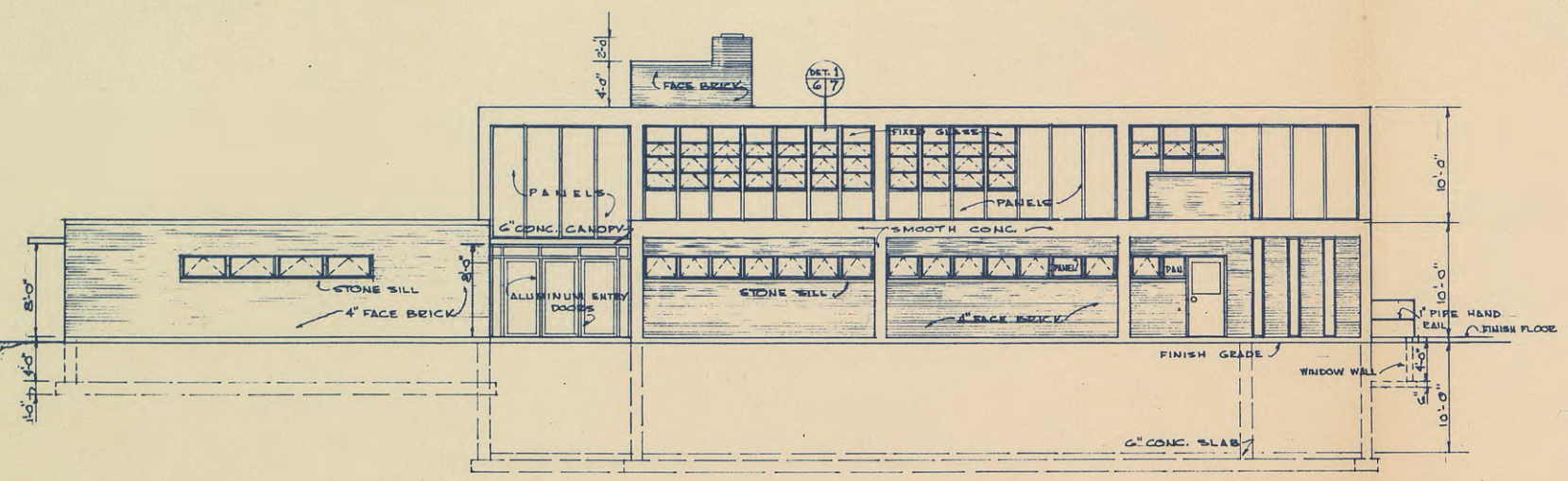

NORTH ELEVATION SCALE 1/8" = 1'-0"

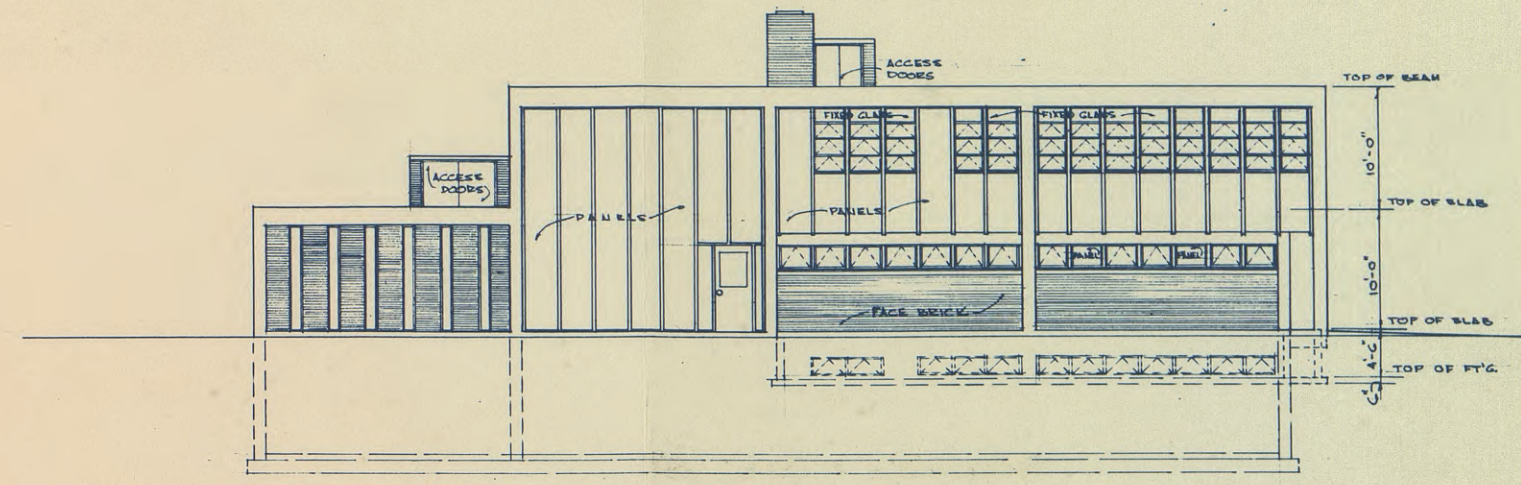

WEST ELEVATION SCALE 1/8" = 1'-0"

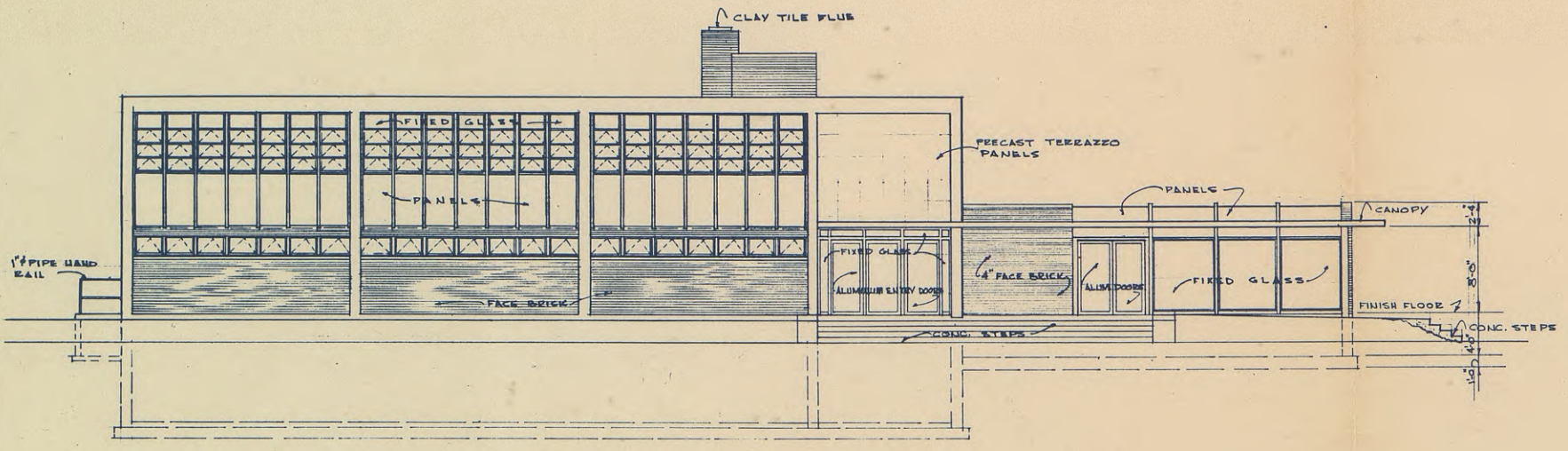

SOUTH ELEVATION SCALE 1/8" = 1'-0"

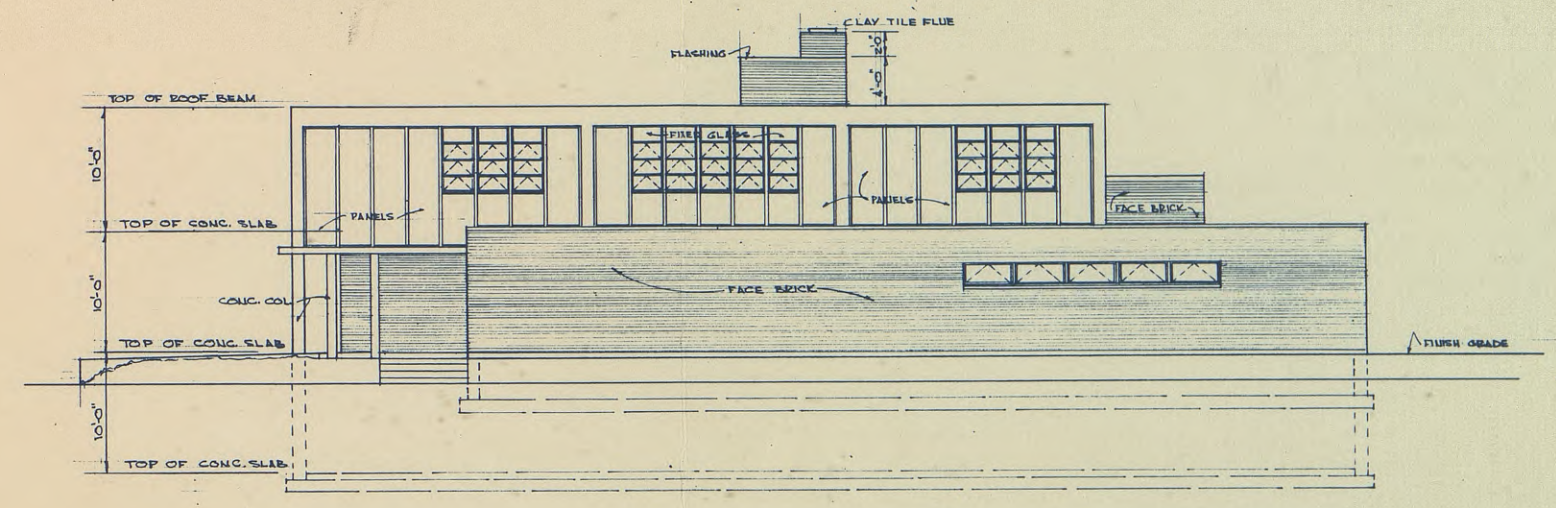

EAST ELEVATION SCALE 1/8" = 1'-0"

A MEDICAL CLINIC AND PROFESSIONAL BUILDING		
FOR		
1200 FREMONT STREET		
MANHATTAN, KANSAS		
CHARLES R. BISSEY		
STUDENT ARCHITECT		
KANSAS STATE UNIVERSITY		
MANHATTAN, KANSAS		
COMM. _____	DRWN. C.R.B.	SHEET NO.
DATE. JUNE 61	CKD. _____	6
REVS. _____	APP. _____	OF

EXPLANATION OF PLATE XLVIII

A half size blueprint of sheet 7 of a partial set of architectural working drawings showing a vertical full section and window details.

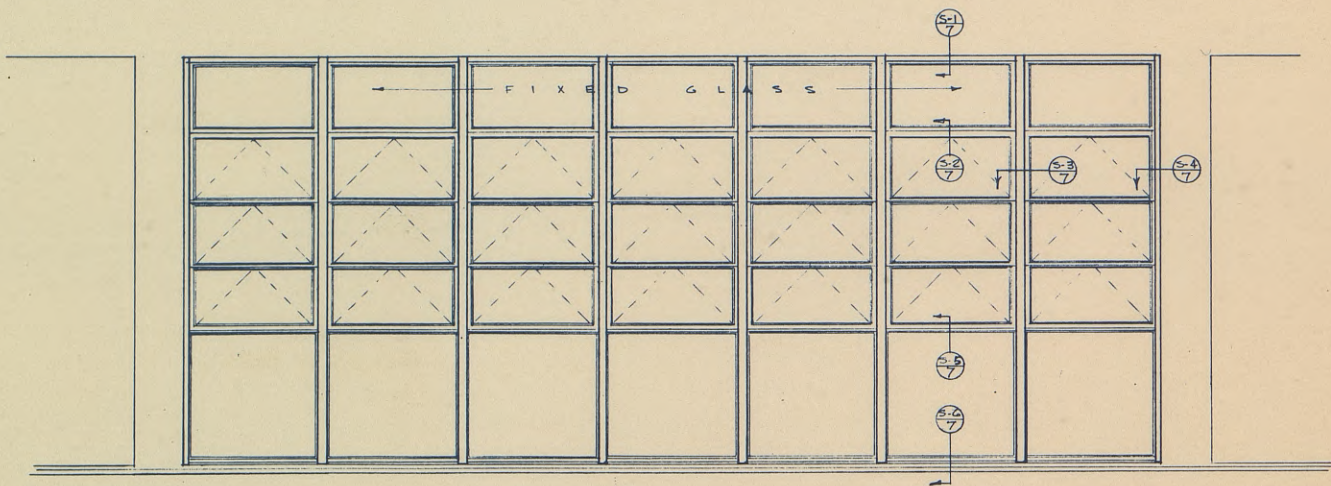
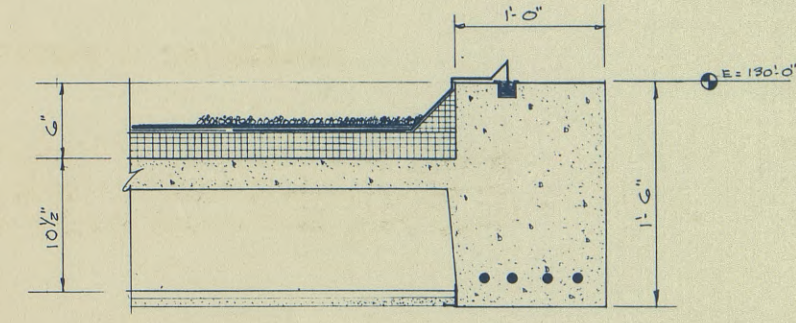
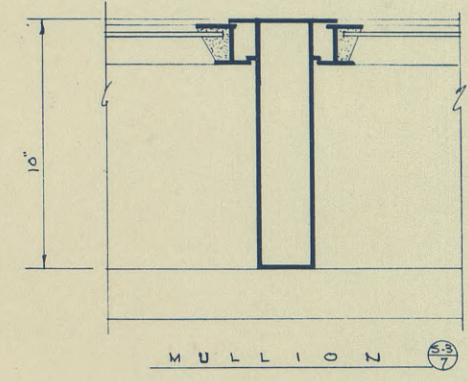
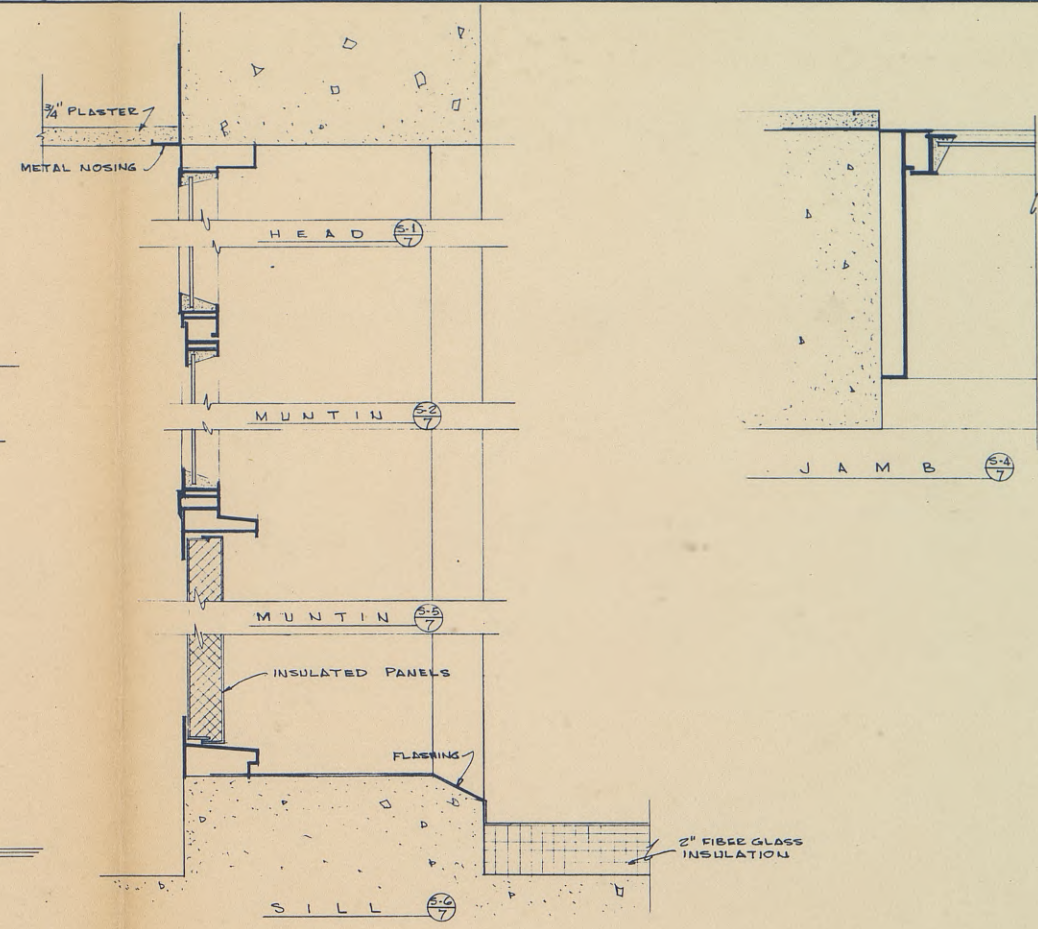
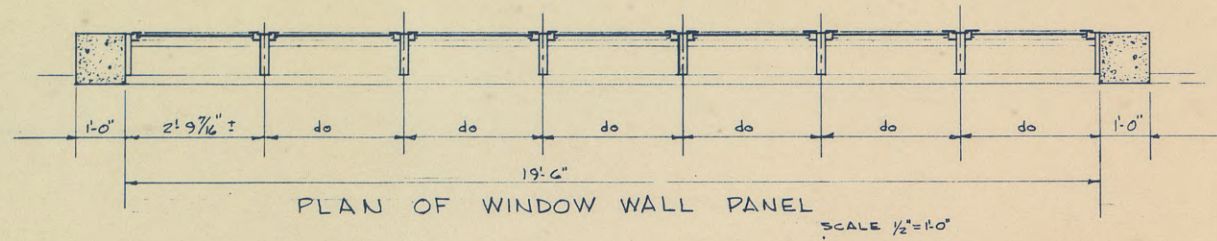

WINDOW SECTIONS
SCALE 3" = 1'-0"

FACIA DETAIL
SCALE 1/2" = 1'-0"

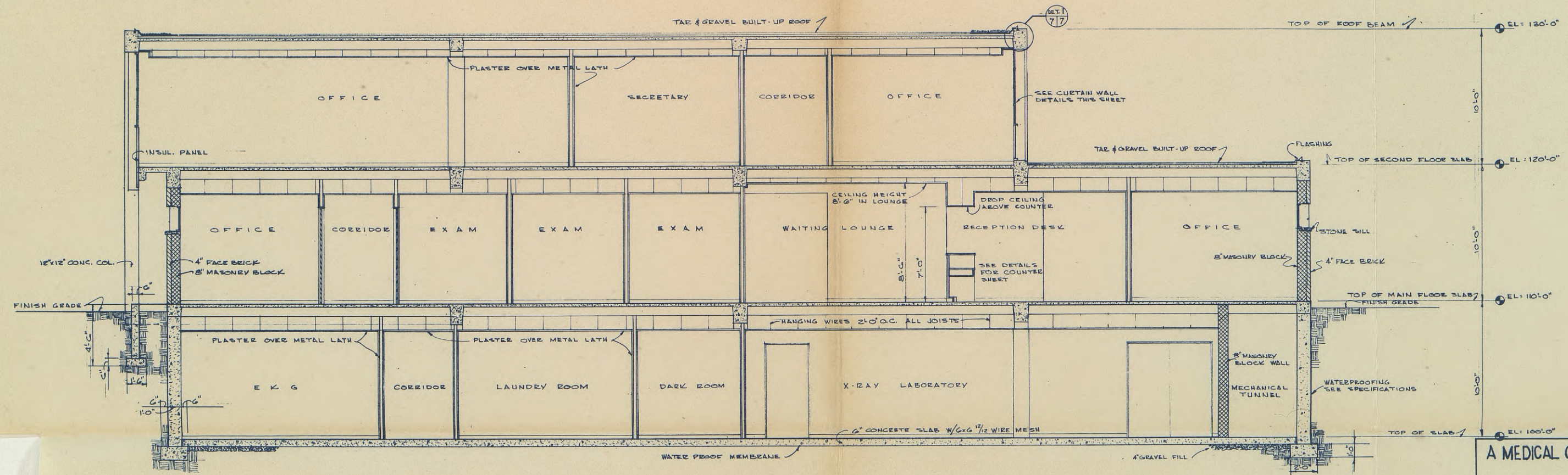

SECTION
SCALE 1/4" = 1'-0"

A MEDICAL CLINIC AND PROFESSIONAL BUILDING
 FOR
 1200 FREMONT STREET
 MANHATTAN, KANSAS

CHARLES E. BISSEY
 STUDENT ARCHITECT
 KANSAS STATE UNIVERSITY
 MANHATTAN, KANSAS

COMM. _____	DRWN. CEB	SHEET NO.
DATE. JUNE 61	CKD. _____	7
REVS. _____	APP. _____	OF

EXPLANATION OF PLATE KLIK

A half size blueprint of sheet 8 of a partial set of architectural working drawings showing a full vertical section through the main stair.

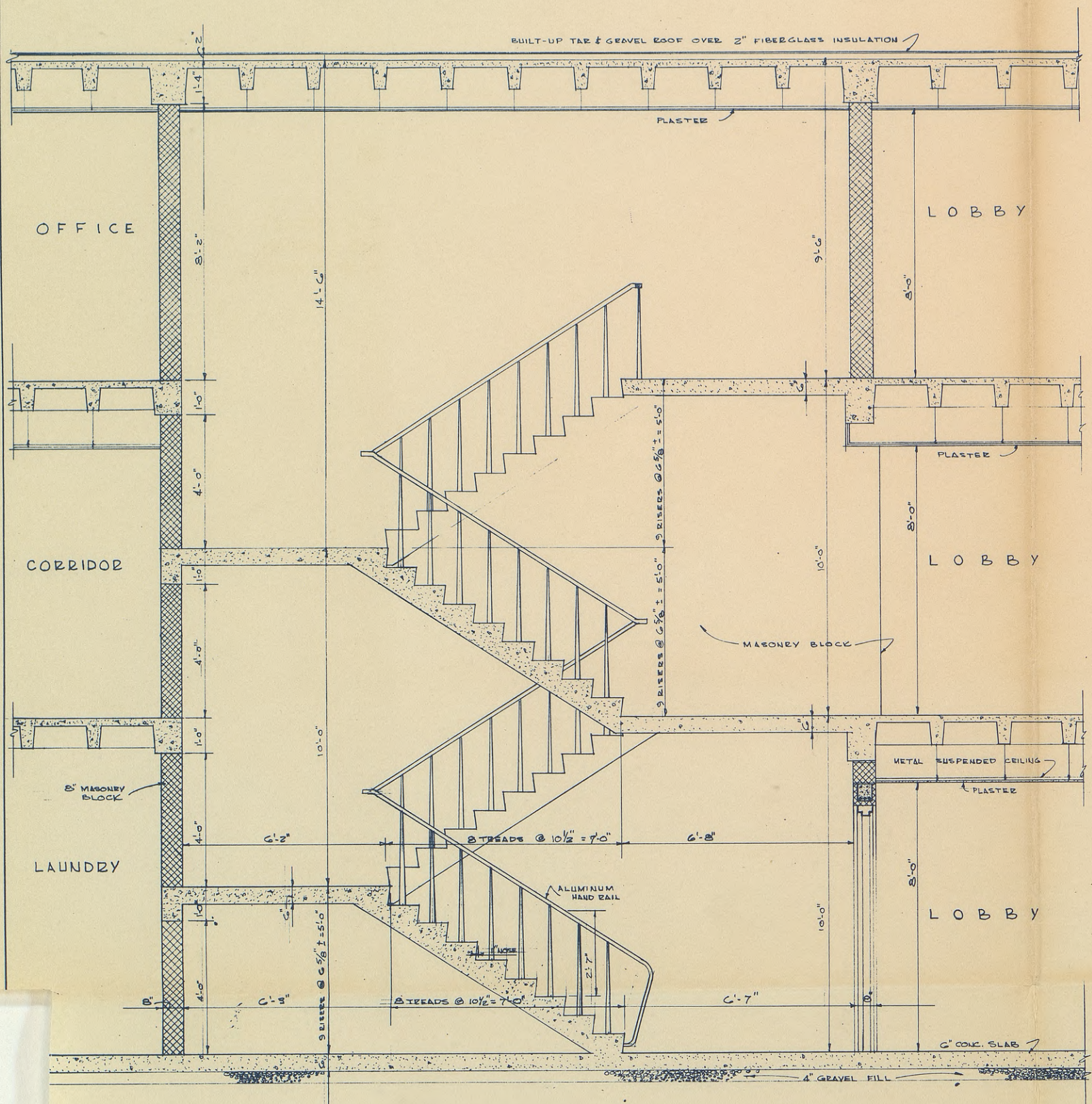

SECTION THRU STAIRS B
 SCALE 1/2" = 1'-0"

A MEDICAL CLINIC AND PROFESSIONAL BUILDING		
FOR		
1200 FREMONT STREET		
MANHATTAN, KANSAS		
CHARLES D. BISSEY		
STUDENT ARCHITECT		
KANSAS STATE UNIVERSITY		
MANHATTAN, KANSAS		
COMM. _____	DRWN. CDB	SHEET NO.
DATE. JUNE 61	CKD. _____	8
REVS. _____	APP. _____	OF.

ARCHITECTURAL DRAFTING STANDARDS

Section 1**Sectioning Techniques****Indexing Scheme**

by
Charles R. Bissey
Student of Architecture
Kansas State University
1961

ARCHITECTURAL DRAFTING STANDARDS
FOR
WORKING DRAWINGS

1-0 Scope

The function of a set of working drawings prepared by the architect is to act as a legal document when supplemented by written specifications between the client, or owner, and the contractor. The working drawings should completely explain how the structure is to be erected. In this sense, the drawings are detailed as all views are complete and accurate in their explanation showing the materials with the correct symbols, and all dimensions. A complete set should contain sufficient information concerning the site, erection details for the structure, and interior furnishings.

1-1 Sectional Views

1-1.1 General Principles.

1-1.1.1 Sectional views are required where the interior construction of a structure cannot be clearly shown by hidden lines in the exterior views. A sectional view is drawn as though an imaginary cutting plane were passed through the structure so as to be in a position perpendicular to the direction of sight and that portion between the observer and cutting plane removed. The areas cut by the plane are indicated with the proper material symbol or darkened, in the case of a design section.

1-1.2 Design Sections on Architectural Drawings.

1-1.2.1 Since the actual materials and their sizes may not be known when the structure is in the design stage, the sectional views may be darkened in where the cutting plane passes through the sectional view. This method

is extensively used when presentation drawings for a newly designed structure are publicly displayed. This may include plan views, and any full vertical sectional view.

1-1.3 Material Symbols for Detailed Sections.

1-1.3.1 When preparing working drawings, it is important to describe the type of material, with a standardized material symbol, where the cutting plane passes through all sectional views. All materials in section should be actual size to scale. Architectural reference books may be used to acquire material symbol information.

1-1.4 The Cutting Plane.

1-1.4.1 The location of the cutting plane where the section has been taken is shown on the drawing by a cutting-plane line which represents the edge view of the cutting plane. Large arrows and a three-quarter circle at the ends of the cutting-plane line are used to indicate the direction of sight for viewing the section and an indexing scheme placed inside the circle for referencing purposes. See plate for explanation of this symbol.

1-1.4.2 A cutting plane may be passed through a sectional view and it's position indicated with the cutting-plane line symbol in the sectional view.

1-1.4.3 Since plan views of multi-story buildings are usually drawn with each plan view on a separate sheet, the cutting plane imagined to be passed through the entire structure is indicated on each plan view by the cutting-plane line and indexing symbol. On the sheet showing the sectional view, the indexing symbol could be enlarged to accommodate all sheet numbers where the cutting plane is indicated on each plan view.

1-1.4.4 If it is apparent from the elevation views of a structure where the cutting plane was located when the floor plan was drawn, no indication

EXPLANATION OF PLATE L

**Cutting-plane line indexing symbol showing
required reference information.**

PLATE L

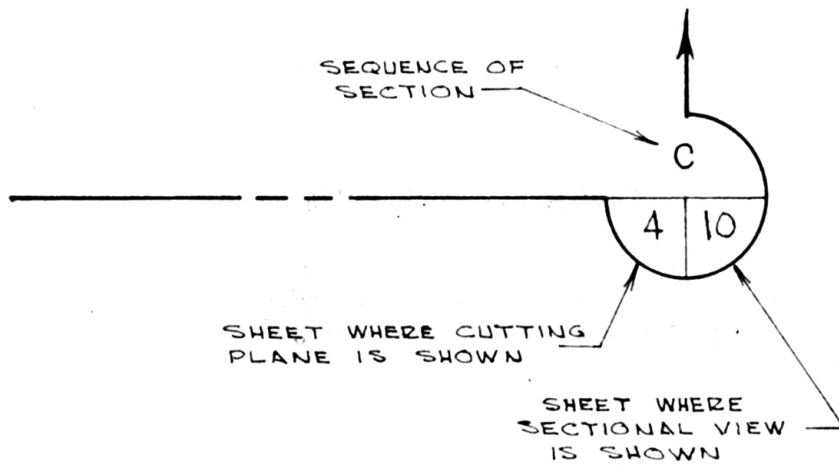

is needed on the elevation views. When preparing drawings of objects having one major center line where normal view projections are retained, the cutting plane may be omitted if it is understood that the section has been located along that center line.

1-1.4.5 When the cutting-plane line interferes with other information shown and confuses the interpretation of a drawing, only those portions of the cutting-plane line necessary to indicate it's position need be shown. Arrows, indexing symbols, and offsets are usually indicated.

1-1.4.6 The cutting plane may be bent or offset if the sectional view will show more information or if the interior features are not in a straight line. In the case of an offset cutting plane being passed through a structure, the offsets should be in corridors or open spaces so as to eliminate confusion of materials and areas in the sectional view.

1-1.5 Full Sections.

1-1.5.1 If the cutting plane is extended completely through an object or structure, a full section is obtained. The portion of the object between the observer and the cutting plane is considered removed and the exposed surface becomes the sectional view.

1-1.5.2 A cutting plane may be passed through a structure and take any position as so to be perpendicular to the direction of sight chosen for the sectional view. When the cutting plane is passed through an elevation view of a structure, in a horizontal position, the projected sectional view will be a plan view.

1-1.5.3 In the case of plan views or any view already in section, the cutting plane is passed through this view, and a complete full sectional view may be projected even though only one-fourth of the object or structure

remains. It is imagined that the portion of the structure, in the case of a plan view, above that shown on the drawing exists when projecting the full sectional view.

1-1.6 Half Sections.

1-1.6.1 When the cutting plane extends only halfway through the entire structure, or object, and one-fourth of the structure is removed, the resulting view projection is termed a half section. This section is generally applied to objects having essentially a symmetrical design and where it is desired to show interior features as well as exterior features in one view projection.

1-1.6.2 In the half sectional view projection, a center line or a visible line may be used to divide the unsectioned portion from the sectioned portion.

1-1.7 Location of Sectional Views.

1-1.7.1 A sectional view should be located on the same sheet with the regular views and occupy its normal projected location to conform with the standard arrangement of orthographic views, except for a removed section. In the case of sectional views too large to be drawn on the same sheet, they may be drawn on another sheet retaining view projection principles. The sectional view should be titled using the cutting-plane line symbol to identify it with the cutting-plane line which has the corresponding symbol at its ends.

1-1.8.1 Broken-out Sections.

1-1.8.1 In some instances, only a portion of the object shown in section is needed to fully explain the interior construction. A small piece of the object is removed and the remaining portion is treated as a section.

The boundary of the break area is shown by a break line.

1-1.9 Revolved Sections.

1-1.9.1 A revolved section is used for elongated objects such as beams, shafts, spokes, or arms and is obtained by passing a cutting plane perpendicular to the axis of the object forming a slice infinitesimal in thickness that is related in place 90° about it's own axis into the plane of the object's view. The visible lines on each side of the revolved section may be removed and break lines inserted.

1-1.10 Removed Sections.

1-1.10.1 A section may be removed from it's normal projected position in the normal arrangement of orthographic views, thus it becomes a removed section.

1-1.10.2 Removed sections may be drawn to a larger scale.

1-1.10.3 On multiple-sheet drawings where it is not possible to place a removed section on the same sheet with it's related views, an indexed symbol used at the end of the cutting-plane line should be placed under the removed sectional view similar to that used for referencing other sections. See plate for explanation of a removed sectional view.

1-1.11 Detail Sections.

1-1.11.1 A detail section is an area already in section that is drawn to a larger scale. In this case, a circle may be constructed around the area, already in section, designating that portion shown which is redrawn to a larger scale. This detail section is not an actual view projection, but consists of transferring an area in section to be redrawn in another location. The indexing symbol used for a detail section does not have an arrow, as no orthographic projection is involved. See plate for detail

EXPLANATION OF PLATE LI

Cutting-plane line indexing symbol showing the required referencing information for a removed section.

PLATE LI

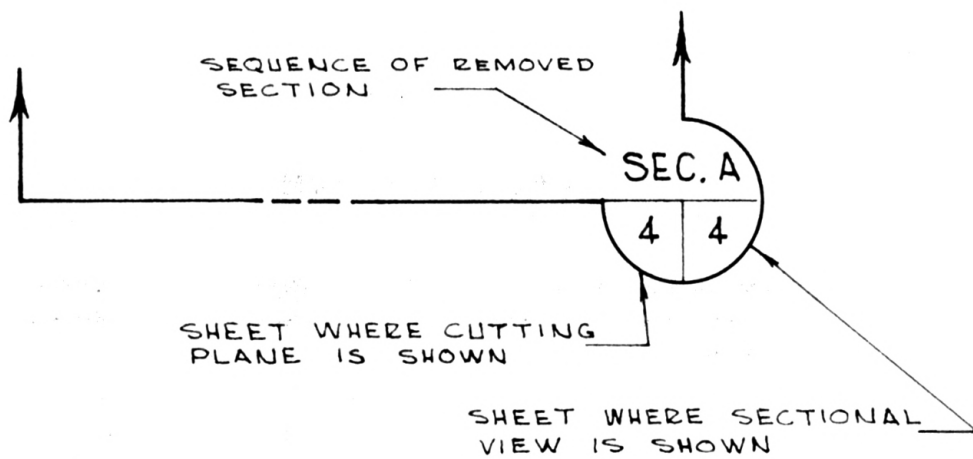

EXPLANATION OF PLATE LII

Indexing symbol used for removed details.

PLATE LII

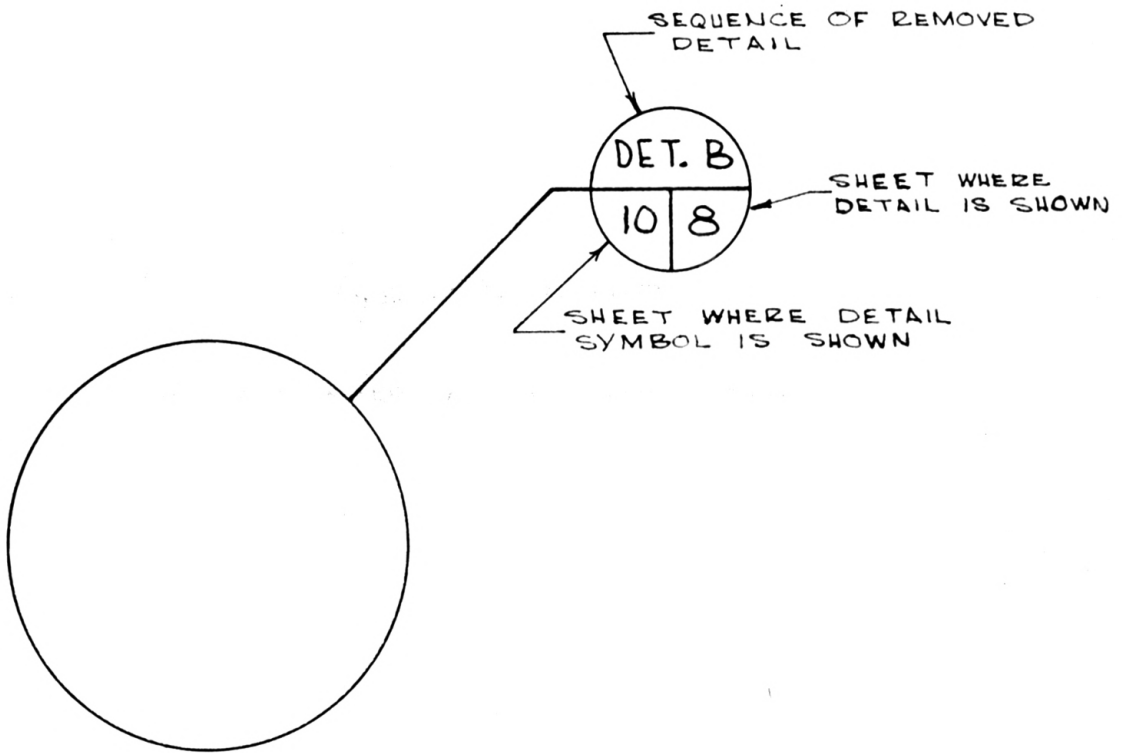

section indexing symbol.

1-1.11.2 Detail sections may consist of a complex element, that is usually shown in a full sectional view such as a built-in, which requires several larger drawings to give full explanation. This type of detail may have as it's reference a note located on the full sectional views, indicating the sheet where the details may be found.

1-1.12 Thin Sections.

1-1.12.1 Materials shown in a sectional view too thin to indicate the correct material symbol, such as asphalt tile, membranes, or sheet metal, may be shown as a darkened area, or with a solid line.

1-1.13 Sections Through Shafts, Fasteners, Etc.

1-1.13.1 When the cutting plane is passed through nails, screws, bolts, pins, shafts, rivets, nuts, washers, split rings, or elements which in themselves do not require sectioning. The elements are shown as though the cutting plane did not pass through them.

ACKNOWLEDGMENTS

The author wishes to acknowledge his indebtedness to the Kansas State University professors for stimulating an enthusiastic interest in the area of graphics. Professor Emil C. Fischer's assistance and counsel during the preparation of this thesis has been greatly appreciated. He also wishes to thank his wife, Rose, for her valuable assistance in typing of the material.

LITERATURE CITED

- American Institute of Steel Construction. Structural Shop Drafting, Vol. 1. New York 17, New York: American Institute of Steel Construction, 1950.
- American Society of Mechanical Engineering. American Drafting Standards Manual. New York: American Society of Mechanical Engineering, 1957.
- American Society of Mechanical Engineering. A Guide For Preparing Technical Illustrations For Publication and Projection. New York: American Society of Mechanical Engineers, 1953.
- Arnold, Joseph Norman. Introductory Graphics. New York: McGraw-Hill Book Company, Inc., 1958.
- Choate, Chris. Architectural Presentation. New York: Reinhold Publishing Corporation, 1961.
- Encyclopaedia Britannica. Drawing, Engineering. Chicago: Encyclopaedia Britannica, Inc., 1959.
- French, Thomas E. A Manual of Engineering Drawing. New York: McGraw-Hill Book Company, Inc., 1911.
- Getty, Vincent C. How to Read a Drawing. Philadelphia: J. B. Lippincott Company, 1912.
- Giesecke, Frederick E., Mitchell, Alva, and Spencer, Henry Cecil. Technical Drawing. New York: The Macmillian Company, 1958.
- Graf, Don. Don Graf's Data Sheets, Second Edition. New York: Reinhold Publishing Corporation, 1949.
- Hobart, Dean E. Engineering Drawing. New York: D. C. Heath and Company, 1941.
- Hoelscher, R. P., and Jordan, H. H. Engineering Drawing. New York: John Wiley and Sons, Inc., 1923.
- Hood, George J. Geometry of Engineering Drawing. New York: McGraw-Hill Book Company, Inc., 1946.
- Radford, William A. Architectural Drafting. Chicago: Radford Architectural Company, 1912.

- Reekie, R. Fraser. Draughtsmanship. London: Edward Arnod and Company, 1946.
- Svensen, Carl Lars. Drafting for Engineers. New York: D. Van Nostrand Company, Inc., 1927.
- Turner, William Wirt, Buck, Carson P., and Ackert, Hugh P. Basic Engineering Drawing. New York: Ronald Press Company, 1950.
- Turner, William Wirt. Projection Drawing for Architects. New York: The Ronald Press Company, 1950.

**ANALYSIS OF GRAPHICAL REPRESENTATION
USED BY ARCHITECTS**

by

CHARLES RALPH BISSEY

B. S., Colorado State University, 1957

AN ABSTRACT OF A THESIS

submitted in partial fulfillment of the

requirements for the degree

MASTER OF ARCHITECTURE

Department of Architecture and Allied Arts

**KANSAS STATE UNIVERSITY
Manhattan, Kansas**

1961

Graphical Representation is a linear language which is understood by visualization and interpretation, and not a language that is written to read aloud. It may be in the form of a freehand sketch or a mechanically constructed drawing.

An architect's set of working drawings consists of a mechanically constructed system of related views that explain how the structure is to be built. To properly understand this system of related views, a person must be able to project an object onto a projection plane. This must be accomplished both mentally and by means of mechanically constructing the projection on paper.

To establish a method of projecting the views of an object having a relationship that would be understood by everyone, a quadrant system is used consisting of three planes. These planes are positioned to form four quadrants and at the same time have a right angle relationship at their intersections. Each plane is termed in accordance with its position and known as the horizontal, vertical, and profile planes. Four dihedral angles are formed by these planes known respectively as the first, second, third and fourth angles.

To construct the orthographic view projections of an object, the object is placed in the third dihedral angle with its faces parallel to the projection planes. The true size and shapes of the faces and sides may be projected onto the projection planes, obtaining the top view or horizontal projection, the front view or vertical projection, and the side view or profile projection. The projection planes are revolved open, in a specified manner, into one flat plane forming the views of the object.

This method of obtaining views of objects does not describe the interior features except by using hidden lines, which are annoying to construct and difficult to decipher if the object is complex. To properly describe the interior of an object, one or more views showing the object in section are drawn.

Sectional views are usually drawn in their normal projected view location. However, some sectioning techniques describe methods for locating the sectional view elsewhere on the sheet, or on another sheet.

The requirements for constructing sectional views set forth in the American Drafting Standards Manual published by the American Society of Mechanical Engineers is discussed and the inadequacies of these standards explained in regard to the architect's working drawings.

An architectural drafting standard for sectional views and an indexing method was devised to fulfill the architectural requirements equivalent to the standards used by the mechanical engineers. This standard consists of written explanations and a partial set of working drawings to illustrate these fundamentals.