

PMU BASED PSS AND SVC FUZZY CONTROLLER DESIGN FOR ANGULAR
STABILITY ANALYSIS

By

AHMED SHEIKH

B.Sc., University of Engineering & Technology, Taxila, 2012

A THESIS

Submitted in partial fulfillment of the requirements for the degree

MASTER OF SCIENCE

Department of Electrical and Computer Engineering
College of Engineering

KANSAS STATE UNIVERSITY
Manhattan, Kansas

2015

Approved by:

Major Professor
Dr. Shelli Starrett

Abstract

Variability in power systems is increasing due to pushing the system to limits for economic purposes, the inclusion of new energy sources like wind turbines and photovoltaic, and the introduction of new types of loads such as electric vehicle chargers. In this new environment, system monitoring and control must keep pace to insure system stability and reliability on a wide area scale. Phasor measurement unit technology implementation is growing and can be used to provide input signals to new types of control. Fuzzy logic based power system stabilizer (PSS) controllers have also been shown effective in various studies. This thesis considers several choices of input signals, composed assuming phasor measurement availability, for fuzzy logic-based controllers. The purpose of the controller is to damp power systems' low frequency oscillations. Nonlinear transient simulation results for a 4-machine two-area system and 50 machine system are used to compare the effects of input choice and controller type on damping of system oscillations.

Reactive power in the system affects voltage, which in turn affects system damping and dynamic stability. System stability and damping can be enhanced by deploying SVC controllers properly. Different types of power system variables play critical role to damp power swings using SVC controller. A fuzzy logic based static var compensator (SVC) was used near a generator to damp these electromechanical oscillations using different PMU-acquired inputs. The goal was again improve dynamic stability and damping performance of the system at local and global level. Nonlinear simulations were run to compare the damping performance of different inputs on the 50 machine system.

Table of Contents

List of Figures.....	v
List of Tables	viii
1. Introduction.....	1
1.1 Motivation.....	1
1.2 Explanation of Thesis	4
1.3 Summary of Cases	5
2. Literature Review	6
3. Systems and Models.....	13
3.1 4- Machine System	13
3.2 50- Machine System	13
4. Fuzzy Logic based PSS.....	15
4.1 State Variable Selection.....	16
4.2 Membership Function Definition.....	17
4.3 Rule Building.....	19
4.4 Fuzzy Inference and Defuzzification Method Selection.....	20
4.5 Simulation Results	21
4.5.1 4-Machine System	21
Comparing CPSS to FLPSS with Speed Inputs.....	22
Comparing FLPSS with Speed and COI Speed Inputs.....	23
Comparing FLPSS with Bus Frequencies as Inputs	23
Comparing Estimates of COI Speed as FLPSS Input.....	24
Effects of Significant Changes in Generator Inertia	25
Observing Effects of Changes in Generator Power	27
4.5.2 Summary of 4 Generator PSS Cases:.....	28
4.5.3 50- Machine System	29
Short Fault.....	30
Longer Fault.....	34
Fault at Different Location:	37

4.5.4 Summary of 50 Generator Cases:	41
5.Fuzzy Logic Based Static Var Compensator (SVC)	44
5.1 Input Gain adjustment in the 4 Machine System:	46
5.2 Input Gain adjustment in the 50 Machine System:	50
SVC Fault Cases:	53
5.2.1 Testing SVC at Bus 6 under Short Fault:.....	55
5.2.2 Testing SVC at Bus 6 under Longer Fault:.....	59
5.2.3 Testing SVC at Bus 6 under a Fault at a Different Location:	63
5.2.4 Testing SVC at Bus 66 under Longer Fault:.....	67
5.2.5 Testing SVC at Bus 66 under Fault at Different Location:	69
5.2.6 Summary of 50 Gen SVC Cases:.....	71
6.Conclusion	74
6.1 Power System Stabilizer:	74
6.2 Static Var Compensator:.....	75
7. Future Work.....	77
8.Bibliography	78

List of Figures

Figure 1 Kundur 4 Machine, 2 Area System [24].....	13
Figure 2 50 Machine System [24].....	14
Figure 3 General Fuzzy Logic Structure [8].....	15
Figure 4 Basic Block Diagram of a Fuzzy Logic PSS.....	17
Figure 5 Input Membership Functions.....	18
Figure 6 Rules relating Inputs to the Outputs.....	20
Figure 7 Output Membership Functions.....	21
Figure 8 Fault comparison of CPSS to Fuzzy PSS with speed and COI speed inputs.....	23
Figure 9 Fault responses for Fuzzy PSSs with bus frequency input.....	24
Figure 10 Fault responses for FLPSSs with COI speed and estimated COI speed inputs.....	25
Figure 11 Fault comparison of CPSS to Fuzzy PSS with speed, bus frequency and COI speed inputs.....	26
Figure 12 Fault comparison of CPSS to Fuzzy PSS with speed, bus frequency and COI speed inputs.....	27
Figure 13 Fault comparison of CPSS to Fuzzy PSS with speed, bus frequency and COI speed inputs.....	28
Figure 14 Short Fault Machine Angles with Fuzzy Bus Frequency PSS at Gen 2.....	30
Figure 15 Short Fault Comparison of Fuzzy Speed and Bus Frequency PSS at Gen 2.....	31
Figure 16 Short Fault Comparison of CPSS to Fuzzy COI and Estimated COI Speed at Gen 2 .	32
Figure 17 Short Fault Comparison of CPSS to Fuzzy Bus Angle and COI Estimated Angle PSS at Gen 2.....	33
Figure 18 Longer Fault Machines Angles with Fuzzy Bus Frequency PSS at Gen 2.....	34
Figure 19 Longer Fault Comparison of CPSS to Fuzzy Speed and Bus Frequency PSS at Gen 2	35
Figure 20 Longer Fault Comparison of CPSS to Fuzzy COI and Estimated COI Speed at Gen 2	36
Figure 21 Longer Fault Comparison of CPSS to Fuzzy Bus Angle and COI Estimated Angle PSS at Gen 2.....	37
Figure 22 Different Location Fault Machines Angles with Fuzzy Bus Frequency PSS at Gen 2	38

Figure 23 Different Location Fault Comparison of CPSS to Fuzzy Speed and Bus Frequency PSS at Gen 2	39
Figure 24 Different Location Fault Comparison of CPSS to Fuzzy COI and Estimated COI Speed at Gen 2	40
Figure 25 Different Location Fault Comparison of CPSS to Fuzzy Bus Angle and COI Estimated Angle PSS at Gen 2.....	41
Figure 26 SVC Model Block Diagram	44
Figure 27 TCR-FC SVC connected in Power System [48]	45
Figure 28 Voltage Fluctuation at Different Gains for 4 Gen System (Expanded View).....	47
Figure 29 Bus Voltage at Different Gains for 4 Gen System	48
Figure 30 Machine Angle at Different Gains for 4 Gen System	49
Figure 31 Machine Angle at Different Gains for 4 Gen System (Expanded View).....	49
Figure 32 SVC Susceptance at Different Gains for 50 Gen System.....	50
Figure 33 Bus Voltage at Different Gains for 50 Gen System	51
Figure 34 Voltage Fluctuation at Different Gains for 50 Gen System (Expanded View).....	52
Figure 35 Machine Angle at Different Gains for 50 Gen System	52
Figure 36 Short Fault Machine Angles with Fuzzy Bus Frequency SVC-PSS at Bus 6.....	55
Figure 37 Short Fault Comparison of Conventional SVC to Fuzzy Speed and Bus Frequency SVC-PSS at Bus 6.....	56
Figure 38 Short Fault Comparison of Conventional SVC to Fuzzy COI and Estimated COI Speed SVC-PSS at Bus 6.....	57
Figure 39 Short Fault Comparison of Conventional SVC to Fuzzy Bus Angle and COI Estimated Angle SVC-PSS at Bus 6.....	58
Figure 40 Longer Fault Machine Angles with Fuzzy Bus Frequency SVC-PSS at Bus 6.....	59
Figure 41 Longer Fault Comparison of Conventional SVC to Fuzzy Speed and Bus Frequency SVC-PSS at Bus 6.....	60
Figure 42 Longer Fault Comparison of Conventional SVC to Fuzzy COI and Estimated COI Speed SVC-PSS at Bus 6.....	61
Figure 43 Longer Fault Comparison of Conventional SVC to Fuzzy Bus Angle and COI Estimated Angle SVC-PSS at Bus 6.....	62

Figure 44 Different Location Fault Machine Angles with Fuzzy Bus Frequency SVC-PSS at Bus 6.....	63
Figure 45 Different Location Fault Comparison of Conventional SVC to Fuzzy Speed and Bus Frequency SVC-PSS at Bus 6.....	64
Figure 46 Different Location Fault Comparison of Conventional SVC to Fuzzy COI and Estimated COI Speed SVC-PSS at Bus 6.....	65
Figure 47 Different Location Fault Comparison of Conventional SVC to Fuzzy Bus Angle and COI Estimated Angle SVC-PSS at Bus 6.....	66
Figure 48 Longer Fault Machine Angles with Fuzzy Bus Frequency SVC-PSS at Bus 66.....	67
Figure 49 Longer Fault Comparison of Conventional SVC to Fuzzy Bus Frequency and Estimated COI Speed SVC-PSS at Bus 66.....	68
Figure 50 Different Fault Location Machine Angles with Fuzzy Bus Frequency SVC-PSS at Bus 66.....	69
Figure 51 Different Location Fault Comparison of Conventional SVC to Fuzzy Bus Frequency and Estimated COI Speed SVC-PSS at Bus 66.....	70

List of Tables

Table 1 PSS and SVC Cases	5
Table 2 Range of Fuzzy Variables.....	19
Table 3 FLPSS Decision Table.....	19
Table 4 4 Machine PSS Cases	22
Table 5 50 Machine Simulation Cases of PSS.....	29
Table 6 Summary of 50 Generator Cases of PSS	43
Table 7 SVC Gain Cases-4 Gen System.....	46
Table 8 50 Machine SVC Cases	51
Table 9 50 Machine SVC Cases	54
Table 10 50 Machine SVC Cases	54
Table 11 50 Generator SVC Cases Summary.....	72
Table 12 50 Generator SVC Cases Summary.....	73

1. Introduction

1.1 Motivation

Modern day electrical power systems are interconnected and tend to have low frequency electromechanical oscillation modes that have been a key concern in planning and operation of power systems [1]. Power system oscillations can be initiated by small load changes and become worse as the system is more heavily loaded and stressed. These oscillations are generally associated with generator dynamics, turbine governors and excitation systems and can be represented by different equations at particular operating condition. These low frequency modes are unfavorable to maximum power transfer and system security. In order to operate the power system securely, damping of these inter-area oscillations is of dynamic concern. Power system stabilizers (PSS) and Flexible AC Transmission devices can be used to damp these oscillations and to improve system dynamic performance [4].

Power system stabilizers, which are set up in generator excitation systems, are used to damp electromechanical oscillations and augment system's overall steady state stability. FACTS devices are generally installed on transmission lines far-off from generating stations. These power electronics-based devices can be very expensive and multifaceted in design. A supplementary controller can be planned for each FACTS device in order to improve damping of certain oscillatory modes.

The SVC, a FACTS device, is normally used to control the voltage at buses as to keep it within certain prescribed limits. Additionally it can be used to damp electromechanical oscillations. Using an SVC, a damping torque is injected for oscillation reduction and thus increase

power system's damping. Voltage based SVC does not provide significant damping in system. A considerable damping is obtained when supplementary signal is used to control the SVC. This supplementary signal can be bus frequency, voltage angle, line current, or active/reactive power to damp low frequency oscillations.

Weak transmission lines, operation of generators at a wider power angle because of heavy loads, and particularly load characteristics contribute towards oscillatory instability. In power systems, synchronous machines are used for electrical power generation. The necessary condition for satisfactory operation is that all machines remain in synchronism or in-step with respect to each other. This stability characteristic is impacted by rotor-angle dynamics and the power angle relationship [3].

Sometimes instability occurs without losing synchronism. For instance, a synchronous generator feeding an induction motor can become unstable because of load voltage collapse. In this case, synchronism is not an issue but stability and control of voltage are more prominent concerns. In order to meet these conflicting exciter performance requirements at any system condition, a power system stabilizer is deployed in machines. The conventional Power System Stabilizer (CPSS), having fixed parameters, is generally deployed by most utilities. The gain settings of these conventional stabilizers are based on the linearized model of a power system to provide maximum performance at given operating point. Generally, power systems are highly non-linear in nature and the operating conditions change over a wide range. Therefore, performance of CPSS is degraded under changing operating conditions because of fixed stabilizer parameters [2]. Power systems' non-linearity and imprecision in modeling lead to consideration of Fuzzy Logic Controller (FLC) use.

Fuzzy Logic is simpler and faster and reduces design development cycle as it is based on simple yet meaningful rules defined by an operator. It reduces design complexity, as we do not need any complex mathematical model, and has proved to be a better solution to non-linear power system control. Moreover, it's very simple to implement and can easily incorporate traditional controls such as state feedback systems and PID controllers because of its inherent approximation capabilities.

Fuzzy logic based PSS, because of lower computation and burden, can easily accommodate uncertainties in power systems thus FLPSS appears to be suitable one amongst all available techniques of deploying PSSs.

Recent advancement in synchrophasor technology has played a key role in supervisory control and data acquisition (SCADA) and energy management systems (EMS). The most common advantages of phasor measurement technology includes dynamic monitoring of the whole interconnected system, machine model validation, and post event analysis [9]. PMUs gather time-stamped data from different locations in the substation for detailed system analysis using global positioning system (GPS), and transmit it to the central locations. In our work, we used inputs such as bus frequency and estimated center of inertia (COI) which can be acquired through PMU based data.

A fuzzy logic controller (FLC) can use PMU based inputs to damp electromechanical oscillations and improve dynamic stability of the system locally and globally [6].

1.2 Explanation of Thesis

In Chapter 2, a general background of power system stabilizers (PSS), Fuzzy Logic, ANFIS, and phasor measurement units is described and participation of different researchers towards solving issues in maintaining stability in a power system is presented.

Chapter 3 describes the systems and models used throughout this research work. We used 4 and 50 machine systems with different PSS and SVC models to run simulation test cases.

Chapter 4 provides details on the designed fuzzy logic based PSS and its application to the 4 and 50 generator systems. In this section, we used different signals such as machine speed, bus frequency, COI machine speed, and COI machine speed estimations as inputs to a fuzzy logic controller to observe their effect on PSS output. Machine speed and machine angle responses versus time results are compared to determine the effectiveness of various input choices for a fuzzy logic based PSS.

Chapter 5 covers the static var compensator (SVC) model used in this research work, and its deployment in the 4 and 50 generator systems. Again, to observe the angular stability of generators, simulations using non-linear transient analysis program by Chew Tree software [23] were carried out using Matlab.

Chapter 6 provides a thesis summary, conclusion, and future work suggestions. Additionally, it covers references being used throughout this research work.

1.3 Summary of Cases

Table 1 presents the cases presented in this research work.

Table 1 PSS and SVC Cases

PSS Controller Studies	SVC Controller Studies
<p style="text-align: center;">4 Machine System</p> <p>Inputs at Machine 1:</p> <p>Bus Frequency</p> <p>Machine Speed</p> <p>COI Frequency Estimates (1ST & 2nd)</p> <p>2 Fault Cases:</p> <p>Machine Inertia Change (H)</p> <p>Machine Power Change (P)</p>	<p style="text-align: center;">4 Machine System</p> <p>Cases:</p> <p>Input Gain Adjustment</p> <p>Simulations :</p> <p>1 fault case</p>
<p style="text-align: center;">50 Machine System</p> <p>Inputs for PSS located at Machine 2:</p> <p>Bus Frequency</p> <p>Machine Speed</p> <p>COI Estimated</p> <p>Bus Voltage Angle</p> <p>Simulations :</p> <p>3 fault cases</p>	<p style="text-align: center;">50 Machine System</p> <p>Inputs for SVCs located at Buses 6 & 66:</p> <p>Bus Frequency</p> <p>Machine Speed</p> <p>COI Estimated</p> <p>Bus Voltage Angle</p> <p>Simulations :</p> <p>3 fault cases</p>

2. Literature Review

Various works have been done and published in the area of low frequency electromechanical oscillations. DeMello and Concordia [25] used a single machine system to analyze low frequency electromechanical oscillations and explained them in terms of synchronous and damping torque. They were the first to learn that lack of damping torque because of AVR action causes these oscillations. In order to mitigate the negative impact of excitation on damping torque, they devised a PSS based on speed signal and expressed its effectiveness by analog based simulations. Since then many authors have proposed PSS designs; few are listed here:

Kundur [26] used an analytical and systematic approach in order to determine PSS parameters for large practical power systems. The basic idea for designing power system stabilizer in [26] is the same as mentioned in [25] but frequency response characteristics were acquired using a 4 Machine 2 area system instead single machine system. This paper discussed overall system stability and analyzes performance of the proposed PSS under different operating conditions. Chow and Sanchez-Gasca [27] designed a power system stabilizer based on the frequency response characteristic of a controller using a pole-placement technique. In order to get the desired frequency responses, a controller fit for varying operating conditions was proposed using a simple technique.

Most PSS used in today's power utilities are devised from classical control theory based on a linearized model of the power system. They are adjusted for one set of operating conditions and may not be effective for different operating conditions and configurations. Conventional PSS can be represented by the following transfer function.

$$G(s) = K_s \left(\frac{1+T_1s}{1+T_2s} \right) \left(\frac{1+T_3s}{1+T_4s} \right) \quad (1)$$

New technologies such as FACTS devices and phasor measurement systems make it possible to monitor rotor angle stability of a power system. This is considered to be a challenging task as power system dynamics become heavily complex in nature [2]. A fuzzy neural network based on Phasor Measurement Units (PMUs) has been applied to predict power swing stability [3].

Wide Area Measurement (WAM) technologies using PMUs can provide control signals at exceptionally high speed. PMUs can be deployed at particular locations in the grid to measure voltages and currents at different locations of the grid to get a coherent picture of the whole network in real time [4]. PMUs gather data from various locations in the power system with Global Positioning Systems and transmit it to centralized locations for processing and analysis. This processed data can be used to determine generator variables such as angles, speeds, accelerations, and powers from time-stamped voltages and currents [5]. These voltage and current signals can be used as feedback inputs for a power system stabilizer (PSS) control design in order to enhance damping of oscillations [3]. The effects of time delay and data uncertainty with PMUs have been studied by Kamwa [6].

The center of inertia (COI) angle and speed of a system or region of a system has been used in the development of energy function methods for analysis for power system dynamics [7]. The COI can be used as a reference to allow the visualization of the machine dynamics with respect to a dynamic center of the system as opposed to a fixed synchronous reference or a single large machine. The COI speed for a system or sub-system is defined as:

$$system_COI_speed = \frac{\sum \omega_i * H_i}{H_{total}} \quad (2)$$

Where the ω_i are the machine speeds, H_i are generator inertias and H_{total} is the sum of the generator inertias for the system or sub-system. COI angle is defined similarly. The COI machine speed or

angle for a single machine is defined by taking the system COI speed or angle as a reference. Namely:

$$\omega_{COI_i} = \omega_i - \text{system_COI_speed} \quad (3)$$

Undeniably, electrical power systems are exceedingly non-linear and demonstrate conditions that are stochastic and dynamic in nature. Conventional PSS (CPSS) performance drops, as system configuration and operating conditions change from one to another, because of fixed stabilizer parameters [8]. With CPSS, gain and other time constants may not suit the varied operations. The definitive goal of deploying PSS in power systems is to ensure performance and dynamic stability under an extensive range of operating conditions and network configurations.

With the development of control technology, authors have been developing modern controllers based on more sophisticated algorithms. Among these refined methods, artificial intelligence-based approaches have been proposed to design effective PSS. These approaches include Fuzzy Logic [1], [9]-[11], neural networks [12] and genetic algorithms [8]. Fuzzy Logic based PSS shows great potential in damping inter-area generator oscillations [13].

Unlike classical control theory, which demands very profound and comprehensive understanding of the physical system, fuzzy logic does not require a multifaceted mathematical system model. It allows developers to utilize knowledge with concepts such as big, moderate and small, which are mapped to numerical ranges [12]. It is, therefore, compatible when the system is highly non-linear, complex, and difficult to model mathematically. Since it requires a lower computation burden and deals with uncertainties with substantial ease, Fuzzy Logic PSS's are considered to be suitable amongst different PSS implementation schemes [8]. The performance of

fuzzy logic PSS predominantly depends on power system operating conditions; however, they are less sensitive to changing conditions than CPSS [9].

A Fuzzy Logic Controller (FLC) endures uncertainty, imprecision or change of input parameters and additionally gives an opportunity to present expert knowledge in control rules. It provides reliable output under changing operating conditions and time-varying input signals as normally experienced in power systems [14]. Hsu and Cheng [15] proposed a fuzzy logic based PSS that used speed deviation and acceleration as inputs that were converted into linguistic variables using some membership functions without any optimization. This proposed PSS was studied on a nine bus system and results were comparatively better than conventional lead-lag PSS. Lotfi and Tsoi tuned membership functions of the fuzzy outputs associated with control rules of an FLC [15]. Hiyama [28] wrote a series of papers on fuzzy logic based controllers for stabilizing power systems using speed and acceleration as an inputs for controller. He devised a phase plane method in order to represent different control regions and actions. Optimal parameter settings were obtained using classical optimization routines. In order to verify the performance, simulations were performed on single machine and a 3 machine system. The results showed better damping control as compared to conventional PSS.

An adaptive Neuro-fuzzy inference system (ANFIS) combines the FLC structure with neural network (NN) learning aspects to determine parameters of the controller. Initially, a rule base, relating controller parameters and operating conditions, is established and then parameters of the controller are tuned in a neural network based training process. Fuzzy parameter estimation is acquired by utilizing different arrays of input-output data [16]. Jang deployed ANFIS to generate membership functions and manage rules of FLC PSS [15]. O.P. Malik designed an Adaptive Neuro Fuzzy Controller by adapting input link weights to obtain optimum performance [17]. In [29], He

and Hariri devised fuzzy based PSS for which parameters were trained off-line so it behaves more like a self-optimizing adaptive PSS presented in [30].

Shamsollahi and Malik [31] devised an adaptive PSS and applied it to a single machine infinite bus (SMIB) and a 5 Machine system. They tested self-coordination ability of the proposed PSS with conventional PSS, and it was shown that proposed PSS provides better damping control as well as coordinates itself with other system's PSSs effectively because of its on-line learning capability. Power System Research Laboratory at University of Calgary was used in order to test and implement this PSS on different systems. Chen and Malik [32] designed a fuzzy logic controller using genetic algorithms in order to acquire optimal parameters for controller. In [33], Abido developed a PSS based on hybrid rules by using a genetic algorithm to find optimal PSS parameters.

In [34], PSS was proposed with single settings of parameters in order to stabilize power system with wide range of operating conditions. The problem was optimized and solved using GA and eigenvalue based functions. In [35], the author proposed a PSS with same idea mentioned above, however, using a different method of optimization to select parameters of PSS. Nehrir and Pierre [36] devised a fuzzy logic based power system stabilizer (PSS) with tuned parameters. Reduced linear models of synchronous machines at an extensive range of operating conditions were acquired, and an optimal PSS was designed separately for each operating condition by frequency domain methods. The same idea was applied to design a Static Var Controller (SVC) controller [37].

Various approaches were presented for designing damping controllers for FACT Devices as well. Larson and Chow [38] used synchronizing and damping torque to represent each electro-mechanical mode of oscillation with the idea of modal decomposition. In [38], the modal

decomposition method was used to analyze the impact of synchronizing and damping torque on each mode of oscillation. The same idea was used to design a Thyristor Controlled Series Capacitor (TCSR) in [39]. Noroozian, in [40], combined SVC and TCSR models in an energy function, and derived the control law by differentiating the energy function and forcing its derivative to be negative. The author stated that any device can contribute towards damping oscillations independently without coordination with other damping devices, and it was great advantage over previous approaches in terms of system stability. In [41], Hiskon and Ghandari used Lyapunov functions in order to design a controller for a FACTS device. They forced the derivative of energy function to be negative as mentioned in previous approach as well; however, the model used to develop control strategy does not describe a real power system's behavior. Zhou [42] presented an approach of using equal area criterion to enhance damping by applying a static var compensator (SVC). He also devised a discontinuous control approach in which deviation of reactive power output of an SVC is a function of transmission line power deviation. Smith [43] devised an SVC controller, which uses only local area data in order to damp system oscillations, his method has shown considerable damping performance on a 3 machine 9 bus system.

Ni and Wu [44] devised a fuzzy logic based damping controller for unified power flow controller (UPFC), and a genetic algorithm was used to optimize the controller's scaling factors. Two area system simulation results showed better performance of fuzzy logic based damping controller as compared to a conventional damping controller.

In this thesis, we use different signals such as machine speed, bus frequency, COI machine speed, and COI machine speed estimations as inputs to a fuzzy logic controller which controls either a PSS or an SVC by supplementary signals. Machine speed and machine angle responses

versus time results are compared to determine the effectiveness of various input choices for the fuzzy logic based PSS and SVC.

3. Systems and Models

Throughout this research work, simulations were carried out on 4 and 50 machine systems using different power system stabilizer and static var compensator controllers.

3.1 4- Machine System

The phenomena of angular stability of synchronous machines experiencing small transients is often analyzed in the literature by examining a 4 machine test system. The Kundur system [24] comprises of two largely symmetrical areas connected together by two 230KV lines of 220 km length. Each has two identical round rotor generators rated 20KV/900MVA. The synchronous machines' parameters are all the same except for inertia which is $H=6.5s$ for Area 1 machines and $H=4s$ for Area 2 machines. The base case load flow (with Generator 2 as slack machine) is such that all generators in the system are producing about 700 MW each. The loads are assumed to be constant impedance loads everywhere, while Area 1 and 2 loads are 976 MW and 1765 MW respectively. In order to improve the voltage profile, 187 MVAR capacitors were added in each area as shown in Fig. 1. Three phase fault of 0.1 sec duration were simulated at tie-line 3-101. The power system stabilizer under study is located at Bus 1, while conventional stabilizers are placed on the other three generators.

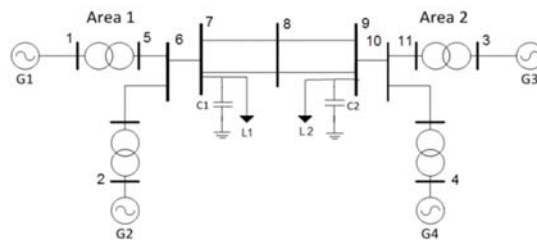

Figure 1 Kundur 4 Machine, 2 Area System [24]

3.2 50- Machine System

The one line diagram of the 145-bus system is shown in Fig. 2. It comprises of 50 generators, 145 buses, and 453 lines with 52 transformers included. There are 60 loads, totaling

2.83 GW and 0.80 GVAR. Seven machines in the study area are represented by the detailed dynamic models while the rest are modeled classically. The loads are considered constant impedance. For simulation purposes, faults were applied at different buses and lines for various time durations.

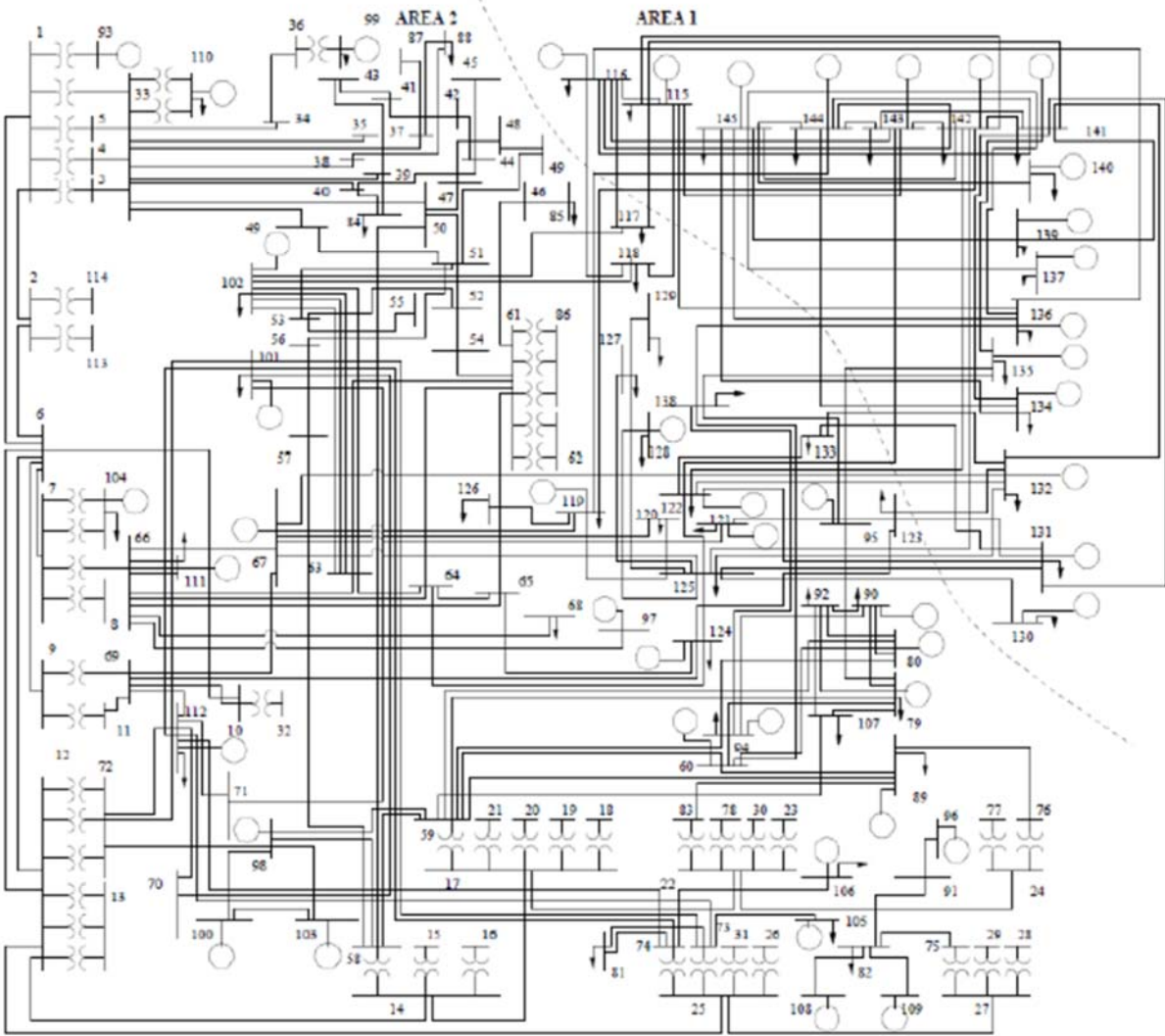

Figure 2 50 Machine System [24]

4. Fuzzy Logic based PSS

The basic purpose of fuzzy systems is to substitute operator experience with a rule-based system. The fuzzy controller converts a linguistic strategy based on experience into an automatic control strategy. In fuzzy logic, the idea is to fuzzify given inputs then infer control decisions based on control rules. The FLC output is obtained by defuzzifying these inferred control decisions. A fuzzy system, as shown in Fig. 3, consists of a total of four components namely: fuzzification interface, an expert knowledge, an inference engine, and defuzzification interface [8].

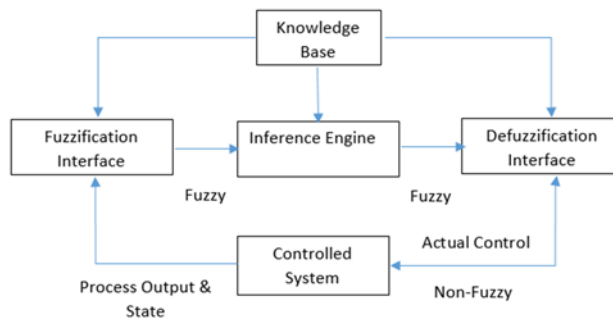

Figure 3 General Fuzzy Logic Structure [8]

The fuzzification interface is the process of transforming numerical input variables into fuzzy variables that can be observed as defined fuzzy sets. Fuzzy sets can be characterized by various membership functions including bell-shaped, linear, triangular and exponential functions. A variables' degree of membership in a given set is defined by these membership functions.

The knowledge base represents knowledge of the application being developed using a set of linguistic rules. The inference engine operates on different conditions from fuzzy sets using the rule base obtained from experience. The rules are stated to define the relationship between input and output of the FLC and are demarcated using linguistic variables. The knowledge required to yield fuzzy rules can be developed from an offline simulation. However, electrical power systems

are highly non-linear and complex in operation so operator experience plays crucial role in describing the rules [8].

The defuzzification inference obtains numerical output from the fuzzy output sets according to output membership functions. The Mamdani type defuzzification inference method is established by the centroid method. In this method, the weighted average of membership functions, or the center of gravity of the area within the membership function curves, is attained to yield a numerical value of the fuzzy quantity [20]. The Takagi-Sugeno defuzzification method uses polynomial functions in place of membership functions. It has an ability to accurately model nonlinear system behavior with relatively few linear equations. Smooth transitions are obtained by implementing fuzzy rules [21]. Takagi-Sugeno method is computationally efficient and performs well with linear techniques, optimization, and adaptive techniques [22].

The fuzzy design process may be divided into following steps: state variable selection, membership function definition, rule building, and fuzzy inference and defuzzification strategy selection.

4.1 State Variable Selection

State variable selection involves the choice of input and output variables. The selection of FLC inputs is the primary research objective of this thesis. This work uses PMU-type data to formulate various FLC input signals for a fairly standard FLC in order to illustrate the effect of input on Fuzzy PSS performance. The output is taken as the standard PSS voltage output signal used for CPSS. The input values are normalized and converted into fuzzy variables. So, the fuzzy power system stabilizer has one input and one output as shown in Fig. 4.

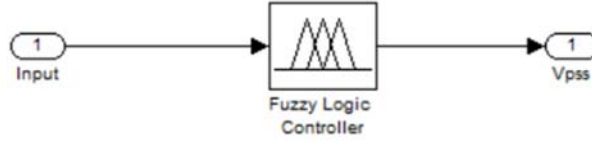

Figure 4 Basic Block Diagram of a Fuzzy Logic PSS

Bus frequency [46] is calculated using bus voltage angles as:

$$Bus\ Freq_i = \frac{bus_angle(i,k) - bus_angle(i,k-1)}{t(k) - t(k-1)} \quad (4)$$

In the above equation, i indicates the bus number of a generator while k indicates time step involved in numerical integration, and t is the simulation time. Thus bus frequency is an estimate of the time derivative of the bus voltage angle, and assumed to be measurable as PMU data.

Some of the input choices used are related to the concept of center of inertia (COI). True COI variable and estimated COI variables (using PMU type data) are used. COI estimated machine speeds are calculated using moment of inertia and bus frequency for all machines as:

$$system_COI_estimate = \frac{\sum Bus_Freq_i * H_i}{H_{total}} \quad (5)$$

The input variables called “COI estimates” are formed as bus frequencies at a bus near the generator minus the system center estimate.

4.2 Membership Function Definition

Linear triangular, sigmoidal, and z-shaped membership functions, in Fig. 5, are used for the input variables. The following fuzzy sets are chosen for the input signal: SN (Small Negative), ZE (Zero), SP (Small Positive), MP (Medium Positive), LP (Large Positive).

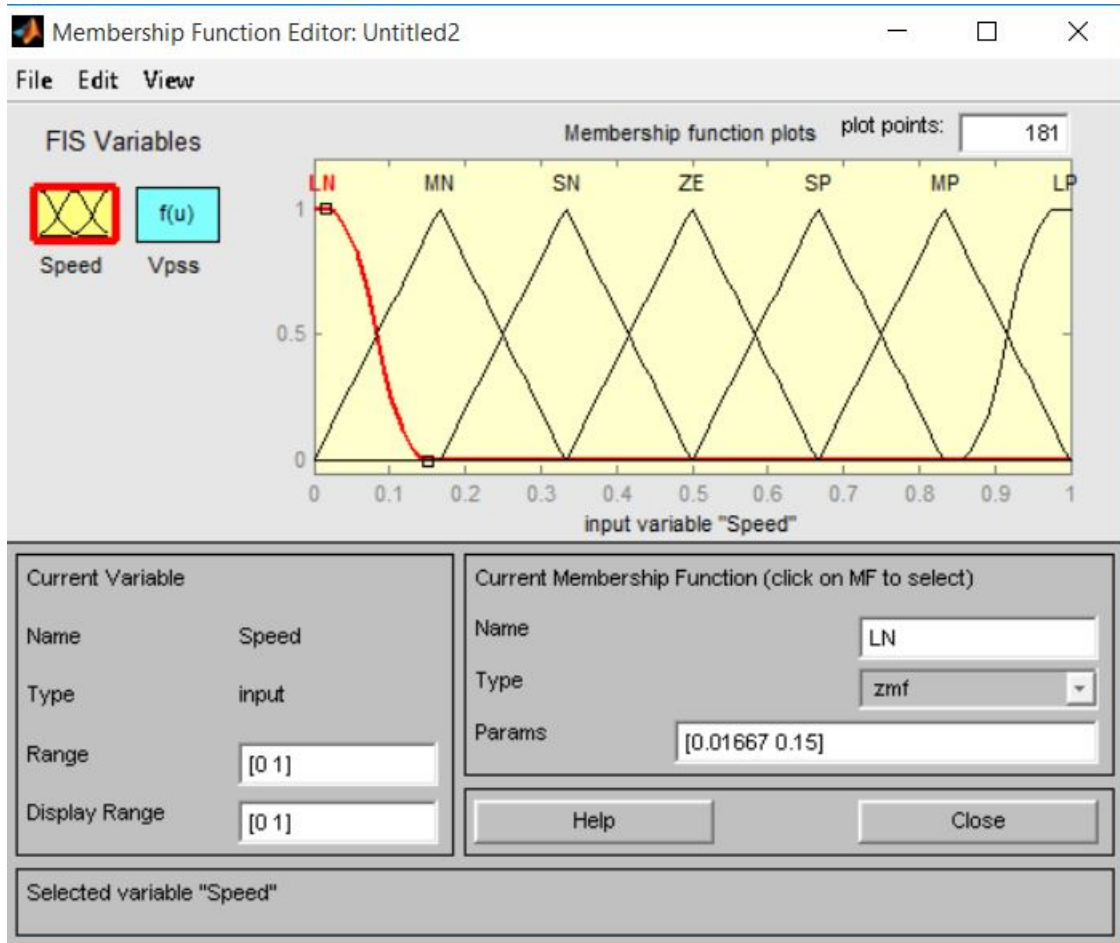

Figure 5 Input Membership Functions

Maximum and minimum values defining range for input and output variables are mentioned in Table 2. Open loop simulation is performed for different initial conditions in order to obtain minimum and maximum values for stabilizer outputs [20]. To give a fair comparison of the various input signals, the same active ranges are used for each variable. Inputs above or below the active range are taken to be LN and LP respectively.

Table 2 Range of Fuzzy Variables

Fuzzy State Variables	Minimum Value (pu)	Maximum Value (pu)
Input	-0.012	0.012
V _{pss}	-0.05	0.2

4.3 Rule Building

The rules are stated to define the relationship between input and output of FLC and are demarcated using linguistic variables. For the proposed FLPSS, the inference mechanism is characterized by a decision table given in Table 3. The set of rules is expressed in the Matlab interface as shown in fig. 6.

Table 3 FLPSS Decision Table

If Input is:	Output Signal is:
LN	SN
MN	SN
SN	SN
ZE	ZE
SP	SP
MP	MP
LP	LP

For example, the first row of the table means “if the input is large negative, the output will be small negative.”

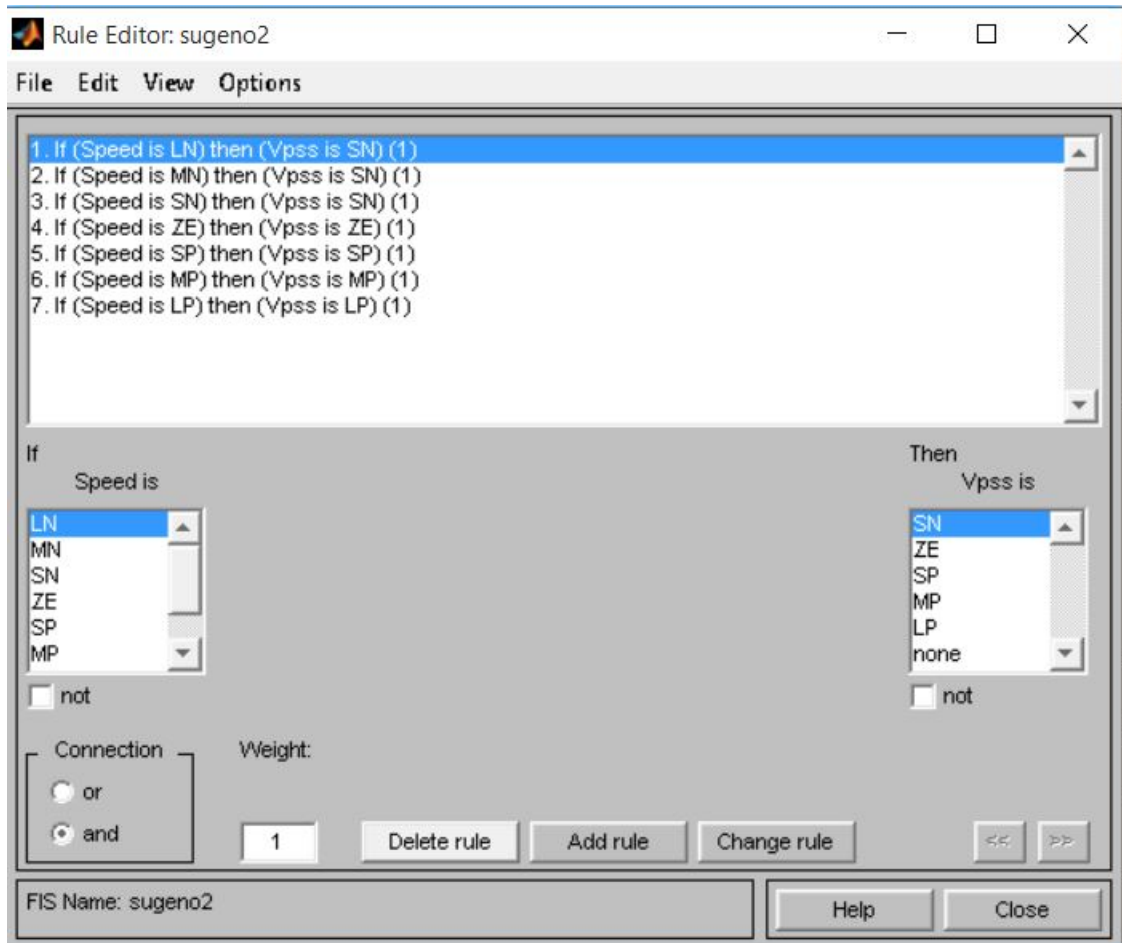

Figure 6 Rules relating Inputs to the Outputs

4.4 Fuzzy Inference and Defuzzification Method Selection

A Takagi-Sugeno inference method is used for all FLC PSS designs presented in this thesis. This simplifies the fuzzy system by utilizing constants for each output membership function as illustrated in the Matlab interface shown in Fig. 7. It would also allow for easier use of adaptive techniques as a future work. The values of the output membership functions were distributed evenly within the active range given in Table 2. The values are SN = -0.05, ZE = 0, SP = 0.1, MP = 0.15, and LP = 0.20.

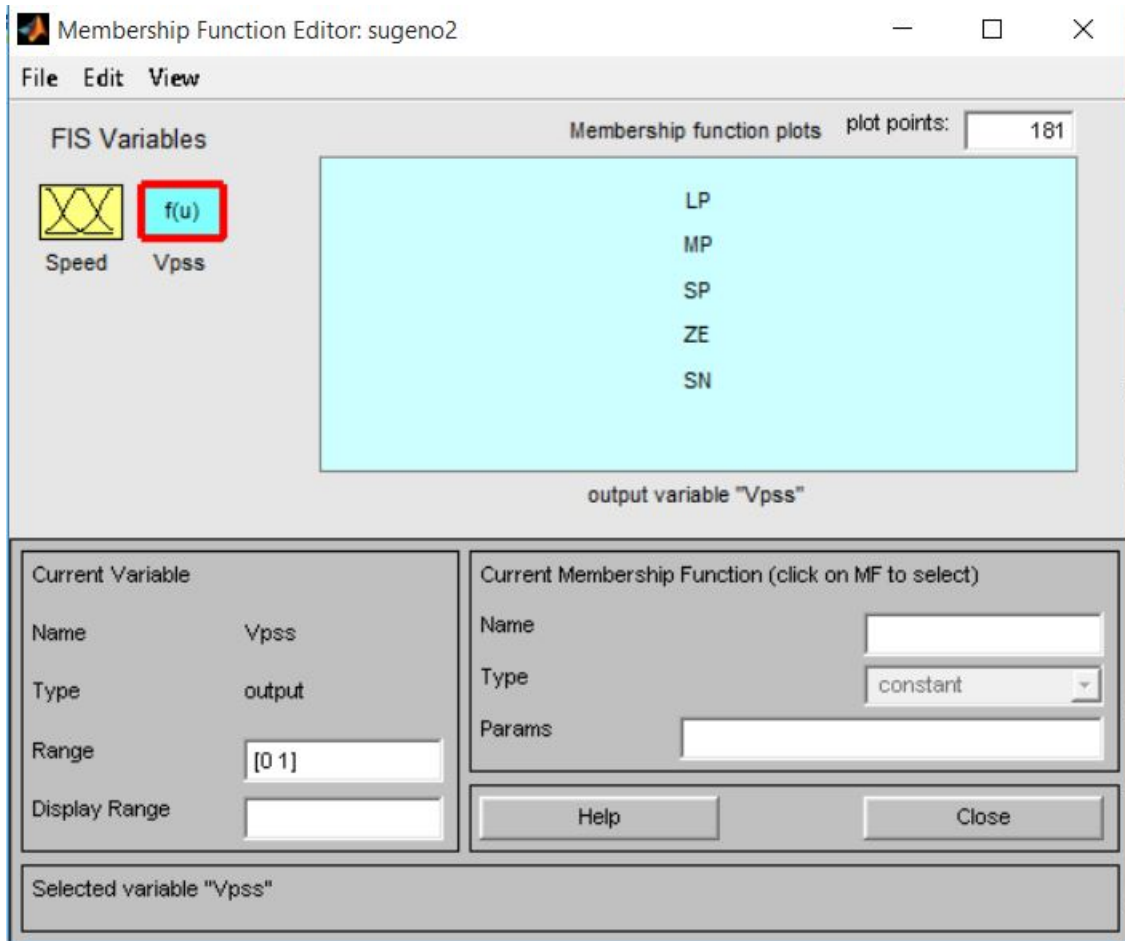

Figure 7 Output Membership Functions

4.5 Simulation Results

4.5.1 4-Machine System

Simulations were performed using a transmission line fault on a Two Area Multi-Machine System. Machine responses are obtained by non-linear simulation using a Cherry Tree Power System Toolbox for Matlab [23]. System responses with FLPSS for various operating conditions are then compared with conventional PSS. Matlab and its fuzzy logic toolbox [23] have been used for system simulations. The Table 4 describes briefly about simulations that were run in this

section. Each controller designed used the same machines but with a different input. The fault was placed on bus 3 and line 3 to 101 being cleared after 0.1 sec.

Table 4 4 Machine PSS Cases

Fuzzy Controllers Tested	Bus Measurement				PSS Machine
Bus frequency	1	6	8	10	1
Machine speed					1
COI Frequency Estimate 1	1	6	8	10	1
COI Frequency Estimate 2	6		10		1
Simulations					
Parameter changed from base case	From				To
Power (P)	7,7,7,7 (pu)				8, 8, 6.53, and 6 (pu)
Inertia 1 (H)	6.5, 6.5, 4, and 4 (s)				8, 7, 5, and 6 (s)
Inertia 2 (H)	6.5, 6.5, 4, and 4 (s)				3, 4, 5 and 6 (s)

Comparing CPSS to FL PSS with Speed Inputs

Machine angle responses for the generator on which the PSS was installed (Generator 1) are shown in the various Figs. Fig. 8 compares the machine angle responses for a CPSS with machine speed as input, a fuzzy PSS with machine speed as input, and a fuzzy PSS with COI machine speed as input. The fuzzy PSS shows a lower peak angle swing with better damping than the CPSS, although both utilize the same inputs. However, since the goal is to use PMU data, other inputs are explored further.

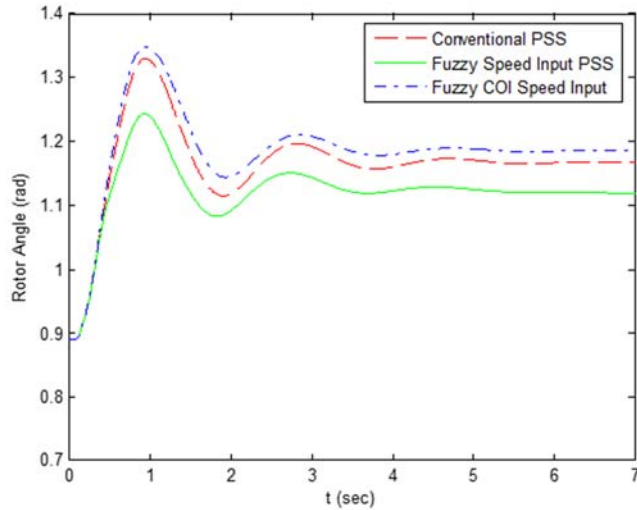

Figure 8 Fault comparison of CPSS to Fuzzy PSS with speed and COI speed inputs

Comparing FLPSS with Speed and COI Speed Inputs

In observing Fig. 8, it is seen that the COI speed input FLPSS swings further in the positive direction than the FLPSS with speed input. Damping appears to be quite similar in both cases.

Comparing FLPSS with Bus Frequencies as Inputs

Here we approximate the use of PMUs to measure bus voltage angles which are then used to estimate bus frequency for use as input to the FLPSS. In this work, no time delay in the measurements is considered, because it has been shown to be manageable by other authors [6]. Fig. 9 depicts the machine angle comparison of several fuzzy PSSs with bus frequencies as inputs. Comparing Fig. 8 and Fig. 9 shows that using bus frequency at the generator terminals produces similar but slightly worse results than seen when using speed as input to the FLPSS. As seen in Fig. 9, when frequency at Busses 1 and 6 are used as inputs, the responses are quite similar, but

when the input is taken from Bus 8 or 10 the swings are larger and less well damped. Referring to the 4-generator system map, we see buses 1 and 6 are closer to generator 1 where the PSS is located. Thus, as expected, measurements taken near the generator being controlled yield better results.

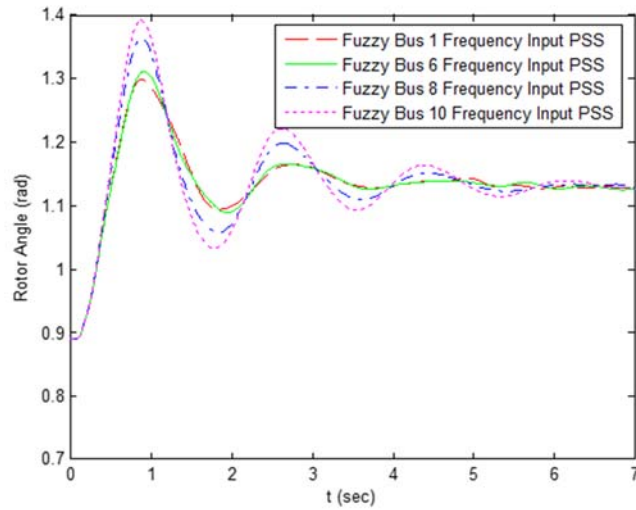

Figure 9 Fault responses for Fuzzy PSSs with bus frequency input

Comparing Estimates of COI Speed as FLPSS Input

Fig. 10 shows Generator 1's machine angle comparison between a Fuzzy PSS with true COI machine speed as input and a Fuzzy PSSs using COI machine speed estimated two different ways as inputs. The first estimate uses COI bus frequencies in place of the machine speed. Equation (6) gives the estimated COI speed of generator 1 which was used as input to the FLC.

$$1st\ COI\ Estimate\ Speed_1 = bus\ freq_1 - \frac{bus\ freq_1 * H_1 + bus\ freq_2 * H_2 + bus\ freq_3 * H_3 + bus\ freq_4 * H_4}{H_{total}}$$

(6)

For the second estimate, Area 1's speed is approximated as the frequency at Bus 6 and is multiplied by the sum of the inertias of Generators 1 and 2. Similarly, Area 2's speed is taken as the bus frequency at Bus 10 and multiplied by the sum of the Generator 3 and 4's inertias. FLC input using the second method to estimate generator 1's COI speed with PMU signal is given by equation 7. This estimate requires only 2 PMUs as opposed to 4 needed for 1st COI estimate.

$$2nd\ COI\ Estimate\ Speed_1 = bus\ freq_1 - \frac{bus\ freq_6 * (H_1 + H_2) + bus\ freq_{10} * (H_3 + H_4)}{H_{total}} \quad (7)$$

The responses are again quite similar to those seen previously, with the FLPSS's with estimated COI calculations having slightly lower maximum swing values, but exhibiting some higher frequency oscillations later in the simulations.

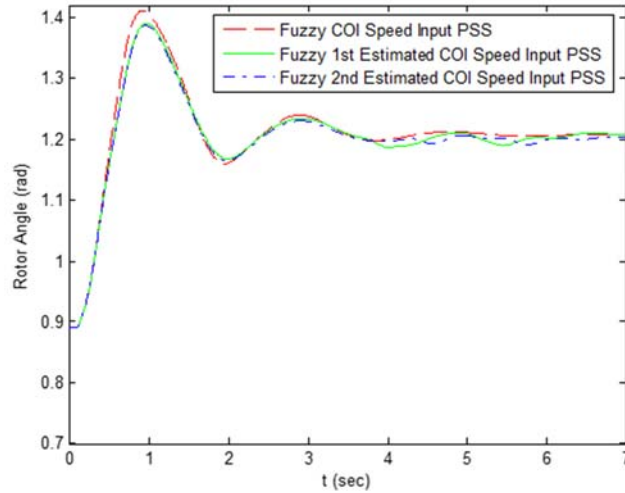

Figure 10 Fault responses for FLPSSs with COI speed and estimated COI speed inputs

Effects of Significant Changes in Generator Inertia

To compare the robustness of various PSS designs to significant changes in system parameters, this case shows Generator 1's angles for the same fault case, but with the inertias of the generators changed from (6.5, 6.5, 4, and 4 s) to (3, 4, 5 and 6 s) respectively. Though the

inertia of an individual generator would not typically change, if each generator in this system is taken to represent a group of generators making up a large portion of the system, inertia of a region could change due to the replacement of large a synchronous machine with a comparably sized wind farm. As seen in Fig. 11, the FLPSS's and the CPSS respond similarly for this large change in system parameters. The FLPSS with speed input again has the lower maximum angle swings and appears most well-damped. However, the FLPSSs show low-amplitude, higher frequency oscillations not seen in the CPSS response. In particular, the bus frequency input produces sustained high frequency oscillations.

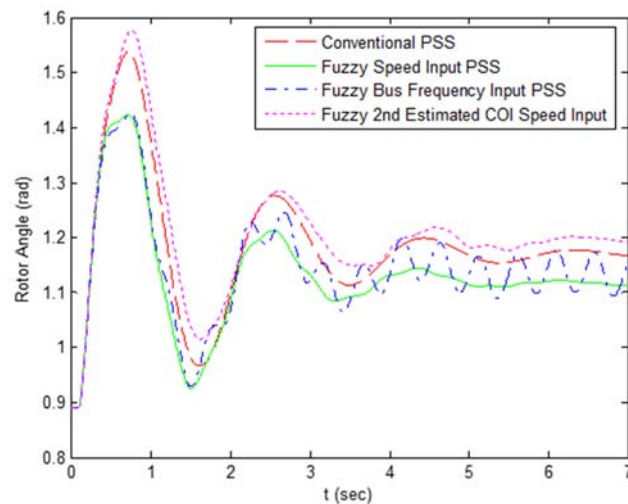

Figure 11 Fault comparison of CPSS to Fuzzy PSS with speed, bus frequency and COI speed inputs

A second case is seen in Fig. 12 with the inertias of the generators changed from (6.5, 6.5, 4, and 4 s) to (8, 7, 5, and 6 s) respectively. Since the inertias of the system are increased, lower frequency oscillations are expected. As seen in Fig. 8, the FLPSS with speed input has the smallest maximum swings and good damping. The FLPSS with the 2nd estimated COI speed input is well damped

but has a larger maximum swing. The FLPSS with Bus Frequency input has small swing and damped oscillations significantly better.

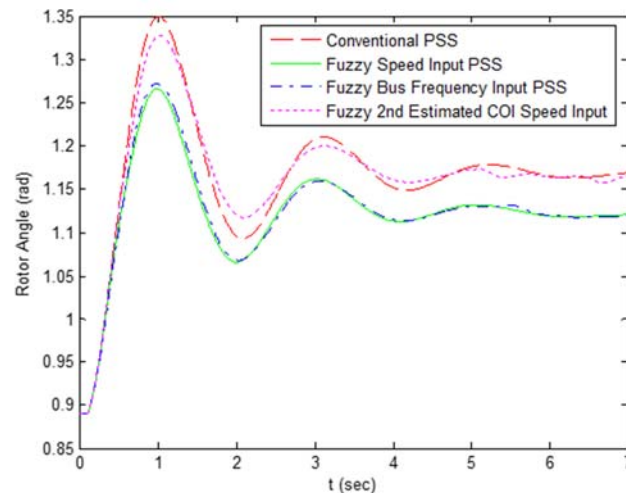

Figure 12 Fault comparison of CPSS to Fuzzy PSS with speed, bus frequency and COI speed inputs

Observing Effects of Changes in Generator Power

Another parameter change studied is to modify the scheduled generator active power. The power values are changed from all being approximately 7 pu to (8, 8, 6.53, and 6) respectively. Fig. 13 illustrates that CPSS and Estimated COI PSS become unstable for this case due to larger first swings. The FLPSS speed and bus frequency input cases show large swings but are still well damped.

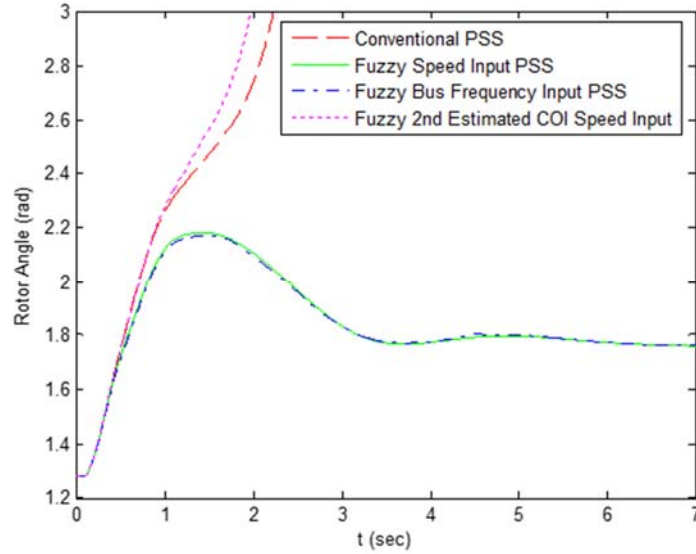

Figure 13 Fault comparison of CPSS to Fuzzy PSS with speed, bus frequency and COI speed inputs

4.5.2 Summary of 4 Generator PSS Cases:

After running all simulation cases and analysing their results, we observed that inputs such as machine speed and bus frequency performed significantly well at damping electromechanical oscillations. Since PMUs provide data at exceptionally high speed and bus frequency can be acquired through PMUs directly, it would be a better choice to use bus frequency as an input for fast system response. Furthermore, for wide area monitoring, estimated center of inertia (COI) based input can be used for oscillations damping.

4.5.3 50- Machine System

Here, we implemented fuzzy logic based PSS using different inputs one at a time on a 50 machine system and ran nonlinear simulations in order to analyze the efficiency of the fuzzy PSS to damp low frequency electromechanical oscillations as compared to conventional PSS. Simulations were performed using transmission line faults of different durations. The Table 5 describes briefly the simulations that were run in this section.

Table 5 50 Machine Simulation Cases of PSS

Controllers Tested			
Inputs	Input Bus	Machine	PMU Location Used (Buses)
Bus Frequency	6	2	6
Machine Speed	-	2	Machine 2
True COI	-	2	All Machines
COI Frequency Estimate	6	2	6,136,128,139,141,145
COI Voltage Angle Estimate	6	2	6,136,128,139,141,145
Voltage Angle	6	2	6
Voltage Angle Difference	6, 12	2	6,12
Simulations			
Fault Cases	Line cleared	Near end bus clear (sec)	Far end bus clear (sec)
Short Fault Bus 6	6-7	0.1	0.15
Long Fault Bus 6	6-7	0.25	0.30
Different Location Fault Bus 12	12-14	0.2	0.25

Short Fault

For Figs. 14-17, simulations were performed for 0.1 sec fault duration on Bus 6 with line 6-7 cleared at 0.15 sec and damping performance for FLC's with different inputs is compared. The Fig. 14 shows the behavior of different machines (1, 2, 3, 4, 5, 6, 23) while using the fuzzy based bus frequency PSS on Machine 2 only. Machine 2 is connect to bus 104 with line 104-7 connecting it radially with rest of the system. Fig. 14 is presented to give an idea of the overall system response to the particular fault. Machine angles with respect to COI reference are presented. Generator 2, represented near the top of the graph in green, has the largest swing in the group, due to its nearness to the fault.

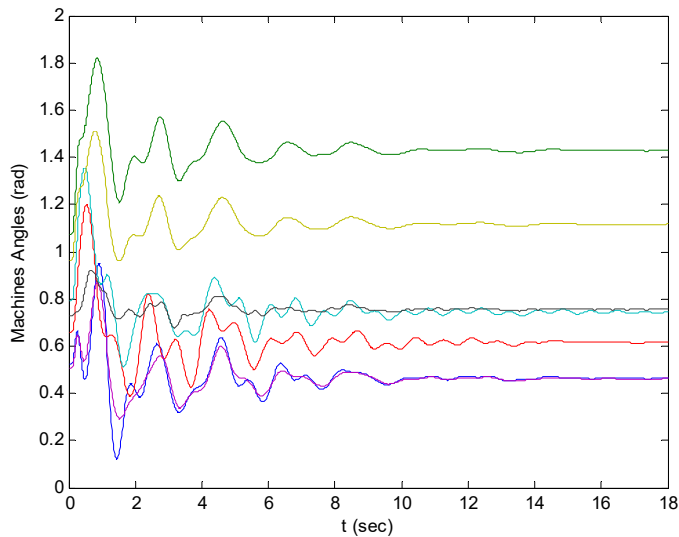

Figure 14 Short Fault Machine Angles with Fuzzy Bus Frequency PSS at Gen 2

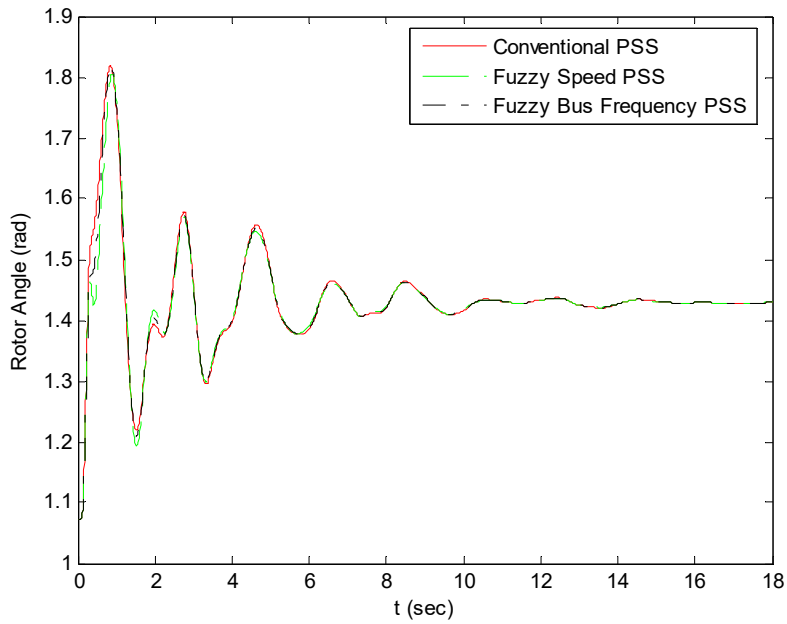

Figure 15 Short Fault Comparison of Fuzzy Speed and Bus Frequency PSS at Gen 2

In Fig. 15, a conventional PSS performance is compared with fuzzy logic based PSS using speed at Generator 2 and bus frequency at Bus 6 inputs. It is evident from the graph that FLPSS with speed input is slightly better damped and has smaller swings as compared to other responses, though all controllers perform similarly.

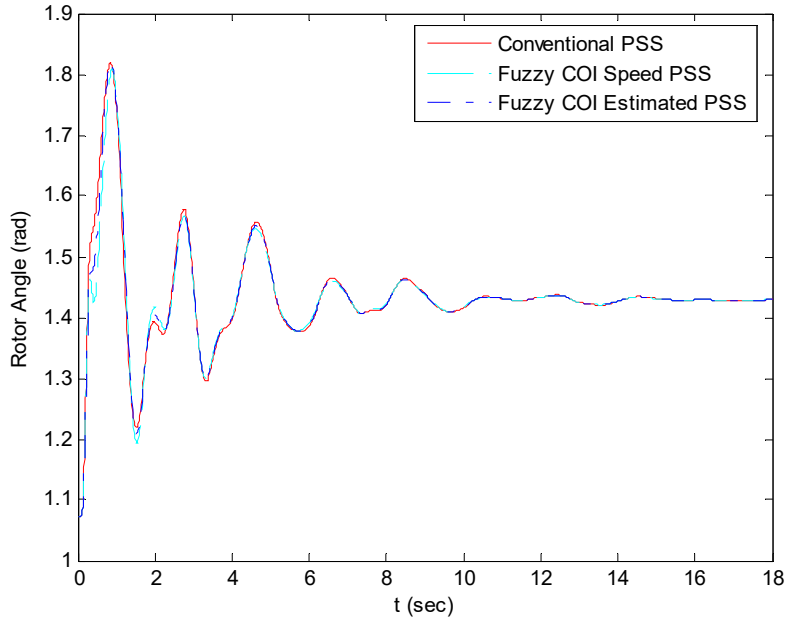

Figure 16 Short Fault Comparison of CPSS to Fuzzy COI and Estimated COI Speed at Gen 2

Fig. 16 shows a comparison of conventional PSS with Fuzzy logic based PSSs using COI speed, and estimated COI speed as inputs all at Generator 2. The estimated COI speed at Gen 2 was calculated using bus frequency at Bus 6 as shown in equation 8. The results in the figure show that COI Speed based Fuzzy logic PSS damps low frequency electromechanical oscillations better than conventional and estimated COI Speed ones though responses are all very similar.

$$Estimated\ COI\ Frequency_6 = Frequency\ at\ bus\ 6 - \frac{\sum_{i=1-5} bus\ freq_i * H_i}{H_{total}} \quad (8)$$

Where i indicates buses where PMU's are located (see Table 5) and H_i is sum of the inertias of generator near PMU buses. This is done such that each of the 11 largest generators (8, 22, 24, 32, 36, 38, 42, 44, 46, 47, and 50) is associated with one PMU. H_{total} is the sum of the inertias of the group of 11 largest generators in the system.

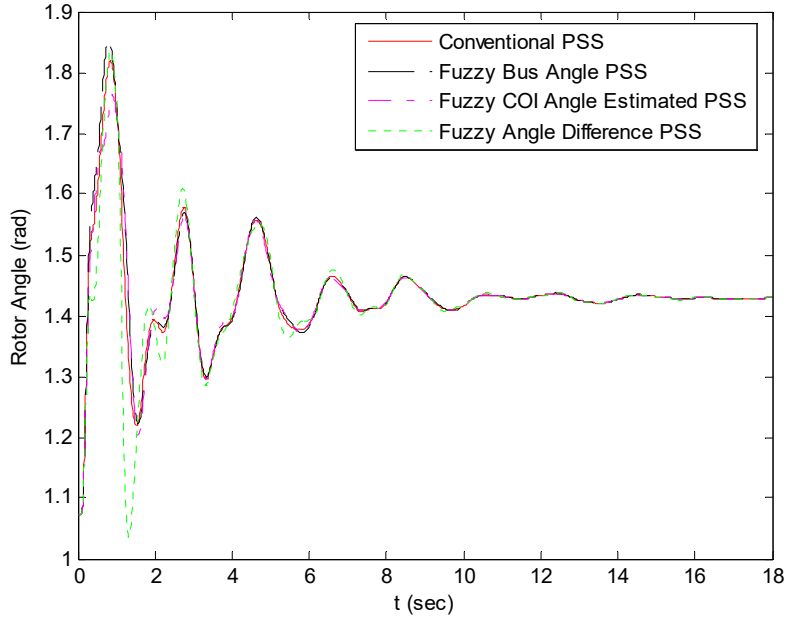

Figure 17 Short Fault Comparison of CPSS to Fuzzy Bus Angle and COI Estimated Angle PSS at Gen 2

In Fig. 17, a conventional PSS is compared with Fuzzy PSS using the bus voltage angle difference between Bus 6 and 12 and the estimated COI bus voltage angle at Bus 6 as inputs. The estimated COI bus voltages angle at Bus 6 was calculated using following equation:

$$Estimated\ COI\ bus\ voltage\ angle_6 = voltage\ angle\ at\ bus\ 6 - \frac{\sum_{i=1-5} angle(bus\ voltage)_i * H_i}{H_{total}} \quad (9)$$

Fig. 17 illustrates that Fuzzy PSS with bus voltage angle input is not good to damp electromechanical oscillations while the estimated COI one performed well and damped oscillations significantly and better than others. The bus angle difference was used in [6] as a way to measure local and global oscillations thus it was included here.

Longer Fault

For Figs. 18-21, simulations were performed for a 0.25 sec fault duration and damping performance results for fuzzy PSS controllers with different inputs are compared. The fault was at Bus 6 and line 6-7 was cleared. Since fault is longer than the previous duration, the oscillation amplitude is larger and the oscillations last longer than in the previous case where we simulated a shorter fault duration. Fig. 18 below shows the behavior of the machines (1, 2, 3, 4, 5, 6, 23) having detailed models in the simulation. The fuzzy based bus frequency PSS was placed on Machine 2 only.

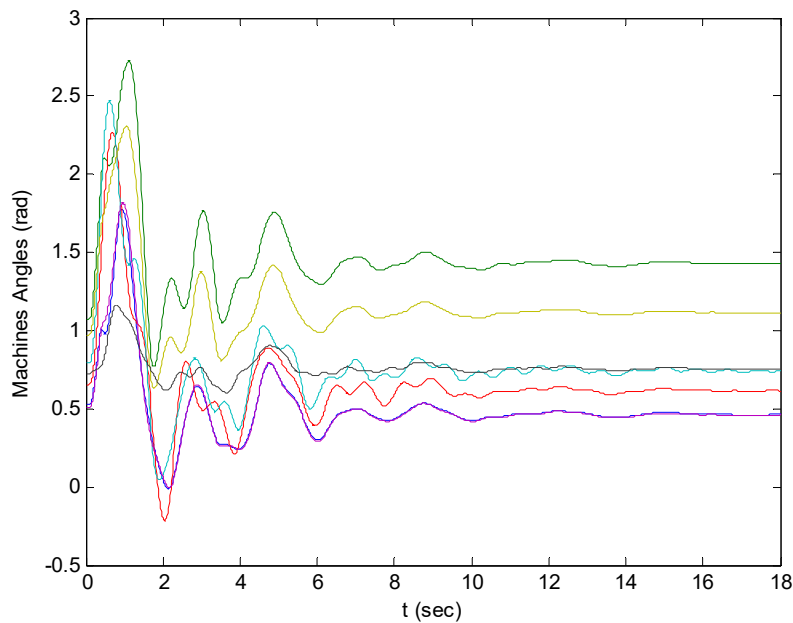

Figure 18 Longer Fault Machines Angles with Fuzzy Bus Frequency PSS at Gen 2

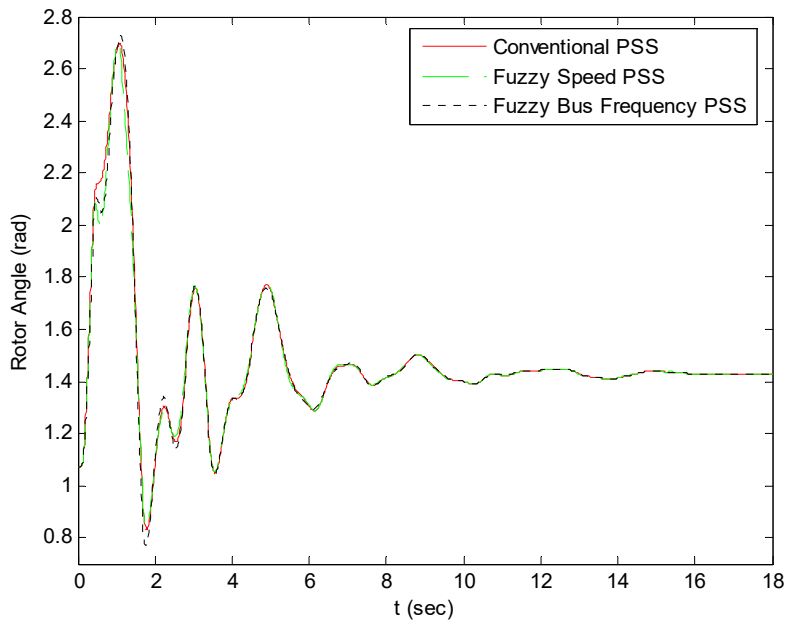

Figure 19 Longer Fault Comparison of CPSS to Fuzzy Speed and Bus Frequency PSS at Gen 2

In Fig. 19, a conventional PSS performance is compared with fuzzy logic based PSS using speed at Machine 2 and bus frequency at bus 7 inputs. These are the same controllers compared in Fig. 15. We see that the FLPSS with speed input is well damped and has smaller swing as compared to other responses even if the fault persists for a longer time. From results, it's obvious that machine speed input to Fuzzy PSS damps low frequency oscillations better than bus frequency input as it gets affected instantly during the fault.

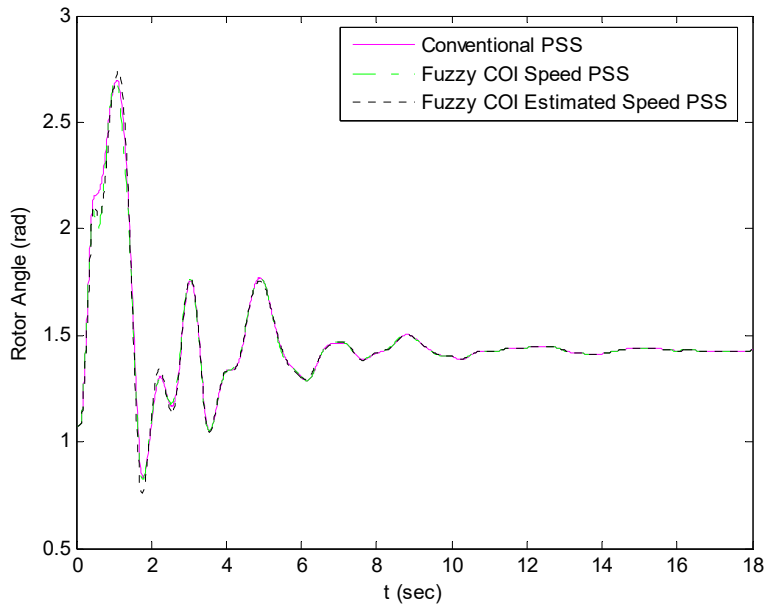

Figure 20 Longer Fault Comparison of CPSS to Fuzzy COI and Estimated COI Speed at Gen 2

Fig. 20 exhibits a comparison of conventional PSS with Fuzzy logic based PSS using true center of inertia speed of Generator 2 and estimated COI speed of Generator 2 as inputs. This is the more severe test of the controllers considered in Fig. 16. The results demonstrate that COI Speed based Fuzzy logic PSS exceeded conventional and estimated COI Speed based power system stabilizers in damping low frequency electromechanical oscillations. This is in contrast to the results from the shorter fault in which estimated COI controller looked better.

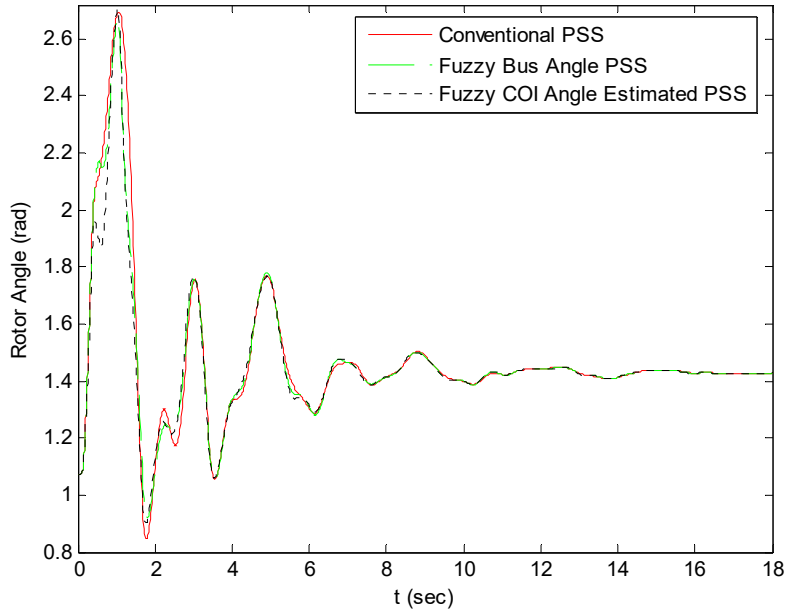

Figure 21 Longer Fault Comparison of CPSS to Fuzzy Bus Angle and COI Estimated Angle PSS at Gen 2

In Fig. 21, a conventional PSS is compared with Fuzzy PSS using bus voltage angle and estimated COI angle as inputs. This graph illustrates three of the four controller's responses shown in Fig. 17. The figure shows that Fuzzy PSS with bus voltage angle and estimated COI angle input are better at damping electromechanical oscillations while conventional one has larger second, third and fourth swings.

Fault at Different Location:

For Figs. 22-25, the fault was placed on transmission line which is away from generator have the PSS under study (at Generator 2) to analyze the stabilizer performance with respect to fault location farther from the generator. Simulations were performed for 0.2 sec fault duration and damping performances for different inputs are compared. The fault was on bus 12, with line 12 to 14 being cleared. Fig. 22 depicts the behavior of the machines (1, 2, 3, 4, 5, 6, 23) having

detailed models in the simulation while using the fuzzy based bus frequency PSS on Machine 2. In this case, generator 3 has largest swing in the group.

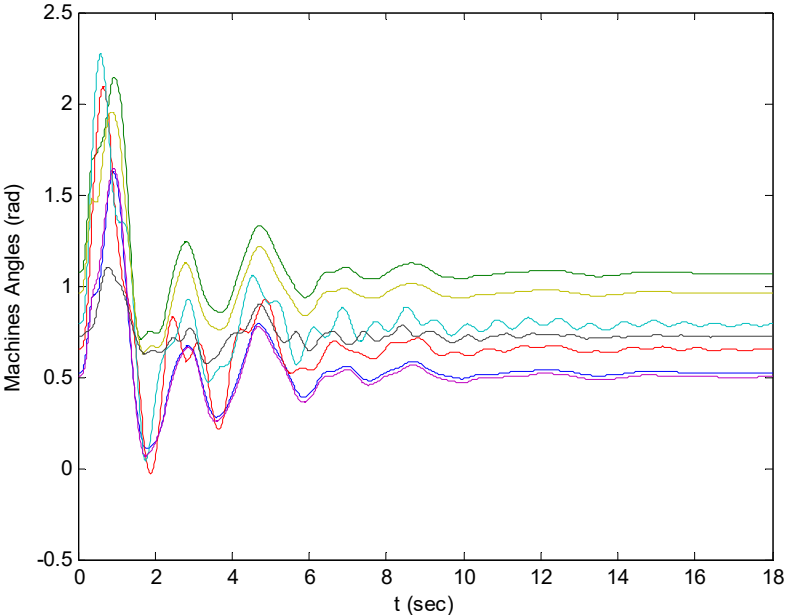

Figure 22 Different Location Fault Machines Angles with Fuzzy Bus Frequency PSS at Gen 2

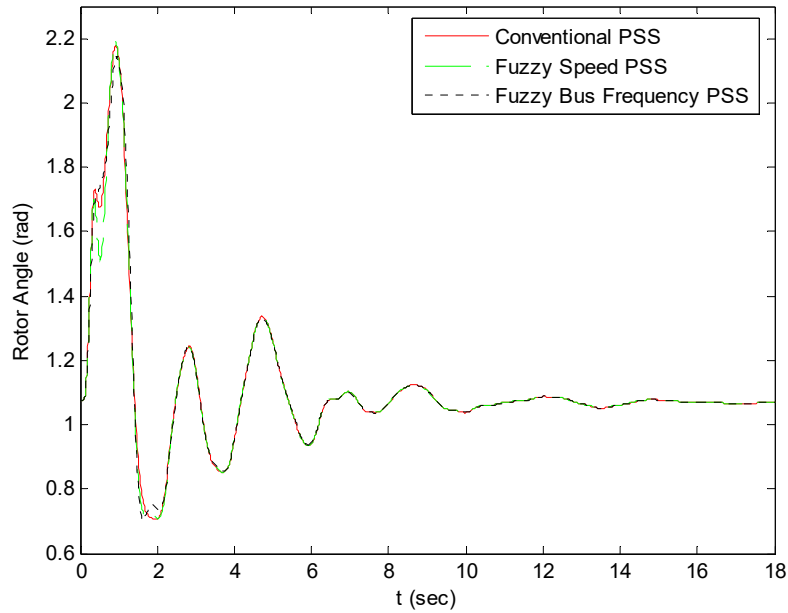

Figure 23 Different Location Fault Comparison of CPSS to Fuzzy Speed and Bus Frequency PSS at Gen 2

Fig.23 shows a comparison of the conventional PSS with fuzzy logic based PSS using speed of Machine 2 and bus frequency at Bus 6 as inputs. This simulation is testing the same controllers seen in Fig. 15 and 19. In this case, swings are of large amplitude as compared to previous cases because it is a more severe fault. The above graph manifests that FLPSS with bus frequency input damps electromechanical oscillations better though all controllers perform almost similarly.

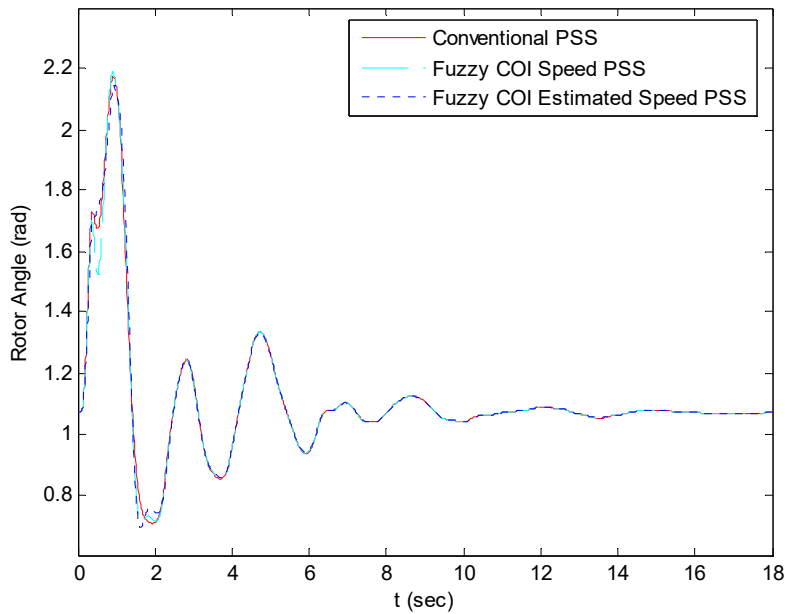

Figure 24 Different Location Fault Comparison of CPSS to Fuzzy COI and Estimated COI Speed at Gen 2

Like Fig. 16 and 20, Fig. 24 shows a comparison of a conventional PSS with Fuzzy logic based PSS using true center of inertia speed of Generator 2 and estimated COI speed of Generator 2 as inputs. The results in figure demonstrate that estimated COI speed based fuzzy logic PSS exceeded conventional and COI speed based power system stabilizers in the first swings. As the fault is placed further away from the PSS generator, it takes more time for generator to settle down low frequency oscillations because of poor control at farther fault location.

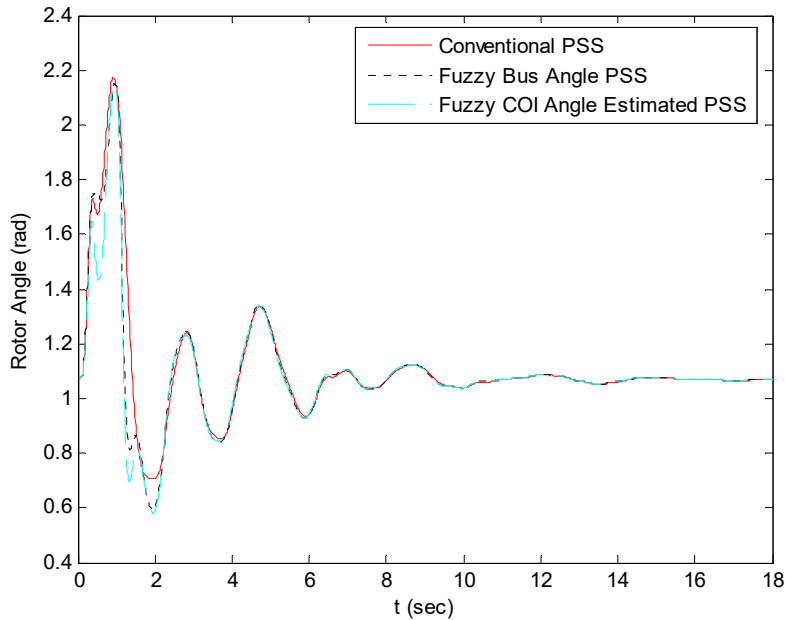

Figure 25 Different Location Fault Comparison of CPSS to Fuzzy Bus Angle and COI Estimated Angle PSS at Gen 2

In Fig. 25, the conventional PSS is compared with fuzzy logic based PSS using global (Estimated COI) and local bus voltage angles as inputs as was done in Fig. 17 and 21. The results indicated that Fuzzy PSS with Bus Voltage Angle input (Global & Local) are damped electromechanical oscillations less well while conventional one.

4.5.4 Summary of 50 Generator Cases:

From simulation results, we perceived that PMU acquired input such as bus frequency (local measurement) and estimated COI (global measurement) performed well to damp oscillations with low amplitude. Bus voltage angle (local area) and estimated COI voltage angle (wide area) inputs are concerned, they did not perform in most of the simulation cases at damping electromechanical oscillations. The Table 6 shows the different trend of results that we obtained

from simulations shown in Figs. 15,16,17,19,20,21,23,24,25. The 1st swing column shows an amplitude of first swing while 2nd column shows comparative heuristic measurements of the damping of the controller for each case.

Table 6 Summary of 50 Generator Cases of PSS

Controller	Short fault		Longer fault		Diff. location fault	
	1st Swing (rad)	damping	1st Swing (rad)	damping	1st Swing (rad)	damping
Conventional	1.82	Worst	2.7	Worst	2.18	Worst
Machine speed	1.78	Best	2.69	Best	2.17	Medium
Bus frequency	1.80	Medium	2.72	Medium	2.16	Best
True COI	1.81	Best	2.68	Best	2.14	Best
COI Frequency Estimate	1.80	Medium	2.71	Best	2.17	Medium
COI Voltage angle estimate	1.76	Best	2.71	Worst	2.14	Best
Voltage angle	1.83	Worst	2.68	Best	2.16	Medium
Voltage angle difference	1.82	Worst	-	-	-	-

5. Fuzzy Logic Based Static Var Compensator (SVC)

The fuzzy logic based controller designed for the PSS is now to be used to supply a supplementary input signal to a static var compensator (SVC). The following SVC model was used in this work to carry out all simulations as was done in the PSS cases. Various inputs are used, one at a time, for the fuzzy controller to compare the effects of input on damping performance.

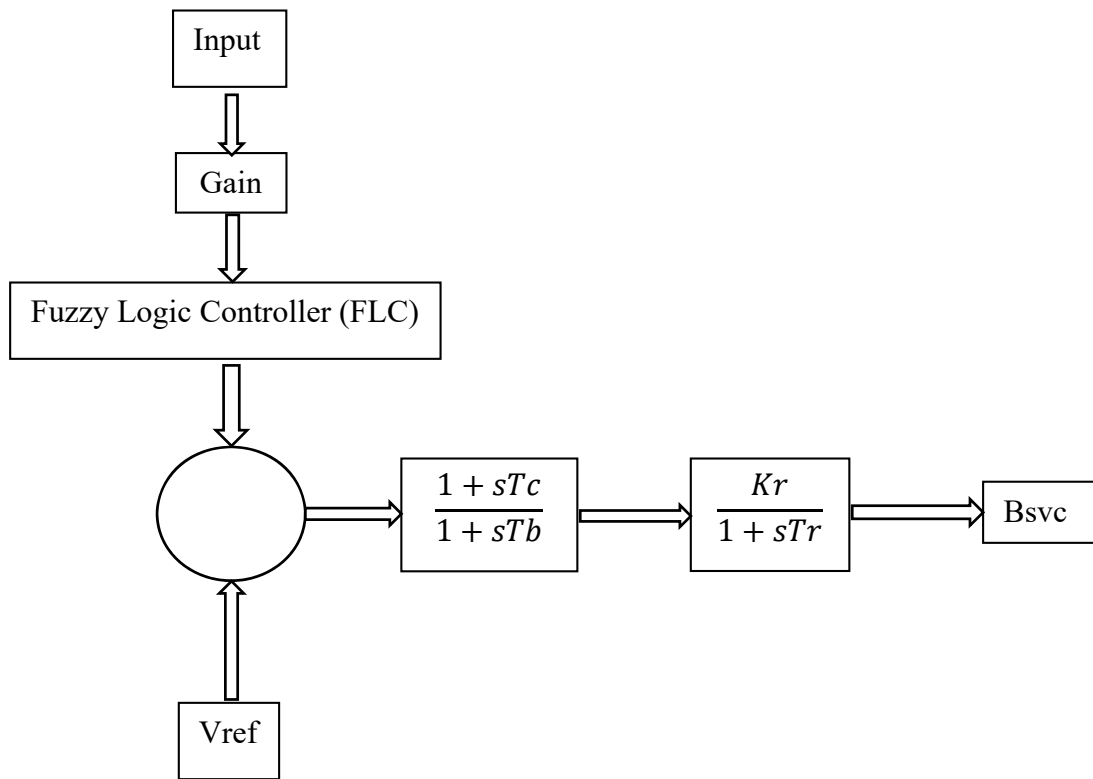

Figure 26 SVC Model Block Diagram

In Fig. 26,

T_c is compensator lead time constant, **T_b** is compensator lag time constant, **K_r** is regulator gain, **T_r** is regulator time constant, **B_{svc}** is SVC susceptance in pu, and **V_{ref}** is reference voltage.

An SVC is a shunt device which can provide voltage control, damping control and stability in electric power systems. The most common configuration of an SVC which is deployed in power systems is known as Thyristor Controlled Reactor- Fixed Capacitor (TCR-FC) in which TCR controls reactive power in lagging power factor while FC controls in leading power factor range. Fig. 27 depicts TSC-FC configuration.

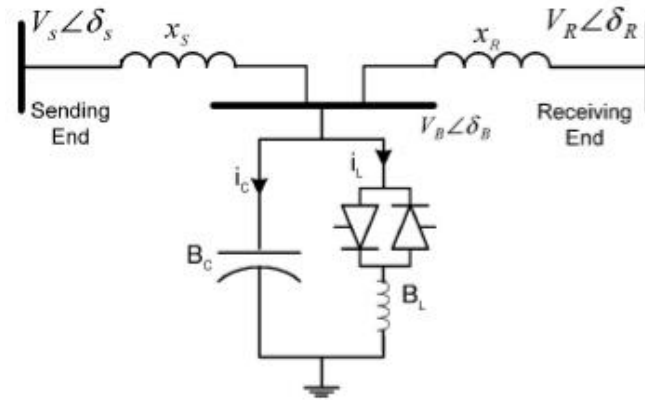

Figure 27 TCR-FC SVC connected in Power System [48]

Depending upon the power factor range, shunt element with susceptance (jB) works as follow:

If $V < V_{min}$: $B=1/X_C$

If $V > V_{max}$: $B=-1/X_L$

X_C and X_L represents capacitive and inductive reactance respectively while V_{min} and V_{max} are predefined voltage limits.

A typical voltage controlled SVC cannot provide significant damping of electromechanical oscillations. The effective oscillation damping is achieved by imposing a supplementary control signal over the SVC's voltage loop as shown in Fig. 26. Since the SVC is used in the transmission system, the supplementary signal could be line currents, active or reactive power, or bus frequency.

An SVC provides damping in power system when it is incorporated with damping controllers which actually modulate the bus voltage by responding to a supplementary control signal sensitive to power swings. Normally, SVC damping controller is performed by sensing changes in power transmitted along transmission corridors and damping torque provided by controller directly relies upon the controller’s gain [49]. In this work, we investigate the use of PMU-based signals like bus frequency.

5.1 Input Gain adjustment in the 4 Machine System:

SVC gain plays a critical role in damping oscillations and voltage fluctuations. A compromise is made to adjust gain in such a way to damp oscillations with minimal voltage deviation from pre-defined limits. A gain can be adjusted using input and output scaling up to a certain level within the fuzzy logic controller (FLC). In this section, we look at the effects of multiplying the inputs to the fuzzy system by various gain factors. In other words, we are using different values in the gain multiplier block of Fig. 26. The Table 6 describes briefly the simulations that were run in this section.

Table 7 SVC Gain Cases-4 Gen System

Inputs	Bus				
Bus frequency	101				
Simulations	Gain Changes				
Voltage Fluctuation	4	6	8	10	12
Machine Angle	4	6	8	10	12

From Figs. 28 and 29, it's evident that bus voltages are sensitive to SVC gain change. As we increase the gain, it affects voltage profile accordingly so we need to limit the SVC gain in order to have the least fluctuation in system voltage and maintain reactive power as well. Considering this, the maximum gain considered reasonable for this 4 generator system is 8, since it shows minimal voltage “notches” in the transient response.

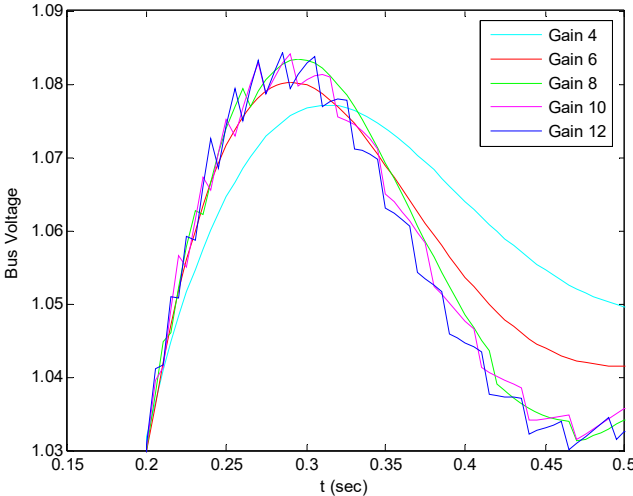

Figure 28 Voltage Fluctuation at Different Gains for 4 Gen System (Expanded View)

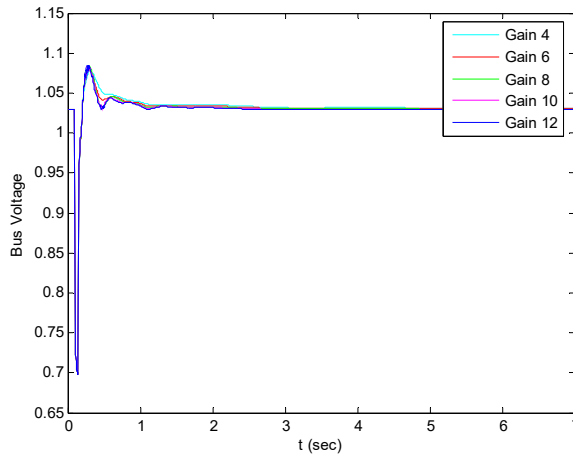

Figure 29 Bus Voltage at Different Gains for 4 Gen System

In Figs. 30 and 31, we can comprehend that changing SVC gain also affects oscillation damping considerably. At higher gains, SVC controller damps electro-mechanical oscillations more effectively than at lower gains. However, because increased gain causes problems in voltage magnitude response, a gain of 8 was chosen to balance the needs of voltage magnitude stability and oscillation damping. Machine and system constraints play key role in defining gain limit for SVC Controller, specially, where different power systems are inter-connected through long EHV tie-lines, thus this gain choice is system specific.

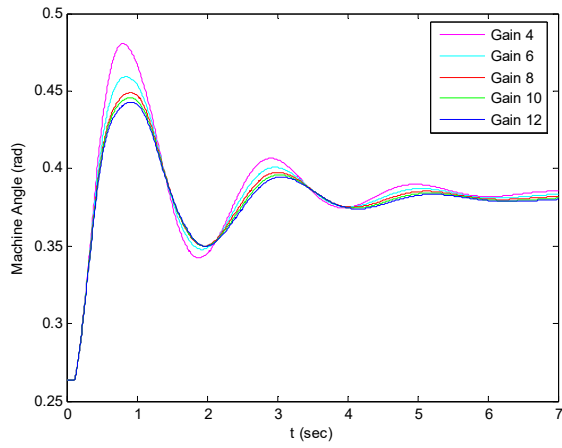

Figure 30 Machine Angle at Different Gains for 4 Gen System

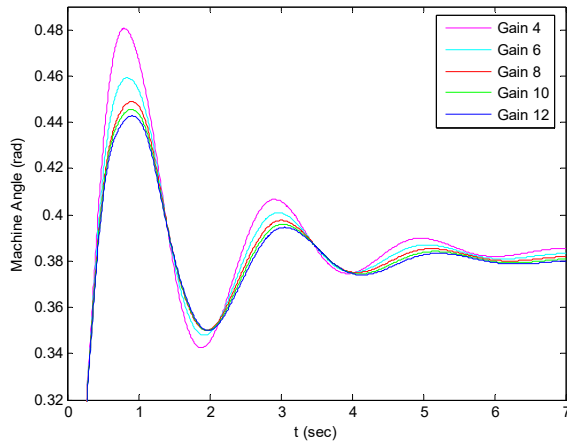

Figure 31 Machine Angle at Different Gains for 4 Gen System (Expanded View)

5.2 Input Gain adjustment in the 50 Machine System:

Fig. 32 is a Susceptance graph showing an SVC controller's effects to damp oscillations at different gains (near Machine 2) for fault duration of 0.1 sec (6 cycles) at bus 6, with line 6 to 7 being cleared. As expected, with a higher gain, the controller is more active as illustrated by large swings in the SVC Susceptance.

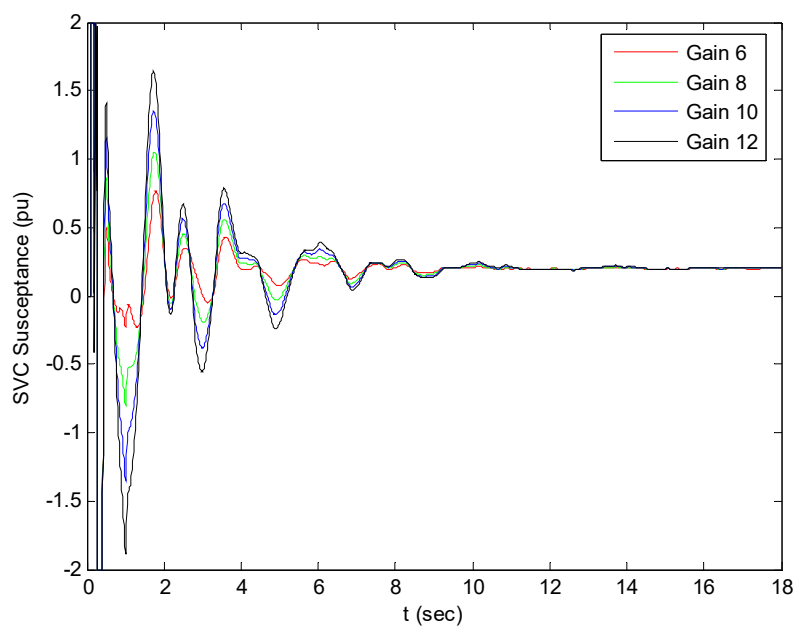

Figure 32 SVC Susceptance at Different Gains for 50 Gen System

In this section, we look at the effects of multiplying the inputs to the fuzzy system by various gain factor for the 50 machine system. The Table 7, 8 and 9 and Figs. 33, 34, 35 illustrate the simulations that were run in this section.

Table 8 50 Machine SVC Cases

Inputs	Bus				
Bus frequency	6				
Simulations	Gain Changes				
Voltage Fluctuation	4	6	8	10	12
Machine Angle	4	6	8	10	12

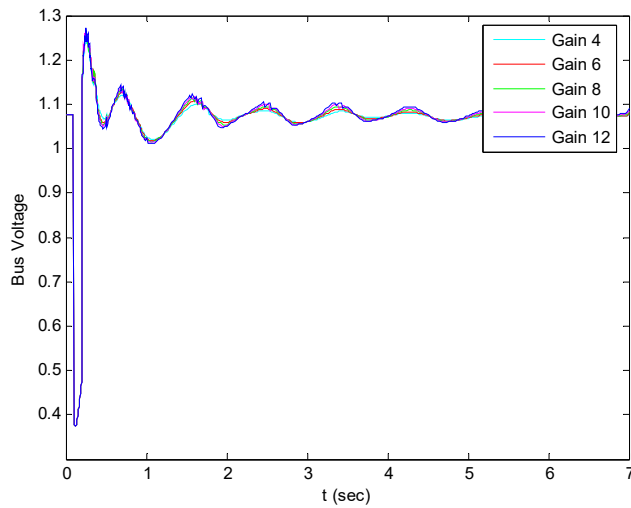

Figure 33 Bus Voltage at Different Gains for 50 Gen System

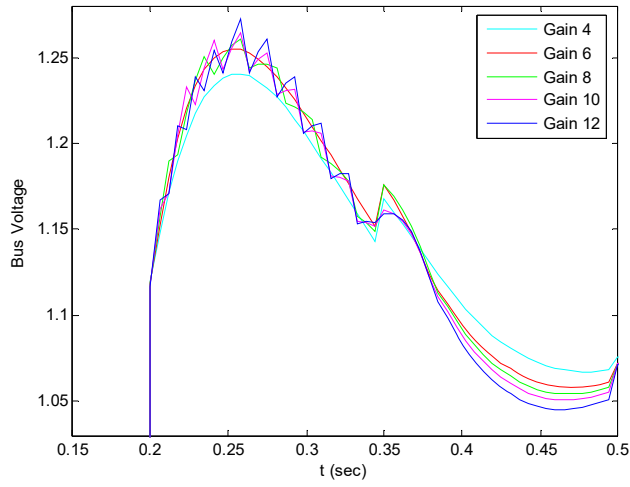

Figure 34 Voltage Fluctuation at Different Gains for 50 Gen System (Expanded View)

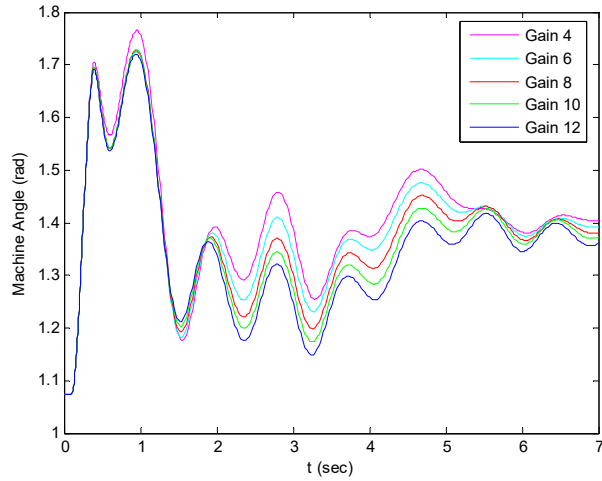

Figure 35 Machine Angle at Different Gains for 50 Gen System

From Figs. 33 and 34, it's again evident that bus voltages are sensitive to SVC gain change. In Fig. 35, we can comprehend that changing SVC gain also affects oscillation damping considerably. At higher gains, SVC controller damps electro-mechanical oscillations more effectively than lower gains. However, because increased gain causes problem in voltage magnitude response, a gain of 8 was chosen to balance the needs of voltage magnitude stability and oscillation damping. Also, machine and system constraints play key role in defining gain limit for SVC Controller, specially, where different power systems are inter-connected through long EHV tie-lines.

SVC Fault Cases:

The Tables 9 and 10 describes briefly the simulations that were run in this section.

Table 9 50 Machine SVC Cases

Controllers Tested			
Inputs	SVC Location Bus		PMU Location Buses
Machine Speed Gen 2	6		Machine 2
COI Speed Gen 2	6		All machines
Bus Frequency bus 6	6		6
COI Frequency Estimate 6	6		6,136,128,139,141,145
COI Voltage Angle Estimate bus 6	6		6,136,128,139,141,145
Voltage Angle bus 6	6		6
Simulations			
Fault Cases	Line cleared	Near end clear (sec)	Far end clear (sec)
Short Fault	6-7	0.1	0.15
Long Fault	6-7	0.25	0.30
Different Location	12-14	0.2	0.25

Table 10 50 Machine SVC Cases

Inputs	SVC Location Bus		PMU Location Buses
Bus Frequency bus 66	66		66
COI Frequency Estimate 66	66		6,136,128,139,141,145
Simulations			
Fault Cases	Line cleared	Near end clear (sec)	Far end clear (sec)
Long Fault	6-7	0.25	0.30
Different Location	12-14	0.2	0.25

5.2.1 Testing SVC at Bus 6 under Short Fault:

For Figs. 36-39, simulations were performed for a 0.1 sec fault duration at bus 6, with line 6 to 7 being cleared and damping performance for different inputs is compared with the SVC providing damping control. The Fig. 36 shows the behavior of different machines (1, 2, 3, 4, 5, 6, 23) having detailed models in simulation while using the Fuzzy based bus frequency SVC-PSS near Machine 2 at bus 6. We can observe that for shorter faults, the amplitude of oscillations remains trivial and oscillations do not last as long in the system compared to Figs. 40 and 44. The system approaches to new equilibrium point gradually.

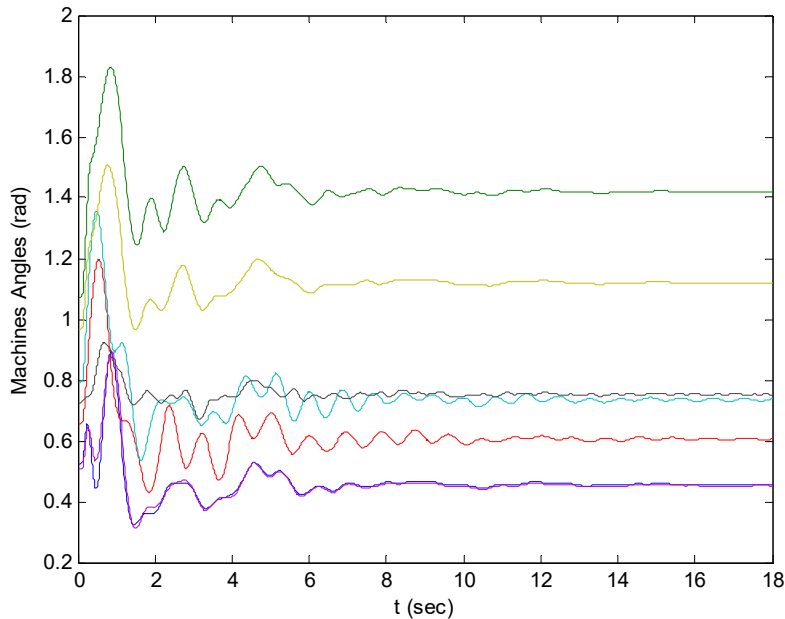

Figure 36 Short Fault Machine Angles with Fuzzy Bus Frequency SVC-PSS at Bus 6

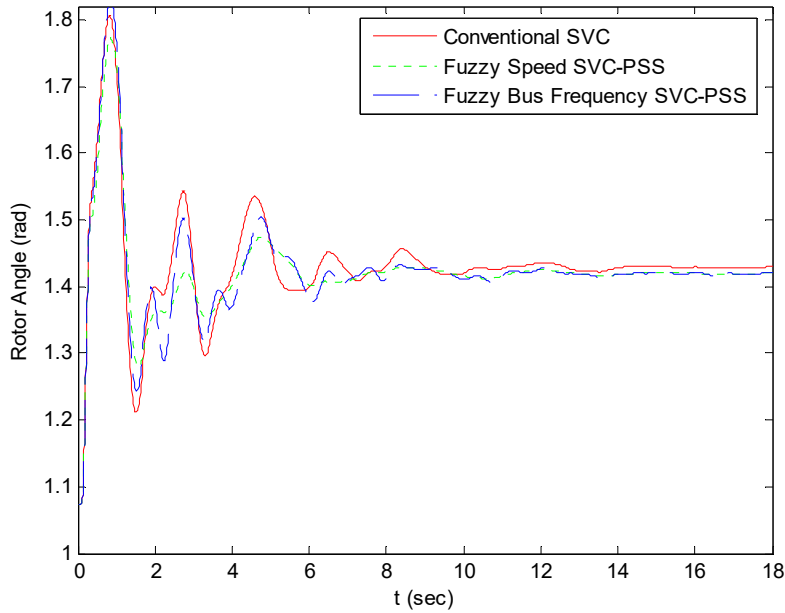

Figure 37 Short Fault Comparison of Conventional SVC to Fuzzy Speed and Bus Frequency SVC-PSS at Bus 6

In Fig. 37, a conventional static var compensator performance is compared with fuzzy logic based SVCs using speed of Machine 2 and bus frequency at Bus 6 as inputs. It is evident from the graph that fuzzy logic based SVC with speed input shows a well damped response and has smaller swing as compared to other responses. Both the fuzzy controllers show improved damping and slightly different final angle. This is not surprising since the conventional controller has no damping signal, but is only voltage (magnitude) controlled.

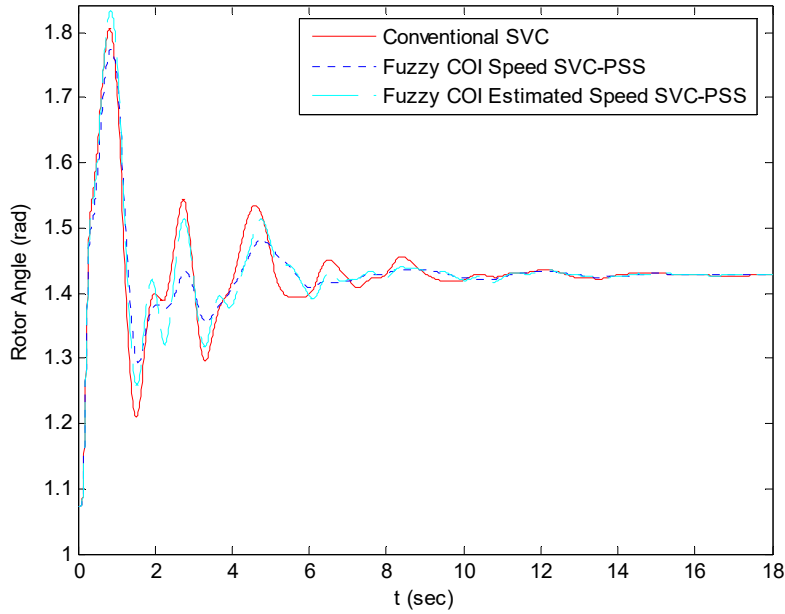

Figure 38 Short Fault Comparison of Conventional SVC to Fuzzy COI and Estimated COI Speed SVC-PSS at Bus 6

Fig. 38 shows a comparison of a conventional SVC with fuzzy logic based SVC using center of inertia speed of Machine 2 and estimated COI speed of Machine 2 inputs. The estimated COI speed of Machine 2 was calculated as it was in the PSS cases as shown below:

$$Estimated\ COI\ Frequency_6 = Frequency\ at\ bus\ 6 - \frac{\sum_{i=1-5} bus\ freq_i * H_i}{H_{total}}$$

Where i indicates buses where PMU's are located (see Table 5) and H_i is sum of the inertias of generator near PMU buses. This is done such that each of the 11 largest generators is associated with one PMU. H_{total} is the sum of the inertias of the group of 11 largest generators (8, 22, 24, 32, 36, 38, 42, 44, 46, 47, and 50) in the system.

The results in Fig. 38 show that the true COI speed based fuzzy logic SVC damps low frequency electromechanical oscillations considerably better than the conventional and estimated COI speed ones and has a lower first swing.

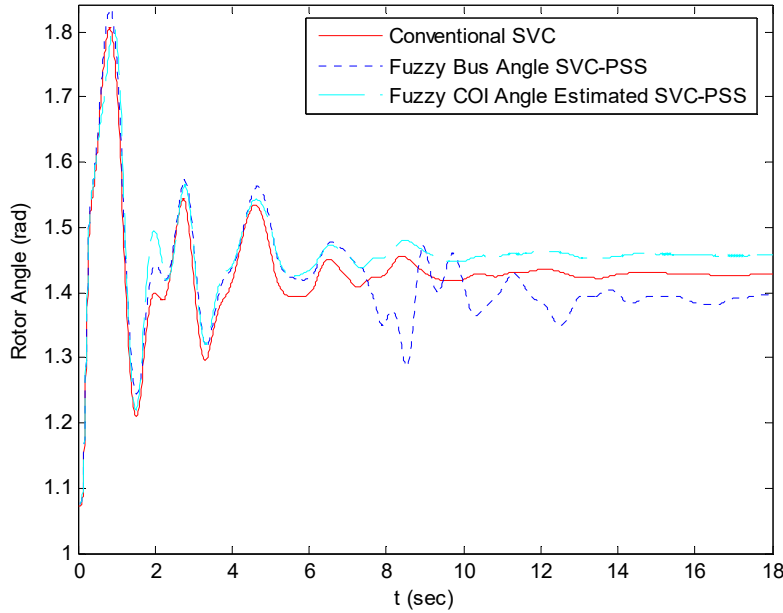

Figure 39 Short Fault Comparison of Conventional SVC to Fuzzy Bus Angle and COI Estimated Angle SVC-PSS at Bus 6

In Fig. 39, a conventional SVC is compared with fuzzy logic based SVC using bus voltage angle at Bus 6 and estimated bus voltage angle at Bus 6 as inputs. The estimated bus voltage angle was calculated as in the PSS cases using following equation:

$$\text{Estimated COI bus voltage angle}_6 = \text{voltage angle at bus 6} - \frac{\sum_{i=1-5} \text{angle}(\text{bus voltage})_i * H_i}{H_{total}}$$

Fig. 39 shows that Fuzzy SVCs with bus voltage angle input are not good to damp electromechanical oscillations while the conventional damped oscillations significantly better and settled down to an equilibrium point sooner than others.

5.2.2 Testing SVC at Bus 6 under Longer Fault:

For Figs. 40-43, simulations were performed for a 0.25 sec fault duration at bus 6, with line 6 to 7 being cleared. Since this fault is longer than previous duration, so the oscillations' amplitudes are larger and they last longer than previous case where we simulated for shorter fault duration as in Figs. 36 and 40. The Fig. 40 shows the behavior of the study area machines (1, 2, 3, 4, 5, 6, 23) having detailed models using the fuzzy based bus frequency SVC-PSS at bus 6.

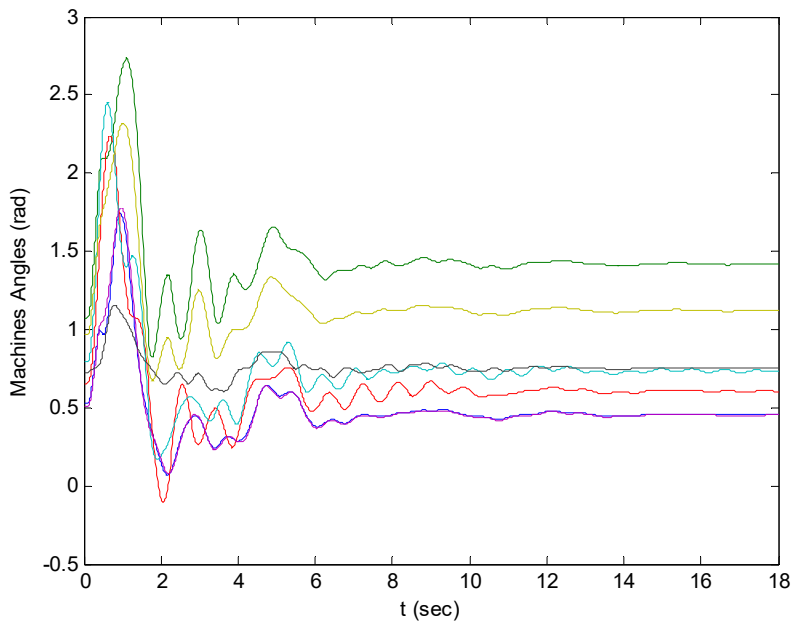

Figure 40 Longer Fault Machine Angles with Fuzzy Bus Frequency SVC-PSS at Bus 6

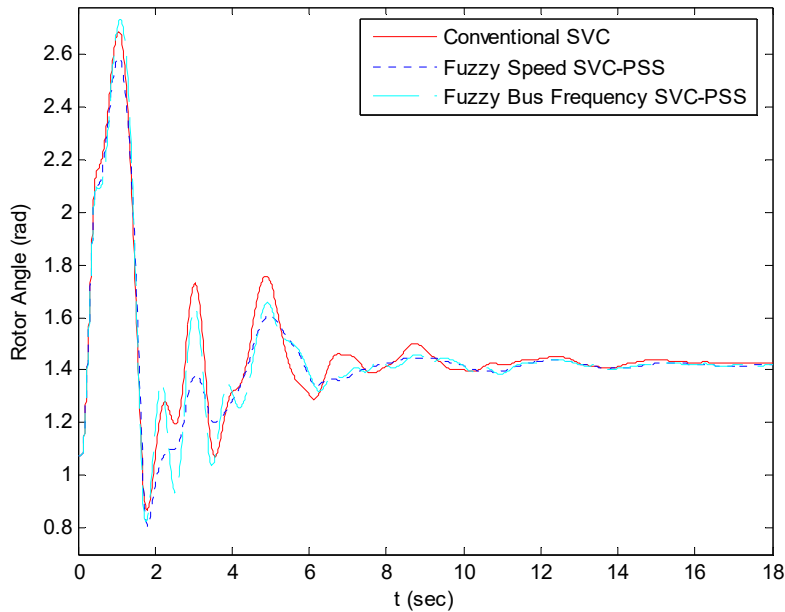

Figure 41 Longer Fault Comparison of Conventional SVC to Fuzzy Speed and Bus Frequency SVC-PSS at Bus 6

In Fig. 41 as in Fig. 37, a conventional SVC performance is compared with fuzzy logic based SVCs using speed of Generator 2 and bus frequency at Bus 6 as inputs. It is evident from the graph of this longer fault that FLPSS with speed input is again well damped and has smaller swing as compared to other responses. From results, it's clear that machine speed input to Fuzzy SVC damps low frequency oscillations better than bus frequency input.

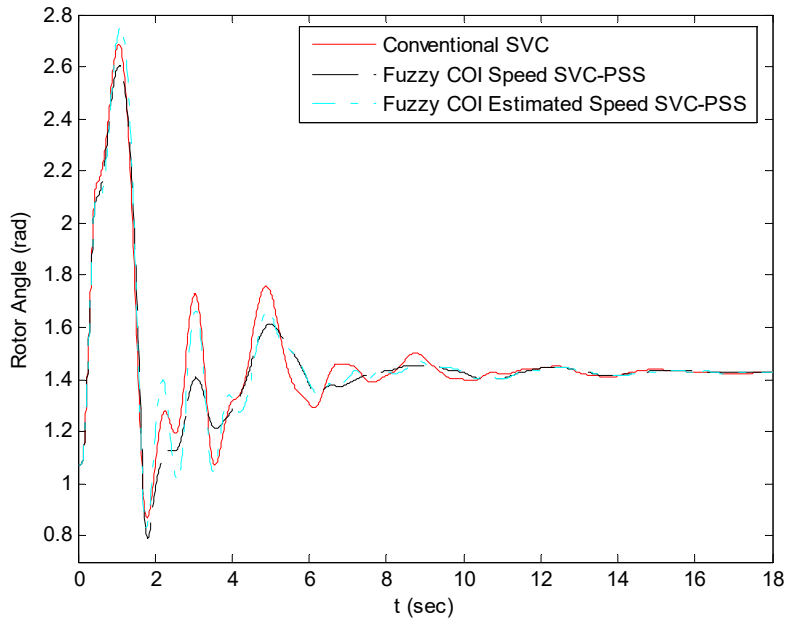

Figure 42 Longer Fault Comparison of Conventional SVC to Fuzzy COI and Estimated COI Speed SVC-PSS at Bus 6

Fig. 42 exhibits a comparison of conventional SVC with fuzzy logic based SVC using true center of inertia (COI) speed of Generator 2 and estimated COI speed of Generator 2 as inputs. These are the same controllers used in Fig. 38. The results demonstrate that COI speed based fuzzy logic SVC exceeded conventional and estimated COI speed based power system stabilizers in damping low frequency electromechanical oscillations. The estimated COI controller has a larger first swing than the conventional SVC but it is better damped.

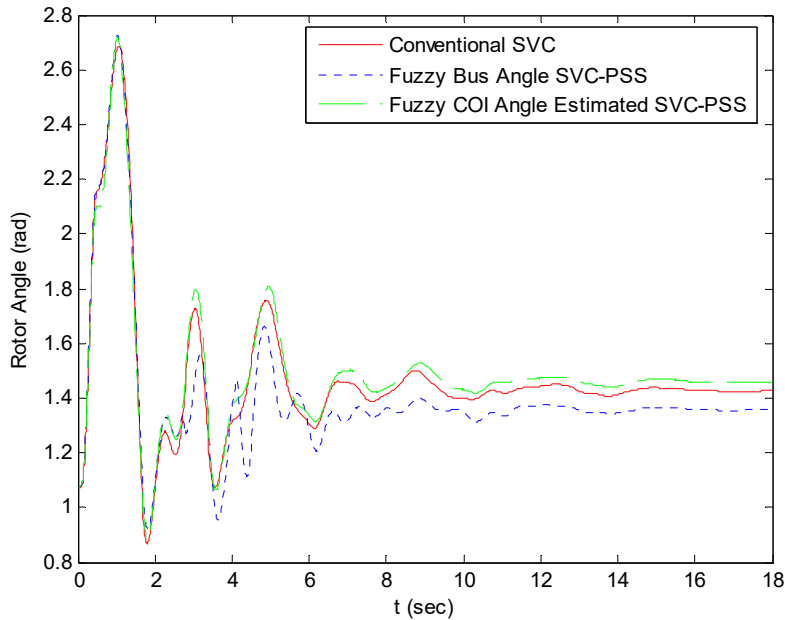

Figure 43 Longer Fault Comparison of Conventional SVC to Fuzzy Bus Angle and COI Estimated Angle SVC-PSS at Bus 6

In Fig. 43, a conventional SVC is compared with fuzzy based SVC using bus voltage angle at Bus 6 and estimated COI bus voltage angle at Bus 6 as inputs as was done in Fig. 39. Fig. 43 shows again that the Fuzzy SVC with bus voltage angle input is not good at damping electromechanical oscillations because conventional one performed better and damped oscillations more significantly. As far as COI estimated angle is concerned, it performed better than bus angle but has larger swings compared to conventional one.

5.2.3 Testing SVC at Bus 6 under a Fault at a Different Location:

For Figs. 44-48, the fault was placed on transmission line which is away from the SVC. The fault was placed on bus 12, and line 12 to 14 was cleared. Simulations were performed for 0.2 sec fault duration, and damping performances for different inputs are compared. Fig. 44 depicts the behavior of different machines (1, 2, 3, 4, 5, 6, 23) having detailed models in simulation using the fuzzy based bus frequency SVC-PSS at bus 6. From the graph, it's clear that since the fault is away from the SVC, we see different frequencies and amplitudes in the generator responses as compared to Figs. 36 and 40.

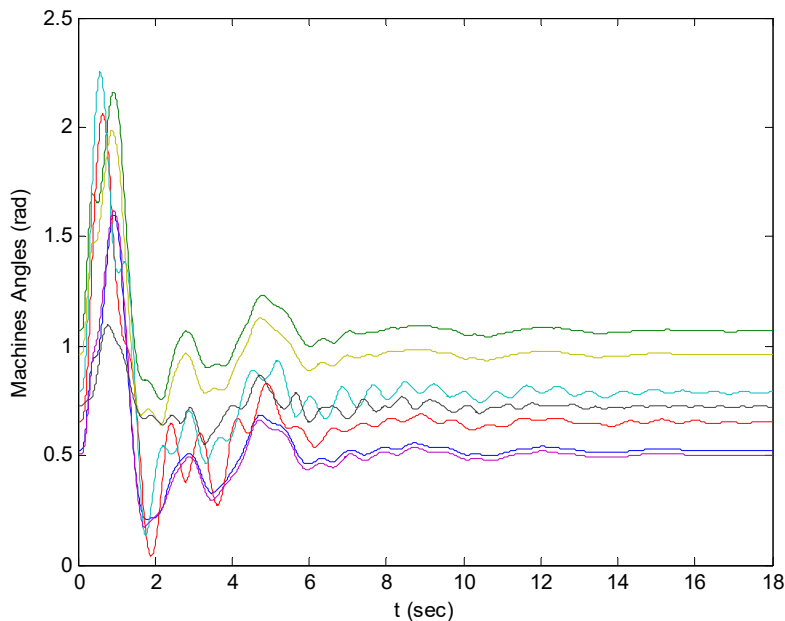

Figure 44 Different Location Fault Machine Angles with Fuzzy Bus Frequency SVC-PSS at Bus 6

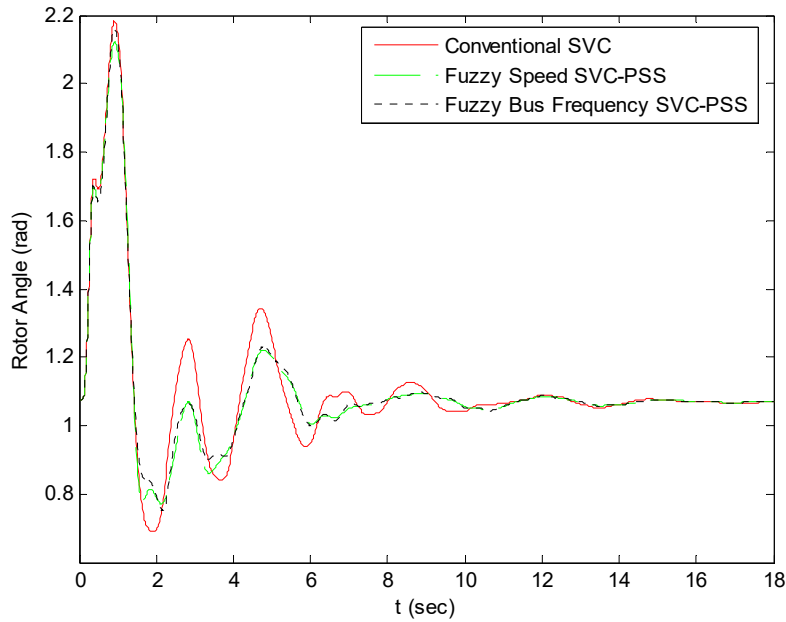

Figure 45 Different Location Fault Comparison of Conventional SVC to Fuzzy Speed and Bus Frequency SVC-PSS at Bus 6

Fig. 45 shows a comparison of a conventional SVC performance with fuzzy logic based SVCs using speed of Machine 2 and bus frequency at Bus 6 as inputs. These are the same controllers seen in Fig. 37 and 41. The graph manifests that fuzzy logic SVC with speed input has a slightly lower first swing although the bus frequency SVC may be slightly better damped. The difference between the fuzzy controllers is much smaller than what was seen in Figs. 37 and 41.

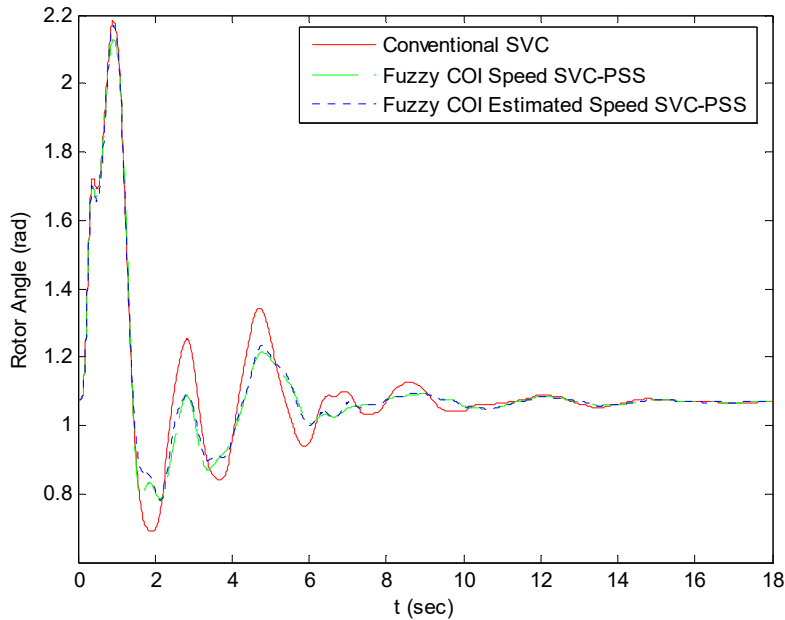

Figure 46 Different Location Fault Comparison of Conventional SVC to Fuzzy COI and Estimated COI Speed SVC-PSS at Bus 6

Fig. 46 exhibits a comparison of conventional SVC with fuzzy logic based SVCs using true center of inertia (COI) speed of Generator 2 and estimated COI speed of Generator 2 as inputs. We can compare this to the cases for the same controllers seen in Figs. 38 and 42. The results in Fig. 40 demonstrate that COI speed based fuzzy logic SVC exceeded conventional and estimated COI speed based static var compensator (SVC) in lowering the first swing, while COI estimate speed is slightly better damped. Again for this more distant fault, the difference between actual and estimated COI controllers is reduced.

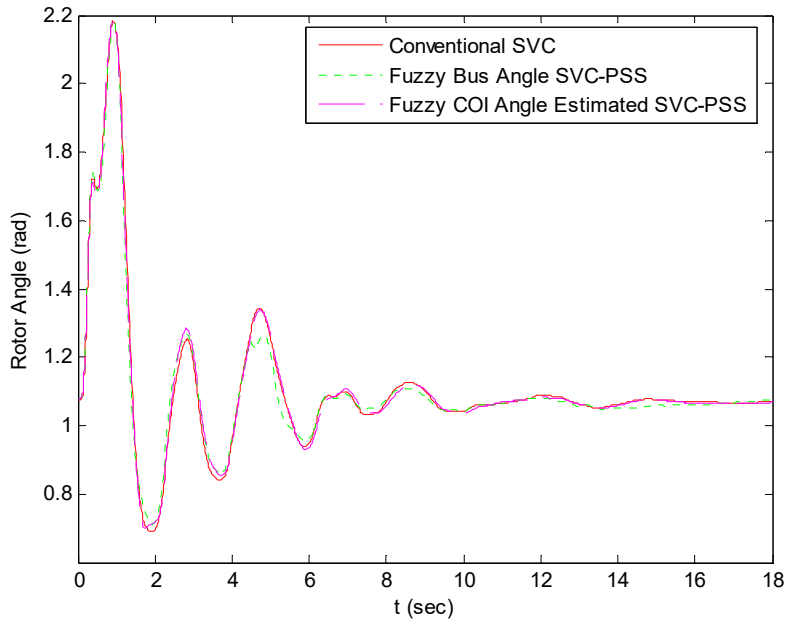

Figure 47 Different Location Fault Comparison of Conventional SVC to Fuzzy Bus Angle and COI Estimated Angle SVC-PSS at Bus 6

In Fig. 47 as in Figs. 39 and 43, a conventional SVC is compared with fuzzy logic based SVC using global (estimated COI) and local bus voltage angles at Bus 6 as inputs. The results indicated that fuzzy SVC with bus voltage angle input is better at damping electromechanical oscillations while conventional and estimated ones have larger amplitude. It shows that estimated COI voltage angle (which actually monitors the whole system) input, for damping oscillations and stabilizing system, is not a better choice here.

5.2.4 Testing SVC at Bus 66 under Longer Fault:

The Fig. 48 shows the behavior of machines (1, 2, 3, 4, 5, 6, and 23) having detailed models using the fuzzy based bus frequency SVC-PSS on bus 66. The fault of 0.25 sec was applied at Bus 6 and line 6 to 7 was cleared. In this case, we put SVC on bus a little farther away from Generator 2(as compared to the SVC at Bus 6 case). Comparing their responses to that of Fig. 40, we see a slightly better system response.

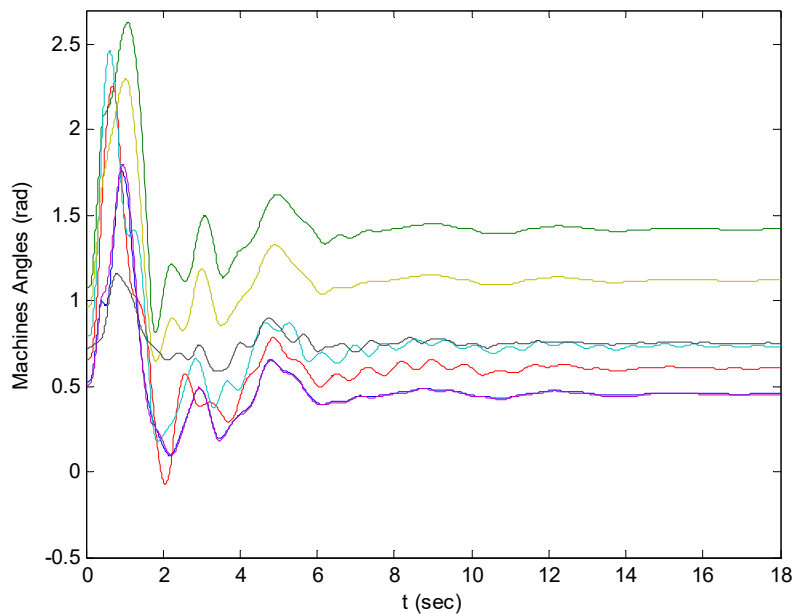

Figure 48 Longer Fault Machine Angles with Fuzzy Bus Frequency SVC-PSS at Bus 66

Fig. 49 exhibits a comparison of conventional SVC with fuzzy logic based SVC using bus frequency at Bus 66 and estimated COI speed of Generator 2 as inputs. It is evident from the graph that fuzzy logic SVC with bus frequency input is well damped and has smaller swing as compared to other responses, although COI estimate controller does well too even if the fault persists for a longer time.

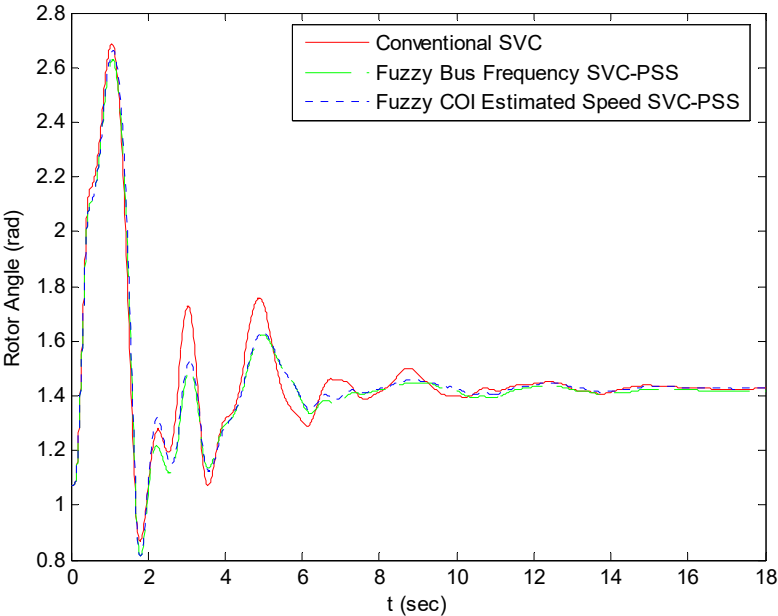

Figure 49 Longer Fault Comparison of Conventional SVC to Fuzzy Bus Frequency and Estimated COI Speed SVC-PSS at Bus 66

5.2.5 Testing SVC at Bus 66 under Fault at Different Location:

Fig. 50 depicts the behavior of machines (1, 2, 3, 4, 5, 6, 23) having detailed models in simulation using fuzzy based bus frequency SVC-PSS on bus 66. This time a fault of 0.2 sec was applied at bus 12 and line 12 to 14 was cleared. From Fig.50, it is clear that since fault is away from the SVC, the controller is not as efficient at damping low frequency oscillation compare to Fig. 44 where we have SVC placed at bus 6.

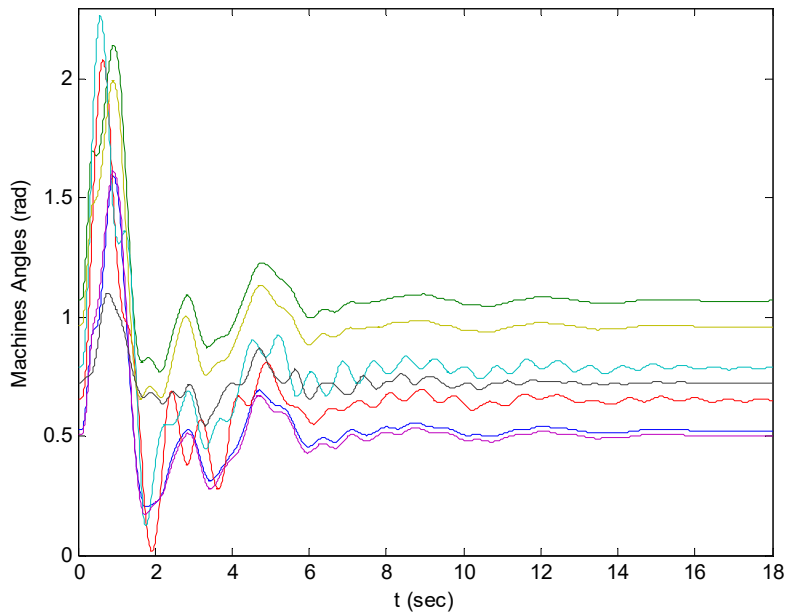

Figure 50 Different Fault Location Machine Angles with Fuzzy Bus Frequency SVC-PSS at Bus 66

Fig. 50 shows a comparison of the conventional SVC performance with fuzzy logic based SVCs using bus frequency at Bus 66 and estimated COI of Machine 2 as inputs.

$$\text{Estimated COI Frequency}_{66} = \text{Frequency at bus 66} - \frac{\sum_{i=1-5} \text{bus freq}_i * H_i}{H_{total}}$$

The above graph shows that fuzzy logic SVC with bus frequency input damps electromechanical oscillations better and approached steady state sooner than other SVCs while estimated COI one performed very similar to the bus frequency based SVC.

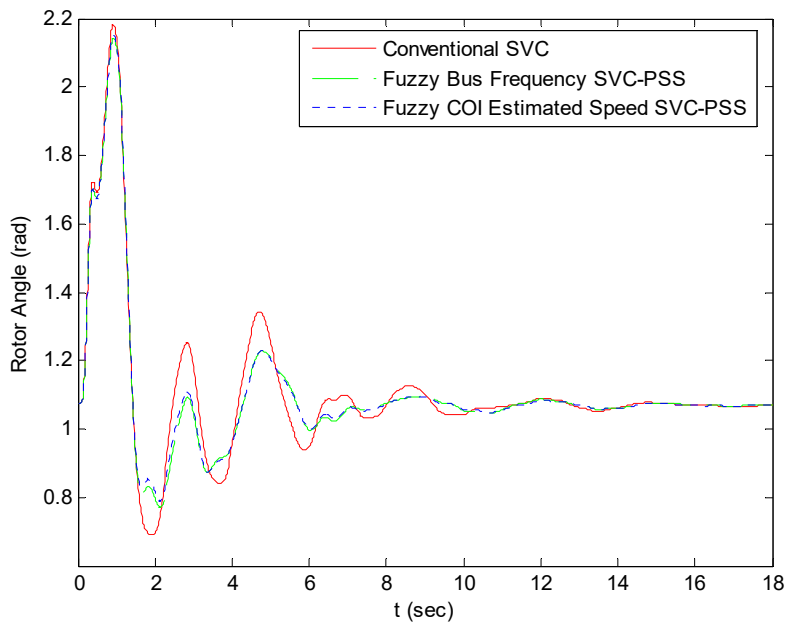

Figure 51 Different Location Fault Comparison of Conventional SVC to Fuzzy Bus Frequency and Estimated COI Speed SVC-PSS at Bus 66

5.2.6 Summary of 50 Gen SVC Cases:

To analyze damping performance of SVC fuzzy logic controller using different inputs, it was placed at 2 different locations (2 buses), one at a time, in the system for 3 different fault cases. From various simulation results, it was observed that SVC FLC with PMU-based inputs such as bus frequency (local) and estimated COI (global for WAMS) performed better at damping low frequency oscillations. Furthermore, bus voltage angle (local measurement) and estimated voltage angle (global measurement), in most of the cases, performed poor at damping electromechanical oscillations. . The Table 11 and 12 show the different trend of results that we obtained from simulations for SVC at Bus 6 and Bus 66 respectively.

Table 11 50 Generator SVC Cases Summary

Controller	Short fault		Longer fault		Diff. location fault	
	1st Swing (rad)	damping	1st Swing (rad)	damping	1st Swing (rad)	damping
Conventional	1.81	Worst	2.69	Worst	2.20	Worst
Machine speed	1.76	Best	2.58	Best	2.12	Best
Bus frequency	1.82	Medium	2.72	Medium	2.17	Medium
True COI	1.76	Best	2.6	Best	2.13	Best
COI Frequency Estimate	1.83	Medium	2.72	Medium	2.18	Medium
COI Voltage angle estimate	1.81	Medium	2.7	Medium	2.20	Medium
Voltage angle	1.84	Worst	2.68	Worst	2.19	Best

Table 12 50 Generator SVC Cases Summary

Controller	Longer fault		Diff. location fault	
	1st Swing (rad)	damping	1st Swing (rad)	damping
Conventional	2.68	Worst	2.19	Worst
Bus frequency	2.61	Best	2.15	Best
COI Frequency Estimate	2.65	Medium	2.17	Medium

6. Conclusion

6.1 Power System Stabilizer:

FLPSS with machine speed as input performed best in most of the cases considered. The PMU-based inputs, bus frequencies and COI estimates, performed similarly to the speed-based measurements. The COI estimates tended to have high frequency oscillations. Better results are seen with bus frequency inputs closer to the generator being controlled especially in the 50 machine system where we simulated short, long and different location faults. Bus frequency FLC tends to have a first large swing but shows better damping response overall.

When considering changes in system parameters, the FLPSS with speed input continued to out-perform the CPSS. The PSSs with bus frequency based input signals also showed robustness to changes in generator inertia and power generation balance changes.

While considering true COI input based FLC, the damping performance was significantly better than any other controller in case of all faults simulated for analysis. Furthermore, bus voltage angle and estimated COI voltage angle showed varying damping performance under different fault conditions.

The CPSS did not show higher frequency oscillations as seen in some of the FLPSS responses. CPSS response is frequency dependent based on its transfer function. Many FLPSS designs presented in the literature use both speed and acceleration (or power) signals to gain frequency dependence. In this work simple, single-input fuzzy systems were used, which may explain the presence of the higher frequencies even in the speed input case.

6.2 Static Var Compensator:

In this study, an SVC was placed at different locations in 2 systems to analyze damping performance using different inputs such as bus frequency, machine speed, estimated COI and bus voltage angle. The results were compared with conventional SVC in terms of damping angular oscillations. Fuzzy logic based SVC performed significantly better in damping low frequency electromechanical oscillations along with reactive power compensation in the system during fault.

Fuzzy based SVC, with machine speed as an input, damped oscillations effectively as shown from the simulation results. However, it's very difficult to measure machine speeds accurately in large interconnected power systems where all machines are synchronized with each other. The SVC controller with true COI input performed very well at damping low frequency oscillations and showed low amplitude of oscillations in the system.

Recent advancements in synchrophasor technology played key role is WAMS and made many system variables readily available for efficient analysis. Using PMUs, we can easily obtain bus frequency at any particular bus at any given time locally. In our study, the bus frequency based SVC damped oscillations, for each of the fault simulated, significantly though first swing was high in most of the cases, but overall it performed better.

Similarly, we used bus frequency based estimated COI as a global input to a fuzzy SVC to damp oscillations. The estimated COI can easily be obtained (though many PMUs may be needed), through PMUs in wide area monitoring system (WAMS), globally. The estimated COI based SVC showed better damping when compared with conventional SVC for various faults and durations. Like the bus frequency based SVC controller, it has high amplitude of first fault swing.

Furthermore, bus voltage angles were used as an input to a Fuzzy SVC. Bus angles can also be acquired through PMUs [47]. The simulation results showed degraded performance of bus voltage angle based SVC as compared to the conventional one and high amplitude oscillation.

Overall, bus frequency should be considered as good input to SVC as it can easily be acquired through PMUs, without any complexity and involvement of system variables matrices, in modern power systems where all required information is readily available. Additionally, both local and global low frequency oscillations can be damped using bus frequency and estimated COI (based primarily on bus frequency as well) as an input to SVC.

7. Future Work

Throughout this research work, the single input is used for FLC's for carrying out different simulation results. However, multiple inputs (combination of any two) can be used for the same controllers to analyze their damping performance. Furthermore, testing of these controllers can be carried out in more complex network models. We tested damping performance of SVC controllers at 2 different locations in the 50 machine system, but it can be verified at other locations in the system to assure the robustness of the FLCs. As far as COI based inputs to the controller are concerned, they can be utilized in wide area monitoring system (WAMS) to help damping low frequency electromechanically oscillations. More study of the COI's usefulness could be done.

8. Bibliography

- [1] Dobrescu, M. and I. Kamwa (2004). "A new fuzzy logic power system stabilizer performances." Power Systems Conference and Exposition, 2004. IEEE PES, IEEE.
- [2] Yan, J., et al. (2011). "PMU-based monitoring of rotor angle dynamics." Power Systems, IEEE Transactions on **26**(4): 2125-2133.
- [3] Chompoobutrcool, Y. and L. Vanfretti (2012). A fundamental study on damping control design using PMU signals from dominant inter-area oscillation paths. North American Power Symposium (NAPS), 2012, IEEE.
- [4] Erlich, I., et al. (2011). "Selective damping of inter area oscillations using phasor measurement unit (PMU) signals." PowerTech, 2011 IEEE Trondheim, IEEE.
- [5] Monchusi, B., et al. (2008). "Power system stability assessment based on synchronized phasor measurements." Power and Energy Conference, 2008. PECon 2008. IEEE 2nd International, IEEE.
- [6] Dobrescu, I. K. M., et al. (2011). "A Fundamental Study of Wide-Area Damping Controllers with Application to Fuzzy-Logic Based PSS Design for Dynamic Shunt Compensators."
- [7] Fouad, A. A., V. Vittal (1992). Power System Transient Stability Analysis Using the Transient Energy Function Method. New Jersey: Prentice-Hall.
- [8] Patel, H. D. and C. Majmudar (2011). "Fuzzy logic application to single machine power system stabilizer." Engineering (NUiCONE), 2011 Nirma University International Conference on, IEEE.
- [9] Dasgupta, S., et al. (2013). "Real-time monitoring of short-term voltage stability using PMU data." Power Systems, IEEE Transactions on **28**(4): 3702-3711.

- [10] Momoh, J. A., et al. (2008). "Voltage stability enhancement using Phasor Measurement Unit (PMU) technology." Power Symposium, 2008. NAPS'08. 40th North American, IEEE.
- [11] Cvetkovic, M. and M. Ilic (2011). "PMU based transient stabilization using FACTS." Power Systems Conference and Exposition (PSCE), 2011 IEEE/PES, IEEE.
- [12] Dotta, D. and I. Decker (2007). "Power system small-signal angular stability enhancement using synchronized phasor measurements." Power Engineering Society General Meeting, 2007. IEEE, IEEE.
- [13] You, R., et al. (2003). "An online adaptive neuro-fuzzy power system stabilizer for multimachine systems." Power Systems, IEEE Transactions on **18**(1): 128-135.
- [14] Mokhtari, M., et al. (2013). "Wide-area power oscillation damping with a fuzzy controller compensating the continuous communication delays." Power Systems, IEEE Transactions on **28**(2): 1997-2005
- [15] Mrad, F., et al. (2000). "An adaptive fuzzy-synchronous machine stabilizer." Systems, Man, and Cybernetics, Part C: Applications and Reviews, IEEE Transactions on **30**(1): 131-137.
- [16] Feilat, E., et al. (2006). "Adaptive neuro-fuzzy technique for tuning power system stabilizer." Universities Power Engineering Conference, 2006. UPEC'06. Proceedings of the 41st International, IEEE.
- [17] Ramirez-Gonzalez, M. and O. Malik (2008). "Power system stabilizer design using an online adaptive neurofuzzy controller with adaptive input link weights." Energy Conversion, IEEE Transactions on **23**(3): 914-922.

- [18] Fraile-Ardanuy, J. and P. J. Zufiria (2005). "Adaptive power system stabilizer using ANFIS and genetic algorithms." Decision and Control, 2005 and 2005 European Control Conference. CDC-ECC'05. 44th IEEE Conference on, IEEE.
- [19] Gholipour, A., et al. (2009). "Performance of a ANFIS based PSS with tie line active power deviation feedback." Power Electronics and Intelligent Transportation System (PEITS), 2009 2nd International Conference on, IEEE
- [20] Toliyat, H. A., et al. (1996). "Design of augmented fuzzy logic power system stabilizers to enhance power systems stability." Energy Conversion, IEEE Transactions on **11**(1): 97-103.
- [21] Tecec, Z., et al. (2010). "A takagi-sugeno fuzzy model of synchronous generator unit for power system stability application." Automatica Vol **51**: 127-137
- [22] Hassan, L. H., et al. (2010). "Takagi-sugeno fuzzy gains scheduled pi controller for enhancement of power system stability." American Journal of Applied Sciences **7**(1): 145.
- [23] Power System Toolbox ver 3.0 Cherry Tree scientific software,1991-2008
- [24] Kundur, Prahba (1994). Power System Stability and Control. New York: McGraw-Hill, Inc

- [25] Demello, Francisco, and Charles Concordia.(1969). "Concepts of Synchronous Machine Stability as Affected by Excitation Control." IEEE Transactions on Power Apparatus and Systems: 316-29.
- [26] Kundur, P., M. Klein, G.J. Rogers, and M.S. Zywno.(1989). "Application of Power System Stabilizers for Enhancement of Overall System Stability." IEEE Transactions on Power Systems: 614-26.
- [27] Chow, J.H., and J.J. Sanchez-Gasca.(1989). "Pole-placement Designs of Power System Stabilizers." IEEE Transactions on Power Systems: 271-77.
- [28] Hiyama, T.(1990). "Rule-based Stabilizer for Multi-machine Power System." IEEE Transactions on Power Systems: 403-11.
- [29] Hariri, A., and O.P. Malik.(1996). "A Fuzzy Logic Based Power System Stabilizer with Learning Ability." IEEE Transactions on Energy Conversion: 721-27.
- [30] Chen, G.P., O.P. Malik, G.S. Hope, Y.H. Qin, and G.Y. Xu.(1993). "An Adaptive Power System Stabilizer Based on the Self-optimizing Pole Shifting Control Strategy." IEEE Transactions on Energy Conversion: 639-45.
- [31] Shamsollahi, P., and O.P. Malik.(1997). "An Adaptive Power System Stabilizer Using On-line Trained Neural Networks." IEEE Transactions on Energy Conversion: 382-87.
- [32] Wen, Jinyu, Shijie Cheng, and O.P. Malik.(1998). "A Synchronous Generator Fuzzy Excitation Controller Optimally Designed with a Genetic Algorithm." IEEE Transactions on Power Systems: 884-89.
- [33] Abido, M.A., and Y.I. Abdel-Magid.(1999). "Hybridizing Rule-based Power System Stabilizers with Genetic Algorithms." IEEE Transactions on Power Systems: 600-07.

- [34] Abdel-Magid, Y.I., M.A. Abido, S. Al-Baiyat, and A.h. Mantawy.(1999). "Simultaneous Stabilization of Multimachine Power Systems via Genetic Algorithms." IEEE Transactions on Power Systems: 1428-439.
- [35] Abdel-Magid, Y.I., M.A. Abido, S. Al-Baiyat, and A.h. Mantawy.(1999). "Simultaneous Stabilization of Multimachine Power Systems via Genetic Algorithms." IEEE Transactions on Power Systems: 1428-439.
- [36] Lu, J., M.H. Nehrir, and D.A. Pierre. "A Fuzzy Logic-based Adaptive Power System Stabilizer for Multi-machine Systems." 2000 Power Engineering Society Summer Meeting (Cat. No.00CH37134).
- [37] Lu, J., M.H. Nehrir, and D.A. Pierre.(2003). "A Fuzzy Logic-based Adaptive Damping Controller for Static VAR Compensator." Electric Power Systems Research: 113-18.
- [38] Larsen, E.V., J.J. Sanchez-Gasca, and J.H. Chow.(1995). "Concepts for Design of FACTS Controllers to Damp Power Swings." IEEE Transactions on Power Systems: 948-56.
- [39] Leirbukt, A.B., J.H. Chow, J.J. Sanchez-Gasca, and E.V. Larsen.(1999). "Damping Control Design Based on Time-domain Identified Models." IEEE Transactions on Power Systems: 172-78.
- [40] Noroozian, M., M. Ghandhari, G. Andersson, J. Gronquist, and I. Hiskens.(2001). "A Robust Control Strategy for Shunt and Series Reactive Compensators to Damp Electromechanical Oscillations." IEEE Transactions on Power: 812-17.
- [41] Ghandhari, M., G. Andersson, and I.A. Hiskens.(2001). "Control Lyapunov Functions for Controllable Series Devices." IEEE Transactions on Power Systems: 689-94.
- [42] Zhou, E.-Z.(1993). "Application of Static VAR Compensators to Increase Power System Damping." IEEE Transactions on Power Systems: 655-61.

- [43] Smith, J.R., D.A. Pierre, I. Sadighi, and M.H. Nehrir.(1989). "A Supplementary Adaptive VAR Unit Controller for Power System Damping." IEEE Transactions on Power Systems: 1017-023.
- [44] Mok, T.K., Y. Ni, and F.F. Wu. "Design of Fuzzy Damping Controller of UPFC through Genetic Algorithm." 2000 Power Engineering Society Summer Meeting (Cat. No.00CH37134).
- [45] Lerch, E.N., D. Povh, and L. Xu.(1991). "Advanced SVC Control for Damping Power System Oscillations." IEEE Transactions on Power Systems: 524-35.
- [46] Hsu, C.-S., M.-S. Chen, and W.-J. Lee.(1998). "Approach for Bus Frequency Estimating in Power System Simulations." IEE Proceedings - Generation, Transmission and Distribution: 431.
- [47] Varma, Rajiv K, R. P. Gupta, and Soubhik Auddy. "Damping of Inter-Area Oscillation in Power Systems by Static Var Compensator (SVC) Using PMU-Acquired Remote Bus Voltage Angles." International Journal of Emerging Electric Power Systems, 2007.
- [48] Dash, P.K., and S. Mishra. (2003). "Damping of Multimodal Power System Oscillations by FACTS Devices Using Non-linear Takagi-Sugeno Fuzzy Controller." International Journal of Electrical Power & Energy Systems: 481-90.
- [49] Hiyama, T., W. Hubbi, and T.H. Ortmeyer. (1999). "Fuzzy Logic Control Scheme with Variable Gain for Static Var Compensator to Enhance Power System Stability." IEEE Transactions on Power Systems: 186-91.

