

K3
K3
c.1
23/8

Kansas 4-H Journal

RECEIVED

August, 1977

AUG 04 1977

THE LIBRARY
KANSAS STATE UNIVERSITY





These are the sponsors who provide your Kansas 4-H Journal.

Be sure to thank them!

EDWARDS

Edwards County 4-H Council, Kinsley

FINNEY

* The Fidelity State Bank, Garden City
Finney County 4-H Council, Garden City

GRAHAM

* Farmers and Merchants Bank, Hill City

GRAY

* Farmers State Bank, Ingalls
* First National Bank in Cimarron, Cimarron
* Montezuma State Bank, Montezuma

HARVEY

* Kansas State Bank, Newton
* First National Bank, Newton
* Hesston State Bank, Hesston
* Midland National Bank, Newton
* Sedgwick State Bank, Sedgwick
* State Bank of Burrton, Burrton
* The Halstead Bank, Halstead
* Walton State Bank, Walton
Harvey County 4-H Council, Newton

HASKELL

* The Haskell County State Bank, Sublette

JEFFERSON

Valley Implement Co., Inc., Valley Falls
Leavenworth-Jefferson Electric Cooperative, McLouth
Jefferson County Homemaker Unit Council, Oskaloosa

LEAVENWORTH

First National Bank, Leavenworth

LINCOLN

* Sylvan State Bank, Sylvan Grove
Lincoln County 4-H Council, Lincoln

MORTON

Coffee Insurance & Real Estate, Elkhart

PRATT

Cairo Co-op Equity Exchange, Cairo-Cunningham
Iuka Co-op Exchange, Iuka
Pratt Equit Exchange, Pratt
Preston Co-op Grain & Mercantile Co., Preston
Sawyer Co-op Equity Exchange, Sawyer
Cullison Co-op, Pratt
Pratt County 4-H Council, Pratt

RENO

Buhler State Bank, Buhler
Central State Bank, Hutchinson
Citizens State Bank, Arlington
State Bank of Kansas, S. Hutchinson
Farmers State Bank, Yoder
First National Bank, Hutchinson
Haven State Bank, Haven
Hutchinson National Bank & Trust Co., Hutchinson
Nickerson State Bank, Nickerson
Northgate National Bank, Hutchinson
State Bank of Plevna, Plevna
State Bank of Pretty Prairie, Pretty Prairie
Sylvia State Bank, Sylvia
Turon State Bank, Turon

RICE

Central Kansas Elevator, Lyons
The Chandler National Bank, Lyons
Bushton Grain & Supply, Chase
Rice County State Bank, Chase
Farmers Co-op of Alden, Lyons, Sterling, & Pollard, Sterling
First National Bank, Sterling
Farmers State Bank, Sterling
Home State Bank, Little River

RILEY

Hill Investment & Construction Co., Inc. Manhattan

SEWARD

* First National Bank, Liberal
* Peoples National Bank, Liberal
* Citizens State Bank, Liberal

*These sponsors have provided Kansas 4-H Journal for 4-H members for 20 or more years.

4-H club works for health

By Gary McClung
Sherman County

Warren Star Busy Bees 4-H Club, Sherman County, was named top club for health in Kansas for 1976. Ten members and two leaders attended the Kansas 4-H Congress in recognition of this accomplishment.

This small club (21 members) conducted various projects throughout 1976. The elderly in the community were remembered on birthdays, Christmas, Easter, and other special occasions. The club also provided bicentennial flags for the hospital and both rest homes during July.

Educating people about the dangers of drugs was another project — conducted by distributing drug pamphlets, giving a drug talk at county and regional level (plus radio and TV), and constructing a fair booth on drugs. Club members participated in various fund drives for health needs in Sherman County — collecting for arthritis, cancer, and for the Kidney Foundation in Denver (for which they received a special award), plus selling poppies for disabled veterans.

Various health-needs projects were conducted by club members during the year — a rabies clinic was held in conjunction with the veterinarian in Goodland, a first aid survey was conducted in the farm community northwest of Goodland, first aid handbooks were distributed to all such families surveyed as well as all 4-H families in the club, a travelers' "take a break — stop for a free drink" project was held at a local service station during a holiday weekend, and free drinks were provided for comfort of Tri-State Royal participants and viewers in August.

Members who represented Warren Star Busy Bees in Wichita in January were Merilan Anderson, Traci Price, Karen Gattshall, Ruth Gattshall, Lisa Wickwar, Leland Gattshall, Alan Roeder, Gary McClung, John Gattshall and Pat Tagtmeyer.

Leaders of WSBB for 1976 were Zona Price and Dick Allaman, with David Gattshall and Beverly Anderson as assistant leaders.



Seed of
Known
Superior
Heredity
and Quality

The Kansas Crop Improvement Assn.

205 CALL HALL Manhattan, Kansas (913) 532-6118

Vol. XXIII, No. 8 August 1977

4-H Around the State 5
 An interview with John Carlin 6
 Good eating habits strengthen
 Your rope of life8, 9
 Ideas and news10, 14
 A Kansas Cowboy11
 Japanese students visit in Kansas ...14
 Family fun Page15

Glenna WilsonEditor
 Debbie DoebeleSecretary

Address all correspondence:
 Kansas 4-H Journal
 Umberger Hall, KSU
 Manhattan, Kansas 66506

Phone 913-532-5881

Kansas 4-H Journal is published monthly by

KANSAS 4-H FOUNDATION, INC.

Merle Evestone Executive Director
 Les HarrodActing Associate Director
 J. Harold JohnsonField Representative
 Trisha CashSecretary
 Ann WalkerTreasurer

BOARD OF TRUSTEES

Governor Robert Bennett
 Honorary Chairman

Balfour S. Jeffrey, Chrm.Topeka
 Ross Beach, Vice-Chrm.Hays
 Mrs. Charles Streeter, Treas.Manhattan
 Glenn M. BussetManhattan
 W. Dale CritserWichita
 Richard DillonHutchinson
 John O. DunbarManhattan
 Ned FlemingTopeka
 Mrs. Olivia GarveyWichita
 William M. McDonaldKansas City, Mo.
 John D. MontgomeryJunction City
 George B. PowersWichita
 Dolph Simons, Sr.Lawrence
 Mrs. Dwane WallaceWichita
 *Sen. Frank CarlsonConcordia
 *Harry DarbyKansas City
 *Harold E. JonesManhattan
 *J. J. MoxleyCouncil Grove
 *Roger E. RegnierManhattan
 *E. B. ShawverWichita
 *John T. StewartWellington
 *Advisory Member

Second Class Postage Paid at Manhattan, Kansas and additional mailing offices. Return Form 3579 to Kansas 4-H Journal, Publication Number 291240 Manhattan, Kansas 66506.

Advertising rates and circulation data on request.

Group subscriptions \$2.00 per year. Individual subscription \$2.50 per year.

Use of the 4-H name and symbol approved by the secretary of Agriculture of the United States, January 23, 1951, under the provisions of the laws as reenacted by Sec. 707 of the Act of June 25, 1948 Public Law No. 772 80th Congress (10 USC 797).

Ten commandments for success

Editor's note: These guidelines for a successful life were written by a successful man, Jerry Litton of Missouri. He died this past year when he was only 39, in an airplane crash the night of the primary election, an election he was winning for the Senate seat from Missouri. He had previously served two terms in the House of Representatives, and before that, with his father, Charley Litton, had developed a top herd of Charolais cattle. He had been a national officer of the FFA.

Mr. Litton often included these rules for success in talks which he gave.

1. Don't give up easily; be persistent.
2. Overcome all handicaps. Those who do will be the people at the head table of life.
3. Work hard. Anything worth having is worth working for.
4. Cultivate your personality. Times have changed. Farmers have to get along with people in town.
5. Have initiative. When you get out of high school there won't be anyone to tell you what to do.
6. Have confidence in yourself; estimate your ability and then raise it 10 per cent.
7. Set high goals. Don't look for your ship to come in if you haven't sent one out, and it doesn't hurt to do a little working on the dock. Stop setting goals, and you're standing still.
8. Take advantage of all opportunity that home, community, and country can offer you.
9. Cooperate with other people.
10. Prayer and closeness with God. In my mind, this is the most important and essential. Prayer is not a last extremity but a personal necessity. A Christian can see more on his knees than a philosopher will ever see on his tiptoes.

Reprinted with permission from the Charolais Bull-O-Gram, edited and published by the Litton Charolais Ranch, Chillicothe, Missouri.

About the cover

Lisa Becker of Valley Victors purple ribbon winner at Kansas 4-H Club, Sedgwick County, took State Fair, the picture was taken this summer picture in 1976, her with a Zeiss Ikon camera. first year in 4-H photography. A

Money For Your Treasury

OVER 2 MILLION

Sunflower Dishcloths



WERE SOLD LAST YEAR BY MEMBERS OF GROUPS, SOCIETIES, CLUBS, ETC.

THEY ENABLE YOU TO EARN MONEY FOR YOUR TREASURY AND MAKE FRIENDS FOR YOUR ORGANIZATION

Sample FREE to Official.

SANGAMON MILLS, INC., Cohoes, N. Y. 12047
 Established 1915

CASH FOR NEWSPAPERS

\$25 per ton

Large Quantities picked up
 Approximately 10 ton or more

Thermal Shield, Inc.

1001 North Kauffman Road
 Hesston, Kansas 67062

Call 316/327-2131

Free!

4-H Woodworking Plans from YOUR LUMBER DEALER

**These plans
are available**



Padded Hassock

Made by Alan Buchanan, Wamego

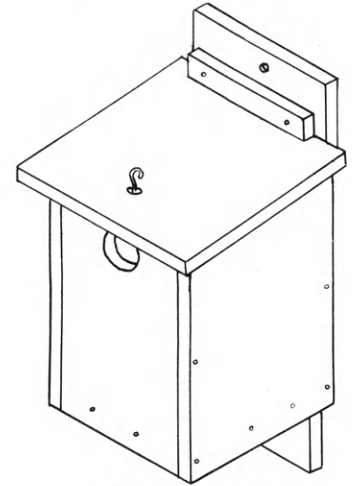

Bluebird Box

A rerun of an old favorite

Plans courtesy American Plywood Association

For your free plans, see your lumber dealer; he will also help you select the material you need.

Ashland Don Spotts Lumber Company	Erie Johnson & Son Lumber Co.	Iola Klein Lumber Company	Mankato Mid-West Lumber Company
Atchison J. B. Russell, Inc.	Eureka A. C. Houston Lumber Company	Johnson Seyb-Tucker Lumber and Implement Company	Marysville Howell Lumber Company
Axtell Meyer Lumber & Hardware Company	Fredonia Schoolcraft Lumber Co.	Junction City Builders Lumber Inc.	Minneapolis Dingee Lumber Co.
Basehor Basehor Lumber	Garden City Cash & Carry Lumber Co., Inc.	Kechi Buck Alley Lumber	Newton National Building Centers Home Care Center
Belleville Belleville Lumber Co.	Great Bend Everitt Lumber Co., Inc.	Kinsley The Kinsley Cooperative Exchange	Nickerson The Home Lumber & Supply Co.
Beloit Peoples Lumber & Coal Co.	Greensburg Hildinger's Lumber, Hardware & Ready Mix	La Cygne La Cygne Lumber and Ready Mix, Inc.	Norton Norton Lumber Company
Blue Rapids Blue Rapids Lumber Company	Harper Town & Country Lumber Co.	LaHarpe Diebolt Lumber and Supply	Nortonville Nortonville Lumber Inc.
Burrton Burrton Lumber & Development, Inc.	Hiawatha Motsinger Lumber Co.	Lakin Tate and Company	Oberlin Nichols Building Supply, Inc.
Clay Center Fullingtons	Hillsboro Hillsboro Lumber Co. The Lumberyard Inc.	Lansing Lansing Lumber, Inc.	Offerle Offerle Co-Op Grain & Supply Co.
Coffeyville Kansas Lumber Company	Holton Holton Lumber Company	Larned T. M. Deal Lumber Co.	Olathe Cowley Lumber & Hardware Co.
Coldwater Home Lumber and Supply Company	Hoxie Hoxie Lumber Co.	Liberal The Star Lumber Company	Osage City Martin Material Co., Inc.
Cottonwood Falls Chase County Lumber, Inc.	Hugoton The Star Lumber Company	Louisburg Louisburg Lumber Co.	Osborne Lewis A. Hardman Lumber Co.
Dodge City T. M. Deal Lumber Co.	Independence Sandott Lumber	Lyons Home Lumber & Supply Co.	Ottawa Hubbard Lumber Company, Inc.
Downs Downs Lumber Company		Manhattan Ramey Brothers	Parsons Woods-Seward Lumber Co.
Ellinwood Home Lumber & Supply Co.			Pittsburg Broadway Lumber Co., Inc.

4-H Around the State

By the State and Area 4-H Staff

OTHER PLANS AVAILABLE

Sheep Blocking Box	Walnut Shelf
Dairy Barn Desk	Clock
Wren House	Table Podium
Wheelbarrow	Feed Bunk
Mitten or Hose Dryer	Pedestal Picnic Table & Benches
Section Patio Tables	Salt Box
Bathroom Vanity	Saddle Rack
Entry Closet	Colonial Magazine Stand
Garden Entrance Trellis	Trestle Table
Foldaway Table	Quilting Frame
Picnic Table	Colonial Table
Extension Dining Table	Cedar Chest
Work Bench	Night Stand
Gun Cabinet	Pigeon Cage
Wall Desk	Hourglass-Porch Swing
Built-In Magazine & Book Rack	Martin House
Rocking Horse	Bicycle Rack
Movable Toy Storage	Food Drying Tray
Mod Squad Lawn Chair	Gable Roof Cupola
Chess Table	Portable Stile
Record Cabinet	Utility Table
Bookcase	Child's Table & Seats
Portable Planter Screen	Hanging Shelves
Ply-Tent	Meat Mallet
Wind Vane	Mail Box
Christmas Card Display	Bed
Table Soccer	

Morris County — Eleven 4-H members and two leaders from Morris County are participating in the return visit of the exchange set up with Crawford County, Arkansas, last year.

Riley County — The county 4-H council paper drive was a huge success, netting 27 plus tons of paper that were sold for \$682.25. The paper drive was used as a major means of raising money to support Adel Visser, selected to participate in the IFYE-AWE program to Poland this summer.

Pottawatomie County — The "IFYE Jamboree" sponsored by the county 4-H council and the county 4-H and Youth Advisory Committee on behalf of IFYE to Greece candidate Nancy Carnahan was also a huge success. The all day carnival held in Onaga netted \$750 with much of the income derived from a drawing that was a part of the carnival.

Hutchinson — Eldon Weaver, former county 4-H agent in Cowley County, will assume the position of South Central Area 4-H specialist located in Hutchinson, July 1, 1977. Eldon will be working with the 19 counties of the south central area, assisting them in 4-H programming and training.

Linn County — The first part of a two-way exchange with Robertson County, Tennessee, will begin for 15 Linn County junior leaders, 3 parents, and 2 extension agents Sunday, July 17. The return part of the exchange will be in the summer of 1978, when the Volunteers come to Linn County for a couple of weeks.

Wichita and Dodge City — July 29 and August 5 will mark the continuance of the Kansas 4-H Wheat Quality shows in Wichita and Dodge City respectively. The program format of these shows is designed to provide interest and participation for the entire family, with judging of the physical samples and mill and bake samples as secondary to the educational aspects

provided to focus on the "why" of raising and marketing quality wheat, instead of just how to put more bushels in the bin at harvest time.

Rice County — Chehalis, Washington, (Lewis County) is the major objective of eight Rice County 4-H'ers, along with their two adult sponsors, for an exchange trip July 5-18. The group will be traveling by means of the Rice County Extension council's 12 seat passenger van, with the 4-H'ers standing the expense of gas and oil.

Manhattan — State 4-H Leader's Convention, held the past two years at Rock Springs Ranch, state 4-H leadership center, will be conducted instead in each of the five extension areas in the spring of 1978. Meeting together, the state and area 4-H staffs decided on this approach to leader training and development, bringing the elements of the leaders' convention as close as possible to the leaders. programming will be determined by the respective area 4-H specialists and their advisory committees, but the state 4-H staff expects to participate as much as possible in the area conferences.

Sumner County — An interstate exchange trip is planned to Waconia, Carver County, Minnesota, for the week of August 15-21. Sumner County members will be making the trip to Carver County this August, with the return trip expected in 1978.

Animal puzzle

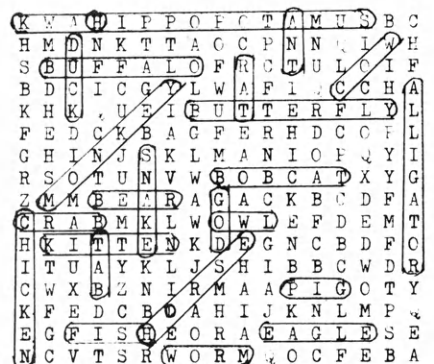

Puzzle is on page 15.

- Plains
 - Home Lumber and Supply Co.
- Pratt
 - W. R. Green Lumber Co., Inc.
- Redfield
 - Redfield Lumber Company
- Rossville
 - Hesse Lumber Company, Inc.
- Russell
 - Houston Lumber Company
- St. Francis
 - St. Francis Equity Exchange
- Salina
 - Easterday-Boster Lumber Co.
- Scott City
 - Scott City Building Materials
- Stafford
 - T. M. Deal Lumber Co.
- Syracuse
 - Hess Lumber Co.
- Tribune
 - Foster Lumber Company, Inc.
- Waterville
 - Waterville Lumber
- Wichita
 - Alexander Lumber Co., Inc.
 - Star Lumber & Supply Co.
- Wilson
 - Hoch Lumber Company
 - Wilson Lumber Co.
- Winfield
 - A. B. Everly Lumber Co.
 - Everitt Lumber Co., Inc.
- Wright
 - Right Coop. Assn.

An interview with John Carlin

The Speaker of the Kansas House of Representatives during this year's session was John Carlin, a former 4-H member from Saline County. When he was a 4-H'er, John was chosen as a member of the Report to the Nation team, the first Kansan to be chosen for this honor.

Kansas 4-H Journal: Where and when were you a 4-H member?

Carlin: I was a 4-H member from 1948 until 1959 at Smoky View in Saline County.

Kansas 4-H Journal: You were one of a group of six 4-H'ers chosen from throughout the country who represented all 4-H members with a report to President Eisenhower in 1959. What do you remember about that experience?

Carlin: Yes, I was in the group selected to present President Eisenhower with a tree to plant on his Gettysburg farm. The President

took about 15 minutes to cordially chat with the group. He was very relaxed, and we were quite impressed.

Kansas 4-H Journal: I've been told that the President enjoyed visiting with the 4-H members so much that he extended the time spent with them past the scheduled period. What was the conversation about?

Carlin: President Eisenhower did in fact spend extended time with our group as we discussed problems that were common to both Kansas farmers and his Gettysburg farm.

Kansas 4-H Journal: Did your experiences as a 4-H member influence you to later run for public office?

Carlin: My experience as a judge for 4-H assisted in the development of my speaking skills. This did not necessarily influence me to run for public office, but has aided me through my public career.

Kansas 4-H Journal: How long have you been a member of the House of Representatives?

Carlin: I was elected to the Kansas House of Representatives in 1970 and am currently serving my fourth two-year term.

Kansas 4-H Journal: After a term as Speaker of the House of Representatives, what problems or concerns are you now more aware of that you think Kansans should be thinking about and trying to find solutions for?

Carlin: I believe that Kansans should be concerned about problems related to Kansas water resources, energy, and our educational system. We must seek means for funding research programs related to these topics on both state and local levels.

Kansas 4-H Journal: As you have been in this responsible position, what are some of the strengths of Kansas which have impressed you?

Carlin: I have come to realize that Kansas has an excellent legislature — a legislature of citizens. Unlike other states, some of which hold a 120-day legislative session and others whose session progresses throughout the entire year, Kansas holds only a 90-day session in which to handle the business of the state. This "short" session is composed of a highly concentrated work schedule. Consequently, the session proves to be more productive, saves money and allows the common citizen to serve as an elected official.

I have found that the Kansas legislative system is an open and honest one. The resulting work is of great competence.

Kansas 4-H Journal: Some people are concerned about the growth of government, both in money costs and

You're feeling good because your 4-H livestock sold well at the sale after the fair, thanks to a generous buyer. Remember to thank the buyer and also to deposit part of the money in your local

Kansas Savings and Loan

Arkansas City

First Federal Savings and Loan Assn.

Clay Center

Northwestern Federal Savings and Loan Assn.

El Dorado

Mid-Continent Federal Savings and Loan Assn.

Eureka

Eureka Federal Savings & Loan Assn.

Fort Scott

Liberty Savings and Loan Assn.

Garnett

The Garnett Savings and Loan Assn.

Hutchinson

Valley Federal Savings & Loan Assn.

Leavenworth

Citizens' Mutual Savings and Loan Assn.
Leavenworth Mutual Saving and Loan Assn.

Liberal

Frontier Federal Savings and Loan Assn.

Lyons

Lyons Savings and Loan Assn.

Manhattan

Manhattan Federal Savings and Loan Assn.

McPherson

Pioneer Savings and Loan Assn.

Medicine Lodge

The Barber County Savings and Loan Assn.

Ottawa

Franklin Savings Assn.

Parsons

Mid-America Federal Savings and Loan Assn.

Plainville and Stockton

Rooks County Savings Assn.

INSURED SAFE

**state-wide services,
border-to-border**

COLUMBUS • COUNCIL GROVE
GOODLAND • JUNCTION CITY • KANSAS
CITY (2) • LAWRENCE • LEAWOOD
MISSION • OLATHE • OTTAWA
OVERLAND PARK • SHAWNEE





President Eisenhower was having a good time and so were the six 4-H members who were presenting the 4-H Report to the Nation in 1959. John Carlin, second from right, was a 4-H member from Saline County.

in control of people's lives; others think maximum power of government should be used to try to correct social and economic ills. What do you think really is the place of government?

Carlin: Government and government officials should strive to do for the people of this state what can be collectively done. By collective action we can achieve goals which may be unattainable when sought on an individual basis. The purpose of government is to provide services to the populace, and while doing so, provide as much freedom to that populace as is possible.

Kansas 4-H Journal: How can young people best learn about our government and about how it functions?

Carlin: By visiting the legislature along with becoming familiar with their state representative and senator, young people, as well as old, can become more knowledgeable about state government and its functions. It is also profitable to study the legislative process and, if possible, to become involved in political campaigning. It is through active participation that one best learns about the political process.

Kansas 4-H Journal: I understand you are a farmer; what kind of farming do you do? You were a state winner in the 4-H dairy project.

Carlin: I am presently a dairy-crop farmer, my primary interest being in

the dairy business.

Kansas 4-H Journal: What advice do you have for 4-H members today?

Carlin: My advice to all young people is to take advantage of the op-

portunities available through 4-H. Attempt to prepare for your future by obtaining as much knowledge and getting as much experience as you possibly can.

12th ANNUAL

KANSAS ALL BREEDS JUNIOR DAIRY SHOW

Salina, Kansas

Kenwood Park

August 19 & 20

(Entries Accepted Until August 15)

A state-wide show for 4-H & FFA

Eight show classes plus Jr. and Sr. Fitting and Showing and County Herd Class of 5 Animals.

Ayrshire • Brown Swiss • Guernsey
Holstein • Jersey • Milking Shorthorn

Ribbons and Premiums
for all classes

PLUS—SPECIAL BREED AWARDS

Animals in place Friday at 4:00 p.m. Exhibitor banquet at 6:30 p.m. Friday at 4-H Building, sponsored by Midland United Dairy Industries Association. Fitting and Showing will be Friday evening. Judging begins Saturday morning in Agriculture Hall.

Sponsored By

Agricultural Committee, Salina Area Chamber of Commerce and
Kansas Interbreed Dairy Council in cooperation with
the Kansas Extension Service.

Write for entry to: Chamber of Commerce,
P.O. Box 596
Salina, Kansas 67401
Attn. Wilma E. McCormack

Good eating habits str

By Mary Clarke
 Extension Specialist, Nutrition Education
 Kansas State University
 Manhattan

How's your hold on a long and healthy life? The strength of your grip on the "rope of life" extending into your future can be greatly influenced by what you eat day in and day out. Some people are born with

a "rope" (your heredity) that is stronger than others. There are few weak places in it. Others not so fortunate are apt to get sick often or become chronically ill later in life. Even a strong body can be seriously weakened or broken by the lack of good nutrition. Of course, other habits of sleep and exercise are important too. Good mental health

Check the column under **true** if the statement is true for you; under **false** if it does not describe what you do.

	True	False
1. I usually eat a good breakfast. (Something from at least three of the four food groups : fruit and vegetable, milk, bread and cereal, and meat group foods)	___	___
2. I daily eat foods from all four of the food groups.	___	___
3. I eat at least three times each day.	___	___
4. I keep my weight normal. I'm not too fat nor too thin for my height and age.	___	___
5. I usually eat foods only lightly sugared rather than those that are highly sweetened such as some cakes, pies, cookies, sweetened pop or fruit-flavored drinks, candy, etc.	___	___
6. I usually have some milk or milk products high in calcium daily (cheese, ice cream, yogurt, skim milk, etc.).	___	___
7. I eat some whole grain foods daily. (Examples: whole wheat bread, whole wheat cereals, oatmeal, granola, popcorn, whole wheat crackers)	___	___
8. I seldom sprinkle salt on my food.	___	___
9. I use some iodized salt.	___	___
10. The water I drink has fluorine naturally or added to it. Fluorine helps build strong bones and teeth. Chlorine added to water helps make it safe to drink.	___	___
11. I use margarine with a liquid vegetable oil named as the first ingredient on the label, for example, liquid corn, soybean, or cottonseed oil. This margarine is higher in polyunsaturated fat than those made from all partially hardened or hydrogenated oils. Avoid using palm or coconut oils frequently.	___	___
12. I usually eat foods that are low in fat. Foods high in calories from fat include fried foods, weiners and luncheon meats, most cheese, cream, fatty meat, peanuts and nuts, egg yolks, and often granola.	___	___
13. I eat foods that contain vegetable oils more often than those with animal fats such as lard, bacon grease, beef suet, and some margarines.	___	___
14. I eat only the lean part of meat or poultry such as chicken or turkey.	___	___

ngthen your rope of life

and emotional balance are also important. But many suffer poor health or die because of lifetime poor food habits. Of course, no one can change the kind of body you are born with, but you can certainly do a great deal to keep the one you have in good repair and strong by the habits you have.

By eating a good diet day in and day out, you can slow down or prevent altogether many of the ills that seem to "just happen" as we grow older. It's not just a matter of good or bad luck. Your nutrition insur-

ance policy is being purchased and eaten bit by bit every time you put food or drink into your mouth. Few of us stop to think about it, but what you are in the habit of eating from the time you are a little child can make a great difference in your health and how you feel, look, and even behave.

This nutrition insurance policy is a result of all sorts of little habits you and I develop. Here are some habits that can help or hinder your good health. Which ones do you have?

15. I eat foods containing some protein two or three times a day. Protein foods include milk, cheese, ice cream, eggs, peanut butter, nuts, cooked dried peas and beans, meat, fish, chicken, etc. ___ ___
16. I eat 3 to 5 eggs each week. ___ ___
17. I eat a serving of a dark green or deep yellow **vegetables** or **fruits** rich in vitamin A every other day or at least 3 times a week. This includes dark green leafy vegetables such as spinach, kale, or other greens, broccoli, carrots, sweet potatoes, winter squash, cantaloupe, apricots, etc. ___ ___
18. I eat a food rich in vitamin C nearly every day. Best sources are grapefruit, oranges, cantaloupe, broccoli, raw strawberries, sweet peppers, brussels sprouts, and tomatoes. Foods fortified with vitamin C such as fruit-flavored drinks will usually not have or will carry smaller amounts of many of the lesser known vitamins and minerals than regular fruits and juices. ___ ___
19. I use at least 5 or 6 cups of liquids daily. ___ ___
20. I depend upon food rather than vitamin or mineral pills to get all of the 50 or more nutrients I need. ___ ___
21. I eat some plant foods containing food fiber daily. Examples of foods rich in food fiber (also called bulk, roughage, cellulose, etc.) are whole grains with the outside bran layers left on and raw and cooked vegetables and fruits including cooked dried beans and peas that have the skins left on. ___ ___

Scoring: Count all of the **true** answers.

18-21—You have excellent food habits. There's very little you can do to improve. The "crystal ball" says that you will likely have a long and healthy life.

15-17—The coverage in your "nutrition insurance policy" has some weak spots. You may want to make some changes in your food habits.

less than

14 —You're definitely flirting with endangering your health. You're counting too much on luck or a strong heredity.

Bonus Point

22. If I live with other people, I have at least one of my meals with them each day.

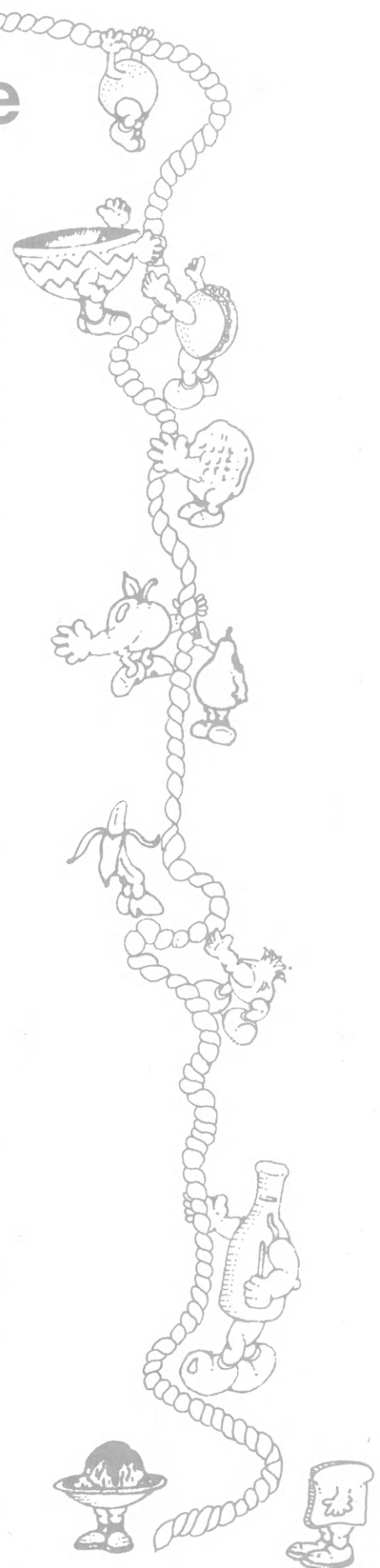

From the Northwest Area:

Phillips County: Linda Child, from Rockhampton, England, is a 4-H youth exchange student who stayed with the Wayne Smith family at Phillipsburg. Linda is a member of a Young Farmers club which is similar to 4-H. Linda works in the personnel department at a Waterfowl Trust, a bird sanctuary where endangered birds live. The goal, writes Melody Townley, is to increase the numbers of near-extinct birds so that one day they can be returned to places where they once lived.

Linda showed slides of the English countryside at the Iowa Union 4-H Club meeting. Instead of fences, the English farmers use hedges of ash, maple, and oak trees. When the bottom part of the hedge becomes spindly, the hedge has to be relaid. The Young Farmers clubs have contests for re-laying hedges, public speaking, debates, and livestock judging. When the members of their clubs judge livestock, the young people wear white smocks and introduce themselves to the judges very formally. These slides showed their members looking as befuddled as most of our livestock judges, Melody writes.

On Linda's family's dairy farm, cattle are kept inside the barn in the rainy winter because if they aren't, the grass won't grow in the spring. Wheat, priced at \$4.50 a bushel, is beardless and soft. The English people are learning to economize with family gardens, small cars, and so on. Gasoline costs \$1.50 a gallon.

Sherman County: Making the community a healthier place to live is a goal of the Glendale Livewire 4-H Club. In February, they conducted a successful one-day dog and cat rabies clinic. One hundred dogs and cats received shots to protect them against rabies. Greg Henry reports that, using the news media, the Livewires are encouraging more people of the community to give their pets rabies inoculations.

From the Northeast Area:

Cloud County: Miltonvale Hustlers 4-H Club members honored their leader, Mrs. Carl Richard, for 10 years as the club leader, 10 years during which the club has received 10 purple seals. After a ceremony during which Mrs. Richard received a plaque with a four-leaf clover as well as carnations along with messages from 4-H members, punch and cake were served from a candlelit table, Karen Breen reports.

(continued on page 14)

LABOR'S FONDEST DREAM...

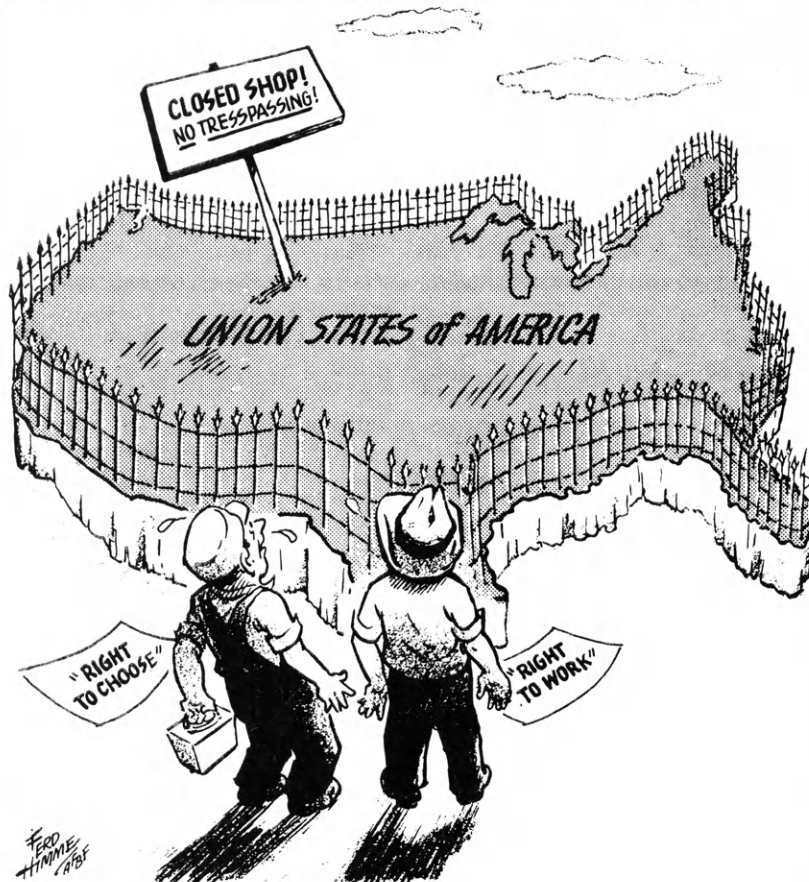

The AFL-CIO and other unions are working in Congress to overhaul the National Labor Relations Act in the hope of dumping Section 14-B.

14-B says states may pass laws permitting residents to hold jobs without having to join a union.

Kansas and 21 other states have such laws.

Farmers and ranchers through Farm Bureau are working to keep those laws. They want freedom for working men and women.

Farm Bureau . . . the freedom organization

One of the top young cowboys in this part of the country — that's Steve Flinn, St. George, a 15 year old member of Bonfire 4-H Club in Riley County. He participates in 4-H rodeos, high school rodeos, open shows, and Little Britches rodeos.

This past August Steve took part in the National Little Britches Rodeo Association finals in Pueblo, Colorado, placing first in junior division ribbon roping with his partner, Stephanie Warren of Eskridge. Steve's favorite event is roping; he says he began learning as soon as he was big enough to pick up a rope. By the time he was 9, he began participating in rodeos.

But roping is just one of the young athlete's skills; in fact, at four rodeos in 1976 he won the title of all around cowboy, and has won this title four consecutive years at the Wabaunsee County 4-H Rodeo, based on combined points in various events. He has won six trophy saddles in Little Britches rodeos.

Six years ago Steve started into 4-H with his first green horse, a black mare named Cricket. She has been a champion and reserve champion in halter, pleasure, horsemanship, and showmanship. Steve and Cricket won the horse showmanship class and then participated in the overall showman-

A Kansas cowboy

ship classes to win master and, another year, reserve master.

Steve has another horse named Kansas Wimpy, nicknamed Joe, who is the same age within two months as Steve is. Both quarter horses, Cricket and Joe are the two main mounts he rides in horse shows and rodeos, although recently he bought a horse to use for bull dogging.

When asked for suggestions for young 4-H members who are interested in the horse project, the slender soft-spoken horseman said to start with a good broke horse because "It will teach you. After learning showmanship and horsemanship yourself, you may start a green or young horse at halter, then continue into performance events. Learn how to ride well before roping from a horse or racing," he suggested.

This spring Steve injured his wrist bull dogging, but it didn't slow him for long; by the end of June, he

had taken part in Little Britches rodeos at Hill City and Scott City in Kansas and at Wymore, Nebraska, as well as in the Kansas high school rodeo in Topeka.

In 1976 Steve was in the junior division when he competed for the first time in the National Little Britches Rodeo Association finals; however, this year he will face stiffer competition as he moves into the senior division. To qualify for this event, the young horseman must place two times in each category in a Little Britches sanctioned rodeo. This year the finals will take place in Fort Pierre, South Dakota, in August.

Steve's parents are Mr. and Mrs. Merle Flinn of St. George; Steve credits his father, who is also a rodeo performer, with teaching him. The Flinns' daughter, Wanita, also shows in 4-H and open events. Their horsemanship leader in 4-H has been Bernard Wells, Manhattan.

As a 4-H member, Steve has had beef and leatherworking as projects, in addition to horsemanship. In 1976 he had the hide tanned from his 4-H steer, and made into a special rug for his room.

This fall Steve will be president of the sophomore class at St. George High School. He is a member of FFA and of student council.

Steve and Kansas Wimpy catch a calf quickly in breakaway roping at the NLBRA finals at Pueblo, Colorado.

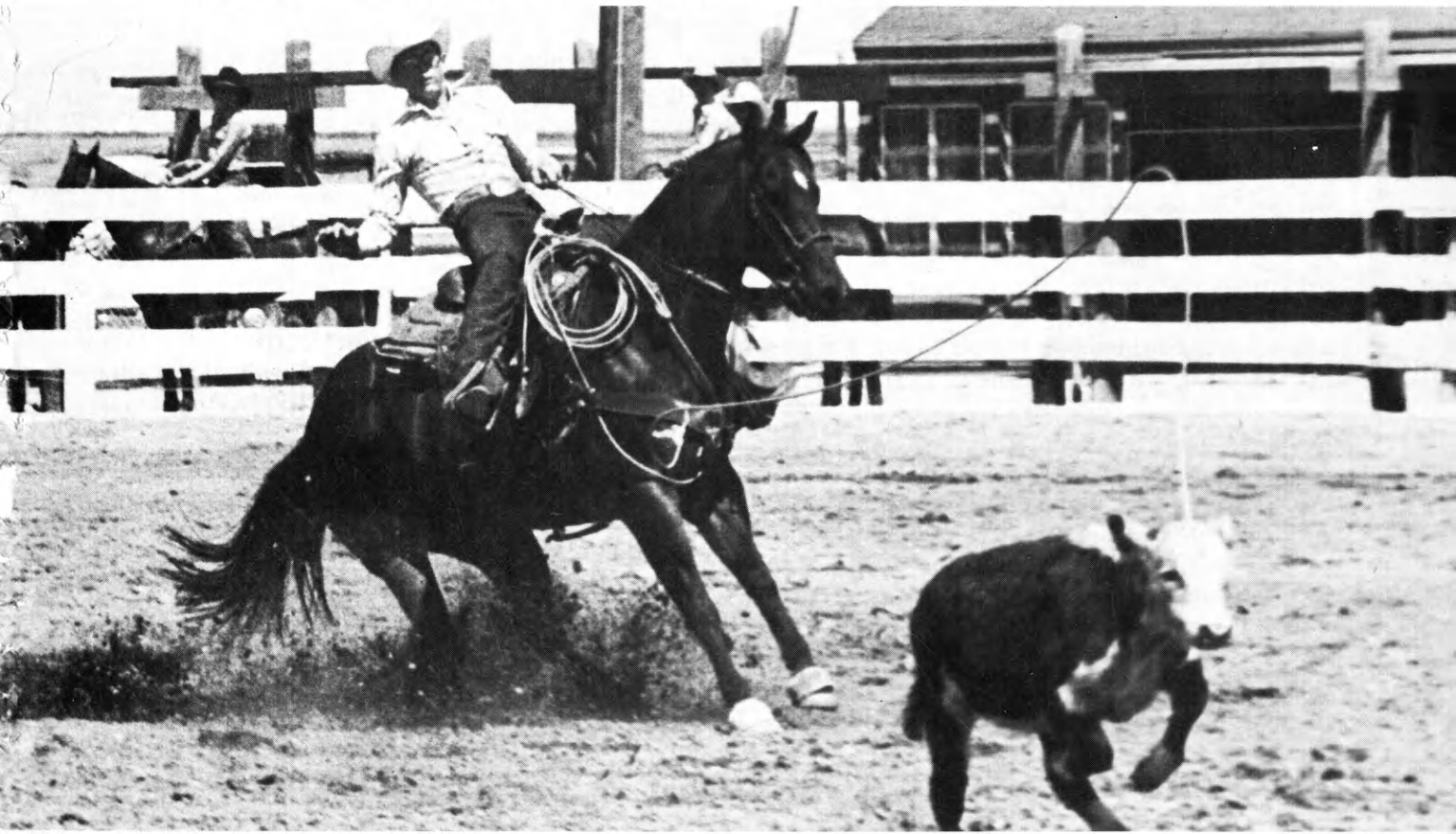

THE FORD MOTOR

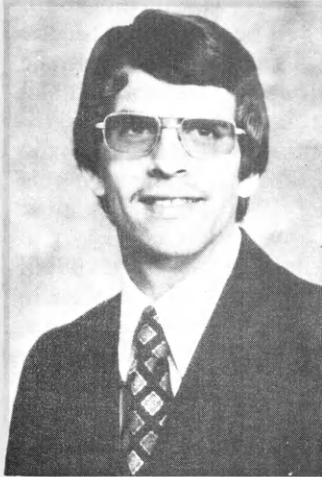

Charles Odgers

STATE AND NATIONAL WINNER

Kansas had a national achievement winner in 1976, Charles Odgers of Sublette in Haskell County. He is a farmer, and most of the 18 projects which he completed this past year related to farming.

1976 was the second year Charles has been honored as a national 4-H winner; in 1974 he won the same accolade in agriculture. In 1975 as a state wheat quality winner he won a trip to Houston given by the Kansas Wheat Commission. Charles exhibited at five district wheat shows and won 11 blue ribbons in five years. Other major projects have been sheep, alfalfa, grain sorghum, corn, woodworking, and electricity.

Charles was a member of the 1976 state youth advisory group. In 1974 he was a Key Award winner.

Charles is the son of Mr. and Mrs. Marvin Odgers. Ford Motor Company provided the trip to National 4-H Congress and an \$800 scholarship. Charles is a student at Garden City Community College.

4-H

The Ford Motor Company is proud to present a maximum of four gold-plated medals of honor to county winners in the 4-H achievement program.

County

ALLEN Jack Sweany Douglas Stackler Vicky Ritter Cindy Wagner	CHASE Bryant Mercer Bryan Stackley Marla Molzen Jayne Starks	COMANCHE Chan Gates Sandy Murphy Dennis McKinney Kathy Parcel	ELK Calvin Clubine Ken Kelly Sherril Markley Kathy Perkins	GRAHAM Jahita Davis Rbhin Morris Rita Minium Mike Dinkel	HASKELL Charles Odgers Dale Moore Thresa Allen Doug Moore
ANDERSON Joe Rickabaugh Darren McGhee Lorena Croucher Nancy Miller	CHAUTAUQUA Lori Martin Marcia Magnus Cathy Magnus Lila Thompson	COWLEY Becky Haddock Mitch Post Brenda Ireton Marshall Post	ELLIS Shirleen Flinn Elaine Dinkel Lester Elston Charla Engel	GRANT Debbie Swearingen Henry Smith Peggy Sewell Allen Randles	HODGEMAN Ardeen Webster DeWayne Craghead Doug Vieux Cheryl Dauber
ATCHISON Becky Besancon Ty Compton Susan Sternsdorff Steven Handke	CHEROKEE Linda Hilderbrand Tammie Carver Shane Eckhardt Gregg Martin	CRAWFORD Lorri VonSoosten Annette Brooker Chuck Kunshek Bill Marshall	ELLSWORTH Jeanette Westerman Brian Huseman Allan Grothusen Flint Warta	GRAY John Rowan Susan Kerr Karla Lynde David Strawn	JACKSON Jill Guess Daryl Fisher Susan Wells Nancy Gooderl
BARBER Susan Bland Mona Rusk Clint Rusk Harold Angell	CHEYENNE Linda Cooper Shelley Linn Randy Hager Kelly Morris	DECATUR Tracy Marshall Ward Brown Gayle Anderson Darla Anderson	FINNEY Mark Schweer Dawn Smith Diane Fillmore Rosemary Huschka	GREELEY Kim Byerly Blane Kleymann Cari Werner Coree Smith	JEFFERSON Kirk Johnson John Houk Karla Hefty Linda Bigham
BARTON Judy Demel Wayne DeWerff Tim Demel Elaine Besthorn	CLARK Barbara Blankinship Rita Moon Cherie Esplund Don Breit	DICKINSON Kent Schuler Larry Garten Natalie Luthi Mary Garten	FORD Charles Nicholson Lyn Snyder Lane Newell Sharlet Deaver	GREENWOOD Terry Hart Crandell McLean Joshiene McLean Jeri Luthi	JEWELL Juaneice Reed Lyle Shipley Melva Shipley Ed Beam
BOURBON Mark Fink Susan Ericson Curtis Russell Brenda Ericson	CLAY Marianne Mugler Karl Visser Rose Scott Marvin Fehlman	DONIPHAN Patty Megown Doris Delzeit Scott Sallee Vanetta Blevins	FRANKLIN Bill Blake Marilyn McClure Debbie Chambers Becky Vining	HAMILTON Charles Golladay Tammy Maxfield Cheryl Cook Margaret Golladay	JOHNSON Charles Voigts Theresa Schlagel Mike Keener Jeannine French
BROWN Martha Dale Jeanne Chadwell Juanelle Pederson Terry Neher	CLOUD Tami Morgan Bradley Fuller Tammy Dorman Randy Johnson	DOUGLAS Linda Cleland JoAnne Born Dale Anders Merlin Johnston	GEARY Belinda Decker Kris Rogers Keith Ascher Ralph Lee	HARPER Tim Dierksen Jerry Pomeroy Cathy Patterson Pam Catlin	KEARNY Rhonda Palmer Joy Palmer Annette Shankle Franci Horton
BUTLER Kenneth Willhite Cindy Simon Brent Mossman Lane Chase	COFFEY Mark Raaf Georganne Dawson	EDWARDS Martha Herrmann Merle Craig Shirley Fouse	GOVE Bryan Evans Linda Jones Debbie Packard Joyce Lubbers	HARVEY Kathy Lowe Anita Sawyerwein Susan Gatz Doug Patterson	LINCOLN Dwight Watson Lorelei Dohl Greg Morrical Lynnette Wallace

These Ford dealers are proud to have a part in providing awards for, and saluting Kansas winners in the 4-H Achievement Program.

ATCHISON
Pruessner Ford, Inc.

AUGUSTA
Hanning-Monnat Ford, Inc.

BELOIT
Gourley Ford, Inc.

CALDWELL
Bluebaugh Ford-Mercury, Inc.

CHANUTE
Merle Kelly Ford, Inc.

CIMARRON
Cimarron Ford, Inc.

CLYDE
George Motor Co.

COUNCIL GROVE
Trimmell Ford
ELLSWORTH
Westerhaus Motor Co.

EMPORIA
John North Ford, Inc.

FORT SCOTT
Ray Shepherd Motors, Inc.
FREDONIA
Demick Ford & Mercury, Inc.

GARDEN CITY
Burtis Motor Co., Inc.
Merrill, Inc.

GARNETT
Anderson Motor Co., Inc.
GREAT BEND
Great Bend Ford Tractor, Inc.

HILL CITY
Ray's Ford, Inc.

HOLTON
Roberts Ford, Inc.

COMPANY PRESENTS

Achievement Award Winners

STATE WINNER

State achievement winner Cecilia Kasl from Cuba in Republic County was co-chairman of the 50th anniversary celebration of the Kansas State University Collegiate 4-H Club, and will be the reporter this fall semester.

As an 11 year member of Merry Meadowlarks 4-H Club, Cecilia worked for 10 years with home improvement; beginning with her room, she went on to improve every room in the house. Another major project was clothing; in 1976 alone she made 16 garments. With health and safety as particular interests, Cecilia won a trip to National Safety Congress in Chicago in 1973.

In 1974 Cecilia was state newswriting winner. This past year in observance of the bicentennial and of her club's 25th anniversary, she prepared a history of the club.

Cecilia was a 1974 Key Award winner. At state fairs, she rated purple on public speaking and on home improvement and was on judging teams five years. Cecilia has been president and reporter of her local club, as well as secretary of the county council and vice president of the county junior leaders organization.

Her parents are Mr. and Mrs. Joe Kasl.



Cecilia Kasl

One state winner receives a trip to the National 4-H Congress in Chicago while nine \$800 Henry Ford II Educational Scholarships are awarded to national winners.

Winners

ANN Max Krull Robert Orth Janet Avery Pam Martin	MEADE Clair Bender Darwin Ediger Connie Friesen Bruce Padgett	NEMAHA John Dobbins Clint Tegtmeier Sandra Tegtmeier Helen Wells	PHILLIPS Clinton Pumphrey Doug Van Allen Tom Fabin Lew Ann Schneider	ROOKS Lorna Sutor Richard Dechant Jr. Becky Jackson Dale Carpenter	SHERIDAN Ellen Wasserman Janet Karnes Randy Mader Gail Meitl	TREGO Christine Schamberger Sheryl Muden Shirley Loflin Mary Jo Felder
LOGAN Jim Mather Karen Darnall Carla Jo Hanson Scott Samuelson	MIAMI Melinda Harbison Becky Mueller Phyllis Butel Gwen Williams	NEOSHO Randy Reinhardt Alex Mih Bruce Brock Joe Simmons	POTTAWATOMIE Sharon Bairow Barbara Fairbanks Haddie Burrow Donald Honig	RUSH Steve Misegadis Fran Jira Christie Conard Rhonda Lippert	SHERMAN Kristi Nelson Peg Short Jorita Henry Ron Schilling	WABAUNSEE Todd Brethour Gregg Gensing LaDonna Dearing Rolinda Smith
LYON Matt Johnson Margaret Stewart Jill Leeberg Linda Collinge	MITCHELL Larry Thompson Rebecca Brobst Tammy Wilson Janette Wilson	NESS Sally Irvin Pat Schlegel Tom Wierman Arlan Hair	PRATT Bruce Clark Carla Lawrence	RUSSELL Raeleen McKinley Lucy Anschutz Brad Stoppel Kara Cederberg	SMITH David Rorabaugh John George	WALLACE Virgil Scott Judy Fischer Etta Walker Kay Pilger
MCPHERSON Dwight Wedel Roger Regehr Ann Toll Kathy Rupp	MONTGOMERY Carol Huneycutt Sharon Gartner Dean Mitchell Carrie Mitchell	NORTON Kathy Sprigg Danny Field Becky Juenemann	RAWLINS Dave Kacirek Laurie Green Doug Klein Debbie Mentlick	SALINE Nancy McDaniel Kim Glasgow Virginia Wann Jill Cyr	STAFFORD Terri Teichmann Mike Hullman Paula Thole Grant White	WASHINGTON Brant Laue Glee Condray Ron Graham Rita Steier
MARION Debra Palmer Natalie Hiebert Kevin Pankratz Stuart Leppke	MORRIS Kenneth Wilkerson Shari Mark Richard Muller Susan Zimmerman	OSAGE Scott Trueblood JoAnn Quaney Eddie Thompson Kim Lindburg	RENO Karen Horton Kim Krehbiel Beth Lang Ken Schmucker	SCOTT Melinda Griffith Randy Scheuerman Marilyn Maddux Brad Baker	STANTON Laura Hume Jerry Lipes	WICHITA Linda Berend Denise Harp Bill Bergh Teresa Luebbers
MARSHALL Jeanne Carlson Kathy Weickert Joyce Wright LuAnn Wassenberg	MORTON Brian Johns Bryan Fisher Ciana Boaldin Shurma Milburn	OSBORNE David Spears Julie Dugan Mike LaRosh Donita Carswell	REPUBLIC Cecilia Kasl Pam Cossaart Karen Kalivoda Kandy Tallent	SEDGWICK Connie Pelton Kathy Enix Byron Enix Kent Nicholson	STEVENS Tony Martin Billy Leonard Kara White Debbie Clinesmith	WILSON Debbie Scott
HUGOTON Don Trentham Ford, Inc.	HUTCHINSON BPH Tractor Co., Inc.	OTTAWA Diana Berry Debra Berry Sally McCall Rochelle Marrs	RICE James Bush Sandra Myers Charles McQuilliam Diana Keesling	SEWARD Maryilyn Shuman Cindy Brose Dianne Harvey Justina Hall	SUMNER Brad Kloefkorn Les Glenn Darlene Humbert Debbie Glenn	WOODSON Barbara Pringle David Lauber Stephanie Pringle Randy Downey
JUNCTION CITY Gateway Ford-Mercury, Inc.	KINGMAN Van Landingham Motors, Inc.	PAWNEE Shelley Bowman Marsha Steffen Mary Jane Hanson Steve Barrett	RILEY Keith Duer Lynn Warnica Wayne Michaels Jelone Siegle	SHAWNEE Tom Bacon Garry Peel Michelle Schmitz Cindy McNorton	THOMAS Patty Sloan Mary Crabtree Kay Gilbert Julie Carmen	WYANDOTTE Eric Vaught Julie Swanson Mark Wise Christianne Vaught

HUGOTON Don Trentham Ford, Inc.	LIBERAL Per Hoel Ford, Inc.	PRATT Marsh Engine Service & Supply, Inc.
HUTCHINSON BPH Tractor Co., Inc.	MCPHERSON Reimer Ford-Lincoln-Mercury, Inc.	SABETHA McFall Motors
JUNCTION CITY Gateway Ford-Mercury, Inc.	MARION Marion Motor Center	SEDAN N. B. Wall Motor Co.
KINGMAN Van Landingham Motors, Inc.	NEWTON Don Rau Ford	SYLVIA Martin Motor Service
LAWRENCE John Haddock Ford, Inc.	NORTON Bennett Motors, Inc.	TOPEKA Lou McKernan Lincoln Mercury, Inc. Midcon Division of Martin Tractor Co.
LEBANON Schuette Motor Co.	OBERLIN Kump Motor Co., Inc.	WICHITA Dick Price Motors, Inc. Wichita Ford Tractor, Inc.
LEOTI Skip Harkness Ford, Inc.	OSAWATOMIE Osawatome Motors, Inc.	

● Mustang ● Cougar ● Mercury ● Lincoln ● Thunderbird

Geary County: Charles Lee writes about a special float which Clark's Creek 4-H Club made this past year for a Junction City parade. "The Alvin Amthauer family offered the use of their Model 1929 Ford truck and an old walking plow. The club accepted and built a float on the truck, refinishing the plow and mounting it on the bed of the truck using the theme '4-H Plows into '76' with four club members riding beside it, one pair dressed in bicentennial costume and the other pair in the dress of today." Then the club received invitations to take part in parades at Wakefield and at Council Grove.

Nemaha County: As part of their people-to-people project, members of Lucky Shamrock 4-H Club of Bern presented a program of music and magic to residents of the Apostolic Christian Home of the Aged in Sabetha . . . Forty-one club members and their families, leaders, and guests enjoyed viewing projects at the Terry Tegtmeiers, John Harters, Byron Lears, and Ron Wettmers during the Lucky Shamrocks 4-H tour. The tour which took place on Father's Day climaxed with a picnic in the Bern Park., reports Marcia Miller.

Shawnee County: A summer meeting of Harmony Hustlers 4-H Club was high lighted when members modeled the hats they had created, using pipes, animals, and just about anything else. Barb Konrade reports . . . David Combs, junior leader for cycle safety of Elmont Wildcats 4-H Club, tells of fun ways the club members have encouraged safety. Each made a poster which was displayed at a meeting; they passed out booklets to the parents called "Sharing the Roadways." It was to be read and then passed on to a friend.

Washington County: The Lucky Four teen cooking group consisting of Kathy Anderson, Hayley Jo Matson, Lori Nelson, Beth Pearson, Randy Wilkens, and Hulda Matson, leader, have been on the go. Recently they toured a local ice cream factory. In April they hosted a tea for their mothers. They served cookies at Parents' Night.

From the South Central Area:

Harvey County: "The hospitality of the western Kansas hosts was fantastic and hunting was good," writes Kathy Murphy, reporter of the Newton City Slickers 4-H Club, Harvey County. Geology project members of the City Slickers 4-H Club, of Peabody Hustlers 4-H Club, and a member of Walton Willing Workers 4-H Club were guests of the Meadow Lark 4-H Club at Utica. The group from central Kansas traveled to western Kansas to hunt for geology specimens. Along the way they visited the Fort Hays Stienburg Museum, Castle Rock and Monument Rock. After a day of hunting and sightseeing the Meadow Lark 4-H Club provided a picnic supper, and had many games for everyone to enjoy.



Dancing goony birds made by members of Cowley County Liberty 4-H craft class were shared with residents of a nursing home in Winfield. In the picture are Merrie Pat Reynolds, Deandra Rhodes, Georgana Weigle, Lesia Askins, and Anna Askins. Others in the craft group are Sonja Ruggles, Linda McCullough, Audrey McCullough, Rodney Wedd, and Lee Ann Wedd.

Japanese students visit in Kansas

Editor's Note: Fifteen Kansas counties are participating in LABO, an exchange program in which about 180 Japanese boys and girls are visiting in Kansas homes this summer. These thoughts from Ellsworth County must be typical of feelings of host families throughout the state.

By Members of Ellsworth
County 4-H Council

From the 28th of July until August 20, nine Ellsworth families are hosting nine Japanese boys and girls. This is a new experience for all of the host families.

Most of the children have never been on a farm. They want to become acquainted with our way of life, to see our homes, where and how we shop, our schools, the library, and to visit the 4-H clubs and other organizations.

Each host family will plan and prepare a Thanksgiving dinner with turkey, dressing, cranberry sauce, and pumpkin pie, to share this tradition with these special guests. The host families serve the children the same meals as they fix for their own. Rice is not one of the main dishes here in America, so this will be much different for the children.

Japan is mainly Buddhist. Our religion is different from the children's. In the United States, most Christians worship God once a week, but in Japan, the people visit the Buddhist Shrine on special oc-

casions. Many have shrines in their own homes.

Because of the scarcity of land, Japan has no drive-in movies. This is a new experience for the children.

The names of the youngsters who are staying with 4-H families are:

Yoko Tsukazoki—a 12 year old girl whose father is a doctor. She is staying with the Ron Svaty family.

Junko Koado—a 14 year old girl whose father is a public servant.

She is staying with the George Place family.

Kei Thaeishi—a 15 year old boy who comes from Tokyo. He is with the Jack Grothusen family.

Futoshi Yamasaki—a 14 year old boy who enjoys stamp collecting.

He is with the Marvin Schneider family.

Noeiko Yagi—a 16 year old girl who has two younger brothers. Her father is a transportation engineer, and her mother teaches.

She stays with the James Cowans.

Tanimura Hideki—a 13 year old boy who is an only child. His father is a photographer. He stays with the Rance Headley family.

Kitanaha Shigemi—a 13 year old girl. She is with the Kermit Rush family.

The chaperone for the group in Ellsworth County is Keiko Yoshinaga. Mrs. Rance Headley is the county coordinator.

Family Fun Page

Q. Why is an island a lot like the letter T?

A. It is in the middle of water.

Q. What's black, green and black?

A. Two skunks fighting for a pickle.

Tina Boyer, Brookville

"Daddy," cried Junior, "Mommy was backing out of the garage, and she ran over my bike!"

"Well, it serves you right," exclaimed Daddy. "How many times have I told you not to leave your bike on the porch?"

Julie McClure, Salina



LISTEN CHARLEY, I'M JUST AS STUBBORN AS YOU ARE!

Animal puzzle

First Rancher: What's the name of your spread?

Second Rancher: CIQ Circle K YBL Bar S.

First Rancher: How many head you got?

Second Rancher: Just a handful; not many survive the branding!

Prize Winner

A widow whose husband's name was Kaye went to his casket and kept saying, "Poor Kaye, Poor Kaye, Poor Kaye." Suddenly a voice from the casket said, "Butter."

Sue: What did the grape say when the elephant sat on it?

Joe: Nothing, it just gave a little wine.

Christy Myers, Hutchinson

Q. How do you shoot a blue elephant?

A. With a blue elephant gun.

Q. How do you shoot a pink elephant?

A. Squeeze him till he turns blue and shoot him with a blue elephant gun!

Lyn Scott, Council Grove

4-H members are invited to contribute jokes, riddles, puzzles, or cartoons to Family Fun Page. Each month the fun page item selected as best by a committee will receive \$1.

ALLIGATOR
ANT
EAGLE
BAT
BUFFALO
OWL
DUCK
HAWK

SNAKE
RAT
CRAB
BOBCAT
DOG
CAT
HORSE
HIPPOPOTAMUS

MONKEY
BEAR
BUTTERFLY
FISH
WORM
COW
PIG
KITTEN
CHICKEN

K W A H I P P O P O T A M U S B C
H M D N K T T A O C P N N Q I W H
S B U F F A L O F R C T U L O I F
B D C I C G Y L W A T I Q C C H A
K H K Q U E I B U T T E R F L Y L
F E D C K B A G F E R H D C O P L
G H I N J S K L M A N I O P Q Y I
R S O T U N V W B O B C A T X Y G
Z M M B E A R A G A C K B C D F A
C R A B M K L W O W L E F D E M T
H K I T T E N K D E G N C B D F O
I T U A Y K L J S H I B B C W D R
C W X B Z N I R M A A P I G O T Y
K F E D C B O A H I J K N L M P Q
E G F I S H E O R A E A G L E S E
N C V T S R W O R M Q O C F E B A

Solution is on page 5.

Georganne Dawson, Waverly

Work in the electronics field is a goal for David Nordhus, Marysville, who enjoyed his five years of work and learning in the electric project.

This past school year, David worked in a radio-television business as part of his school work, and this fall he plans to enter Kansas Technical Institute at Salina to study electronics.

David started with easy projects in his 4-H electric work; rewiring a lamp and making a game using electric connections.

Then he became interested in electronics and built a portable radio from a kit. A more advanced project was wiring of a volt-ohm-meter kit, which would be useful in new projects he might build.

He received blue at the Marshall County Fair on all these projects and was able to take them on to Kansas State Fair.

David belonged to the Happy Harvesters 4-H Club. He is the son of Mr. and Mrs. Francis Nordhus of Marysville.

This spring David was graduated from Marysville High School.

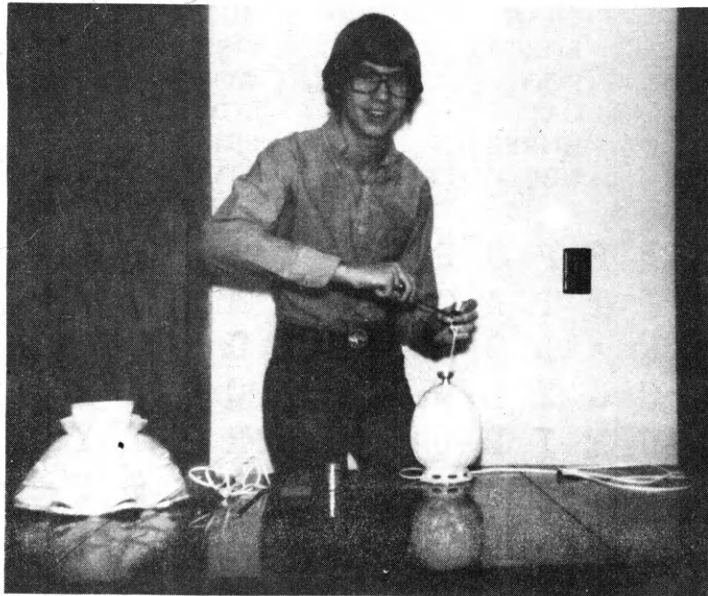

David is pictured practicing a demonstration which he gave at 4-H Day, receiving a blue ribbon. He gave several other demonstrations relating to the electric project.

Electronics is a career goal



These are some of the things David made which took more advanced skills.

What are you or your family doing to conserve energy? Please send your ideas, with illustrations if possible, to Electric Page, Kansas 4-H Journal, Umberger Hall, KSU, Manhattan, Kansas 66506.



Watch This Page For Ideas On Farm And Home Electric Projects

ELECTRIC LIGHT and POWER COMPANIES in KANSAS

The Kansas Power and Light Company Central Kansas Power Company
Kansas Gas and Electric Company
Western Power Division of Central Telephone & Utilities Corporation

