

AN INVESTIGATION OF RESONANCE OF FREQUENCY
MODULATED CIRCUITS

by

CARL JESUS MARTINEZ

B. S., Kansas State College
of Agriculture and Applied Science, 1932

A THESIS

submitted in partial fulfillment of the

requirements for the degree of

MASTER OF SCIENCE

KANSAS STATE COLLEGE
OF AGRICULTURE AND APPLIED SCIENCE

1933

TABLE OF CONTENTS

	Page
INTRODUCTION	3
THEORY	4
CONSTRUCTION OF APPARATUS	24
RESULTS AND CONCLUSIONS	31
ACKNOWLEDGMENT	60
BIBLIOGRAPHY	61

INTRODUCTION

In a previous experiment conducted by Professor Leo E. Hudiburg, (4) it was determined that frequency modulation was produced by varying the capacity of the oscillating circuit at audio-frequency, which in turn varied the natural frequency of the circuit. In a later experiment by Hoyt, (1932) M.S. (3) the quality of frequency modulation produced by this method, and the factors affecting it were determined. Hoyt found three factors which might cause distortion of the current in the receiving circuit that is produced by frequency modulation in the transmitter. First,

from the equation $f = \frac{1}{2\pi} \sqrt{\frac{1}{LC}}$ it is evident that the

frequency f is not directly proportional to the capacity C . Therefore, if C varies sinusoidally it does not necessarily follow that f will do so. Second, the edge capacity effect of the plates of the sinusoidal variable condenser might cause distortion of the sinusoidal capacity variation. Third, some distortion will result if reception is not on the straight portion of the resonance curve.

In his experiment, Hoyt had a sinusoidal variable condenser in the transmitter, but not in the receiver. It is the purpose of this thesis to determine if resonance may be

obtained in a receiver having a sinusoidal variable condenser in synchronism with a sinusoidal variable condenser in the transmitter.

THEORY

The sinusoidal variation of capacity was obtained by the special design of a condenser. The sinusoidal capacity variation depends on the area of coincidence between two geometrical figures in parallel planes when one is projected upon the other.

In this work the rotor consists of a metal plate with ($P = 8$) teeth which have radial edges projecting outward from a circle of radius r , to a circle of radius R , Plate I. The angular width of each tooth is π/P radians. The stator consists of ($P = 8$) petal shaped plates placed on an insulating plate in a circle of radius R , Plate II. The design of the petal shaped plates is governed by the following equations. (Fig. 1, Fig. 2, Plate III).

*PLATE I**Sinusoidal Variable Condenser**Rotor*

PLATE II

Sinusoidal Variable Condenser*Stator*

Plate III

PLATE III

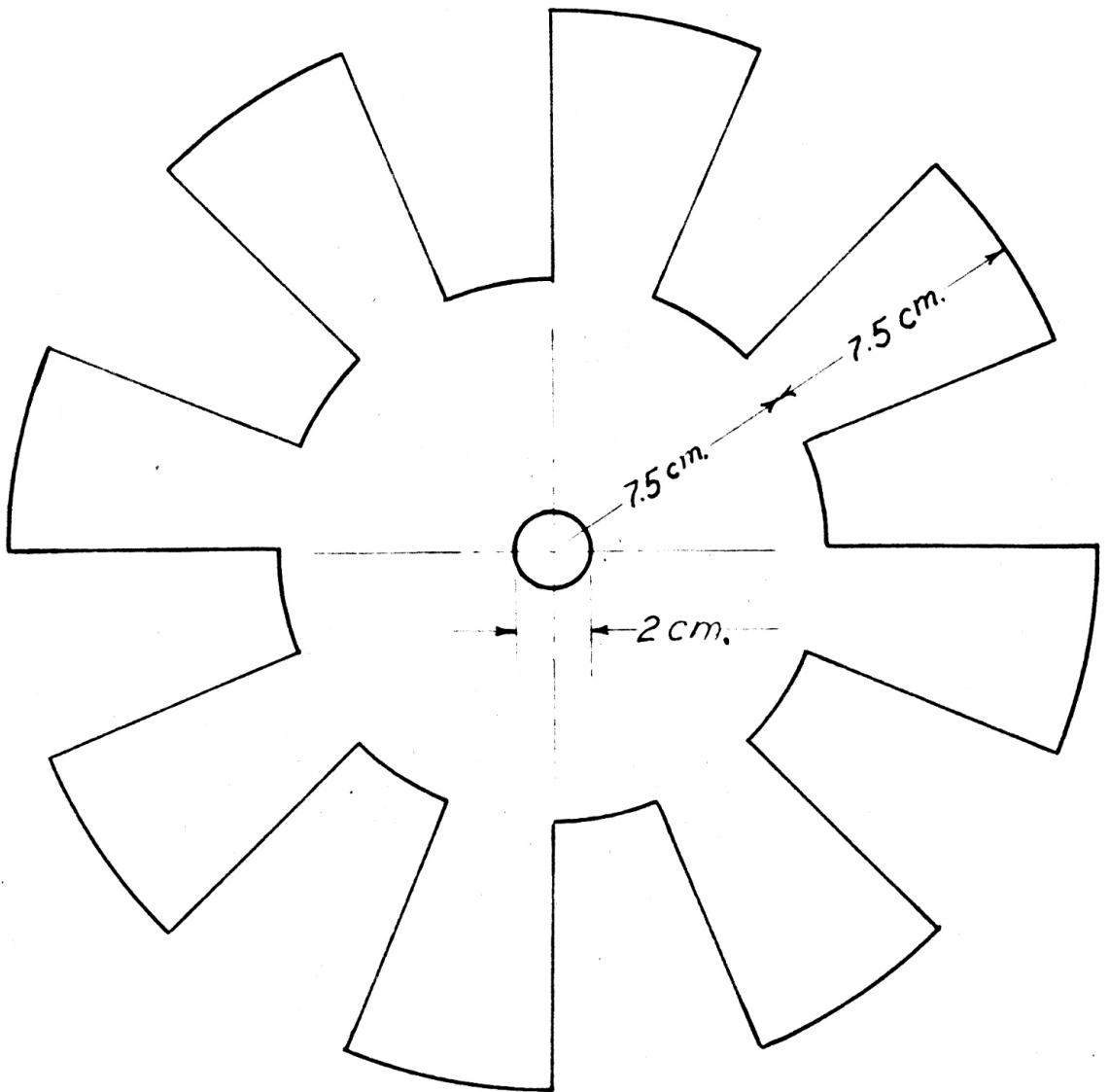
Fig. 1 and Fig. 2. Theoretical development of sinusoidal variation of capacitance by superimposing two geometrical plane figures in parallel planes.

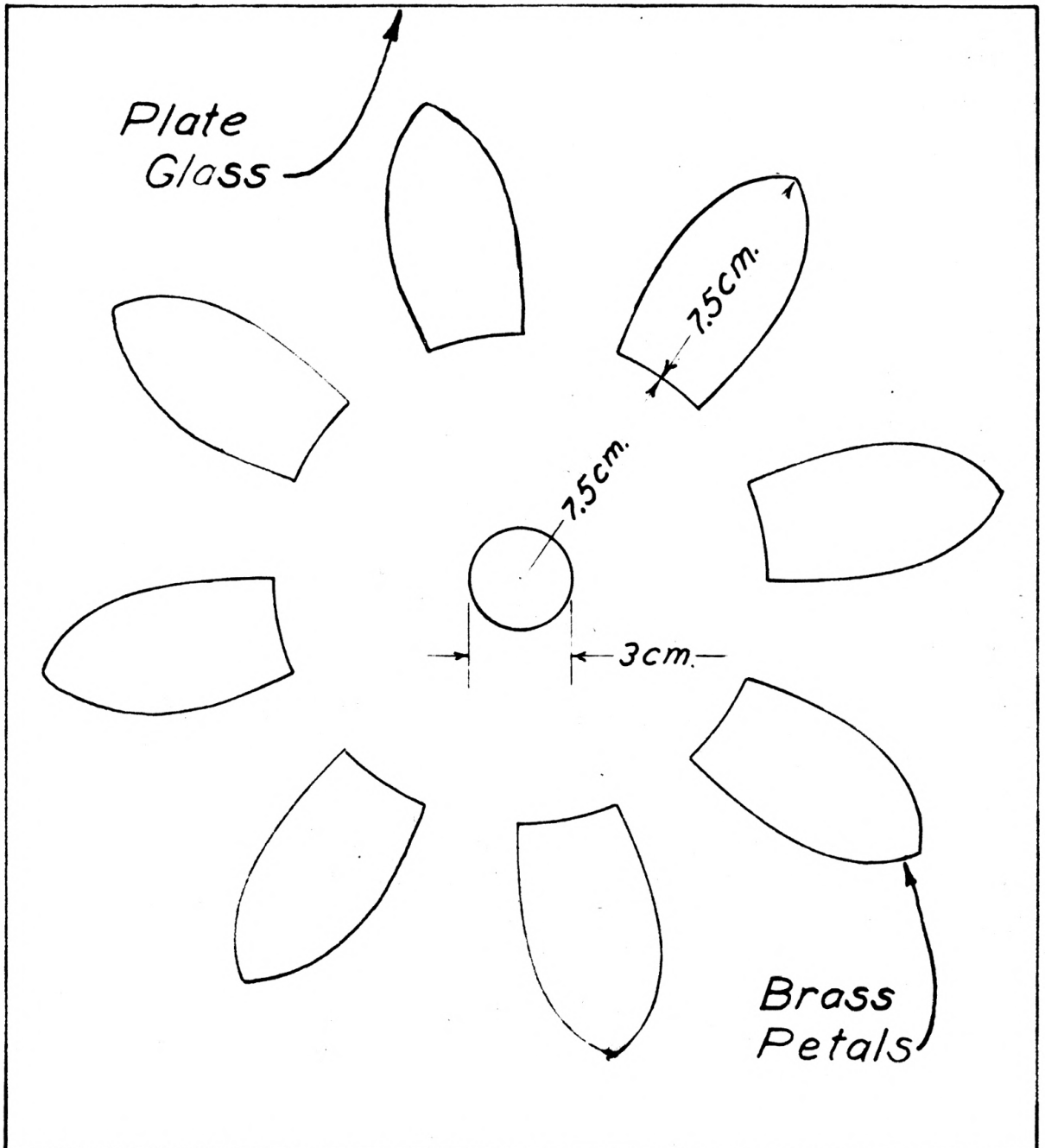
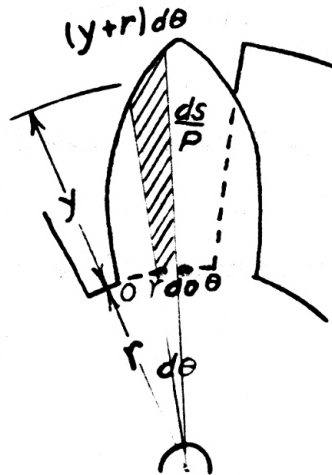

Fig. 1

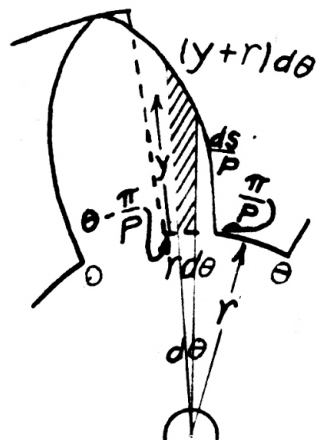

Fig. 2

$$\frac{ds}{P} = \frac{1}{2} (r+y)^2 d\theta - \frac{1}{2} (r^2 d\theta)$$

$$\frac{ds}{P} = ryd\theta + \frac{1}{2} y^2 d\theta \quad d\theta = \frac{dx}{r}$$

$$ds = P \left(y + \frac{y^2}{2r} \right) dx \quad - 1 -$$

where s is intended to represent the area of coincidence of the eight stator teeth with the eight rotor teeth. A detailed explanation of the above theory may be found in a paper by Professor Eric R. Lyon, (5).

Because of the variable surface s of coincidence between the teeth, the device is a variable condenser. Also it has a certain amount of fixed capacity that is in parallel with its variable capacity. Therefore, its capacity C may be expressed as a function of time by the following equation.

$$C = A + B \cos wt \quad - 2 -$$

where A and B are constants.

A practical application of this sinusoidal variable condenser will now be considered, namely when it is placed in the oscillator circuit of a receiver. The circuit diagram for this condition is represented by (Fig. 3, Plate IV.)

Plate IV

PLATE IV

Fig. 3. Circuit diagram showing a practical application of a sinusoidal variable condenser in a Hartley oscillator.

Fig. 4. Digramatic representation of a frequency modulated wave train.

Fig. 5. Resonance curves showing the variation of frequency with variation of capacitance.

PLATE IV

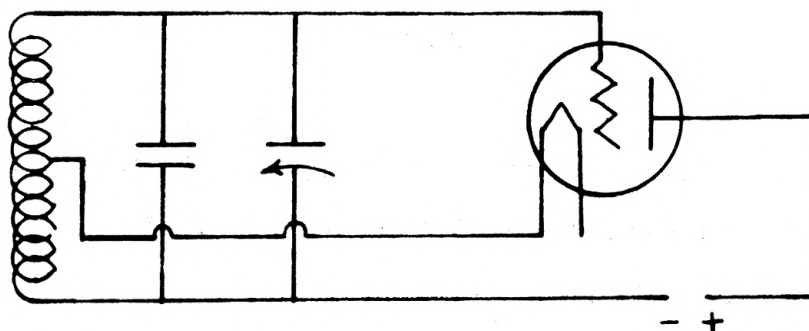

Fig. 3

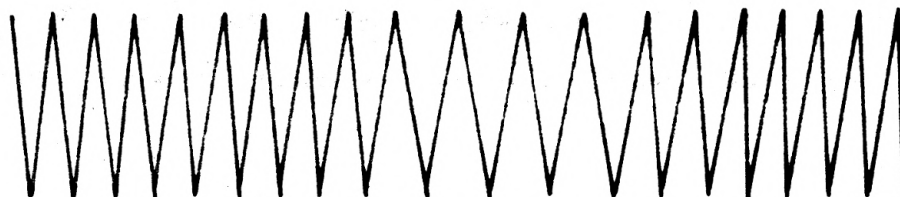

Fig. 4

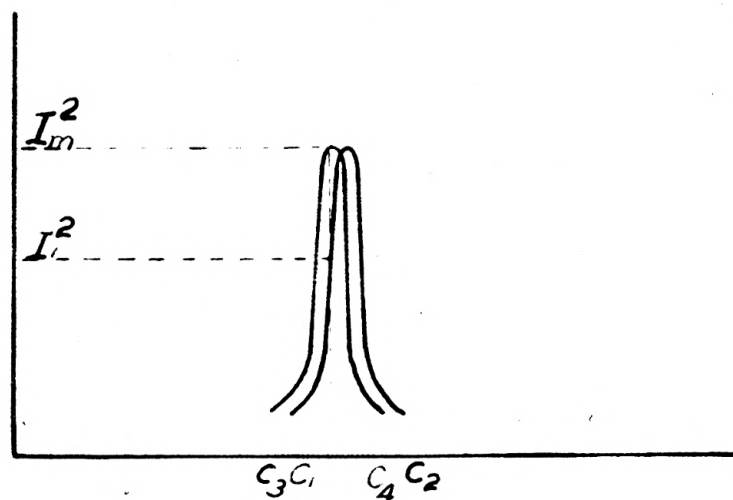

Fig. 5

The natural or free oscillation frequency of a circuit containing constant resistance, constant capacitance, and constant inductance in series is

$$f = \frac{1}{2\pi} \sqrt{\frac{1}{LC} - \frac{r^2}{4L^2}} = \frac{1}{2\pi} \sqrt{\frac{1 - \frac{r^2 C}{4L}}{LC}} \quad - 3 -$$

When \underline{r} is small compared with $\frac{2L}{C}$, equation - 3 - reduces to

$$f = \frac{1}{2\pi \sqrt{LC}} \quad - 4 -$$

The above conditions are taken from Lawrence's "Principles of Alternating Current" Page 208.

When a circuit containing constant resistance, constant capacitance and constant inductance in series, is in resonance, the capacitive reactance is equal to the inductive reactance. Consider a circuit containing a resistance \underline{r} , a capacitance C, and an inductance L in series.

$$I = \frac{E}{\sqrt{r^2 + \left(2\pi fL - \frac{1}{2\pi fC}\right)^2}} \quad - 5 -$$

For resonance $2\pi fL = \frac{1}{2\pi fC}$. From this equation the resonant frequency \underline{f} is

$$f = \frac{1}{2\pi \sqrt{LC}} \quad - 6 -$$

By equations -6- and -4-, the resonant frequency of a series circuit which has low resistance, compared with the ratio of its inductance and capacitance, is practically the same as its free oscillation frequency. Since its free oscillation frequency depends upon the product of L and C, governed by the conditions of equation -4-, it follows that the resonant frequency will vary as C is varied. This will result in a shifting of the resonance curve corresponding to every change of value of capacitance. In Fig. 5, Plate IV, the resonance curve a represents the behavior of the circuit under constant conditions. It is seen that any change in natural frequency, produced by a capacity change, will cause a shift in the resonance curve, as shown by curve b.

It can be shown that the current in a receiving set tuned to a transmitter oscillating at constant frequency, will vary as the frequency of the transmitter changes. Let curve a, Fig. 5, Plate IV, represent the resonance curve of the transmitter at constant frequency. Then I_m^2 is the current of the receiver tuned to the transmitter. Now if the natural frequency of the transmitter changes the resonance curve will shift. The new resonance curve will be represented by curve b. The receiving set however is still tuned to curve a, therefore its current will change to I_1^2 .

We will now consider the sinusoidal capacity variation,

and the resulting frequency variation. Differentiating equation -2- with respect to time,

$$\frac{dc}{dt} = -2\pi f \sin 2\pi ft \quad - 7 -$$

By equations -2- and -4-

$$f = \frac{1}{2\pi \sqrt{LA + LB \cos 2\pi nt}} \quad - 8 -$$

if $\frac{n}{f_0}$ is very small, where n is the audio-frequency, f_0 is the resonant frequency. The resulting frequency variation is found by differentiating equation -8- with respect to time.

$$\frac{df}{dt} = \frac{nLB \sin 2\pi nt}{(LA + LB \cos 2\pi nt)^{3/2}}$$

since $\frac{B}{A}$ is very small,

$$(LA + LB \cos 2\pi nt)^{3/2} = (LA)^{3/2}, \text{ approximately}$$

$$\text{but } f_0 = \frac{1}{2\pi \sqrt{LA}} .$$

Therefore, approximately,

$$\frac{df}{dt} = f_0 = \frac{2\pi nA \sin 2\pi nt}{B} \quad - 9 -$$

The final wave train is represented by Fig. 4, Plate IV, as a cyclical and periodically progressing system of alternations of the radio frequency.

The resulting variation of the current in the receiving set that is coupled with the modulated frequency transmitter may be determined as follows:

$$I = \frac{E}{Z}, \text{ where } Z = \sqrt{R^2 + \left(2\pi fL - \frac{1}{2\pi fC}\right)^2}$$

$$I^2 = \frac{E^2}{Z^2}$$

$$I^2 = \frac{E^2}{R^2 + \left(2\pi fL - \frac{1}{2\pi fC}\right)^2} \quad - 10 -$$

Differentiating equation -10- with respect to f .

$$\frac{dI^2}{df} = - \frac{E^2 \left(2 \left(2\pi fL - \frac{1}{2\pi fC}\right)\right) \left(2\pi L + \frac{1}{2\pi f^2 C}\right)}{\left\{R^2 + \left(2\pi fL - \frac{1}{2\pi fC}\right)^2\right\}^2} \quad - 11 -$$

We will now consider a circuit having constant inductance and constant resistance, but having a sinusoidal variation of capacity. The equation representing this condition is as follows:

$$L \frac{d^2q}{dt^2} + R \frac{dq}{dt} + \frac{q}{C\{1 + S \cos w(t_0+t)\}} = E \quad - 12 -$$

in which $S < 1$.

Equation -12- may be written in the form,

$$\frac{d^2q}{dt^2} + \frac{R}{L} \frac{dq}{dt} + \frac{q (\phi^1(t))^2}{LC} = \frac{E}{L} \quad - 13 -$$

The solutions of equations -12- and -13- will approximate the solution of the following equation:

$$\frac{d^2q}{dt^2} + \frac{R}{L} \frac{dq}{dt} + \frac{q}{LC (1 + S \cos wt_0)} = \frac{E}{L} \quad - 14 -$$

Since the oscillations are to be sustained, we may assume, for the solution of equation -14-:

$$q = Q \cos (\rho t + \theta) \quad - 15 -$$

$$\frac{dq}{dt} = i = -\rho Q \sin (\rho t + \theta) = -I \sin (\rho t + \theta) \quad - 16 -$$

$$\frac{d^2q}{dt^2} = \frac{di}{dt} = -\rho^2 Q \cos (\rho t + \theta) = -\rho^2 q \quad - 17 -$$

Substituting equations -15-, -16- and -17- in equation -14- we have

$$\begin{aligned} & -\rho^2 Q \cos (\rho t + \theta) - \frac{\rho QR}{L} \sin (\rho t + \theta) \\ & + \frac{Q \cos (\rho t + \theta)}{LC (1 + S \cos wt_0)} = \frac{E}{L} \end{aligned} \quad - 18 -$$

which is satisfied by

$$\rho = \frac{1}{\sqrt{LC} \sqrt{1 + S \cos wt_0}} \quad - 19 -$$

$$E = Ri = -wRQ \sin (\rho t + \theta) \quad - 20 -$$

$$\text{Now let } \rho t = \frac{\phi(t)}{\sqrt{LC}} \quad - 21 -$$

$$\text{where } \phi(t) = \int_0^t \frac{dt}{\sqrt{1 + S \cos w(t_0 + t)}} \quad - 22 -$$

Expanding equation -22-, we have

$$\int_0^t \frac{dt}{\sqrt{1 + S \cos w(t_0 + t)}} = \frac{t}{\sqrt{1 + S \cos wt_0}} \left\{ 1 + \frac{wSt}{4} \left(\frac{\sin wt_0}{1+S \cos wt_0} \right) - \frac{w^2St^2}{8} \left(\frac{\cos wt_0}{3(1+S \cos wt_0)} - \frac{S+\cos wt_0}{(1+S \cos wt_0)^2} \right) - \frac{w^3St^3}{16} \left(\frac{\sin wt_0}{12(1+S \cos wt_0)} - \frac{\sin wt_0}{(1+S \cos wt_0)^2} + \frac{5(1-S^2) \sin wt_0}{4(1+S \cos wt_0)^3} \right) + \dots \right\} \quad - 23 -$$

The above expansion will be limited to the following conditions.

$$w = 2\pi f \quad \text{and} \quad \rho = 2\pi n$$

f = radio frequency

n = audio frequency

$$\frac{t}{t_0} = 10^{-3}$$

$$\rho t = 10^{-3}$$

$$\frac{w}{\rho} = 10^{-3}$$

$$wSt = 10^{-4} \text{ when } S = \frac{1}{30} \quad - 24 -$$

$$wSt = 10^{-5} \text{ when } S = \frac{1}{240} \quad - 25 -$$

With 8 petals of the sinusoidal variable condenser in action, $S = \frac{1}{30}$. With one petal in action, $S = \frac{1}{240}$.

The ideal case for this work would be when $S = .001$.

$$wSt = 10^{-5} \text{ to } 10^{-6} \text{ when } S = .001. \quad - 26 -$$

Under these conditions $\phi(t)$ reduces to the following:

$$\phi(t) = \frac{t}{\sqrt{1+S \cos wt_0}} \frac{t^2}{4} \left\{ \frac{wS \sin wt_0}{(1+S \cos wt_0)^{3/2}} \right\} \quad - 27 -$$

with a degree of approximation of 1 ± 10^{-7} .

Substituting equation -21- in equation -15- we may write

$$q = Q \cos \left(\frac{\phi t}{\sqrt{LC}} + \theta \right) \quad - 28 -$$

where Q and θ are assumed to be constant.

Differentiating, we have

$$\frac{dq}{dt} = i = - \frac{\phi' t}{\sqrt{LC}} Q \sin \left(\frac{\phi t}{\sqrt{LC}} + \theta \right) \quad - 29 -$$

$$\begin{aligned} \frac{d^2q}{dt^2} = \frac{di}{dt} = & \left\{ - \frac{\phi''(t)}{\sqrt{LC}} Q \sin \left(\frac{\phi(t)}{\sqrt{LC}} + \theta \right) \right\} \\ & - \left\{ \left(\frac{\phi'(t)}{\sqrt{LC}} \right)^2 Q \cos \left(\frac{\phi(t)}{\sqrt{LC}} + \theta \right) \right\} \quad - 30 - \end{aligned}$$

Substituting equations -28-, -29- and -30- in equation -13-, we have

$$E = - \frac{\phi''(t)}{\sqrt{LC}} \left\{ Q \sin \left(\frac{\phi t}{\sqrt{LC}} + \theta \right) - \frac{\phi'(t)}{\sqrt{LC}} RQ \sin \left(\frac{\phi t}{\sqrt{LC}} + \theta \right) \right\} \quad - 31 -$$

$$\text{Since } \omega t = \frac{\phi t}{\sqrt{LC}}, \quad - 32 -$$

$$\omega = \frac{1}{\sqrt{LC} \sqrt{1+S \cos \omega t_0}} + \frac{\omega S \sin \omega t_0}{\sqrt{LC} (1+S \cos \omega t_0)^{3/2}} \quad - 33 -$$

Then,

$$E = - \frac{1}{2} \sqrt{\frac{L}{C}} \left(\frac{\omega S \sin \omega t_0}{(1+S \cos \omega t_0)^{3/2}} \right) Q \sin \left(\frac{\phi(t)}{\sqrt{LC}} + \theta \right) - \left(\frac{1}{\sqrt{LC} \sqrt{1+S \cos \omega t_0}} + \frac{\omega}{2} \frac{\omega S \sin \omega t_0}{\sqrt{LC} (1+S \cos \omega t_0)^{3/2}} \right) RQ \sin \left(\frac{\phi t}{\sqrt{LC}} + \theta \right) \quad - 34 -$$

Assuming Q to be constant, E must satisfy equation -34-. It is, however, very desirable that I should be constant, and easier to obtain.

Let $\underline{\omega t}$ be defined by equation -32-, and let I be constant.

$$i = \frac{dq}{dt} = I \sin \left(\frac{\phi t}{\sqrt{LC}} + \theta \right) \quad - 35 -$$

$$\frac{di}{dt} = \frac{d^2q}{dt^2} = \frac{\phi'(t)}{\sqrt{LC}} I \cos \left(\frac{\phi(t)}{\sqrt{LC}} + \theta \right) \quad - 36 -$$

$$q = \int idt = - \frac{\sqrt{LC}}{\phi'(t)} I \cos \left(\frac{\phi t}{\sqrt{LC}} + \theta \right) \\ - \frac{\phi''(t)LC}{(\phi't)^3} I \sin \left(\frac{\phi t}{\sqrt{LC}} + \theta \right) \quad - 37 -$$

in which the I sine term is of the magnitude of 10^{-4} to 10^{-6} of the I cosine term. The subsequent terms in the series may be neglected, as their magnitude is small.

Substituting equations -35-, -36- and -37- in equation -13-, we have

$$E = RI \sin \left(\frac{\phi t}{\sqrt{LC}} + \theta \right) - \frac{\phi''(t)}{\phi'(t)} LI \sin \left(\frac{\phi t}{\sqrt{LC}} + \theta \right) \dots \quad - 38 -$$

Expanding $\frac{\phi''(t)}{\phi'(t)}$ in a manner similar to that of equation

-23-, we have

$$\frac{\phi''(t)}{\phi'(t)} = \frac{wS}{2} \left\{ \left(1 + \frac{S^2}{4} + \frac{S^4}{8} \pm \dots \right) \sin wt_0 \right. \\ \left. - \frac{S}{2} \left(1 - \frac{S^2}{2} \pm \dots \right) \sin 2wt \right\} \quad - 39 -$$

Substituting in equation -38-, we have

$$E = RI \sin \left(\frac{\phi t}{\sqrt{LC}} + \theta \right) - \left\{ \frac{wS}{2} LI \sin \left(\frac{\phi t}{\sqrt{LC}} + \theta \right) \right\}$$

$$\left\{ \left(1 + \frac{S^2}{4} + \frac{S^4}{8} \pm \dots \right) \sin wt_0 - \frac{S}{2} \left(1 - \frac{S^2}{2} \pm \dots \right) \sin 2wt_0 \right\}$$

- 40 -

The magnitude of wS is 10^2 when $S = \frac{1}{30}$, and is one when $S = 0.001$. Therefore, the magnitude of the series term in equation -40- is 10^{-3} when $S = \frac{1}{30}$, and is 10^{-5} when $S = 0.001$. The harmonic part of the series has a smaller magnitude. Therefore, when I is a constant amplitude of current,

$$E = RI \sin \left(\frac{\phi t}{\sqrt{LC}} + \theta \right) - \frac{wS}{2} (\sin wt_0)$$

$$LI \sin \left(\frac{\phi t}{\sqrt{LC}} + \theta \right) \pm \dots$$

- 41 -

Since the last terms are of small magnitude, we may write

$$E = RI \sin \left(\frac{\phi t}{\sqrt{LC}} + \theta \right)$$

- 42 -

Substituting the value of ϕt , equation -27-, and neglecting the latter part, we have

$$E = RI \sin \left(\frac{t}{\sqrt{LC} \sqrt{1+S \cos wt_0}} + \theta \right)$$

- 43 -

Consider the resonant current reception of frequency modulated waves in a receiver whose capacitance is at all times varying in synchronism with the capacitance of the transmitter. The received e.m.f. may be expressed as

follows:

$$E = M \frac{di}{dt} = I \rho M \cos (\rho t + \theta)$$

$$E = \frac{MI \cos (\rho t + \theta)}{\sqrt{LC} \sqrt{1+S \cos w(t_0+t)}} = \frac{E \cos (\rho t + \theta)}{\sqrt{1+S \cos w(t_0+t)}}$$

- 44 -

Since the receiver has a duplicate rotating condenser in synchronism with the condenser of the transmitter, w , t_0 and t are the same for the transmitter and receiver. Therefore equation -12- may now be expressed for the resonant receiver as follows:

$$L \frac{d^2q}{dt^2} + R \frac{dq}{dt} + \frac{q}{C\{1+S \cos w(t_0+t)\}} = \frac{E \cos (\rho t + \theta)}{\sqrt{1+S \cos w(t_0+t)}}$$

- 45 -

The suggested resonant solution of equation -45- is

$$i = \frac{dq}{dt} = \frac{E \cos (\rho t + \theta)}{R \sqrt{1+S \cos w(t_0+t)}} = \frac{I \cos (\rho t + \theta)}{\sqrt{1+S \cos w(t_0+t)}}$$

- 46 -

Equation -46- shows that the instantaneous current received by the receiver will not vary greatly from sinusoidal form, since the variation of the denominator is within narrow limits.

The circuit diagram of the receiving set is shown in Plate V, illustrating also the method of connecting the deflecting plates of the cathode ray oscillograph which was

PLATE V

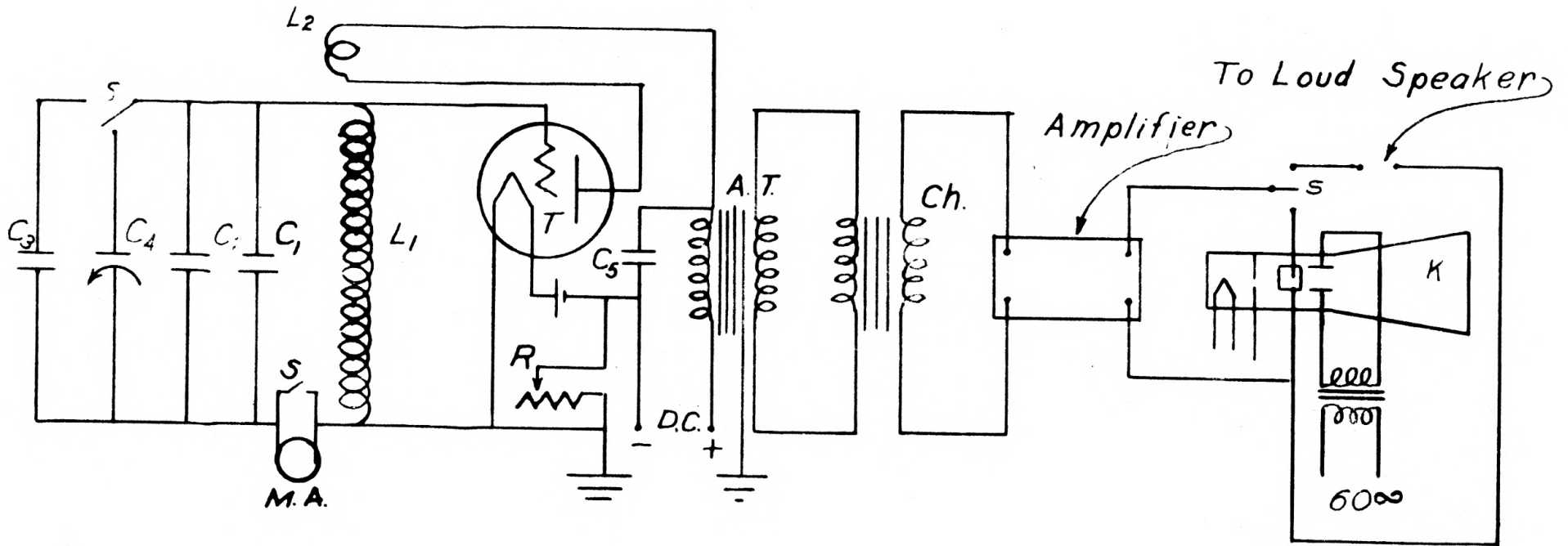

Receiver

used in this investigation. The theory of operation of the cathode ray oscillograph may be found in a paper, "The Cathode Ray Oscillograph" by J. B. Johnson, published in the Bell System Technical Journal, January 1932, Vol. XI, Number 1.

CONSTRUCTION OF APPARATUS

The apparatus used consisted of standard parts belonging to the Department of Physics and some parts which were constructed in the shop.

Transmitter

In the first part of this work a five watt Hartley oscillator was used. However, the results obtained with the Hartley oscillator were not satisfactory. The Hartley oscillator was discarded and a tuned grid oscillator was used. The various parts are listed, corresponding to the letters used in the circuit diagram, Plate VI.

PLATE VI

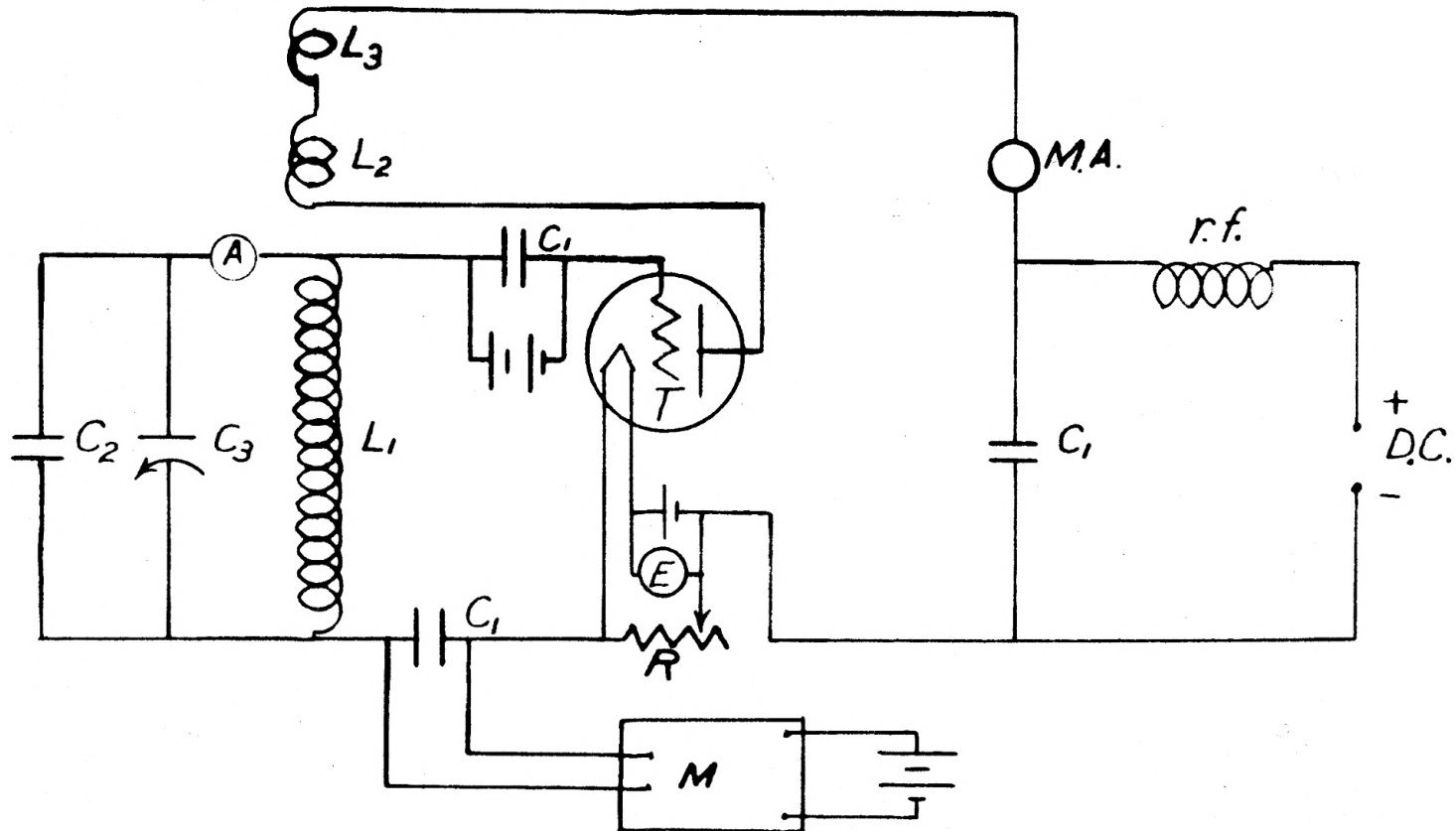

L_1 = Inductance coil, about 92,700 cm.

L_2 = Tickler coil, fixed part about 153,000 cm.

L_3 = Tickler coil, movable part about 57,600 cm.

C_1 = Condensers, .002 μ f, Model U.C. 1014.

C_2 = Standard variable condenser.

C_3 = Sinusoidal variable condenser.

A = Ammeter (0-2.5).

M = Modulating tuning fork, 1000 cycles.

R = Filament rheostat, model R.T. 537 R.C.A.

E = Voltmeter (0-15).

r.f. = About 200 μ h. choke.

M.A. = Microammeter.

T = Tube, Radiotron, Model UV202.

The inductance of the coils was calculated by Nagaoka's formula,

$$L = \frac{4\pi^2 N^2 R^2 K}{l} \text{ cm.}$$

in which

L = inductance in cm.,

R = radius of coil to center of wire,

N = number of turns of windings,

l = length of winding in cm.,

K = constant depending on the ratio of coil diameter
to the coil length $\frac{2R}{L}$.

The values of K have been worked out by H. Nagaoka.
See radio hand book.

Receiver

A Hartley oscillator was first used having the same constants as the Hartley oscillator used as a transmitter. However the Hartley oscillator was found inadequate, due to a critical coupling existing between the transmitter and the receiver. A tuned grid circuit was then employed, matching the circuit used in the receiver. The various parts are listed, corresponding to the letters used in the circuit diagram, Plate V.

C_3 = Compensating condenser.

C_4 = Sinusoidal variable condenser.

C_2, C_3 = Standard variable condensers.

C_5 = Fixed condenser $.001 \mu f$.

L_1 = Inductance coil, about 92,700 cm.

L_2 = Tickler coil, about 118,500 cm.

S = Knife switch.

M.A. = Milliammeter.

R = Filament Rheostat, carbon.

T = Tube, Radiotron, Model UX201A.

A.T. = Audio-frequency transformer.

Ch = Microphone transformer, Model UP414.

K = Cathode ray oscillograph.

The power unit used with the tube is not shown in the diagram.

Sinusoidal Variable Condenser

The rotor of the sinusoidal variable condenser was constructed from a brass plate, cut in a circle of radius ($R = 15$ cm.). Then from a circle of radius, $r = \frac{R}{2} = 7.5$ cm. inscribed on the brass plate, ($P = 8$) apertures were cut, projecting outwards radially to the circle of radius R , thus leaving ($P = 8$) teeth forming the rotor as explained in the theory. The angular width of each tooth or aperture may be calculated as follows. Since there are ($P = 8$) teeth and ($P = 8$) apertures, the angular width in degrees of each tooth or aperture is $22^{\circ}30'$. The rotor is shown on Plate I.

The petals for the stator were cut out of a brass plate, $1/8$ " thick, their shape being governed by the following equation.

$$y = \sqrt{r^2 + 2hr \sin \theta} - r \quad - 47 -$$

It is first necessary however to calculate the value of the constant h in equation -47-. The maximum value of y will be when $\sin \theta = 1$. It is evident the maximum value of y is r . Making these substitutions we may rewrite equation -47-:

PLATE VII

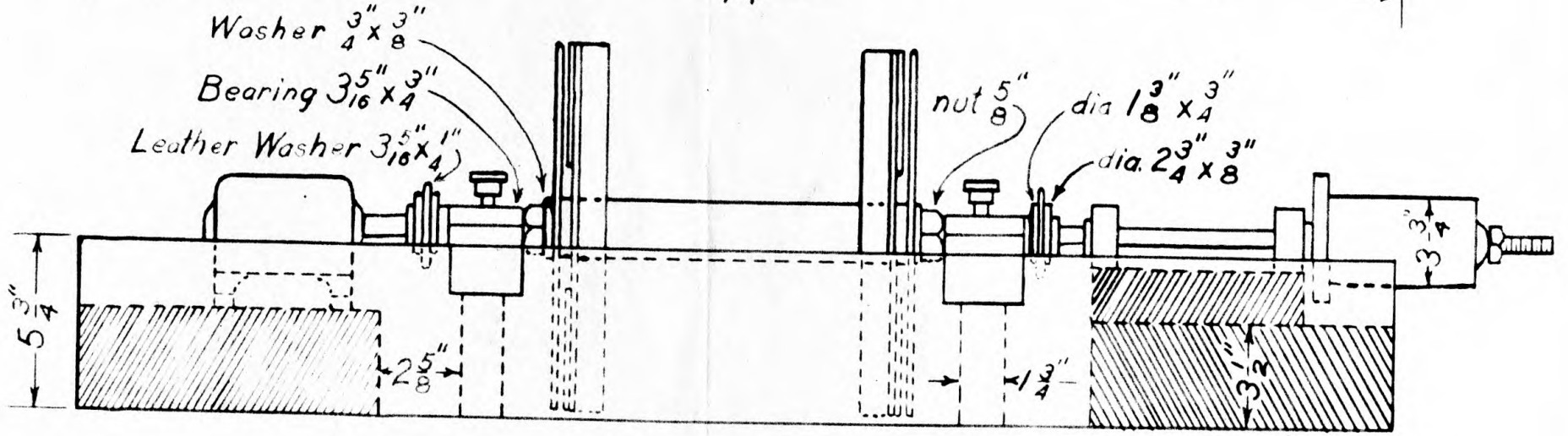
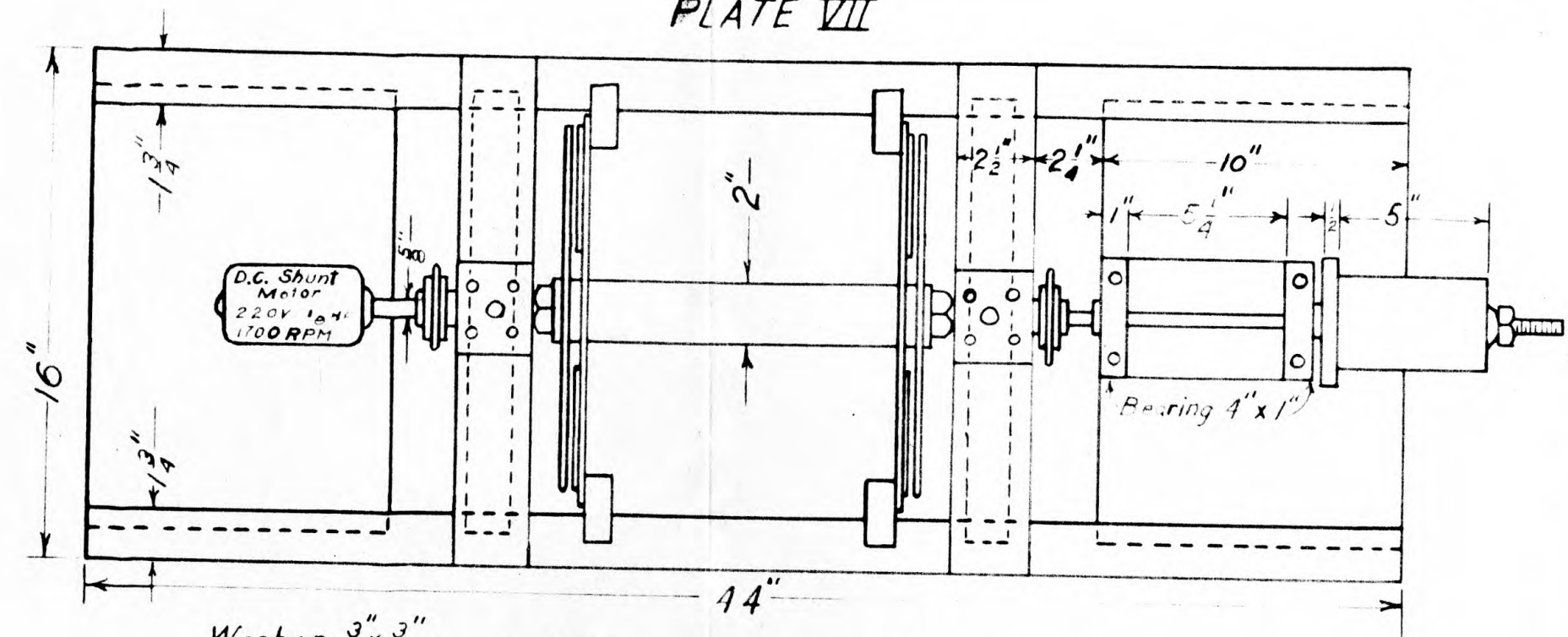

Sinusoidal Variable Condensers

$$r = \sqrt{r^2 + 2hr} - r$$

$$2r = \sqrt{r^2 + 2hr}$$

$$h = \frac{3}{2} r$$

Substituting this value of h in equation -47-

$$y = r \sqrt{1 + 3 \sin^2 \theta} - r$$

Thus we see that the value of y for each degree, from 0° to 22.5° , may be calculated and plotted, giving the shape of the petals as shown on Plate II. It must be remembered that the angular width of each tooth corresponds to 180 electrical degrees.

Rotating Camera

The rotating camera was constructed from a piece of wood turned in the form of a cylinder, five and one-half inches long, and three and three-fourths inches in diameter. At one end there was a flange, one-half inch wide, and projecting one-fourth inch beyond the diameter of the cylinder, making the total diameter four and one-fourth inches at one end. The hole in the central axis of the cylinder was lined with a half-inch brass tube, forming a bearing for a half-inch steel shaft that turned the cylinder. A metal cylindrical cover was made, five and one-half inches long, with a diameter of four and one-fourth inches. With this

cover it was possible to load the cylinder in a dark room and protect it from light with the cover.

The image on the screen of the cathode ray oscillograph was focused on the film with a lens. The cylinder and the lens were enclosed in a dark box, made from beaver board to help exclude light while the picture was being taken.

RESULTS AND CONCLUSIONS

The sinusoidal variable condensers were placed in the oscillator circuit of the transmitter and receiver, with the rotor on the grounded side of the circuit. Electrical connection was made by use of a copper brush on the shaft on which the rotors turned. The petals of the stators were electrically connected by means of binding posts which extended through holes bored in the glass and screwed into the petals, thus serving the double purpose of making electrical connection and of clamping the petals to the plate glass.

The receiving circuit was inductively coupled, by means of coupling coils, with the transmitter. While the rotor of the sinusoidal variable condenser was turning, when the receiving set was tuned to the transmitter, a hum could be heard in the loud speaker. When the rotor was stopped the hum could not be heard, indicating that frequency modulation was produced by the variable condenser.

This was done with a condenser in the receiving set having its capacitance equal to the mean capacitance of the sinusoidal variable condenser. The receiver was provided with a switch allowing a change from the sinusoidal variable condenser to the fixed condenser.

Further indication of frequency modulation was determined by the use of a wavemeter, which was coupled with the transmitter. With the sinusoidal variable condenser at a minimum capacity, a resonance curve (b, Plate VIII) was plotted. Another curve a was plotted with the sinusoidal variable condenser set at a maximum capacity. It is obvious that the maximum change of frequency, due to the maximum change of capacity in the transmitter, is the difference between the resonance frequencies of curves b and a, which is approximately twenty kilocycles per second. With the rotor running, the resonance curves (a, b, c, Plate IX) were obtained at three different speeds of the rotor. It is seen that changing the speed of the rotor does not materially change the resonance curves.

It is quite obvious that, when the receiving set is tuned to the curves of Plate IX, the current varies as the resonance frequency varies from curves a to b, Plate VIII, which corresponds to the theory illustrated by Fig. 5, Plate IV. The above curves were taken with the Hartley circuit.

PLATE VIII

Resonance Curves of Transmitter

- a. Sinusoidal Condenser Maximum
- b. Sinusoidal Condenser Minimum

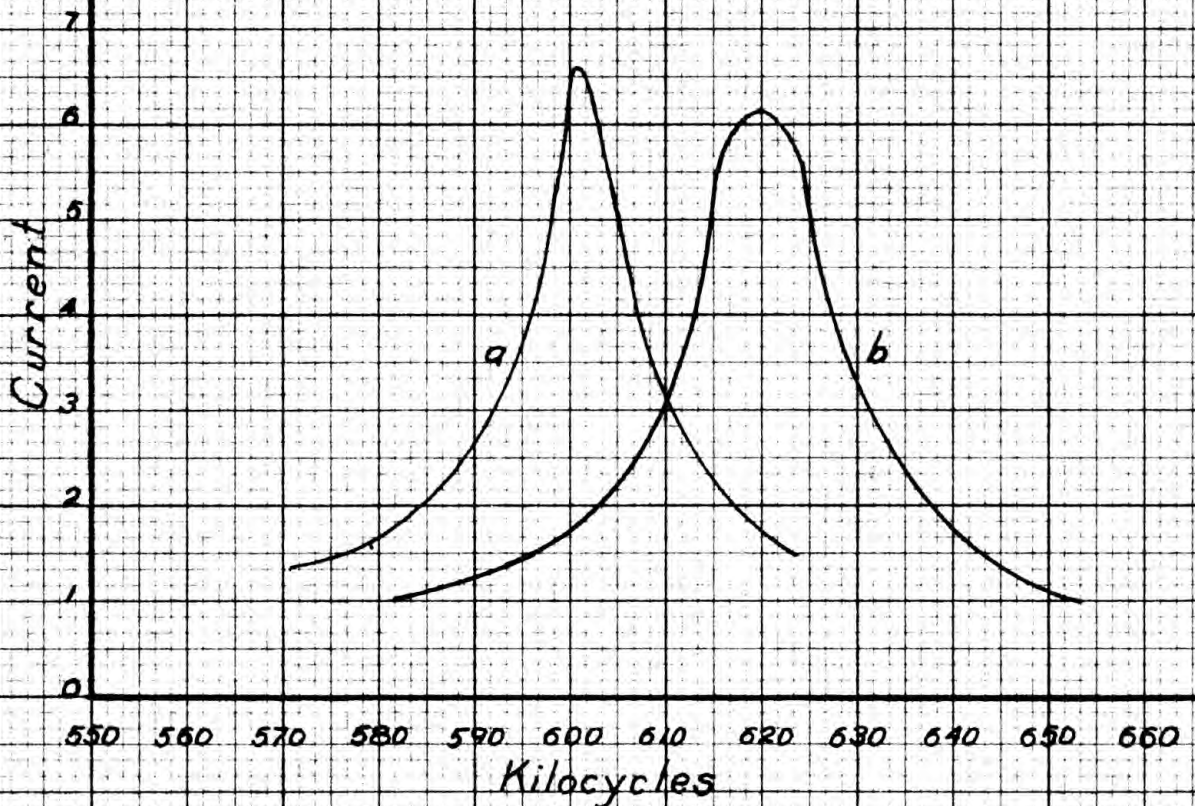

PLATE IX

Resonance Curves of Transmitter
Sinusoidal Condenser Rotating
a. 990 R.P.M.
b. 1247 R.P.M.
c. 1500 R.P.M.

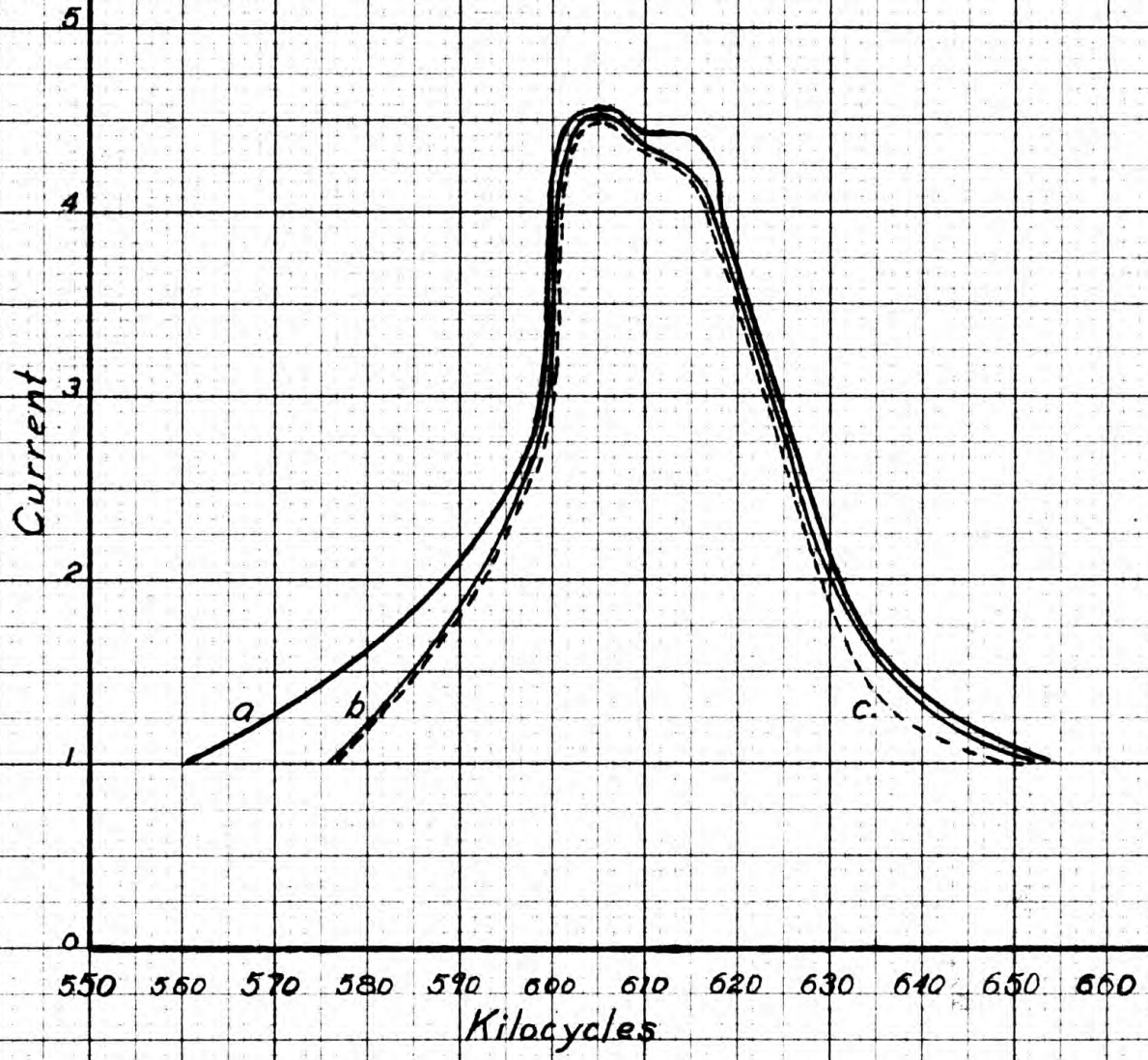

PLATE X

Resonance Curves

- a. Sinusoidal Condenser Maximum
- b. Sinusoidal Condenser Minimum

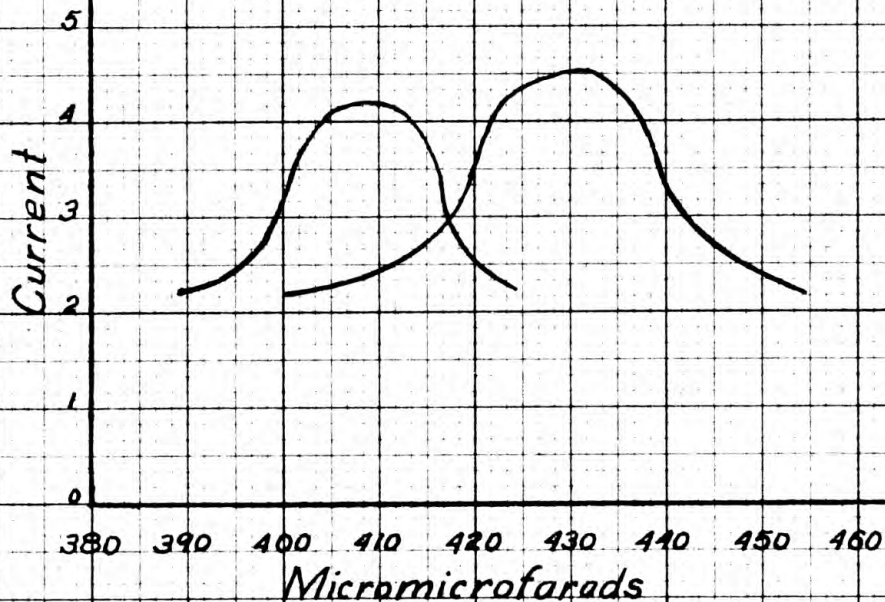

PLATE XI

Resonance Curves

- a. Sinusoidal Condenser In Transmitter.
- b. Sinusoidal Condensers In Transmitter
And Receiver At 1300 R.P.M.
- c. Sinusoidal Condensers AT 1000 R.P.M.

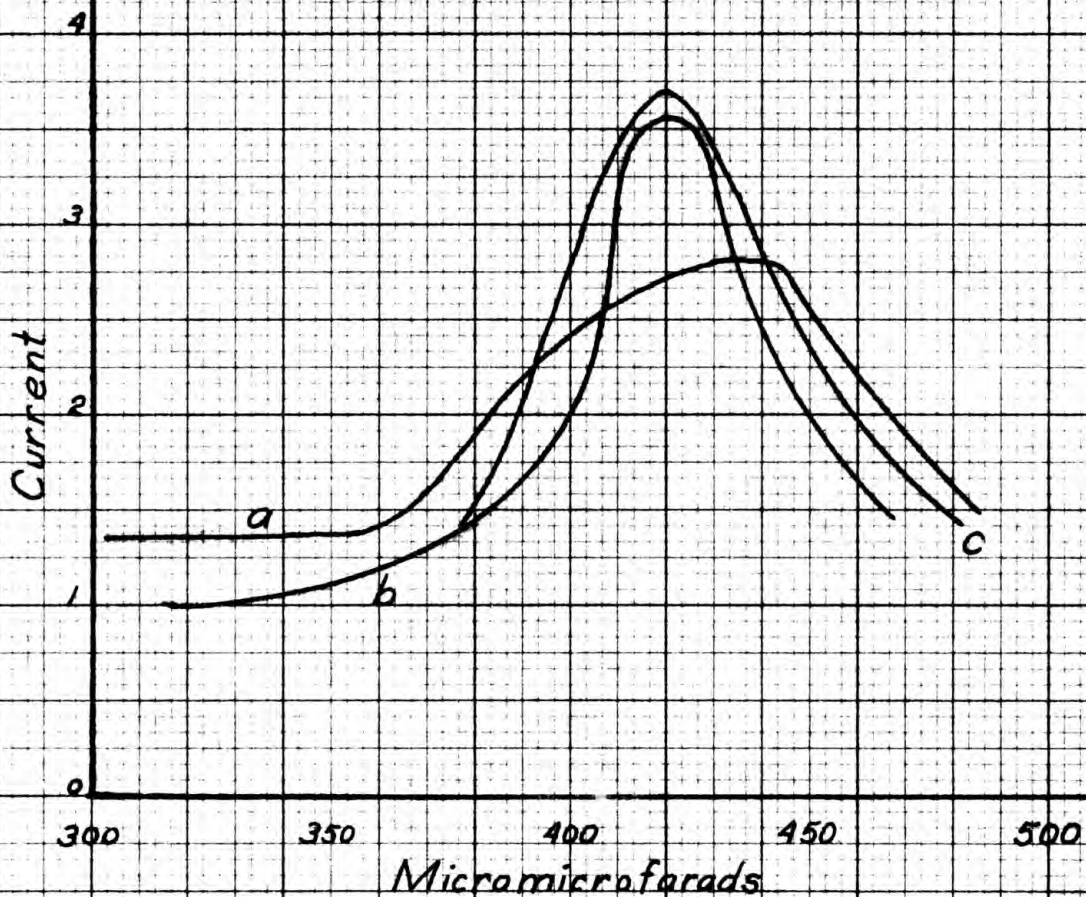

PLATE XII

Capacity Variation

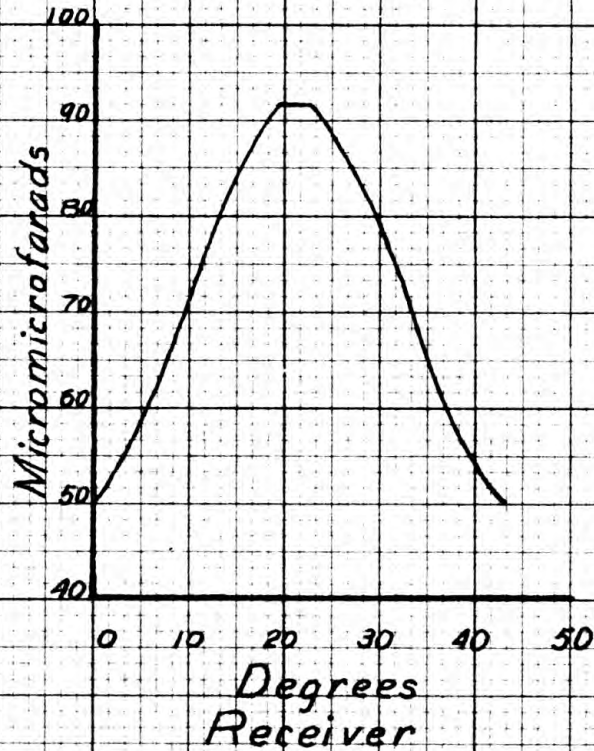
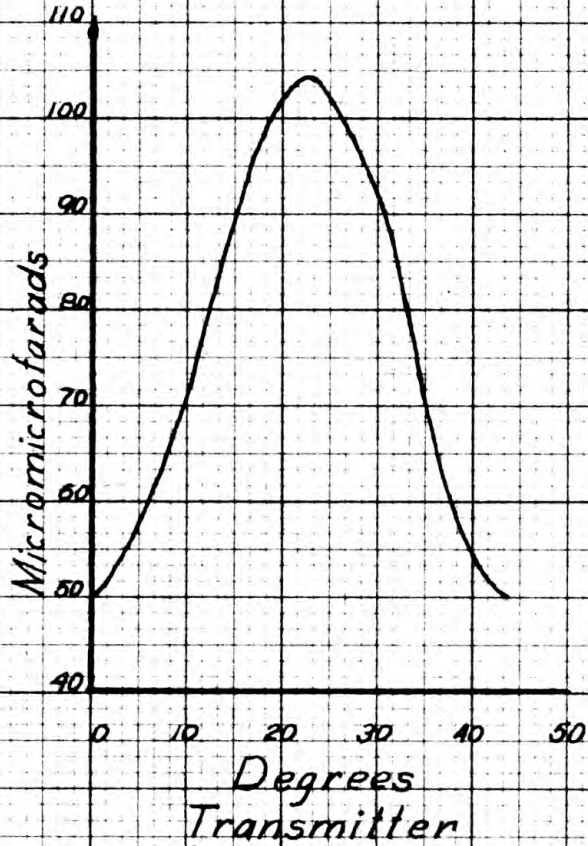

PLATE XIII

Capacity Variation

Negative Half

Variation Of Transmitter
Ideal Variation
Actual

Actual Variation Of Receiver
Ideal Variation

Positive Half

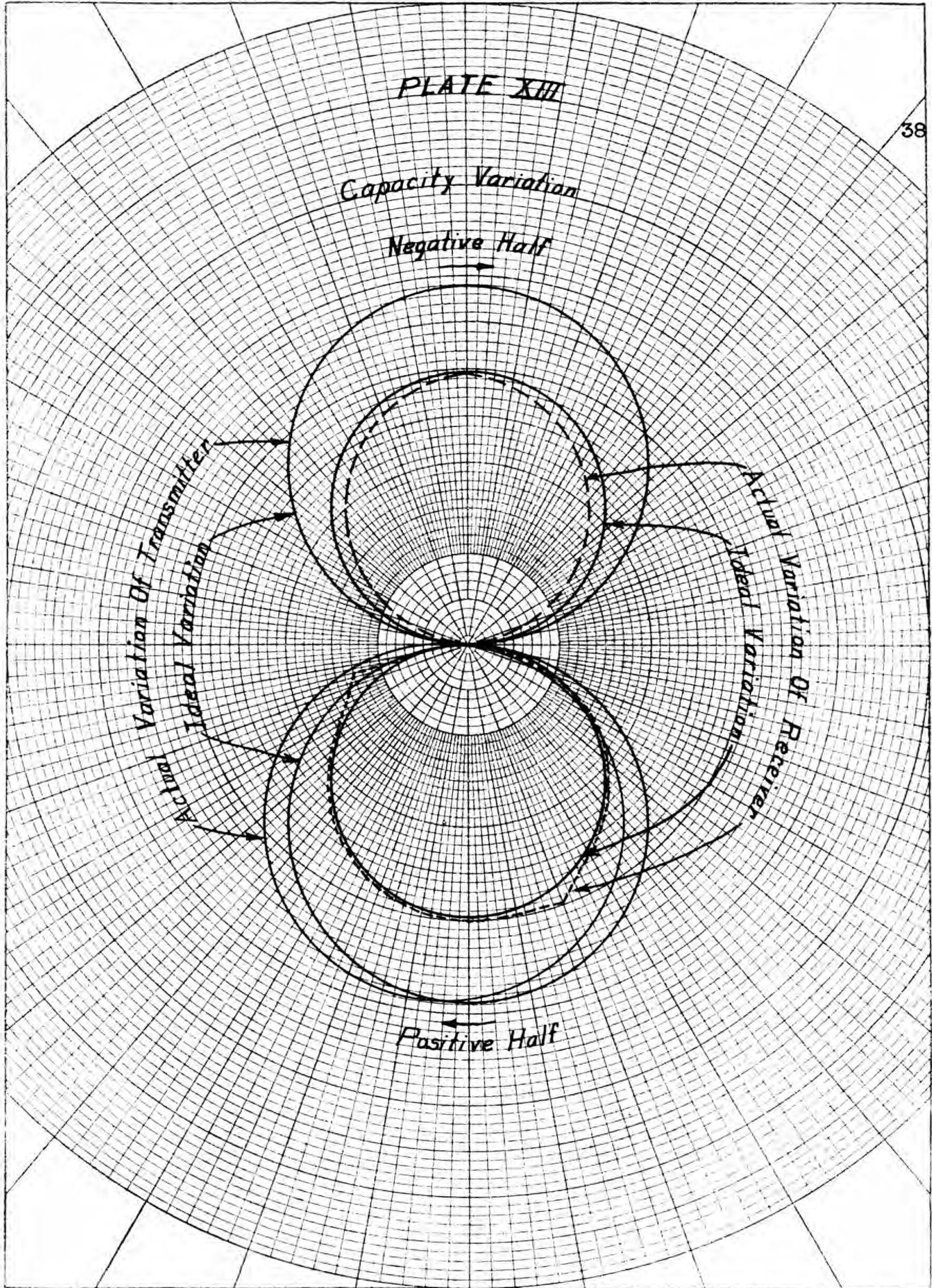

PLATE XIV

Variation Of Current In Tank Coil With Change Of Capacity In Transmitter

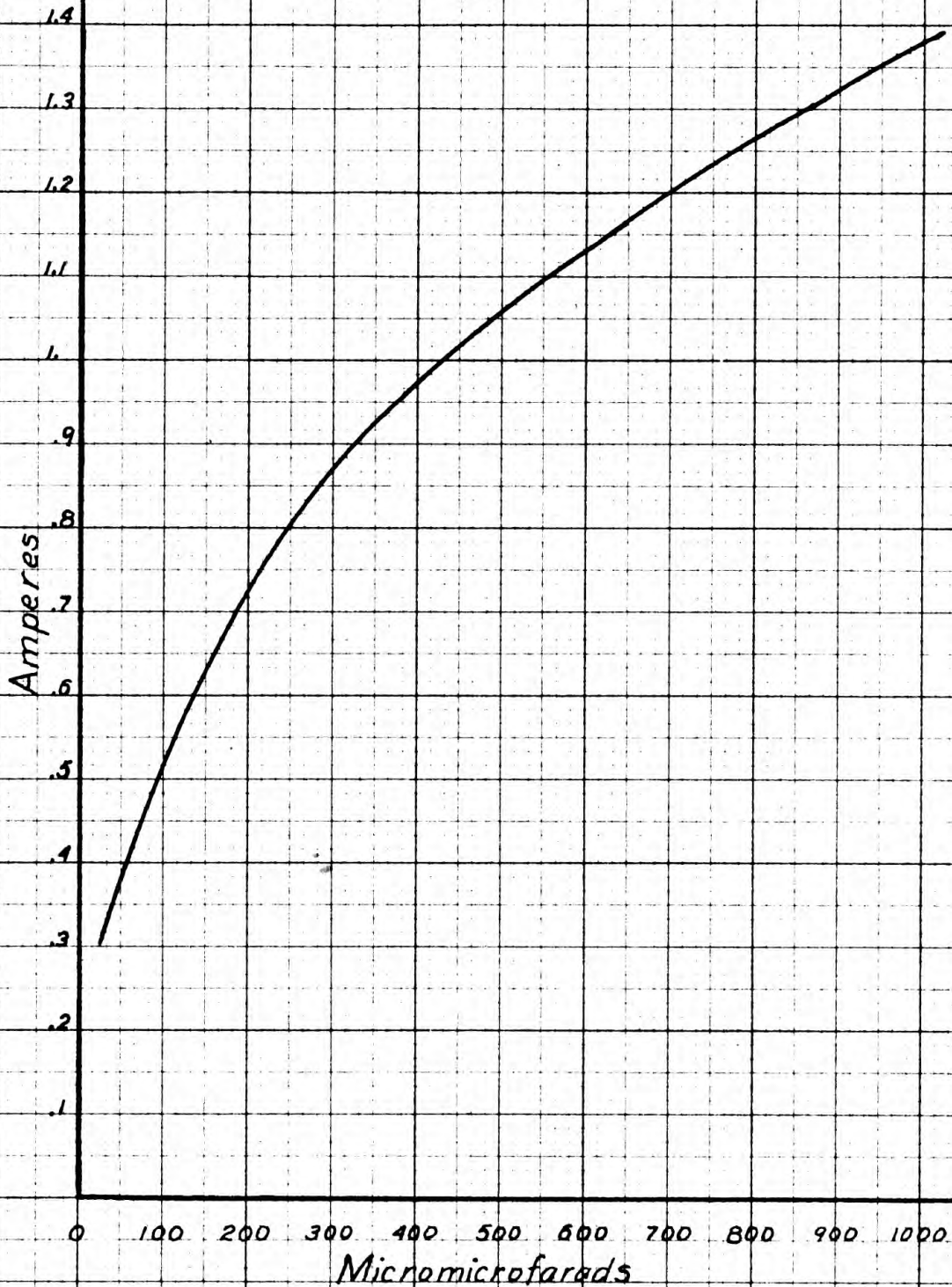
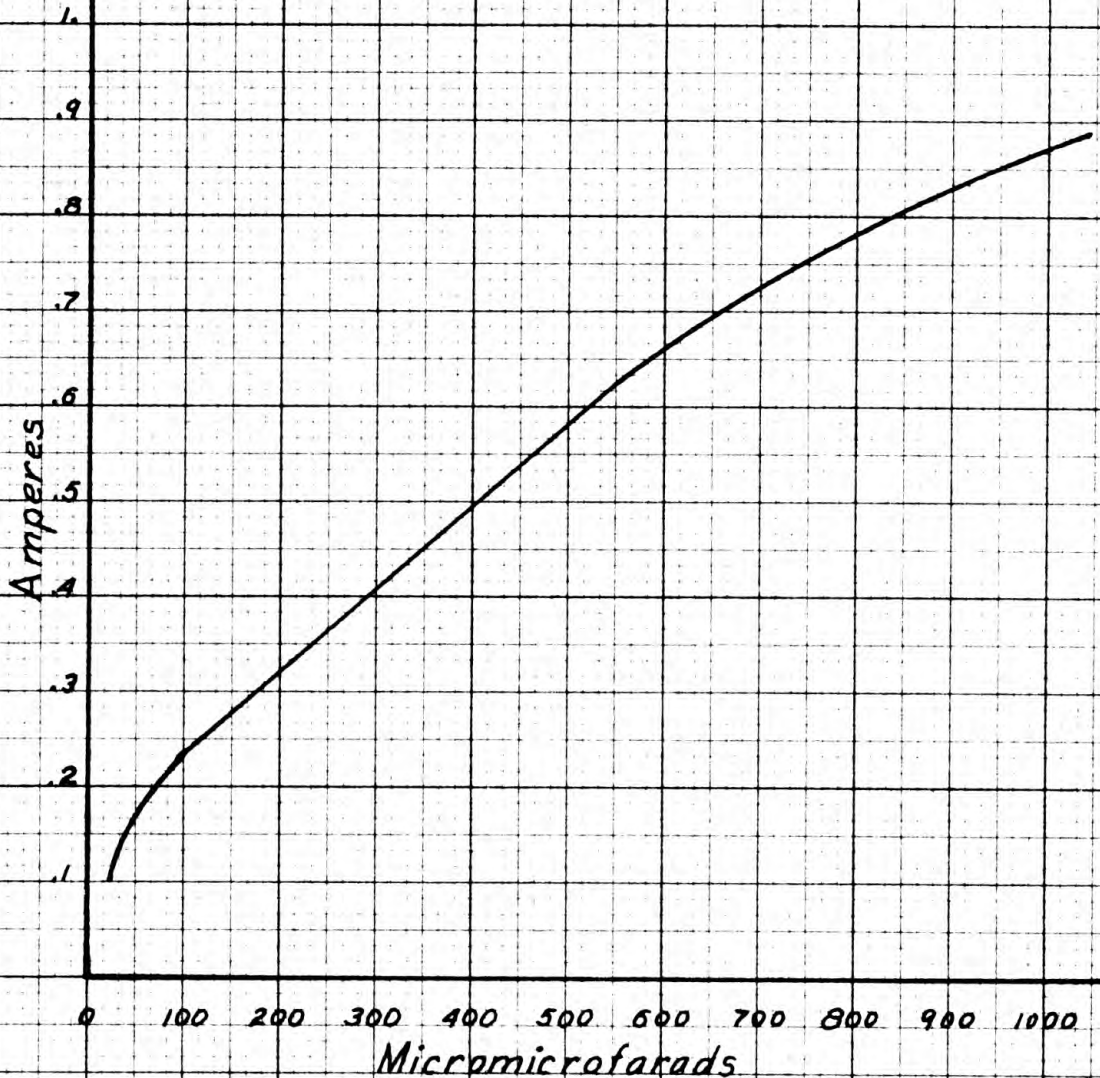

PLATE XV

Variation Of Current In Tank Coil With
Change Of Capacity In Transmitter



In Plate X the tuned grid circuit was used without the sinusoidal variable condenser in the circuit. The receiver was used as a wavemeter with a thermojunction meter at M.A., Plate V. With the variable condenser in the transmitter, but not in the receiver, the resonance curve is quite broad, as shown by curve a, Plate XI. Placing the variable condenser in the receiving set makes the resonance curve sharper, as shown by curves b and c, Plate XI. Changing the speed of the rotor changes the resonance curve. However, this does not affect the results materially.

The test showing that the capacitance of the sinusoidal variable condenser varied in a sinusoidal form was conducted as follows. The sinusoidal variable condenser was calibrated in degrees for one complete cycle, 360 electrical degrees, or $\frac{2\pi}{P} = 45$ mechanical degrees. The capacity was then measured for each degree change over the complete cycle by the resonance method, employing a standard condenser in parallel with the unknown, and a wavemeter as described in "Radio Frequency Electrical Measurements" by Brown, pages 6-8. The results thus obtained were plotted with degrees as abscissae and capacity as ordinates, resulting in the curves shown on Plate XII. A perfect sine curve when transformed into polar coordinates will give two perfect circles. Therefore, transforming the curves on Plate XII, the results given on Plate XIII show that the variation of capacity is

almost a perfect sinusoidal variation. There is a slight deviation from a perfect circle, also the axis for the positive half of the receiver is shifted eight electrical degrees. This is undoubtedly due to some mechanical defect in the construction and set up of the apparatus.

In frequency modulation it is undesirable to have the variation of capacity induce a variation of current in the oscillatory circuit of the transmitter. In this work it was found that the current did vary as the capacitance of the oscillatory circuit was varied. This is shown by Plate XIV. These data were taken with the Hartley oscillator. Plate XV shows this variation with the tuned grid circuit. For this work the receiver was used as a wavemeter, allowing us to see the actual variation of current in the receiver as the capacitance of the transmitter was varied. However, the variation of current in the receiver was not sufficient to interfere seriously with the results of the work.

In order to be certain of electromagnetic coupling, and with exclusion of electrostatic coupling, the transmitter and receiver were both heavily shielded in zinc boxes, the cover being made of pure copper screen. The filament and plate batteries were shielded in tin boxes. The sinusoidal variable condensers were shielded with pure copper sheet boxes. It was found by experiment that it was necessary to shield also the cathode ray oscillograph and its power pack.

The shielding sheets and screens were heavily grounded. The thousand cycle tuning fork used for modulation had to be shielded. With these precautions; it was then necessary to couple the transmitter and receiver by means of coupling coils. Small holes were cut in the shields of the receiver and transmitter to allow manipulation of the dials and switches.

With the transmitter oscillating, the receiver was tuned to the transmitter. This was done when the rotor of the sinusoidal variable condenser was not rotating. In the receiver the sinusoidal variable condenser was cut out of the circuit and the rotor of the sinusoidal variable condenser was started in the transmitter. A distinct hum could be detected in the receiver. With the sinusoidal variable condenser in the receiver, the hum vanished, showing that the capacitance of the receiver was in synchronism with the varying capacitance of the transmitter.

With the rotor of the variable condenser stopped and the receiver tuned to the transmitter, the thousand cycle tuning fork was started, varying the current in the oscillatory circuit of the transmitter. The thousand cycle note could be heard in the loud speaker of the receiver. With the fixed condenser in the receiver and the sinusoidal variable condenser rotating in the transmitter, the thousand cycle note was masked by a loud hum. Placing in the circuit

the rotating sinusoidal variable condenser in the receiver eliminated the hum, and the thousand cycle note could again be heard. This proved that signals can be sent over a transmitter of the kind used in this experiment, and the signals can not be picked up by a receiver unless the capacitance of the receiver is varying in synchronism with the capacitance of the transmitter. The above phenomena were observed at the peak of the resonance curve. If the receiver was tuned to the side of the resonance curve a distorted note was received.

When feeding the output of the receiver to a cathode ray oscillograph, instead of to the loud speaker, it was possible to see the wave form received by the receiver. It was also possible to photograph the wave form by focusing the image of the cathode ray oscillograph upon the rotating camera.

The resonance curve, showing the points at which the wave form was photographed, is shown on Plate XVI. These resonance curves use as ordinates the deflection of the cathode ray on the fluorescent screen as the condenser settings were varied for abscissae. Curve 1, Plate XVI, shows the resonance curve when the rotating sinusoidal condenser is in the transmitter but not in the receiver. The letters on this curve indicate the points at which the photographs were taken. Curve 2, Plate XVI, was obtained

with the thousand cycle note superimposed on the conditions of curve 1. Curve 3, Plate XVI, was obtained with the rotating sinusoidal condensers in both transmitter and receiver and the thousand cycle note superimposed on the transmitter.

Fig. 6, Plate XVII, shows the wave form in the receiver when the rotating sinusoidal condenser is in the transmitter only. The wave form is quite distorted, due to the varying capacitance of the transmitter. Fig. 7, Plate XVII, shows practically a straight line when the rotating sinusoidal condenser was placed in the receiver, and was synchronous with the rotating sinusoidal condenser of the transmitter. There is a small distortion present. However, it is very small as compared with the distortion present in Fig. 6. This proves that the distortion in the receiver can be practically neutralized; and therefore the receiver is in continuous resonance with the transmitter. Fig. 8, Plate XVIII, shows the wave form in the receiver with the rotating sinusoidal condenser in the transmitter and the thousand cycle note superimposed on the transmitter. The thousand cycles are completely masked. Placing the rotating sinusoidal condenser in the receiver should neutralize the distortion and allow the thousand cycle wave form to be seen. This condition is shown on Fig. 9, Plate XVIII. The envelope of the modulation is not symmetrical with the axis and the interior of the envelope is a blur. The blur is pro-

bably due to the thousand cycles not being synchronized with the camera. The envelope is probably due to beats between the thousand cycle amplitude modulation and a certain amount of amplitude modulation that was an unwanted accompaniment of the frequency modulation induced by the rotation of the sinusoidal variable condensers. The photographs thus far shown were taken at the peak of the resonance curve, point a curve 1, Plate XVI.

Let us now consider some points off the peak of the resonance curve. Fig. 10, Plate XIX, shows the wave form when the rotating sinusoidal condenser is in the transmitter only, at point C, curve 1, Plate XVI. The distortion is still present when the rotating sinusoidal condenser is in the receiver as shown by Fig. 11, Plate XIX. At point B the distortion is pronounced when the rotating sinusoidal condenser is in the transmitter only, as shown by Fig. 12, Plate XX. Placing the rotating sinusoidal condenser in the receiver at this point still gave the distortion. This is shown by Fig. 13, Plate XX. At point D the distorted wave in the receiver, when the rotating sinusoidal condenser is in the transmitter only, is shown by Fig. 14, Plate XXI. Placing the rotating sinusoidal condenser in the receiver gave the wave form shown by Fig. 15, Plate XXI. At point E, almost off the resonance curve, the distortion is still present when the rotating sinusoidal condenser is in the transmitter only. This is shown by Fig. 16, Plate XXII.

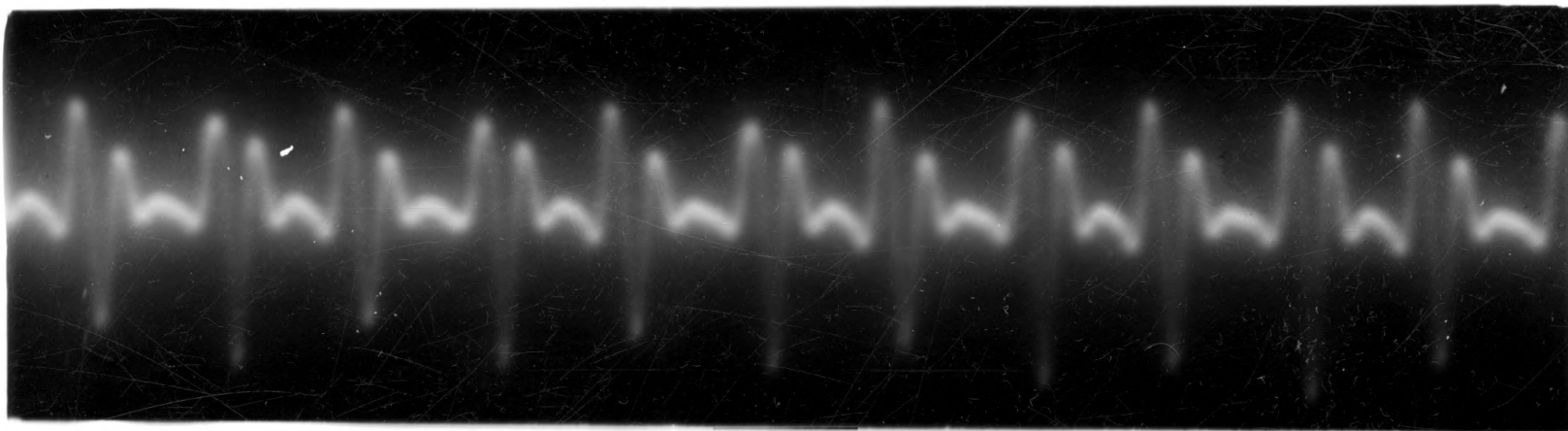

Fig. 6

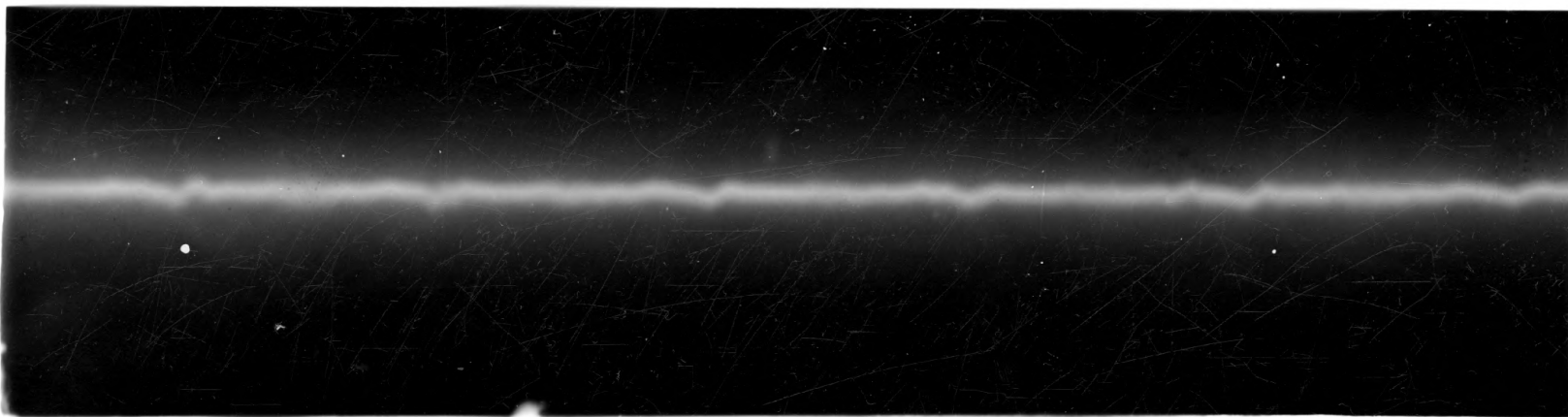

Fig. 7

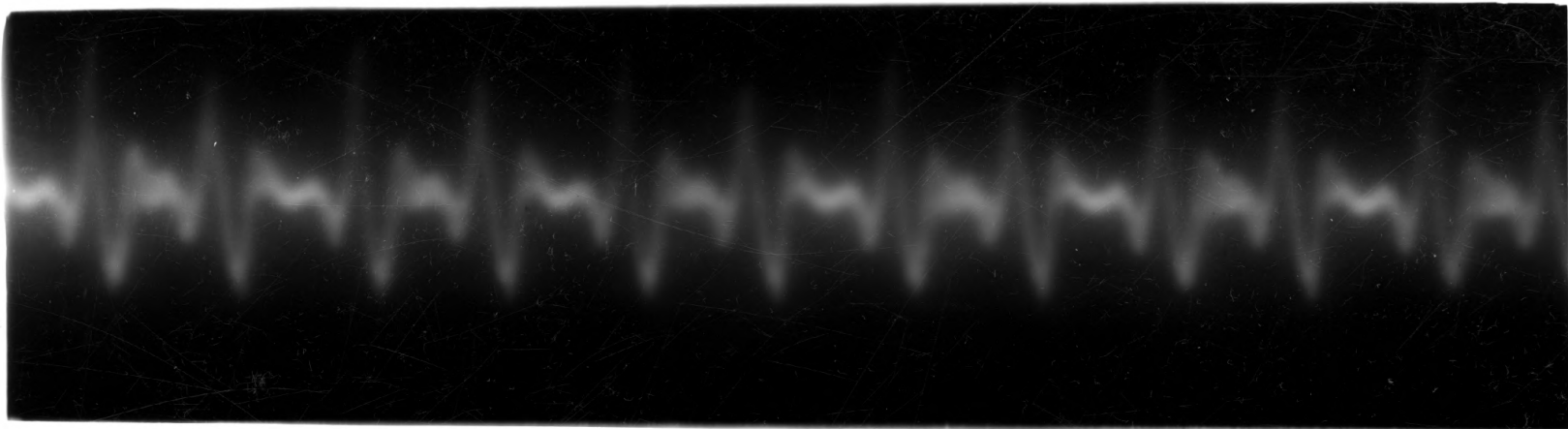

Fig. 8

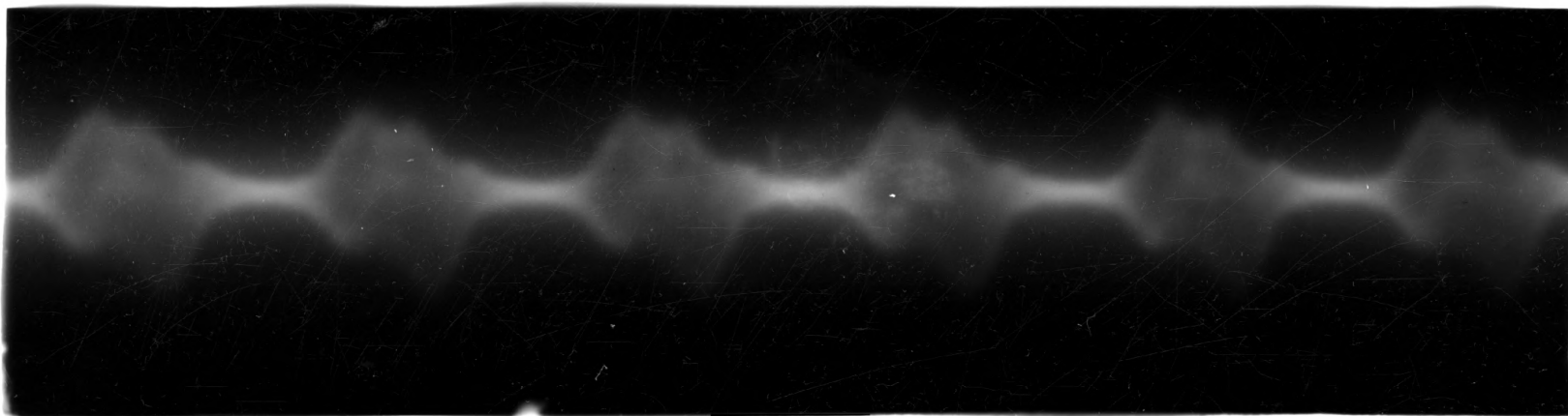

Fig. 9

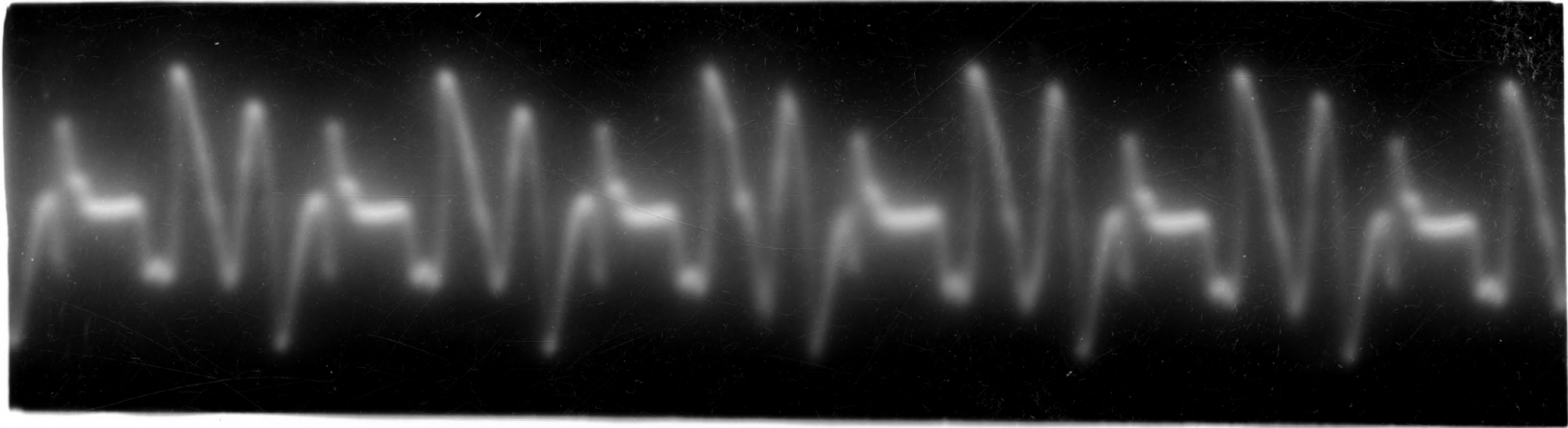

Fig. 10

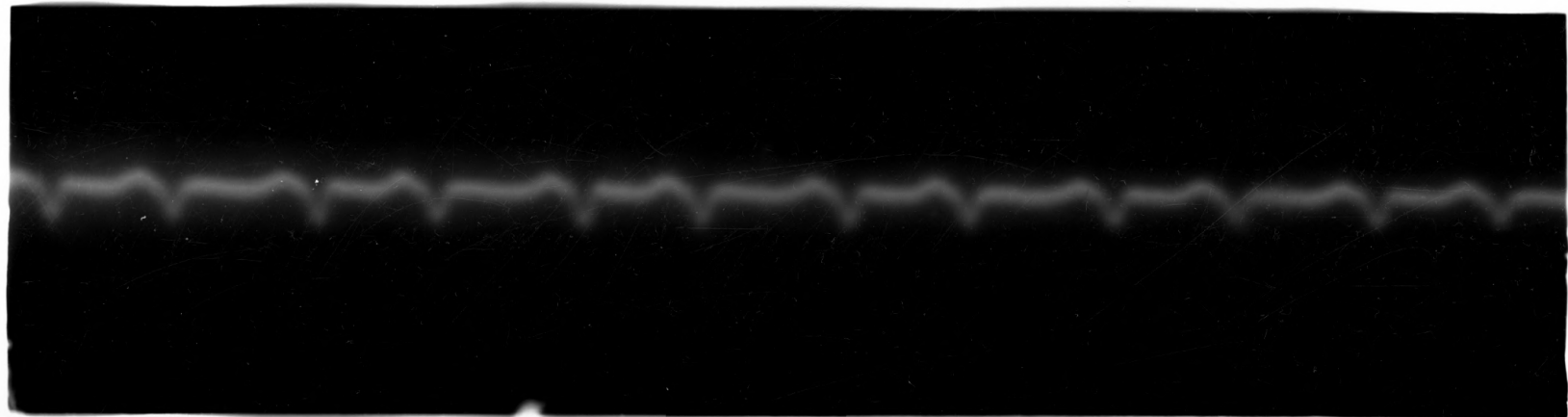

Fig. 11

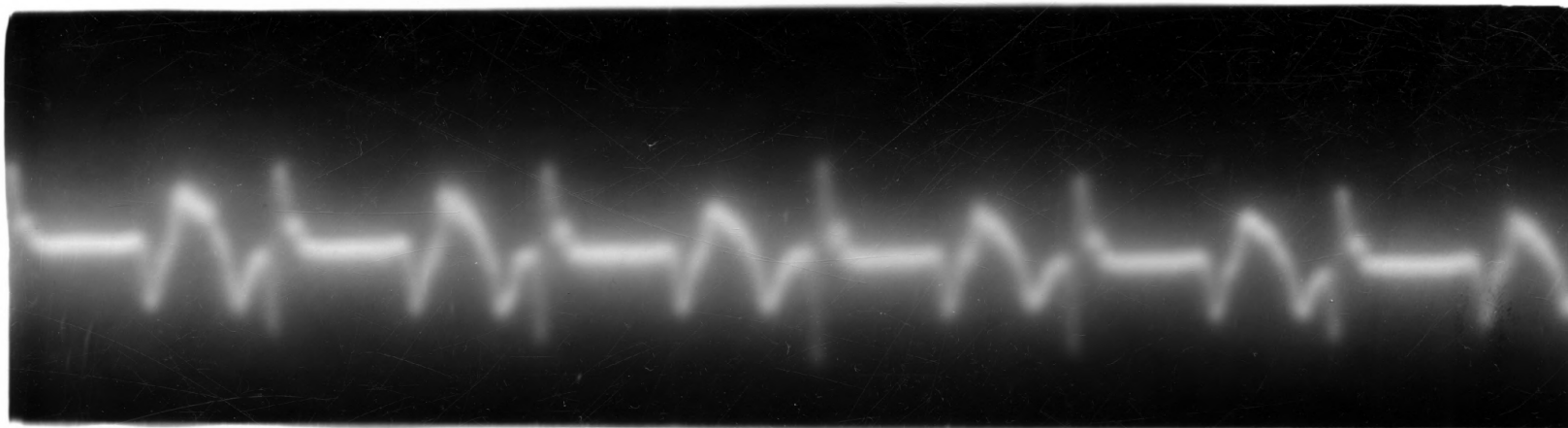

Fig. 12

PLATE XX

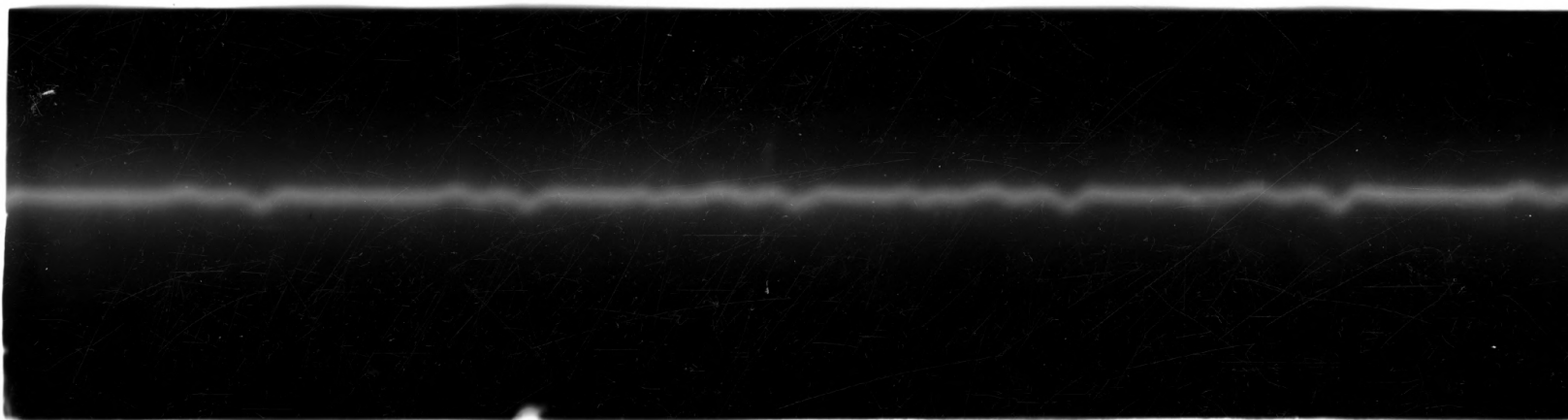

Fig. 13

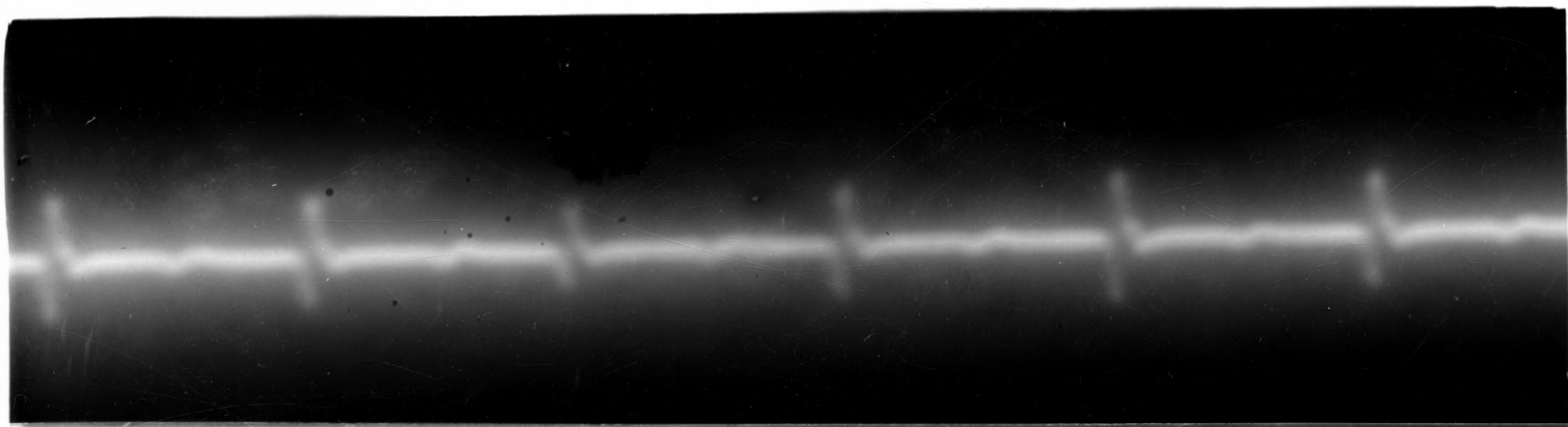

Fig. 14

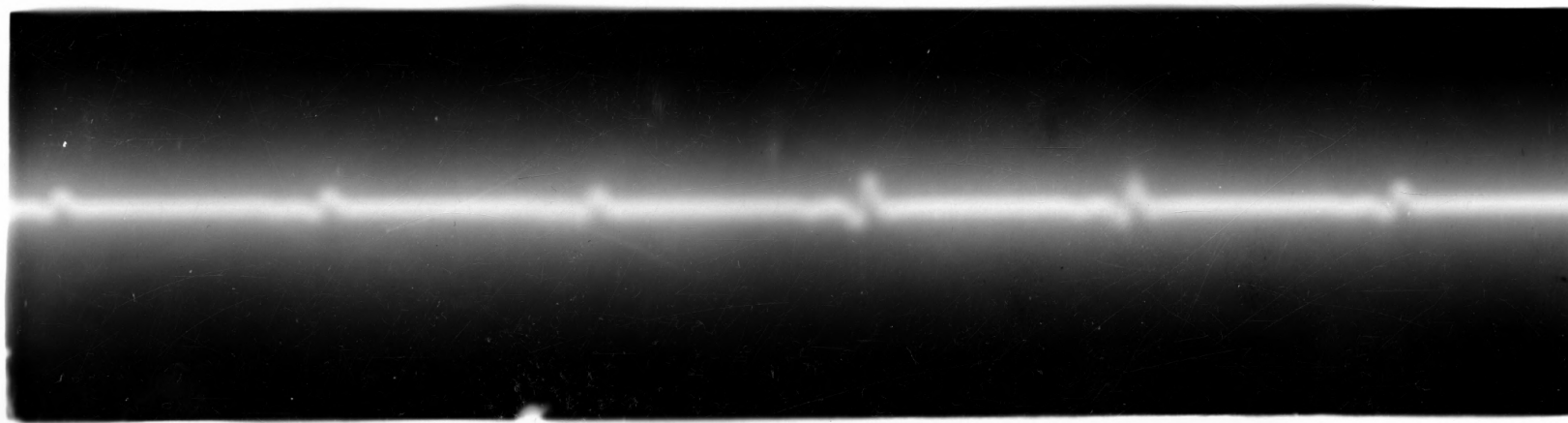

Fig. 15

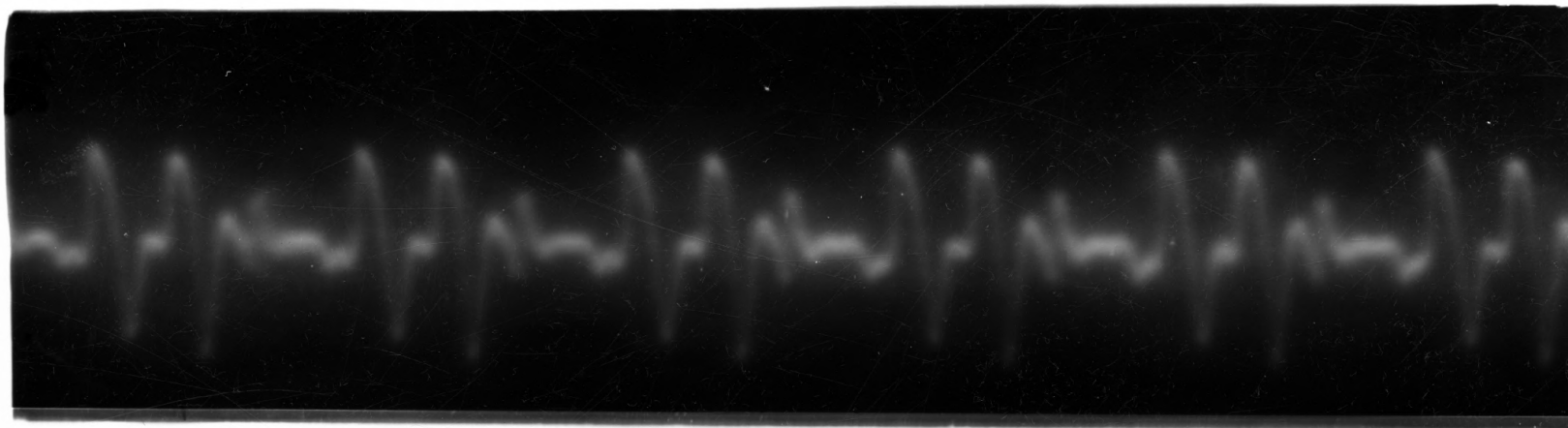

Fig. 16

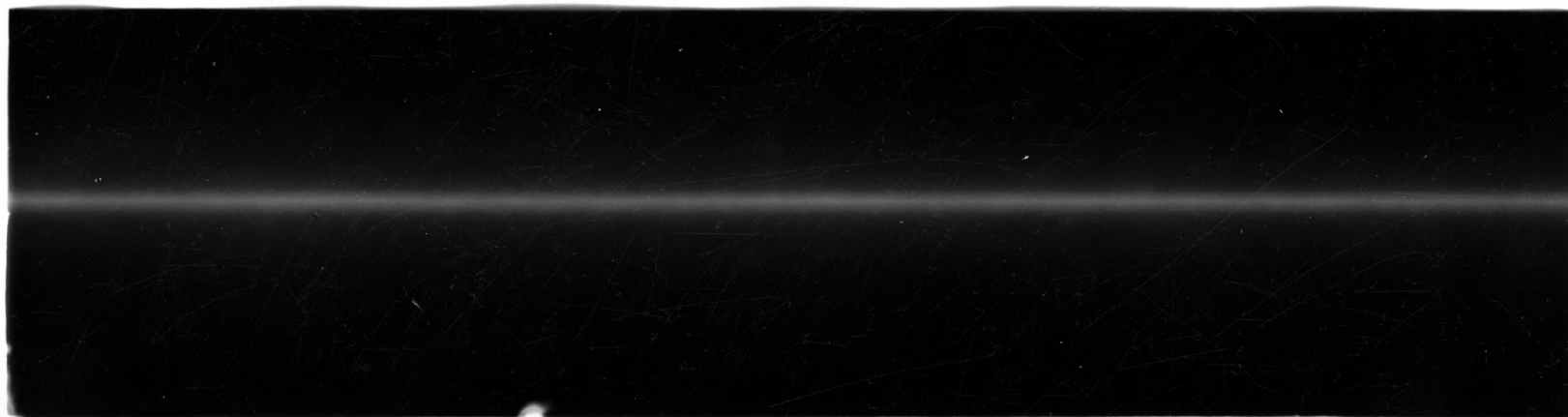

Fig. 17



Fig. 18

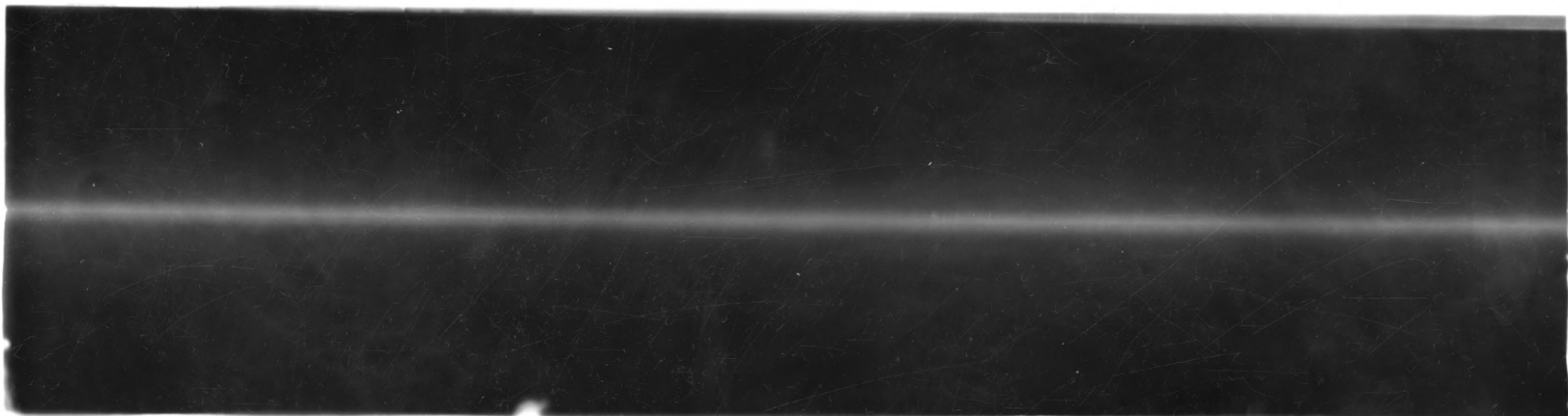

Fig. 19

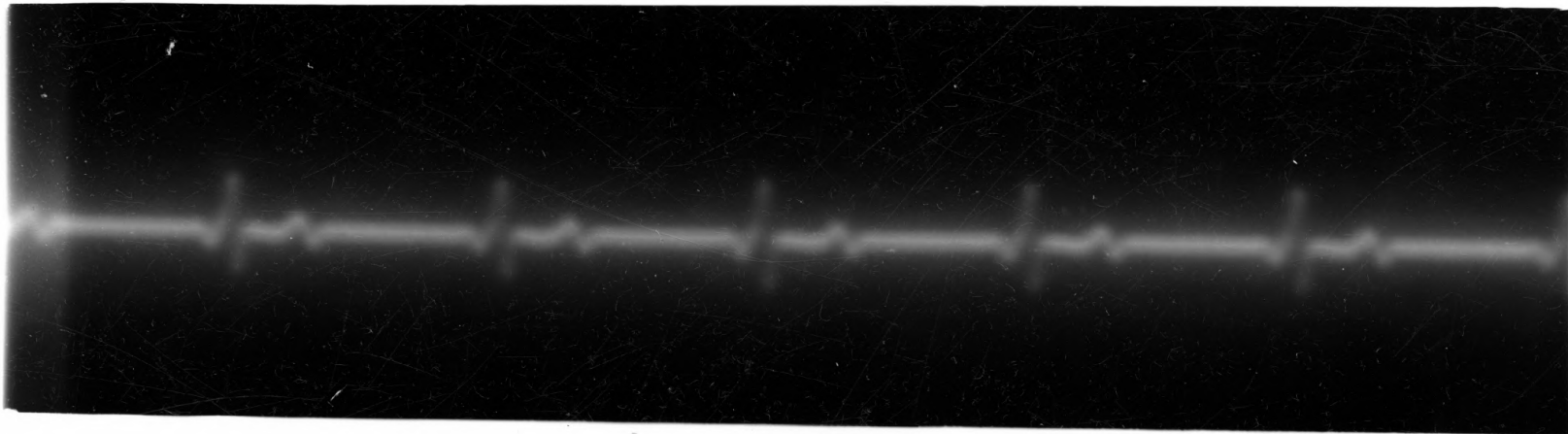

Fig. 20

TABLE XXIV

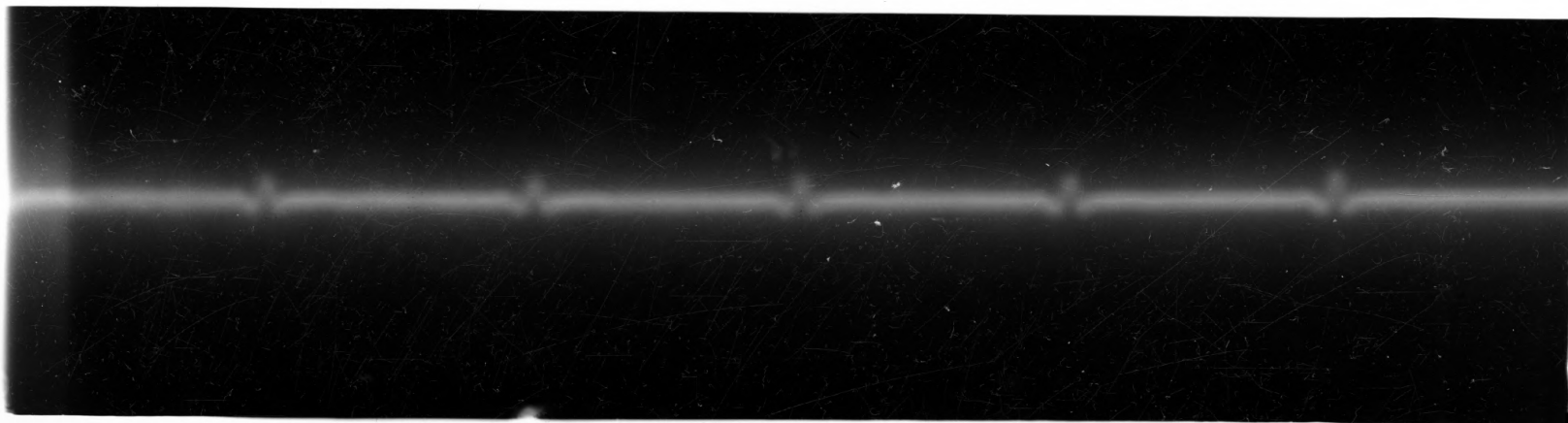

Fig. 21

PLATE XXV

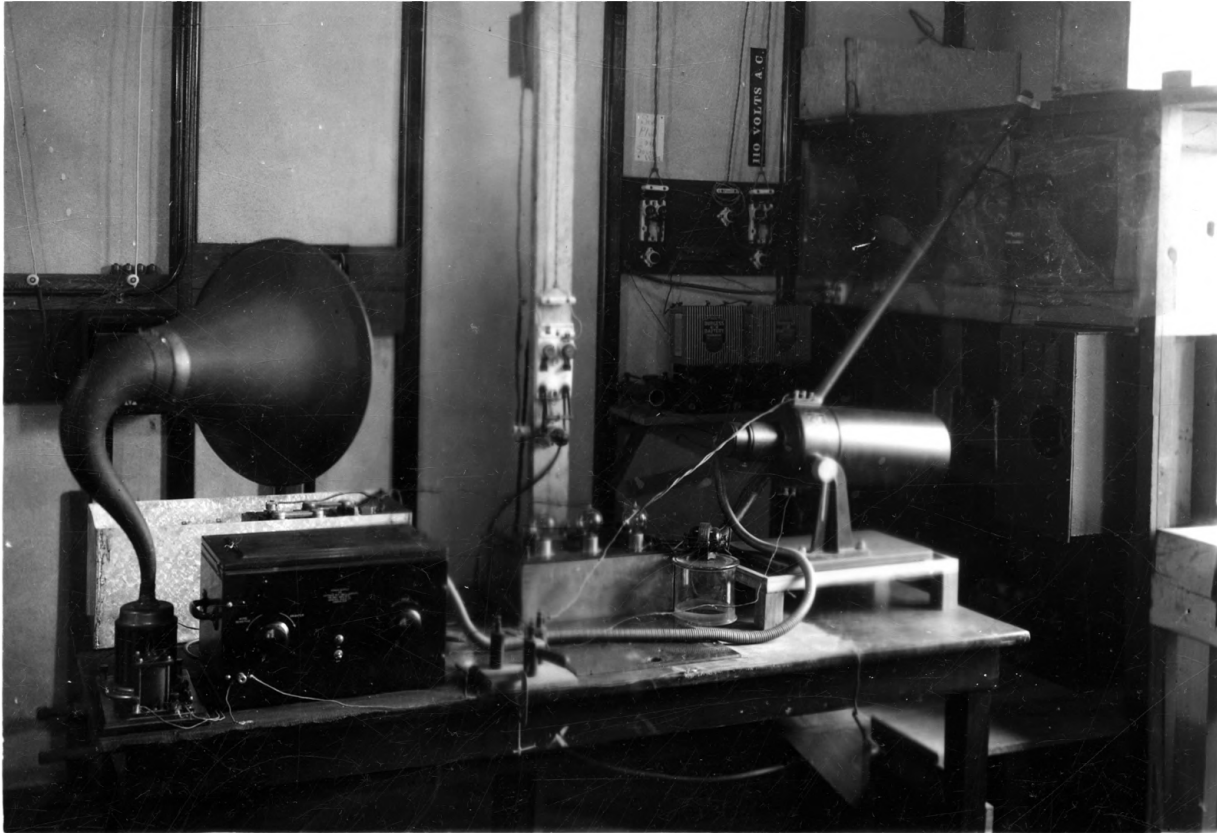

PLATE XXVI

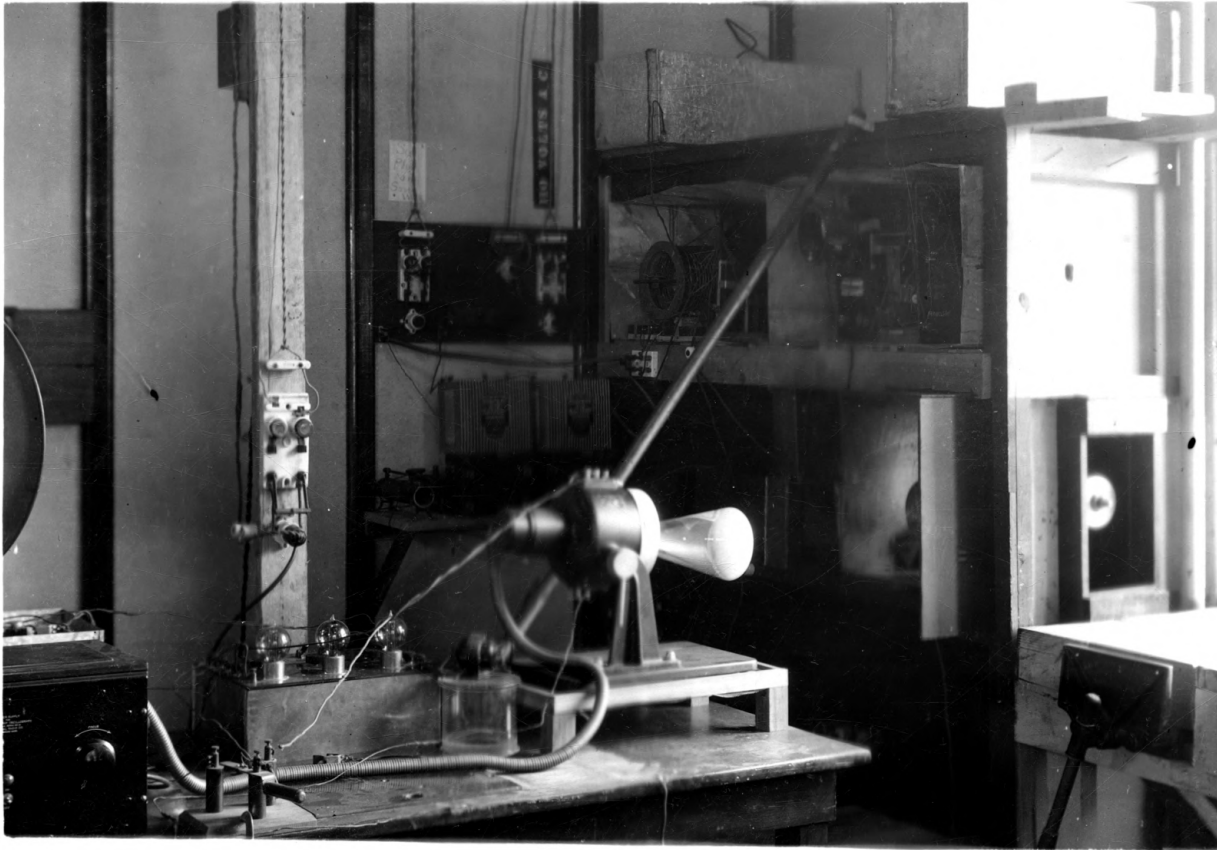
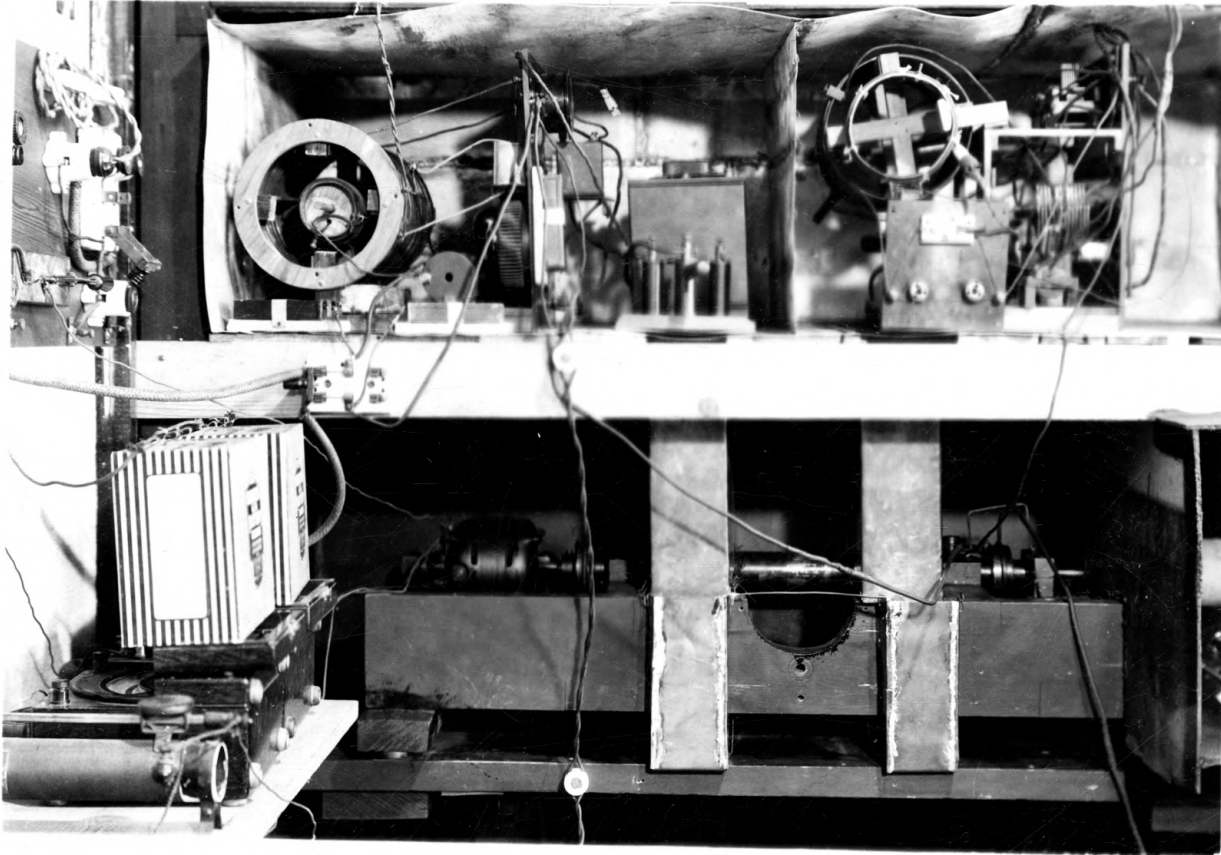

PLATE XXVII



On the other side of the resonance curve at point F the distortion was pronounced with the rotating sinusoidal condenser in the transmitter only, as shown by Fig. 17, Plate XXII. Placing the rotating sinusoidal condenser in the receiver still gives the distortion, as shown on Fig. 18, Plate XXIII. At point G, having the rotating sinusoidal condenser in only the transmitter gave the wave form of Fig. 19, Plate XXIII. With the rotating sinusoidal condenser in the receiver, the distortion was not entirely neutralized, as is shown by Fig. 20, Plate XXIV. At point H, almost opposite point F, the distortion was still present when the rotating sinusoidal condenser was in the transmitter only. Thus by photographing the entire range of the resonance curve it was found that complete neutralization occurred only at the peak of the resonance curve.

The results of this work show conclusively that signals may be transmitted and received over the frequency modulated system described in the preceding pages, and be unintelligible in an ordinary receiver. A further possibility of research along this line is to transmit speech and detect it with the frequency modulated receiver.

ACKNOWLEDGMENT

I wish to express my sincere gratitude to Professor Eric R. Lyon, my major instructor, for his guidance and direction throughout this work and for the mathematical derivations presented in the theory of this thesis; to Professor Leo Hudiburg for his assistance in the construction of the apparatus and in the photographing of the wave forms with the cathode ray oscillograph; and to Professor J. O. Hamilton for photographing the apparatus.

BIBLIOGRAPHY

- (1) Culver, Charles A.
Electrostatic Alternator. *Physics*, 2: 448-456.
1932.
- (2) Gunn, Ross.
Principles of a New Portable Electrometer.
Physical Review, 40: 307-312. 1932.
- (3) Hoyt, Paul R.
Investigation of the Quality of Frequency Modulation Produced by a Sinusoidal Variable Condenser. Unpublished Thesis, Kansas State College. 54 p. 1932.
- (4) Hudiburg, Leo E.
Investigation of Resonance Curve with Respect to Variation of Capacity. *Kans. Acad. Sci., Trans.* 34: 276-281. 1931.
- (5) Lyon, Eric R.
Electrostatic Inductor Alternator. *Kans. Acad. Sci., Trans.* 34: 244-247. 1931.
- (6) Sterling, George E.
The Radio Manual, Chapter 6: 228-235. *The Radio Manual*, New York. D. Van Nostrand, 666 p. 1928.
- (7) Wentz, E. C.
Electrostatic Transmitters. *Physical Review*, 10: 39-63. 1917.