

DEVELOPING SHORT-SPAN ALTERNATIVES TO REINFORCED CONCRETE BOX  
CULVERT STRUCTURES IN KANSAS

by

JOHN MICHAEL HANDKE

B.S., Kansas State University, 2011

A THESIS

submitted in partial fulfillment of the requirements for the degree

MASTER OF SCIENCE

Department of Civil Engineering  
College of Engineering

KANSAS STATE UNIVERSITY  
Manhattan, Kansas

2013

Approved by:

Major Professor  
Dr. Robert J. Peterman, Ph.D., P.E.

# **Copyright**

JOHN MICHAEL HANDKE

2013

## **Abstract**

Concrete box culvert floor slabs are known to have detrimental effects on river and stream hydraulics. Consequences include an aquatic environment less friendly to the passage of fish and other organisms. This has prompted environmental regulations restricting construction of traditional, four-sided box culvert structures in rivers and streams populated by protected species. The box culvert standard currently used by the Kansas Department of Transportation (KDOT) is likely to receive increased scrutiny from federal and state environmental regulators in the near future.

Additionally, multiple-cell box culverts present a maintenance challenge, since passing driftwood and debris are frequently caught in the barrels and around cell walls. As more structures reach the end of their design lives, new solutions must be developed to facilitate a more suitable replacement. Since construction can cause significant delays to the traveling public, systems and techniques which accelerate the construction process should also be considered.

This thesis documents development of a single-span replacement system for box culverts in the state of Kansas. Solutions were found using either a flab slab or the center span of the KDOT three-span, haunched-slab bridge standard. In both cases, the concrete superstructure is connected monolithically with a set of abutment walls, which sit on piling. The system provides an undisturbed, natural channel bottom, satisfying environmental regulations. Important structural, construction, maintenance, and economic criteria considered during the planning stages of bridge design are discussed.

While both superstructural systems were found to perform acceptably, the haunched section was chosen for preliminary design. Rationale for selection of this system is explained.

Structural modeling, analysis, and design data are presented to demonstrate viability of the system for spans ranging from 32 to 72 feet. The new system is expected to meet KDOT's needs for structural, environmental, and hydraulic performance, as well as long-term durability. Another option involving accelerated bridge construction (ABC) practices is discussed.

# Table of Contents

|   |      |
|---|------|
| List of Figures .....                                     | ix   |
| List of Tables .....                                      | xiii |
| Acknowledgements.....                                     | xv   |
| Chapter 1 - Introduction and Background Information ..... | 1    |
| Project Context .....                                     | 1    |
| Project Requirements .....                                | 8    |
| Project Scope and Phasing.....                            | 9    |
| Report Outline.....                                       | 10   |
| Chapter 2 - Review of Relevant Subject Literature .....   | 11   |
| Hydraulic Considerations .....                            | 12   |
| Environmental Considerations.....                         | 14   |
| Effects of Culverts on Organism Passage.....              | 15   |
| Protected Species .....                                   | 18   |
| Mitigation Techniques .....                               | 19   |
| Accelerated Bridge Construction Practices .....           | 24   |
| Existing KDOT Box Culvert Standard .....                  | 26   |
| Survey of Short-Span Systems Used in Other States .....   | 30   |
| Embedded Four-Sided Box Culverts .....                    | 34   |
| Three-Sided Box Culverts .....                            | 36   |
| Proprietary Bottomless Culverts .....                     | 40   |
| CON/SPAN Bridge Systems.....                              | 42   |
| BEBO Arch Systems.....                                    | 48   |
| HY-SPAN .....   | 51   |
| Corrugated Metal Plate Structures .....                   | 53   |
| Conventional Short-Span Bridge Systems.....               | 57   |
| Selection of the Superstructural System .....             | 58   |
| Innovative Practices in Minnesota .....                   | 64   |
| Innovative Practices in Nebraska.....                     | 71   |

|  |     |
|--|-----|
| Innovative Practices in the Northeastern U.S. ....       | 73  |
| Northeast Extreme Tee Beam .....                         | 74  |
| Bridge-in-a-Backpack .....                               | 80  |
| Innovative Practices in Texas .....                      | 84  |
| Innovative Practices in Washington.....                  | 92  |
| Geosynthetic Reinforced Soil Systems.....                | 95  |
| Chapter 3 - Development of Cast-in-Place Solution.....   | 103 |
| Selection of the New Bridge System .....                 | 103 |
| Environmental and Hydraulic Design Characteristics ..... | 104 |
| Superstructural Design Characteristics .....             | 105 |
| Substructural Design Characteristics .....               | 106 |
| Connections and Joints .....                             | 108 |
| Summary of Design Concepts.....                          | 109 |
| Parameters of the Chosen System.....                     | 109 |
| Target Project Span Range.....                           | 110 |
| Superstructural Details.....                             | 110 |
| Flat Slabs.....  | 111 |
| Haunched Slabs.....                                      | 111 |
| Comparison of Superstructural Options.....               | 113 |
| Substructural Details .....                              | 114 |
| Connection and Joint Details .....                       | 115 |
| Experimental Setup.....                                  | 115 |
| Analysis Methodology .....                               | 116 |
| Model Setup .....  | 117 |
| Superstructural Modeling.....                            | 118 |
| Substructural Modeling.....                              | 121 |
| Connection and Joint Modeling .....                      | 125 |
| Loads.....   | 126 |
| Load Combinations .....                                  | 133 |
| Summary of STAAD Model Setup.....                        | 134 |
| Model Verification.....                                  | 135 |

|   |     |
|---|-----|
| Structural Analysis of the New System .....               | 136 |
| Analysis Procedure .....                                  | 137 |
| Evaluation of Substructural and Profile Effects.....      | 137 |
| 32-ft. Haunched Slab .....                                | 138 |
| 32-ft. Flat Slab .....                                    | 140 |
| 72-ft. Haunched Slab .....                                | 142 |
| 72-ft. Flat Slab .....                                    | 143 |
| Conclusions for Substructural Effects .....               | 145 |
| Comparison of Haunched and Flat Profiles .....            | 147 |
| Analysis Results of All Spans and Profiles.....           | 150 |
| 32-ft. Haunched Slab .....                                | 152 |
| 32-ft. Flat Slab .....                                    | 153 |
| 40-ft. Haunched Slab .....                                | 154 |
| 48-ft. Haunched Slab .....                                | 155 |
| 56-ft. Haunched Slab .....                                | 156 |
| 64-ft. Haunched Slab .....                                | 157 |
| 72-ft. Haunched Slab .....                                | 158 |
| 72-ft. Flat Slab .....                                    | 159 |
| Comparison of All Profiles .....                          | 160 |
| Design Procedure .....                                    | 163 |
| Input Variables .....                                     | 164 |
| Strength .....  | 165 |
| Service.....  | 166 |
| Fatigue.....  | 167 |
| Design Results .....                                      | 167 |
| Comparison of Haunched and Flat Profiles .....            | 167 |
| Design of Remaining Haunched Profiles.....                | 171 |
| Design Drawings for the Haunched Profiles .....           | 190 |
| Chapter 4 - Discussion of Precast Solution.....           | 198 |
| Performance Characteristics of Precast Bridge System..... | 199 |
| Substructural Details for Precast Bridge System .....     | 200 |

|   |     |
|---|-----|
| Comparison of Available Precast Superstructural Options .....               | 201 |
| Selection of Precast Superstructure .....                                   | 204 |
| Summary of Precast System .....   | 206 |
| Chapter 5 - Summary and Conclusions .....                                   | 208 |
| Hydraulic and Environmental Design.....                                     | 208 |
| Evaluation of Existing Solutions .....                                      | 209 |
| Development of Cast-in-Place System .....                                   | 210 |
| Analysis and Design Results.....  | 211 |
| Selection of Precast System.....  | 214 |
| Chapter 6 - Recommendations for Future Research .....                       | 215 |
| Superstructural Considerations .....  | 215 |
| Substructural Considerations .....  | 216 |
| Other Considerations .....  | 218 |
| Closing .....   | 219 |
| References .....  | 220 |
| Appendix A - Calculation of Live Load Based on Equivalent Strip Method..... | 226 |
| Appendix B - Sample Calculations for Limit State Design.....                | 242 |



## List of Figures

|   |    |
|---|----|
| Figure 1.1: Low-Water Crossing .....  | 2  |
| Figure 1.2: Scour Under Bridge Pile Bent .....                                  | 3  |
| Figure 1.3: Box Culvert Obstructed with Driftwood .....                         | 4  |
| Figure 1.4: Box Culvert with Narrow Waterway Opening.....                       | 5  |
| Figure 1.5: Scour Adjacent to Box Culvert .....                                 | 6  |
| Figure 2.1: KDOT RCB Dimensions.....  | 28 |
| Figure 2.2: KDOT RFB Dimensions .....   | 29 |
| Figure 2.3: Span-to-Depth Ratio for Common Structural Shapes .....              | 60 |
| Figure 2.4: Guidelines for Selection of Structural Shapes.....                  | 61 |
| Figure 2.5: Minnesota Bridge Types Based on Maximum Span Length.....            | 63 |
| Figure 2.6: Dimensions of Minnesota Inverted-Tee System .....                   | 66 |
| Figure 2.7: Minnesota Inverted Tee with Standard Web.....                       | 67 |
| Figure 2.8: Minnesota Inverted Tee with Hooked Rebar Connection .....           | 67 |
| Figure 2.9: Minnesota Inverted Tee with Tapered Web .....                       | 68 |
| Figure 2.10: Minnesota Inverted-Tee Embedded-Plate Connection.....              | 69 |
| Figure 2.11: Nebraska Inverted-Tee System .....                                 | 72 |
| Figure 2.12: Northeast Extreme Tee Beam Bridge.....                             | 76 |
| Figure 2.13: Detail of NEXT Full-Depth Section.....                             | 77 |
| Figure 2.14: Cross Section of NEXT Beam Bridge with Partial-Depth Section ..... | 78 |
| Figure 2.15: Detail of NEXT Partial-Depth Section Prior to Topping .....        | 78 |
| Figure 2.16: Detail of NEXT Concrete Railing Attachment .....                   | 79 |
| Figure 2.17: Bridge-in-a-Backpack .....   | 81 |
| Figure 2.18: Bridge-in-a-Backpack Under Construction.....                       | 82 |
| Figure 2.19: Texas Prestressed Slab-Beam Bridge.....                            | 85 |
| Figure 2.20: Texas Prestressed Decked-Slab Beam Bridge * .....                  | 85 |
| Figure 2.21: Welded Embedded-Plate Connection.....                              | 86 |
| Figure 2.22: Texas Prestressed Box-Beam Bridge .....                            | 87 |
| Figure 2.23: Texas Prestressed Double-Tee Beam Bridge .....                     | 88 |
| Figure 2.24: Rebar Connection for Adjacent Deck Panels.....                     | 89 |

|   |     |
|---|-----|
| Figure 2.25: Precast Abutment Placed on Piles .....                                   | 90  |
| Figure 2.26: Welded Embedded-Plate Connection for Substructure.....                   | 91  |
| Figure 2.27: Grouted Duct Substructural Connection .....                              | 92  |
| Figure 2.28: Placement of Precast Substructural Elements .....                        | 94  |
| Figure 2.29: GRS Bridge System in Service .....                                       | 98  |
| Figure 2.30: Profile of a GRS-IBS System.....   | 99  |
| Figure 3.1: Outline of Frame Elements.....  | 118 |
| Figure 3.2: Parabolic Haunched-Slab Profile .....                                     | 119 |
| Figure 3.3: Idealized Haunched-Slab Profile for Model.....                            | 120 |
| Figure 3.4: Stepped Member Offsets Shown in STAAD Model .....                         | 121 |
| Figure 3.5: Model Combinations .....  | 124 |
| Figure 3.6: Modeled View of Strip with 6-ft. Abutment and Clay Soil .....             | 124 |
| Figure 3.7: Modeled View of Strip with 20-ft. Abutment and Sandy Soil.....            | 125 |
| Figure 3.8: Dead Load Deflection of Structure .....                                   | 126 |
| Figure 3.9: AASHTO HL-93 Truck Load on Structure.....                                 | 127 |
| Figure 3.10: AASHTO HL-93 Tandem Load on Structure .....                              | 127 |
| Figure 3.11: AASHTO HL-93 Lane Load on Structure .....                                | 128 |
| Figure 3.12: Lateral Earth Load on 6-ft. Abutment Wall .....                          | 130 |
| Figure 3.13: Lateral Earth Load on 20-ft. Abutment Wall .....                         | 131 |
| Figure 3.14: Substructural Influence on Maximum Moment for 32-ft. Haunched Slab.....  | 139 |
| Figure 3.15: Substructural Influence on Minimum Moment for 32-ft. Haunched Slab ..... | 140 |
| Figure 3.16: Substructural Influence on Maximum Moment for 32-ft. Flat Slab.....      | 141 |
| Figure 3.17: Substructural Influence on Minimum Moment for 32-ft. Flat Slab .....     | 141 |
| Figure 3.18: Substructural Influence on Maximum Moment for 72-ft. Haunched Slab.....  | 142 |
| Figure 3.19: Substructural Influence on Minimum Moment for 72-ft. Haunched Slab ..... | 143 |
| Figure 3.20: Substructural Influence on Maximum Moment for 72-ft. Flat Slab.....      | 144 |
| Figure 3.21: Substructural Influence on Minimum Moment for 72-ft. Flat Slab .....     | 145 |
| Figure 3.22: Moment Envelopes for 32-ft. Span .....                                   | 148 |
| Figure 3.23: Moment Envelopes for 72-ft. Span .....                                   | 149 |
| Figure 3.24: Moment Envelope for 32-ft. Span with Haunched Profile.....               | 152 |
| Figure 3.25: Moment Envelope for 32-ft. Span with Flat Profile.....                   | 153 |

|   |     |
|---|-----|
| Figure 3.26: Moment Envelope for 40-ft. Span with Haunched Profile.....   | 154 |
| Figure 3.27: Moment Envelope for 48-ft. Span with Haunched Profile.....   | 155 |
| Figure 3.28: Moment Envelope for 56-ft. Span with Haunched Profile.....   | 156 |
| Figure 3.29: Moment Envelope for 64-ft. Span with Haunched Profile.....   | 157 |
| Figure 3.30: Moment Envelope for 72-ft. Span with Haunched Profile.....   | 158 |
| Figure 3.31: Moment Envelope for 72-ft. Span with Flat Profile.....   | 159 |
| Figure 3.32: Maximum Design Moment for All Spans and Profiles .....   | 161 |
| Figure 3.33: Minimum Design Moment for All Spans and Profiles.....  | 162 |
| Figure 3.34: Comparison of Factored Positive Moment Demand for All Sections.....  | 180 |
| Figure 3.35: Comparison of Factored Negative Moment Demand for All Sections .....   | 180 |
| Figure 3.36: Comparison of Factored Positive Moment Capacity for All Sections with Center-Span Reinforcement Design ..... | 181 |
| Figure 3.37: Comparison of Factored Negative Moment Capacity for All Sections with Center-Span Reinforcement Design ..... | 182 |
| Figure 3.38: Comparison of Factored Positive Moment Capacity for All Sections with Single-Span Reinforcement Design ..... | 182 |
| Figure 3.39: Comparison of Factored Negative Moment Capacity for All Sections with Single-Span Reinforcement Design ..... | 183 |
| Figure 3.40: Factored Positive Moment Design of 32-ft. Section .....  | 184 |
| Figure 3.41: Factored Negative Moment Design of 32-ft. Section.....   | 184 |
| Figure 3.42: Factored Positive Moment Design of 40-ft. Section .....  | 185 |
| Figure 3.43: Factored Negative Moment Design of 40-ft. Section.....   | 185 |
| Figure 3.44: Factored Positive Moment Design of 48-ft. Section .....  | 186 |
| Figure 3.45: Factored Negative Moment Design of 48-ft. Section.....   | 186 |
| Figure 3.46: Factored Positive Moment Design of 56-ft. Section .....  | 187 |
| Figure 3.47: Factored Negative Moment Design of 56-ft. Section.....   | 187 |
| Figure 3.48: Factored Positive Moment Design of 64-ft. Section .....  | 188 |
| Figure 3.49: Factored Negative Moment Design of 64-ft. Section.....   | 188 |
| Figure 3.50: Factored Positive Moment Design of 72-ft. Section .....  | 189 |
| Figure 3.51: Factored Negative Moment Design of 72-ft. Section.....   | 189 |
| Figure 3.52: Plan View of 32-ft., Haunched-Slab Section .....   | 191 |

|   |     |
|---|-----|
| Figure 3.53: Plan View of 40-ft., Haunched-Slab Section ..... | 192 |
| Figure 3.54: Plan View of 48-ft., Haunched-Slab Section ..... | 193 |
| Figure 3.55: Plan View of 56-ft., Haunched-Slab Section ..... | 194 |
| Figure 3.56: Plan View of 64-ft., Haunched-Slab Section ..... | 195 |
| Figure 3.57: Plan View of 72-ft., Haunched-Slab Section ..... | 196 |
| Figure 3.58: Section View of 28-ft.-Wide Roadway .....        | 197 |

## List of Tables

|   |     |
|---|-----|
| Table 1.1: Functional Classification of Kansas Bridges .....                        | 1   |
| Table 2.1: State Responses to Environmental Mitigation Survey .....                 | 31  |
| Table 2.2: CON/SPAN Bridge Sizes .....  | 43  |
| Table 2.3: California Prestressed Shapes by Recommended Span Length .....           | 62  |
| Table 3.1: Depth of Flat Slab .....   | 119 |
| Table 3.2: Depth of Haunched Slab at Tenth-Points on Span .....                     | 120 |
| Table 3.3: Modeled Depth of Haunched-Slab Elements on Span .....                    | 120 |
| Table 3.4: Substructural Influence on Moment for 32-ft. Haunched Slab.....          | 139 |
| Table 3.5: Substructural Influence on Moment for 32-ft. Flat Slab.....              | 140 |
| Table 3.6: Substructural Influence on Moment for 72-ft. Haunched Slab.....          | 142 |
| Table 3.7: Substructural Influence on Moment for 72-ft. Flat Slab.....              | 144 |
| Table 3.8: Profile Influence on Moment for 32-ft. Span .....                        | 148 |
| Table 3.9: Profile Influence on Moment for 72-ft. Span .....                        | 149 |
| Table 3.10: Moment Envelope for 32-ft. Span with Haunched Profile .....             | 152 |
| Table 3.11: Moment Envelope for 32-ft. Span with Flat Profile .....                 | 153 |
| Table 3.12: Moment Envelope for 40-ft. Span with Haunched Profile .....             | 154 |
| Table 3.13: Moment Envelope for 48-ft. Span with Haunched Profile .....             | 155 |
| Table 3.14: Moment Envelope for 56-ft. Span with Haunched Profile .....             | 156 |
| Table 3.15: Moment Envelope for 64-ft. Span with Haunched Profile .....             | 157 |
| Table 3.16: Moment Envelope for 72-ft. Span with Haunched Profile .....             | 158 |
| Table 3.17: Moment Envelope for 72-ft. Span with Flat Profile .....                 | 159 |
| Table 3.18: Maximum Design Moment for All Spans and Profiles .....                  | 160 |
| Table 3.19: Minimum Design Moment for All Spans and Profiles .....                  | 161 |
| Table 3.20: Comparison of Reinforcement Designs for 32-ft. Sections.....            | 168 |
| Table 3.21: Provision of Steel for 32-ft. Haunched Slab for Profile Comparison..... | 168 |
| Table 3.22: Provision of Steel for 32-ft. Flat Slab for Profile Comparison.....     | 169 |
| Table 3.23: Comparison of Reinforcement Designs for 72-ft. Sections.....            | 169 |
| Table 3.24: Provision of Steel for 72-ft. Haunched Slab for Profile Comparison..... | 170 |
| Table 3.25: Provision of Steel for 72-ft. Flat Slab for Profile Comparison.....     | 170 |

|   |     |
|---|-----|
| Table 3.26: Reinforcement Design of 32-ft., Haunched-Slab Section ..... | 172 |
| Table 3.27: Provision of Steel for 32-ft., Haunched Slab .....          | 172 |
| Table 3.28: Reinforcement Design of 40-ft., Haunched-Slab Section ..... | 173 |
| Table 3.29: Provision of Steel for 40-ft., Haunched Slab .....          | 173 |
| Table 3.30: Reinforcement Design of 48-ft., Haunched-Slab Section ..... | 173 |
| Table 3.31: Provision of Steel for 48-ft. Haunched Slab .....           | 174 |
| Table 3.32: Reinforcement Design of 56-ft., Haunched-Slab Section ..... | 174 |
| Table 3.33: Provision of Steel for 56-ft. Haunched Slab .....           | 174 |
| Table 3.34: Reinforcement Design of 64-ft., Haunched-Slab Section ..... | 175 |
| Table 3.35: Provision of Steel for 64-ft. Haunched Slab .....           | 175 |
| Table 3.36: Reinforcement Design of 72-ft., Haunched-Slab Section ..... | 175 |
| Table 3.37: Provision of Steel for 72-ft. Haunched Slab .....           | 176 |
| Table 3.38: Design Capacities of Haunched Sections .....                | 177 |
| Table 3.39: Section Depths at Midspan and Abutment .....                | 197 |

## Acknowledgements

Completion of my master's thesis warrants recognition of numerous contributors who helped make this product a success. I first extend my sincere appreciation to Dr. Robert Peterman for entrusting me with the opportunity to work on this project. His advice, assistance, and supervision were very helpful in guiding me throughout the research. I wish to recognize my other committee members, Dr. Hayder Rasheed and Dr. Asad Esmaeily, for their comments and suggestions as well. I would also like to thank Mary Rankin, communications director for the College of Engineering at Kansas State University, for her assistance in editing this report.

The research presented in this report covers a broad subject area. In order to address the wide variety of topics related to this project, several people outside of Kansas State University were solicited for input. Without their help, results of this project would not have been as successful. I am pleased to mention the following individuals for providing advice, commentary, and resources that aided me in performing the research:

- Michael Knapp, Alaska Department of Transportation and Public Facilities
- Carl Fusilier, Arkansas Highway Department
- Dallas Forester, California Department of Transportation
- Amanullah Mommandi, Colorado Department of Transportation
- Joseph Cancelliere, Connecticut Department of Transportation
- Glen Lovelace III, Delaware Department of Transportation
- Sam Fallaha, Florida Department of Transportation
- Steve Nolan, Florida Department of Transportation
- Rick Renna, Florida Department of Transportation
- Paul Santo, Hawaii Department of Transportation

- Mike Ebright, Idaho Transportation Department
- Carl Puzey, Illinois Department of Transportation
- Jay Wasson, Indiana Department of Transportation
- Norman McDonald, Iowa Department of Transportation
- Mark Hite, Kentucky Department of Transportation
- Steve Lee, Louisiana Department of Transportation and Development
- Andrzej Kosicki, Maryland State Highway Administration
- Alexander Bardow, Massachusetts Department of Transportation
- Kristen Schuster, Michigan Department of Transportation
- Scott Westerfield, Mississippi Department of Transportation
- Dennis Heckman, Missouri Department of Transportation
- Kent Barnes, Montana Department of Transportation
- Kevin Donahoo, Nebraska Department of Roads
- Mark Richardson, New Hampshire Department of Transportation
- Michael Seniw, New York State Department of Transportation
- Tim Keller, Ohio Department of Transportation
- Bruce Johnson, Oregon Department of Transportation
- Thomas Macioce, Pennsylvania Department of Transportation
- Barry Bowers, South Carolina Department of Transportation
- Kevin Goeden, South Dakota Department of Transportation
- Gregg Freeby, Texas Department of Transportation
- Joshua Sletten, Utah Department of Transportation
- Mike Hedges, Vermont Department of Transportation



- Kendal Walus, Virginia Department of Transportation
- Mark Szewcik, Washington Department of Transportation
- Keith Fulton, Wyoming Department of Transportation
- Dr. Rollin Hotchkiss, Brigham Young University
- Joseffa Meir, HNTB Corporation
- Craig Mattox, Finney and Turnipseed, L.L.C.
- Steven Wilton, Wilson and Company, Inc.
- Rod Nicholson, Prestressed Concrete Inc.
- Mark Simpson, CORESLAB Structures

Furthermore, I extend special thanks to the Kansas Department of Transportation for funding this research project and sponsoring me throughout its completion. I would like to specifically recognize Jon Jones, Terry Fleck, Steve Burnett, Calvin Reed, and Loren Risch at KDOT for giving their time, advice, and direction as well. Their input has helped focus and steer the project toward a more useful and beneficial outcome.

Finally, I wish to express special gratitude to my parents, Dennis and Marlene Handke, and the rest of my family and friends who have been supportive of my educational endeavors, especially throughout my master's program. My college professors, former teachers, and several others not named here have oriented me along a professional direction and have had tremendous influence on my academic performance. I am forever grateful for all the people in my life who have invested in and contributed to my success.

# Chapter 1 - Introduction and Background Information

## Project Context

As of 2008, 25,464 bridges are in service in the state of Kansas. Of these, more than 75% are owned and maintained by city and county governments, while the remainder belong to the state (KDOT, 2008). Kansas currently ranks fourth in the nation in total number of bridges statewide (AASHTO, 2008). The large extent of the state's public infrastructure presents a significant concern as future funding levels for maintenance, repair, reconstruction, and replacement of these facilities remain uncertain.

On the state system, approximately 9% of bridges are classified as functionally obsolete, while 1% is classified as structurally deficient. Status of bridges on the local system is less favorable, with 8% classified as functionally obsolete and 13% classified as structurally deficient. Table 1.1 shows statistics on the condition of Kansas bridges (KDOT, 2008).

**Table 1.1: Functional Classification of Kansas Bridges**

| <b>Kansas Bridges At A Glance - Updated 11-14-08</b> |                     |                     |              |
|--|---------------------|---------------------|--------------|
|  | <u>State System</u> | <u>Local System</u> | <u>Total</u> |
| All bridges  | 5,047               | 20,425              | 25,464       |
| Structurally deficient                               | 59                  | 2,647               | 2,707        |
| Functionally obsolete                                | 442                 | 1,596               | 2,042        |
| Total % deficient & obsolete                         | 9.9%                | 20.7%               | 18.6%        |

Throughout the U.S., average bridge age is 42 years, while in Kansas is it 46 years (Transportation for America, n.d.). Based on these statistics, policy makers understand present and future challenges. As a large number of bridges reach the end of their design lives, new and

innovative solutions must be developed to adequately address replacement needs in an economical way.

Many Kansas bridges are located at river crossings. Additionally, several Kansas streams are characterized by intermittent rather than steady flow throughout the year. At these locations, structures known as low-water crossings may be used. Low-water crossings, like the one shown in Figure 1.1, are normally constructed by placing one or more adjacent box culvert structures until the required hydraulic capacity is provided (USFWS (1), 2012).



**Figure 1.1: Low-Water Crossing**

At many low-water crossings, it is not uncommon to see the stream completely dry throughout part of the year. In some cases, overfill may not be used to raise the road elevation as the expense is normally not justifiable. However, on rare occasions, such as during flash-flooding conditions, these structures convey much higher flow rates and may even experience inundation and overtopping.

River bridges face a set of challenges not experienced by bridges at road crossings. Performance of these structures is influenced by scour and erosion problems along the foundation elements. At high velocities, streams may undermine spread footings and pile bents. Figure 1.2 shows a pile bent with extreme scour problems (Caltrans, 2002). Loss of soil under the foundation leads to reduced bearing and skin friction areas, and a potential for settlement.

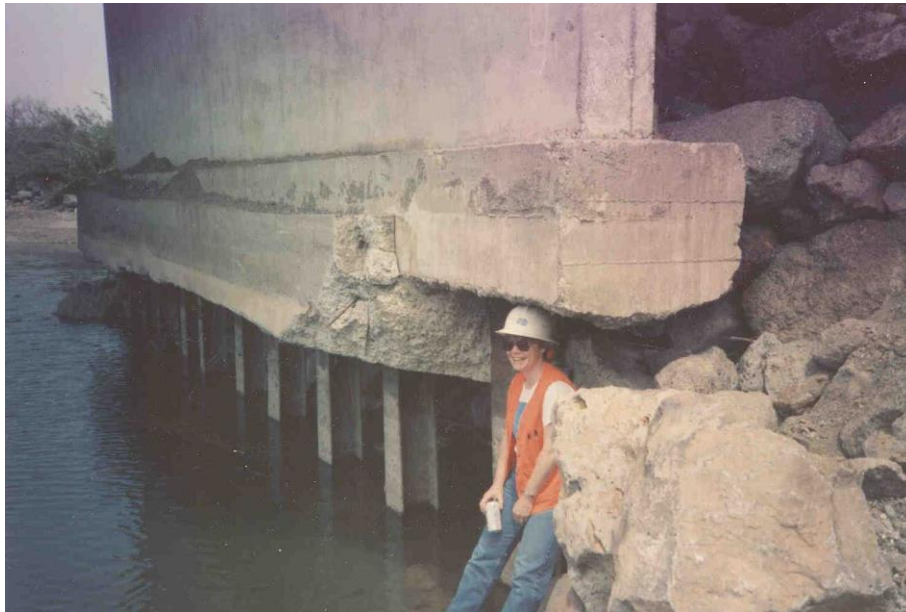

**Figure 1.2: Scour Under Bridge Pile Bent**

If substructural elements sink excessively, the bridge may become unstable and undergo structural failure. Collapse of the Schoharie Creek Bridge in New York in 1987 demonstrated the disastrous effects of unmitigated scour (NTSB, n.d.). Scour conditions are detrimental to safety and durability of bridges, and result in significant maintenance and repair needs. More information regarding scour and proper hydraulic design is provided later in the report.

Additionally, river bridges are frequently subject to impact from passing objects. After large rainfall events, rivers may carry driftwood, uprooted trees, and other debris downstream.

This material becomes easily wrapped around bridge piers, caught in shallow and narrow end-span regions, or lodged within the cells of box culverts. Removal of this debris presents a significant maintenance concern for bridge owners, who often have limited financial resources and understaffed work crews. In extreme cases, impact from passing trees or debris is sufficient to dislodge girders or remove piers entirely.

These problems are usually magnified for box culverts, such as the one shown in Figure 1.3 (Salem et al., 2008). Presence of multiple barrel walls, shorter spans, and lower headroom provides greater opportunity for these problems to occur. River bridges and culverts also experience lateral loads due to stream flow, and uplift when water elevations reach the girders or slab. The uplift force must be taken into consideration to prevent the superstructure from being carried away during extreme events.



**Figure 1.3: Box Culvert Obstructed with Driftwood**



In Kansas, box culverts are used extensively to span short streams. The current state standard uses a traditional, four-sided design. In these structures, the floor slab serves as the bottom of the stream channel. Use of four-sided box culverts has been known to create hydraulic and environmental problems. As a stream passes through a culvert, its flow characteristics typically change. Several interrelated hydraulic and environmental problems involve scour.

Scour problems are commonly initiated by the practice of placing a box culvert whose waterway opening is smaller than the natural stream width, as shown in Figure 1.4 (Frank, n.d.). Culverts are typically sized to minimize the length of the structure and reduce construction costs, while providing required design hydraulic capacity. The result is a narrower waterway opening with higher stream velocity inside the structure. The higher velocity is beneficial at reducing the likelihood of ponding and stagnant flow within the structure, but also contributes to contraction scour during high flow rates.



**Figure 1.4: Box Culvert with Narrow Waterway Opening**

As a result of scour, undercutting at the inlet and outlet of a box culvert is commonly observed. Figure 1.5 shows scour and undercutting at the edge of a box culvert (FEMA, 2009). Stream flow characteristics are a function of numerous parameters, including channel roughness. As the stream flows over natural soil, its velocity is relatively slow. As it flows across a concrete surface, its velocity increases. This change in velocity accompanies the effect of waterway contraction.



**Figure 1.5: Scour Adjacent to Box Culvert**

Environmental externalities accompany hydraulic effects resulting from four-sided box culverts. Many rivers and streams in Kansas are home to an abundance of aquatic life. Changes in channel flow in the vicinity of box culverts are known to have a detrimental effect on aquatic organism passage (AOP). In addition to the effects resulting from existing structures on aquatic life, construction of new bridges and culverts creates a similar disturbance for AOP.

These problems have caught the attention of the U.S. Environmental Protection Agency (EPA). Recently, the EPA has made it more difficult to obtain construction permits for any structure that threatens certain aquatic life in a natural stream passage. Types of structures built and means of mitigating hydraulic and environmental problems are influenced by these regulations. More detailed information about environmental mitigation will be presented later in the report.

When new bridges and culverts are constructed, the traveling public is often required to use detours for a lengthy amount of time. In other cases, the existing route may remain open for traffic, but at the expense of delays and fewer lanes open for service. Detours and traffic delays pose a significant cost to travelers. User costs include wasted time, fuel, and opportunity as a result of idling, lower speeds, or detours.

The Federal Highway Administration (FHWA) has implemented initiatives for bridge owners to use accelerated bridge construction procedures in new construction. When a new bridge is being selected for a project, construction time and cost are important parameters to be considered. A bridge system that minimizes user costs associated with delays is a desirable factor to be weighed during the selection phase.

As more box culverts reach the end of their design lives, environmental, hydraulic, and construction time concerns must be taken into consideration when determining the most appropriate replacement structure. While historically it would have been acceptable to replace existing box culverts with new ones, different types of structures are able to meet current needs while mitigating problems associated with box culverts. This report documents the development of a replacement bridge system for the existing Kansas box culvert standard which addresses these concerns.



## **Project Requirements**

The alternative solution to box culverts must meet a certain set of criteria. The new system must be a single-span structure in order to minimize the bridge's environmental and maintenance impact on the river or stream during construction, service life, and removal phases. It must be an open-bottom system utilizing the natural channel to achieve desirable hydraulic and environmental performance. The structure must be durable enough to withstand the effects of submersion and uplift during extreme rainfall events. The system should also allow for simple construction without use of large cranes or specialty contractor equipment.

The new system will take on two forms. A cast-in-place option will be developed for use in the absence of stringent construction time constraints, when maximum economy and structural efficiency are the guiding parameters. A precast option will also be developed for use when minimizing construction time is critically important. Target spans for the project range from 40 to 70 feet in 10-ft. increments, although the system would ideally be acceptable for use on spans as short as 20 feet. Bridge widths must range from 28 to 44 feet in four-foot increments. All cases will accommodate two, 12-foot-wide lanes with outside shoulders varying from two feet to 10 feet on each side of the roadway.

While the project title suggests the bridge systems will be tailored toward the replacement of box culverts, the solution is developed to serve a more general purpose. It is expected the bridge system can be used for any short-span environment meeting these criteria, regardless of whether a box culvert is currently in place. The bridges may be used for river crossings or road crossings, and for replacement projects or new construction.

## **Project Scope and Phasing**

Due to the extensive nature of research to be completed, work for the project is scheduled to be completed in three phases. Phase 1 involves a literature review and development of a preliminary design for the new bridge system. An extensive search and review of practices currently used in other states will be performed. Overlying parameters governing selection of the bridge systems will be investigated. This includes determining the most appropriate type of structure for the given span range, investigating various joint and construction details, and evaluating economic constraints which govern the design and construction process.

Two types of bridge superstructure systems will be selected. The first type will be the cast-in-place option. The second type will be the precast option. A compatible substructural system will be developed for use with each superstructural system. Input will be solicited from a wide variety of individuals and organizations throughout the U.S. After selection of types of bridge systems, a preliminary structural design will be developed for each, demonstrating the feasibility of both options.

Phase 2 of the project includes final design of the structural systems. Both superstructural and substructural options will be taken to full plan design. All design limit state calculations will be performed for all combinations of span length and roadway width specified in the scope of the project. Connections and joints will be designed, and final details for plan sheets will be calculated and developed.

Phase 3 of the project involves implementation of the bridge systems. Final load ratings will be calculated for each bridge. A training session will be developed to introduce the new bridge systems to KDOT policy makers, local governments, consulting firms, contractors, and maintenance personnel. Bridge engineers will be updated on design characteristics, rationale, and

benefits of the newly proposed bridge systems. The new structures will then be ready for use on Kansas roads and highways.

## **Report Outline**

This report presents the work completed for Phase 1 of the project. Chapter 2 contains the literature review of existing practices, procedures, and systems used by DOTs in other states. Chapter 3 documents selection of the cast-in-place option. Merits and rationale behind choice of the system are described. Analytical modeling of the bridge system and its results are included. Calculations showing adequacy of the proposed system are presented. Preliminary design of the structural system is finalized.

Chapter 4 shows development of the precast option. Due to limited use of precast products throughout the state of Kansas, this portion of the project has been de-emphasized. This chapter documents selection of the most appropriate bridge system based on a comparison of competing options, but does not include the design calculations shown for the cast-in-place system. As such, this chapter presents qualitative rather than quantitative information. Chapter 5 presents the summary and conclusions. Chapter 6 provides a set of recommendations for KDOT policy makers and an outline of future research to be completed within the scope of the project.

## **Chapter 2 - Review of Relevant Subject Literature**

This chapter contains a review of literature pertaining to the replacement of box culverts with other short-span systems. The review was extensive since the project covers a broad subject area. The information attempts to cover a wide variety of parameters, conditions, and options considered by engineers in selection and design phases of a bridge project. This includes hydraulic, environmental, structural, and construction aspects of the facility. The review highlights a number of systems and their merits in serving as a replacement for Kansas box culvert structures based on criteria specified for this research project.

Contents of the literature search are divided into several subchapters. The beginning subchapters provide a more in-depth explanation of the context in which the new structural system is being developed. First, a description of hydraulic problems experienced in streams near box culverts is given. Next, an overview of environmental problems observed in streams resulting from box culverts is included. A set of environmental performance guidelines for the new structural system is presented. By adhering to these constraints, the new system is more likely to satisfy the increasing and evolving number of environmental regulations. A brief introduction to accelerated bridge construction practices is included. Details of the current KDOT box culvert standard relevant to this project are then provided.

Remaining subchapters of the literature review document the search for solutions. A survey of practices used by DOTs in other states to mitigate environmental and hydraulic concerns for box culverts is presented. A set of alternative structures used for replacing box culverts is provided, drawing heavily from research on systems used in other states. These include a variety of three-sided and bottomless culverts for shorter spans, and conventional bridge systems for longer spans. All of these systems can be used to satisfy objectives outlined

for this project, as well as accelerated bridge construction requirements. The review also provides information on the substructural elements to be coupled with the superstructural systems mentioned earlier. Specifically, geosynthetic reinforced soil systems are discussed in greater detail.

## **Hydraulic Considerations**

Hydraulic factors are known to impact long-term performance of culverts and bridges from a structural standpoint. When any facility is constructed at a river crossing, the importance of proper hydraulic analysis and design cannot be understated. Historically, this aspect of the design process has not always been conducted, and many existing culverts and bridges were implemented while neglecting hydraulic effects. Because of this, hydraulic circumstances are cited as the cause for a majority of bridge failures in the U.S. (Hunt, 2009). This subchapter presents evidence of hydraulic problems experienced by rivers and streams in the vicinity of box culverts. Simple techniques for mitigating these concerns are provided.

One of the most important design aspects to consider for river bridges is scour. Scour occurs as water erodes soil from the channel bed. Scour is common near footings and foundation elements, along the wingwalls and inlet of a culvert, and immediately downstream from the culvert outlet. Potential for scour can be addressed by controlling river velocity and bridge alignment (Schall et al., 2012). Velocity is a function of several parameters. Most important are the channel's cross-sectional shape, width, depth, flow rate, elevation, pressure characteristics, and bed material roughness. Proper hydraulic design reduces the likelihood of scour problems.

One hydraulic aspect of bridge design includes properly sizing the waterway opening. Geometric properties of the waterway opening affect flow properties of the river and, hence, its susceptibility to scour. Many box culverts use a smaller waterway opening than would be

appropriate for bridges spanning the same stream. Contraction of the waterway reduces size and cost of the facility, but increases velocity of the water flowing through the structure. This change in stream velocity at the inlet and outlet of the culvert is conducive to scour in both locations. When culverts are replaced by bottomless structures, a larger opening is recommended to keep velocities low enough to prevent scour in a natural channel (Arneson et al., 2012).

Due to the variety of options that exist for replacing box culverts, scour research pertaining to the effects of structural geometry is especially relevant. The FHWA has conducted experimental research on scour conditions within bottomless culverts. The research studied the effects of wingwalls and the shape of waterway openings on the propensity for contraction scour to occur. Rectangular, moderately arched, and fully arched sections were subject to flow tests with and without wingwalls (Kerenyi, Jones, and Stein, 2003).

Research shows the shape of a bottomless culvert opening had minimal effect on the extent of scour within the structure. However, use of wingwalls did have an effect. Wingwalls exist to provide a smoother transition for the width of stream as it enters and exits the culvert. Presence of wingwalls reduces scour depth at the culvert inlet. Unfortunately, the experiment was limited to the modeling of flat channel bottoms with uniformly distributed flow characteristics, properties that may not be representative of real-world conditions (Kerenyi, Jones, and Stein, 2003).

For new structures, a few approaches to design are effective and practical. Designs that allow alignment, depth, width, and velocity of the river to remain unchanged, as it passes through a structure, minimize the hydraulic and environmental impact. This is most easily accommodated by providing an opening greater than the natural width of the channel. Artificially altering direction of the stream has adverse hydraulic consequences and should be avoided if

possible. Maintaining natural stream flow characteristics throughout the system is key to successful hydraulic performance. Avoiding man-made changes to the stream improves the likelihood of the channel remaining stable during the life of the structure (Lagasse et al., 2012).

Depending on characteristics of a river, scour problems can range from nonexistent to heavily problematic. Various techniques for mitigating scour exist when necessary. For new or replacement structures, sizing or resizing the structure to minimize scour is a proactive approach. In any case, depth of scour should be calculated in critical areas of the river for appropriate flow conditions. For new construction, foundation elements should be placed below the design scour depth (Lagasse et al., 2009).

If additional protection is desired, structural elements may be protected physically with riprap. Use of riprap is one of the easiest and cheapest methods of mitigating bridge scour. New structures designed with an appropriate waterway opening and scour countermeasures can be made to satisfy hydraulic requirements. However, even with a proper design, opportunity for scour still exists from large flow rates during extreme events. Proper monitoring and evaluation of a bridge's hydraulic performance is necessary for long-term functionality of the system (Lagasse et al., 2009).

## **Environmental Considerations**

This subchapter describes environmental problems resulting from use of culverts in stream channels. It includes research on effects of unnatural channel bottoms and narrow waterway openings on passage and migration of fish and other species within a river reach. Focus of these studies pertains to use of concrete box and metal pipe culverts of various shapes and sizes. Findings are applicable to the current KDOT four-sided, box culvert standard and other structures used throughout the Kansas highway system.

These problems have resulted in increased regulation of box culvert implementation by entities such as the EPA, U.S. Fish and Wildlife Service (USFWS), and U.S. Army Corps of Engineers (USACE), as well as state environmental agencies. Authority for these regulations is most commonly derived from various provisions of the National Environmental Policy Act, Clean Water Act of 1977, and Endangered Species Act of 1973, among others (Erickson et al, 2002). A list of protected animal and plant species for the state of Kansas is included in this subchapter. Finally, examples and models of current design practices used in other states to mitigate these environmental concerns are provided.

### *Effects of Culverts on Organism Passage*

When box culverts are placed in a river or stream channel, they are normally intended to facilitate continuous flow. Attention to river hydraulics has become an increasingly detailed part of the design process. However, in practice, many culverts fail to perform as designed from a hydraulic perspective. Hydraulic failures previously described have led to several noteworthy environmental problems. Environmental effects commonly observed are related to stream continuity, and transport of species and sediment.

As mentioned in the previous subchapter, scour is perhaps the most important hydraulic phenomenon for bridge engineers to address. Problems associated with scour extend beyond geotechnical and structural stability. Scour holes at the inlet of culverts can form deeply enough, that during periods of low stream flow, water pools at the entrance of a culvert rather than flowing through. Presence of debris lodged at the entrance or inside a culvert can also block stream flow. Even in cases without inlet scour or debris blockage, very low stream flow can result in water depths so small that organism passage through the culvert is impossible. In these



situations, the stream is discontinuous and the culvert imposes a barrier to organism migration (Bates et al., 1999).

Scour holes are equally likely to develop at the outlet of the culvert. Scour in the downstream portion of a river reach creates a different type of stream continuity problem. As downstream erosion increases, flow line elevation of the stream is lowered. Since elevation of the floor slab in the culvert remains the same, the stream undergoes an immediate drop at the exit of the culvert. If change in flow line elevation is large enough, river species will not be able to make upstream migrations past the culvert. Barriers to travel caused by culverts for river species have resulted in regulations requiring mitigation of these environmental problems (Fitch, 1995).

When water flows through a narrow culvert under normal conditions, contraction resulting from the narrow opening causes an increase in stream velocity inside the culvert. This velocity change can also be detrimental to passage of aquatic species. Fish attempting to migrate upstream must be able to overcome the stream velocity. If the velocity is too high within the culvert, aquatic species will be unable to pass and a stream continuity problem exists even though there is flow between the upstream and downstream sides of the facility (Baker and Votapka, 1990).

Just as hydraulic effects of culverts are known to inhibit passage of aquatic organisms, they are known to impact movement of land creatures as well. Land animals migrate along riparian areas and their habitats typically cross barriers imposed by man-made facilities. During normal and high stream flow, a conventional culvert conveys water across the entire width of the flat-bottomed section. Unless culverts are sized and designed to include natural stream banks, no riparian areas are available for passage of land creatures. Barriers to travel for land animals may be regulated the same as for aquatic organisms (Erickson et al., 2002).

Unique environmental and hydraulic effects are commonly observed within the channel and surrounding drainage area for rivers and streams that utilize box culverts. Occasionally, flow constriction caused by box culverts can result in flooding of unstream areas. In some cases, adjacent areas may even become wetlands. As water pools in the upstream environment, the reduced flow rate decreases the chances of flooding in the downstream environment. Reduction in stream flow occurring from channel constriction can reduce streambed erosion and cause excessive sedimentation upstream from the structure (RSCP, 2011).

When a culvert is removed, a structure with a larger waterway opening may likely be chosen as its replacement. This may cause unintended consequences within the channel and surrounding areas. Elimination of river constriction may result in draining of upstream wetland areas, some of which may have become environmentally protected during the life of the structure. Removal of flow barriers causes the stream to flow at higher velocities in the upstream portion of the reach. This increases the chances of streambed erosion (RSCP, 2011).

Higher flow rate in the downstream portion of the river reach may cause flooding of adjacent areas where this was previously not occurring. Sediments that had been blocked by the culvert will now reach downstream environments. If a new type of structure is implemented, environmental and hydraulic changes will occur in the river and surrounding areas. These changes must be adequately addressed in the design of the new facility in order to ensure desirable environmental and hydraulic performance (RSCP, 2011).

A variety of structural shapes are used to span stream crossings. Different shapes and different types of structures are known to perform differently with respect to environmental considerations. While all structures will impose some form of environmental impact, traditional bridges are known to be more favorable to organism passage than culverts. Use of bridges will

avoid vertical stream jumps associated with culvert floor slabs. Waterway constriction is normally less severe with bridges, lending to more preferable stream flow and velocity characteristics through the structure. Presence of wider stream banks beneath most bridges allows for greater land species migration. In many cases of sensitive streams, conventional bridges may be recommended over use of culverts due to better accommodation of organism passage (Blank et al., 2011).

### ***Protected Species***

Presence of an endangered species is a common cause for required environmental mitigation at stream crossings. USFWS maintains a list of species, by state, that are protected by federal environmental regulations. In the state of Kansas, the following animal species are known to exist and are protected: gray bat, American burying beetle, whooping crane, Neosho madtom, piping plover, Arkansas River shiner, Topeka shiner, spectaclecase, pallid sturgeon, and the tern. The following animal species are protected but are not currently known to exist in the state of Kansas: Indiana bat, snuffbox mussel, and the gray wolf. The black-footed ferret is known to exist in the state of Kansas but is not protected here (USFWS (2), 2012).

The following plant species are known to exist in the state of Kansas and are protected: Mead's milkweed and the western prairie fringed orchid. The running buffalo clover is a plant species that is protected but not known to exist in the state of Kansas. If it is determined that any of these species are affected by removal of an existing bridge system or construction of a new bridge system, the effect must be mitigated in an environmentally acceptable and lawful manner (USFWS (2), 2012).

### *Mitigation Techniques*

In response to the known consequences of stream obstructions on the vitality of aquatic life, various environmental regulations have been enacted. These regulations have resulted in changes to standards and procedures governing design and construction of new culverts and bridges. The goal of these changes is to mitigate future environmental problems that would arise in sensitive streams.

Stringency and applicability of these regulations may vary at different locations, since some rivers and streams are more sensitive than others. Depending on conditions at a particular river or stream crossing, adherence to certain environmental guidelines may be mandated by governing regulatory agencies, or simply suggested as good practice. Several DOTs have adopted new provisions in their design guides based on research conducted by various individuals, groups, and entities. A model set of guidelines for environmentally friendly design at river and stream crossings is presented here.

One such group that has conducted research on environmentally friendly design at stream crossings is the River and Stream Continuity Partnership (RSCP). The RSCP is a consortium of academics, government officials, and environmentally focused non-profit organizations working extensively within the state of Massachusetts. It is comprised of members from the University of Massachusetts Amherst, the Nature Conservancy, the Massachusetts Division of Ecological Restoration-Riverways Program, and American Rivers (RSCP, 2011). Since the group's formation in 2006, it has developed a set of river and stream crossing standards consistent with environmentally acceptable practices.

The RSCP works with the Massachusetts Highway Department, Massachusetts Department of Environmental Protection, and Army Corps of Engineers to influence hydraulic and environmental design of structures on Massachusetts roads and highways (RSCP, 2009).

While numerous entities have made recommendations pertaining to the subject, RSCP guidelines are provided as the model in this report. Its guidelines were chosen because they are comprehensive and detailed in addressing hydraulic and environmental concerns previously listed. Moreover, structural designs adhering to RSCP recommendations have a record of achieving successful permitting in the environmentally conscious state of Massachusetts (RSCP, 2011).

Goals, recommendations, and suggestions developed by the RSCP are presented here. To address the root of several hydraulic and environmental issues at stream crossings, great emphasis is placed on maintaining full continuity of the river or stream before, during, and after it passes through a structure. The RSCP recommends engineers avoid use of structures that cause vertical and horizontal changes in the stream profile, waterway constriction, and changes in velocity and flow characteristics. If structures possess these features, acquiring approval for permitting will be difficult since they are the core of the AOP problem. Due to their improved facilitation of AOP, the RSCP typically recommends use of bridges over culverts (RSCP, 2011).

Even when environmentally friendly facilities are constructed, aquatic life may still not be immune from man-made hydraulic disturbances. In order to achieve this goal, the RSCP recommends engineers design and implement structures that avoid interaction with the river environment entirely, if possible. If this design practice can be upheld, it holds an added benefit. Habitat, migration, and swimming characteristics of individual species do not need to be monitored from an environmental standpoint, since any man-made changes to their environment have been avoided (RSCP, 2011).

Avoiding or at least minimizing stream disturbance during a structure's service life can be difficult, but achievable. Fortunately, it can be accommodated for many short-span crossings

which currently utilize box culverts. For short, single-span structures, the RSCP recommends sizing of span length to be at least 20% longer than the normal width of the channel (RSCP, 2011). This practice allows for a normal stream to pass through the structure without obstruction or constriction in its natural channel. It also avoids creation of vertical jumps and changes to the stream's horizontal alignment, and reduces the chance of debris blockage.

When a box culvert is to be replaced, environmental impact of its replacement will need be considered. In most circumstances, the RSCP recommends replacement of a culvert with a different type of structure to reap the most positive environmental benefit. Retrofits can be made for existing culverts to improve their environmental performance, but at the end of service life, construction of a new culvert should normally be avoided. Throughout the lifespan of a box culvert, changes occur in river flow patterns, channel characteristics, and adjacent watershed areas. Thus, when a new structural system is put into place, the river or stream must adjust to the new changes (RSCP, 2011).

As a general rule, the RSCP recommends all new structures be implemented with a few other considerations. Whether stream flow is continual or intermittent should not influence the type of facility to be constructed. Since intermittent streams perform the same function as continual streams in transporting species, sediment, and other material throughout part of the year, design criteria for structures in these regions should not discount their importance. All facilities should maintain a natural streambed to offer the most environmental benefit. While bridges are again preferred, three-sided and arched culverts can satisfy this constraint (RSCP, 2011).

In rare circumstances, a four-sided box culvert may serve with adequate environmental performance. The RSCP recommends the bottom slab of these structures be buried and covered

with overfill to simulate a natural channel after construction is complete. Backfilling the slab may allow characteristics of the streambed to reform with time. The slab should be buried at least two feet below the stream flow line. In order to avoid washout, depth of overfill should also be sufficient to prevent fill material from being removed during a 100-year design flow. To improve hydraulic properties further, fill should be the same or possess the same properties and characteristics of the natural channel bed material. In general, this practice of embedding box culverts should be avoided unless circumstances prevent use of a more desirable structure (RSCP, 2011).

Regardless of type of structure used, a scour analysis must be performed to guarantee foundation elements are safe from undercutting, exposure, and instability. Oversizing the structure to be 20% longer than the normal width of the channel assists in this aim. This setback creates a barrier for impact of scour on the foundation. Design must still take into consideration occasions when extreme flow rates will pass through the facility. Constriction may still occur during very large rainfall events, and this effect on scour and channel stability must still be evaluated (RSCP, 2011).

Previous suggestions pertain to passage of aquatic organisms. Passage of land organisms should also be considered. This concern may be addressed through the geometric criterion of openness. The RSCP recommends the ratio of cross-sectional flow area to span length should be greater than or equal to 0.82 feet. Openness ensures the height of the opening is sufficient for most non aquatic wildlife to pass through the structure without obstruction (RSCP, 2011).

Oversizing of span length provides for banks on each side of the stream. Not only is this area useful for scour protection, but it achieves continuity of riparian area for small animal passage. Man-made banks should not be excessively steep. The RSCP recommends an H:V ratio

of 1.5:1 be maintained. Adherence to these standards are helpful in ensuring new structures do not have detrimental effects on wildlife and AOP caused by culverts (RSCP, 2011).

The EPA provides advice and suggestions on ways to mitigate environmental problems posed by culverts as well. Their information pertains to concrete box culverts, and concrete and metal pipe culverts. Many design standards provided by the RSCP are reiterated by the EPA, demonstrating their research and recommendations are consistent with that of the regulatory community (EPA, 2003).

As a guide in the selection phase, the EPA prefers bridges or bottomless culverts over traditional box culverts in environmentally sensitive areas. When culverts or bridges are constructed or replaced at river crossings, the EPA recommends avoiding changes to the original channel alignment, width, depth, profile, and flow rate, similar to the RSCP. Stream velocities should remain comparable before, during, and after passing through a facility, accommodating easy upstream fish passage and migration (EPA, 2003).

When a culvert or bridge is constructed, flow line of the channel should pass closely through the centerline of the waterway opening. Ideally, the geometry of the channel should be left unchanged in the vicinity of the structure. However, in some occasions, it is necessary or highly practical to adjust stream alignment near a structure. Should a channel be redesigned, the EPA suggests modifications occur in the upstream portion of the reach, rather than downstream, if possible. This practice reduces scour problems near the structure's outlet. The EPA also recommendeds the channel be free of curvature within 50 feet of the structure, both upstream and downstream. Good hydraulic design of culverts and bridges will minimize processes of erosion and sedimentation (EPA, 2003).



Since channels may require reconstruction, a few guidelines are presented for this process. The EPA recommends flow line elevation and slope of the channel remain as similar as possible in the vicinity of the structure before and after construction. Ideally, channel slope should fall between the bounds of 0.5% and 1.0%, preventing stagnation and high velocities, respectively. In cases where high water velocities are expected, resting pools for aquatic organisms should be provided in areas adjacent to the inlet and outlet of the structure. Adhering to these guidelines provided by the RSCP and EPA will assist new structures in moving through the environmental permitting process (EPA, 2003).

### **Accelerated Bridge Construction Practices**

As of 2011, Americans are approaching three trillion vehicle-miles traveled per year. This trend is only increasing on urban, rural, highway, and off-system routes (BTS, 2013). Rising traffic volumes present a set of problems for DOTs and the traveling public. When our nation's aging infrastructure is replaced, construction results in road and lane closures, detours, congestion, and delays. This costs motorists time, fuel, money, and opportunity. Work zones also present a safety concern for motorists and construction workers. As traffic increases, these problems will only worsen.

One solution promoted by the FHWA is to develop practices and techniques that reduce the amount of on-site time needed to replace and construct new bridges. Use of these practices and techniques is referred to as accelerated bridge construction. The intended outcome of ABC practices is to improve efficiency of the procurement and construction aspects of a project, and deliver tangible and intangible benefits to all stakeholders. ABC seeks to reduce delay for the traveling public, thereby reducing motorists' costs and environmental impact, while improving safety, quality, and durability of the finished product (FHWA, 2013).

Facilitation of ABC requires focus throughout the planning, selection, design, and construction phases of a project (FHWA, 2013). While there is no single correct approach, there are a few similarities to most ABC projects. ABC practices and techniques can be quite detailed and only a very general introduction is presented here.

One important aspect pertains to use of prefabricated structural components. Use of precast concrete and other materials immediately ready for implementation are ubiquitous to ABC projects. When cast-in-place concrete is used, high early-strength mixes and rapid curing help meet project goals. Use of prefabricated materials is promoted for both superstructural and substructural elements (Culmo, 2011). In some cases, entire bridges are constructed from prefabricated elements. Other times, portions of a bridge are prefabricated, while the remainder is constructed by traditional methods. This hybrid practice captures partial, rather than full, ABC benefit.

In addition to use of prefabricated elements, number of components and scheduling of their implementation are other important aspects. Minimizing number of pieces to the bridge is an important goal in planning and selection phases. Using elements such as pre-topped beams, full-depth sections, and wide modular components help reduce the amount of construction work to be completed on site. In some cases, expensive and time-consuming use of formwork can be eliminated entirely from a project. Proper planning can ensure these members are delivered to the site at the appropriate time, minimizing delays and keeping schedules on the critical path. In some cases, entire sections of bridges can be connected off site and delivered to the final location by transport vehicle (Culmo, 2011).

In order to take advantage of ABC benefits, several states have expanded their design and construction policies to allow procedures aimed at reducing length of bridge construction

schedules. These efforts have been successful at achieving desired goals. A wide range in impact can occur depending on size of the bridge project, and nature and extent of ABC practices applied. Past experience shows reduction in construction time can vary from days to years, depending on the circumstances (FHWA, n.d.).

A few guidelines should still be maintained for projects considering ABC procedures. The economics of different materials, products, construction, and transportation can vary considerably from state to state, and even within states. While ABC can reduce construction and user costs, it may be offset by higher material and transportation costs. Impact of delays is much different in urban and rural areas. Also, quality, availability, and life-cycle performance of bridge components, and contractor experience in working with ABC projects, are not uniform throughout the U.S. Due to advantages offered to the traveling public, ABC practices should be considered for new bridge projects. However, DOTs should carefully balance these benefits against any potential drawbacks to their use. ABC may be the preferred policy in some cases, but unwarranted in others.

### **Existing KDOT Box Culvert Standard**

Previous subchapters describe desirable characteristics of structures spanning short streams. A variety of systems in use will be described and evaluated based on these characteristics. Traditional box culverts are one option. KDOT possesses standards, specifications, and policies for design, construction, and maintenance of box culvert structures. Box culverts are used throughout the state highway system and on local roads in Kansas. While these structures may be cast-in-place or precast, the cast-in-place option is most commonly used in Kansas.

The existing box culvert standard consists of a traditional four-sided design only. By utilizing the concrete floor slab as the channel bottom and waterway constriction in numerous cases, streams with KDOT box culverts are prone to hydraulic and environmental problems discussed earlier in this chapter. By consequence, use of these structures has become increasingly regulated.

The current state standard consists of two types of structures. One is called a reinforced concrete box (RCB), the other a rigid frame box (RFB). The difference between the two is in the structural design. RCBs are box culverts that lack significant internal fixity at the corners of the structure. These structures are considered to be hinged at the joints. This design minimizes transfer of moment between the top slab and barrel walls. Using this design reduces the need for large amounts of reinforcing steel to continue from the slabs into the barrel walls. Figure 2.1 shows available combinations of span-length and cell-height dimensions for KDOT RCBs (KDOT, 2011).

The figure uses a matrix to show the combinations of cell length and height for which full design plans have already been developed and approved by KDOT. Each cell of the matrix contains a distinct set of information. Boxed numbers 1, 2, and 3 indicate number of barrels that may be placed adjacent to one another. The unboxed number specifies height of fill, in feet, that may be placed over the culvert, based on the number of adjacent barrels used. Blue boxes indicate corresponding span length and barrel height is available in the existing standard. Orange boxes indicate a particular combination of span length and barrel height is unavailable (KDOT, 2011).

|              |                 | Span (ft)         |                   |                   |                   |                   |                   |                   |                   |                   |                   |                   |                   |                   |
|--------------|-----------------|-------------------|-------------------|-------------------|-------------------|-------------------|-------------------|-------------------|-------------------|-------------------|-------------------|-------------------|-------------------|-------------------|
|              |                 | 4                 | 5                 | 6                 | 7                 | 8                 | 9                 | 10                | 12                | 14                | 16                | 18                | 20                |                   |
| Height<br>ft | 20              | X X X<br>1 2 3    | X X X<br>1 2 3    | X X X<br>1 2 3    | X X X<br>1 2 3    | X X X<br>1 2 3    | X X X<br>1 2 3    | X X X<br>1 2 3    | X X X<br>1 2 3    | X X X<br>1 2 3    | X X X<br>1 2 3    | X X X<br>1 2 3    | X X X<br>1 2 3    | 20 15 15<br>1 2 3 |
|              | 18              | X X X<br>1 2 3    | X X X<br>1 2 3    | X X X<br>1 2 3    | X X X<br>1 2 3    | X X X<br>1 2 3    | X X X<br>1 2 3    | X X X<br>1 2 3    | X X X<br>1 2 3    | X X X<br>1 2 3    | X X X<br>1 2 3    | X X X<br>1 2 3    | 25 15 15<br>1 2 3 | 20 15 15<br>1 2 3 |
|              | 16              | X X X<br>1 2 3    | X X X<br>1 2 3    | X X X<br>1 2 3    | X X X<br>1 2 3    | X X X<br>1 2 3    | X X X<br>1 2 3    | X X X<br>1 2 3    | X X X<br>1 2 3    | X X X<br>1 2 3    | X X X<br>1 2 3    | 35 20 20<br>1 2 3 | 25 15 15<br>1 2 3 | 20 15 15<br>1 2 3 |
|              | 14              | X X X<br>1 2 3    | X X X<br>1 2 3    | X X X<br>1 2 3    | X X X<br>1 2 3    | X X X<br>1 2 3    | X X X<br>1 2 3    | X X X<br>1 2 3    | X X X<br>1 2 3    | X X X<br>1 2 3    | 40 30 30<br>1 2 3 | 35 20 20<br>1 2 3 | 25 15 15<br>1 2 3 | 20 15 15<br>1 2 3 |
|              | 12              | X X X<br>1 2 3    | X X X<br>1 2 3    | X X X<br>1 2 3    | X X X<br>1 2 3    | X X X<br>1 2 3    | X X X<br>1 2 3    | X X X<br>1 2 3    | X X X<br>1 2 3    | 50 40 40<br>1 2 3 | 40 30 30<br>1 2 3 | 35 20 20<br>1 2 3 | 25 15 15<br>1 2 3 | 20 15 15<br>1 2 3 |
|              | 10              | X X X<br>1 2 3    | X X X<br>1 2 3    | X X X<br>1 2 3    | X X X<br>1 2 3    | X X X<br>1 2 3    | X X X<br>1 2 3    | 50 50 50<br>1 2 3 | 50 40 40<br>1 2 3 | 40 30 30<br>1 2 3 | 35 20 20<br>1 2 3 | 25 15 15<br>1 2 3 | 20 15 15<br>1 2 3 |                   |
|              | 9               | X X X<br>1 2 3    | X X X<br>1 2 3    | X X X<br>1 2 3    | X X X<br>1 2 3    | X X X<br>1 2 3    | 50 50 50<br>1 2 3 | 50 50 50<br>1 2 3 | 50 50 50<br>1 2 3 | X X X<br>1 2 3    | X X X<br>1 2 3    | X X X<br>1 2 3    | X X X<br>1 2 3    | X X X<br>1 2 3    |
|              | 8               | X X X<br>1 2 3    | X X X<br>1 2 3    | X X X<br>1 2 3    | X X X<br>1 2 3    | 50 50 50<br>1 2 3 | 50 50 50<br>1 2 3 | 50 50 50<br>1 2 3 | 50 40 40<br>1 2 3 | 40 25 25<br>1 2 3 | 35 20 20<br>1 2 3 | 25 15 15<br>1 2 3 | 20 15 15<br>1 2 3 |                   |
|              | 7               | X X X<br>1 2 3    | 50 X X<br>1 2 3   | 50 X X<br>1 2 3   | 50 50 50<br>1 2 3 | 50 50 50<br>1 2 3 | 50 50 50<br>1 2 3 | 50 50 50<br>1 2 3 | 50 50 50<br>1 2 3 | X X X<br>1 2 3    | X X X<br>1 2 3    | X X X<br>1 2 3    | X X X<br>1 2 3    | X X X<br>1 2 3    |
|              | 6               | X X X<br>1 2 3    | X X X<br>1 2 3    | 50 50 50<br>1 2 3 | 50 50 50<br>1 2 3 | 50 50 50<br>1 2 3 | 50 50 50<br>1 2 3 | 50 50 50<br>1 2 3 | 40 40 40<br>1 2 3 | 40 40 40<br>1 2 3 | 40 25 25<br>1 2 3 | 35 20 20<br>1 2 3 | 25 15 15<br>1 2 3 | X X X<br>1 2 3    |
|              | 5               | X X X<br>1 2 3    | 50 50 50<br>1 2 3 | 50 50 50<br>1 2 3 | 50 50 50<br>1 2 3 | 50 50 50<br>1 2 3 | 50 50 50<br>1 2 3 | 40 40 40<br>1 2 3 | 30 30 30<br>1 2 3 | X X X<br>1 2 3    | X X X<br>1 2 3    | X X X<br>1 2 3    | X X X<br>1 2 3    | X X X<br>1 2 3    |
|              | 4               | 50 X X<br>1 2 3   | 50 50 50<br>1 2 3 | 50 50 50<br>1 2 3 | 40 40 40<br>1 2 3 | 40 40 40<br>1 2 3 | 40 40 40<br>1 2 3 | 30 30 30<br>1 2 3 | 20 20 20<br>1 2 3 | 30 30 30<br>1 2 3 | X X X<br>1 2 3    | X X X<br>1 2 3    | X X X<br>1 2 3    | X X X<br>1 2 3    |
| 3            | 50 X X<br>1 2 3 | 50 50 50<br>1 2 3 | 40 40 40<br>1 2 3 | 30 30 30<br>1 2 3 | 30 30 30<br>1 2 3 | 30 30 30<br>1 2 3 | X X X<br>1 2 3    | X X X<br>1 2 3    | X X X<br>1 2 3    | X X X<br>1 2 3    | X X X<br>1 2 3    | X X X<br>1 2 3    | X X X<br>1 2 3    |                   |
| 2            | 40 X X<br>1 2 3 | 40 40 40<br>1 2 3 | 30 30 30<br>1 2 3 | X X X<br>1 2 3    | X X X<br>1 2 3    | X X X<br>1 2 3    | X X X<br>1 2 3    | X X X<br>1 2 3    | X X X<br>1 2 3    | X X X<br>1 2 3    | X X X<br>1 2 3    | X X X<br>1 2 3    | X X X<br>1 2 3    |                   |
|              |                 | Span (ft)         |                   |                   |                   |                   |                   |                   |                   |                   |                   |                   |                   |                   |
|              |                 | 4                 | 5                 | 6                 | 7                 | 8                 | 9                 | 10                | 12                | 14                | 16                | 18                | 20                |                   |

**Figure 2.1: KDOT RCB Dimensions**

For some projects, the number or geometric configuration of the barrels may differ from what is shown in the figure. If dimensions or configurations are unavailable, the culvert can still be constructed as desired. In this case, it will have to be designed as a unique structure on a case-by-case basis, like a traditional bridge. Accordingly, this matrix is not a limit on dimensions and configurations of box culverts in service. Rather, it simply indicates those for which full plans and details are already designed and standardized for use in the state of Kansas.

RFBs differ from RCBs in the details at the junctions of the slabs and walls. RFBs use reinforcing steel that runs continuously from the top and bottom slabs into the walls. This detail

creates an internally fixed connection between the two components, allowing moment transfer. In these structures, a tapered haunch is formed at the corners, increasing section depth and providing room for the additional steel reinforcement. Figure 2.2 shows span-length and cell-height combinations available for KDOT RFBs (KDOT, 2011).

|              |                 | Span (ft)         |                   |                   |                   |                   |                   |                   |                   |                   |                   |                   |                   |                   |
|--------------|-----------------|-------------------|-------------------|-------------------|-------------------|-------------------|-------------------|-------------------|-------------------|-------------------|-------------------|-------------------|-------------------|-------------------|
|              |                 | 4                 | 5                 | 6                 | 7                 | 8                 | 9                 | 10                | 12                | 14                | 16                | 18                | 20                |                   |
| Height<br>ft | 20              | X X X<br>1 2 3    | X X X<br>1 2 3    | X X X<br>1 2 3    | X X X<br>1 2 3    | X X X<br>1 2 3    | X X X<br>1 2 3    | X X X<br>1 2 3    | X X X<br>1 2 3    | X X X<br>1 2 3    | X X X<br>1 2 3    | X X X<br>1 2 3    | 20 15 15<br>1 2 3 |                   |
|              | 18              | X X X<br>1 2 3    | X X X<br>1 2 3    | X X X<br>1 2 3    | X X X<br>1 2 3    | X X X<br>1 2 3    | X X X<br>1 2 3    | X X X<br>1 2 3    | X X X<br>1 2 3    | X X X<br>1 2 3    | X X X<br>1 2 3    | 25 15 15<br>1 2 3 | 20 15 15<br>1 2 3 |                   |
|              | 16              | X X X<br>1 2 3    | X X X<br>1 2 3    | X X X<br>1 2 3    | X X X<br>1 2 3    | X X X<br>1 2 3    | X X X<br>1 2 3    | X X X<br>1 2 3    | X X X<br>1 2 3    | X X X<br>1 2 3    | X X X<br>1 2 3    | 35 20 20<br>1 2 3 | 25 15 15<br>1 2 3 | 20 15 15<br>1 2 3 |
|              | 14              | X X X<br>1 2 3    | X X X<br>1 2 3    | X X X<br>1 2 3    | X X X<br>1 2 3    | X X X<br>1 2 3    | X X X<br>1 2 3    | X X X<br>1 2 3    | X X X<br>1 2 3    | X X X<br>1 2 3    | 40 30 30<br>1 2 3 | 35 20 20<br>1 2 3 | 25 15 15<br>1 2 3 | 20 15 15<br>1 2 3 |
|              | 12              | X X X<br>1 2 3    | X X X<br>1 2 3    | X X X<br>1 2 3    | X X X<br>1 2 3    | X X X<br>1 2 3    | X X X<br>1 2 3    | X X X<br>1 2 3    | X X X<br>1 2 3    | 50 40 40<br>1 2 3 | 40 30 30<br>1 2 3 | 35 20 20<br>1 2 3 | 25 15 15<br>1 2 3 | 20 15 15<br>1 2 3 |
|              | 10              | X X X<br>1 2 3    | X X X<br>1 2 3    | X X X<br>1 2 3    | X X X<br>1 2 3    | X X X<br>1 2 3    | X X X<br>1 2 3    | X X X<br>1 2 3    | 50 50 50<br>1 2 3 | 50 40 40<br>1 2 3 | 40 30 30<br>1 2 3 | 35 20 20<br>1 2 3 | 25 15 15<br>1 2 3 | 20 15 15<br>1 2 3 |
|              | 9               | X X X<br>1 2 3    | X X X<br>1 2 3    | X X X<br>1 2 3    | X X X<br>1 2 3    | X X X<br>1 2 3    | 50 50 50<br>1 2 3 | 50 50 50<br>1 2 3 | 50 50 50<br>1 2 3 | X X X<br>1 2 3    | X X X<br>1 2 3    | X X X<br>1 2 3    | X X X<br>1 2 3    | X X X<br>1 2 3    |
|              | 8               | X X X<br>1 2 3    | X X X<br>1 2 3    | X X X<br>1 2 3    | X X X<br>1 2 3    | 50 50 50<br>1 2 3 | 50 50 50<br>1 2 3 | 50 50 50<br>1 2 3 | 50 50 50<br>1 2 3 | 50 40 40<br>1 2 3 | 40 25 25<br>1 2 3 | 35 20 20<br>1 2 3 | 25 15 15<br>1 2 3 | 20 15 15<br>1 2 3 |
|              | 7               | X X X<br>1 2 3    | 50 X X<br>1 2 3   | 50 X X<br>1 2 3   | 50 50 50<br>1 2 3 | 50 50 50<br>1 2 3 | 50 50 50<br>1 2 3 | 50 50 50<br>1 2 3 | 50 50 50<br>1 2 3 | X X X<br>1 2 3    | X X X<br>1 2 3    | X X X<br>1 2 3    | X X X<br>1 2 3    | X X X<br>1 2 3    |
|              | 6               | X X X<br>1 2 3    | X X X<br>1 2 3    | 50 50 50<br>1 2 3 | 50 50 50<br>1 2 3 | 50 50 50<br>1 2 3 | 50 50 50<br>1 2 3 | 50 50 50<br>1 2 3 | 40 40 40<br>1 2 3 | 40 40 40<br>1 2 3 | 40 25 25<br>1 2 3 | 35 20 20<br>1 2 3 | 25 15 15<br>1 2 3 | X X X<br>1 2 3    |
|              | 5               | X X X<br>1 2 3    | 50 50 50<br>1 2 3 | 50 50 50<br>1 2 3 | 50 50 50<br>1 2 3 | 50 50 50<br>1 2 3 | 50 50 50<br>1 2 3 | 40 40 40<br>1 2 3 | 30 30 30<br>1 2 3 | X X X<br>1 2 3    | X X X<br>1 2 3    | X X X<br>1 2 3    | X X X<br>1 2 3    | X X X<br>1 2 3    |
|              | 4               | 50 X X<br>1 2 3   | 50 50 50<br>1 2 3 | 50 50 50<br>1 2 3 | 40 40 40<br>1 2 3 | 40 40 40<br>1 2 3 | 30 30 30<br>1 2 3 | 20 20 20<br>1 2 3 | 30 30 30<br>1 2 3 | X X X<br>1 2 3    | X X X<br>1 2 3    | X X X<br>1 2 3    | X X X<br>1 2 3    | X X X<br>1 2 3    |
| 3            | 50 X X<br>1 2 3 | 50 50 50<br>1 2 3 | 40 40 40<br>1 2 3 | 30 30 30<br>1 2 3 | 30 30 30<br>1 2 3 | X X X<br>1 2 3    | X X X<br>1 2 3    | X X X<br>1 2 3    | X X X<br>1 2 3    | X X X<br>1 2 3    | X X X<br>1 2 3    | X X X<br>1 2 3    | X X X<br>1 2 3    |                   |
| 2            | 40 X X<br>1 2 3 | 40 40 40<br>1 2 3 | 30 30 30<br>1 2 3 | X X X<br>1 2 3    | X X X<br>1 2 3    | X X X<br>1 2 3    | X X X<br>1 2 3    | X X X<br>1 2 3    | X X X<br>1 2 3    | X X X<br>1 2 3    | X X X<br>1 2 3    | X X X<br>1 2 3    | X X X<br>1 2 3    |                   |
|              |                 | Span (ft)         |                   |                   |                   |                   |                   |                   |                   |                   |                   |                   |                   |                   |
|              |                 | 4                 | 5                 | 6                 | 7                 | 8                 | 9                 | 10                | 12                | 14                | 16                | 18                | 20                |                   |

Figure 2.2: KDOT RFB Dimensions

For both RCBs and RFBs, available span lengths range from four to 20 ft. Rise heights range from two to 20 ft. In some cases, where multiple barrels are placed adjacent to one another, total length of a box culvert structure may reach 60 ft. or more. Geometrically, most barrel

shapes provided by the standard are reasonably square. When rectangular barrels are selected, the span is typically greater than the height. These specifications make the box culvert structures best suited for relatively narrow, low-flow stream crossings.

### **Survey of Short-Span Systems Used in Other States**

Use of environmental friendly designs at stream and river crossings has become increasingly common nationwide as regulations have become more stringent over the past few decades. In order to evaluate response, preferences, and mitigation efforts of bridge owners throughout the U.S., a survey was sent to all 50 state DOTs. The survey sought to determine what type of structures are commonly selected to span streams and narrow rivers, when environmental circumstances discourage or prohibit use of a traditional four-sided box culvert.

An attempt was made to observe and evaluate trends among the states. Participants in the survey were typically the most high-ranking officials in the bridge, structural, or hydraulic design sections of each state's DOT. While no span range was specified, the survey was focused on types of systems used for replacement of one or more adjacent box culvert sections. Table 2.1 shows each state's response to the survey, categorized by type of structure preferred.

Of the survey's recipients, 35 of the 50 states provided some form of feedback. A summary of their responses is provided here. Five states indicated they currently do not have a policy to address environmental regulations in short-span environments. Three states expressed that, like Kansas, they are in the preliminary phase of investigating environmentally friendly alternatives to box culverts. The remaining responses from the survey showed clear trends in the types of facilities being selected. Policies of 27 state DOTs can be easily classified into four categories: embedded four-sided box culverts, three-sided box culverts, proprietary bottomless culverts, and corrugated metal pipe culverts.

**Table 2.1: State Responses to Environmental Mitigation Survey**

| State          | Preliminary Investigation | Embedded Four-sided Box Culvert | Three-sided Box Culvert | Proprietary Bottomless Culvert | Corrugated Metal Culvert | No Policy | No Response |
|----------------|---------------------------|---------------------------------|-------------------------|--------------------------------|--------------------------|-----------|-------------|
| Alabama        |                           |                                 |                         |                                |                          |           | X           |
| Alaska         |                           | X                               | X                       |                                | X                        |           |             |
| Arizona        |                           |                                 |                         |                                |                          |           | X           |
| Arkansas       |                           |                                 |                         |                                |                          | X         |             |
| California     |                           |                                 | X                       |                                |                          |           |             |
| Colorado       |                           |                                 | X                       |                                | X                        |           |             |
| Connecticut    |                           | X                               | X                       | X                              |                          |           |             |
| Delaware       |                           | X                               |                         |                                |                          |           |             |
| Florida        | X                         |                                 |                         |                                |                          |           |             |
| Georgia        |                           |                                 |                         |                                |                          |           | X           |
| Hawaii         |                           |                                 |                         | X                              |                          |           |             |
| Idaho          |                           |                                 | X                       |                                |                          |           |             |
| Illinois       |                           |                                 |                         |                                |                          | X         |             |
| Indiana        |                           |                                 |                         |                                |                          | X         |             |
| Iowa           |                           | X                               |                         |                                |                          |           |             |
| Kansas         |                           | X                               |                         |                                |                          |           |             |
| Kentucky       |                           |                                 |                         | X                              |                          |           |             |
| Louisiana      |                           | X                               |                         |                                |                          |           |             |
| Maine          |                           |                                 |                         |                                |                          |           | X           |
| Maryland       |                           | X                               | X                       |                                |                          |           |             |
| Massachusetts  |                           |                                 | X                       | X                              |                          |           |             |
| Michigan       |                           | X                               | X                       | X                              |                          |           |             |
| Minnesota      |                           |                                 |                         |                                |                          |           | X           |
| Mississippi    |                           |                                 |                         |                                |                          | X         |             |
| Missouri       |                           | X                               |                         |                                |                          |           |             |
| Montana        | X                         |                                 |                         |                                |                          |           |             |
| Nebraska       | X                         |                                 |                         |                                |                          |           |             |
| Nevada         |                           |                                 |                         |                                |                          |           | X           |
| New Hampshire  |                           | X                               |                         | X                              |                          |           |             |
| New Jersey     |                           |                                 |                         |                                |                          |           | X           |
| New Mexico     |                           |                                 |                         |                                |                          |           | X           |
| New York       |                           |                                 | X                       | X                              |                          |           |             |
| North Carolina |                           |                                 |                         |                                |                          |           | X           |
| North Dakota   |                           |                                 |                         |                                |                          |           | X           |
| Ohio           |                           |                                 | X                       | X                              |                          |           |             |
| Oklahoma       |                           |                                 |                         |                                |                          |           | X           |
| Oregon         |                           |                                 |                         | X                              |                          |           |             |
| Pennsylvania   |                           |                                 |                         | X                              |                          |           |             |
| Rhode Island   |                           |                                 |                         |                                |                          |           | X           |
| South Carolina |                           | X                               | X                       |                                |                          |           |             |
| South Dakota   |                           | X                               |                         |                                |                          |           |             |
| Tennessee      |                           |                                 |                         |                                |                          |           | X           |
| Texas          |                           |                                 |                         | X                              |                          |           |             |
| Utah           |                           |                                 |                         | X                              |                          |           |             |
| Vermont        |                           | X                               |                         | X                              |                          |           |             |
| Virginia       |                           | X                               |                         |                                |                          |           |             |
| Washington     |                           |                                 | X                       | X                              |                          |           |             |
| West Virginia  |                           |                                 |                         |                                |                          |           | X           |
| Wisconsin      |                           |                                 |                         |                                |                          |           | X           |
| Wyoming        |                           |                                 |                         |                                |                          | X         |             |



Fourteen states indicated they embed the bottom slab of four-sided box culverts below the flow line. Soil is then backfilled over the slab, allowing for a natural channel bottom as it passes through the structure. Several states specified their depth of backfill ranges from one to two feet. For embedded culverts, modifications to the substructure are normally not required, since vertical loads can still be distributed throughout the large foundation in bearing with the floor slab. Geographically, the practice of embedding a traditional box culvert is not unique to any region of the U.S. It is, however, most common in states along the East Coast, followed by scattered use in the Midwest.

A few states that bury the floor slab of box culverts indicated they use other systems to mitigate environmental problems as well. Some states have both three-sided box culverts and embedded four-sided culverts in their inventory. Use of either is typically determined on a case-by-case basis. One prominent factor governing selection of these systems is the susceptibility of soil to scour. When hydraulic studies conclude a three-sided design would contribute to an unacceptable level of scour, several states opt for the embedded four-sided culvert.

Another challenge for use of three-sided box culverts is the competence of the soil beneath the structure. For soils with weak bearing capacity, a pile foundation may be necessary. Many states prefer this type of structure only when coupled with a spread footing foundation. When pile foundations are necessary, three-sided culverts are not as likely to be selected.

Twelve states have implemented three-sided box culverts. Some of these states have developed their own design standards and typical drawings much like the KDOT four-sided, box culvert standard. Others have not developed standards, but have policies, code provisions, and design specifications to which these structures must comply. In those states, each culvert is designed and approved on a case-by-case basis, similar to that of a traditional bridge. Several

states mentioned that precast culverts were used more commonly than cast-in-place structures. Geographically, use of three-sided box culverts is most common throughout the Mid-Atlantic, Great Lakes, Upper Rocky Mountain, and West Coast regions.

Fourteen states use one or more of the proprietary bottomless culverts. These systems are patented, commercially available, and modularized for a given set of span lengths and widths. The geometry of these structures may be arched or flat top. Overall, geographical use of proprietary bottomless culverts is more difficult to generalize. The systems are found in most regions of the country, but more commonly in the Northeast, Great Lakes, and West Coast regions. The most popular system is CON/SPAN, followed by HY-SPAN and BEBO Arch. Implementation of HY-SPAN products is more concentrated in the Northeast states, while CON/SPAN products are used throughout the country.

Two states indicated they frequently use large corrugated metal pipe culverts to span short stream and river crossings. Without modifications, these systems possess the same hydraulic and environmental drawbacks as concrete box or pipe culverts. The bottom of corrugated metal pipe culverts may be filled in with natural substrates to provide a channel bottom with acceptable environmental performance. Similar to embedded box culverts, these facilities can satisfy environmental regulations. In other cases, these structures may be bottomless, serving as the metal pipe equivalent to three-sided concrete culverts.

Some DOTs employ more than one of these structural types throughout their state. Overall, use of environmentally friendly designs for culvert structures is most prominent in the Northeast, Great Lakes, upper Rocky Mountain, and West Coast regions. Not surprisingly, the most environmentally sensitive and progressive states are the ones that have developed and

implemented policies pertaining to environmentally friendly stream crossings. These practices are observed far less often throughout the Midwest and the South.

Attitudes toward these practices vary considerably from state to state. Some states intend to minimize changes to their existing practices for as long as possible. Several states indicated they will maintain the practice of embedding four-sided box culverts if permitting agencies continue allowing them to do so. Other states, however, have been using three-sided culverts and proprietary bottomless culverts for more than 25 years.

Some states have been resistant to these changes, while others have been highly proactive in developing new designs, policies, standards, and specifications. Overall, there is no unified consensus among the states for selecting a system that mitigates environmental regulations for short stream crossings. However, a few different options are consistently used throughout a large number of states. Each category of systems is discussed in further detail in the following sub-chapters.

### **Embedded Four-Sided Box Culverts**

One technique used to bring box culverts into compliance with environmental regulations is constructing and implementing the structure with the floor slab embedded below the stream flow line. In this practice, a standard four-sided box culvert is used without modification. Substrates are either backfilled or allowed to settle over the floor slab with time so the channel maintains a natural bottom before, during, and after it flows through the structure. The depth of soil placed over the floor slab may differ between locations, but is commonly one foot or more (Bowers, 2011 and Lovelace, 2011).

In order to prevent discontinuities in the stream from occurring in the vicinity of the culvert, some states construct a streambed profile representative of the stream before and after it

passes through the culvert. Parameters considered in this procedure include the horizontal and vertical profile of the streambed, location and curvature of the thalweg, and compatibility of the soil used for the backfill (MassDOT, 2010).

An embedded box culvert may also be constructed such that it is hydraulically oversized, where the span length exceeds the natural channel width. This allows the presence of a strip of dry ground between the stream and the barrel walls during much of the year. This area can be used for conveyance of land creatures through the culvert, satisfying some states' environmental regulations (Cancelliere, 2011).

For longer box culvert structures, multiple barrels are typically used. Multi-span culverts may be implemented with all barrels embedded to the same depth. In some cases, multi-span culverts are placed with one barrel set lower than the others, creating a low-flow cell. The advantage of the low-flow cell is that the culvert can facilitate a greater stream depth in one barrel than would be possible if the stream flow was spread over the entire cross-section. During times of low stream flow, depth of water in the low-flow cell may be adequate to facilitate AOP (Kosicki, 2011).

Use of multiple barrel walls presents an obstruction which collects passing debris and driftwood. When multiple barrels are required, some DOTs opt for using single-span, conventional bridges or other systems instead. Properly sizing bridge waterway openings can reduce the maintenance concern associated with debris passage. Single-span bridges can easily achieve the goal of avoiding disturbance to the stream environment altogether. While more expensive than multiple-barrel culverts, traditional bridges are naturally proven and effective systems (Richardson, 2011).

Embedding a box culvert presents some challenges. In large rainfall events, the backfilled material may be eroded and washed away (Hansen et al., 2011). If this occurs, the owner may be required to redesign the channel and replace the lost soil. This practice would not be recommended in streams with unstable channels, as this maintenance problem could become a common occurrence.

The embedded, four-sided box culvert option presents the most minimal change to current practice. In this case, no changes are required in structural design. Differences exist in installation and maintenance procedures. Keeping the floor slab is this option's primary structural advantage. The floor slab allows gravity loads to be transferred over a large soil area. This keeps soil pressures low and prevents the need for a deep foundation. Deep foundations would preferably be avoided due to their additional cost and construction time (Kosicki, 2011).

The nature of applicable environmental regulations also dictates whether embedding a box culvert is a viable option. Embedding a box culvert may result in satisfactory environmental performance throughout the service life of the structure, but it will require disturbance to the natural channel during construction and implementation. If environmental regulations only affect the structure following construction, an embedded culvert may meet all requirements in a very cost-effective manner. In the case of highly sensitive streams, however, environmental requirements may forbid any disturbances of the natural environment, even if limited to the construction phase. In these situations, the practice of embedding box culverts is not likely to be permitted.

### **Three-Sided Box Culverts**

Four-sided box culverts have historically been used throughout the U.S. Standard drawings, details, and specifications were developed by state DOTs to govern design,

construction, and implementation of these structures. When required by regulatory agencies to overcome the hydraulic and environmental challenges presented by traditional four-sided box culverts, some states have elected to keep the essentials of the design but remove the floor slab. This change resulted in development of the three-sided box culvert.

In the three-sided design, the top slab and barrel walls remain similar to the four-sided design. The primary difference between the two systems exists in the nature of the foundation. In the four-sided design, the floor slab serves as the foundation. The slab has the function of distributing gravity loads over a large area, allowing bearing pressures in the underlying soil to remain relatively low. Consequently, settlement is normally minimal, likelihood of failure is reduced, and need for a conventional foundation is avoided. Due to removal of the floor slab in the three-sided culvert, modifications to the foundation are necessary to ensure functionality and performance of the system.

When the floor slab is removed, new elements must be added to the system to allow the transfer of gravity loads to the subsurface without excessive settlement, instability, or soil failure. When competent soils are present and bearing capacity is adequate, three-sided, rigid-frame culverts typically rest on strip footings (Kosicki, 2011). Strip footings serve as the least expensive and simplest conventional foundation available. Acceptable performance of three-sided culverts on strip footings has been achieved for properly designed systems. Care must be taken to ensure the structure is properly sized and that detrimental hydraulic effects are minimized. By using a short span with a shallow foundation, the facility is at elevated risk for scour problems (Kosicki, 2011).

Three-sided culverts are affected by unique scour problems not experienced by their four-sided counterparts. Four-sided culverts are typically subject to scour at the inlet and outlet. These

effects, associated with contraction of the waterway, affect three-sided structures in the same manner, but other scour concerns must be addressed as well. In these structures, geotechnical stability relies on performance of the footings. Excessive scour near the footings can result in undercutting, exposure, and bearing-capacity failure of the substructure. The shallow depth of footings increases their vulnerability. In three-sided culverts, relatively small amounts of scour can lead to foundation problems (Mommami, 2011).

As an alternative to spread footings, pile foundations can be used with three-sided culverts as well (Seniw, 2011). Regardless of the type of foundation used, the culvert will still have the same propensity for scour. When deep foundations are used, however, the defenses against scour are improved, since piles can carry structural loads below normal scour depths (Bardow, 2011). By extending the substructure deeper, more scour is needed to cause failure to the system. For any foundation, placing riprap in critical areas to protect against scour remains a common and effective practice for numerous DOTs (Lee, 2011).

Pile foundations can improve performance and safety of a three-sided system. The disadvantage to its use is the additional time and cost of construction when compared to strip footings. Economics of the structure can be quite favorable when shallow foundations suffice. However, when deep foundations are required, the primary advantage of the culvert is lost (Richardson, 2011). Despite the added robustness, some states avoid use of three-sided culverts when deep foundations are required, because of the higher costs. In several cases, DOTs have elected to use conventional bridges or other structural systems when piles are required. (Kosicki, 2011)

For longer crossings, conventional box culvert designs call for multiple barrels. Wide streams present a challenge for three-sided culverts, however. For bottomless structures, multiple

barrel walls will require some form of foundation. Use of strip footings in the stream will not likely be used because of scour. In this case, choice of either an embedded four-sided culvert, conventional bridge, or an alternative single-span structure will probably prevail (Richardson, 2011).

Regardless of whether a floor slab is used, all culverts must be properly designed to avoid hydraulic and environmental disturbances to natural streams. Three-sided culverts have been successfully used to comply with environmental regulations in other states. When implemented, the structures should be sized to exceed ordinary stream width. The 20% oversize policy serves as a useful guideline. These designs mitigate problems associated with constriction of the waterway and maintain consistent stream velocities through the structure. Continuity of the stream is achieved at the inlet and outlet of the culvert, satisfying requirements.

Another advantage to use of three-sided culverts is that DOTs can develop in-house standard designs for these structures, similar to their four-sided culverts. This practice has already prevailed in some states. By developing their own standards, DOTs should still be able to achieve the comparably low costs associated with their four-sided culverts. In other states, standard designs have not been generated, but three-sided culverts are still implemented. In those states, culverts are designed on a case-by-case basis, much like traditional bridges. In addition to environmental requirements, these facilities have a record of meeting DOT structural and economic goals for short stream crossings in other states. Modifying an existing state's box culvert standard into a three-sided design presents one of the less drastic changes to current practice.

The primary drawback to three-sided culverts is increased susceptibility to scour. While not unique to this type of facility, effects of scour cannot be understated, even for small



structures. Despite risks imposed by scour, successful performance of three-sided culverts with spread footings and piles foundations has been achieved in other states. While very useful in their application, culverts are typically limited in size to relatively short spans. As mentioned earlier, maximum span of a KDOT box culvert is 20 ft. To fit the purposes of this project, single spans up to 70 ft. are desired. Attempting to apply a modified box culvert to such a long span will require considerable redesign.

### **Proprietary Bottomless Culverts**

Another area of development in the mitigation of environmental regulations at short stream crossings has been design, construction, and implementation of proprietary bottomless culverts. These structures are typically made of non-prestressed, reinforced concrete, although some corrugated metal systems are available. Arched and flat-slab superstructures are common options. While referred to as culverts throughout this report because of their shape and other qualities, these systems could easily be characterized as bridges due to their span lengths and the nature of their open-bottom design.

The slabs are normally poured monolithic with abutment walls, which rest on foundation elements. Precast bottomless culverts usually come modularized in standard widths. Multiple sections are transported to the construction site and placed side by side to provide for the entire width of the roadway. The culverts are then backfilled and topped with a roadway surface.

Proprietary bottomless culverts have similarities with three-sided box culverts. They are usually composed of the same basic elements, including a bottomless, load-bearing frame, headwalls, and wingwalls. Types of foundations coupled with proprietary bottomless culverts are the same as for three-sided box culverts. Overall appearance of the systems resembles that of precast, three-sided culverts, the primary exception being the arch or other geometric variations

in the superstructure. They are implemented in the same short-span environments that box culverts are used for. A single span may be used for short crossings or sensitive environments where disturbance of the channel must be avoided. Multiple spans may be placed adjacent to one another in the same manner as box culverts for cases where a longer structure is needed.

Despite the similarities, there are a few noteworthy differences. While traditional box culvert standards are developed in house by state DOTs, proprietary bottomless culverts are designed, patented, and marketed by private-sector companies. These companies specialize in development, design, and optimization of these facilities. The designs are sold to DOTs, fabricated, and then implemented. Despite comparisons in overall shape of the facilities, geometric differences provided by arches and haunches are differentiating characteristics. These are details that make the systems easily identifiable and have been patented as intellectual property.

As a prefabricated structure, all reinforced concrete bottomless culverts are made of precast elements. Traditional box culverts may be cast in place or precast, depending on project scheduling, engineering concerns, economics, or preferences of each state. For states that predominately use precast box culverts, use of a proprietary bottomless culvert presents less of a change to the existing practice than for states that use cast-in-place box culverts.

While several companies exist, a few of the more noteworthy brands are summarized in this subchapter. These include CON/SPAN, BEBO Arch, HY-SPAN, and CONTECH structures. It should be noted that inclusion or exclusion of any particular brand in this report is not made on the basis of perceived merit. Facilities described in later subchapters were included because of their popularity in other states, as indicated by results of the previous survey. Nothing in this chapter constitutes an endorsement of any commercially available system. Nor should the

descriptions and comparisons be construed as the author's preference of any structural system. The author intends to provide objective descriptions only. Selection of a bridge or culvert system should always be conducted on a case-by-case basis, considering unique conditions of every project. The author does not believe any one system available can be guaranteed to adequately address all the concerns of every short-span bridge project.

### ***CON/SPAN Bridge Systems***

One type of proprietary bottomless culvert available for spanning short stream crossings is the CON/SPAN bridge system. CON/SPAN structures are patented products available through Contech Construction Products Inc. Central to the system is the distinct arched profile, monolithic with stem walls, used in all of its designs. Similar to other bottomless concrete culverts, CON/SPAN offers full precasting of all elements (CON/SPAN, 2010). Details of the CON/SPAN system, as well as the advantages and disadvantages of its use, are presented in this subchapter.

For all CON/SPAN systems, overall shape and geometric characteristics remain essentially similar. Unique designs are still provided for each culvert developed, however. General geometric details have been optimized for structural efficiency. The primary change is in the reinforcement design, since different structures will have different uses with varying design loads. CON/SPAN structures are used for a wide variety of applications. In addition to highway loading, they are used for railroad lines, underground storage, and storm water conduits. For this reason, the CON/SPAN system uses a design that is partially standardized yet still unique to the environment in which it is implemented (CON/SPAN, 2010).

Spans come available in preset lengths to ease the precasting process. Available span lengths range from 12 ft. to 48 ft., with rise heights varying from five feet to 14 ft. Table 2.2

shows available combinations of span length and rise, and also includes the area of waterway opening for each combination. Rise refers to the maximum clear distance from the bottom of the base of the structure to the underside of the arch at midspan (CON/SPAN, 2003).

**Table 2.2: CON/SPAN Bridge Sizes**

| Waterway Area<br>(ft <sup>2</sup> ) |    | Span Length (ft) |     |     |     |     |     |     |     |     |     |
|-------------------------------------|----|------------------|-----|-----|-----|-----|-----|-----|-----|-----|-----|
|                                     |    | 12               | 14  | 16  | 20  | 24  | 28  | 32  | 36  | 42  | 48  |
| Rise (ft)                           | 4  | 42               | 50  |     |     |     |     |     |     |     |     |
|                                     | 5  | 54               | 64  | 71  | 85  |     |     |     |     |     |     |
|                                     | 6  | 66               | 78  | 87  | 105 | 119 |     |     |     |     |     |
|                                     | 7  | 78               | 92  | 103 | 125 | 143 |     |     |     |     |     |
|                                     | 8  | 90               | 106 | 119 | 145 | 167 | 195 | 216 |     |     |     |
|                                     | 9  | 102              | 120 | 135 | 165 | 191 | 223 | 248 | 268 |     |     |
|                                     | 10 | 114              | 134 | 151 | 165 | 215 | 251 | 280 | 304 | 334 |     |
|                                     | 11 |                  | 148 |     |     |     | 279 | 312 | 340 | 376 | 435 |
|                                     | 12 |                  |     |     |     |     |     | 344 | 376 | 418 | 483 |
|                                     | 13 |                  |     |     |     |     |     |     | 412 | 460 |     |
|                                     | 14 |                  |     |     |     |     |     |     |     | 502 |     |

This table can be particularly helpful when designing the structure, should the engineer know the requirements of the hydraulic opening. The cross-sectional geometry of the river at the location of the bridge will dictate the most appropriate span and height dimensions to be selected. Much like traditional box culverts, if the desired span length or arch rise is not available, CON/SPAN can design a completely unique structure to satisfy the needs of a particular application (CON/SPAN, 2010).

The CON/SPAN system is made of four main components: arches, headwalls, wingwalls, and foundation. The arch, as well as the haunched fillet which connects to the stem wall, uses circular geometry. The arched superstructure comes in standardized modular sections which can be placed side by side for the full width of the roadway. Width of the modular arched section

varies from four to six feet. Narrower sections may be designed for any span if desired (CON/SPAN, 2010).

Because of the arched shape, the culvert requires placement of backfill and a roadway surface following implementation. Thus, the arch does not assume the burden of a wearing surface and is not directly subjected to traffic loads, rain and snowfall, de-icing salts, and other contaminants. While the arch is neither immune nor completely protected from infiltration, durability and performance of the system is improved by minimizing its contact with these agents.

Since the arch does not serve as the roadway surface, it also benefits from reduced live-load impact. On traditional bridges, motorists commonly feel the bump at the connection of the approach slab and bridge deck. Due to overfill and transition in the arch profile, a smoother change of stiffness is achieved with the CON/SPAN system. The curved geometry of the arch provides another added durability benefit. If water and de-icing salts percolate to the arch, the curvature provides a path for drainage. This reduces ponding of water on the superstructure (CON/SPAN, 2010).

Similar to the arches, headwalls come precast. Two types of headwalls are available: attached and detached. Attached headwalls are cast monolithic with the arches. Detached headwalls are cast separately and attached to the arches on site. A headwall may come in one piece, or several, depending on length of the span. CON/SPAN also uses a system of self-supporting wingwalls. Like the other components in the structure, the wingwalls are precast. The walls resist earth pressure through bending, similar to traditional wingwalls. One important feature is the set of anchors connected near the base on the back side of the wingwalls. During construction, backfill is placed over the anchors. The moment created from the soil placed on the

anchors counteracts horizontal earth pressure, resisting the overturning of the walls. The wingwalls are fabricated separately from the arches and are attached at the construction site (CON/SPAN, 2010).

The CON/SPAN system can be paired with multiple types of foundations, depending on soil conditions. Four types of foundations are commonly used: strip footings, pedestals, bottom slab, and piles. All foundation elements interface with the stem wall. The stem wall extends vertically and is monolithic with the arch. The stem wall functions as an abutment wall, carrying gravity loads to the foundation while resisting horizontal earth pressure in bending. In all cases, the bottom of the stem wall fits into a key joint in the foundation. The joint is grouted to provide a positive connection. All concrete foundation elements may be precast or cast in place (CON/SPAN, 2010).

CON/SPAN structures are most often placed on strip footings. The strip footing is the simplest and least expense foundation type. It will typically be used when soils possess high bearing capacity, allowing design forces to be distributed over a small area. If the arch rise or stem wall heights are insufficient to provide the necessary hydraulic opening, or if a large difference in vertical elevation between the roadway and the stream exists, the CON/SPAN structure may be placed on a pedestal. The pedestal works similar to a strip footing, but provides an elevated seat for the bottom of the stem wall. Pedestal height is determined on a case-by-case basis (CON/SPAN, 2010).

If it is determined a strip footing is not the most appropriate element for a particular CON/SPAN structure, the system will normally use a bottom slab or pile foundation. When connected to a slab bottom, the system resembles a four-sided box culvert. In this case, there are two components per modular section, one for the top slab and walls, the other for the bottom

slab. The slab is most commonly selected when soils with low bearing pressure are present. The slab distributes the design loads over a much larger area, reducing chances of settlement and soil failure (CON/SPAN, 2010).

Much like with four-sided box culverts, using the bottom slab option will not likely be permitted in situations where environmental regulations restrict the types of structure being placed. When environmental regulations and poor soils concurrently influence the design, a pile foundation will most likely be used. In this case, the stem walls are connected to the pile bents with the same grouted key joint used with other elements (CON/SPAN, 2010).

Selection of a foundation will always depend on conditions at the construction site. Since the project pertains to developing environmentally friendly alternatives to traditional four-sided box culverts, use of the bottom slab cannot be considered. Ideally, a foundation that minimizes project cost, time, and site preparation, without compromising safety, would be selected.

Strip footing will be the least expensive option and requires the least amount of site preparation. But, it will be the most vulnerable to scour, settlement, and instability. The pile foundation will require the most time and site preparation, and will be the most expensive solution. However, it is better equipped for mitigating poor soil and scour issues. For these reasons, strip footings and pedestals may not perform acceptably, or will be too risky in some situations, leaving piles as the only option. Piles are advantageous since they can extend well below the design scour depth and conservatively develop excess skin friction.

Several characteristics of the CON/SPAN system lend to its use throughout numerous states as an environmentally acceptable alternative to traditional four-sided box culverts. The strip footing, pedestal, and pile foundations can all be placed outside of the natural stream environment, allowing for a natural channel bottom. Scour, constriction, and velocity concerns

are easily satisfied by sizing the span to exceed the stream width by 20%. Since the superstructure is entirely precast, it can be transported to the site and lowered into place by crane. After attaching wingwalls and headwalls, the structure is ready for backfill. The entire construction process can be completed without disturbing a sensitive stream.

Since the system is entirely precast, CON/SPAN can meet the requirements for most accelerated bridge replacement projects. Precast systems also have the advantage of being produced in controlled conditions away from the effects of temperature, inclement weather, and other external factors. If proper controls are in place during fabrication, a very high-quality product may result. Use of precast products also reduces on-site construction work, and time and labor costs associated with this part of the project.

Even if the CON/SPAN system meets the environmental requirements for a project, there are some disadvantages to its implementation. Since the structures are proprietary, initial cost may be higher than for other nonproprietary structures. The system may carry a premium compared to other precast culvert and bridge designs currently approved by state DOTs. Individual states retain the ability to design their own nonproprietary three-sided culverts as long as none of the patented aspects of the CON/SPAN system are duplicated. Some states have already taken this course of action.

Similar to other precast modular systems, CON/SPAN structures require extensive use of joints to connect adjacent members. Joints are particularly vulnerable to wear and tear, infiltration of water and de-icing salts, and require extra precision during the construction process. While initial quality of precast products may be high, significant durability concerns from external contaminants present a large disadvantage to their use. Additionally, the longest available standard span length is 48 feet, well short of the 70-foot upper bound for this project.



While custom designs can be made for longer spans, these systems may carry an additional cost burden.

In some cases, a precast bridge may be more durable and longer lasting than a cast-in-place bridge. In other cases, durability and longevity of a precast bridge is considerably less than that of a cast-in-place system. This creates large variation in the life-cycle costs for a bridge project. Economics of cast-in-place and precast construction vary by state and region. Individual DOTs must evaluate appropriateness and suitability of both systems based on factors and preferences within their state.

### ***BEBO Arch Systems***

Another environmentally friendly, proprietary bottomless culvert available for use is the BEBO Arch System. Like CON/SPAN, the BEBO Arch is also a patented product available through Contech Construction Products Inc. (BEBO Arch Systems (1), n.d.). The BEBO Arch has important similarities and differences to the CON/SPAN system discussed earlier. It uses a system of precast, concrete arches modularly connected to adjacent sections. It is comprised of the same basic components found in other proprietary bottomless culverts. These include prefabricated arches, spandrel walls, wingwalls, and the foundation (BEBO Arch Systems (1), n.d.). Details of the BEBO Arch, a comparison to other options, and an explanation of the system's advantages and disadvantage are presented in this subchapter.

While making use of an arched concrete span, a major difference between the BEBO Arch and CON/SPAN systems is available span-length and rise-height combinations. While all CON/SPAN superstructures come as one monolithic piece, BEBO Arches may come in one or two pieces, depending on span length. One-piece BEBO Arches are used for shorter spans, ranging from 12 ft. to 50 ft. in length. Two-piece arches are available for longer spans, ranging

from 50 ft. to 100 ft. in length. In the case of the two-piece arch, rebar from the two arch elements are tied together at midspan. Use of two arch elements allows the BEBO system to span relatively long distances. With the longest spans reaching 100 ft., BEBO Arches cover the range of many single-span and short-span bridges (BEBO Arch Systems (2), n.d.).

Another important difference is in the geometry of the superstructure. While CON/SPAN uses a flatter arch element integral with two stem walls, the BEBO system uses the arch alone. CON/SPAN systems resemble an arched box in shape, while BEBO Arches are more semi-circular. The arches are prismatic throughout, with the exception of the thickening at the midspan joint in the two-piece arches (BEBO Arch Systems (2), n.d.).

Whereas CON/SPAN specializes in the same basic shape for all of its sections, the BEBO Arch comes in a variety of shapes. Three generalized designs are available, each geometrically suited for a different environment. One series of arches uses a circular shape. Circular arches are a good fit when span length and rise height are fairly balanced, or when large depths of overfill will be placed. Another series is elliptical in shape. These arches are suited for longer spans. The final option uses a flat profile. This series is used when limited headroom is available. The broad diversification of height and profile between different arch types allows the BEBO system to fit span and rise requirements for a wide variety of projects (BEBO Arch Systems (2), n.d.).

The BEBO Arch system also comes with precast spandrel walls similar to the headwall component of the CON/SPAN system. The spandrel walls come in one piece and are responsible for holding overfill in place. If desired, the BEBO Arch can be used in conjunction with mechanically stabilized earth (MSE). Foundations are designed on a case-by-case basis according to soil conditions at each project site (BEBO Arch Systems (1), n.d.).

BEBO systems are used not only on highway projects, but for railroads, airports, and several nontraditional applications as well. Due to the variety of possible design loads, each BEBO Arch receives a unique reinforcement design, while overall characteristics of the system remain consistent. Like CON/SPAN, a special BEBO Arch may be custom designed if none of the standardized systems adequately serve the bridge owner's needs for a particular situation. Multiple arches may be placed adjacent to one another when longer bridges are needed. A variety of façade options are also available for improved aesthetics (BEBO Arch Systems (2), n.d.).

Advantages of the BEBO Arch are similar to those of the CON/SPAN system. Proper sizing of the structure can address all hydraulic and environmental concerns presented earlier. By using total precasting of all elements, the entire system can be placed by crane with minimal or no stream disturbance. These qualities have allowed the BEBO Arch to successfully satisfy environmental regulations in other states. The span ranges available in the BEBO Arch system cover the full span range specified in this project, allowing the system to adequately address this criterion without the need for additional alternatives or custom-made solutions.

Since the BEBO Arch system comes completely precast, its construction time is minimized. Use of the system can meet ABC criteria and reduce the construction portion of project costs when compared to cast-in-place construction. Fabrication of BEBO Arches in a controlled environment can also result in higher initial quality of the structures. As a buried structure, the arch does not endure direct traffic loads like a bridge deck. The roadway surface protects the arch infiltration of rainwater, snow melt, and de-icing salts, improving the lifespan and long-term durability of the structure and reducing the need for maintenance.

Much like its advantages, BEBO Arches possess the same disadvantages as CON/SPAN systems. As a proprietary product, initial cost may be considerably higher than other precast or cast-in-place alternatives. DOTs and their consultants still have the option of designing similar nonproprietary structures, resulting in lower costs. As a modular system, joints are required to connect all components of the system together. These joints are subject to the wear and tear created from repetitive traffic loads and environmental effects, which can never be completely avoided. Durability of joints in any precast, modular system presents a major drawback to its use.

### ***HY-SPAN***

Another proprietary bottomless culvert option is the HY-SPAN system. As modular, precast concrete culverts, HY-SPAN products are similar to the CON/SPAN and BEBO Arch systems, but with a few notable differences. HY-SPAN structures use a flat-topped, rectangular, box design to contrast with the arched superstructures of the CON/SPAN and BEBO systems. The three-sided box culverts provided by HY-SPAN resemble traditional four-sided box culverts with the bottom slab removed. Uniqueness of the HY-SPAN system exists in design of the haunches at the corners of the structure. The slabs use tapered haunches in some cases and circular haunches in others (HY-SPAN, n.d.). Due to the internal fixity provided by the tapered haunch, HY-SPAN structures are similar to rigid-frame box culverts.

The HY-SPAN system consists of the same basic components as other proprietary, bottomless culverts. The superstructure is composed of a precast, top slab monolithic with abutment walls. Wingwalls and footings comprise the remainder of the system, either of which can be precast or cast in place. Wingwalls are self-supporting and attached to the structure on site. Strip footings are the foundation element commonly used when good soils are present at the project location. The superstructure is connected to the footings by means of a grouted key joint,

similar to the CON/SPAN and BEBO Arch systems. Upon placement of the modular units, the system is ready for joint sealant to be applied and backfilling to take place (HY-SPAN, n.d.).

HY-SPAN culverts come in a wide variety of size configurations. Available span lengths range from 6 ft. to 40 ft. Heights range from 2 ft. to 10 ft. The spans are available in one-foot increments, while the heights are available in one-inch increments. All possible combinations of length and height within these ranges are available (HY-SPAN, n.d.). The assortment of available size configurations improves the likelihood of a HY-SPAN product's suitability for a particular project.

The nature of HY-SPAN's superstructure allows it to function differently than other proprietary bottomless culverts. Because of its flat profile, the top slab can serve as the roadway surface. The process of backfilling the structure and applying a roadway can be avoided, saving time and money during construction. In several cases though, a wearing surface will still be applied to the top of the HY-SPAN system, similar to the procedure followed for most box culverts. If the tallest structures do not reach roadway elevation, overfill will be placed (HY-SPAN, n.d.).

Like CON/SPAN and BEBO Arches, unique designs for HY-SPAN structures are provided on each project. Overall geometric shape is the only standardized feature. HY-SPAN structures are used for multiple applications in addition to roadway bridges. Due to site-specific loads, the reinforcement is designed on a case-by-case basis. HY-SPAN systems can be designed to accommodate skews and curves in the roadway or stream alignment. Multiple HY-SPAN structures can be placed in series if bridge length requirements exceed the maximum available span length. The units do not come in predetermined modular widths. Modular widths are determined to fit the needs of each project (HY-SPAN, n.d.).

Like other proprietary bottomless culverts, HY-SPAN systems have satisfactorily served as a substitute for traditional four-sided box culverts in other states. Proper sizing and placement of the structure allows it to meet necessary environmental and hydraulic guidelines. The flat-topped superstructure presents a minimal change from the existing KDOT box culvert design. As a precast product, it is produced under carefully controlled conditions, increasing the potential for very high initial quality. Due to prefabrication, HY-SPAN structures can be implemented rapidly, reducing on-site construction costs and meeting ABC guidelines.

The HY-SPAN system has many of the same disadvantages as the precast culverts previously discussed. As a proprietary system, DOTs may pay higher up-front costs to receive a product that is similar to nonproprietary box culverts already within their inventory. Similar to any modular precast system, HY-SPAN structures require joints to connect adjacent members. These joints may degrade and deteriorate with time, resulting in poor performance and reducing long-term durability of the system. Also, the longest standardized span length for the HY-SPAN system is only 40 ft. This falls well short of the 70-ft. parameter specified for this project. Accordingly, another solution would have to be developed for longer spans.

### ***Corrugated Metal Plate Structures***

In addition to precast, bottomless, concrete culverts, CONTECH Construction Products Inc. patents several corrugated metal plate bridge structures. These bridge systems are constructed by bolting together several corrugated metal plates to form a culvert structure. CONTECH markets a variety of structural types including circular-, elliptical-, and pear-shaped culverts, to match the wide assortment of concrete culvert shapes available. A large selection of fully enclosed and bottomless culverts are produced. Most of the same shapes are available for

both fully enclosed and bottomless designs. Rectangular three- and four-sided, box culvert structures are manufactured as well (CONTECH Engineered Solutions, 2013).

CONTECH markets these products under different brand names. The SUPER-SPAN and SUPER-PLATE brands are primarily bottomless structures. SUPER-SPAN is very similar to SUPER-PLATE, with one exception. SUPER-SPAN uses corrugated steel plates, while SUPER-PLATE uses corrugated aluminum. The fully enclosed culverts are generally marketed under the MULTI-PLATE or Aluminum Structural Plate brand names. MULTI-PLATE, like SUPER-SPAN, uses corrugated steel. The three- and four-sided box culverts are aluminum structures only. Description of these brands is somewhat generalized as each brand offers some systems outside of the normal product line described here (CONTECH Engineered Solutions, 2013).

With such a large number of systems and configurations available, this report will consider only those marketed at satisfying environmental regulations for sensitive streams. These include the Low-Profile Arch, High-Profile Arch, the MULTI-PLATE Arch, and Box Culvert. The Low-Profile Arch is a group of structures tailored for low-volume stream flow and design situations where vertical clearances limit the height and opening of the structure. Available spans range from approximately 20 ft. to 45 ft. Rise varies from approximately 7.5 ft. to 18.6 ft. The Low-Profile Arch is available in steel and aluminum (CONTECH Engineered Solutions, 2013).

The High-Profile Arch possesses many of the same features of the Low-Profile Arch, except that its higher rise dimensions are made for larger flow volumes or projects where height restrictions do not govern selection of a structure. Span lengths range from approximately 20 ft. to more than 35 ft. Rise dimensions range from approximately 9 ft. to 20 ft. The High-Profile Arch is also available in steel and aluminum (CONTECH Engineered Solutions, 2013).

Both the Low-Rise and High-Rise Arch culverts use an elliptical shape. The steel and aluminum systems are marketed under the SUPER-SPAN and SUPER-PLATE brands, respectively. Both systems use stiffeners to prevent failure or excessive deformation of the thin, oblong arches. Other arch-shaped structures are available, but their use is intended for grade-separated crossings on highways and railroads (CONTECH Engineered Solutions, 2013).

A circular arch is available but is used for smaller waterway openings. Span lengths for the circular arch range from 6 ft. to 25 ft. Rise dimensions range from approximately 2 ft. to 12.5 ft. The circular arch is available in steel, under the MULTI-PLATE and Aluminum Structural Plate brands (CONTECH Engineered Solutions, 2013).

Finally, CONTECH also produces a three-sided, box culvert structure. The three-sided box culvert can be connected to a bottom plate, forming a four-sided box, if desired. This bottom-slab option is similar to the one offered by the CON/SPAN system. The box culvert is neither arch shaped nor rectangular, but uses a flat top with rounded corners, allowing the metal plates to make the geometric transition. Its spans range from 8.75 ft. to 35.3 ft. Its available heights range from approximately 2.5 ft. to 13.5 ft. The box culvert is available in aluminum plates only (CONTECH Engineered Solutions, 2013).

By measure of span range, the systems can be ranked from shortest to longest as MULTI-PLATE Arch, Box Culvert, High-Profile Arch, and Low-Profile Arch. For small streams where headroom is limited and avoiding disturbance of the stream is imperative, the box culvert maximizes the possible span-to-height ratio. Like the precast CONTECH products, multiple units have been placed side by side when longer structures are needed. CONTECH may provide custom designs if the required span length is longer than those currently available (CONTECH Engineered Solutions, 2013).



The metal plate arch structures rest on strip footings when soils with high bearing pressure are present at the site (CONTECH Engineered Solutions, 2013). For projects where environmental regulations are less restrictive, use of a fully enclosed culvert may be acceptable. In this case, the bottom of the pipe culvert may be filled with substrates to provide a natural stream channel. This option results in a more economical foundation design and reduces risk of settlement, scour, and soil failure during the life of the structure. Similar to embedding four-sided box culverts, the number of stream crossings where this practice may be allowed is unfortunately limited.

Metal plate structures are a unique alternative to existing box culverts. Cost of construction, maintenance, and the life cycle will be different than for concrete facilities. By using a different material, and by avoiding the costly adjustment of precast beds for various sizes, the economics of steel plate structures is different than precast concrete culverts. Construction time for metal plate structures may be different than for precast concrete products since the metal plates must be connected on site. However, construction should still take place much more rapidly than for cast-in-place concrete structures. The economics of cast-in-place, precast, and metal plate structures all vary from state to state.

Since SUPER-SPAN uses metal plates instead of reinforced concrete, a different variety of structural configurations is used. Unlike precast concrete structures, SUPER-SPAN systems are constructed by connecting a large number of components on site. For this reason, limitations on length, height, and weight during transportation do not affect the geometric configuration and overall design of metal plate systems (CONTECH Engineered Solutions, 2013).

Similar to the precast, bottomless, concrete culverts, metal plate structures have been successfully used to mitigate environmental regulations in other states, when properly sized,

proportioned, and fitted into place. A bottomless metal plate structure can be connected and fabricated at the construction site, then lowered by crane into its final location to avoid disturbing the stream environment. The systems can be implemented faster than cast-in-place facilities, contributing to reduced costs in the construction portion of the project and meeting ABC requirements.

One disadvantage to the metal pipe is the propensity for section loss due to erosion and corrosion throughout its lifespan. Protective measures are taken to ensure the durability of metal and concrete structures alike, but both will still undergo physical and chemical degradation. As a buried structure, the metal pipe will receive some shelter, but not total immunity, from the effects of traffic, de-icing salts, and water infiltration that commonly reduce the service life of a bridge deck or wearing surface. Suitability and performance of this type of structure should be carefully considered during the selection phase of a project.

Another disadvantage to CONTECH metal pipe structures is that the longest available span is less than what is required for the scope of this project. Maximum available span of 45 ft. falls short of the specified 70-ft. upper limit. Use for the shorter spans would be acceptable, but it would be preferable to have one system that adequately serves the full span range. Finally, as another proprietary system, CONTECH structures may be more expensive than nonproprietary alternatives. Patented products must compete with the economical concrete box and metal pipe culverts, and other systems already used by DOTs.

### **Conventional Short-Span Bridge Systems**

The previous subchapters have described structural systems used in other states that target relatively shorter span lengths. Box culverts and proprietary bottomless culverts are normally used to satisfy spans ranging from 3 ft. up to approximately 50 ft. While some span

further, they do not typify the systems traditionally used for distances of 40 ft. to 100 ft. The systems previously mentioned could serve as solutions for the lower end of this project's span range, but more alternatives should be investigated for the upper end of the span range.

This subchapter provides examples of short-span bridge systems currently used throughout the U.S. that could serve as appropriate replacements for box culverts. Due to the broad nature of systems available for this application, the list of suggestions is not all inclusive. Rather, a sampling of potential solutions the author felt was noteworthy and applicable for use in Kansas bridge design, construction, and maintenance environment is provided. The goal was to research and identify a few of the new, innovative systems successfully implemented in other states, in addition to traditional, conventional sections available.

For added benefit, all systems described in this subchapter are intended to meet qualifications for ABC requirements. Focus of these systems is primarily for their application as the precast solution for this project. Information is separated by state or geographic region in which specific practices are performed. First, guides for selection of the most appropriate superstructural system are presented. Then, a summary of some newly developed systems is provided. These descriptions cover not only superstructural systems, but details for joints, connections, toppings, safety barriers, and substructural components as well.

### ***Selection of the Superstructural System***

Many short-span environments present the question of what type of structural system is most appropriate. An extensive variety of section types are available to span rivers and streams. However, the number of options which are economical, well-suited, and appropriate in most situations is much more limited. River crossings have special concerns not relevant to road crossings. Providing adequate hydraulic capacity and freeboard is necessary in addition to

structural requirements. Ideal designs may be difficult for replacement structures since it is highly impractical to adjust bridge deck elevations or other geometric details in these circumstances.

For environmental reasons discussed earlier, multi-span culverts may need to be replaced with single-span systems. Hydraulic and environmental requirements will likely result in a replacement bridge that is longer than the existing structure. In these cases, selection and design of a replacement presents a new challenge. Depth of a longer, single-span structure would naturally exceed depth of the existing multi-span structure. Yet, requirements for the waterway opening must still be accommodated. A wider opening helps provide additional hydraulic capacity, but structural depth must still be limited. Deeper superstructures are also more vulnerable to impact from debris. When selecting replacements for box culverts, designs that minimize depth and maximize structural efficiency are of critical importance.

One common measure of structural efficiency is the span-to-depth ratio. Structural types considered for this project would ideally maximize the span-to-depth ratio. Figure 2.3 provides approximations of span-to-depth ratios for common structural shapes (Kamel and Tadros, 1996). Values for specific sections may vary from those shown. This figure is included to give engineers a rough estimation of the slenderness of various systems.

The figure demonstrates that inverted tees, slabs, and box beams rank as the most slender sections available for short-span bridges. KDOT already has standards and specifications for inverted-tee beams and AASHTO I-beams. Cast-in-place slabs are already used frequently throughout Kansas. These sections are likely to be highly suitable for the cast-in-place portion of the project. Precast slabs and box beams are less common in Kansas, leaving considerable room for their development as precast alternatives.

|                            |              |
|----------------------------|--------------|
| <i>AASHTO Beams</i>        | <i>12-20</i> |
| <i>Double Tee</i>          | <i>21</i>    |
| <i>Solid Slab</i>          | <i>26</i>    |
| <i>Multi-Stemmed Beam</i>  | <i>28</i>    |
| <i>Voided Slab</i>         | <i>30</i>    |
| <i>AASHTO Box</i>          | <i>31</i>    |
| <i>Cast-in-Place Slabs</i> | <i>31</i>    |
| <i>Inverted Tee (IT)</i>   | <i>31</i>    |
| <i>IT continuous</i>       | <i>35</i>    |

**Figure 2.3: Span-to-Depth Ratio for Common Structural Shapes**

While span-to-depth ratios are useful for identifying efficient shapes, care must be taken to ensure a shape is economical for a desired span length. Systems highly suited for very short or long spans are not likely to be appropriate for the 40-ft. to 70-ft. range considered here. Figure 2.4 provides guidelines for selection of a structural shape based on length and allowable depth of the section (Tokerud, 1979). This figure shows prestressed concrete shapes and is intended for the precast portion of this project.

Several of the shapes shown in the figure present a close fit for the desired span range. The box beam and bulb-tee girder are more economical for longer spans and are less appropriate for this project. The single tee and I-girder are the only sections that cover the entire proposed span range. The voided slab, multi-stem, and double-tee beams are close fits, but are less economical for longer spans. It is important to note the information in this figure is a guide and not a definite limit on application of each system. Each section can be shortened or extended beyond the lengths given to satisfy design constraints. Deviation from these parameters will, however, reduce the efficiency or economy of the section, and other choices may be preferred.









| Typical section   |               | Width (in.) | Depth (in.) | Span range (ft) |
|---|---------------|-------------|-------------|-----------------|
|    | Solid slab    | 36 to 96    | 10 to 18    | up to 30        |
|    | Voided slab   | 36 to 48    | 15 to 23    | 20 to 60        |
|    | Multi-stem    | 48          | 16 to 23    | 20 to 60        |
|    | Double stem   | 60 to 96    | 16 to 23    | 20 to 60        |
|   | Single stem   | 48 to 72    | 24 to 48    | 35 to 80        |
|  | Box girder    | 36 to 48    | 27 to 42    | 60 to 100       |
|  | Deck bulb tee | 48 to 84    | 29 to 41    | 60 or 110       |
|  | I-girder*     | 18 to 26    | 36 and 45   | 40 to 80        |

Figure 2.4: Guidelines for Selection of Structural Shapes

To supplement earlier figures, the California Department of Transportation (Caltrans) provides a guide for selection of precast, prestressed, structural shapes based on possible and preferred span lengths. This information is shown in Table 2.3 (Caltrans, 2012). The table shows several sections unfamiliar to the Kansas bridge environment and not contained in preceding figures.

**Table 2.3: California Prestressed Shapes by Recommended Span Length**

| Girder Type                   | Possible Span Length | Preferred Span Length |
|-------------------------------|----------------------|-----------------------|
| California I-Girder           | 50' to 125'          | 50' to 95'            |
| California Bulb-Tee Girder    | 80' to 150'          | 95' to 150'           |
| California Bath-Tub Girder    | 80' to 150'          | 80' to 120'           |
| California Wide-Flange Girder | 80' to 200'          | 80' to 180'           |
| California Voided Slab        | 20' to 70'           | 20' to 50'            |
| Precast Box Girder            | 40' to 120'          | 40' to 100'           |
| Precast Delta Girder          | 60' to 120'          | 60' to 100'           |
| Precast Double T Girder       | 30' to 100'          | 30' to 60'            |

Based on this table, the California shapes that completely fit the project's span range are the voided slab, box girder, and double tees. All three systems are fairly versatile, covering a variety of spans, ranging from very short to medium in length. I-girders fit the upper portion of the span range, but are not indicated to be as appropriate for shorter distances. Nevertheless, these sections could still be used for the full span range, at the expense of efficiency and economy. Ideally, one bridge system would be selected that effectively satisfies the entire extent of the project span range.

The Minnesota Department of Transportation (MnDOT) also provides recommendations on maximum economical span length of various bridge sections used in that state. Figure 2.5 shows one of Minnesota's guidelines for bridge selection (MnDOT, n.d.). The figure provides a

comparison of steel, prestressed concrete, reinforced concrete, and timber sections. The listed depths give an idea of the section size most appropriate for a given span length. This figure unfortunately does not provide lower bounds for span ranges, but rather maximum practical span lengths.

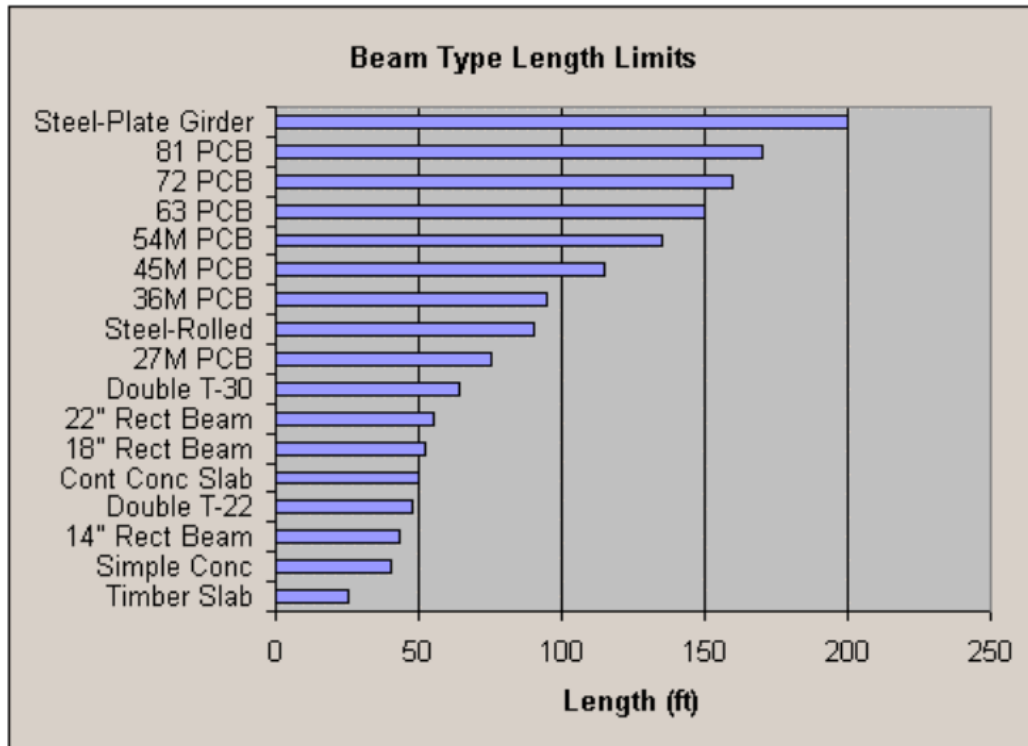

**Figure 2.5: Minnesota Bridge Types Based on Maximum Span Length**

Similar to California, the Minnesota sections most fitting for the project’s span range are the prestressed concrete I-girders and double-tee sections. While most of the I-girders are sized for long spans, the shallowest sections are appropriate for short-span environments. In addition to the deep I-girders, steel sections are not likely economical for spans as short as ones considered in this project. Conversely, timber slabs, concrete slabs, and rectangular concrete beams are shown to be too short for the span ranges of this project. (MnDOT, n.d.)



These figures demonstrate that shapes most appropriate for the short-span environment are the voided slab, single tee, double tee, I-girder, and box girder. It should be noted that some variation exists between the recommendations of these sources. The preferred span range for a shape varies from one state to another. However, the information is reasonably comparable and differences are relatively minor. The overall shapes are consistent with those used in other states, but design details will normally differ at least slightly.

Design changes, as well as economic factors unique to precasting in each state, lead to some differences in the suitability of certain sections for a particular span range. This explains why some sections may be recommended for somewhat longer or shorter spans in different states. Developing a section to fit this project's span range is likely to bear on economics as much as engineering. For this reason, selection of an appropriate shape should draw heavily from economic considerations of precasting in a particular state.

While serving as a good fit for the required span range, a disadvantage for I-girders and double tees is the height of the sections. A girder or double tee topped with a slab may reach three feet of total depth. For situations with limited headroom, use of these sections may result in insufficient hydraulic capacity due to reduced waterway opening. A more slender alternative would be ideal. As another disadvantage, the double tee is not recommended for roads with high traffic volumes or those treated with de-icing salts during winter weather. These drawbacks raise serious challenges to use of I-girders and double tees on highways in Kansas (MnDOT, n.d.).

### ***Innovative Practices in Minnesota***

Based on economic and span lengths consideration, a sampling of new, short-span practices in other states is presented. The state of Minnesota has a proactive policy toward use of innovative, ABC practices. MnDOT has implemented a variety of ABC bridge designs, ranging

from a unique inverted-tee system to concrete box beams and three-sided culverts. All these structures serve the purpose of spanning short stream crossings. This subchapter will discuss details of these types of structures.

In 2004, with the promotion of the FHWA, Minnesota began to develop a new short-span structural system. The goal was that the bridge be constructed rapidly and avoid any durability problems associated with precast systems that require extensive use of joints. After researching the ABC practices of several European and Asian countries, Minnesota produced a set of designs based on existing French bridges. The system uses a precast, inverted-tee beam with cast-in-place topping. After details for a few alternative designs were developed, the inverted-tee bridge was subjected to full-scale testing at FHWA research facilities to evaluate its effectiveness (Menkulasi et al., 2012).

Shape and dimensions of the Minnesota inverted tee are the differentiating characteristics between it and traditional inverted tees. The Minnesota section uses wider and thinner flanges than most traditional inverted tees. Individual sections are set adjacent to one another such that the edges of the flanges can be connected. A cast-in-place topping is poured over the inverted tees to create a flat roadway surface. The design maintains a topping thickness of 7 in. over the stems of the webs. Figure 2.6 shows the dimensions of two Minnesota inverted-tee sections placed adjacent to each other (Menkulasi, et al., 2012). The precast inverted tee is the darker shaded region. The cast-in-place topping is the lighter shaded region (Menkulasi et al., 2012).

The advantage of the system is that the inverted tees serve both as structural components and stay-in-place forms. The topping fills all the voids in the structure, creating a solid, full-depth, two-part slab. While the bridge still uses a cast-in-place topping, the precast sections eliminate the need for expensive formwork and reduce construction time. The final product

functions as a composite slab since stiffness and strength of the two concrete mixes are different. By using a solid slab, depth of the section is minimized. With a total depth just above 2 ft., the system is competitive with longer slabs and remains useful in situations where headroom is limited.

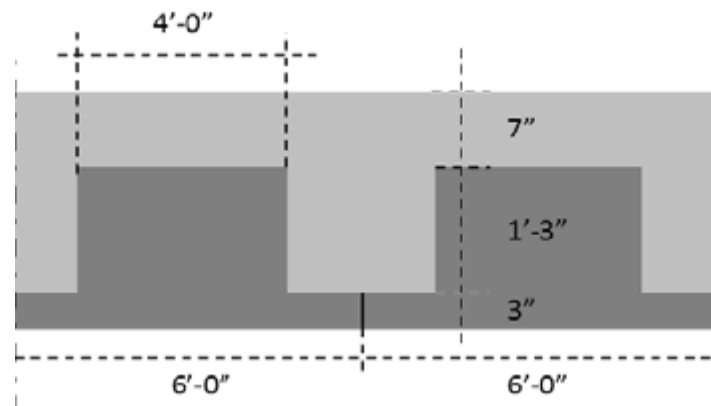

**Figure 2.6: Dimensions of Minnesota Inverted-Tee System**

After design, the FHWA tested different connections for modular sections. The goal of the testing was to observe the performance of these connections under transverse flexural loading, an important property for beam and beam-slab bridges. Testing sought to determine the load at which reflective cracking was observed between adjacent sections, and the load which produces ultimate failure of the system (Menkulasi et. al. 2012).

The first connection was simply a roughened surface on the interface between the cast-in-place and precast sections. This standard connection does not use mechanical connectors, relying instead on bond friction and interlock to hold adjacent sections together. This type of connection is the least expensive and easiest to detail and maintain. Figure 2.7 shows a detail of the Minnesota inverted-tee system with standard web design and no mechanical connectors (Menkulasi et al., 2012). Dotted lines indicate locations where reflective cracking is anticipated.

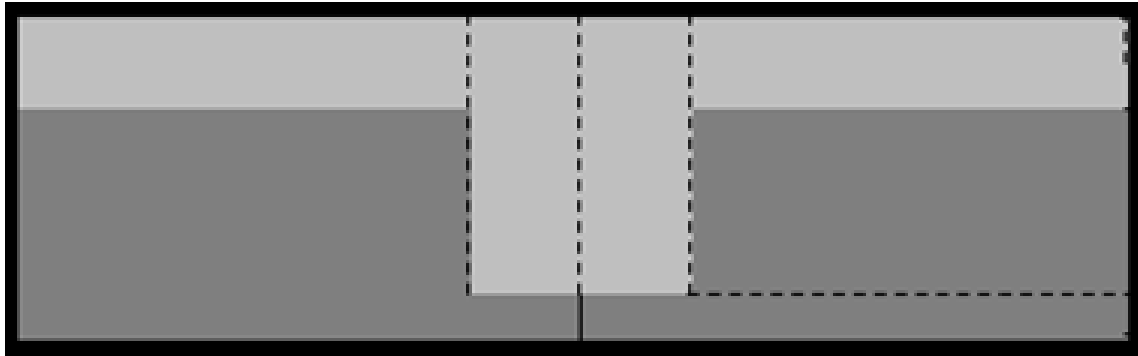

**Figure 2.7: Minnesota Inverted Tee with Standard Web**

An alternative connection uses hooked rebar extending from the inverted-tee web horizontally into the topping. The connection provides good interlock between the two components but is more difficult to produce. During precasting, the bars must be placed and embedded through holes in the forms. This adds time, expense, and difficulty to the production phase (Menkulasi et al., 2012). Figure 2.8 shows the Minnesota inverted-tee system with the hooked rebar connection (Piccinin and Schultz, 2012).

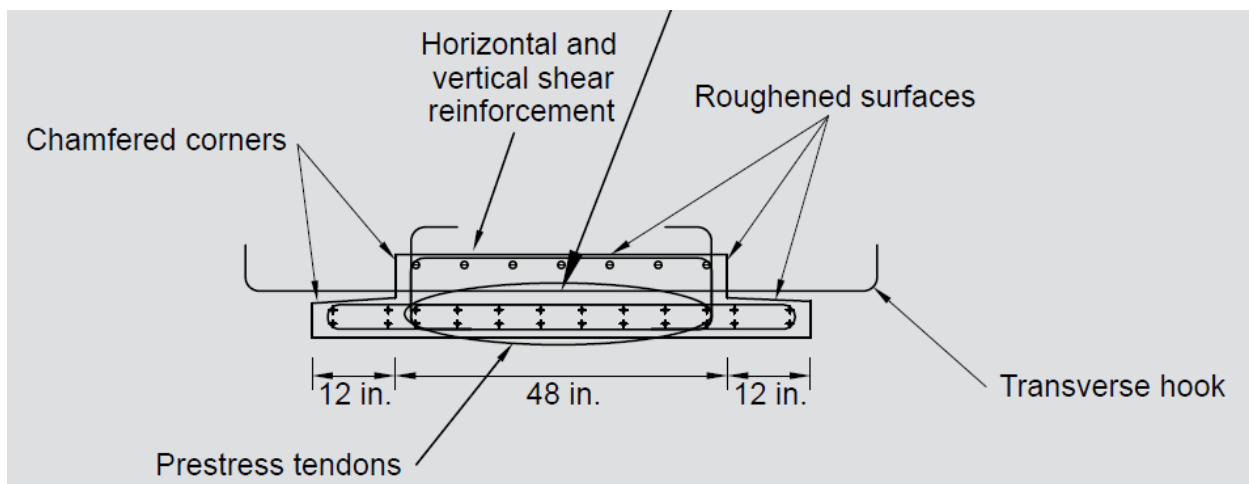

**Figure 2.8: Minnesota Inverted Tee with Hooked Rebar Connection**

Another connection is similar to the standard, nonmechanical connection, but forms the web at a  $46^\circ$  taper instead of the  $90^\circ$  rectangular detail. The goal of this connection is to improve performance of the concrete at re-entrant corners where high stress concentrations are observed. More re-entrant corners are created, but testing shows that higher loads are required to cause reflective cracking at these locations, due to less abrupt changes in their orientation. Figure 2.9, shows the Minnesota inverted-tee system with tapered web design (Menkulasi et al., 2012).

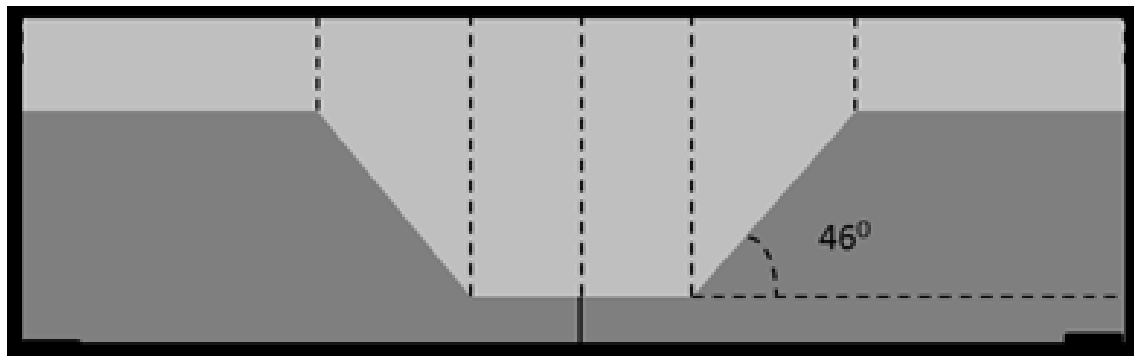

**Figure 2.9: Minnesota Inverted Tee with Tapered Web**

The final connection uses a system of embedded-plate connectors. As the name indicates, steel plates are placed during the precasting process into a taper formed in the flange of the inverted tee. When the sections are placed on site, a reinforcing bar is fitted into the groove in the joint. The rebar runs longitudinally with the bridge and is welded to the steel plates on each side. Like the hooked-bar connection, the embedded-plate connection is more difficult to detail and construct than those without mechanical connectors. Figure 2.10 shows a detail of the embedded-plate connection for the Minnesota inverted tee (Menkulasi et al., 2012).

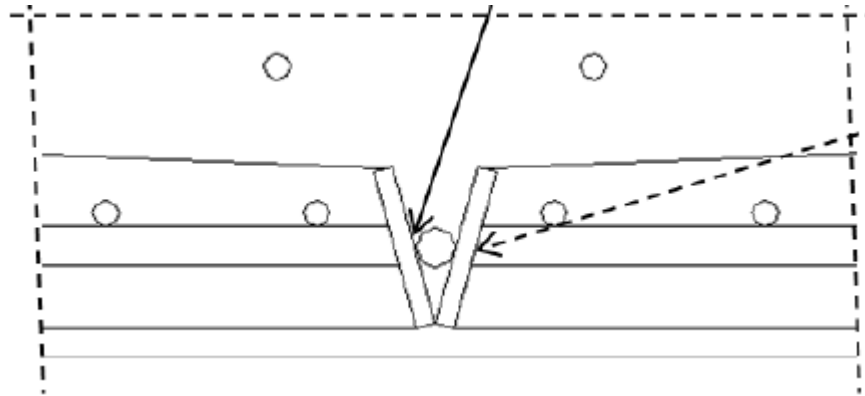

**Figure 2.10: Minnesota Inverted-Tee Embedded-Plate Connection**

Upon transverse flexural testing, it was observed that all four connections performed adequately under service load conditions. That is, the sections were not observed to crack or experience unacceptable deformations. The embedded-plate connection sustained the highest loads for cracking and ultimate failure. The tapered webs also sustained higher loads than the rectangular webs, as expected (Menkulasi et al., 2012).

One noteworthy observation was made regarding the standard, nonmechanical connection with rectangular webs. Not surprisingly, sections with this connection cracked and failed at the lowest loads. However, the system still performed adequately, well beyond service load conditions. While results suggest this connection is the worst performing, it may still be the preferred connection due to its favorable cost and maintenance characteristics. Since the simple connection proved adequate and acceptable for service loads, the expense of higher performing connections may not be merited or practical. Due to promising tests results and acceptance of the design, a two-span Minnesota inverted-tee bridge is currently scheduled for implementation at a site in Virginia (Menkulasi et al., 2012).

In addition to the inverted-tee bridge system, Minnesota also uses box-beam bridges for short-span stream crossings. Box beams are rectangular structures that contain a hollow

rectangular center. The void is created to reduce weight while increasing the depth of the section. Box beams can be a versatile bridge system since shallow sections can be used for short spans and very deep sections can be used for the longest spans. The most economical length and sizes of box beams vary by state. Like other precast systems, box-beam bridges use modular sections placed side by side during construction, (MnDOT, 2012).

During modular construction, care must be taken to ensure the sections are properly connected in the transverse direction. Minnesota box beams have been coupled with different types of transverse connections. Grouted shear keys are a common type of connection that has been used with this and other systems. In other cases, transverse post-tensioning has been used (MnDOT, 2012).

In some cases, Minnesota box beam bridges have been coupled with sheet-pile abutments. In these designs, circular steel piles have been used as the primary substructural component. The sheet-pile wall allows for reduced span lengths, similar to vertical wall abutments. The sheet pile not only holds back the abutting soil, but also protects the piles from scour in a stream environment. Pre-topped sections eliminate the need for cast-in-place topping. Use of pre-topped box girders has resulted in faster construction times than experienced with prestressed I-girders requiring cast-in-place topping (MnDOT, 2012).

While the primary structural sections can be fabricated and assembled easily and rapidly, railings or other protective appurtenances must be attached. For precast sections, railings can be cast integrally with the remainder of the superstructure at the plant. This is difficult and inefficient, however, since only exterior sections have railings and different forms will be needed for those members. Because of this, railings are often attached at the construction site. These railings can either be precast or cast in place. (MnDOT, 2012)

Concrete railings are most commonly used on highway and road projects. But in some cases, metal railings have been used. Metal railings can have an important time-saving construction advantage. Using metal railings can reduce the construction schedule since they can be connected by anchor bolts placed in the superstructure during casting. In this detail, no rebar is required. Metal railing weighs less than concrete railings, so dead load is reduced. A major factor that determines whether metal railings can be used is crashworthiness. Some metal railings have been approved for nonhighway or low-speed use, but have not yet received certification for highway traffic. In this case, metal railings are still a viable option for off-system routes (MnDOT, 2012).

### ***Innovative Practices in Nebraska***

In the 1990s, Nebraska sought to find an alternative design to replace many short-span, cast-in-place slab bridges. The goal of the search was to develop a system that would eliminate or reduce the need for expensive formwork on cast-in-place structures. Many of the bridges to be replaced had spans less than 100 ft. and were located at stream crossings. Headroom is an issue at these locations due to freeboard requirements. This prompted the search for a system that would satisfy the need for a large span-to-depth ratio, yet still remain economical for a range of span lengths. Consideration was also given to the fact that many of these bridges would be built in rural areas where fewer contractors exist and access to large-scale construction equipment is limited (Kamel and Tadros, 1996).

After studying several options, the inverted-tee system was selected. As a precast section, formwork would be unnecessary on the construction site. Similar to the Minnesota inverted tee, the girder flanges are wide enough that adjacent modular sections touch after placement,



providing a flat underbody for the bridge. For the Nebraska section, no positive connection exists between the flanges (Kamel and Tadros, 1996).

Voids between the webs are filled with polystyrene block at the construction site. The girders are then topped with a 6-in., cast-in-place deck. The blocks provide a flat surface for the placement of the deck, allowing the bridge to be constructed without the need for formwork. The blocks are very lightweight and do not contribute to the weight or strength of the section in any significant manner. Figure 2.11 shows a detail of the Nebraska inverted-tee beam system (Kamel and Tadros, 1996).

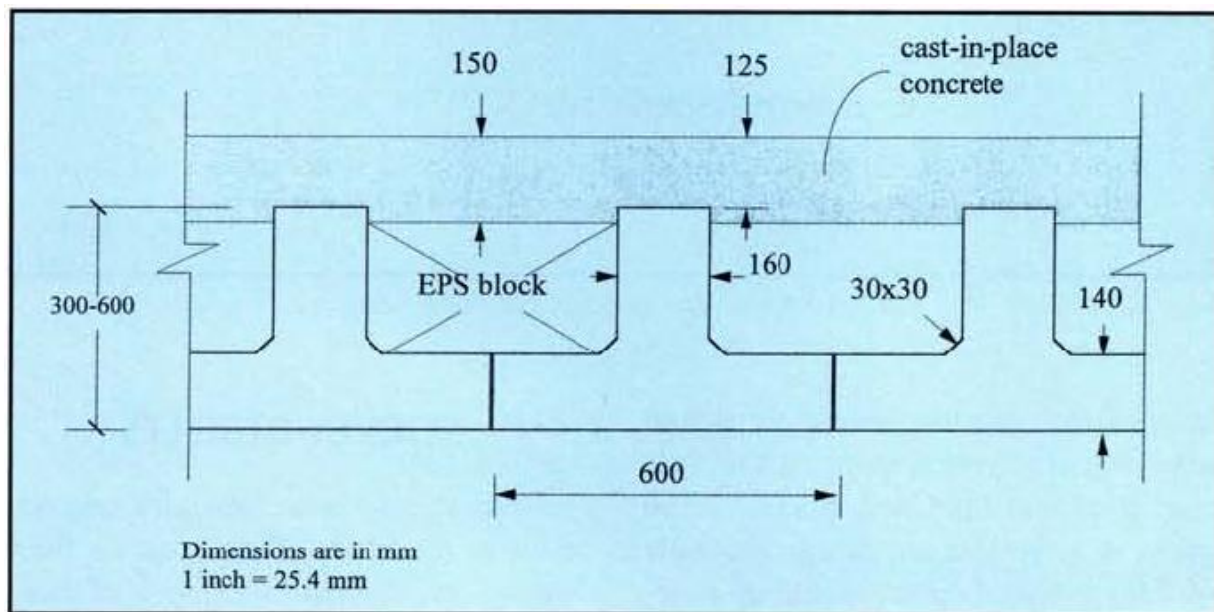

**Figure 2.11: Nebraska Inverted-Tee System**

A benefit of the new system is that the same set of forms can be used to produce every inverted-tee section in the standard. The flange design is identical for all sections. When a deeper beam is needed, height of the web is the only geometric change. Precast formwork can easily

accommodate varying heights. Simplicity of the inverted tee's fabrication improves its desirability during the selection process (Kamel and Tadros, 1996).

The section is prestressed using straight strands only. Additional reinforcement is provided with welded wire fabric instead of conventional rebar. Use of prestressing allows some multiple-span slab bridges to be replaced with single-span inverted tees, contributing to cost savings by eliminating piers. The relatively lightweight nature of the section provides another advantage for its use throughout the short-span environment (Kamel and Tadros, 1996).

Available heights of the Nebraska inverted-tee beams vary from approximately 12 in. to 35 in. The modular width, dictated by the flanges, is approximately 24 in. for all sections. These dimensions are approximations since metric dimensions were used when the standard was developed. Span lengths served by the inverted tee range from approximately 40 ft. to 110 ft. Spans up to 70 ft. can be served by sections 24 in. deep or less. After the topping is placed, the Nebraska sections are deeper than the Kansas haunched-slab sections for similar span lengths, but presence of voids in the inverted tees reduces the weight of the structure (Kamel and Tadros, 1996).

Another advantage is that inverted tees are more economical than cast-in-place slabs in the higher span ranges. The sections are shallower than competitive alternatives such as I-girders and box beams. Results from analytical and experimental data demonstrate the system's favorable performance. The inverted-tee system has the potential to be used in a significant portion of the Nebraska short-span bridge market (Kamel and Tadros, 1996).

### ***Innovative Practices in the Northeastern U.S.***

Bridge construction in the Northeast involves a set of challenges not experienced in other parts of the U.S. The region is heavily urbanized and densely populated. High traffic volumes on

roads and highways create some of the nation's worst traffic problems, even under normal conditions. The geographic presence near the coast increases susceptibility to rapid corrosion and vessel collision. Cold winter weather results in exposure to de-icing salts and freeze-thaw cycles. The region is environmentally sensitive due to its natural scenic beauty and its history as a polluted manufacturing region. These factors, as well as engineering and economic constraints, influence types of structures used in short-span environments.

While these characteristics are not unique to the Northeast, few areas are required to deal with all these considerations on such a large number of projects. Due to these conditions, accelerated construction, environmental sensitivity, durability, and cost considerations must be accommodated for numerous bridges. Naturally, use of prefabricated sections is common. Attempts are made to ensure a long design life with infrequent interruptions to traffic for maintenance, repair, and replacement. Systems that avoid disruption of the natural stream environment are used when required. This subsection will discuss a few types of bridges that have been successfully used in the Northeast states in order to mitigate these problems. The well-rounded nature of these solutions could yield promising results in the Kansas bridge environment.

### ***Northeast Extreme Tee Beam***

As an attempt to mitigate many of the bridge construction and maintenance challenges of the heavily urbanized Northeast states, development of the Northeast Extreme Tee (NEXT) beam began in 2006. The NEXT beam was the product of a consortium of bridge engineers, DOT administrators, and precast plant personnel in several states. The result was creation of a standard bridge section that would be accepted and implemented on a regional, rather than state-by-state, basis. The design has been accepted for use in Maine, New Hampshire, Vermont, Massachusetts,

Rhode Island, Connecticut, New York, New Jersey, Pennsylvania, Delaware, and Maryland. Despite private-sector involvement in its development, the NEXT beam serves as a state standard and is not a proprietary section (PCINE, 2012).

A major impetus for regional cooperation and development is the geography of the area. The small size of most Northeast states creates relative ease in moving materials and products to projects that are nearby, but out of state. Unlike large states where most or all bridge components are fabricated and supplied from entities within the state, the Northeast is likely to have a greater volume of products move across state lines (PCINE, 2012).

Motivation for development of a new system was inspired by less-than-ideal performance of existing bridge solutions in the short- to medium-span range. Specifically, box-beam sections that had been used for these spans proved to be successful structurally but were undesirable from an economic standpoint. Accommodation of utilities is difficult with box beams due to enclosure of the sections. Additionally, the performance of grouted shear keys connecting adjacent modular sections proved unacceptable (Culmo and Serederian, 2010).

One goal was to develop a section that would economically fit the gap between slab bridges and bulb-tee girders. Emphasis was maintained on minimizing cost of the beam, especially fabrication and transportation aspects. Minimizing section depth was preferred in order to reduce the number of bridges with vertical clearance issues. An attempt was made to avoid detail changes between different sections in order to maximize standardization and simplify the precasting process. An acceptable solution was found by using a double-tee section. Figure 2.12 shows the NEXT beam bridge (Culmo and Serederian, 2010).

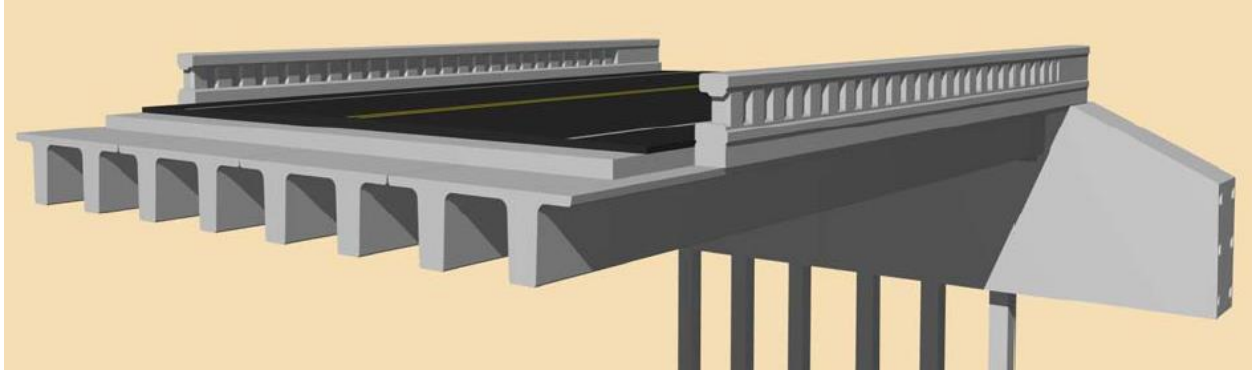
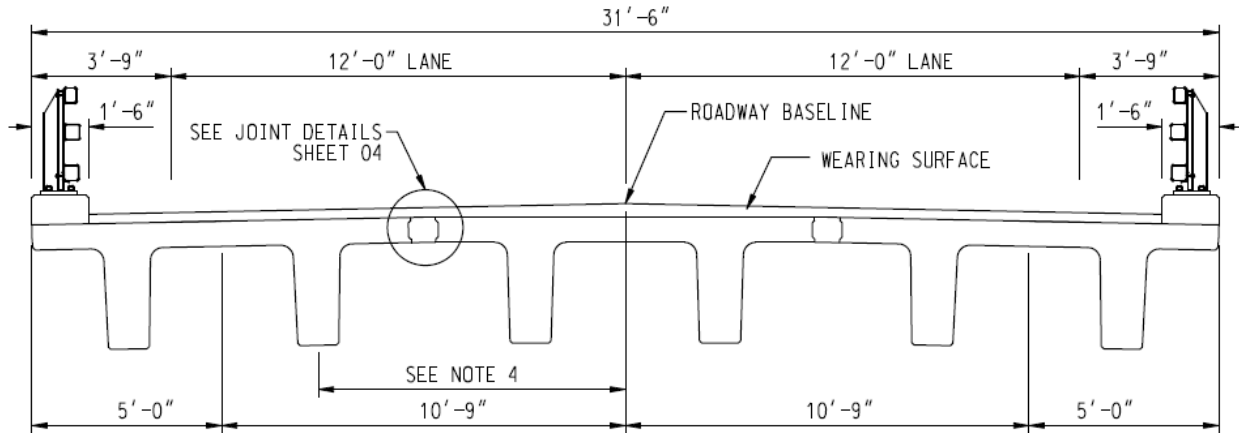

**Figure 2.12: Northeast Extreme Tee Beam Bridge**

The NEXT beam system utilizes a precast, prestressed double-tee section. It is prestressed using straight strands only. Available span lengths range from 30 ft. to 90 ft. The section is available in 8-ft., 10-ft., and 12-ft. widths. The NEXT beam is typically used for single-span projects but has been used for some two-span bridges. Since depressed and harped strands are not available in the design, traditional deck reinforcement must be used in the negative moment region for two-span applications (PCINE, 2012).

Two distinct NEXT beam systems are available for a given project. One option utilizes a full-depth flange. The full-depth flange system is equivalent to a pre-topped section in which the slab or bridge deck is monolithic with the girders. After placement of the beams and appurtenances, only a thin wearing surface is applied to the system onsite. This design minimizes the time the bridge is closed for traffic (PCINE, 2012).

Depths for the full-depth flange section range from 28 in. to 40 in. in 4-in. increments. Thickness of the flange/deck remains constant at 8 in. for all sections. Adjacent sections are connected with a joint that concurrently utilizes headed rebar and a grouted shear key. Figure 2.13 shows a detail of the NEXT full-depth section (PCINE, 2012).



**Figure 2.13: Detail of NEXT Full-Depth Section**

The other option uses a partial-depth flange which requires a cast-in-place concrete topping after placement of the beams (PCINE, 2012). The cast-in-place topping is beneficial because it holds adjacent beams together without the need for a transverse connection. But, it comes at the expense of increasing the project's construction time. An added advantage of the partial-depth flange is its ability to function as stay-in-play formwork for the cast-in-place topping. The need for traditional formwork is minimized for this option (PCINE, 2012).

Depths for partial-depth flange sections range from 24 in. to 36 in. in 4-in. increments. The topping must be applied so that the slab has the same 8-in. thickness as the full-depth flange. The decking may be thicker than what is commonly used in other states. Durability concerns and high traffic volumes of the Northeast dictate additional robustness to ensure a long service life. Figure 2.14 shows a cross section of a NEXT beam bridge using the partial-depth section (PCINE, 2012).

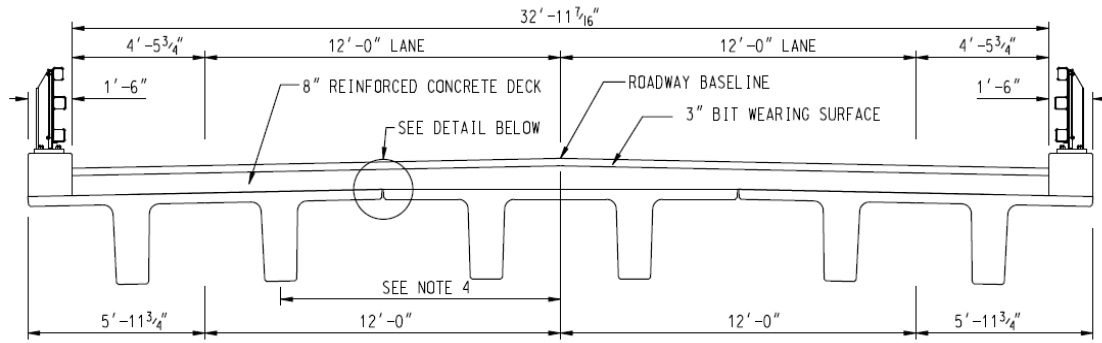

**Figure 2.14: Cross Section of NEXT Beam Bridge with Partial-Depth Section**

Figure 2.15 shows a detail of the NEXT partial-depth section prior to topping (PCINE, 2012).

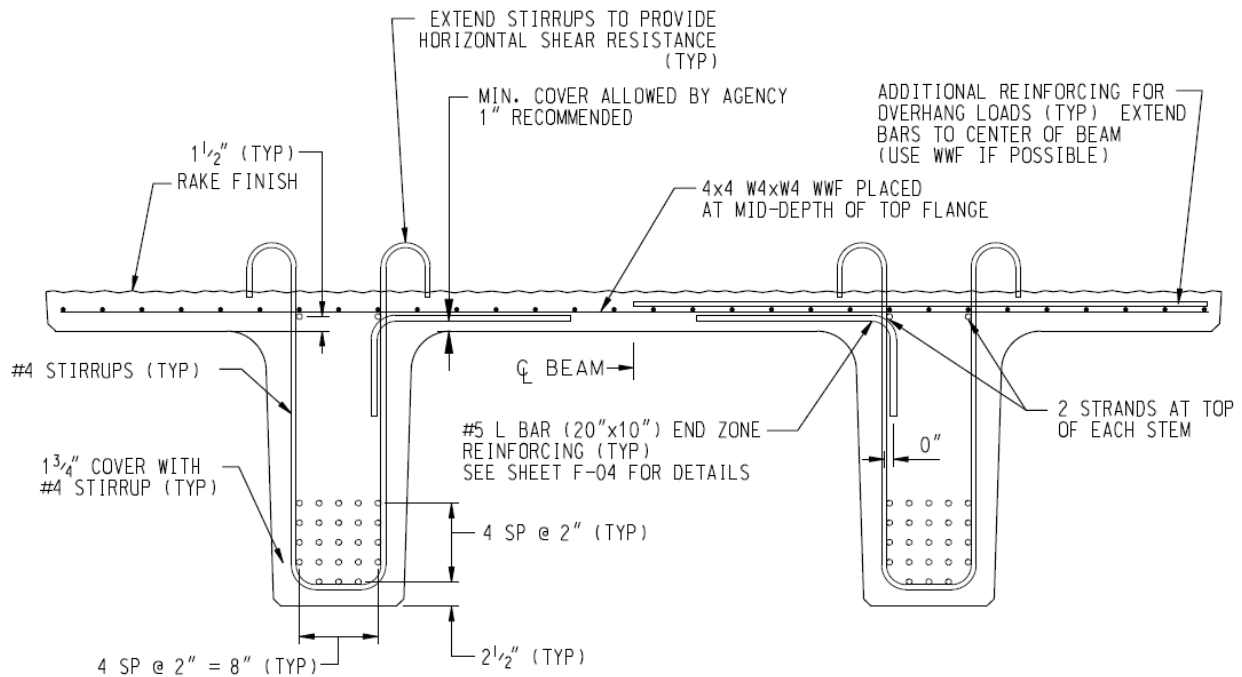

**Figure 2.15: Detail of NEXT Partial-Depth Section Prior to Topping**

Use of precast sections presents the question of how to attach railings and protective barriers. The NEXT beam uses precast railings as well. The cast-in-place topping may ease the

connection of railings or barrier walls. Rebar can extend continuously from railing into the deck prior to the pour, providing a connection between the two components. For the pre-topped deck, rebar extensions from the precast railing can be grouted into pockets in the deck, achieving the same result. Figure 2.16 shows a detail of the NEXT concrete railing attachment (Culmo and Serederian, 2010).

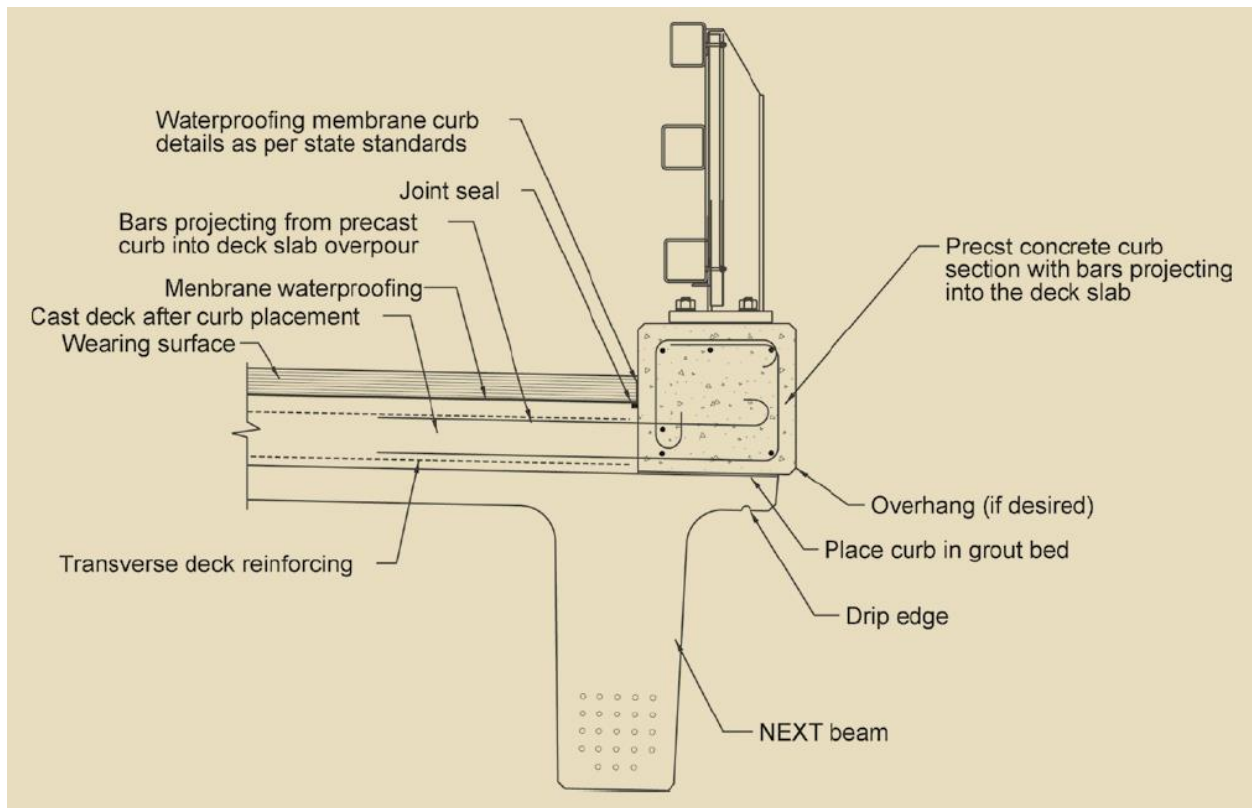

**Figure 2.16: Detail of NEXT Concrete Railing Attachment**

One noteworthy characteristic of the NEXT beam is the size of the webs. The webs are available up to 13.75 in. wide, lending to its description as the extreme tee beam. Substantial width of the webs provides high lateral stiffness relative to other tee or double-tee sections. For this reason, diaphragms are unnecessary except at the end locations (Culmo and Serederian, 2010).



Rationale behind development of the NEXT beam section addresses many of the same concerns present in the Kansas bridge environment. The NEXT beam system satisfies requirements specified by this project. As a precast, short-span bridge, it could replace multi-span box culverts without disturbing a sensitive stream. Fast implementation times allow it to qualify for ABC requirements. Perhaps most importantly, it was developed with durability as a paramount concern. Measures taken to ensure long-term performance under difficult conditions make it well suited to the criteria it must satisfy in the Midwest. Development of a similar system in Kansas could prove valuable.

### ***Bridge-in-a-Backpack***

An innovative concept implemented in the state of Maine in 2008 is the Bridge-in-a-Backpack. The Bridge-in-a-Backpack is a unique structural system that uses non-traditional components to span short stream crossings. It was developed as part of a research project at the University of Maine in an attempt to reduce overall costs and construction schedules for bridge projects. Much like for this project, the goal was to develop a system that meets structural and durability performance requirements while satisfying ABC criteria and environmental regulations (University of Maine, 2011).

The primary distinguishing detail between the Bridge-in-a-Backpack and traditional bridge systems is the nature of the superstructure. Instead of steel or concrete sections, primary superstructural elements are carbon fiber tubes. The tubes are inflatable, allowing them to be transported to the construction site in a very compact form. The light, compressible nature of the superstructure lends to the branding suggestion that the bridge could physically fit into a backpack (University of Maine, 2011). Figure 2.17 shows a Bridge-in-a-Backpack in service

(MaineDOT, 2010). The system appears visually similar to several of the proprietary bottomless culverts discussed earlier.



**Figure 2.17: Bridge-in-a-Backpack**

During construction, the carbon fiber tubes are inflated, shaped into their desired form, and infused with resin. The arched tubes are placed in a row at two-foot spacing (Maine DOT, 2010). The tubes are then filled with concrete, which upon curing, provide the system's rigidity. The tubes are anchored into cast-in-place strip footings. A corrugated, fiber-reinforced polymer (FRP) metal sheet is placed and fastened over the tubes, giving the system lateral bracing and stability. After the superstructure is erected, backfill is placed over the arches and the roadway is constructed. Extensive use of composite materials as primary structural elements makes the Bridge-in-a-Backpack one of the most revolutionary short-span bridge products in service

(University of Maine, 2011). Figure 2.18 shows a Bridge-in-a-Backpack under construction (MaineDOT, 2010).



**Figure 2.18: Bridge-in-a-Backpack Under Construction**

The Bridge-in-a-Backpack possesses a few advantages over conventional bridge systems. The tubes have added benefit from functioning as both structural elements and stay-in-place forms. Due to confinement provided by the tubes, the concrete is isolated from the elements, improving the system's durability. Since carbon fiber is a ductile material, the tubes can resolve tensile forces, eliminating the need for rebar in the bridge superstructure. By providing protection from de-icing salts and the saline coastal environment, the system can achieve a longer design life. Because of its corrosion-resistant properties, carbon fiber is more advantageous than steel or concrete as an exposed surface. Materials selected and nature of the

design give the Bridge-in-a-Backpack higher durability performance characteristics, compared to traditional bridges (University of Maine, 2011).

Additionally, use of lightweight materials throughout the system reduces the need for heavy construction equipment on site. Dead load is considerably reduced when compared to a traditional concrete bridge. The tubes can be lowered into place with a boom truck instead of a large construction crane needed for traditional precast bridges. This allows the bridge to be constructed without obstructing the natural stream environment, meeting some of the most stringent environmental requirements. Also, the superstructure can be completed in two weeks or less, meeting ABC requirements (University of Maine, 2011).

More than half a dozen Bridge-in-a-Backpack structures have been built throughout Maine, with more planned in the future (University of Maine, n.d.) In some cases, these structures were used to replace deteriorated box culverts (MaineDOT, 2010). Span lengths in service range from 28 ft. to 48 ft. (University of Maine, n.d.). The longest span currently undergoing testing is 70 ft., reaching the required span length investigated by this project. Thus far, only single-span bridges have been built with development and testing of multiple-span systems in progress (University of Maine, 2011).

Favorable long-term performance is expected with laboratory tests predicating a service life of 100 years. Fatigue testing has demonstrated minimal reduction in capacity after cyclic loading. Despite its praise, no Bridge-in-a-Backpack has completed its design life, due to its very recent development. Thus, bridge engineers are left without empirical evidence verifying the system will reach its predicted performance in the field (University of Maine, 2011).

### *Innovative Practices in Texas*

The state of Texas is known for its extensive use of precast concrete products throughout its bridge network. For this reason, numerous conventional bridge projects meet ABC criteria. A noteworthy quality of many Texas bridges is how pervasive use of rapidly constructed elements is for all aspects of bridge design. Several projects have been implemented with ABC-qualifying, precast components used throughout the entire superstructural and substructural systems (Marin III, 2008).

Texas has numerous superstructural sections that have been used on recent projects. For relatively short spans, bridge designs may use a set of prestressed slab beams placed adjacent to one another. These modular sections run in the longitudinal direction of the bridge and are held together with a cast-in-place topping. Typical width of each section is less than 5 ft. and depth ranges from 13 in. to 20 in. A topping thickness of 5 in. is used. Presence of prefabricated slab allows the topping to be placed with minimal amounts of conventional formwork. The system is relatively simple and serves as a rapid replacement option to be used instead of a fully cast-in-place slab bridge. Figure 2.19 shows a detail of a prestressed slab-beam bridge (Marin III, 2008).

Another option for short to medium spans is the prestressed, decked-slab beam bridge. The decked-slab beams are full-depth sections, fitting the gap in the span range between slab and conventional girder bridges. Depending on depth of the section, the beams may be solid concrete or hollow, similar to box beams. This makes the section more economical for a variety of span lengths. An advantage of the system is that deck and girder elements are monolithic with each other, reducing the number of members in the bridge. The modular sections touch one another and require a transverse connection. An overlay or wearing surface is still typically applied to the top of the beams. Width of the beams is set at 6.5 ft. Depth of the section is allowed to vary as

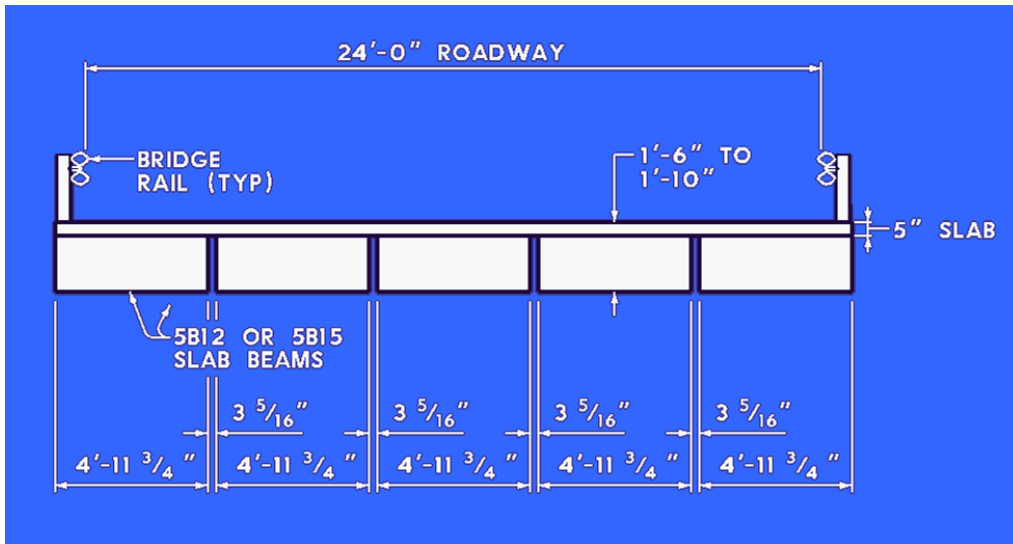

**Figure 2.19: Texas Prestressed Slab-Beam Bridge\***

needed for a project, but the flanged deck uses a 6-in. depth with 2-in. overlay. Figure 2.20 shows a detail of a prestressed decked-slab beam bridge (Marin III, 2008).

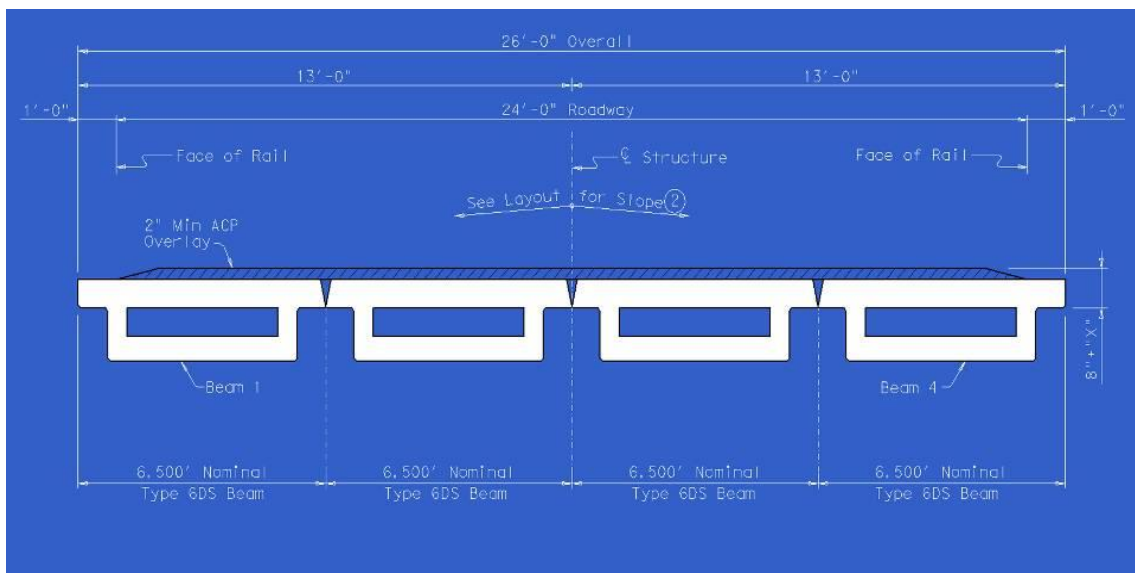

**Figure 2.20: Texas Prestressed Decked-Slab Beam Bridge\***

\* Neither the entity or individual nor the information, as it is presented in this report is endorsed by the State of Texas or any state agency.



This type of bridge can utilize the welded embedded-plate connection for adjacent sections. In this connection, bevels are formed on the sides of the flanges during the precasting process. Steel plates are embedded into the sides of the flanges during casting. The plates are placed at 5-ft. intervals longitudinally throughout the beams. Rebar is placed in the groove created by adjacent bevels and welded to the embedded plates. Non-shrink grout is then poured into the portion of the groove above the rebar, filling the groove and protecting the rebar from the elements (Marin III, 2008).

The embedded-plate connections serve as an alternative to grouted shear keys and transverse post-tensioning, which are still used quite extensively throughout bridge designs. The Texas embedded plate is similar to one of the connections tested on the Minnesota inverted-tee beam bridges. Figure 2.21 shows the welded embedded-plate connection (Marin III, 2008).

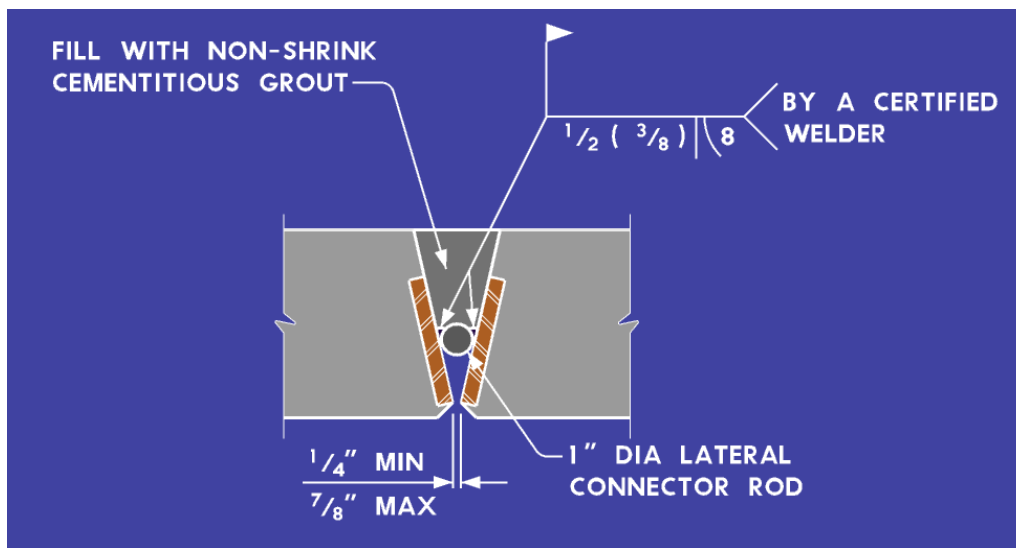
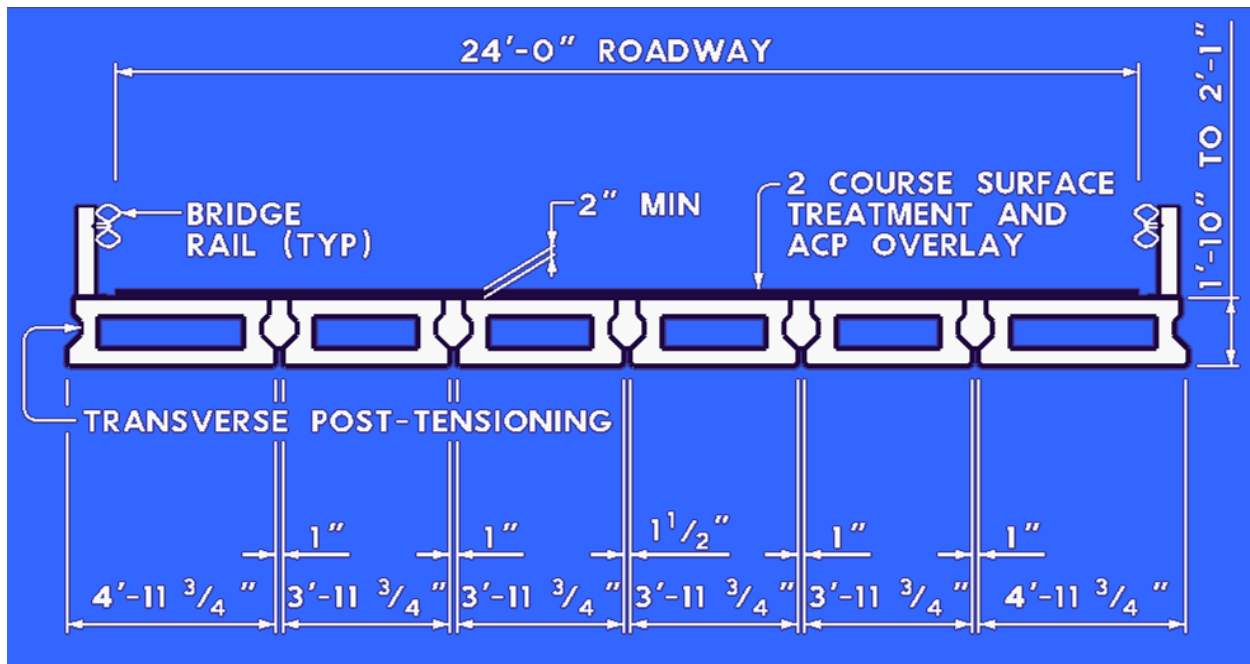

**Figure 2.21: Welded Embedded-Plate Connection\***

---

\* Neither the entity or individual nor the information, as it is presented in this report is endorsed by the State of Texas or any state agency.

In addition to the decked-slab beams, Texas also uses prestressed concrete box beams. Width of the box beams comes in the 4-ft. to 5-ft. range. Narrow sections are used for interior beams. Wider sections are used for exterior beams, which must accommodate placement of the concrete railing. Heights vary from 22 in. to 25 in. Box beams are most likely used for longer spans than the decked-slab beams. The box section is versatile and can be used for short, medium, and long spans, but remains most economical in the medium- and long-span market. The modular sections can be tied together laterally by use of grouted shear keys or post-tensioning. A 2-in. overlay is placed over the box beams for a wearing surface. Figure 2.22 shows a detail of a prestressed box-beam bridge (Marin III, 2008).

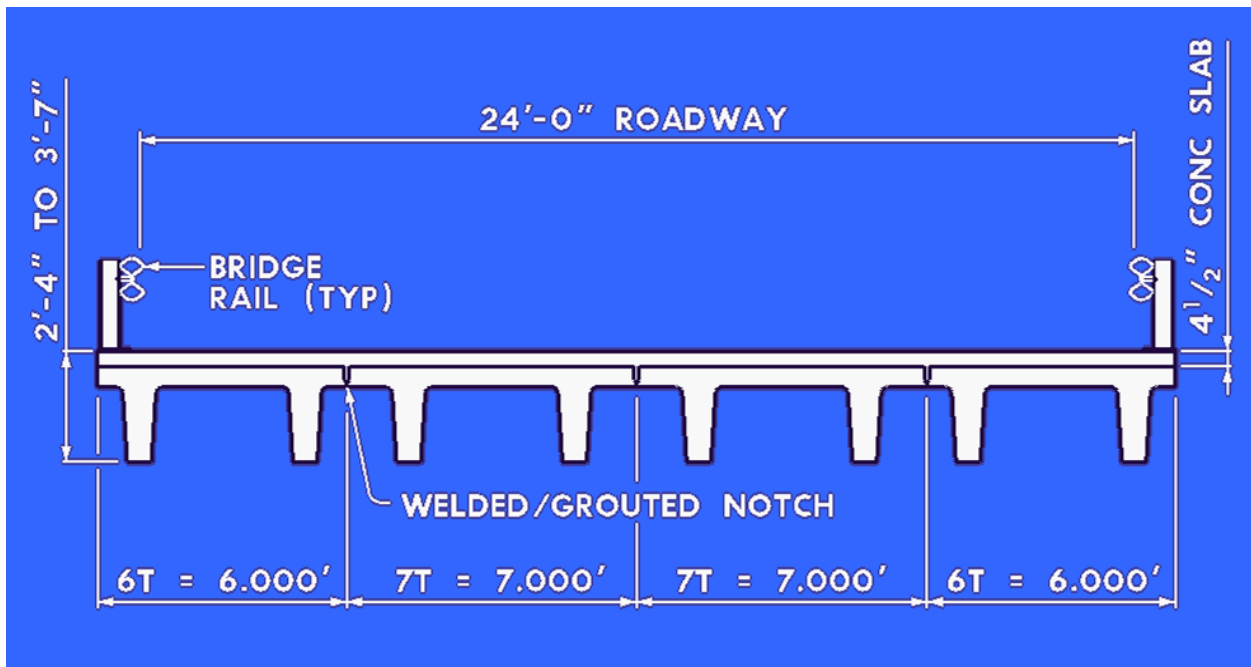

**Figure 2.22: Texas Prestressed Box-Beam Bridge\***

\* Neither the entity or individual nor the information, as it is presented in this report is endorsed by the State of Texas or any state agency.



A prestressed double-tee beam standard is also available for medium spans. The double tees come in modular sections of 6 ft. or 7 ft. Depth of the sections varies from approximately 2 ft. to 3.25 ft. Double tees may be transversely fastened with the welded embedded-plate connectors discussed earlier. A 4.5-in. concrete slab is placed over the beams to provide a wearing surface. Figure 2.23 shows a detail of a prestressed double-tee beam bridge (Marin III, 2008).



**Figure 2.23: Texas Prestressed Double-Tee Beam Bridge\***

Another precast option involves use of traditional I-girders, topped with prefabricated deck panels. Unlike all other sections, the I-girder section is already used frequently in the Kansas bridge environment. Precast deck panels present the primary difference with the Kansas

\* Neither the entity or individual nor the information, as it is presented in this report is endorsed by the State of Texas or any state agency.

design. The panels are modularized with their long dimension running perpendicular to the span of the bridge. Just as cast-in-place decks are connected to girders with shear anchors, precast deck panels use similar fasteners that must be grouted (Marin III, 2008).

As with any modular system, connections for adjacent components must be provided. Grooves are cut at the edges of the panels to provide a rebar slot. These bars are used to tie adjacent slabs together. These grooves and the gap between the slabs are grouted to provide continuity. Figure 2.24 shows the grouted rebar connection for adjacent precast panels (Marin III, 2008).



**Figure 2.24: Rebar Connection for Adjacent Deck Panels\***

In addition to various precast superstructural systems, precast substructures have been used in Texas to further accelerate bridge construction. Precast abutments and pier beams have

---

\* Neither the entity or individual nor the information, as it is presented in this report is endorsed by the State of Texas or any state agency.

been successfully used on projects in the past. With these elements, steel plates can be embedded into the bottom side of the concrete during precasting. Steel piles are then welded to the embedded plate on site, providing a connection for the substructural components. Figure 2.25 shows a precast abutment placed on piles (Marin III, 2008). Figure 2.26 shows the welded embedded-plate connection used to fasten piles to a precast abutment (Marin III, 2008).



**Figure 2.25: Precast Abutment Placed on Piles\***

For multiple-span projects that require piers, precast piers are still a viable option to compete with cast-in-place construction. In order to mitigate the problem of transporting long and heavy piers, these elements can be transported in separate pieces and connected on site. Common connections include grouted pockets, grouted vertical ducts, and bolted connections. The same concept can be applied on short, single-span bridges. At stream crossings, providing a positive connection between precast superstructural and substructural components is important in order to minimize the likelihood that components will be carried away in flood conditions or

---

\* Neither the entity or individual nor the information, as it is presented in this report is endorsed by the State of Texas or any state agency.

pressurized flow. These types of connections can be used to fasten a single-span superstructure to its abutment (Marin III, 2008).



**Figure 2.26: Welded Embedded-Plate Connection for Substructure\***

The field operation used to connect separate substructural components is qualitatively similar for grout pockets and ducts. In either case, rebar extends from the male element after precasting. Pockets or ducts are formed into the female element during precasting. Structural components are fitted together during construction. Then, grout is inserted into the pockets or ducts, connecting adjacent members. As an alternative to rebar, threaded rods can be cast into one component. A plate and fastener can be used to complete the connection with the adjacent member. The connection will still be grouted in similar fashion (Marin III, 2008).

---

\* Neither the entity or individual nor the information, as it is presented in this report is endorsed by the State of Texas or any state agency.

This process presents a solution to the problem of providing a connection for members which cannot be fabricated monolithic with each other during precasting, a problem which had traditionally given cast-in-place construction an important advantage. Experimental testing had validated the acceptable performance of these connections, most notably, lack of slip in the grouted assemblies under real-world loading conditions. Figure 2.27 shows a grouted duct connection at the interface of the pier and pier cap (Marin III, 2008).

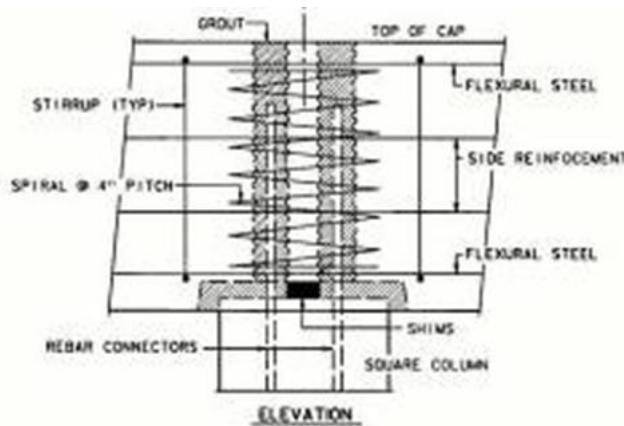

**Figure 2.27: Grouted Duct Substructural Connection\***

### *Innovative Practices in Washington*

Similar to Texas, Washington is another state that has made extensive use of precast concrete components throughout both superstructural and substructural systems. The decision to use cast-in-place or precast products in the substructure has advantages and disadvantages, similar to the superstructure. Precast substructures reduce the construction schedule further. However, the frictional bond formed at the interface between cast-in-place concrete and the soil

---

\* Neither the entity or individual nor the information, as it is presented in this report is endorsed by the State of Texas or any state agency.

is advantageous for stability reasons (WSDOT, 2011). For this reason, some bridge owners may prefer use of cast-in-place construction for elements such as strip footings and piers. However, there are cases where DOTs have used prefabricated components on the vast majority of the bridge.

The state of Washington has recently sought ways to effectively construct bridges with use of precast pier caps and columns. Washington faces an added challenge not experienced in most states, since it is located in a high seismic region. Because of this, connections at the interface of major components require special design and attention to detail (Khaleghi et al., 2012).

Traditional construction procedures began with pouring cast-in-place footings, followed by cast-in-place columns. The lower portion of the pier cap may have been poured monolithic with the columns. Precast girders, commonly used throughout Washington, are then ready for placement on the pier cap. Finally, the upper portion of the pier cap, including the diaphragms, and bridge deck are cast in place (Khaleghi et al., 2012).

While it was not deemed effective to use precast products to replace all of these components, precasting certain parts of the substructure has proven successful. A recent design maintains use of cast-in-place spread footings, but involves precasting the columns and lower portion of the pier cap. For the connection, columns are fitted onto rebar extending upward from the footing and grouted into place. The lower portion of the pier cap is then set onto the columns. In similar fashion, the elements are connected using a grouted joint with rebar extending from the columns into voids in the pier cap. Care must be taken in the construction process to ensure the rebar properly fit into the pier cap (Khaleghi et al., 2012).

The precast girders are then lowered into position. The upper portion of the pier cap may be cast in place, as was the case in the ordinary design procedure, or precast with use of a closure pour as needed. The design and construction procedure allows for use of a cast-in-place deck or prefabricated deck panels. After laboratory testing demonstrated successful performance of the precast substructural system under seismic loading, the Washington DOT implemented one bridge project according to this procedure. Figure 2.28 shows the pier cap being placed on the columns (Khaleghi et al., 2012).



**Figure 2.28: Placement of Precast Substructural Elements**

Additional construction time can be saved by simultaneous placement of bridge elements. One project previously constructed called for the precast column to be placed on the ground before the cast-in-place spread footing was poured. The column was fitted and tied to rebar in the footing for continuity. The footing was then poured as the pier cap was moved into place. Since a large portion of the bridge's dead load had not yet come to bear on the footing, the footing was allowed to cure while other portions of the bridge were being constructed. In this case,



construction will proceed in a safe manner as long as dead loads do not exceed available strength of the footing during the procedure (Khaleghi et al., 2012).

Washington bridges built according to these specifications were implemented with success. Extensive use of precast elements throughout caused a large reduction in project schedule. Elimination of formwork for much of the structure also resulted in considerable cost savings. On both projects, construction proceeded in the absence of any noteworthy problems. Integration of precast components into both the superstructure and substructure is a major step in implementing bridge projects in as little time as possible (Khaleghi et al., 2012).

### **Geosynthetic Reinforced Soil Systems**

Previous subchapters have discussed the implementation of various substructural components that help accelerate bridge construction. All these cases have involved precasting of traditional concrete bridge substructural elements. A different option available for bridge owners can be used to replace the conventional approach slab, abutment, and foundation elements, and still satisfy structural and geotechnical requirements of the bridge. This system, known as geosynthetic reinforced soil (GRS), has become increasingly researched as a substructural solution. GRS systems have been constructed throughout the last decade and can be used to meet ABC goals. A description of GRS systems is presented in this subchapter.

GRS refers to an innovative geotechnical system that combines properties of granular soil and geosynthetic material to improve strength and stiffness of a soil mass. GRS systems are somewhat analogous to reinforced concrete. Both plain concrete and soil perform adequately in compression and shear, but lack strength and ductility in tension. The addition of rebar in concrete and geosynthetics in soil improves performance of both materials. GRS systems were shown to have a beneficial application to short-span bridges in recent years.



GRS systems are very similar to mechanically stabilized earth (MSE), with a few exceptions. MSE typically uses metal strips rather than geosynthetics. While MSE is more commonly used for structural stability of retaining walls, GRS systems are designed to distribute all loads of a bridge or large structure to the foundation. The mechanism for GRS and MSE is that bond interaction between the soil and reinforcement can be used to resolve lateral forces, rather than relying upon the reaction from cantilever walls or other means of formal support. The GRS system covers a large area under the approach to a bridge. Successful distribution of load under a large soil area can eliminate the need for piles, drilled shafts, or other deep foundations (Adams et al., 2011).

The GRS system is comprised of a few basic components, namely, the foundation, abutment, and facing elements. Success of GRS systems in bridge environments is dependent upon performance of its elements. At the bottom of the system lies a reinforced soil foundation. The foundation uses compacted, granular soil wrapped with the geosynthetic fabric. The foundation is intended to not only support the structure but keep above layers reasonably waterproof as well. (Adams et al., 2011).

Water infiltration could result in much lower bearing capacity and ultimate failure of the system. This problem is naturally more prevalent at streams than at road crossings. In non-stream environments, GRS systems may pose low risk of this type of failure. While GRS systems have been successfully used at stream crossings, their substructures warrant additional protection not only from gradual water infiltration and seepage, but from scour and erosion (Adams et al., 2011).

Above the foundation is the GRS abutment. The abutment consists of periodic layers of geosynthetic material supporting compacted soil. The FHWA recommends lifts for geosynthetic

layers not exceed 12 in. The FHWA has also found that maintaining close reinforcement spacing results in better performance than using higher strength reinforcement at wider intervals (Adams et al., 2011).

Soil used in a GRS system must conform to a set of specifications to guarantee proper performance. It may not be acceptable to build the foundation and abutment out of the ordinary material removed from the site during excavation (Adams et al., 2011). Soil used for the backfill should qualify as well-graded. In order to limit settlement, proper compaction of the backfill is of paramount importance. High-quality material reduces vertical and horizontal movement of the GRS mass. When these design and construction guidelines are followed, stiffness of the soil structure is improved both initially and long term (Wu et al., 2006).

The abutment extends vertically from the foundation to the base of the superstructure. It is constructed to form a vertical wall under the span of the bridge. This wall is protected by a set of facing elements. The facing must be a stable, sturdy material such as masonry blocks or a concrete wall. The facing prevents water from infiltrating the GRS abutment. The geosynthetic material is connected to the facing element, providing structural support (Adams, Alzamora, and Nicks, 2011).

The superstructure of the bridge should not come into contact with the facing. The facing is not intended to provide rigid vertical support to the bridge. Functionality of the GRS system is based on flexible deformation rather than rigid restraint. Near the top of the abutment, the FHWA recommends spacing of the geosynthetic layers be reduced to 6 in. At stream crossings, the practice of using layers of different colored blocks has proven helpful at detecting scour and erosion along the base of the wall facing (Adams, Alzamora, and Nicks, 2011). Figure 2.29 shows the facing elements used on a GRS bridge system (Adams et al., 2011).



**Figure 2.29: GRS Bridge System in Service**

Length of the geosynthetic fabric extending horizontally from the facing should vary throughout the vertical profile of the abutment. Near the bottom of the abutment, geosynthetics may extend only a small distance from the facing. Near the road surface, layers should extend a greater length outward. This practice increases the number of layers of reinforcement throughout the soil mass when approaching the span. (Adams et al., 2011).

Presence of more layers through the profile contributes to increased stiffness of the GRS system. Naturally, stiffness of the soil mass is highest near the span and decreases away from the bridge. The practice of increasing strength and stiffness of the approach closer to the span is highly beneficial. It mitigates the longstanding problem of how to smooth the transition from a flexible roadway foundation to a rigid bridge foundation (Adams et al., 2011).

At the top of the system is the interface between the superstructure and abutment. The girder or slab rests on a bearing pad. It is through the bearing pad the vertical loads from the superstructure are transferred to the substructure. Directly behind the girder or slab is the bridge approach. Instead of a slab, the approach consists also of soil with geotextile layers to ease the transition. When GRS layers are used in the approach, a jointless bridge is created. The system is

then designated as a Geosynthetic Reinforced Soil-Integrated Bridge System (GRS-IBS). Construction of GRS eliminates the need for expansion joints since the ductility of the system is intended to provide sufficient flexibility. Pavement or a wearing surface can extend continuously from the approach onto the bridge. Figure 2.30 shows the profile view of all components of a GRS-IBS section (Adams et al., 2011).

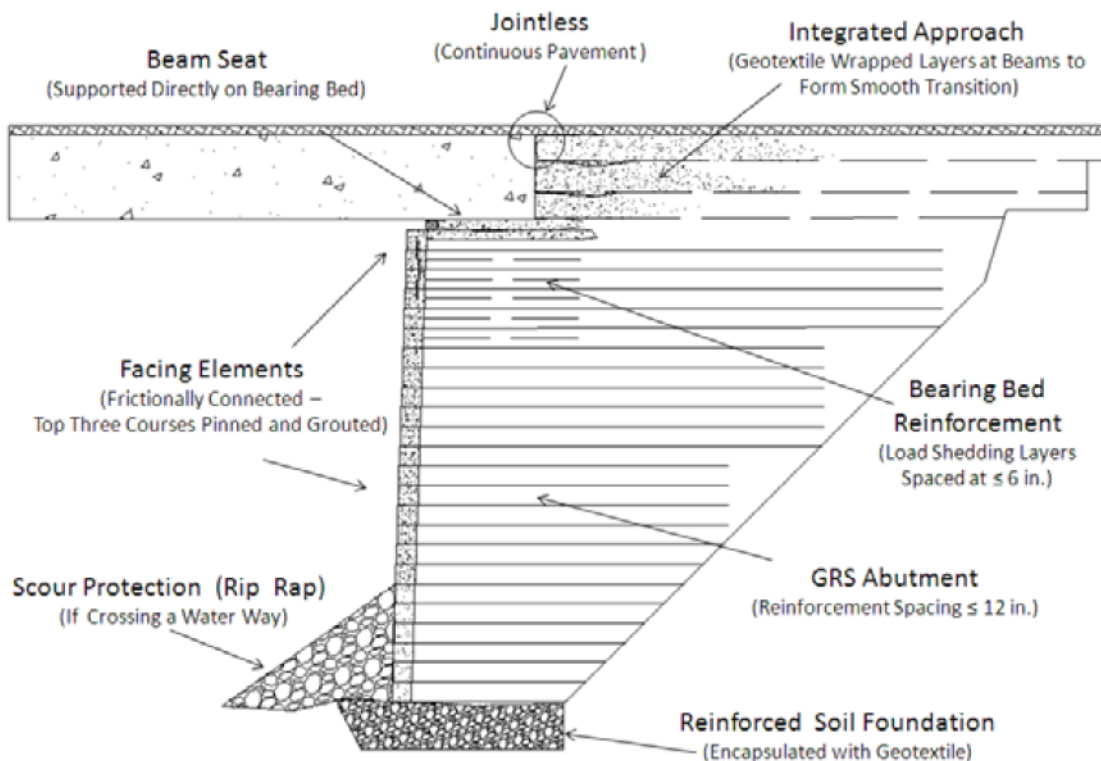

**Figure 2.30: Profile of a GRS-IBS System**

Research on GRS-IBS has shown safe and successful performance both in a laboratory setting and real-world environment. However, since the system is relatively new and data is not widespread, the FHWA recommends that GRS-IBS conform to a few constraints. Height of the system should not exceed 30 ft. until further research shows that taller systems behave acceptably. The longest single span for a GRS-IBS currently in service is 140 ft. Longer bridges

may perform just as well but are not recommended at this time. Fill material used in the abutment should also be compacted to 95% of its maximum dry unit weight in order to perform as intended. It is also recommended that geosynthetic layers not exceed the spacing limits discussed earlier. Finally, in situ soil pressures should not exceed 4000 psf under service loads (Adams et al., 2011).

As opposed to rigid, conventional foundations, GRS-IBS are inherently flexible systems. Strains may exceed those experienced with bridges on piles or other traditional foundations. It is expected some permanent vertical and lateral deformation will occur with GRS systems. This should be carefully considered during the selection and design processes (Adams et al., 2011).

Perhaps the most noteworthy advantage of the GRS-IBS is the elimination of deep foundations and expansion joints. Substructures typically represent a large portion of bridge construction costs. Naturally, removal of piles or drilled shafts from the plans can result in considerable savings. Elimination of maintenance associated with expansion joints is another added benefit (Adams et al., 2011).

Another advantage of removing the expansion joint and integrating the bridge approach is a smoother and more comfortable ride for the traveling public. The impact generated by vehicles moving from an approach slab to a bridge deck contributes to additional stress in the superstructure. Smoothness of the transition on a flexible foundation improves durability of the structural system. Experimental testing on thermal fluctuations has also shown acceptable ductility of the GRS system without destructive effects on bridge components (Adams et al., 2011).

Some replacement projects even allow existing abutments or footing elements to remain in place during and after construction of the new system. In this case, the GRS system is placed

in the existing approach, with a longer span built over existing substructural elements. If kept in place, these elements can serve as scour protection for the base of the wall facing. The disadvantage of the longer span is mitigated by moving the sensitive soil system further away from the stream, reducing associated risks (Adams et al., 2011).

Construction of GRS systems can also be completed very rapidly. Bridges using GRS systems may qualify as ABC projects. In conjunction with other ABC practices, it is expected bridge decks or other superstructural systems used with GRS-IBS be precast concrete or steel. Similar to other systems previously discussed, projects using GRS-IBS can be completed without use of cast-in-place concrete or formwork. Some GRS-IBS projects have been completed in less than two weeks (Adams, Alzamora, and Nicks, 2011). Regardless of whether the system is part of a replacement project or original construction, the GRS and superstructure can be constructed entirely without placing people or equipment in the stream. The system is compatible with the environmental and hydraulic requirements associated with this project.

A major disadvantage to GRS-IBS is the threat water poses to the system. Infiltration, seepage, water table fluctuation, and flooding prove to be detrimental to GRS systems. Saturated foundations can cause total failure of the substructure. However, several GRS-IBS have been built at stream crossings. They have shown successful performance over the past five to 10 years, when proper precautions and protective measures are taken. However, the risk always remains near any water environment. Thus, the FHWA recommends GRS systems be placed at streams with low susceptibility for scour (Adams et al., 2011).

If bridge owners are concerned with risks and disadvantages of the GRS-IBS, the technology can still be used. Another type of GRS system may address the concerns. A rigid system has been developed which combines GRS in the approach with traditional abutments

integral with the bridge superstructure. Use of integral abutments as a design practice is gaining popularity (Tatsuoka et al., 2009).

In the rigid GRS system, abutments sit on pile foundations, similar to a traditional bridge. The GRS system is implemented in the backfilled area behind the abutments. The purpose of this system is to reduce undesirable settlement in the approach that causes the bump at the bridge. Experimental testing has demonstrated success at reducing short- and long-term vertical deformations under traffic loads. Results also show the GRS integral bridge system can adequately handle horizontal stresses and strains caused by expansion and contraction of the bridge girders due to thermal cycles and seismic loading (Tatsuoka et al., 2009).

Use of pile foundations is beneficial for increasing the conservatism of the design. Unfortunately, though, it eliminates construction time and cost advantages inherent in the flexible GRS system. It does, however, incorporate the technology and presents a less drastic change to most existing bridge designs than the pure system. By using properly protected piles, scour may be less threatening. Where a flexible GRS bridge system is susceptible to failure due to shallow foundation washout, use of piles in the rigid system will safely carry the bridge substructure below the scour threshold. Experimental testing of GRS has shown promising results for alleviating several disadvantages of traditional bridge systems. The ability to reduce its inherent risks makes the system more acceptable for use in the Kansas bridge environment.

## **Chapter 3 - Development of Cast-in-Place Solution**

The project proposal called for development of two structural systems. One solution is intended maximize structural efficiency and economy. For this system, minimizing the construction schedule was not of critical importance. The goal was to create the most effective system from a structural and durability standpoint. This solution makes use of cast-in-place concrete and will be discussed in this chapter. The primary purpose of the other solution was to minimize construction time without neglecting the importance of structural efficiency, cost, and durability. This accelerated option makes use of precast concrete and will be discussed in the next chapter.

This chapter documents development of the cast-in-place solution for short-span bridges. The structural section deemed most appropriate for the new system was chosen based on characteristics discussed in the literature search. The new system will be shown to satisfy all requirements of the project. Exact parameters of the new design were selected for the research setup. A description of computer modeling assumptions for the structure is given. The procedure for analysis and design of the structural sections is provided. Finally, results of analysis and design are presented.

### **Selection of the New Bridge System**

In order to establish a paradigm for selection of the new bridge system, a recap of required performance characteristics is provided in this subchapter. This will briefly summarize information contained in the earlier portion of the literature search. These characteristics pertain to the system's environmental and hydraulic performance, material type, durability, and cost.



Qualities of the new system will be presented along with an explanation of how it serves as the most appropriate solution for this project.

### ***Environmental and Hydraulic Design Characteristics***

Perhaps the most noteworthy drawback to use of traditional box culverts is the system's environmental performance. Environmental problems associated with box culverts commonly result from the hydraulic performance of those structures. Several concerns are related to scour. A likely cause of scour near box culverts is constriction of the waterway that commonly occurs within these structures. A four-sided, concrete conduit can convey water at higher velocities than a natural channel. As a result, the opening for these facilities is often sized smaller than the natural waterway. This design practice causes undesirable flow characteristics that have led to regulation of box culverts.

Scour at the inlet and outlet of culverts creates vertical jumps in flow line elevation near the bottom slab. These vertical jumps make AOP difficult and sometimes impossible. Effects on passage of fish and other organisms were the impetus for environmental regulations pertaining to box culverts. Additionally, scour near the floor slab can lead to the undermining of soil beneath the culvert. This causes higher bearing pressure in the remaining soil and, in extreme cases, instability of the structure. Because many of these problems are inherently related to the design of box culverts, it was deemed more practical to develop a new solution than to modify the existing standard.

The new structural system should avoid or mitigate all drawbacks to box culverts previously mentioned. In many cases, compliance with environmental regulations can be achieved simply by avoiding constriction of the waterway. Since maximum span length specified in this project is relatively short at 70 ft., only single-span facilities will be considered. For good

environmental practice, span of the new system should be sized to exceed the channel width by at least 20%.

By hydraulically oversizing the structure, all disturbances to the natural stream environment can be avoided when placing the substructural components. Properly implementing the superstructure can allow an entire bridge to be constructed without affecting a sensitive stream. Adherence to these policies has improved a facility's likelihood of receiving environmental permits in other states. Developing a new bridge standard becomes much simpler when it is known that proper sizing of the structure mitigates numerous environmental drawbacks. In this case, design details of the bridge emphasized structural, geotechnical, construction, and economic concerns, since environmental aspects had already been satisfied.

### *Superstructural Design Characteristics*

Single spans are more environmentally beneficial than multi-spans when placement of substructural components in the stream or river is eliminated. They also reduce maintenance concerns associated with obstructions posed by piers or barrel walls. A single-span system may be more durable than a multi-span system due to reduced impact from driftwood and debris in the stream. For the relatively short distances examined in this project, cast-in-place slabs were assumed to be sufficient from an engineering and economic standpoint. The procedure described in later subchapters will test this assumption.

Cast-in-place slabs are likely to be less expensive than any competing superstructural option, providing substantial benefit to their use. While there were more structurally efficient sections available, the slab met the goal of minimizing structural depth. This is important when considering limited headroom requirements for structures replacing multi-span box culverts.

Use of concrete slabs requires a means of reinforcement. Slabs will use either a regularly reinforced or post-tensioned design. Post-tensioning would be valuable from a structural standpoint, since it allows for shallower sections. Reducing slab thickness would be beneficial in situations where headroom and waterway opening requirements suggest a more slender design. It could also be useful when short multi-spans are being replaced by long single spans. However, cost of post-tensioning is a major drawback to its use. The economics of post-tensioning were not likely favorable on spans as short as those considered in this project.

Additionally, post-tensioning would place the superstructure in negative bending. While highly beneficial for gravity loads, effects of overtopping and inundation could be disastrous for these sections. If water elevation reaches the bridge deck, uplift force from the strands acts in conjunction with upward water pressure from the river. In this case, post-tensioned bridge decks could be more easily destroyed and carried away during flood conditions, since the effect of dead load is counteracted. For purposes of safety and security, post-tensioned sections were not considered in this project. Only regularly reinforced sections were used in analysis and design.

### ***Substructural Design Characteristics***

In order to avoid environmental drawbacks of four-sided structures, the new system will not possess a floor slab. As a result, the foundation will change considerably. Alternative structures discussed in the literature search were typically paired with strip footings when good soils were present or deep foundations otherwise. However, even when good soils are present, strip footings are still susceptible to scour.

Because of scour risk with bottomless structures and relative proximity to the stream environment, shallow foundations were not appropriate for the new system. While GRS is a promising and efficient new technology, it has the same vulnerability to scour as conventional

shallow foundations. For this reason, neither strip footings nor GRS substructural systems were investigated further in this project.

In order to improve durability and performance of the system, only deep foundations were considered. While adding expense to the project, security provided by deep foundations likely outweighs its cost. Extreme weather is a common occurrence in Kansas and variability in flow conditions at numerous stream crossings calls for a conservative approach. Development of a new standard should consider the most extreme probable effects the system will endure. Based on this selection, a substructural system must be developed that can be appropriately used in conjunction with deep foundations.

Since single spans are to be used, resting on deep foundations, the new system took the form of a traditional bridge. With traditional bridges, abutment beams are used to transfer superstructural loads to the foundation. A similar application may be successful on the new short-span bridge system. Use of traditional abutments is beneficial since it is very familiar to DOT personnel, consultants, and contractors throughout Kansas. Its use results in no major change to conventional bridge practice.

Substructure for the new short-span system will function in one manner different from traditional bridges. Ordinarily, bridges are sized to provide considerable sloping bank areas adjacent to the river. This is especially true when bridge deck elevation is high above the river or stream. Conversely, box culverts used to span short streams are normally sized to minimize structural length and associated costs. Vertical barrel walls and wingwalls are used to hold back abutting soil.

Keeping economics in mind, the short-span bridge solution was adequately sized to avoid stream constriction but will not likely be longer than required by environmental regulations. In

this case, length of the structure will still be minimized. Instead of providing broad, sloping banks, the substructure will make use of vertical walls and wingwalls similar to traditional box culverts. Accordingly, substructural components may be best described as abutment walls. In addition to transferring gravity loads from the superstructure to the piles, abutment walls have the function of holding back large amounts of lateral earth pressure from adjacent soil through flexure.

Height of the abutment wall will, in practice, be determined based on the geometry of the waterway opening. To capture the benefit of reduced dead load, the replacement system will not be overfilled, to contrast with box culverts. To account for the elimination of fill, height of the new system will often be greater than the existing box culvert's rise.

In order to adequately protect piles, the abutment wall will extend from the roadway surface until at least reaching the subsurface. Depending on engineering judgment and economics, scour below the subsurface may be mitigated by further extension of the wall to desired depth, or through alternative means of protection. Riprap and sheet piling are commonly observed agents for scour protection.

### ***Connections and Joints***

One important goal was to provide an appropriate connection between superstructural and substructural components. Since the bridge is likely to endure occasional overtopping and impact from debris, measures had to be taken to ensure the system was capable of withstanding effects of extreme events. Superstructures that simply rest in bearing on substructural components are vulnerable to washout during flood conditions.

To protect against structural failure, a positive connection between the slab and abutments was necessary. Fortunately, the slab can be cast monolithic with abutments, providing

such a connection. The monolithic connection avoids the necessity of maintenance associated with alternative mechanical connections commonly used on bridges. In this case, a more durable, effective, and longer-lasting structure was likely to be achieved. This practice had an additional benefit by providing continuity for transfer of moment into the substructure. Structures designed for continuity are more structurally efficient than their simply supported counterparts.

### ***Summary of Design Concepts***

To summarize, the short-span system selected for replacement of box culvert structures was a single-span, cast-in-place slab. The slab was monolithic with abutment walls, which sit on deep foundations. Slab structures with traditional abutments are very common to the Kansas bridge environment. Thus, design, construction, and maintenance experience with these types of systems is fortunately abundant.

The monolithic connection between the slab and abutments satisfied the functionality and durability expectations for this project. Use of deep foundations is also common practice for Kansas bridges. For these reasons, the new short-span bridge system satisfied environmental, durability, construction, and economic criteria while minimizing changes to current practice. These characteristics made the new system most appropriate for serving as the replacement for box culvert structures.

### **Parameters of the Chosen System**

The previous subchapter provided an overview of the qualities of the new short-span bridge system. This subchapter defines specific parameters to be used in analysis and design. Geometric details of the superstructure and substructure are determined. The final combination of bridge lengths and widths are selected. The exact type of foundation elements is specified. Selection of these details and rationale for their choice is presented.

### ***Target Project Span Range***

A major step in development of the new system was selecting a target span range. The proposal for this project specified a span range of 40 ft. to 70 ft. It is important to explain why this choice of span range is fitting. Available span lengths for KDOT box culverts range from 4 ft. to 20 ft. However, multiple spans have been placed adjacent to each other, creating longer structures. Triple-barrel culverts with 20-ft. cells have been implemented. This combination represented a practical upper bound for the environment under consideration.

As discussed earlier, the span of any replacement structure will most likely exceed that of the current structure in order to prevent contraction scour. Thus, the replacement system should be investigated for longer applications than those currently in service. The 70-ft. limit provides an estimate of the excess span required for the longest systems. The 40-ft. limit was selected since it provides additional waterway opening for shorter, multi-span structures and because it serves as a practical lower bound for a conventional bridge system as initially envisioned. It is important to understand these limits are rough target values. They serve as a guide rather than exact parameters for study. For this reason, upper and lower bounds may change if dictated by specific reasons.

### ***Superstructural Details***

Once the structural type was chosen, it was important to select the profile. Slab selection allows for competing profile types. One available option was use of flat slabs. Flat slabs represent a very basic superstructural solution. The other option was use of haunched slabs. Haunched slabs are a more detailed design option. Common haunch types are stepped, tapered, and parabolic. A discussion of advantages and disadvantages of flat and haunched slabs is presented.

### ***Flat Slabs***

Flat slabs may be an appropriate choice for the new system. Construction of flat slabs presents a minimal change from current box culvert practice. Flat slabs are economical and simple to construct. However, a flat, prismatic section may not be the most efficient option available. Another cause for concern is that the upper bound of the span range may exceed the practical limit for flat slabs. Fortunately, continuous behavior is provided by the connection between the slab and abutments. Moment carryover may extend the practical length of flat slabs to suit the required range of spans.

### ***Haunched Slabs***

The other option considered was use of haunched slabs. KDOT maintains a design standard for a haunched-slab bridge system. All bridges in the standard have three spans (KDOT, n.d.). Naturally, they are used for longer applications than required in this project. However, since the solution will be single span, potential exists to use the geometric profile of one of the spans. Haunched-slab bridges are widely used throughout Kansas as well, so broad familiarity with the existing system would be transferable to the newly developed system.

The three-span, haunched-slab bridge system consists of two different designs. One is a regularly reinforced concrete system. The other is a post-tensioned concrete system. The post-tensioned system is used for longer spans than required for this project (KDOT, n.d.). For reasons stated earlier, the post-tensioned superstructure was not suitable for this project and its details will not be discussed. Thus, the regularly reinforced sections were appropriate for this application. Further details of this system will be provided.

The three-span, haunched-slab system uses a symmetric center span paired with two end spans. The end spans are haunched near the pier and transition into a flat slab near the abutment. The profile of the haunch is symmetric about midspan of the bridge. For single-span application,



the center span would be appropriate for use. Center spans range from 32 ft. on the shortest bridge to 72 ft. on the longest bridge. Six haunched-slab bridges are contained in the standard with center-span lengths increasing in 8-ft. intervals. Thus, the center-span lengths available for use were 32 ft., 40 ft., 48 ft., 56 ft., 64 ft., and 72 ft. (KDOT, n.d.).

These span lengths were a good fit for the range specified in this project. While the 32-ft. section falls below the lower bound, its consideration would still be useful. The 72-ft. section was very close to the upper limit. The 8-ft. increments provided by the standard were a reasonably close match to the 10-ft. increments specified in the project proposal. Widths of haunched-slab bridges ranged from 28 ft. to 44 ft., in 4-ft. increments, exactly as specified in the proposal. This provided for variation in shoulder width, as needed per bridge project (KDOT, n.d.).

As discussed previously, continuity provided by monolithic construction of the slab and abutments allows the transfer of moment from the slab into the abutments. Since the longest spans for this project tests the limits of slab effectiveness, it was ideal to transfer as much moment into the substructure as possible. Aside from its familiarity within the Kansas bridge environment, the haunched-slab possesses another benefit as an efficient structural system.

In the single-span system, it is intended that abutment walls function similar to adjacent spans in a multi-span system by drawing moment from the main span under loading. In order to maximize the moment transfer, robustness is needed in the substructure and nearby portions of the superstructure. The increased section depth in the haunches provides additional stiffness in those regions. This is beneficial for redistributing moment away from midspan and increasing the efficiency of the section.

This haunched profile may be necessary to preserve the efficiency and economy of slabs for spans reaching 72 ft. The haunch is expected to facilitate proper moment transfer to the substructure. However, since it was designed as part of a three-span section it is unknown whether monolithic abutments will attract moment as effectively as end spans. Results could show the section to be well-suited or ineffective as a single span. Analysis and design of the section would determine its appropriateness.

Haunched sections studied in this project will have profiles identical to those shown in the three-span standard. Should these sections be used in practice, the forms needed to construct the single-span systems will be the same ones used for the three-span systems. Since the geometric design is already determined, the only changes to the system will be the design of reinforcement. Results of analysis and design will suggest if the haunched section can be used effectively.

### *Comparison of Superstructural Options*

Both flat and haunched slabs have potential to serve as effective superstructural systems. It is not yet readily obvious which profile is best suited for short-span bridges. To establish a control for comparison, a flat slab should be compared to a haunched slab of the same length. Flat slabs ranging from 32 ft. to 72 ft., in 8-ft. increments, were considered. To minimize independent variables, thickness of the flat slab was selected such that the volume of concrete in the section was roughly the same as in the haunched section. By keeping the concrete volumes and associated costs equal, the required amount of reinforcement became the only major differentiating variable. Quantity of reinforcement dictated whether the haunched or flat-slab system was preferable.

### *Substructural Details*

The three-span, haunched-slab systems use a similar abutment design for all bridges. The regularly reinforced system uses an abutment beam that measures 2.5 ft. wide by 5.5 ft. deep, in section view. The post-tensioned system uses an abutment beam that measures 3 ft. wide by 6 ft. deep, in section view (KDOT, n.d.). Since stiffness of the substructure is critically important for the single-span system, dimensions of the post-tensioned abutment were used. The larger, post-tensioned abutment is preferable for use since its greater rigidity is assumed to reduce deflection and rotation in the superstructure. For simplicity, it was desirable to keep existing abutment details as consistent as possible when applied to the single-span system.

Additionally, width of piers used with haunched-slab bridges is three feet. The assumption for this project was that span length is measured between centerlines of the abutments (KDOT, n.d.). This assumption matches the haunched-slab bridge standard, allowing exact geometric details of the center span to be reproduced for the short-span bridge. This minimized changes in details for construction forms, allowing the new bridge system to be constructed with equipment already used by bridge contractors. Maintaining familiarity with current practice helps minimize expense.

In order to satisfy requirements of a deep foundation, piles or drilled shafts could be used. A variety of sizes are available for each element. For simplicity, one foundation was selected for purposes of preliminary design. To narrow the field of possibilities, this project only considered steel piles. The HP12x53 section was considered appropriate for similarly sized bridges and was suggested for use in the new system. While drilled shafts or concrete piles are viable options, they will not be analyzed in the preliminary design portion of this project.

### *Connection and Joint Details*

In addition to primary superstructural and substructural components, a standard KDOT approach slab was connected to both abutments. This is consistent with standard bridge design and construction practice for traditional bridges in the state of Kansas. Since GRS-IBS is not used at stream crossings, approach slab serves as the most commonly used element. The approach slab was used to smooth transition of the roadway from a relatively flexible pavement foundation to a rigid bridge foundation.

Another problem to consider was expansion and contraction of the bridge under thermal changes. Traditionally, expansion joints were commonly used to relieve bridge elements of stresses associated with restrained thermal effects. However, use of integral abutments on Kansas bridges has achieved successful performance and popularity. Integral abutments allow a bridge to be constructed without expansion joints. In these systems, the substructure is designed to flex according to the movement of the superstructure. Integral abutments eliminate maintenance and cost of construction associated with expansion joints. The existing KDOT haunched-slab bridge standard uses integral abutments. Due to their acceptance in Kansas, integral abutments will be used on the new single-span system.

### **Experimental Setup**

Once parameters had been established, the system could best be described as a regularly reinforced, cast-in-place, single-span slab bridge. Two superstructural options existed for study: a flat slab and a haunched slab. The superstructure is integral with a set of abutment walls, sitting on a pile foundation. In order to evaluate its effectiveness, the proposed system must undergo structural analysis and design. Results will verify suitability of the proposed system in serving as a replacement for box culverts.

### *Analysis Methodology*

In order to perform structural analysis, the help of computer software was solicited. For this project, STAAD.Pro V8i was used. This particular software was selected since it is used by the KDOT Bridge Section for the analysis of its structures. In order to model the system with this program, appropriate assumptions about behavior of the structure must be developed. These assumptions are documented in this subchapter.

It is important that parameters of the computer model be consistent with common practice and the requirements indicated in the governing design code. This project was analyzed and designed in accordance with AASHTO LRFD Bridge Design Specifications, 5<sup>th</sup> ed., 2010, hereinafter referred to as “the code.” It was also necessary to determine the most appropriate analysis methodology for the system. For slab bridges, designers are permitted to use the equivalent strip method of analysis according to Sec. 4.6.2.3 of the code (AASHTO, 2010).

In this method, analysis of full-size bridges was conducted per driving lane. A driving lane is defined as the width over which force effects from a passing design vehicle are assumed to be distributed. This value is calibrated based on research and testing, and does not coincide with actual lane markings. It is calculated as a function of actual length and width of the bridge, number of driving lanes physically and legally available, and design limit state under consideration. Fatigue limit state uses a wider equivalent strip than strength and service limit states (AASHTO, 2010).

The magnitude of the equivalent strip width has a large effect on design of the bridge. When small strip widths were calculated, the load was more heavily concentrated. This results in a greater design load on a per foot basis. Study of the equivalent strip method demonstrates, with all other parameters being equal, narrower bridges have narrower calculated strip widths. For this

project, the 28-ft.-wide bridge is the narrowest section and would thus have higher moment demand than wider bridges.

Because of the difference in equivalent strip width, each width of bridge could have a different design. While this would optimize the sections, it may be inconvenient to have a unique design for so many bridges within the standard. Instead, it would be more desirable to produce one reinforcement design that satisfies all bridge widths. To achieve this, the equivalent strip width for the 28-ft.-wide bridge was used for all widths of the same span. While the design was more conservative for wider bridges, it was consistent with the practice used for designing three-span, haunched-slab bridges. Accordingly, only one model was necessary for each superstructural profile considered for each span length.

The HL-93 load case was then applied over the resulting equivalent strip width. To simplify analysis further, applied loads were divided by the equivalent strip width yielding values of force per unit width of bridge. Loading for all bridges in this project was calculated and adjusted based on the equivalent strip method. One-foot-wide sections allowed for simple analysis and design of frame elements. Calculations of equivalent strip for all bridges of one span length are provided in Appendix A.

### ***Model Setup***

As a three-sided, monolithic system, the structure was modeled as a rigid frame in STAAD. A three-dimensional setup was selected; however, no out-of-plane loading was used. Thus, a two-dimensional model would have been sufficient. Force effects from the program were calculated based on the respective stiffness of elements within the system. The model assumed linear-elastic stress and strain distribution. Since this phase of the project was for preliminary

design, no second-order or P-delta effects were included. These considerations may be left for later phases of design if necessary.

The model consisted of individual frame elements connected at nodes. These elements are capable of carrying axial force, shear, and bending moment. The connection at each node provided continuity to adjacent members and full transfer of all force effects. All degrees of freedom were accounted for except when releases were specified.

### ***Superstructural Modeling***

In order to evaluate the effect of loading at various locations on the superstructure, the slab was equally divided into 10 elements. Nodes were placed such that each slab element was connected at tenth-points. This method provided an approximation of force effects throughout the span. While not exact, the degree of accuracy provided by tenth-point analysis was assumed to be sufficient for design. Important parameters to be modeled for each slab element included its length, width, depth, and modulus of elasticity. Figure 3.1 shows an outline of the frame system modeled in STAAD.



**Figure 3.1: Outline of Frame Elements**

Based on the method of analysis discussed earlier, a width of one foot was used for all slab elements. Length of each was naturally one-tenth of the span length. The depth used the average profile depth of each element between consecutive nodes. For the flat slab, the depth

was, of course, identical for all elements. Table 3.1 shows the depth of flat-slab elements used for modeling and design.

**Table 3.1: Depth of Flat Slab**

| Depth of Flat Slab |                     |
|--------------------|---------------------|
| Span Length        | Slab Thickness (in) |
| 32'                | 15.5                |
| 40'                | 17.0                |
| 48'                | 18.0                |
| 56'                | 19.5                |
| 64'                | 23.0                |
| 72'                | 26.0                |

For the haunched slab, the exact profile had to be determined. The haunch uses a parabolic profile, so depth of the section at tenth-points was calculated accordingly. Figure 3.2 shows a drawing of the haunched-slab profile. Table 3.2 shows depths of the haunched-slab section taken from the existing KDOT bridge design at tenth-points. Averaging adjacent tenth-points provided the depth of each frame element to be used in the computer model. These values are shown in Table 3.3. The stepped profile used in the STAAD model for averaging adjacent nodes is shown in Figure 3.3. All concrete for the bridge was assumed to have 4000 psi compressive strength. Based on strength, a corresponding elastic stiffness of 3605 ksi was used for all concrete members.

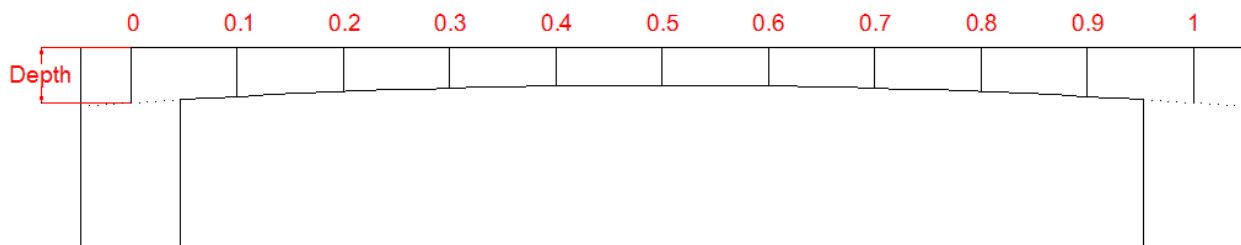

**Figure 3.2: Parabolic Haunched-Slab Profile**



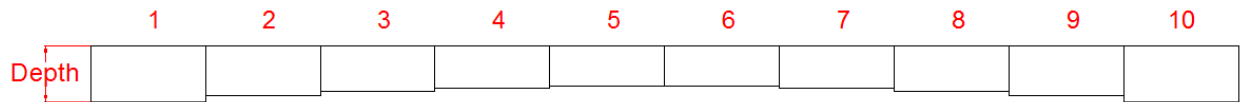

**Figure 3.3: Idealized Haunched-Slab Profile for Model**

**Table 3.2: Depth of Haunched Slab at Tenth-Points on Span**

| Span Length | Depth of Haunched-Slab at Tenth-Points on Span (in) |       |       |       |       |       |       |       |       |       |       |
|-------------|---|-------|-------|-------|-------|-------|-------|-------|-------|-------|-------|
|             | 0   | 0.1   | 0.2   | 0.3   | 0.4   | 0.5   | 0.6   | 0.7   | 0.8   | 0.9   | 1     |
| 32'         | 19.88   | 17.58 | 15.80 | 14.52 | 13.76 | 13.50 | 13.76 | 14.52 | 15.80 | 17.58 | 19.88 |
| 40'         | 21.69   | 19.10 | 17.09 | 15.65 | 14.79 | 14.50 | 14.79 | 15.65 | 17.09 | 19.10 | 21.69 |
| 48'         | 23.44   | 20.58 | 18.36 | 16.77 | 15.82 | 15.50 | 15.82 | 16.77 | 18.36 | 20.58 | 23.44 |
| 56'         | 25.44   | 22.22 | 19.72 | 17.93 | 16.86 | 16.50 | 16.86 | 17.93 | 19.72 | 22.22 | 25.44 |
| 64'         | 31.19   | 26.62 | 23.07 | 20.53 | 19.01 | 18.50 | 19.01 | 20.53 | 23.07 | 26.62 | 31.19 |
| 72'         | 37.00   | 31.06 | 26.44 | 23.14 | 21.16 | 20.50 | 21.16 | 23.14 | 26.44 | 31.06 | 37.00 |

**Table 3.3: Modeled Depth of Haunched-Slab Elements on Span**

| Span Length | Modeled Depth of Haunched-Slab Elements on Span (in) |       |       |       |       |       |       |       |       |       |
|-------------|--|-------|-------|-------|-------|-------|-------|-------|-------|-------|
|             | 1  | 2     | 3     | 4     | 5     | 6     | 7     | 8     | 9     | 10    |
| 32'         | 18.73  | 16.69 | 15.16 | 14.14 | 13.63 | 13.63 | 14.14 | 15.16 | 16.69 | 18.73 |
| 40'         | 20.39  | 18.09 | 16.37 | 15.22 | 14.64 | 14.64 | 15.22 | 16.37 | 18.09 | 20.39 |
| 48'         | 22.01  | 19.47 | 17.56 | 16.29 | 15.66 | 15.66 | 16.29 | 17.56 | 19.47 | 22.01 |
| 56'         | 23.83  | 20.97 | 18.82 | 17.39 | 16.68 | 16.68 | 17.39 | 18.82 | 20.97 | 23.83 |
| 64'         | 28.90  | 24.84 | 21.80 | 19.77 | 18.75 | 18.75 | 19.77 | 21.80 | 24.84 | 28.90 |
| 72'         | 34.03  | 28.75 | 24.79 | 22.15 | 20.83 | 20.83 | 22.15 | 24.79 | 28.75 | 34.03 |

For the haunched slab, member offsets were modeled into the program. Normally, the longitudinal axes of frame members are connected at exactly the same point by a node. Member offsets allow the axis of one member to be located at a different location. This property is important when adjacent elements are not the same depth. In the haunched slab, the top of the elements are at the same elevation, but the centroid of each element is not. The change in elevation of the centroid throughout the slab induces a moment when axial force was present. At each node in the model, adjacent members connected at an eccentricity. Accounting for the moment induced by axial eccentricity achieved greater accuracy in the model. This behavior, of

course, did not occur in flat slabs. Figure 3.4 shows the member offsets in STAAD, providing a flat bridge deck.



**Figure 3.4: Stepped Member Offsets Shown in STAAD Model**

The slab elements were assumed to remain plane and uncracked for the modeled conditions. While this is not representative of real-world conditions, the system itself was not designed in STAAD. The purpose of the model was simply to determine the force distribution in each member of the system. The distribution of forces was assumed to be sufficiently accurate when using gross cross-section properties. This alleviated the burden of evaluating the extent of cracking under ultimate or service conditions. Again, calculation of second-order effects was considered to be unnecessary for preliminary design. Nor was stiffness of the rebar accounted for in the model. Since the concrete was assumed to remain uncracked, modeling of rebar throughout the slab was assumed to have insufficient effect on distribution of forces to warrant its inclusion.

### ***Substructural Modeling***

The concrete abutment walls were modeled according to the same assumptions as the slab. Height of the abutment wall was divided into two-foot increments, similar to the slab. The

abutments themselves were not designed within this project. Rather, modeling of the abutment was used to demonstrate the effect of the substructure on force distribution within the superstructure. Since three-foot-wide abutments were used in all the designs, cracking will likely be limited. Thus, the uncracked section assumption was more valid for the abutments. Exclusion of reinforcement in this case was assumed to have very minor effect.

The standard abutment height of six feet served for replacement of structures with low rise height. Minimum rise height for KDOT box culverts is two feet. If height of a structure is less than six feet, the standard abutment will still be used. In this case, the lower portion of the abutment will be buried, similar to a traditional bridge. When taller structures are needed, height of the abutment must extend to the required depth. For these systems, taller abutments must be designed, including the greater flexural component from lateral earth. The change in height represented the largest change to the abutment design.

Since the maximum KDOT box culvert height is 20 ft., maximum structural height considered in the project was 20 ft. Modeling of the new structural system had to include effects of the shortest and tallest structures. In order to consider practical extreme effects of wall height, separate models using 6-ft. and 20-ft. tall abutments were generated for each span. Again, the purpose of these models was to evaluate the influence of substructural parameters on the design of the superstructure.

Steel HP12x53 piles were included as foundation elements in the model. In practice, for the new system, piles were assumed to be placed under the abutments at 7-ft. spacing. In accordance with the equivalent strip method, properties of the design pile were adjusted to yield accurate results on a per-foot basis. Similar to the abutments, modeling of the piles was not conducted to evaluate their performance, but instead to demonstrate their influence on force

distribution in the superstructure. As steel sections, the model used a modulus of elasticity of 29,000 ksi for piles. To account for their spacing, cross-sectional area and strong-axis moment of inertia of the piles were both divided by seven for modeling purposes. Naturally, piles were aligned such that their strong axis bent was in bending.

To create an accurate model, an acceptable paradigm for the substructure had to be established. Unless site-specific soil data are available, analysis and design must proceed without knowledge of soil conditions. For purposes of designing a standard, consideration of practical extreme criteria was helpful. In this case, effect of soil stiffness on the superstructure was important. Clay represented the upper bound for soil stiffness. Sandy soil represented the lower bound. The stiffness of soil was very influential on performance of the system.

When relatively weak soils are present, piles are assumed to undergo a significant amount of bending. When stiffer soils are present, bending of the pile is assumed to be reduced. Effect of soil stiffness can be modeled based on the depth at which the pile is assumed to reach full fixity. For this project, piles placed in clay soil were assumed to reach fixity at a depth of seven feet below the base of the abutment. In sandy soil, piles were assumed to reach fixity at a depth of 15 feet below the abutment. These values represent practical extremes for the effect of soil stiffness on the new system.

Two models were developed for each soil type: one for clay soil, the other for sandy soil. Since two different abutment heights were used, four models had to be generated for each span. These four models accounted for every possible combination of substructural parameters: two separate wall heights, each paired with two different soil conditions. By modeling these parameters, the superstructure could be adequately designed without knowledge of soil

conditions at a specific project site. Figure 3.5 shows the four model combinations used for the superstructural profile of each span.

|            | 6' Wall | 20' Wall |
|------------|---------|----------|
| Clay Soil  | A       | C        |
| Sandy Soil | B       | D        |

**Figure 3.5: Model Combinations**

Figure 3.6 shows a STAAD model view of a one-foot strip of bridge with a 6-ft. abutment wall and clay soil.

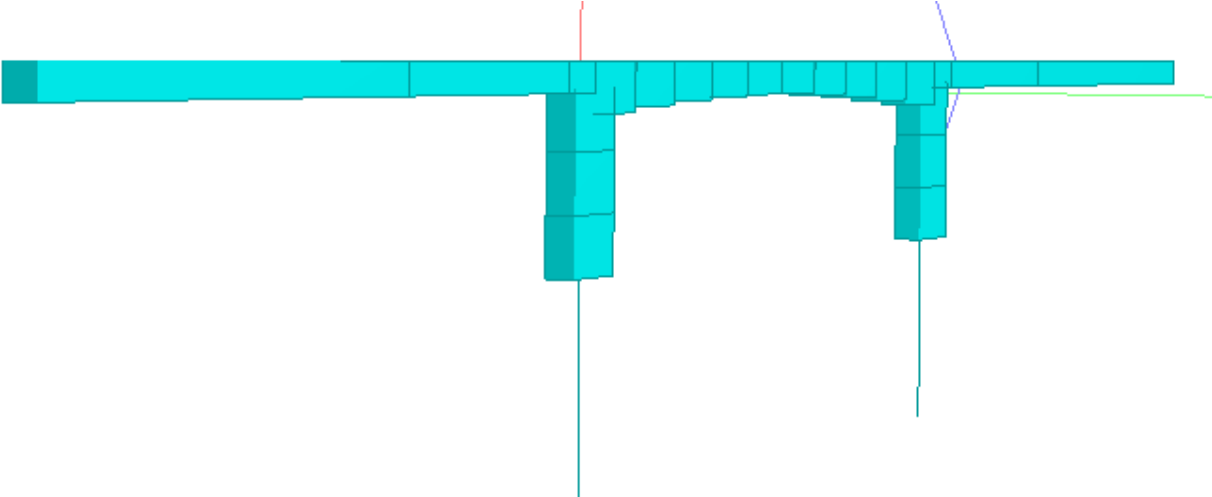

**Figure 3.6: Modeled View of Strip with 6-ft. Abutment and Clay Soil**

Figure 3.7 shows a STAAD model view of a one-foot strip with a 20-ft. abutment wall and sandy soil.

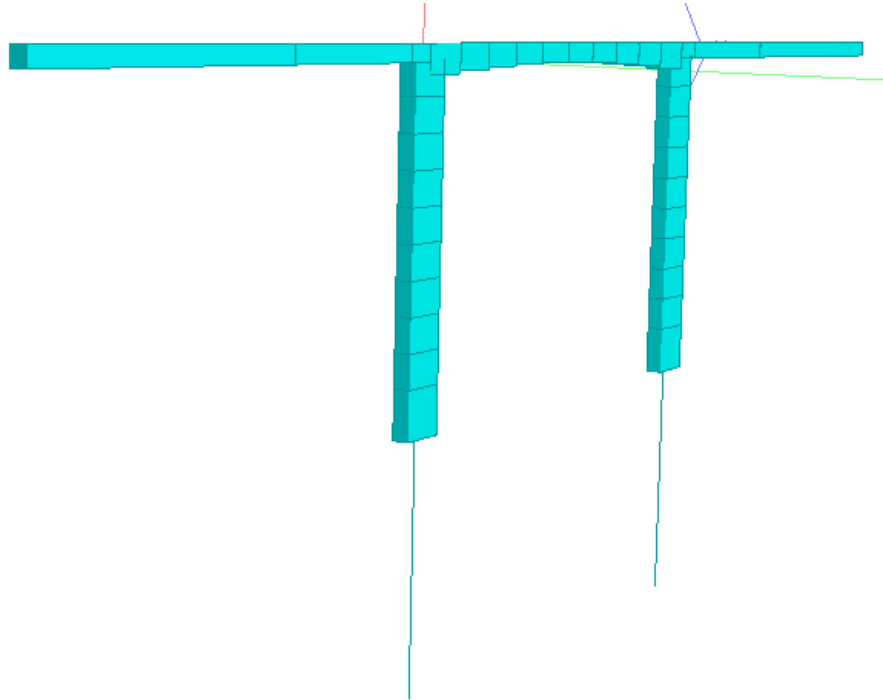

**Figure 3.7: Modeled View of Strip with 20-ft. Abutment and Sandy Soil**

### ***Connection and Joint Modeling***

A standard KDOT approach slab was modeled into the system. A one-foot-thick slab was connected to the abutments. The slab length measured 33 ft. The approach slab was supported by two footings and the abutment. The first footing was placed 13 ft. from the abutment. The second was at the end of the slab (KDOT, 2010). Connections at both footings and the abutment were assumed to be pinned. This allowed the transfer of shear, but not moment, from the slab into the abutment.

## ***Loads***

In addition to components of the system, effect of loads must be properly modeled as well. As a preliminary design model, basic load cases were considered. Load types used in the model included dead, live, impact, and lateral earth. An explanation of each load type and how they are applied is provided.

Dead load was applied to each member in the system. For concrete members, a unit weight of 150 pcf was used. Figure 3.8 shows the deflected shape of the system under dead load.

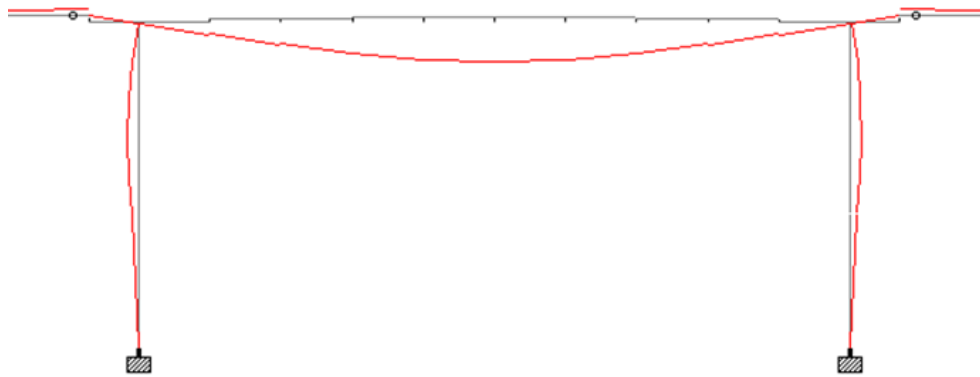

**Figure 3.8: Dead Load Deflection of Structure**

Live load consisted of the AASHTO HL-93 truck, tandem, and lane load. For this load case, the truck load consisted of one, 8-kip front axle followed by two, 32-kip axles. Spacing between the first and second axle was fixed at 14 ft. Spacing between the second and third axles varied from 14 ft. to 30 ft. (AASHTO, 2010). Figure 3.9 shows one iteration of axle loads from the AASHTO HL-93 truck acting on the structure.

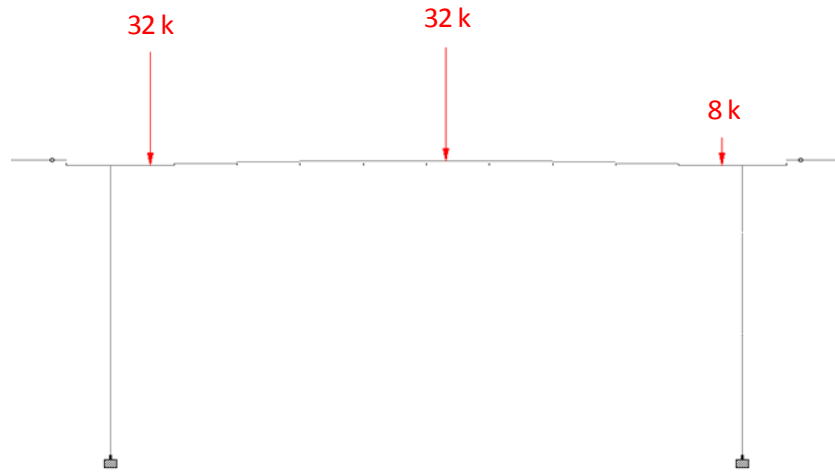

**Figure 3.9: AASHTO HL-93 Truck Load on Structure**

When applying the live load case, the truck was moved from one abutment to the other in one-foot increments. To account for the change in axle spacing, additional iterations of truck movement were provided with rear-axle spacing increasing one foot at a time. All combinations of axle configurations were applied over the entire span. The tandem load used two, 25-kip axles, separated by four feet, applied across the structure in identical fashion (AASHTO, 2010). Figure 3.10 shows one iteration of AASHTO HL-93 tandem loads acting on the structure.

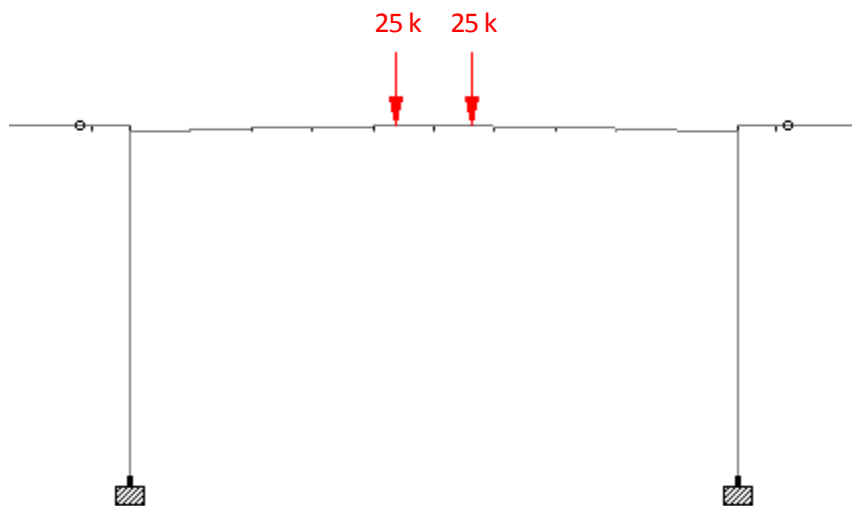

**Figure 3.10: AASHTO HL-93 Tandem Load on Structure**



Lane load consisted of a 640 plf distributed load (AASHTO, 2010). Since the approach slab transfers shear to the bridge, the lane load was applied to the approach slab as well. Figure 3.11 shows the application of lane load to the system.

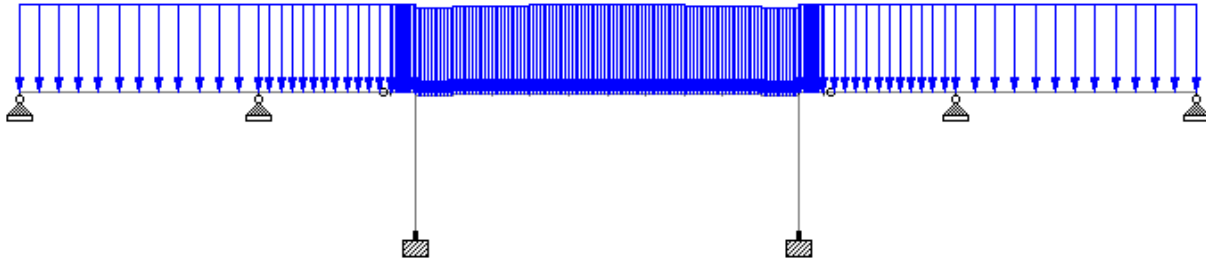

**Figure 3.11: AASHTO HL-93 Lane Load on Structure**

Magnitude of the lane load was distributed over the full equivalent strip width. Thus, like the truck and tandem loads, the lane load had to be adjusted for application on a per-foot basis. The HL-93 load case involved two combinations. The first used truck load and lane load. The second used tandem load and lane load (AASHTO, 2010). As with any live load case, any component of the load may be applied or omitted as needed to generate extreme force effects on the structure.

According to Sec. 3.6.1.1 of the code, live load must be adjusted to account for the effect of multiple presence of vehicles. Based on the number of lanes of bridge loaded, live load values were multiplied by the appropriate factor. Extreme force effects were generated when a multiple presence factor corresponding to one lane loaded was used. Consequently, a multiple presence factor of 1.20 was conservatively used regardless of the number of lanes loaded. The equivalent strip method was calibrated to include the multiple presence factor; multiplication of the load values was not required (AASHTO, 2010).

Since moving loads were applied to the structure, effect of impact had to be included. Section 3.6.2.1 of the code specifies different load factors for impact based on limit states and the affected component in the system. One impact factor was used for deck joints. Since no joints were modeled into the system, this load factor was avoided. The impact factor for other elements in the fatigue limit state was 1.15. All other limit states used an impact factor of 1.33 (AASHTO, 2010). This factor was multiplied by the truck, tandem, and lane loads at every position they occupied on the structure.

Finally, lateral earth load was considered. Since specific soil data were not available, assumptions were again made for soil properties. For lateral earth loading, active earth pressure was assumed. Important parameters for active earth pressure are the coefficient and unit weight of soil. For this project, a coefficient of active earth of 1.33 and a unit weight of 120 pcf were used. Both of these represented typical average values used for modeling impact of soil on the structure.

Lateral earth pressure is assumed to increase linearly in magnitude with depth. The pressure value was divided by the one-foot width to provide a vertically distributed load throughout the soil profile. As part of preliminary design, no attempt was made to develop a soil-pressure envelope, considering practical maximum and minimum values. Use of the same soil load for all models was assumed to be sufficient. Lateral earth load was calculated according to the following equation:

$$\omega(d) = (K_{aa})(\gamma_{soil})(d)(1 \text{ ft.})$$

where  $K_{aa}$  = coefficient of active earth,

$\gamma_{soil}$  = unit weight of soil, and

d = depth in soil profile below grade

For 6-ft.-tall abutments, lateral earth was applied to the outside face of the top three feet of wall. This value represented a field situation where only three feet of wall is exposed and the remainder of the abutment is below grade level. For this structure, the wall below grade was counteracting soil pressure on both faces. This load was consequently ignored. The 3-ft.-tall box culvert is one of the shortest structures. While 2-ft.-tall culverts exist, their use is rare. The 3-ft. option was modeled since its use is more common. Figure 3.12 shows lateral earth load on the top three feet of a 6-ft. abutment.

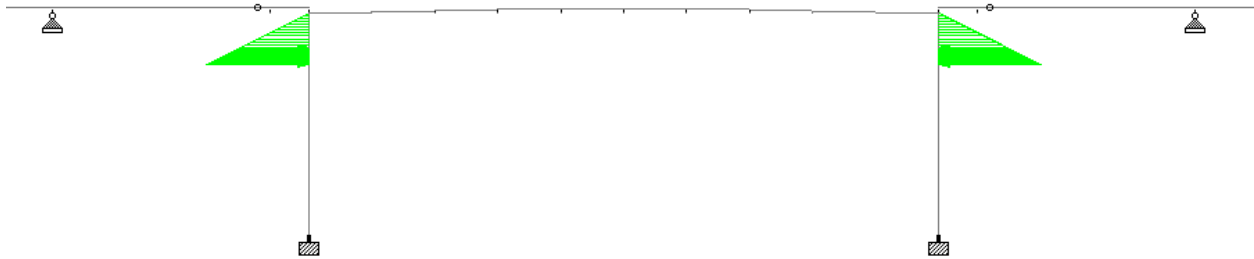

**Figure 3.12: Lateral Earth Load on 6-ft. Abutment Wall**

For 20-ft.-tall abutments, lateral earth load was applied to the entire height of the abutment wall. Load was applied on the outside face, since the entire inside face of the wall was assumed to be open waterway area. The base of the abutment wall was assumed to be roughly at ground elevation. No earth loads were applied to the piles, since assuming an appropriate unbraced length was considered to be an adequate substitute for a more detailed soil modeling approach. Figure 3.13 shows lateral earth load on a 20-ft. abutment.

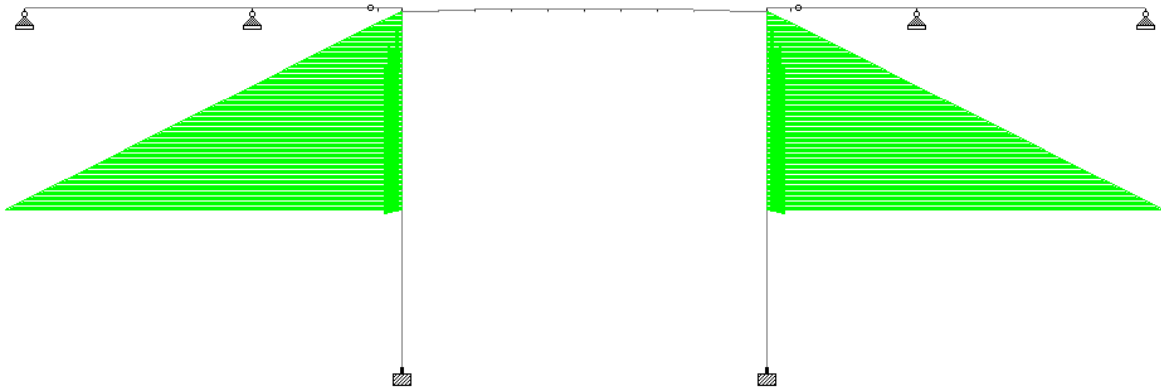

**Figure 3.13: Lateral Earth Load on 20-ft. Abutment Wall**

Since the model served to provide a distribution of forces for preliminary design, only the most significant loads were considered. Minor or insignificant load cases were excluded at this time, but may be included for final design. Permanent loads listed for consideration in the code, but not included in the model, are listed here:

- Dead load of components and attachments
- Downdrag
- Weight of wearing surfaces and utilities
- Locked-in construction stresses
- Vertical earth pressure
- Earth surcharge
- Prestressing
- Creep
- Shrinkage

Insufficient information was available at this time for components and attachments, downdrag, utilities, and construction stresses. The bridge deck is expected to serve as the

wearing surface for the service life of the structure. Application of overlays is no longer traditional practice in Kansas, so this effect was excluded. Since the bridge deck is situated at grade elevation, use of overfill was avoided. Thus, no vertical earth pressure is present. The effect of earth surcharge results in lateral load on the abutments, similar to lateral earth pressure. Since this does not contribute to extreme force effects in the slab, it was ignored. Post-tensioning and its associated effects of creep and shrinkage were not applicable to any part of the bridge.

Live load effects not modeled include the following:

- Centrifugal force
- Braking
- Pedestrian

The code specifies, but does not require, consideration of centrifugal force, so it was not included here. Braking force is not assumed to create a significant impact on design of the structures, so it was omitted. The bridges were not designed with the intention of accommodating pedestrian travel.

Transient loads not considered include the following:

- Water
- Wind on structure
- Wind on vehicles
- Friction
- Temperature
- Settlement
- All extreme-event load cases

Water pressure effects were excluded since upward force on the slab does not contribute to extreme force effects in the superstructure. Wind loads on the structure and vehicles, and friction between elements were assumed to be negligible in the design of the bridge. Temperature effects were excluded in the preliminary model, but are relevant in final design. Values for settlement and other deformations were unknown and were not taken into consideration here. Extreme events included earthquakes, ice, and vehicular and vessel collisions. Extreme-event limit states were not included in the preliminary portion of the project. If necessary, any or all of the omitted load cases can be considered for final design.

### ***Load Combinations***

In order to consider the effect of these load cases on the structure, proper load combinations were applied. Load combinations were obtained from the code. Combinations considered for preliminary design included Strength I, Service I, and Fatigue I. Effects of each individual load case were modeled in STAAD. Appropriate load factors were applied to each load case as required by the respective load combinations.

Strength I limit state included all calculated load cases: dead, live, impact, and lateral earth. A load factor of 1.25 was applied to dead load. A load factor of 1.75 was applied to the live load and impact cases. For these cases, these load factors were the maximum values allowed by the code. Finally, a load factor of 0.5 was applied to the lateral earth load. Since lateral earth load does not contribute to extreme force effects in the slab, a minimum load factor was applied. This exception to conventional practice was executed according to Sec. 3.11.7 of the code. Finally, all loads for the strength limit state were multiplied by a modifier of 1.05 as suggested by Sec. 3.4.1 of the code (AASHTO, 2010). Strength I load combination considered for this project can be summarized as follows:

$$Q = 1.05\{1.25(\text{DC}) + 1.75[1.33(\text{LL})] + 0.5(\text{EH})\}$$

where DC = dead load,

LL = live load, and

EH = lateral earth load

Service I limit state included the same force effects as Strength I. The load factors were different, however. Service I used load factors of 1.0 for all loads except the lateral earth load. For lateral earth, the same load factor of 0.5 was used. Service I load combinations can be summarized as follows:

$$Q = 1.0(\text{DC}) + 1.0[1.33(\text{LL})] + 0.5(\text{EH})$$

For fatigue limit state, a load factor of 1.0 was used for dead, 1.5 for live, and 0.5 for lateral earth load. For calculating stress ranges, only live load was considered. In this case, only the truck load was used. A spacing of 30 ft. between the rear axles was used. A load factor of 0.75 was used. Fatigue load combination can be summarized as follows:

$$Q = 1.0(\text{DC}) + 1.5[1.33(\text{LL})] + 0.5(\text{EH})$$

For consideration of stress range and minimum moment, the load combination can be summarized as follows:

$$Q = 0.75[1.33(\text{LL})]$$

### ***Summary of STAAD Model Setup***

Development of the short-span bridge standard required consideration of a wide variety of parameters. Modeling the bridge system required assumptions, generalizations, and constraints to reduce the task into a solvable problem. For the short-span bridge system, analysis and design of each span depended on a small set of models. Each span had two competing profiles: a flat slab and haunched slab. Each profile used four models.

The four models used the same superstructural profile throughout. Differences were in the substructure. These variations included differences in abutment wall height and soil conditions. Practical extremes for wall height were six feet for the shortest wall and 20 ft. for the tallest wall. Practical extremes for soil conditions were clay for the stiffest soil and sand for the least stiff soil. The four models represented all unique combinations of extreme substructural conditions:

- short wall with clay soil
- tall wall with clay soil
- short wall with sandy soil
- tall wall with sandy soil

These models demonstrated the full range of effects the substructure had on the superstructure. From these results, each profile could be designed. The same load cases were applied to each model. AASHTO load combinations used included Strength I, Service I, and Fatigue. Each combination used dead, HL-93 live, and lateral earth load cases. Load cases were ignored if thought to be irrelevant or insignificant, if inadequate information was available, or if the load cases were better left for later stages of design.

The goal of the preliminary models was to evaluate the effect of the most important loads, testing the adequacy of the proposed system. Results with the greatest magnitude from each of the four models represented the design case for each profile. Designs of the two slab profiles could then be compared and evaluated.

### ***Model Verification***

A properly constructed computer model can provide useful results for a designer. However, care must be taken to ensure the model's assumptions are accurate and reflective of



actual practice. In order to verify the validity of the computer models, an example problem for the design of a slab bridge was obtained. The structure was a three-span, flat-slab bridge. The design example was developed by HDR Inc. for the Florida DOT.

The example demonstrated selection and calculation of applicable loads and load combinations. These loads were then applied to the facility. Results of structural analysis showed the moment envelope at tenth-points on each span. These results were used to design the bridge. Since the bridge profile was already selected, reinforcement was the only component to be designed. Design calculations according to the code were shown. Design was developed for strength, service, and fatigue limit states. The example demonstrated design of a bridge very similar to the system in this project (FDOT, n.d.).

For verification, a STAAD model was constructed according to the specifications of the design example. Structural analysis results from the STAAD model were compared to those provided by the design example. The magnitude of maximum and minimum moment at each tenth-point on the slab from the STAAD model matched the values provided by the design example within 2.5%. Results were determined to be sufficiently precise that the STAAD models could be trusted to provide accurate analysis results for the new bridge system.

### **Structural Analysis of the New System**

Structural analysis of the new bridge system was primarily concerned with the bending moment at tenth-points on the span. Values for shear force were captured but not used since Sec. 4.6.3.2.1 of the code does not require decks to be checked for shear (AASHTO, 2010). Midspan deflection data were captured as well. However, the model used gross cross-section properties and did not consider cracking of the slab. Since deflections are a function of cracked-section

depth, values provided by the model were not suitable for comparison with limits allowed by code. Hence, deflection data are not included in this report.

This subchapter will include an explanation of how structural analysis was performed. Evidence of the substructure's effect on the superstructure's design will be presented. A comparison of haunched and slab sections will be used to demonstrate the most appropriate profile for the new system. Finally, structural analysis results for all spans and profiles are included.

### ***Analysis Procedure***

As stated earlier, for each span profile under consideration, four models were generated, based on different substructural conditions. Analysis of each load case was performed separately in order to distinguish their respective effects. Moment envelopes were created in STAAD in order to show maximum and minimum effect each load case had on the structure. Force effects from each load case were then superimposed onto one another, including appropriate load factors, to assemble required load combinations. Accumulation of this process was a moment envelope at tenth-points for all three limit states under consideration. These values represented final results of the analysis and were subsequently used in design.

### ***Evaluation of Substructural and Profile Effects***

One important goal of the modeling and analysis process was to determine the effect substructural parameters had on design of the superstructure. Data from all four models were captured and shown to demonstrate these effects. Specifically, a comparison of moment envelopes along the span was used to evaluate the type of substructural conditions most conducive for providing an efficient superstructural design. An attempt was made to observe relevant trends and conclusions.

An additional goal was to evaluate if one type of superstructural profile was more suitable than the other for application in the short-span bridge system. Haunched and flat-slab profiles were compared to determine if load distribution was more advantageous in one of the systems. Based on noteworthy differences in design moment observed between the two profiles, one system was selected for exclusive analysis and design.

First, analysis of the 32-ft. and 72-ft. spans was prepared. Since these represented extreme ends of the span range, results could verify if certain characteristics or trends in performance could be evaluated over the full spectrum of span lengths. Both profiles were considered for each span. Haunched and flat profiles for the 32-ft. and 72-ft. spans were selected for the comparison. Only values for Strength I limit state are shown, since these were used in ultimate design. Similar behavior was also observed in other limit states. By showing all four model results for both spans, proper conclusions can be drawn.

### ***32-ft. Haunched Slab***

This subchapter shows maximum and minimum moment obtained from analysis of the 32-ft., haunched-slab section. Data was separated within the tables and graphs by abutment wall height and soil conditions for comparison purposes. Table 3.4 shows moment values obtained for the 32-ft. haunched slab.

**Table 3.4: Substructural Influence on Moment for 32-ft. Haunched Slab**

| Point on Span | Strength I Limit State |                    |                    |                    |                    |                    |                    |                    |
|---------------|------------------------|--------------------|--------------------|--------------------|--------------------|--------------------|--------------------|--------------------|
|               | 6' Wall - Clay         |                    | 6' Wall - Sand     |                    | 20' Wall - Clay    |                    | 20' Wall - Sand    |                    |
|               | $M_{max}$ (kip-in)     | $M_{min}$ (kip-in) | $M_{max}$ (kip-in) | $M_{min}$ (kip-in) | $M_{max}$ (kip-in) | $M_{min}$ (kip-in) | $M_{max}$ (kip-in) | $M_{min}$ (kip-in) |
| 0             | -199.5                 | -889.8             | -142.3             | -626.5             | -236.0             | -997.3             | -288.1             | -957.3             |
| 0.1           | 40.5                   | -435.9             | 137.9              | -243.8             | -8.6               | -530.5             | -41.9              | -506.4             |
| 0.2           | 232.9                  | -180.4             | 440.2              | -44.1              | 177.6              | -268.6             | 152.3              | -262.7             |
| 0.3           | 417.3                  | -21.2              | 662.3              | 78.2               | 327.5              | -81.5              | 350.0              | -108.4             |
| 0.4           | 528.4                  | 74.4               | 791.2              | 143.5              | 431.4              | 24.9               | 465.5              | -15.6              |
| 0.5           | 561.0                  | 106.8              | 836.7              | 165.8              | 460.4              | 67.3               | 501.0              | 13.3               |
| 0.6           | 528.4                  | 74.4               | 791.2              | 143.5              | 431.4              | 24.9               | 465.5              | -15.6              |
| 0.7           | 417.3                  | -21.2              | 662.3              | 78.2               | 327.5              | -81.5              | 350.0              | -108.4             |
| 0.8           | 232.9                  | -180.4             | 440.2              | -44.1              | 177.6              | -268.6             | 152.3              | -262.7             |
| 0.9           | 40.5                   | -435.9             | 137.9              | -243.8             | -8.6               | -530.5             | -41.9              | -506.4             |
| 1             | -199.5                 | -889.8             | -142.3             | -626.5             | -236.0             | -997.3             | -288.1             | -957.3             |

Figure 3.14 shows a graph of maximum moment values for the 32-ft. haunched slab.

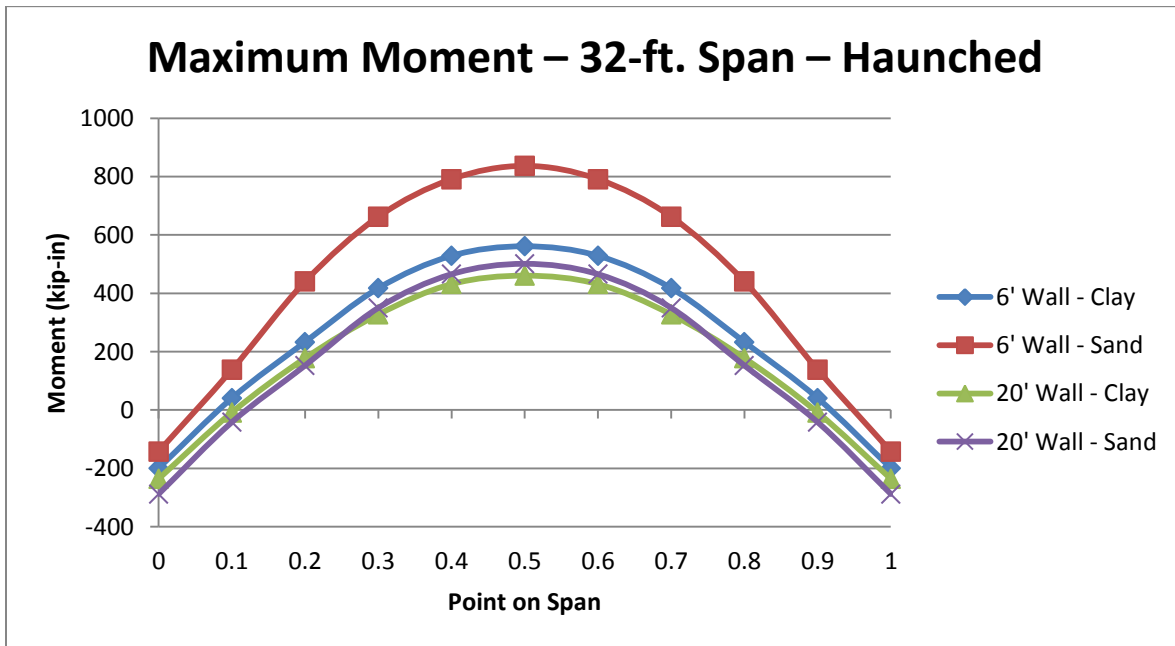

**Figure 3.14: Substructural Influence on Maximum Moment for 32-ft. Haunched Slab**

Figure 3.15 shows a graph of minimum moment values for the 32-ft. haunched slab.

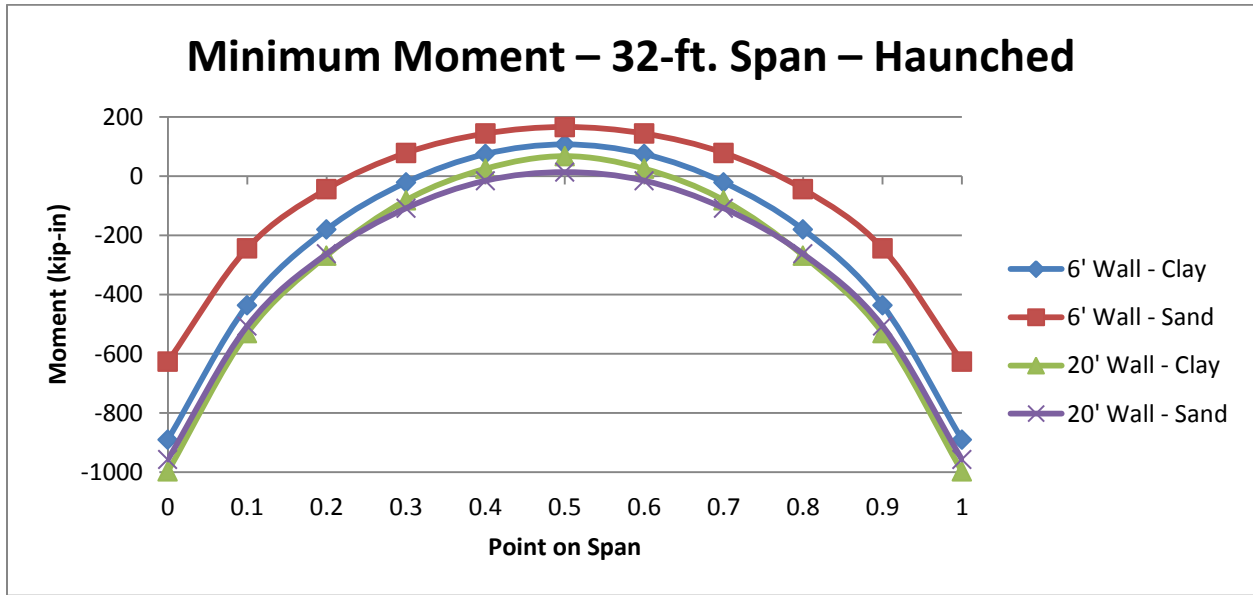

Figure 3.15: Substructural Influence on Minimum Moment for 32-ft. Haunched Slab

### 32-ft. Flat Slab

This subchapter shows maximum and minimum moments obtained from analysis of the 32-ft., flat-slab section. Table 3.5 shows moment values obtained for the 32-ft. flat slab.

Table 3.5: Substructural Influence on Moment for 32-ft. Flat Slab

| Point on Span | Strength I         |                    |                    |                    |                    |                    |                    |                    |
|---------------|--------------------|--------------------|--------------------|--------------------|--------------------|--------------------|--------------------|--------------------|
|               | 6' Wall - Clay     |                    | 6' Wall - Sand     |                    | 20' Wall - Clay    |                    | 20' Wall - Sand    |                    |
|               | $M_{max}$ (kip-in) | $M_{min}$ (kip-in) | $M_{max}$ (kip-in) | $M_{min}$ (kip-in) | $M_{max}$ (kip-in) | $M_{min}$ (kip-in) | $M_{max}$ (kip-in) | $M_{min}$ (kip-in) |
| 0             | -179.9             | -783.5             | -140.7             | -624.6             | -220.6             | -887.5             | -279.6             | -858.7             |
| 0.1           | 72.0               | -322.6             | 145.0              | -240.3             | 20.5               | -414.5             | -18.6              | -406.3             |
| 0.2           | 312.1              | -100.7             | 445.8              | -40.8              | 225.0              | -170.2             | 236.3              | -197.8             |
| 0.3           | 542.8              | 42.6               | 671.2              | 81.7               | 444.9              | -11.5              | 467.8              | -57.0              |
| 0.4           | 681.1              | 133.6              | 802.6              | 146.3              | 579.1              | 84.1               | 605.9              | 32.4               |
| 0.5           | 730.3              | 158.1              | 849.1              | 169.0              | 628.3              | 117.4              | 654.7              | 57.2               |
| 0.6           | 681.1              | 133.6              | 802.6              | 146.3              | 579.1              | 84.1               | 605.9              | 32.4               |
| 0.7           | 542.8              | 42.6               | 671.2              | 81.7               | 444.9              | -11.5              | 467.8              | -57.0              |
| 0.8           | 312.1              | -100.7             | 445.8              | -40.8              | 225.0              | -170.2             | 236.3              | -197.8             |
| 0.9           | 72.0               | -322.6             | 145.0              | -240.3             | 20.5               | -414.5             | -18.6              | -406.3             |
| 1             | -179.9             | -783.5             | -140.7             | -624.6             | -220.6             | -887.5             | -279.6             | -858.7             |

Figure 3.16 shows a graph of maximum moment values for the 32-ft. flat slab.

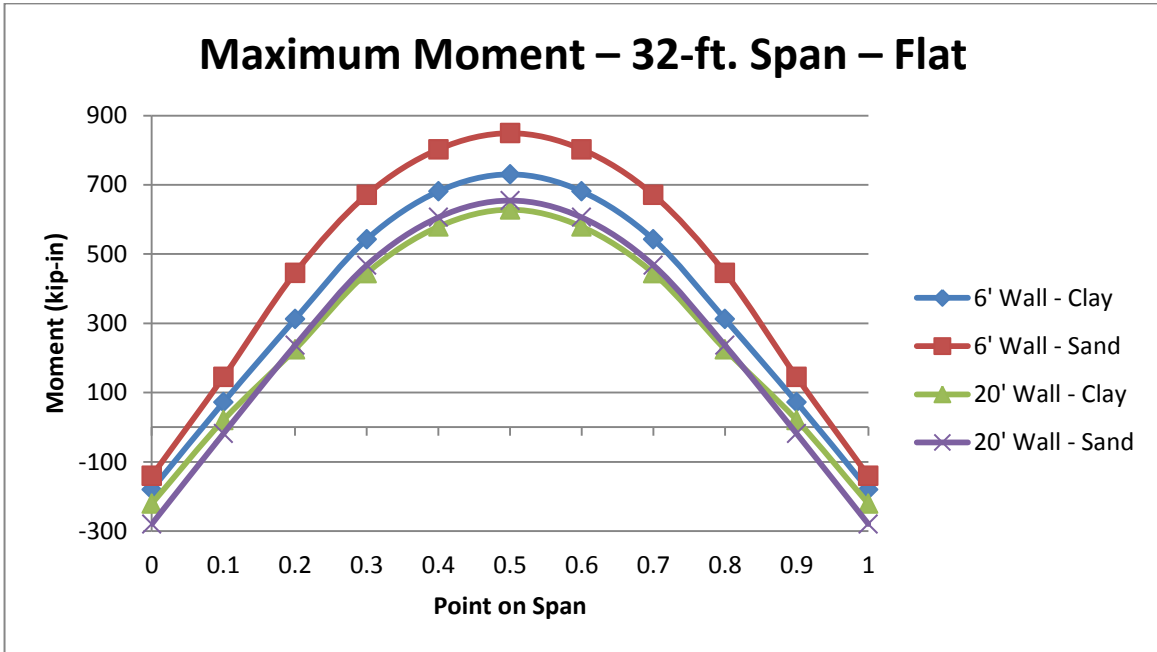

Figure 3.16: Substructural Influence on Maximum Moment for 32-ft. Flat Slab

Figure 3.17 shows a graph of minimum moment values for the 32-ft. flat slab.

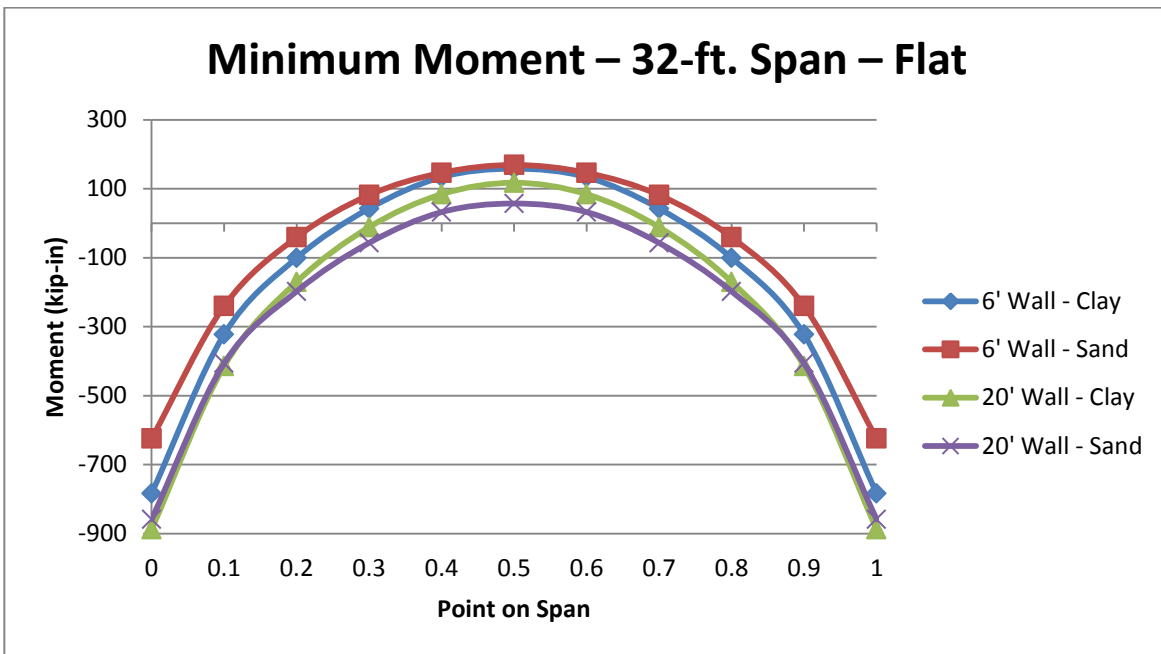

Figure 3.17: Substructural Influence on Minimum Moment for 32-ft. Flat Slab

### 72-ft. Haunched Slab

This subchapter shows maximum and minimum moments obtained from analysis of the 72-ft., haunched-slab section. Table 3.6 shows moment values obtained for the 72-ft. haunched slab.

**Table 3.6: Substructural Influence on Moment for 72-ft. Haunched Slab**

| Point on Span | Strength I Limit State    |                           |                           |                           |                           |                           |                           |                           |
|---------------|---------------------------|---------------------------|---------------------------|---------------------------|---------------------------|---------------------------|---------------------------|---------------------------|
|               | 6' Wall - Clay            |                           | 6' Wall - Sand            |                           | 20' Wall - Clay           |                           | 20' Wall - Sand           |                           |
|               | M <sub>max</sub> (kip-in) | M <sub>min</sub> (kip-in) | M <sub>max</sub> (kip-in) | M <sub>min</sub> (kip-in) | M <sub>max</sub> (kip-in) | M <sub>min</sub> (kip-in) | M <sub>max</sub> (kip-in) | M <sub>min</sub> (kip-in) |
| 0             | -1706.6                   | -3497.6                   | -1009.7                   | -2063.4                   | -2035.3                   | -4145.0                   | -1773.9                   | -3486.8                   |
| 0.1           | -330.3                    | -1463.0                   | 579.0                     | -192.6                    | -712.8                    | -1996.5                   | -355.8                    | -1439.4                   |
| 0.2           | 780.9                     | -244.3                    | 2006.2                    | 810.6                     | 337.7                     | -760.5                    | 793.9                     | -226.5                    |
| 0.3           | 1620.6                    | 545.1                     | 3041.3                    | 1346.4                    | 1122.1                    | 120.9                     | 1670.1                    | 548.8                     |
| 0.4           | 2145.6                    | 909.0                     | 3653.9                    | 1657.6                    | 1603.3                    | 597.9                     | 2243.5                    | 882.1                     |
| 0.5           | 2306.6                    | 1009.3                    | 3844.6                    | 1763.6                    | 1752.5                    | 717.6                     | 2427.3                    | 988.7                     |
| 0.6           | 2145.6                    | 909.0                     | 3653.9                    | 1657.6                    | 1603.3                    | 597.9                     | 2243.5                    | 882.1                     |
| 0.7           | 1620.6                    | 545.1                     | 3041.3                    | 1346.4                    | 1122.1                    | 120.9                     | 1670.1                    | 548.8                     |
| 0.8           | 780.9                     | -244.3                    | 2006.2                    | 810.6                     | 337.7                     | -760.5                    | 793.9                     | -226.5                    |
| 0.9           | -330.3                    | -1463.0                   | 579.0                     | -192.6                    | -712.8                    | -1996.5                   | -355.8                    | -1439.4                   |
| 1             | -1706.6                   | -3497.6                   | -1009.7                   | -2063.4                   | -2035.3                   | -4145.0                   | -1773.9                   | -3486.8                   |

Figure 3.18 shows a graph of maximum moment values for the 72-ft. haunched slab.

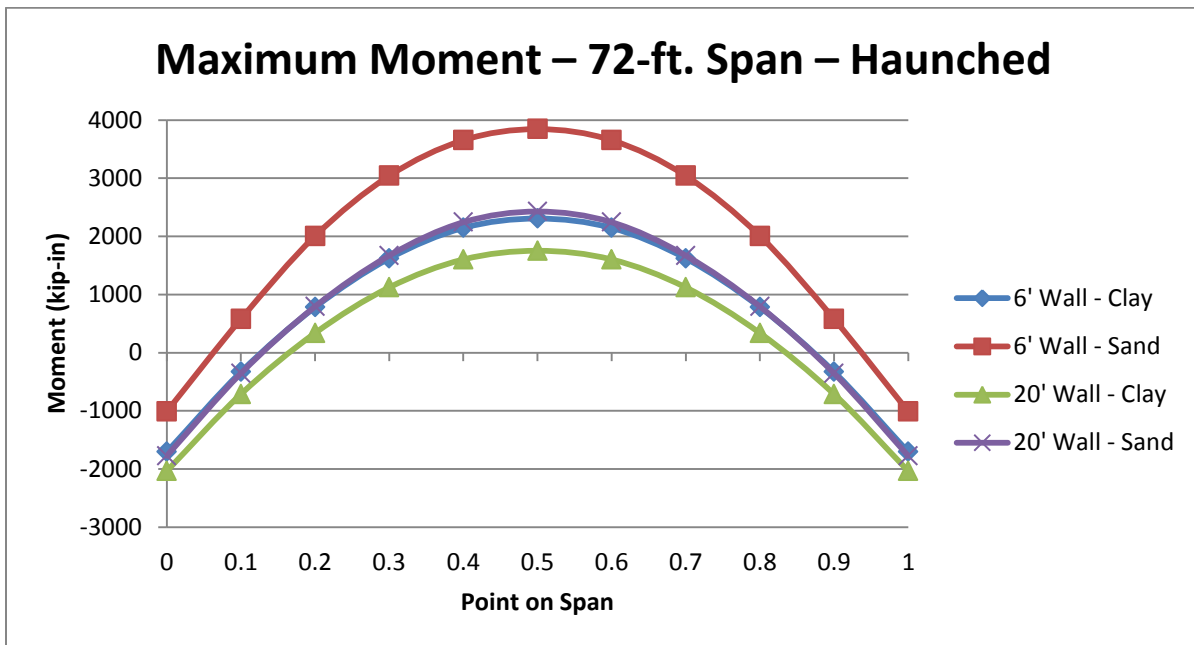

**Figure 3.18: Substructural Influence on Maximum Moment for 72-ft. Haunched Slab**

Figure 3.19 shows a graph of minimum moment values for the 72-ft. haunched slab.

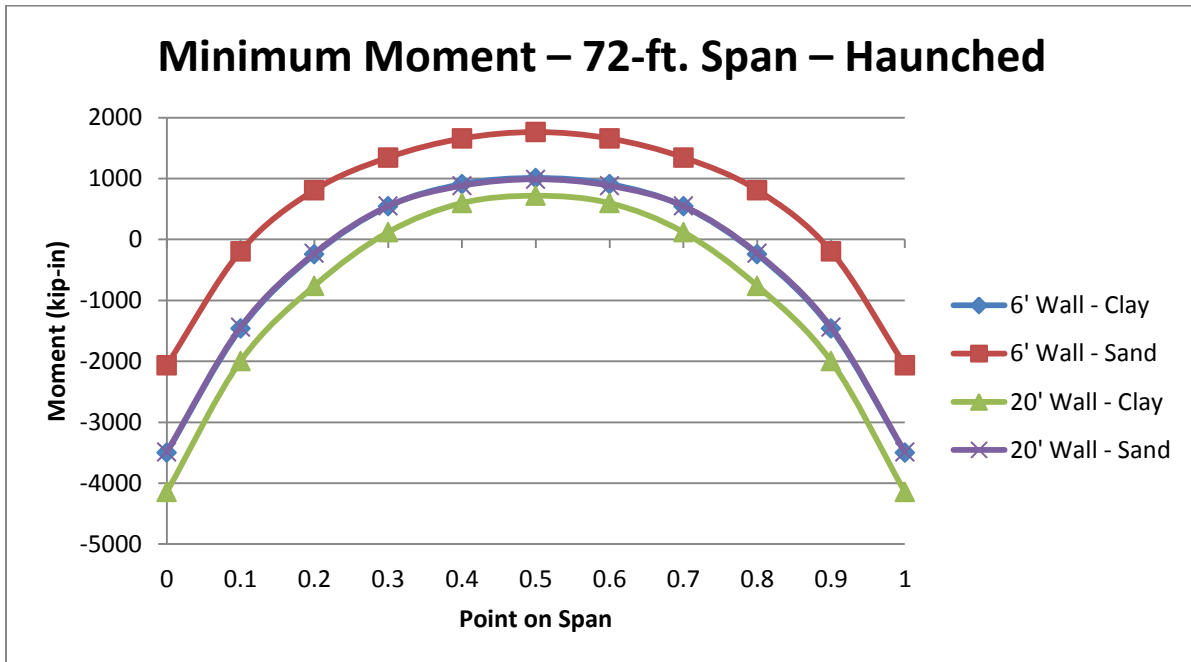

**Figure 3.19: Substructural Influence on Minimum Moment for 72-ft. Haunched Slab**

### *72-ft. Flat Slab*

This subchapter shows maximum and minimum moments obtained from analysis of the 72-ft., flat-slab section. Table 3.7 shows moment values obtained for the 72-ft. flat slab.



**Table 3.7: Substructural Influence on Moment for 72-ft. Flat Slab**

| Point on Span | Strength I Limit State    |                           |                           |                           |                           |                           |                           |                           |
|---------------|---------------------------|---------------------------|---------------------------|---------------------------|---------------------------|---------------------------|---------------------------|---------------------------|
|               | 6' Wall - Clay            |                           | 6' Wall - Sand            |                           | 20' Wall - Clay           |                           | 20' Wall - Sand           |                           |
|               | M <sub>max</sub> (kip-in) | M <sub>min</sub> (kip-in) | M <sub>max</sub> (kip-in) | M <sub>min</sub> (kip-in) | M <sub>max</sub> (kip-in) | M <sub>min</sub> (kip-in) | M <sub>max</sub> (kip-in) | M <sub>min</sub> (kip-in) |
| 0             | -1519.7                   | -2949.2                   | -831.4                    | -1608.6                   | -1858.3                   | -3570.0                   | -1589.9                   | -2923.4                   |
| 0.1           | -33.9                     | -915.9                    | 893.3                     | 189.8                     | -445.5                    | -1455.2                   | -73.2                     | -925.3                    |
| 0.2           | 1325.6                    | 320.9                     | 2563.1                    | 1123.1                    | 805.6                     | -168.8                    | 1322.2                    | 287.2                     |
| 0.3           | 2432.2                    | 1075.3                    | 3737.0                    | 1763.2                    | 1829.6                    | 675.1                     | 2453.8                    | 1004.8                    |
| 0.4           | 3118.5                    | 1462.7                    | 4456.7                    | 2150.7                    | 2498.6                    | 1124.1                    | 3143.6                    | 1392.3                    |
| 0.5           | 3341.2                    | 1597.4                    | 4672.6                    | 2285.4                    | 2724.1                    | 1258.8                    | 3365.0                    | 1527.0                    |
| 0.6           | 3118.5                    | 1462.7                    | 4456.7                    | 2150.7                    | 2498.6                    | 1124.1                    | 3143.6                    | 1392.3                    |
| 0.7           | 2432.2                    | 1075.3                    | 3737.0                    | 1763.2                    | 1829.6                    | 675.1                     | 2453.8                    | 1004.8                    |
| 0.8           | 1325.6                    | 320.9                     | 2563.1                    | 1123.1                    | 805.6                     | -168.8                    | 1322.2                    | 287.2                     |
| 0.9           | -33.9                     | -915.9                    | 893.3                     | 189.8                     | -445.5                    | -1455.2                   | -73.2                     | -925.3                    |
| 1             | -1519.7                   | -2949.2                   | -831.4                    | -1608.6                   | -1858.3                   | -3570.0                   | -1589.9                   | -2923.4                   |

Figure 3.20 shows a graph of maximum moment values for the 72-ft. flat slab.

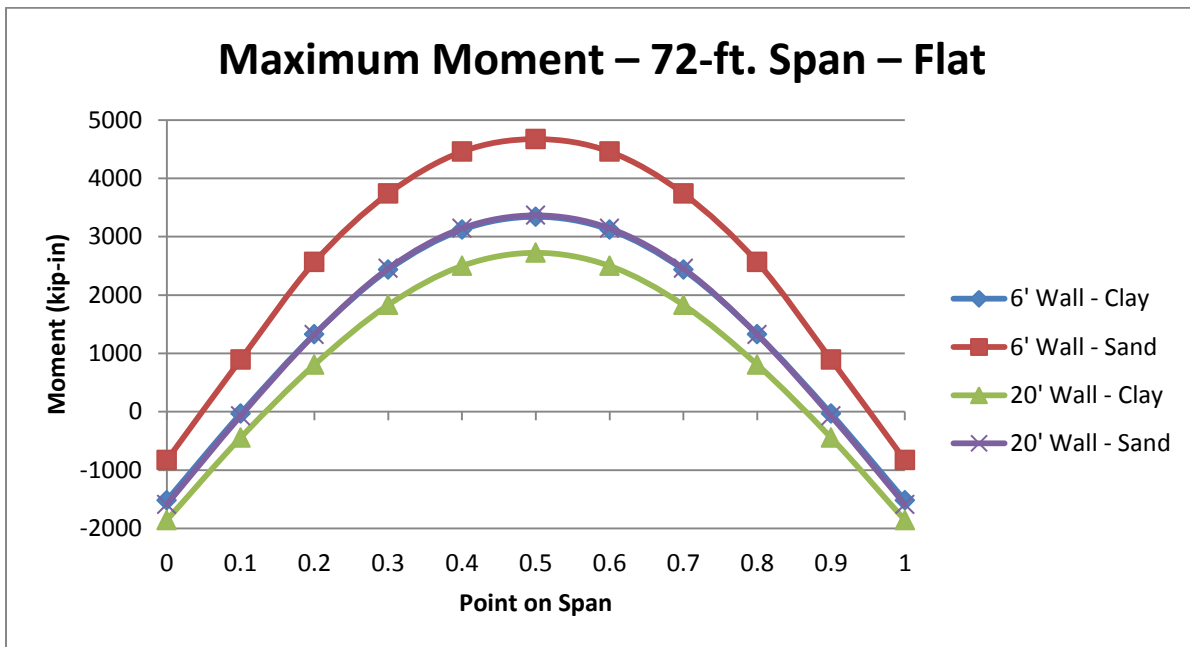

**Figure 3.20: Substructural Influence on Maximum Moment for 72-ft. Flat Slab**

Figure 3.21 shows a graph of minimum moment values for the 72-ft. flat slab.

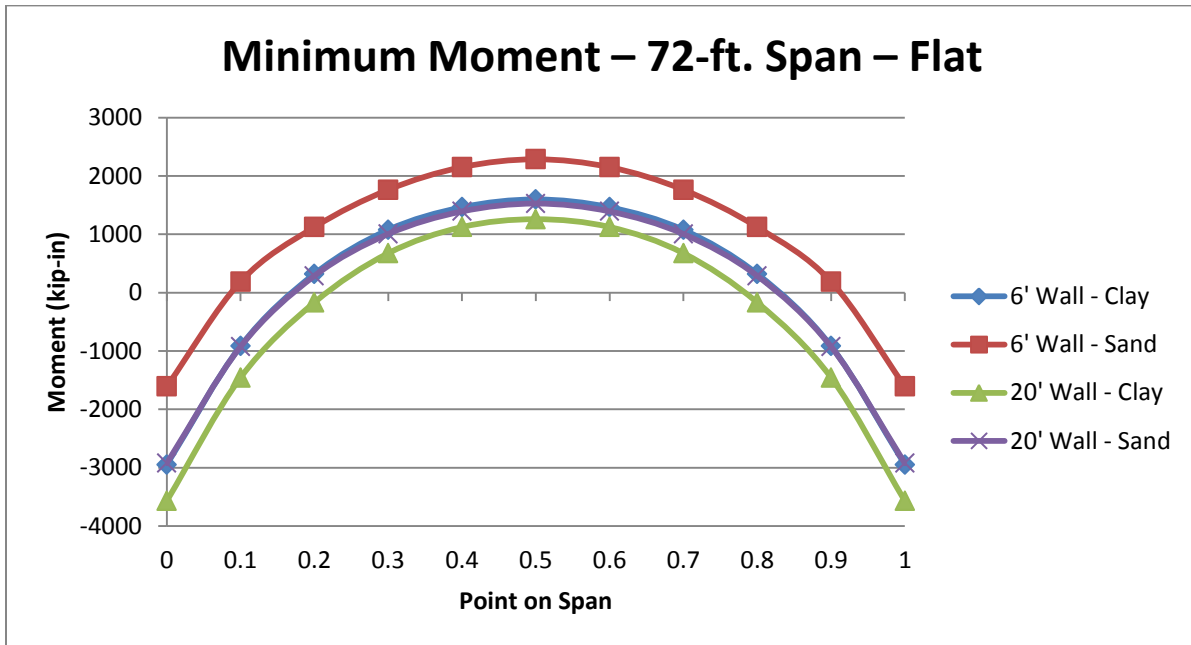

**Figure 3.21: Substructural Influence on Minimum Moment for 72-ft. Flat Slab**

### *Conclusions for Substructural Effects*

A valuable conclusion for preliminary design was found by evaluating trends in load distribution based on differences in substructural parameters. Qualitative assessment of the graphs showed differences in the amount of positive and negative moment attracted by various parts of the superstructure, relative to changes in substructural stiffness. A summary and explanation of these observations is presented here.

When considering maximum positive moment demand, results at midspan of the section are most important. All four graphs of maximum moment show a similar trend. Using a 6-ft. abutment wall with sandy soil led to the greatest positive moment demand at midspan. The 20-ft. abutment wall with clay soil generates the least positive moment at midspan. Values for the 6-ft.

wall with clay soil and 20-ft. wall with sandy soil were relatively similar and fell between the two extremes.

Opposite observations were made when evaluating negative moment demand. The end of span is the important location for maximum negative moment. The 20-ft. wall with clay soil attracted the most negative moment to the end of span. The 6-ft. wall with sandy soil resulted in the least negative moment at the end of span. Values for the 6-ft. wall with clay soil and 20-ft. wall with sandy soil were still relatively similar and lie between the two extremes.

It is important to explain why these phenomena were observed. A suggestion was developed pertaining to the proportional height of abutment wall and pile. As a reminder, clay soil was modeled by using a pile length of seven feet before achieving fixity. Sandy soil was modeled with a pile length of 15 ft. before reaching fixity.

The 6-ft. wall coupled with sandy soil can be described as a short, stiff abutment sitting on a tall, flexible foundation. When proportioning lengths and stiffness of the two elements, this substructure is relatively flexible overall. Conversely, the 20-ft. wall with clay soil can be described as a tall, stiff abutment sitting on a short flexible foundation. Overall, its relative stiffness is high. Similarities existed between the remaining two models. Both the 6-ft. wall on clay soil and a 20-ft. wall on sandy soil have relatively equal length of abutment and pile. Accordingly, they were neither extremely stiff nor flexible relative to the other cases.

The most flexible substructure is assumed to undergo the most bending under load. Naturally, the stiffest substructure is predicted to bend the least. Stiffness of the substructure effectively creates an end condition for the slab. A flexible substructure will be less resistant to bending of the slab. If substructural stiffness is very low, the slab will bend similar to a simply supported beam. The abutment will not draw appreciable moment from the slab and a higher

positive moment will be observed at midspan. Naturally, negative moment at the end of span will be reduced.

However, if the substructure is very stiff, it will be capable of effectively resisting the rotation and bending of the slab. In this case, the slab functions more similarly to a fixed-fixed beam. Midspan will attract less positive moment and the end of span will carry more negative moment. For the case of moderate stiffness, maximum moment will be more balanced at both locations.

In this case, total depth of the substructure did not appear to be relevant to load distribution in the slab. The 6-ft. abutment with clay soil and 20-ft. abutment with sandy soil were the shallowest and deepest substructures, respectively. Yet, performance of the superstructure was very similar for these two cases. The 6-ft. abutment with sandy soil and 20-ft. abutment in clay soil were fairly close in overall depth, yet their effect was noticeably different.

Evaluating overall relative stiffness of the substructure provided a fitting explanation for the variation in modeling results. In practice, type of soil present at the construction site cannot be practically changed. However, depth of the abutment wall can. If deemed necessary or desirable to draw additional moment from the midspan, depth of the abutment and its associated stiffness can be increased regardless of height of waterway opening required. Deeper construction of the abutment is more costly, but may prove useful when weaker, sandy soil is present. This was especially relevant since the upper end of the span range exceeded the normal length for single spans.

### ***Comparison of Haunched and Flat Profiles***

Modeling results for the 32-ft. and 72-ft. spans demonstrated the effect the superstructural profile has on distribution of moment throughout the slab. To compare the performance of the

competing systems, a moment envelope was developed for both spans. These graphs show the difference in positive and negative moment across the span for the haunched and flat slabs. From this information, assessment of the competing profiles could be made. Table 3.8 shows the effect of slab profile on moment demand for both 32-ft. sections.

**Table 3.8: Profile Influence on Moment for 32-ft. Span**

| Point on Span | Haunched Slab      |                    | Flat Slab          |                    |
|---------------|--------------------|--------------------|--------------------|--------------------|
|               | $M_{max}$ (kip-in) | $M_{min}$ (kip-in) | $M_{max}$ (kip-in) | $M_{min}$ (kip-in) |
| 0             | -142.3             | -997.3             | -140.7             | -887.5             |
| 0.1           | 137.9              | -530.5             | 145.0              | -414.5             |
| 0.2           | 440.2              | -268.6             | 445.8              | -197.8             |
| 0.3           | 662.3              | -108.4             | 671.2              | -57.0              |
| 0.4           | 791.2              | -15.6              | 802.6              | 32.4               |
| 0.5           | 836.7              | 13.3               | 849.1              | 57.2               |
| 0.6           | 791.2              | -15.6              | 802.6              | 32.4               |
| 0.7           | 662.3              | -108.4             | 671.2              | -57.0              |
| 0.8           | 440.2              | -268.6             | 445.8              | -197.8             |
| 0.9           | 137.9              | -530.5             | 145.0              | -414.5             |
| 1             | -142.3             | -997.3             | -140.7             | -887.5             |

Figure 3.22 shows a plot of moment enveloped of the 32-ft. haunched and flat slabs.

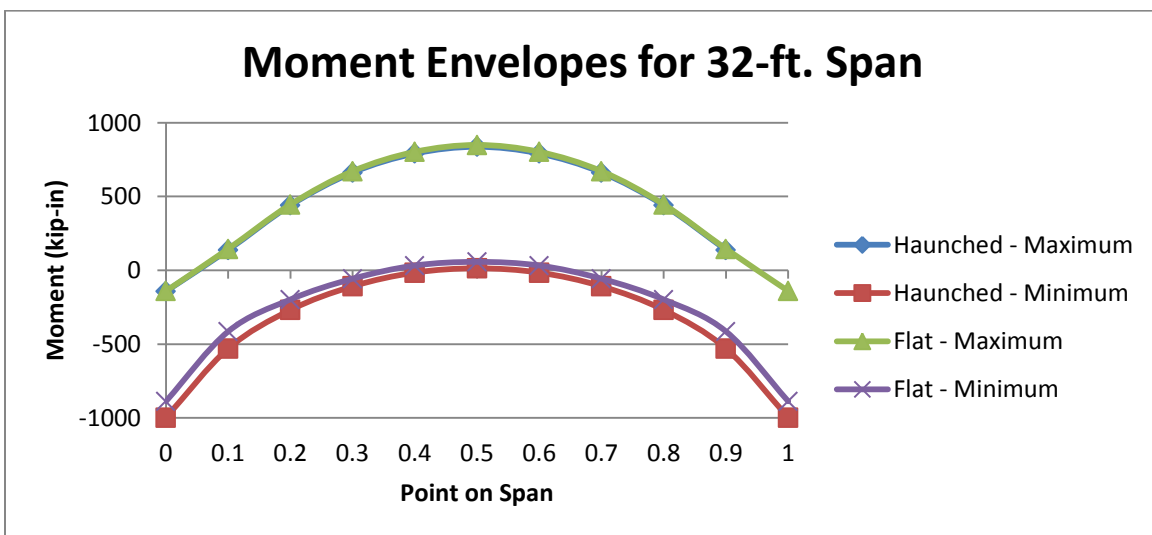

**Figure 3.22: Moment Envelopes for 32-ft. Span**

Table 3.9 shows the effect of slab profile on moment demand for both 72-ft. sections.

**Table 3.9: Profile Influence on Moment for 72-ft. Span**

| Point on Span | Haunched Slab      |                    | Flat Slab          |                    |
|---------------|--------------------|--------------------|--------------------|--------------------|
|               | $M_{max}$ (kip-in) | $M_{min}$ (kip-in) | $M_{max}$ (kip-in) | $M_{min}$ (kip-in) |
| 0             | -1009.7            | -4145.0            | -831.4             | -3570.0            |
| 0.1           | 579.0              | -1996.5            | 893.3              | -1455.2            |
| 0.2           | 2006.2             | -760.5             | 2563.1             | -168.8             |
| 0.3           | 3041.3             | 120.9              | 3737.0             | 675.1              |
| 0.4           | 3653.9             | 597.9              | 4456.7             | 1124.1             |
| 0.5           | 3844.6             | 717.6              | 4672.6             | 1258.8             |
| 0.6           | 3653.9             | 597.9              | 4456.7             | 1124.1             |
| 0.7           | 3041.3             | 120.9              | 3737.0             | 675.1              |
| 0.8           | 2006.2             | -760.5             | 2563.1             | -168.8             |
| 0.9           | 579.0              | -1996.5            | 893.3              | -1455.2            |
| 1             | -1009.7            | -4145.0            | -831.4             | -3570.0            |

Figure 3.23 shows a plot of moment envelope of the 72-ft. haunched and flat slabs.

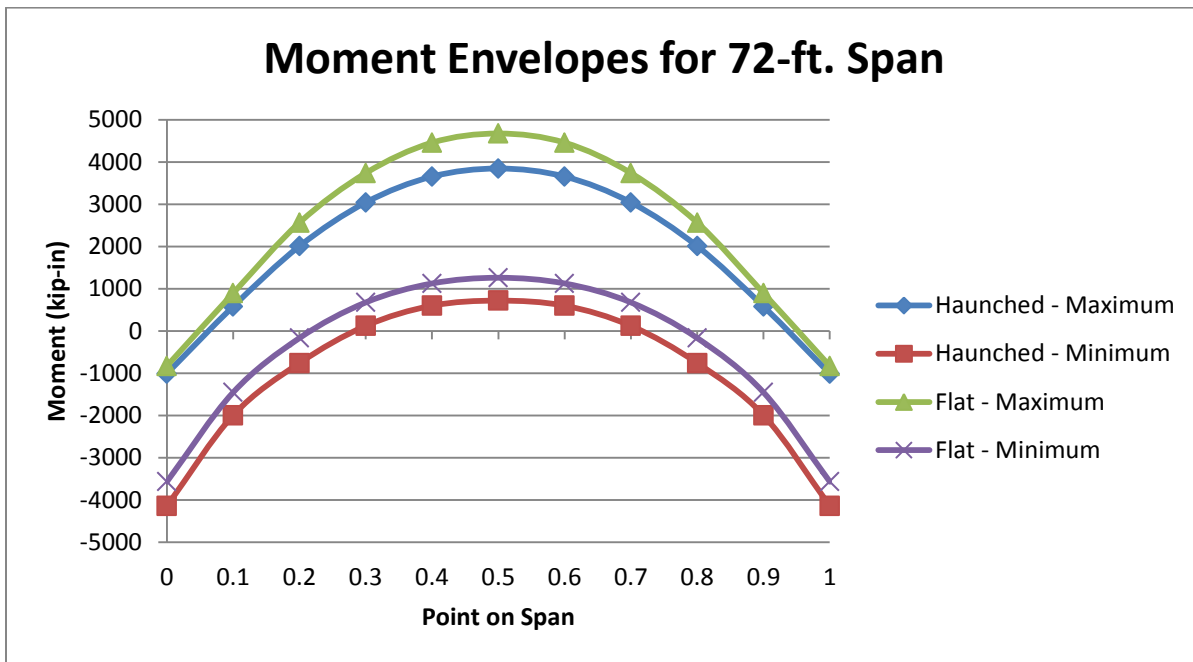

**Figure 3.23: Moment Envelopes for 72-ft. Span**

Moment envelopes for both spans showed trends in performance for the competing profiles. As predicted, the haunch succeeded at drawing moment away from the middle of the section to the end of the span. Added stiffness caused the haunched profile to attract a higher negative design moment at the end of the span than its flat counterpart. Conversely, the flat profile attracted a higher positive design moment at midspan than the haunched slab. These trends were more pronounced for the 72-ft. span, since the increased length resulted in much greater moment.

This presented a tradeoff for use of either profile configuration. Geometry of both sections succeeded at reducing moment in one part of the span, but increasing it in another. For this reason, it was not readily obvious which section would be more advantageous in design. As expected from the stiffness method, the higher negative moment in the haunched slab occurred in a region of greater section depth. The lower positive moment occurred in a region of reduced depth. Similar observations were made for the flat slab. Because of these variations, a preliminary design of both options will be necessary to demonstrate if one profile is preferable to the other.

### ***Analysis Results of All Spans and Profiles***

After assembling all applicable load combinations, final results could be prepared. For all four models of the same span profile, the largest magnitude of positive and negative moment was identified at each tenth-point, for the load combination considered. By selecting the largest values, a moment envelope could be created for each profile. The envelope covered the entire range of substructural parameters modeled in the project.

In this subchapter, final results for all spans are presented. Results are shown for Strength I, Service I, and Fatigue limit states for each span length and profile. Graphs for the moment

envelope represent the Strength I limit state. Graphs for the other limit states are not presented to avoid unnecessary repetition.

It should be noted, the haunched profile was predicted to be the one used for design. For this reason, all span lengths were modeled with haunched profiles. The longest and shortest spans were modeled with flat profiles as well. If comparison of designs for the 32-ft. and 72-ft. spans shows the flat profile to be more suitable, analysis and design of the flat slab would be performed for all lengths. If the haunched profile is shown to be preferable for the 32-ft. and 72-ft. spans, then no more analysis of the flat slab will be performed.



### 32-ft. Haunched Slab

Analysis results for the 32-ft., haunched-slab profile are presented here. Table 3.10 shows design moment values for the 32-ft. span with haunched slab.

**Table 3.10: Moment Envelope for 32-ft. Span with Haunched Profile**

| Point on Span | Strength I                |                           | Service I                 |                           | Fatigue                   |                           |                             |                           |
|---------------|---------------------------|---------------------------|---------------------------|---------------------------|---------------------------|---------------------------|-----------------------------|---------------------------|
|               | M <sub>max</sub> (kip-in) | M <sub>min</sub> (kip-in) | M <sub>max</sub> (kip-in) | M <sub>min</sub> (kip-in) | M <sub>max</sub> (kip-in) | M <sub>min</sub> (kip-in) | M <sub>Range</sub> (kip-in) | M <sub>min</sub> (kip-in) |
| 0             | -142.3                    | -997.3                    | -119.9                    | -640.7                    | -131.5                    | -493.7                    | 123.5                       | -122.4                    |
| 0.1           | 137.9                     | -530.5                    | 71.0                      | -353.5                    | 73.6                      | -302.1                    | 117.1                       | -76.5                     |
| 0.2           | 440.2                     | -268.6                    | 266.6                     | -192.4                    | 218.7                     | -174.2                    | 113.5                       | -47.4                     |
| 0.3           | 662.3                     | -108.4                    | 408.9                     | -89.3                     | 329.7                     | -87.3                     | 127.8                       | -25.3                     |
| 0.4           | 791.2                     | -15.6                     | 491.6                     | -27.5                     | 394.6                     | -28.0                     | 130.3                       | -9.6                      |
| 0.5           | 836.7                     | 13.3                      | 520.5                     | -8.1                      | 413.1                     | -3.0                      | 132.0                       | 0.0                       |
| 0.6           | 791.2                     | -15.6                     | 491.6                     | -27.5                     | 394.6                     | -28.0                     | 130.3                       | -9.6                      |
| 0.7           | 662.3                     | -108.4                    | 408.9                     | -89.3                     | 329.7                     | -87.3                     | 127.8                       | -25.3                     |
| 0.8           | 440.2                     | -268.6                    | 266.6                     | -192.4                    | 218.7                     | -174.2                    | 113.5                       | -47.4                     |
| 0.9           | 137.9                     | -530.5                    | 71.0                      | -353.5                    | 73.6                      | -302.1                    | 117.1                       | -76.5                     |
| 1             | -142.3                    | -997.3                    | -119.9                    | -640.7                    | -131.5                    | -493.7                    | 123.5                       | -122.4                    |

Figure 3.24 shows the moment envelope for the 32-ft. span with haunched profile.

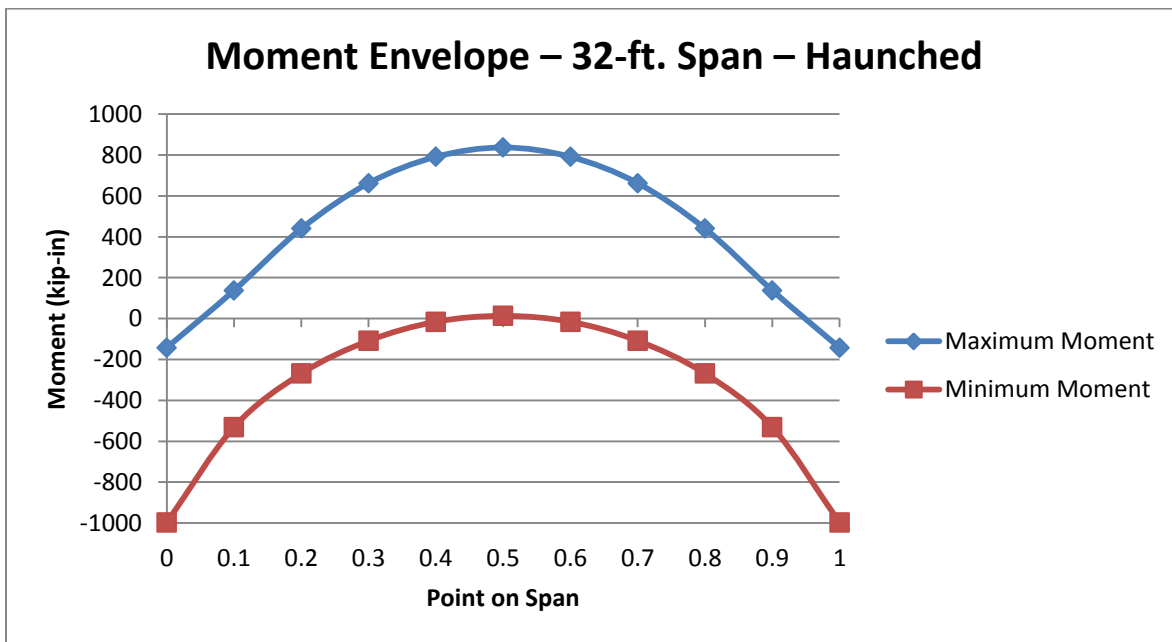

**Figure 3.24: Moment Envelope for 32-ft. Span with Haunched Profile**

### 32-ft. Flat Slab

Analysis results for the 32-ft., flat-slab profile are presented here. Table 3.11 shows design moment values for the 32-ft. span with flat slab.

**Table 3.11: Moment Envelope for 32-ft. Span with Flat Profile**

| Point on Span | Strength I                |                           | Service I                 |                           | Fatigue                   |                           |                             |                           |
|---------------|---------------------------|---------------------------|---------------------------|---------------------------|---------------------------|---------------------------|-----------------------------|---------------------------|
|               | M <sub>max</sub> (kip-in) | M <sub>min</sub> (kip-in) | M <sub>max</sub> (kip-in) | M <sub>min</sub> (kip-in) | M <sub>max</sub> (kip-in) | M <sub>min</sub> (kip-in) | M <sub>Range</sub> (kip-in) | M <sub>min</sub> (kip-in) |
| 0             | -140.7                    | -887.5                    | -118.8                    | -585.0                    | -128.4                    | -455.1                    | 106.1                       | -104.2                    |
| 0.1           | 145.0                     | -414.5                    | 75.5                      | -294.9                    | 75.4                      | -266.9                    | 102.2                       | -59.3                     |
| 0.2           | 445.8                     | -197.8                    | 270.3                     | -151.1                    | 223.9                     | -144.0                    | 115.2                       | -36.4                     |
| 0.3           | 671.2                     | -57.0                     | 414.8                     | -53.1                     | 336.0                     | -54.3                     | 129.6                       | -20.1                     |
| 0.4           | 802.6                     | 32.4                      | 499.0                     | 8.5                       | 401.0                     | 10.9                      | 131.9                       | -6.3                      |
| 0.5           | 849.1                     | 57.2                      | 528.5                     | 26.2                      | 419.1                     | 31.9                      | 133.5                       | 0.0                       |
| 0.6           | 802.6                     | 32.4                      | 499.0                     | 8.5                       | 401.0                     | 10.9                      | 131.9                       | -6.3                      |
| 0.7           | 671.2                     | -57.0                     | 414.8                     | -53.1                     | 336.0                     | -54.3                     | 129.6                       | -20.1                     |
| 0.8           | 445.8                     | -197.8                    | 270.3                     | -151.1                    | 223.9                     | -144.0                    | 115.2                       | -36.4                     |
| 0.9           | 145.0                     | -414.5                    | 75.5                      | -294.9                    | 75.4                      | -266.9                    | 102.2                       | -59.3                     |
| 1             | -140.7                    | -887.5                    | -118.8                    | -585.0                    | -128.4                    | -455.1                    | 106.1                       | -104.2                    |

Figure 3.25 shows the moment envelope for the 32-ft. span with flat profile.

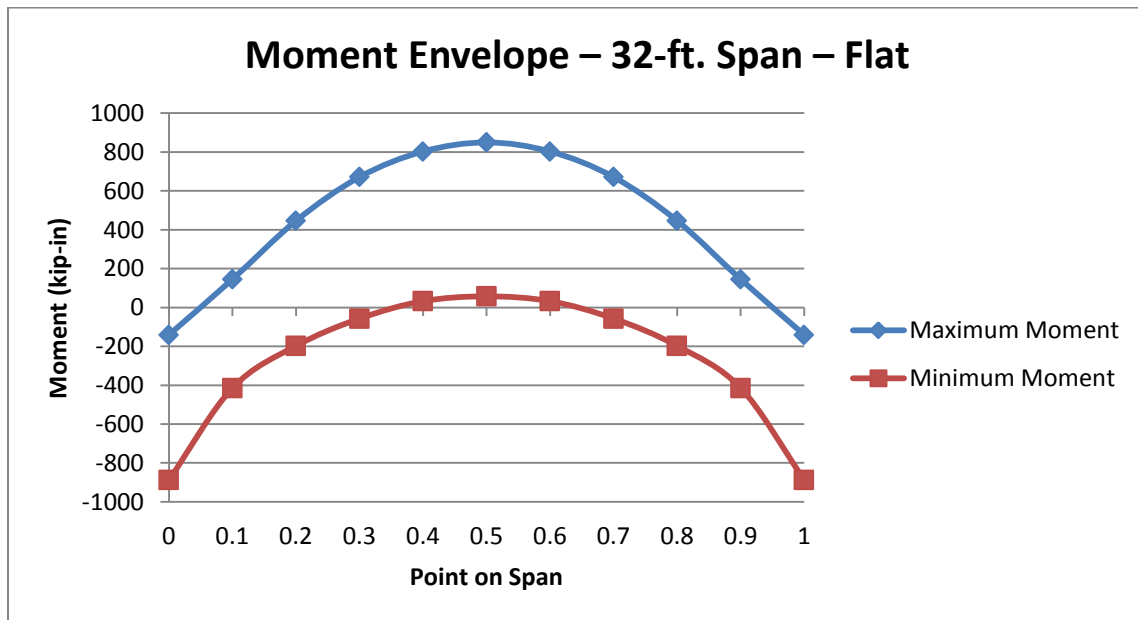

**Figure 3.25: Moment Envelope for 32-ft. Span with Flat Profile**

### 40-ft. Haunched Slab

Analysis results for the 40-ft., haunched-slab profile are presented here. Table 3.12 shows design moment values for the 40-ft. span with haunched slab.

**Table 3.12: Moment Envelope for 40-ft. Span with Haunched Profile**

| Point on Span | Strength I                |                           | Service I                 |                           | Fatigue                   |                           |                             |                           |
|---------------|---------------------------|---------------------------|---------------------------|---------------------------|---------------------------|---------------------------|-----------------------------|---------------------------|
|               | M <sub>max</sub> (kip-in) | M <sub>min</sub> (kip-in) | M <sub>max</sub> (kip-in) | M <sub>min</sub> (kip-in) | M <sub>max</sub> (kip-in) | M <sub>min</sub> (kip-in) | M <sub>Range</sub> (kip-in) | M <sub>min</sub> (kip-in) |
| 0             | -250.0                    | -1407.2                   | -206.0                    | -908.9                    | -217.8                    | -645.5                    | 143.6                       | -142.6                    |
| 0.1           | 169.1                     | -685.4                    | 84.2                      | -446.7                    | 71.2                      | -382.9                    | 136.4                       | -95.7                     |
| 0.2           | 596.3                     | -321.4                    | 366.2                     | -201.8                    | 288.1                     | -188.5                    | 129.7                       | -59.1                     |
| 0.3           | 907.4                     | -59.4                     | 569.7                     | -39.6                     | 443.3                     | -38.2                     | 132.2                       | -29.1                     |
| 0.4           | 1088.3                    | 74.6                      | 688.2                     | 43.8                      | 529.2                     | 53.3                      | 148.4                       | -4.3                      |
| 0.5           | 1146.0                    | 105.3                     | 726.1                     | 66.3                      | 551.8                     | 71.0                      | 150.9                       | 0.0                       |
| 0.6           | 1088.3                    | 74.6                      | 688.2                     | 43.8                      | 529.2                     | 53.3                      | 148.4                       | -4.3                      |
| 0.7           | 907.4                     | -59.4                     | 569.7                     | -39.6                     | 443.3                     | -38.2                     | 132.2                       | -29.1                     |
| 0.8           | 596.3                     | -321.4                    | 366.2                     | -201.8                    | 288.1                     | -188.5                    | 129.7                       | -59.1                     |
| 0.9           | 169.1                     | -685.4                    | 84.2                      | -446.7                    | 71.2                      | -382.9                    | 136.4                       | -95.7                     |
| 1             | -250.0                    | -1407.2                   | -206.0                    | -908.9                    | -217.8                    | -645.5                    | 143.6                       | -142.6                    |

Figure 3.26 shows the moment envelope for the 40-ft. span with haunched profile.

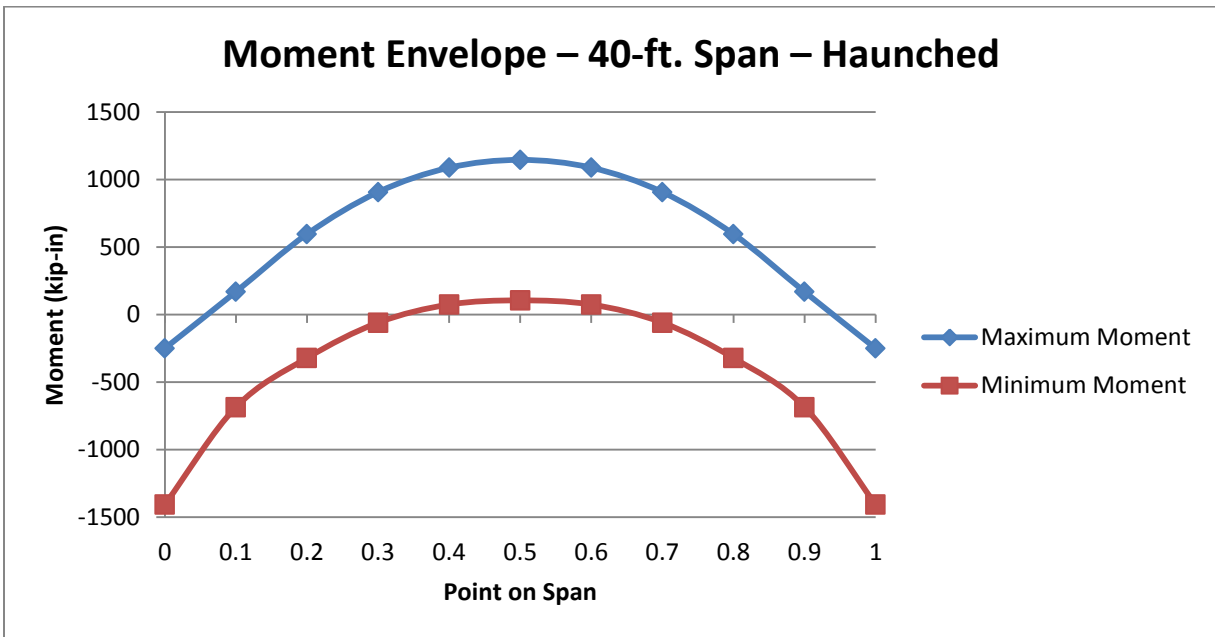

**Figure 3.26: Moment Envelope for 40-ft. Span with Haunched Profile**

### 48-ft. Haunched Slab

Analysis results for the 48-ft., haunched-slab profile are presented here. Table 3.13 shows design moment values for the 48-ft. span with haunched slab.

**Table 3.13: Moment Envelope for 48-ft. Span with Haunched Profile**

| Point on Span | Strength I                |                           | Service I                 |                           | Fatigue                   |                           |                             |                           |
|---------------|---------------------------|---------------------------|---------------------------|---------------------------|---------------------------|---------------------------|-----------------------------|---------------------------|
|               | M <sub>max</sub> (kip-in) | M <sub>min</sub> (kip-in) | M <sub>max</sub> (kip-in) | M <sub>min</sub> (kip-in) | M <sub>max</sub> (kip-in) | M <sub>min</sub> (kip-in) | M <sub>Range</sub> (kip-in) | M <sub>min</sub> (kip-in) |
| 0             | -393.9                    | -1895.5                   | -320.9                    | -1241.1                   | -332.4                    | -881.3                    | 169.2                       | -168.4                    |
| 0.1           | 192.0                     | -929.0                    | 92.2                      | -611.5                    | 61.5                      | -505.9                    | 158.9                       | -116.6                    |
| 0.2           | 766.9                     | -390.0                    | 479.2                     | -246.3                    | 359.7                     | -210.5                    | 140.4                       | -69.5                     |
| 0.3           | 1187.1                    | -41.2                     | 759.1                     | -7.3                      | 569.9                     | 20.7                      | 143.5                       | -23.7                     |
| 0.4           | 1431.6                    | 168.7                     | 921.9                     | 126.2                     | 691.1                     | 135.6                     | 163.5                       | -4.6                      |
| 0.5           | 1515.7                    | 220.4                     | 977.5                     | 157.9                     | 725.8                     | 162.5                     | 167.6                       | 0.0                       |
| 0.6           | 1431.6                    | 168.7                     | 921.9                     | 126.2                     | 691.1                     | 135.6                     | 163.5                       | -4.6                      |
| 0.7           | 1187.1                    | -41.2                     | 759.1                     | -7.3                      | 569.9                     | 20.7                      | 143.5                       | -23.7                     |
| 0.8           | 766.9                     | -390.0                    | 479.2                     | -246.3                    | 359.7                     | -210.5                    | 140.4                       | -69.5                     |
| 0.9           | 192.0                     | -929.0                    | 92.2                      | -611.5                    | 61.5                      | -505.9                    | 158.9                       | -116.6                    |
| 1             | -393.9                    | -1895.5                   | -320.9                    | -1241.1                   | -332.4                    | -881.3                    | 169.2                       | -168.4                    |

Figure 3.27 shows the moment envelope for the 48-ft. span with haunched profile.

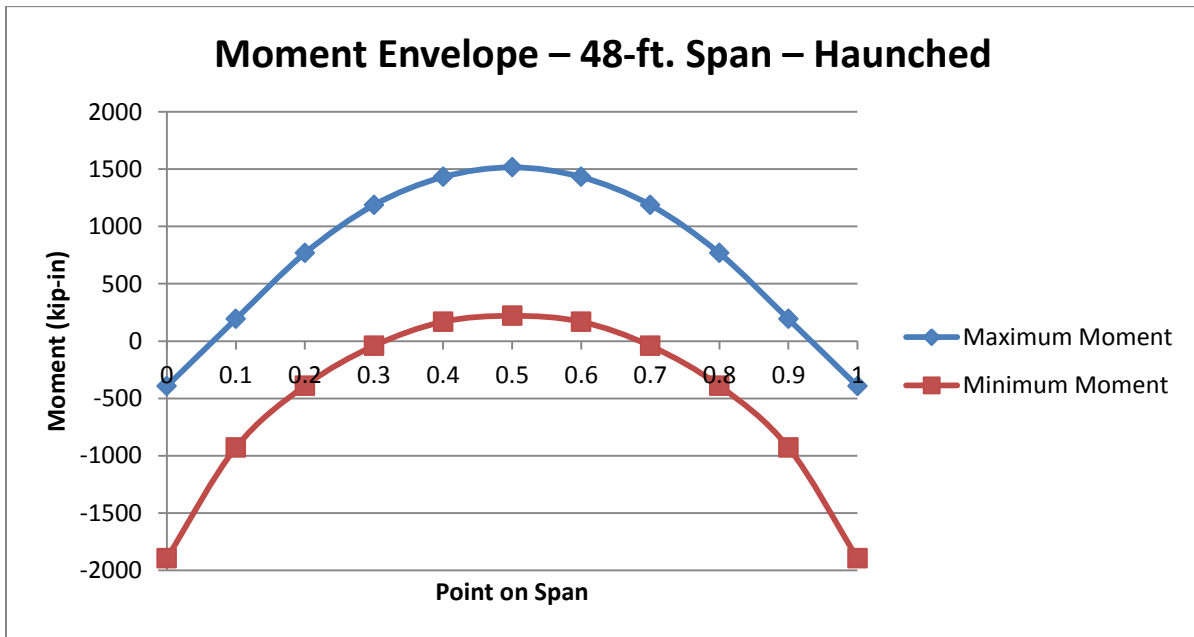

**Figure 3.27: Moment Envelope for 48-ft. Span with Haunched Profile**

### 56-ft. Haunched Slab

Analysis results for the 56-ft., haunched-slab profile are presented here. Table 3.14 shows design moment values for the 56-ft. span with haunched slab.

**Table 3.14: Moment Envelope for 56-ft. Span with Haunched Profile**

| Point on Span | Strength I                |                           | Service I                 |                           | Fatigue                   |                           |                             |                           |
|---------------|---------------------------|---------------------------|---------------------------|---------------------------|---------------------------|---------------------------|-----------------------------|---------------------------|
|               | M <sub>max</sub> (kip-in) | M <sub>min</sub> (kip-in) | M <sub>max</sub> (kip-in) | M <sub>min</sub> (kip-in) | M <sub>max</sub> (kip-in) | M <sub>min</sub> (kip-in) | M <sub>Range</sub> (kip-in) | M <sub>min</sub> (kip-in) |
| 0             | -573.8                    | -2464.1                   | -464.5                    | -1635.2                   | -475.6                    | -1194.8                   | 238.1                       | -236.9                    |
| 0.1           | 222.4                     | -1208.4                   | 104.7                     | -804.6                    | 52.7                      | -650.8                    | 211.6                       | -142.4                    |
| 0.2           | 982.0                     | -489.3                    | 623.9                     | -310.2                    | 464.4                     | -231.6                    | 183.4                       | -67.8                     |
| 0.3           | 1518.9                    | -12.7                     | 988.3                     | 7.9                       | 742.2                     | 16.3                      | 175.6                       | -25.6                     |
| 0.4           | 1881.4                    | 174.5                     | 1229.0                    | 122.3                     | 912.0                     | 131.6                     | 186.3                       | -5.0                      |
| 0.5           | 1997.4                    | 216.3                     | 1306.3                    | 153.8                     | 944.4                     | 158.4                     | 187.3                       | 0.0                       |
| 0.6           | 1881.4                    | 174.5                     | 1229.0                    | 122.3                     | 912.0                     | 131.6                     | 186.3                       | -5.0                      |
| 0.7           | 1518.9                    | -12.7                     | 988.3                     | 7.9                       | 742.2                     | 16.3                      | 175.6                       | -25.6                     |
| 0.8           | 982.0                     | -489.3                    | 623.9                     | -310.2                    | 464.4                     | -231.6                    | 183.4                       | -67.8                     |
| 0.9           | 222.4                     | -1208.4                   | 104.7                     | -804.6                    | 52.7                      | -650.8                    | 211.6                       | -142.4                    |
| 1             | -573.8                    | -2464.1                   | -464.5                    | -1635.2                   | -475.6                    | -1194.8                   | 238.1                       | -236.9                    |

Figure 3.28 shows the moment envelope for the 56-ft. span with haunched profile.

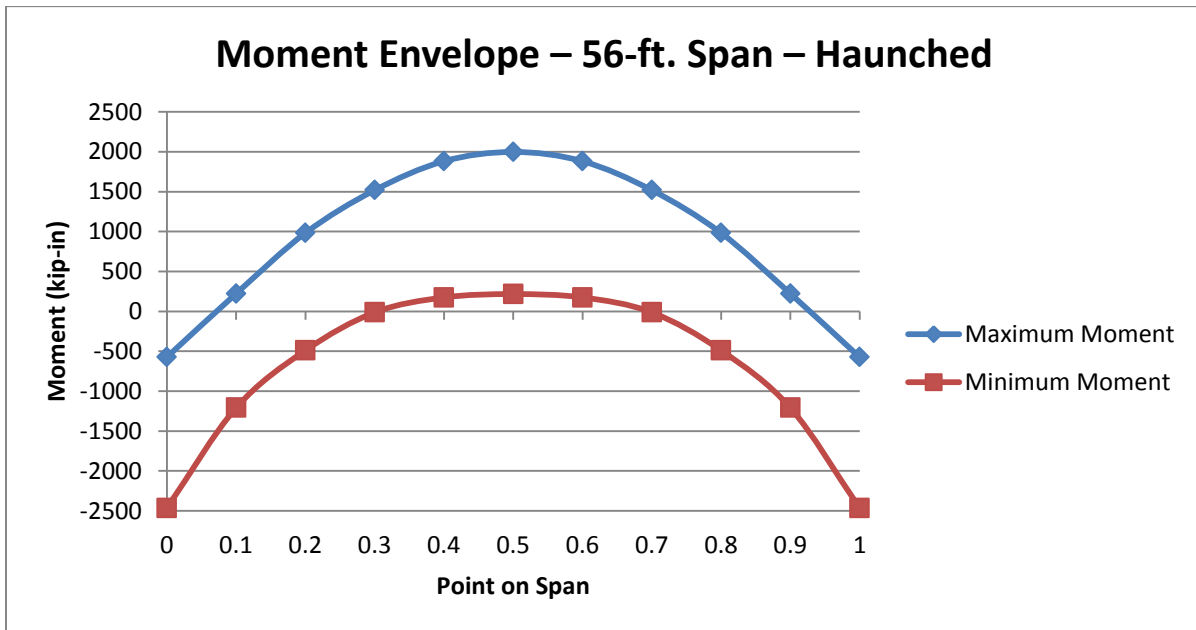

**Figure 3.28: Moment Envelope for 56-ft. Span with Haunched Profile**

### 64-ft. Haunched Slab

Analysis results for the 64-ft., haunched-slab profile are presented here. Table 3.15 shows design moment values for the 64-ft. span with haunched slab.

**Table 3.15: Moment Envelope for 64-ft. Span with Haunched Profile**

| Point on Span | Strength I                |                           | Service I                 |                           | Fatigue                   |                           |                             |                           |
|---------------|---------------------------|---------------------------|---------------------------|---------------------------|---------------------------|---------------------------|-----------------------------|---------------------------|
|               | M <sub>max</sub> (kip-in) | M <sub>min</sub> (kip-in) | M <sub>max</sub> (kip-in) | M <sub>min</sub> (kip-in) | M <sub>max</sub> (kip-in) | M <sub>min</sub> (kip-in) | M <sub>Range</sub> (kip-in) | M <sub>min</sub> (kip-in) |
| 0             | -783.9                    | -3237.1                   | -631.9                    | -2188.8                   | -641.4                    | -1684.5                   | 254.9                       | -254.2                    |
| 0.1           | 359.3                     | -1581.2                   | 194.2                     | -1071.7                   | 111.7                     | -855.2                    | 190.4                       | -139.8                    |
| 0.2           | 1399.3                    | -631.4                    | 916.0                     | -404.2                    | 700.8                     | -282.7                    | 161.3                       | -72.6                     |
| 0.3           | 2187.9                    | 36.0                      | 1451.9                    | 63.1                      | 1112.8                    | 104.0                     | 203.2                       | -30.0                     |
| 0.4           | 2651.7                    | 398.2                     | 1766.2                    | 318.8                     | 1349.6                    | 325.1                     | 235.3                       | -5.0                      |
| 0.5           | 2805.0                    | 493.0                     | 1869.8                    | 388.9                     | 1404.2                    | 390.8                     | 234.7                       | 0.0                       |
| 0.6           | 2651.7                    | 398.2                     | 1766.2                    | 318.8                     | 1349.6                    | 325.1                     | 235.3                       | -5.0                      |
| 0.7           | 2187.9                    | 36.0                      | 1451.9                    | 63.1                      | 1112.8                    | 104.0                     | 203.2                       | -30.0                     |
| 0.8           | 1399.3                    | -631.4                    | 916.0                     | -404.2                    | 700.8                     | -282.7                    | 161.3                       | -72.6                     |
| 0.9           | 359.3                     | -1581.2                   | 194.2                     | -1071.7                   | 111.7                     | -855.2                    | 190.4                       | -139.8                    |
| 1             | -783.9                    | -3237.1                   | -631.9                    | -2188.8                   | -641.4                    | -1684.5                   | 254.9                       | -254.2                    |

Figure 3.29 shows the moment envelope for the 64-ft. span with haunched profile.

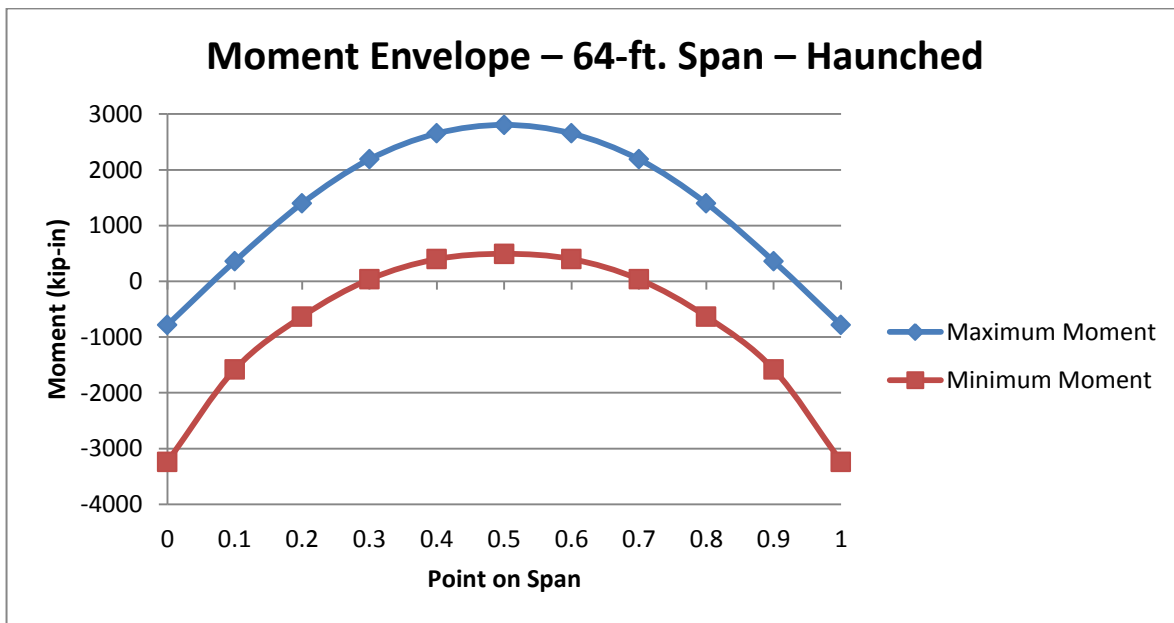

**Figure 3.29: Moment Envelope for 64-ft. Span with Haunched Profile**

### 72-ft. Haunched Slab

Summary of analysis results for the 72-ft., haunched slab is compiled here. Table 3.16 shows the moment envelope for the 72-ft. span with haunched slab.

**Table 3.16: Moment Envelope for 72-ft. Span with Haunched Profile**

| Point on Span | Strength I                |                           | Service I                 |                           | Fatigue                   |                           |                             |                           |
|---------------|---------------------------|---------------------------|---------------------------|---------------------------|---------------------------|---------------------------|-----------------------------|---------------------------|
|               | M <sub>max</sub> (kip-in) | M <sub>min</sub> (kip-in) | M <sub>max</sub> (kip-in) | M <sub>min</sub> (kip-in) | M <sub>max</sub> (kip-in) | M <sub>min</sub> (kip-in) | M <sub>Range</sub> (kip-in) | M <sub>min</sub> (kip-in) |
| 0             | -1009.7                   | -4145.0                   | -812.0                    | -2847.5                   | -820.3                    | -2280.7                   | 309.5                       | -308.9                    |
| 0.1           | 579.0                     | -1996.5                   | 347.9                     | -1373.8                   | 249.7                     | -1154.6                   | 238.1                       | -177.5                    |
| 0.2           | 2006.2                    | -760.5                    | 1342.6                    | -489.7                    | 1034.2                    | -338.3                    | 181.9                       | -81.4                     |
| 0.3           | 3041.3                    | 120.9                     | 2054.5                    | 135.8                     | 1624.5                    | 184.2                     | 257.9                       | -34.2                     |
| 0.4           | 3653.9                    | 597.9                     | 2473.8                    | 476.6                     | 1952.2                    | 482.8                     | 300.6                       | -4.7                      |
| 0.5           | 3844.6                    | 717.6                     | 2605.1                    | 567.2                     | 2028.3                    | 569.5                     | 299.6                       | -0.1                      |
| 0.6           | 3653.9                    | 597.9                     | 2473.8                    | 476.6                     | 1952.2                    | 482.8                     | 300.6                       | -4.7                      |
| 0.7           | 3041.3                    | 120.9                     | 2054.5                    | 135.8                     | 1624.5                    | 184.2                     | 257.9                       | -34.2                     |
| 0.8           | 2006.2                    | -760.5                    | 1342.6                    | -489.7                    | 1034.2                    | -338.3                    | 181.9                       | -81.4                     |
| 0.9           | 579.0                     | -1996.5                   | 347.9                     | -1373.8                   | 249.7                     | -1154.6                   | 238.1                       | -177.5                    |
| 1             | -1009.7                   | -4145.0                   | -812.0                    | -2847.5                   | -820.3                    | -2280.7                   | 309.5                       | -308.9                    |

Figure 3.30 shows the moment envelope for the 72-ft. span with haunched profile.

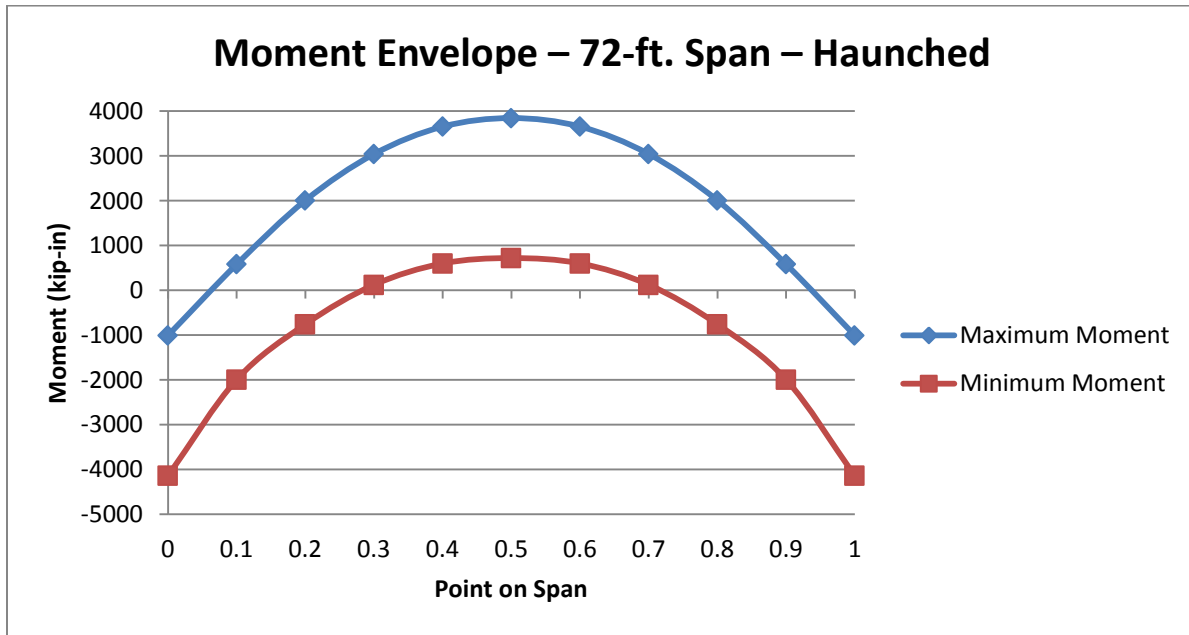

**Figure 3.30: Moment Envelope for 72-ft. Span with Haunched Profile**

### 72-ft. Flat Slab

Summary of analysis results for the 72-ft. flat slab is compiled here. Table 3.17 shows the moment envelope for the 72-ft. span with flat slab.

**Table 3.17: Moment Envelope for 72-ft. Span with Flat Profile**

| Point on Span | Strength I                |                           | Service I                 |                           | Fatigue                   |                           |                             |                           |
|---------------|---------------------------|---------------------------|---------------------------|---------------------------|---------------------------|---------------------------|-----------------------------|---------------------------|
|               | M <sub>max</sub> (kip-in) | M <sub>min</sub> (kip-in) | M <sub>max</sub> (kip-in) | M <sub>min</sub> (kip-in) | M <sub>max</sub> (kip-in) | M <sub>min</sub> (kip-in) | M <sub>Range</sub> (kip-in) | M <sub>min</sub> (kip-in) |
| 0             | -831.4                    | -3570.0                   | -669.0                    | -2481.4                   | -675.9                    | -2038.5                   | 257.9                       | -257.2                    |
| 0.1           | 893.3                     | -1455.2                   | 576.5                     | -1013.1                   | 439.9                     | -861.5                    | 188.2                       | -123.6                    |
| 0.2           | 2563.1                    | -168.8                    | 1732.8                    | -75.8                     | 1357.5                    | -3.0                      | 209.2                       | -48.1                     |
| 0.3           | 3737.0                    | 675.1                     | 2548.0                    | 550.8                     | 2042.2                    | 570.4                     | 298.7                       | -14.1                     |
| 0.4           | 4456.7                    | 1124.1                    | 3045.9                    | 894.1                     | 2433.0                    | 899.9                     | 342.5                       | -1.0                      |
| 0.5           | 4672.6                    | 1258.8                    | 3198.2                    | 999.9                     | 2527.2                    | 1002.9                    | 339.1                       | 0.0                       |
| 0.6           | 4456.7                    | 1124.1                    | 3045.9                    | 894.1                     | 2433.0                    | 899.9                     | 342.5                       | -1.0                      |
| 0.7           | 3737.0                    | 675.1                     | 2548.0                    | 550.8                     | 2042.2                    | 570.4                     | 298.7                       | -14.1                     |
| 0.8           | 2563.1                    | -168.8                    | 1732.8                    | -75.8                     | 1357.5                    | -3.0                      | 209.2                       | -48.1                     |
| 0.9           | 893.3                     | -1455.2                   | 576.5                     | -1013.1                   | 439.9                     | -861.5                    | 188.2                       | -123.6                    |
| 1             | -831.4                    | -3570.0                   | -669.0                    | -2481.4                   | -675.9                    | -2038.5                   | 257.9                       | -257.2                    |

Figure 3.31 shows the moment envelope for the 72-ft. span with flat profile.

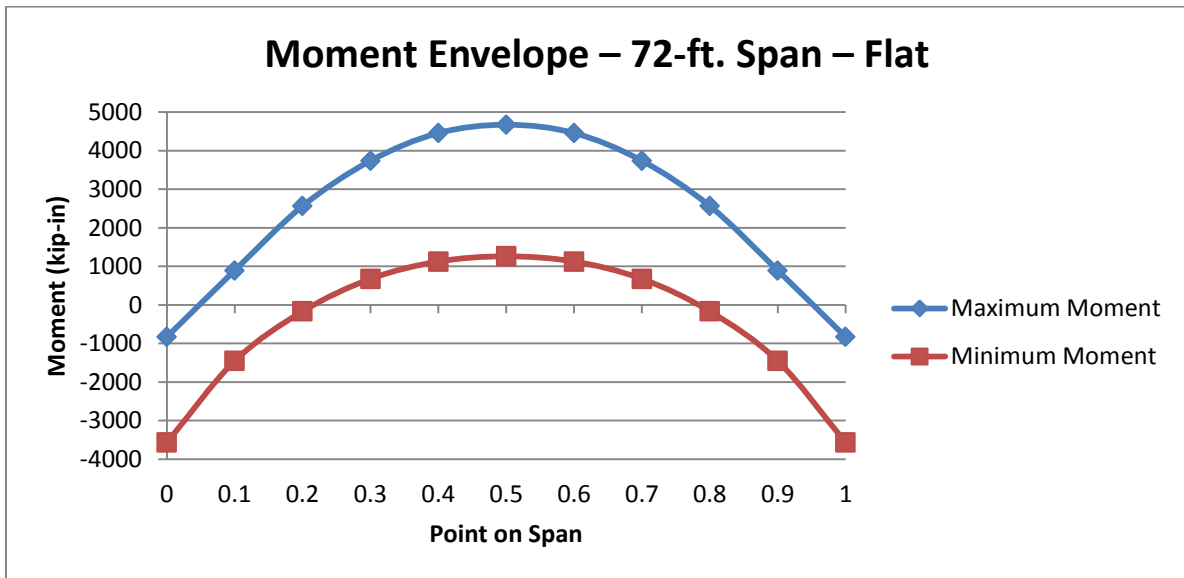

**Figure 3.31: Moment Envelope for 72-ft. Span with Flat Profile**



### *Comparison of All Profiles*

With modeling and structural analysis results for all span lengths and profile types prepared, conclusions could be drawn after comparing the data. The information tabulated and graphed below pertains to Strength I limit state only. The tables and graphs were separated according to maximum and minimum design moments. They represented the top and bottom half of the design moment envelope, respectively. Table 3.18 shows the maximum design moment values for all spans and profiles modeled.

**Table 3.18: Maximum Design Moment for All Spans and Profiles**

| Point on Span | Maximum Design Moment ( $M_u$ ) (kip-in) |            |                |                |                |                |                |            |
|---------------|--|------------|----------------|----------------|----------------|----------------|----------------|------------|
|               | 32' - Haunched                           | 32' - Flat | 40' - Haunched | 48' - Haunched | 56' - Haunched | 64' - Haunched | 72' - Haunched | 72' - Flat |
| 0             | -142.3                                   | -140.7     | -250.0         | -393.9         | -573.8         | -783.9         | -1009.7        | -831.4     |
| 0.1           | 137.9                                    | 145.0      | 169.1          | 192.0          | 222.4          | 359.3          | 579.0          | 893.3      |
| 0.2           | 440.2                                    | 445.8      | 596.3          | 766.9          | 982.0          | 1399.3         | 2006.2         | 2563.1     |
| 0.3           | 662.3                                    | 671.2      | 907.4          | 1187.1         | 1518.9         | 2187.9         | 3041.3         | 3737.0     |
| 0.4           | 791.2                                    | 802.6      | 1088.3         | 1431.6         | 1881.4         | 2651.7         | 3653.9         | 4456.7     |
| 0.5           | 836.7                                    | 849.1      | 1146.0         | 1515.7         | 1997.4         | 2805.0         | 3844.6         | 4672.6     |
| 0.6           | 791.2                                    | 802.6      | 1088.3         | 1431.6         | 1881.4         | 2651.7         | 3653.9         | 4456.7     |
| 0.7           | 662.3                                    | 671.2      | 907.4          | 1187.1         | 1518.9         | 2187.9         | 3041.3         | 3737.0     |
| 0.8           | 440.2                                    | 445.8      | 596.3          | 766.9          | 982.0          | 1399.3         | 2006.2         | 2563.1     |
| 0.9           | 137.9                                    | 145.0      | 169.1          | 192.0          | 222.4          | 359.3          | 579.0          | 893.3      |
| 1             | -142.3                                   | -140.7     | -250.0         | -393.9         | -573.8         | -783.9         | -1009.7        | -831.4     |

Figure 3.32 shows a graph of maximum design moment values for all spans and profiles modeled.

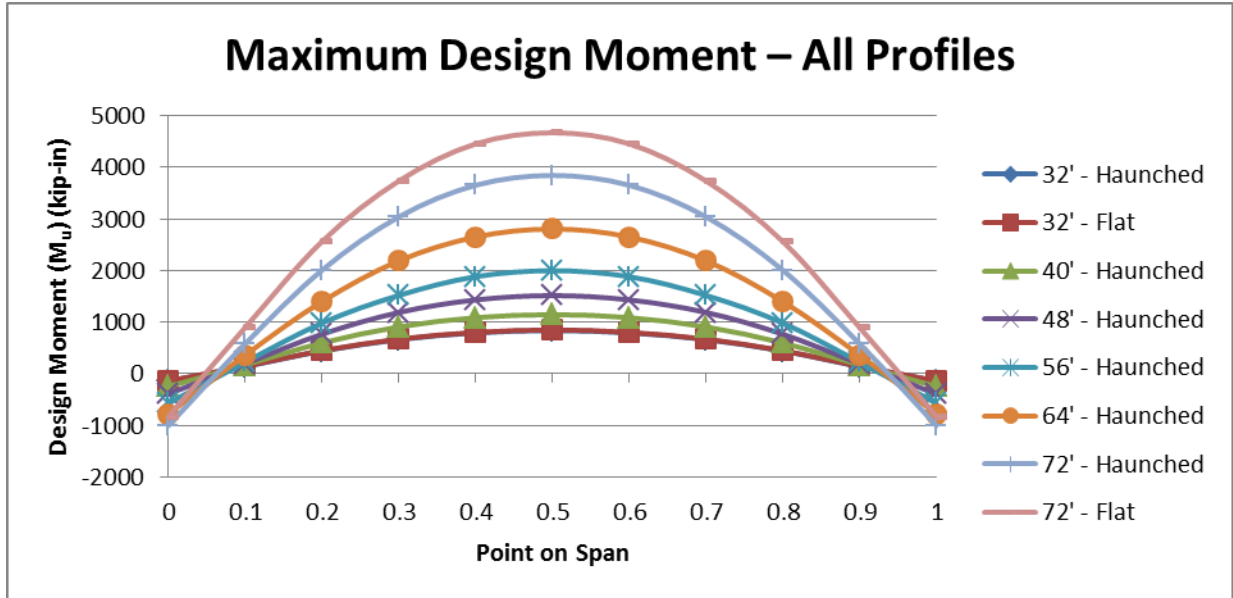

**Figure 3.32: Maximum Design Moment for All Spans and Profiles**

Table 3.19 shows minimum design moment values for all spans and profiles modeled.

**Table 3.19: Minimum Design Moment for All Spans and Profiles**

| Point on Span | Minimum Design Moment ( $M_u$ ) (kip-in) |            |                |                |                |                |                |            |
|---------------|--|------------|----------------|----------------|----------------|----------------|----------------|------------|
|               | 32' - Haunched                           | 32' - Flat | 40' - Haunched | 48' - Haunched | 56' - Haunched | 64' - Haunched | 72' - Haunched | 72' - Flat |
| 0             | -997.3                                   | -887.5     | -1407.2        | -1895.5        | -2464.1        | -3237.1        | -4145.0        | -3570.0    |
| 0.1           | -530.5                                   | -414.5     | -685.4         | -929.0         | -1208.4        | -1581.2        | -1996.5        | -1455.2    |
| 0.2           | -268.6                                   | -197.8     | -321.4         | -390.0         | -489.3         | -631.4         | -760.5         | -168.8     |
| 0.3           | -108.4                                   | -57.0      | -59.4          | -41.2          | -12.7          | 36.0           | 120.9          | 675.1      |
| 0.4           | -15.6                                    | 32.4       | 74.6           | 168.7          | 174.5          | 398.2          | 597.9          | 1124.1     |
| 0.5           | 13.3                                     | 57.2       | 105.3          | 220.4          | 216.3          | 493.0          | 717.6          | 1258.8     |
| 0.6           | -15.6                                    | 32.4       | 74.6           | 168.7          | 174.5          | 398.2          | 597.9          | 1124.1     |
| 0.7           | -108.4                                   | -57.0      | -59.4          | -41.2          | -12.7          | 36.0           | 120.9          | 675.1      |
| 0.8           | -268.6                                   | -197.8     | -321.4         | -390.0         | -489.3         | -631.4         | -760.5         | -168.8     |
| 0.9           | -530.5                                   | -414.5     | -685.4         | -929.0         | -1208.4        | -1581.2        | -1996.5        | -1455.2    |
| 1             | -997.3                                   | -887.5     | -1407.2        | -1895.5        | -2464.1        | -3237.1        | -4145.0        | -3570.0    |

Figure 3.33 shows a graph of maximum design moment values for all spans and profiles modeled.

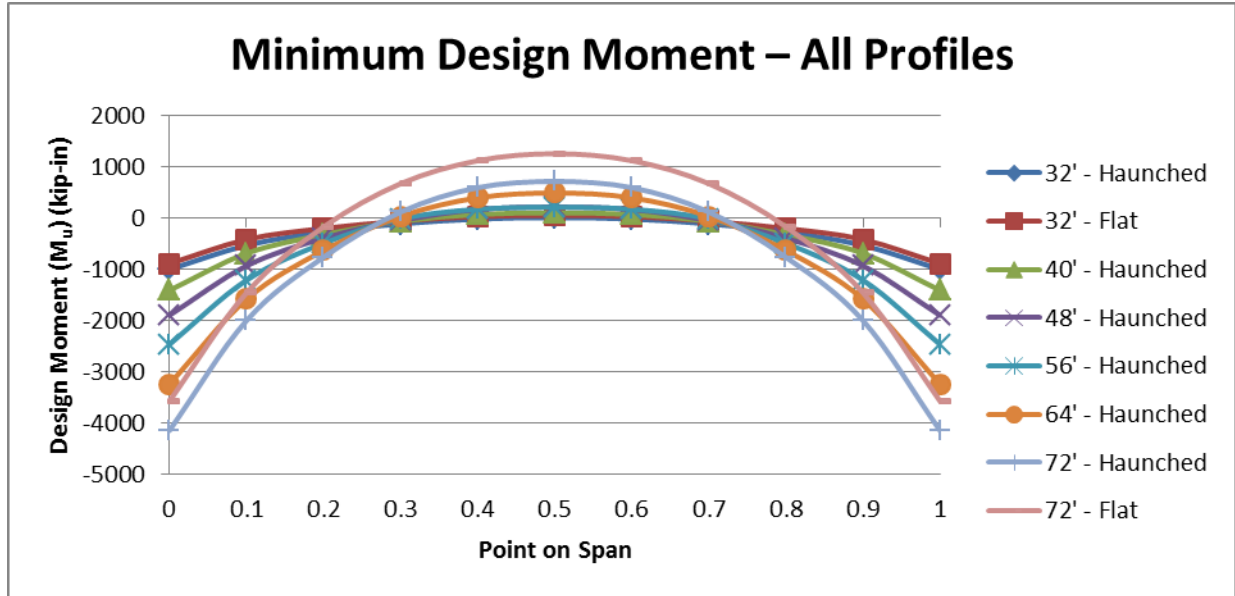

**Figure 3.33: Minimum Design Moment for All Spans and Profiles**

Comparison of all span lengths and profiles types showed the obvious trend of increasing positive and negative moment as span length increased. For haunched profiles, magnitude of the maximum negative moment was greater than the corresponding positive moment. The opposite was true for flat profiles, whose maximum positive moment exceeded the negative moment. This observation was expected based on the geometric details and variation in stiffness between the two profiles.

For all spans and profiles, the system experienced negative moment near the abutment. Presence of a negative moment region made the slab more efficient than a simply supported beam by reducing positive moment at midspan. However, due to rotation of the substructure, the system did not achieve maximum efficiency inherent in a truly fixed-fixed beam. The short-span system exhibited behavior in between these two idealized extremes. From these results, it can be

concluded the substructure succeeded, to some extent, at performing similar to end spans in multi-span structures. These promising results will be verified through preliminary structural design.

## **Design Procedure**

Tables and graphs provided in the previous subchapter provided all necessary data to proceed with design. This subchapter shows how preliminary design of the system was performed. Preliminary design was limited to flexural design. Shear design was not required by code for slabs in this case. In all cases, details of the profile had been determined. Flexural design consisted of adequately providing and proportioning the reinforcement.

The design portion of the verification example problem was used as a benchmark for the design of the new system. Since the verification example was completed in 2002, the bridge was designed according to an older version of the code. Procedures and code provisions used in the example were still assumed to be relevant and applicable for the new system. Care was taken to observe differences between versions of the code to facilitate appropriate, up-to-date design of the new system.

Design of the new system included Strength I, Service I, and Fatigue limit states. This subchapter is further separated according to limit state. Calculations were performed using Mathcad software. This same procedure was conducted at every tenth-point on the span of all profiles analyzed. Design for positive and negative moment was performed as needed. A brief overview of design considerations is provided in this subchapter. Calculations for design of one span are provided in Appendix B.

Design of the new system was performed in accordance with code provisions. References for equations are provided, including the relevant section and page number in the AASHTO

LRFD Bridge Design Specification, 5<sup>th</sup> ed., 2010. Additional references were used in design as well. Data for properties of selected reinforcement reference the Building Code Requirements for Structural Concrete (ACI 318-08) and Commentary, 2008. Other details reference a reinforced concrete textbook, *Design of Concrete Structures*, 14<sup>th</sup> ed., by Nilson, Darwin, and Dolan, 2010.

In order to begin design, a trial section was inputted. The trial section used the reinforcement size and spacing design from the center span of the existing KDOT three-span, haunched-slab bridge standard for each span length. Based on results for each trial section, size and spacing were modified to provide the most appropriate and efficient design. An attempt was made to minimize changes from the existing plans. Major goals of design included keeping all reinforcement sizing less than or equal to #11 bars, minimizing the number of bar splices, and minimizing the differences between bar sizes when splices were used.

### ***Input Variables***

Variables related to materials were constant in all cases. These included the following:

- 28-day compressive strength of concrete equal to 4 ksi
- Ultimate strain of concrete equal to 0.003
- Yield strength of reinforcing steel equal to 60 ksi
- Modulus of elasticity of steel equal to 29000 ksi

Required input variables related to the geometry of the structure included the following:

- Span length
- Height of section
- Width of strip (1 ft. in all cases)
- Clear cover for top layer of rebar (3 in. in all cases)

- Clear cover for bottom layer of rebar (1 in. in all cases)

Required input variables related to the loads and structural analysis included the following:

- Design moment demand for Strength I limit state
- Design moment demand for Service I limit state
- Design moment range for Fatigue limit state
- Minimum moment for Fatigue limit state

Required input variables to be determined by the designer included the following:

- Area and spacing of top layer of transverse steel reinforcement
- Area and spacing of bottom layer of transverse steel reinforcement
- Area and spacing of top layer of longitudinal steel reinforcement
- Area and spacing of bottom layer of longitudinal steel reinforcement

### ***Strength***

Design for Strength I limit state consisted of providing adequate structural capacity for ultimate moment. Calculations were carried out according to basic reinforced concrete theory. As doubly reinforced sections, both tension and compression steel were included. Structural analysis showed all slab elements carried axial compression, resulting from lateral earth pressure on the abutment walls. Because magnitude of the compressive forces was minimal, it was not shown earlier. In practice, presence of flexure and compressive force cause the system to behave as a beam column.

The beam columns were heavily dominated by flexure with minimum compression. For cases of low axial force, compression is known to increase the flexural capacity of the section. Compression was ignored for design purposes and the moment capacity was conservatively calculated as a case of pure flexure. To check, the  $c/d$  ratio of each section was compared to the balanced  $c/d$  ratio to ensure this design assumption was valid. In all cases, the sections remained in the tension-controlled region.

### *Service*

Design for Service I limit state included checks for distribution of longitudinal and transverse reinforcement, minimum reinforcement, and shrinkage and temperature reinforcement. Distribution of longitudinal reinforcement pertains to crack control in the tension regions of the system. Based on service load stresses, spacing of reinforcement was checked against the maximum allowed by code. Spacing of transverse reinforcement was likewise checked against code requirements for the tension region of the slab. Preliminary design of the system was primarily concerned with longitudinal reinforcement, however. No changes were made from the existing haunched-slab bridge plans related to transverse reinforcement.

Requirements for minimum reinforcement are intended to ensure ductility of the section. Checks for this code provision existed to guarantee enough steel was present so that cracking of the section did not result in immediate failure of the system. Finally, shrinkage and temperature provisions were checked for the top of the slab. These requirements specified a maximum reinforcement spacing to resolve tensile stresses resulting from temperature and volumetric changes in the concrete.

## ***Fatigue***

Fatigue design is concerned with preventing excessive stress ranges in reinforcing steel. Based on the minimum moment from the fatigue load case, the associated minimum stress was obtained. From this, the allowable stress range was calculated. Based on the moment range from the fatigue load case, actual stress range was compared to allowable stress range in the code.

## **Design Results**

Design of the system began with evaluating performance of the competing haunched and flat profiles. Results consisted of selection of the most efficient longitudinal reinforcement design for the system. First, a comparison of the haunched and flat profiles is presented. A reinforcement design was created for the 32-ft. and 72-ft. span of each profile. The required amount of steel reinforcement was calculated. By representing extremes of the span range, the profile which required the least amount of steel was determined to be the more efficient design. Design of the remaining spans was carried out using the more efficient profile. Preliminary design drawings are shown in plan, profile, and section views.

It cannot be understated that analysis and preliminary design results presented in this report are intended for purposes of comparison, evaluation, and selection of structural systems only. Before implementation, construction, and use of any facility, final design results must be prepared. All design calculations should first be checked and approved by a licensed, professional engineer with competence and proficiency in the appropriate field.

### ***Comparison of Haunched and Flat Profiles***

This subchapter presents design results for the 32-ft. and 72-ft. spans with haunched and flat profiles. The tables show rebar details used, and their spacing for the top and bottom of the slab at tenth-point locations. For the design, a set of bars were placed in a pattern for the full



width of the bridge. The tables show bar sizes used in the repeating pattern. The spacing value indicates the dimension over which the rebar pattern repeats itself, rather than the spacing between individual bars. The area of steel per unit width was calculated at the tenth-point of each profile. The amount of steel used at each tenth-point was averaged for the entire section. This average is the metric for comparison of the profiles. Table 3.20 shows a comparison of the reinforcement pattern for the 32-ft., haunched- and flat-slab sections.

**Table 3.20: Comparison of Reinforcement Designs for 32-ft. Sections**

| 32' Span | Haunched Slab |              |                |              | Flat Slab   |              |                |              |
|----------|---------------|--------------|----------------|--------------|-------------|--------------|----------------|--------------|
|          | Top of Slab   |              | Bottom of Slab |              | Top of Slab |              | Bottom of Slab |              |
| Location | Bars          | Spacing (in) | Bars           | Spacing (in) | Bars        | Spacing (in) | Bars           | Spacing (in) |
| 0.0      | 1 #6, 2 #7    | 15           | 1 #4           | 20           | 2 #6, 2 #7  | 16           | 1 #4           | 20           |
| 0.1      | 1 #6, 1 #7    | 15           | 1 #4           | 20           | 2 #6, 1 #7  | 16           | 1 #4, 1 #5     | 20           |
| 0.2      | 1 #7          | 15           | 1 #6, 1 #7     | 20           | 1 #6        | 16           | 1 #5, 2 #6     | 20           |
| 0.3      | 1 #4          | 15           | 3 #6, 1 #7     | 20           | 1 #4        | 16           | 1 #5, 3 #7     | 20           |
| 0.4      | 1 #4          | 15           | 4 #6, 1 #7     | 20           | 1 #4        | 16           | 1 #5, 4 #6     | 20           |
| 0.5      | 1 #4          | 15           | 4 #6, 1 #7     | 20           | 1 #4        | 16           | 1 #5, 4 #6     | 20           |

Table 3.21 summarizes the provision of steel for the 32-ft., haunched-slab section.

**Table 3.21: Provision of Steel for 32-ft. Haunched Slab for Profile Comparison**

| Single-Span Haunched Slab                    |                                      |                                   |                                      |                                   |                                   |
|--|--------------------------------------|-----------------------------------|--------------------------------------|-----------------------------------|-----------------------------------|
| 32' Span                                     | Top of Slab                          |                                   | Bottom of Slab                       |                                   | Total for Section                 |
| Location                                     | $A_s$ for Pattern (in <sup>2</sup> ) | $A_s$ per foot (in <sup>2</sup> ) | $A_s$ for Pattern (in <sup>2</sup> ) | $A_s$ per foot (in <sup>2</sup> ) | $A_s$ per foot (in <sup>2</sup> ) |
| 0.0  | 1.64                                 | 1.31                              | 0.20                                 | 0.12                              | 1.43                              |
| 0.1  | 1.04                                 | 0.83                              | 0.20                                 | 0.12                              | 0.95                              |
| 0.2  | 0.60                                 | 0.48                              | 1.04                                 | 0.62                              | 1.10                              |
| 0.3  | 0.20                                 | 0.16                              | 1.92                                 | 1.15                              | 1.31                              |
| 0.4  | 0.20                                 | 0.16                              | 2.36                                 | 1.42                              | 1.58                              |
| 0.5  | 0.20                                 | 0.16                              | 2.36                                 | 1.42                              | 1.58                              |
| Average $A_s$ for Section (in <sup>2</sup> ) |                                      |                                   |                                      |                                   | 1.30                              |

Table 3.22 summarizes the provision of steel for the 32-ft., flat-slab section.

**Table 3.22: Provision of Steel for 32-ft. Flat Slab for Profile Comparison**

| Flat Slab                                    |                                      |                                   |                                      |                                   |                                   |
|--|--------------------------------------|-----------------------------------|--------------------------------------|-----------------------------------|-----------------------------------|
| 32' Span                                     | Top of Slab                          |                                   | Bottom of Slab                       |                                   | Total for Section                 |
| Location                                     | $A_s$ for Pattern (in <sup>2</sup> ) | $A_s$ per foot (in <sup>2</sup> ) | $A_s$ for Pattern (in <sup>2</sup> ) | $A_s$ per foot (in <sup>2</sup> ) | $A_s$ per foot (in <sup>2</sup> ) |
| 0.0  | 2.08                                 | 1.56                              | 0.20                                 | 0.12                              | 1.68                              |
| 0.1  | 1.40                                 | 1.05                              | 0.51                                 | 0.31                              | 1.36                              |
| 0.2  | 0.44                                 | 0.33                              | 1.19                                 | 0.71                              | 1.04                              |
| 0.3  | 0.20                                 | 0.15                              | 1.63                                 | 0.98                              | 1.13                              |
| 0.4  | 0.20                                 | 0.15                              | 2.07                                 | 1.24                              | 1.39                              |
| 0.5  | 0.20                                 | 0.15                              | 2.07                                 | 1.24                              | 1.39                              |
| Average $A_s$ for Section (in <sup>2</sup> ) |                                      |                                   |                                      |                                   | 1.33                              |

Table 3.23 shows a comparison of the reinforcement patterns for the 72-ft., haunched- and flat-slab sections.

**Table 3.23: Comparison of Reinforcement Designs for 72-ft. Sections**

| 72' Span | Haunched Slab |              |                |              | Flat Slab   |              |                |              |
|----------|---------------|--------------|----------------|--------------|-------------|--------------|----------------|--------------|
|          | Top of Slab   |              | Bottom of Slab |              | Top of Slab |              | Bottom of Slab |              |
| Location | Bars          | Spacing (in) | Bars           | Spacing (in) | Bars        | Spacing (in) | Bars           | Spacing (in) |
| 0.0      | 3 #9          | 15           | 1 #5           | 20           | 2 #9, 2 #10 | 16           | 1 #5           | 20           |
| 0.1      | 2 #9          | 15           | 2 #5           | 20           | 1 #9, 1 #10 | 16           | 1 #5, 1 #10    | 20           |
| 0.2      | 1 #9          | 15           | 1 #10, 1 #11   | 20           | 1 #4, 1 #10 | 16           | 2 #10, 1 #11   | 20           |
| 0.3      | 1 #9          | 15           | 1 #10, 3 #11   | 20           | 1 #4        | 16           | 3 #10, 1 #11   | 20           |
| 0.4      | 1 #9          | 15           | 1 #10, 4 #11   | 20           | 1 #4        | 16           | 3 #10, 2 #11   | 20           |
| 0.5      | 1 #9          | 15           | 1 #10, 4 #11   | 20           | 1 #4        | 16           | 3 #10, 2 #11   | 20           |

Table 3.24 summarizes the provision of steel for the 72-ft., haunched-slab section.

**Table 3.24: Provision of Steel for 72-ft. Haunched Slab for Profile Comparison**

| Single-Span Haunched Slab                    |                                      |                                   |                                      |                                   |                                   |
|--|--------------------------------------|-----------------------------------|--------------------------------------|-----------------------------------|-----------------------------------|
| 72' Span                                     | Top of Slab                          |                                   | Bottom of Slab                       |                                   | Total for Section                 |
| Location                                     | $A_s$ for Pattern (in <sup>2</sup> ) | $A_s$ per foot (in <sup>2</sup> ) | $A_s$ for Pattern (in <sup>2</sup> ) | $A_s$ per foot (in <sup>2</sup> ) | $A_s$ per foot (in <sup>2</sup> ) |
| 0.0  | 3.00                                 | 2.40                              | 0.31                                 | 0.19                              | 2.59                              |
| 0.1  | 2.00                                 | 1.60                              | 0.62                                 | 0.37                              | 1.97                              |
| 0.2  | 1.00                                 | 0.80                              | 2.83                                 | 1.70                              | 2.50                              |
| 0.3  | 1.00                                 | 0.80                              | 5.95                                 | 3.57                              | 4.37                              |
| 0.4  | 1.00                                 | 0.80                              | 7.51                                 | 4.51                              | 5.31                              |
| 0.5  | 1.00                                 | 0.80                              | 7.51                                 | 4.51                              | 5.31                              |
| Average $A_s$ for Section (in <sup>2</sup> ) |                                      |                                   |                                      |                                   | 3.52                              |

Table 3.25 summarizes the provision of steel for the 72-ft., flat-slab section.

**Table 3.25: Provision of Steel for 72-ft. Flat Slab for Profile Comparison**

| Flat Slab                                    |                                      |                                   |                                      |                                   |                                   |
|--|--------------------------------------|-----------------------------------|--------------------------------------|-----------------------------------|-----------------------------------|
| 72' Span                                     | Top of Slab                          |                                   | Bottom of Slab                       |                                   | Total for Section                 |
| Location                                     | $A_s$ for Pattern (in <sup>2</sup> ) | $A_s$ per foot (in <sup>2</sup> ) | $A_s$ for Pattern (in <sup>2</sup> ) | $A_s$ per foot (in <sup>2</sup> ) | $A_s$ per foot (in <sup>2</sup> ) |
| 0.0  | 4.54                                 | 3.41                              | 0.31                                 | 0.19                              | 3.59                              |
| 0.1  | 2.27                                 | 1.70                              | 1.58                                 | 0.95                              | 2.65                              |
| 0.2  | 1.47                                 | 1.10                              | 4.10                                 | 2.46                              | 3.56                              |
| 0.3  | 0.20                                 | 0.15                              | 5.37                                 | 3.22                              | 3.37                              |
| 0.4  | 0.20                                 | 0.15                              | 6.93                                 | 4.16                              | 4.31                              |
| 0.5  | 0.20                                 | 0.15                              | 6.93                                 | 4.16                              | 4.31                              |
| Average $A_s$ for Section (in <sup>2</sup> ) |                                      |                                   |                                      |                                   | 3.57                              |

A few conclusions can be made from comparison of the haunched and flat designs. The change in reinforcement between the profiles was relatively minimal and predictable. Since the haunched slab had less depth than the flat slab at midspan, more steel was needed in this region to provide the required capacity. Conversely, the haunched slab had greater depth than the flat

slab at the end of span. It likewise had less reinforcement than the flat slab in this region. Differences between the two sections in the end span region are fairly equal and balanced with the differences near midspan.

Both sections were functional and served adequately as solutions to the short-span bridge problem. The required quantity of steel was averaged for all 11 nodes on the span to evaluate which profile design was more economical. For the case of both span lengths, the haunched slab used less steel than the flat slab.

It should be noted, though, that calculating steel quantities this way is a rough estimate. It is not yet known where the cut-off and splice points for the rebar will be located. Development length calculations were not performed as part of preliminary design. Only after these calculations and design decisions are made will the steel quantity be entirely accurate. Since these details will not be covered in this report, estimations must be relied upon.

The haunched profile was selected based on this data, but the author does not suggest it as the only acceptable design. The flat slab should serve just as well. Due to the closeness of preliminary design data, a more detailed design is needed to determine whether the haunched or flat profile is truly more appropriate for all span lengths under consideration.

### ***Design of Remaining Haunched Profiles***

Based on the preceding observation, the haunched slab was used throughout the remainder of design. Just as in the previous subchapter, reinforcement design and steel requirements for the 40-ft., 48-ft., 56-ft., and 64-ft. designs are shown. Although repetitive, the 32-ft. and 72-ft., haunched-profile designs and steel requirements are shown as well so that design data for all spans are located together. For all cases, the existing reinforcement pattern from the center span of the three-span, haunched-slab bridge standard was used as a trial design.

Based on this benchmark, changes were made as needed to the reinforcement pattern to provide a more efficient and effective design. Tables show both trial and final designs to more easily illustrate required changes to the system. Table 3.26 shows the reinforcement pattern for the 32-ft., haunched-slab section.

**Table 3.26: Reinforcement Design of 32-ft., Haunched-Slab Section**

| 32' Span | Center Span - Existing Reinforcement Design |              |                |              | Single Span - New Reinforcement Design |              |                |              |
|----------|---|--------------|----------------|--------------|--|--------------|----------------|--------------|
|          | Top of Slab                                 |              | Bottom of Slab |              | Top of Slab                            |              | Bottom of Slab |              |
| Location | Bars  | Spacing (in) | Bars           | Spacing (in) | Bars                                   | Spacing (in) | Bars           | Spacing (in) |
| 0.0      | 2 #7, 1 #8                                  | 15           | 2 #8           | 20           | 1 #6, 2 #7                             | 15           | 1 #4           | 20           |
| 0.1      | 2 #7, 1 #8                                  | 15           | 2 #8           | 20           | 1 #6, 1 #7                             | 15           | 1 #4           | 20           |
| 0.2      | 2 #7, 1 #8                                  | 15           | 2 #8           | 20           | 1 #7                                   | 15           | 1 #6, 1 #7     | 20           |
| 0.3      | 1 #7, 1 #8                                  | 15           | 1 #7, 2 #8     | 20           | 1 #4                                   | 15           | 3 #6, 1 #7     | 20           |
| 0.4      | 1 #8  | 15           | 2 #7, 2 #8     | 20           | 1 #4                                   | 15           | 4 #6, 1 #7     | 20           |
| 0.5      | 1 #8  | 15           | 2 #7, 2 #8     | 20           | 1 #4                                   | 15           | 4 #6, 1 #7     | 20           |

Table 3.27 summarizes the provision of steel for the 32-ft., haunched-slab section.

**Table 3.27: Provision of Steel for 32-ft., Haunched Slab**

| Single-Span Haunched Slab |                                      |                                   |                                      |                                   |                                   |  |
|---------------------------|--------------------------------------|-----------------------------------|--------------------------------------|-----------------------------------|-----------------------------------|--|
| 32' Span                  | Top of Slab                          |                                   | Bottom of Slab                       |                                   | Total for Section                 |  |
| Location                  | $A_s$ for Pattern (in <sup>2</sup> ) | $A_s$ per foot (in <sup>2</sup> ) | $A_s$ for Pattern (in <sup>2</sup> ) | $A_s$ per foot (in <sup>2</sup> ) | $A_s$ per foot (in <sup>2</sup> ) |  |
| 0.0                       | 1.64                                 | 1.31                              | 0.20                                 | 0.12                              | 1.43                              |  |
| 0.1                       | 1.04                                 | 0.83                              | 0.20                                 | 0.12                              | 0.95                              |  |
| 0.2                       | 0.60                                 | 0.48                              | 1.04                                 | 0.62                              | 1.10                              |  |
| 0.3                       | 0.20                                 | 0.16                              | 1.92                                 | 1.15                              | 1.31                              |  |
| 0.4                       | 0.20                                 | 0.16                              | 2.36                                 | 1.42                              | 1.58                              |  |
| 0.5                       | 0.20                                 | 0.16                              | 2.36                                 | 1.42                              | 1.58                              |  |

Table 3.28 shows the reinforcement pattern for the 40-ft., haunched-slab section.

**Table 3.28: Reinforcement Design of 40-ft., Haunched-Slab Section**

| 40' Span | Center Span - Existing Reinforcement Design |              |                |              | Single Span - New Reinforcement Design |              |                |              |
|----------|---|--------------|----------------|--------------|--|--------------|----------------|--------------|
|          | Top of Slab                                 |              | Bottom of Slab |              | Top of Slab                            |              | Bottom of Slab |              |
| Location | Bars  | Spacing (in) | Bars           | Spacing (in) | Bars                                   | Spacing (in) | Bars           | Spacing (in) |
| 0.0      | 3 #8  | 15           | 1 #4, 1 #9     | 20           | 2 #7, 1 #8                             | 15           | 1 #4           | 20           |
| 0.1      | 3 #8  | 15           | 1 #4, 1 #9     | 20           | 2 #7                                   | 15           | 1 #4           | 20           |
| 0.2      | 3 #8  | 15           | 2 #9           | 20           | 1 #7                                   | 15           | 1 #7, 1 #8     | 20           |
| 0.3      | 2 #8  | 15           | 3 #9           | 20           | 1 #4                                   | 15           | 3 #7, 1 #8     | 20           |
| 0.4      | 1 #8  | 15           | 1 #8, 3 #9     | 20           | 1 #4                                   | 15           | 4 #7, 1 #8     | 20           |
| 0.5      | 1 #8  | 15           | 1 #8, 3 #9     | 20           | 1 #4                                   | 15           | 4 #7, 1 #8     | 20           |

Table 3.29 summarizes the provision of steel for the 40-ft., haunched-slab section.

**Table 3.29: Provision of Steel for 40-ft., Haunched Slab**

| Single-Span Haunched Slab |   |  |   |  |  |
|---------------------------|---|--|---|--|--|
| 40' Span                  | Top of Slab                                   |  | Bottom of Slab                                |  | Total for Section                          |
| Location                  | A <sub>s</sub> for Pattern (in <sup>2</sup> ) | A <sub>s</sub> per foot (in <sup>2</sup> ) | A <sub>s</sub> for Pattern (in <sup>2</sup> ) | A <sub>s</sub> per foot (in <sup>2</sup> ) | A <sub>s</sub> per foot (in <sup>2</sup> ) |
| 0.0                       | 1.99  | 1.59                                       | 0.20  | 0.12                                       | 1.71                                       |
| 0.1                       | 1.20  | 0.96                                       | 0.20  | 0.12                                       | 1.08                                       |
| 0.2                       | 0.60  | 0.48                                       | 1.39  | 0.83                                       | 1.31                                       |
| 0.3                       | 0.20  | 0.16                                       | 2.59  | 1.55                                       | 1.71                                       |
| 0.4                       | 0.20  | 0.16                                       | 3.19  | 1.91                                       | 2.07                                       |
| 0.5                       | 0.20  | 0.16                                       | 3.19  | 1.91                                       | 2.07                                       |

Table 3.30 shows the reinforcement pattern for the 48-ft., haunched-slab section.

**Table 3.30: Reinforcement Design of 48-ft., Haunched-Slab Section**

| 48' Span | Center Span - Existing Reinforcement Design |              |                |              | Single Span - New Reinforcement Design |              |                |              |
|----------|---|--------------|----------------|--------------|--|--------------|----------------|--------------|
|          | Top of Slab                                 |              | Bottom of Slab |              | Top of Slab                            |              | Bottom of Slab |              |
| Location | Bars  | Spacing (in) | Bars           | Spacing (in) | Bars                                   | Spacing (in) | Bars           | Spacing (in) |
| 0.0      | 3 #9  | 15           | 1 #4, 1 #9     | 20           | 3 #8                                   | 15           | 1 #4           | 20           |
| 0.1      | 3 #9  | 15           | 1 #4, 1 #9     | 20           | 2 #8                                   | 15           | 1 #4           | 20           |
| 0.2      | 3 #9  | 15           | 2 #9           | 20           | 1 #8                                   | 15           | 1 #8, 1 #9     | 20           |
| 0.3      | 2 #9  | 15           | 3 #9           | 20           | 1 #4                                   | 15           | 2 #8, 1 #9     | 20           |
| 0.4      | 1 #9  | 15           | 1 #8, 3 #9     | 20           | 1 #4                                   | 15           | 4 #8, 1 #9     | 20           |
| 0.5      | 1 #9  | 15           | 1 #8, 3 #9     | 20           | 1 #4                                   | 15           | 4 #8, 1 #9     | 20           |

Table 3.31 shows the provision of steel for the 48-ft., haunched-slab section.

**Table 3.31: Provision of Steel for 48-ft. Haunched Slab**

| Single-Span Haunched Slab |   |  |   |  |  |
|---------------------------|---|--|---|--|--|
| 48' Span                  | Top of Slab                                   |  | Bottom of Slab                                |  | Total for Section                          |
| Location                  | A <sub>s</sub> for Pattern (in <sup>2</sup> ) | A <sub>s</sub> per foot (in <sup>2</sup> ) | A <sub>s</sub> for Pattern (in <sup>2</sup> ) | A <sub>s</sub> per foot (in <sup>2</sup> ) | A <sub>s</sub> per foot (in <sup>2</sup> ) |
| 0.0                       | 2.37  | 1.90                                       | 0.20  | 0.12                                       | 2.02                                       |
| 0.1                       | 1.58  | 1.26                                       | 0.20  | 0.12                                       | 1.38                                       |
| 0.2                       | 0.79  | 0.63                                       | 1.79  | 1.07                                       | 1.71                                       |
| 0.3                       | 0.20  | 0.16                                       | 2.58  | 1.55                                       | 1.71                                       |
| 0.4                       | 0.20  | 0.16                                       | 4.16  | 2.50                                       | 2.66                                       |
| 0.5                       | 0.20  | 0.16                                       | 4.16  | 2.50                                       | 2.66                                       |

Table 3.32 shows the reinforcement pattern for the 56-ft., haunched-slab section.

**Table 3.32: Reinforcement Design of 56-ft., Haunched-Slab Section**

| 56' Span | Center Span - Existing Reinforcement Design |              |                |              | Single Span - New Reinforcement Design |              |                |              |
|----------|---|--------------|----------------|--------------|--|--------------|----------------|--------------|
|          | Top of Slab                                 |              | Bottom of Slab |              | Top of Slab                            |              | Bottom of Slab |              |
| Location | Bars  | Spacing (in) | Bars           | Spacing (in) | Bars                                   | Spacing (in) | Bars           | Spacing (in) |
| 0.0      | 1 #9, 2 #10                                 | 15           | 1 #4, 1 #10    | 20           | 1 #8, 2 #9                             | 15           | 1 #5           | 20           |
| 0.1      | 1 #9, 2 #10                                 | 15           | 1 #4, 1 #10    | 20           | 1 #8, 1 #9                             | 15           | 1 #5           | 20           |
| 0.2      | 1 #9, 2 #10                                 | 15           | 1 #9, 1 #10    | 20           | 1 #8                                   | 15           | 1 #9, 1 #10    | 20           |
| 0.3      | 1 #9, 1 #10                                 | 15           | 2 #9, 1 #10    | 20           | 1 #4                                   | 15           | 2 #9, 1 #10    | 20           |
| 0.4      | 1 #10                                       | 15           | 3 #9, 1 #10    | 20           | 1 #4                                   | 15           | 4 #9, 1 #10    | 20           |
| 0.5      | 1 #10                                       | 15           | 3 #9, 1 #10    | 20           | 1 #4                                   | 15           | 4 #9, 1 #10    | 20           |

Table 3.33 shows the provision of steel for the 56-ft., haunched-slab section.

**Table 3.33: Provision of Steel for 56-ft. Haunched Slab**

| Single-Span Haunched Slab |   |  |   |  |  |
|---------------------------|---|--|---|--|--|
| 56' Span                  | Top of Slab                                   |  | Bottom of Slab                                |  | Total for Section                          |
| Location                  | A <sub>s</sub> for Pattern (in <sup>2</sup> ) | A <sub>s</sub> per foot (in <sup>2</sup> ) | A <sub>s</sub> for Pattern (in <sup>2</sup> ) | A <sub>s</sub> per foot (in <sup>2</sup> ) | A <sub>s</sub> per foot (in <sup>2</sup> ) |
| 0.0                       | 2.79  | 2.23                                       | 0.31  | 0.19                                       | 2.42                                       |
| 0.1                       | 1.79  | 1.43                                       | 0.31  | 0.19                                       | 1.62                                       |
| 0.2                       | 0.79  | 0.63                                       | 2.27  | 1.36                                       | 1.99                                       |
| 0.3                       | 0.20  | 0.16                                       | 3.27  | 1.96                                       | 2.12                                       |
| 0.4                       | 0.20  | 0.16                                       | 5.27  | 3.16                                       | 3.32                                       |
| 0.5                       | 0.20  | 0.16                                       | 5.27  | 3.16                                       | 3.32                                       |

Table 3.34 shows the reinforcement pattern for the 64-ft., haunched-slab section.

**Table 3.34: Reinforcement Design of 64-ft., Haunched-Slab Section**

| 64' Span | Center Span - Existing Reinforcement Design |              |                |              | Single Span - New Reinforcement Design |              |                |              |
|----------|---|--------------|----------------|--------------|--|--------------|----------------|--------------|
|          | Top of Slab                                 |              | Bottom of Slab |              | Top of Slab                            |              | Bottom of Slab |              |
|          | Bars  | Spacing (in) | Bars           | Spacing (in) | Bars                                   | Spacing (in) | Bars           | Spacing (in) |
| 0.0      | 3 #10                                       | 15           | 1 #4, 1 #10    | 20           | 3 #9                                   | 15           | 1 #5           | 20           |
| 0.1      | 3 #10                                       | 15           | 1 #4, 1 #10    | 20           | 2 #9                                   | 15           | 1 #5           | 20           |
| 0.2      | 3 #10                                       | 15           | 1 #9, 1 #10    | 20           | 1 #9                                   | 15           | 1 #9, 1 #10    | 20           |
| 0.3      | 2 #10                                       | 15           | 2 #9, 1 #10    | 20           | 1 #4                                   | 15           | 1 #9, 3 #10    | 20           |
| 0.4      | 1 #10                                       | 15           | 3 #9, 1 #10    | 20           | 1 #4                                   | 15           | 1 #9, 4 #10    | 20           |
| 0.5      | 1 #10                                       | 15           | 3 #9, 1 #10    | 20           | 1 #4                                   | 15           | 1 #9, 4 #10    | 20           |

Table 3.35 shows the provision of steel for the 64-ft., haunched-slab section.

**Table 3.35: Provision of Steel for 64-ft. Haunched Slab**

| Single-Span Haunched Slab |   |  |   |  |  |
|---------------------------|---|--|---|--|--|
| 64' Span                  | Top of Slab                                   |  | Bottom of Slab                                |  | Total for Section                          |
| Location                  | A <sub>s</sub> for Pattern (in <sup>2</sup> ) | A <sub>s</sub> per foot (in <sup>2</sup> ) | A <sub>s</sub> for Pattern (in <sup>2</sup> ) | A <sub>s</sub> per foot (in <sup>2</sup> ) | A <sub>s</sub> per foot (in <sup>2</sup> ) |
| 0.0                       | 3.00  | 2.40                                       | 0.31  | 0.19                                       | 2.59                                       |
| 0.1                       | 2.00  | 1.60                                       | 0.31  | 0.19                                       | 1.79                                       |
| 0.2                       | 1.00  | 0.80                                       | 2.27  | 1.36                                       | 2.16                                       |
| 0.3                       | 0.20  | 0.16                                       | 4.81  | 2.89                                       | 3.05                                       |
| 0.4                       | 0.20  | 0.16                                       | 6.08  | 3.65                                       | 3.81                                       |
| 0.5                       | 0.20  | 0.16                                       | 6.08  | 3.65                                       | 3.81                                       |

Table 3.36 shows the reinforcement pattern for the 72-ft., haunched-slab section.

**Table 3.36: Reinforcement Design of 72-ft., Haunched-Slab Section**

| 72' Span | Center Span - Existing Reinforcement Design |              |                |              | Single Span - New Reinforcement Design |              |                |              |
|----------|---|--------------|----------------|--------------|--|--------------|----------------|--------------|
|          | Top of Slab                                 |              | Bottom of Slab |              | Top of Slab                            |              | Bottom of Slab |              |
|          | Bars  | Spacing (in) | Bars           | Spacing (in) | Bars                                   | Spacing (in) | Bars           | Spacing (in) |
| 0.0      | 2 #10, 1 #11                                | 15           | 1 #4, 1 #10    | 20           | 3 #9                                   | 15           | 1 #5           | 20           |
| 0.1      | 2 #10, 1 #11                                | 15           | 1 #4, 1 #10    | 20           | 2 #9                                   | 15           | 2 #5           | 20           |
| 0.2      | 2 #10, 1 #11                                | 15           | 2 #10          | 20           | 1 #9                                   | 15           | 1 #10, 1 #11   | 20           |
| 0.3      | 2 #10                                       | 15           | 3 #10          | 20           | 1 #9                                   | 15           | 1 #10, 3 #11   | 20           |
| 0.4      | 1 #10                                       | 15           | 4 #10          | 20           | 1 #9                                   | 15           | 1 #10, 4 #11   | 20           |
| 0.5      | 1 #10                                       | 15           | 4 #10          | 20           | 1 #9                                   | 15           | 1 #10, 4 #11   | 20           |



Table 3.37 shows the provision of steel for the 72-ft., haunched-slab section.

**Table 3.37: Provision of Steel for 72-ft. Haunched Slab**

| Single-Span Haunched Slab |                                      |                                   |                                      |                                   |                                   |
|---------------------------|--------------------------------------|-----------------------------------|--------------------------------------|-----------------------------------|-----------------------------------|
| 72' Span                  | Top of Slab                          |                                   | Bottom of Slab                       |                                   | Total for Section                 |
| Location                  | $A_s$ for Pattern (in <sup>2</sup> ) | $A_s$ per foot (in <sup>2</sup> ) | $A_s$ for Pattern (in <sup>2</sup> ) | $A_s$ per foot (in <sup>2</sup> ) | $A_s$ per foot (in <sup>2</sup> ) |
| 0.0                       | 3.00                                 | 2.40                              | 0.31                                 | 0.19                              | 2.59                              |
| 0.1                       | 2.00                                 | 1.60                              | 0.62                                 | 0.37                              | 1.97                              |
| 0.2                       | 1.00                                 | 0.80                              | 2.83                                 | 1.70                              | 2.50                              |
| 0.3                       | 1.00                                 | 0.80                              | 5.95                                 | 3.57                              | 4.37                              |
| 0.4                       | 1.00                                 | 0.80                              | 7.51                                 | 4.51                              | 5.31                              |
| 0.5                       | 1.00                                 | 0.80                              | 7.51                                 | 4.51                              | 5.31                              |

Table 3.38 shows the moment capacity of the new system. For each of the six spans, the moment demand based on structural analysis is given. Again, capacity of the section based on the reinforcement pattern currently used for the three-span, haunched-slab bridge system is included. This shows locations in which the section would be oversized and undersized if the current reinforcement was maintained. Moment capacity of the section based on final design is then shown. All design results are for the one-foot-wide strip used in structural analysis. The overbuild factor was calculated as the ratio of factored moment capacity to factored moment demand, for each respective design.

A few important trends and conclusions were observed from the design data. For shorter spans, existing reinforcement patterns were a better fit than for longer spans. The existing reinforcement resulted in an oversized system for positive moment on the shorter bridges. Overdesign was highest near the inflection point region around the one-tenth point. Even when redesigned, overdesign was difficult to avoid in this area since minimal steel will still exceed the requirements for very low moment demand. Near midspan, the existing design was more appropriate.

**Table 3.38: Design Capacities of Haunched Sections**

| Location on Span (Tenth-Points)  |   | Positive Moment |      |      |      |      |      | Negative Moment |       |       |        |       |      |
|----------------------------------|---|-----------------|------|------|------|------|------|-----------------|-------|-------|--------|-------|------|
|                                  |   | 0.0             | 0.1  | 0.2  | 0.3  | 0.4  | 0.5  | 0.0             | 0.1   | 0.2   | 0.3    | 0.4   | 0.5  |
| 32' Span                         | Moment Demand ( $M_u$ ) (kip-in)        | 0               | 138  | 440  | 662  | 791  | 837  | -997            | -531  | -269  | -108   | -16   | 0    |
| Center-Span Reinforcement Design | Moment Capacity ( $\phi M_n$ ) (kip-in) | 961             | 844  | 752  | 877  | 1000 | 977  | -1319           | -1121 | -968  | -613   | -338  | -330 |
|                                  | Overbuild Factor                        | --              | 6.12 | 1.71 | 1.32 | 1.26 | 1.17 | 1.32            | 2.11  | 3.60  | 5.65   | 21.67 | --   |
| Single-Span Reinforcement Design | Moment Capacity ( $\phi M_n$ ) (kip-in) | 252             | 239  | 528  | 770  | 866  | 847  | -1099           | -608  | -317  | -118   | -104  | -102 |
|                                  | Overbuild Factor                        | --              | 1.73 | 1.20 | 1.16 | 1.09 | 1.01 | 1.10            | 1.15  | 1.18  | 1.09   | 6.67  | --   |
| 40' Span                         | Moment Demand ( $M_u$ ) (kip-in)        | 0               | 169  | 596  | 907  | 1088 | 1146 | -1407           | -685  | -321  | -59    | 0     | 0    |
| Center-Span Reinforcement Design | Moment Capacity ( $\phi M_n$ ) (kip-in) | 844             | 743  | 986  | 1172 | 1418 | 1382 | -1740           | -1475 | -1273 | -767   | -375  | -365 |
|                                  | Overbuild Factor                        | --              | 4.39 | 1.65 | 1.29 | 1.30 | 1.21 | 1.24            | 2.15  | 3.96  | 12.91  | --    | --   |
| Single-Span Reinforcement Design | Moment Capacity ( $\phi M_n$ ) (kip-in) | 291             | 254  | 717  | 1094 | 1228 | 1198 | -1468           | -776  | -353  | -131   | -124  | -111 |
|                                  | Overbuild Factor                        | --              | 1.50 | 1.20 | 1.21 | 1.13 | 1.05 | 1.04            | 1.13  | 1.10  | 2.21   | --    | --   |
| 48' Span                         | Moment Demand ( $M_u$ ) (kip-in)        | 0               | 192  | 767  | 1187 | 1432 | 1516 | -1896           | -929  | -390  | -41    | 0     | 0    |
| Center-Span Reinforcement Design | Moment Capacity ( $\phi M_n$ ) (kip-in) | 920             | 809  | 1074 | 1356 | 1544 | 1505 | -2392           | -2022 | -1747 | -1051  | -505  | -492 |
|                                  | Overbuild Factor                        | --              | 4.21 | 1.40 | 1.14 | 1.08 | 0.99 | 1.26            | 2.18  | 4.48  | 25.51  | --    | --   |
| Single-Span Reinforcement Design | Moment Capacity ( $\phi M_n$ ) (kip-in) | 307             | 277  | 961  | 1207 | 1675 | 1632 | -1907           | -1104 | -496  | -144   | -137  | -134 |
|                                  | Overbuild Factor                        | --              | 1.44 | 1.25 | 1.02 | 1.17 | 1.08 | 1.01            | 1.19  | 1.27  | 3.50   | --    | --   |
| 56' Span                         | Moment Demand ( $M_u$ ) (kip-in)        | 0               | 222  | 982  | 1519 | 1811 | 1997 | -2464           | -1208 | -489  | -13    | 0     | 0    |
| Center-Span Reinforcement Design | Moment Capacity ( $\phi M_n$ ) (kip-in) | 1182            | 1029 | 1291 | 1577 | 1845 | 1796 | -3093           | -2601 | -2236 | -1290  | -684  | -664 |
|                                  | Overbuild Factor                        | --              | 4.63 | 1.31 | 1.04 | 1.02 | 0.90 | 1.26            | 2.15  | 4.57  | 101.57 | --    | --   |
| Single-Span Reinforcement Design | Moment Capacity ( $\phi M_n$ ) (kip-in) | 404             | 337  | 1273 | 1573 | 2209 | 2148 | -2456           | -1366 | -544  | -157   | -140  | -146 |
|                                  | Overbuild Factor                        | --              | 1.52 | 1.30 | 1.04 | 1.22 | 1.08 | 1.00            | 1.13  | 1.11  | 12.36  | --    | --   |
| 64' Span                         | Moment Demand ( $M_u$ ) (kip-in)        | 0               | 359  | 1399 | 2188 | 2652 | 2805 | -3237           | -1581 | -631  | 0      | 0     | 0    |
| Center-Span Reinforcement Design | Moment Capacity ( $\phi M_n$ ) (kip-in) | 1457            | 1239 | 1538 | 1852 | 2143 | 2073 | -4259           | -3507 | -2947 | -1722  | -802  | -774 |
|                                  | Overbuild Factor                        | --              | 3.45 | 1.10 | 0.85 | 0.81 | 0.74 | 1.32            | 2.22  | 4.67  | --     | --    | --   |
| Single-Span Reinforcement Design | Moment Capacity ( $\phi M_n$ ) (kip-in) | 463             | 408  | 1524 | 2627 | 2906 | 2806 | -3371           | -1897 | -819  | -181   | -149  | -164 |
|                                  | Overbuild Factor                        | --              | 1.14 | 1.09 | 1.20 | 1.10 | 1.00 | 1.04            | 1.20  | 1.30  | --     | --    | --   |
| 72' Span                         | Moment Demand ( $M_u$ ) (kip-in)        | 0               | 579  | 2006 | 3041 | 3654 | 3845 | -4145           | -1997 | -761  | 0      | 0     | 0    |
| Center-Span Reinforcement Design | Moment Capacity ( $\phi M_n$ ) (kip-in) | 1739            | 1456 | 1976 | 2445 | 2856 | 2747 | -5282           | -4530 | -3749 | -2009  | -920  | -884 |
|                                  | Overbuild Factor                        | --              | 2.51 | 0.98 | 0.80 | 0.78 | 0.71 | 1.27            | 2.27  | 4.93  | --     | --    | --   |
| Single-Span Reinforcement Design | Moment Capacity ( $\phi M_n$ ) (kip-in) | 522             | 624  | 2161 | 3657 | 4007 | 3847 | -4125           | -2284 | -966  | -824   | -738  | -710 |
|                                  | Overbuild Factor                        | --              | 1.08 | 1.08 | 1.20 | 1.10 | 1.00 | 1.00            | 1.14  | 1.27  | --     | --    | --   |

A similar trend was observed for the negative moment design. Near the end of span, the system was mildly overdesigned. But near the midspan region of low negative moment, the capacity greatly exceeded the requirement. Again, this was impossible to avoid if the system was to be doubly reinforced throughout.

Redesign for shorter spans can be characterized by reduction in the amount of reinforcement throughout the sections. This was especially true near the end of span in the positive moment region and near midspan for the negative moment region. Reduction in

reinforcement in the high positive and negative moment regions was more limited. It should be mentioned that the existing haunched-slab plans may have additional rebar as needed to reduce deflection or satisfy other service conditions. Since some of these parameters were not included in this project, a completely identical comparison cannot be performed.

For longer spans, the end of span was still overdesigned in the positive moment region. However, the midspan area was underdesigned. For negative moment, longer sections were somewhat overdesigned near the end of span, but heavily overdesigned in near midspan. Redesign resulted in less reinforcement in the negative moment region throughout the section. For the case of positive moment, reinforcement was reduced near the end of span, but added near midspan.

Results of redesign were fitting based on structural analysis of the sections. Analysis confirmed the single-span system achieved continuity for moment transfer into the substructure. But, it was not as effective in this transfer as an adjacent span in the three-span system. Naturally, the three-span system attracted more negative moment at the piers and less positive at midspan of the center span. Redesign consequently required the addition of positive moment reinforcement, and midspan and reduction of reinforcement at the end of span.

It was confirmed the single-span, haunched-slab system can be effectively used to span crossings up to 72 ft., albeit with changes to the reinforcement design. Design of the system was dictated primarily by Strength I limit state. On a few occasions, service requirements for maximum spacing resulted in a different reinforcement selection. This was true for the region of the slab near the inflection points where moment demand, and consequently, design for strength, required limited amounts of reinforcement. Fatigue limit state did not govern design of the haunched section. Stress ranges were sufficiently low without the need for additional steel.

For design, an overbuild factor of 1.00 was sufficient. In two cases—the 56-ft. and 72-ft. designs—negative moment capacity was slightly less than demand at the end of span. However, the calculations did not consider minimum abutment depth of six feet. Section depth for moment capacity was based on depth of bottom steel, which indicated the same value used for positive moment calculations. For negative moment though, the top layer of steel is in tension and the lower portion of abutment is available for compression. By not accounting for this increase in section depth at the end of span, the section was assumed to have more negative moment resistance than provided by the calculations. For this reason, it was assumed the end span region has adequate capacity to resist the full bending moment in both cases.

Graphs of moment capacity and demand for each haunched section are presented here. A comparison of positive moment demand for all spans is shown. The same is shown for negative moment. Similarly, a comparison of the positive and negative moment capacity of each section, using both the existing reinforcement design and the new reinforcement design, is provided. This helped visually compare changes made to the design. Finally, a graph of capacity and demand for positive and negative moment is shown individually for all sections. Figure 3.34 shows the factored positive moment demand for all six spans.

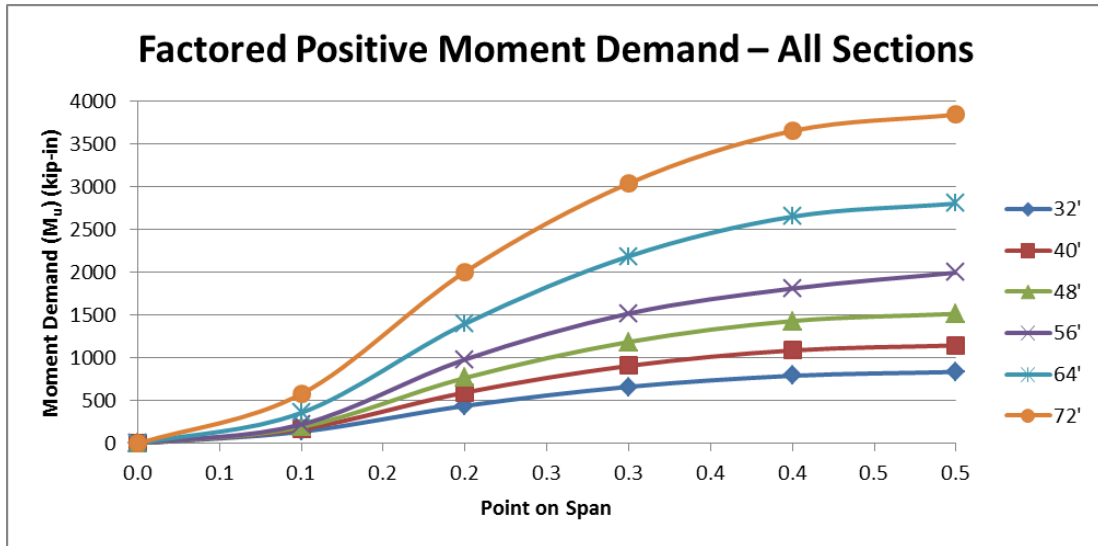

**Figure 3.34: Comparison of Factored Positive Moment Demand for All Sections**

Figure 3.35 shows the factored negative moment demand for all six spans.

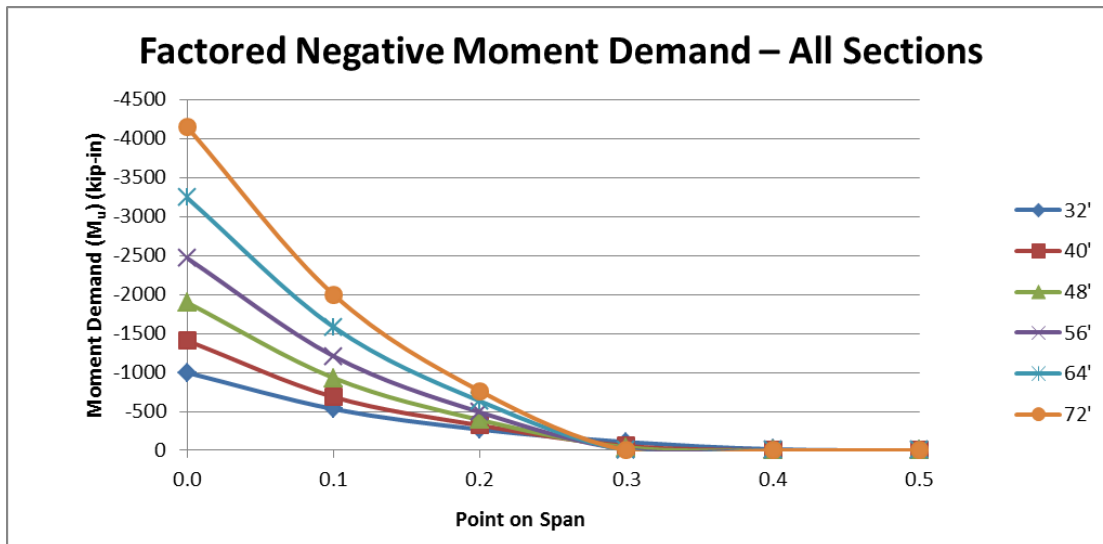

**Figure 3.35: Comparison of Factored Negative Moment Demand for All Sections**

These graphs show predictable trends in demand between different span lengths from structural analysis results. Figure 3.36 shows the factored positive moment capacity for all six spans using the center-span reinforcement design.

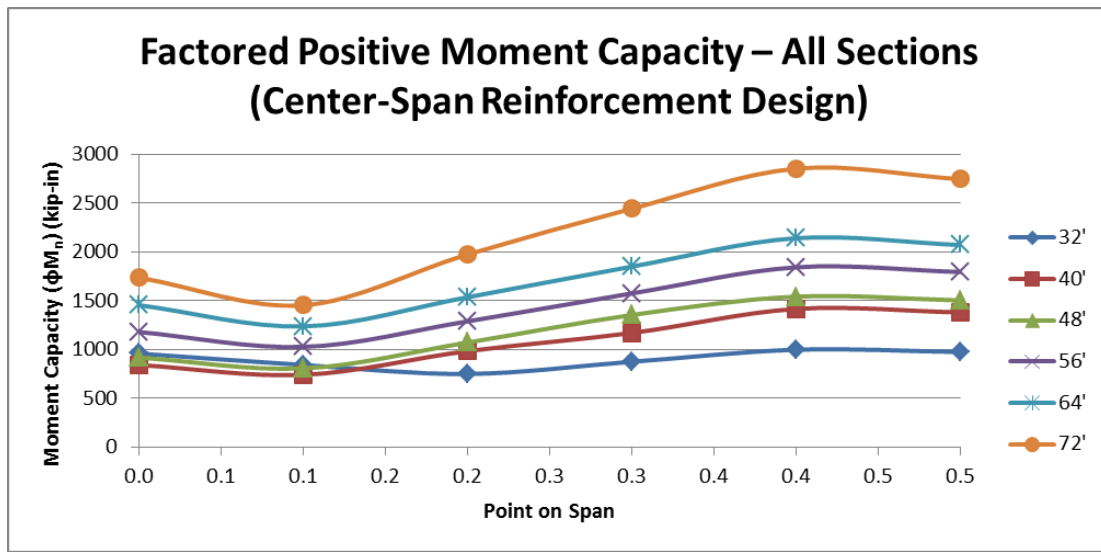

**Figure 3.36: Comparison of Factored Positive Moment Capacity for All Sections with Center-Span Reinforcement Design**

Contrary to prediction, plots for positive moment capacity cross one another in a two instances. The 32-ft. span is shown to have greater capacity than the 40-ft. and 48-ft. sections near the end of span. This was unanticipated since deeper sections are expected to have greater capacity than their shallower counterparts. However, existing design plans show that the 32-ft. span does not splice larger bars with smaller ones in that region. All other spans connect large bars to #4 bars near the pier. By avoiding this change, the 32-ft. span naturally maintains higher moment capacity, explaining this anomaly. Positive moment capacity was shown to increase near the end of span since the reinforcement is carried into the piers with a section of increasing depth. Figure 3.37 shows the factored negative moment capacity for all six spans using the center-span reinforcement design.

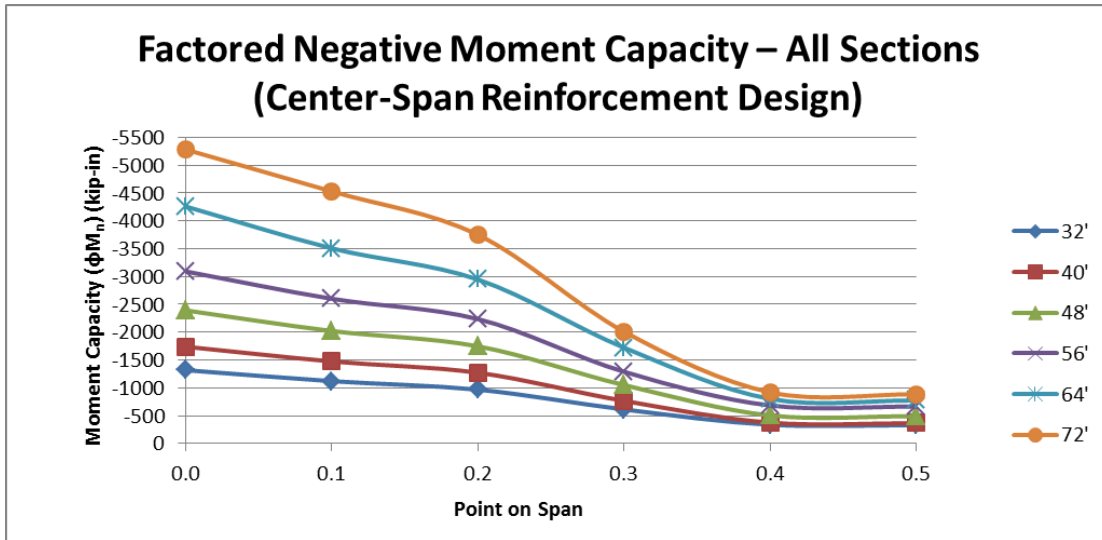

**Figure 3.37: Comparison of Factored Negative Moment Capacity for All Sections with Center-Span Reinforcement Design**

Figure 3.38 shows the factored positive moment capacity for all six spans using the new, single-span reinforcement design.

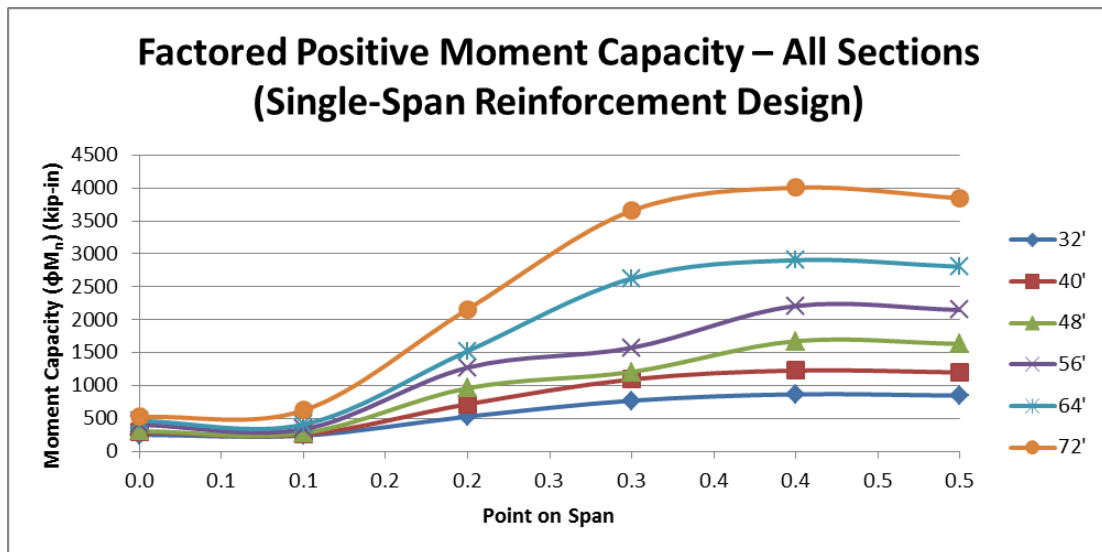

**Figure 3.38: Comparison of Factored Positive Moment Capacity for All Sections with Single-Span Reinforcement Design**

Figure 3.39 shows the factored negative moment capacity for all six spans using the new, single-span reinforcement design.

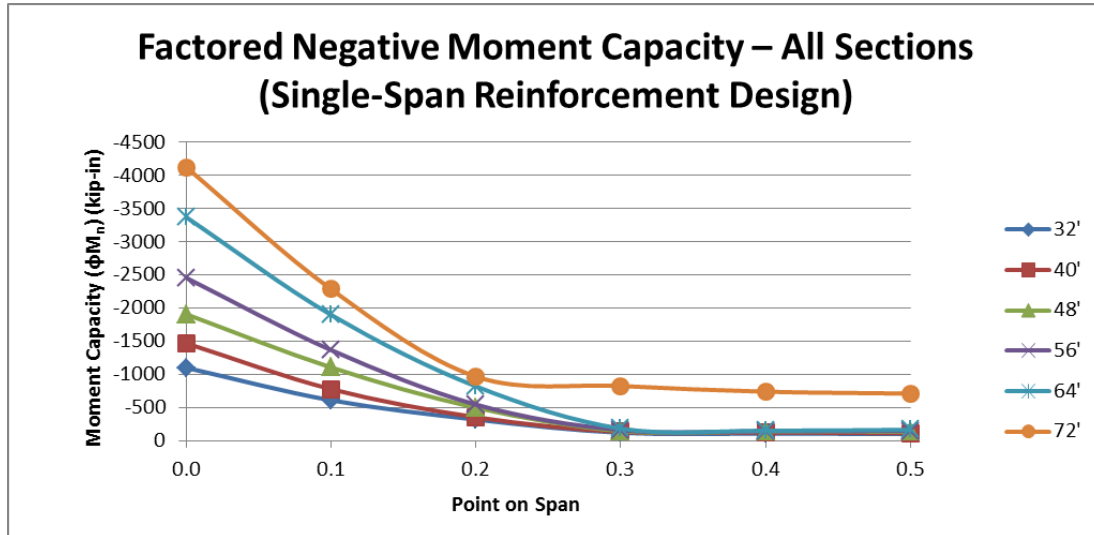

**Figure 3.39: Comparison of Factored Negative Moment Capacity for All Sections with Single-Span Reinforcement Design**

Redesigns for positive and negative moment provided smooth, predictable capacity curves. The 72-ft. span maintained a higher negative moment capacity at midspan than the other sections, since both the top and bottom steel were needed to satisfy Strength I limit state. Figure 3.40 shows the factored positive moment capacity and demand for the 32-ft. haunched slab with new, single-span reinforcement design.



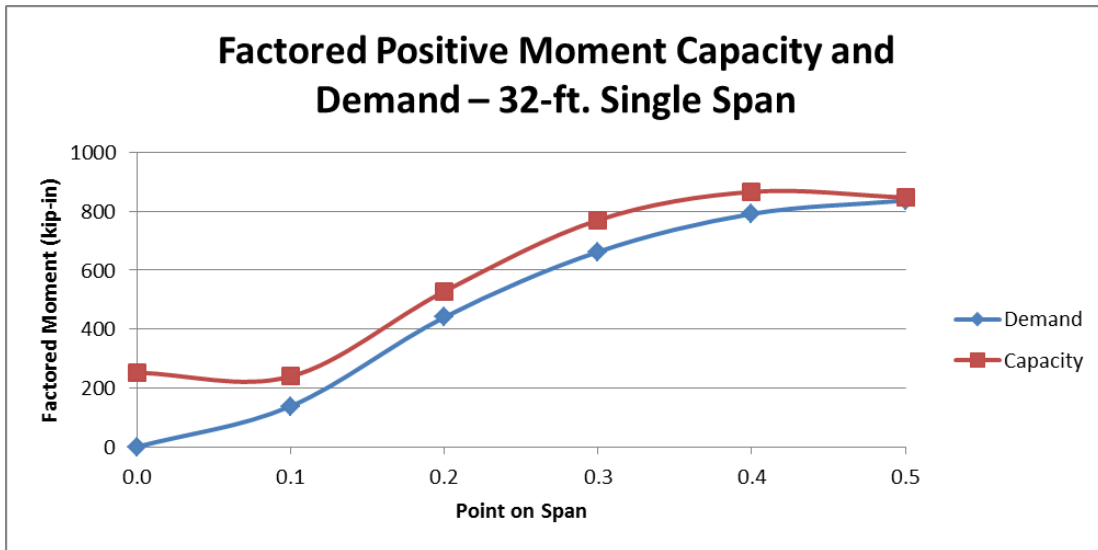

**Figure 3.40: Factored Positive Moment Design of 32-ft. Section**

Figure 3.41 shows the factored negative moment capacity and demand for the 32-ft. haunched slab with new, single-span reinforcement design.

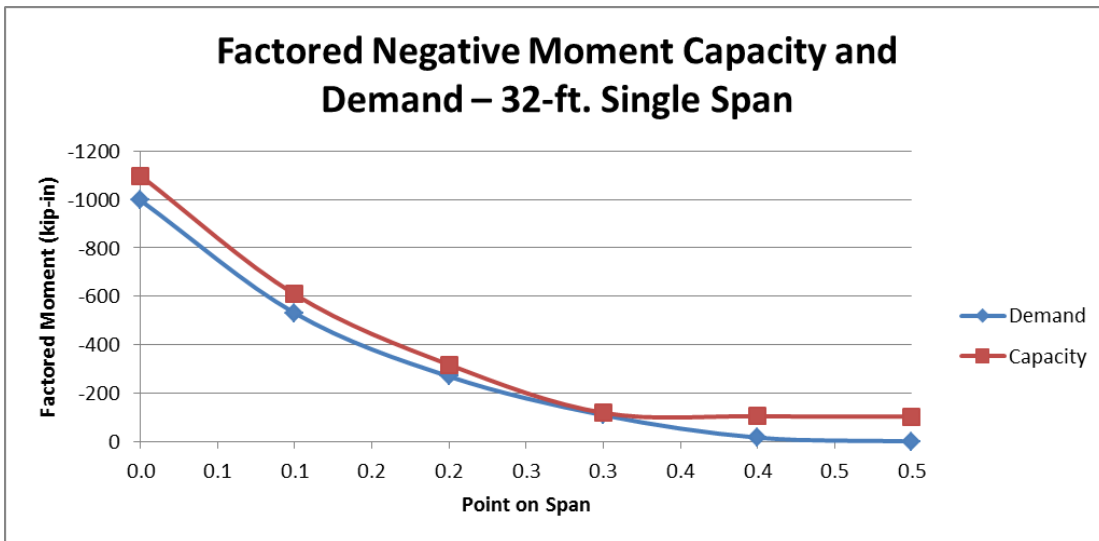

**Figure 3.41: Factored Negative Moment Design of 32-ft. Section**

Figure 3.42 shows the factored positive moment capacity and demand for the 40-ft. haunched slab with new, single-span reinforcement design.

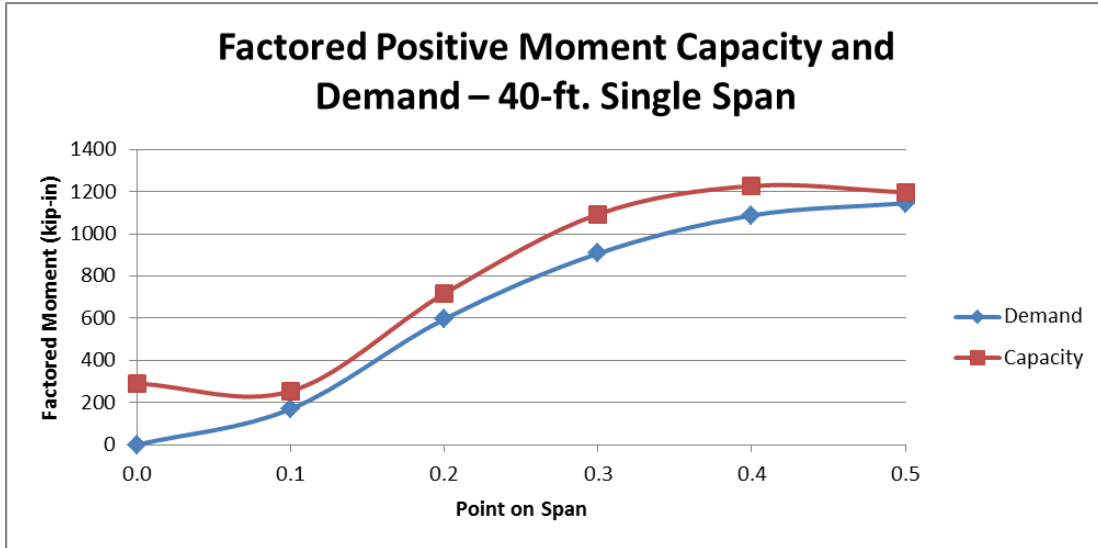

**Figure 3.42: Factored Positive Moment Design of 40-ft. Section**

Figure 3.43 shows the factored negative moment capacity and demand for the 40-ft. haunched slab with new, single-span reinforcement design.

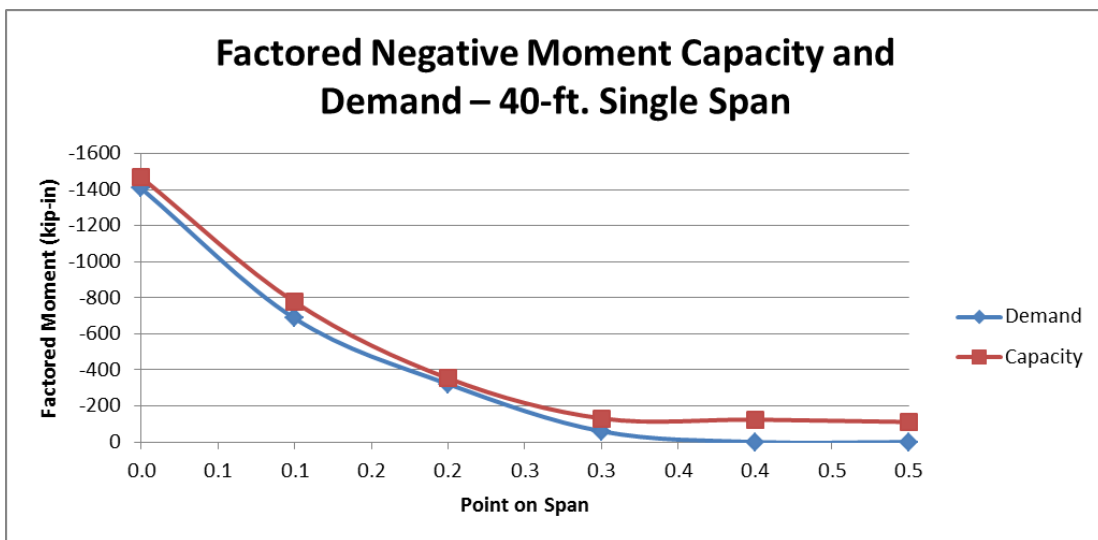

**Figure 3.43: Factored Negative Moment Design of 40-ft. Section**

Figure 3.44 shows the factored positive moment capacity and demand for the 48-ft. haunched slab with new, single-span reinforcement design.

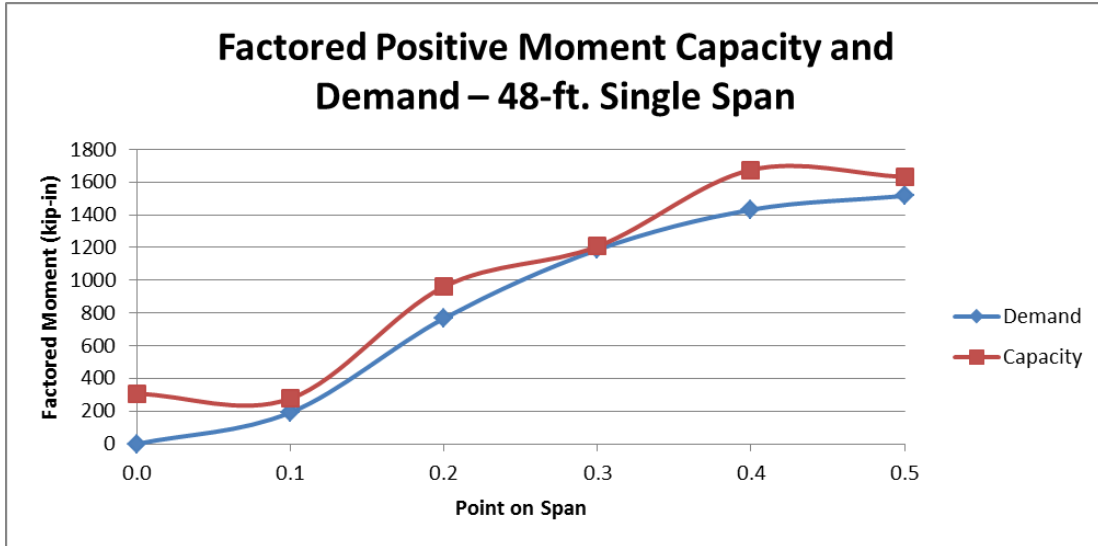

**Figure 3.44: Factored Positive Moment Design of 48-ft. Section**

Figure 3.45 shows the factored negative moment capacity and demand for the 48-ft. haunched slab with new, single-span reinforcement design.

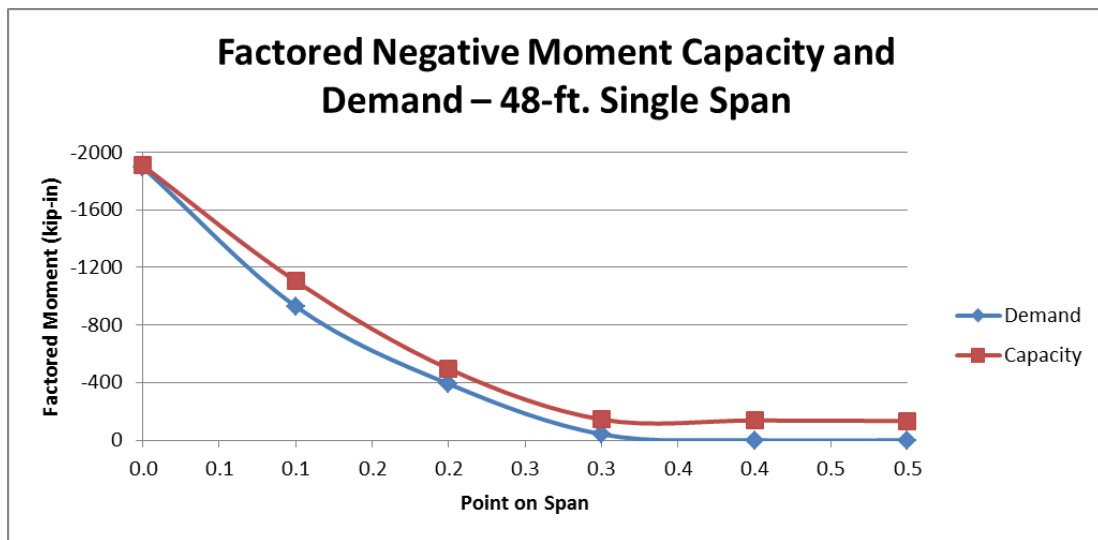

**Figure 3.45: Factored Negative Moment Design of 48-ft. Section**

Figure 3.46 shows the factored positive moment capacity and demand for the 56-ft. haunched slab with new, single span reinforcement design.

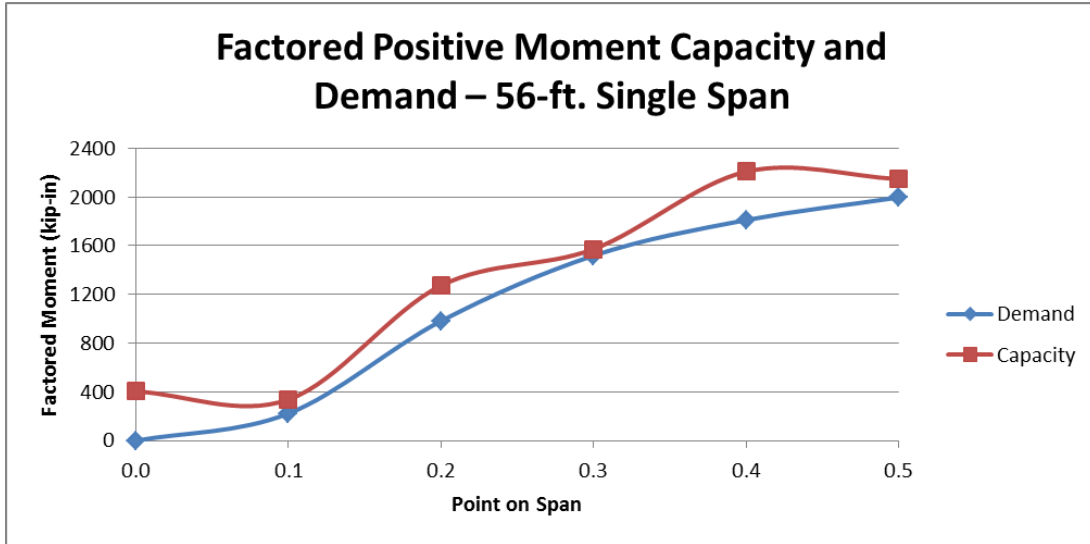

**Figure 3.46: Factored Positive Moment Design of 56-ft. Section**

Figure 3.47 shows the factored negative moment capacity and demand for the 56-ft. haunched slab with new, single-span reinforcement design.

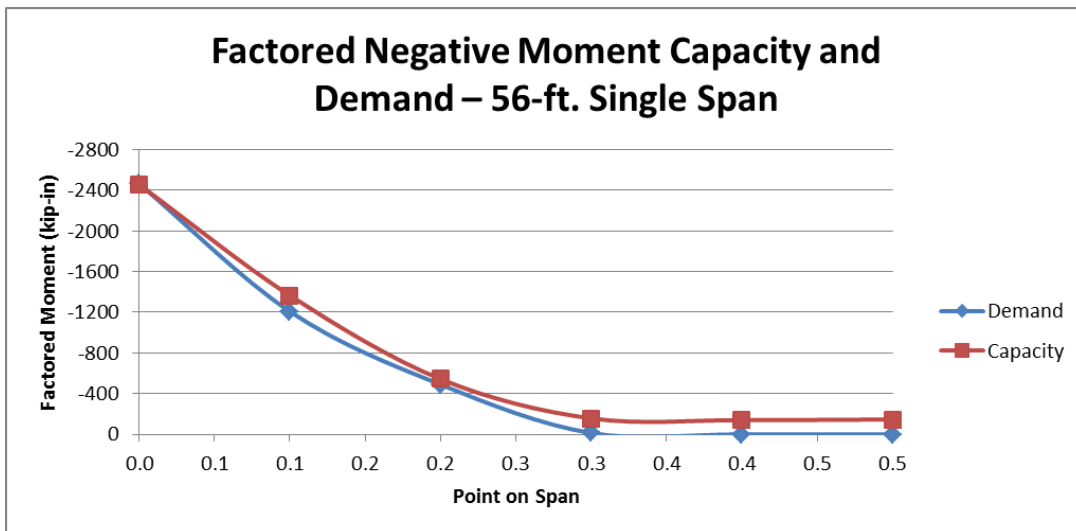

**Figure 3.47: Factored Negative Moment Design of 56-ft. Section**

Figure 3.48 shows the factored positive moment capacity and demand for the 64-ft. haunched slab with new, single-span reinforcement design.

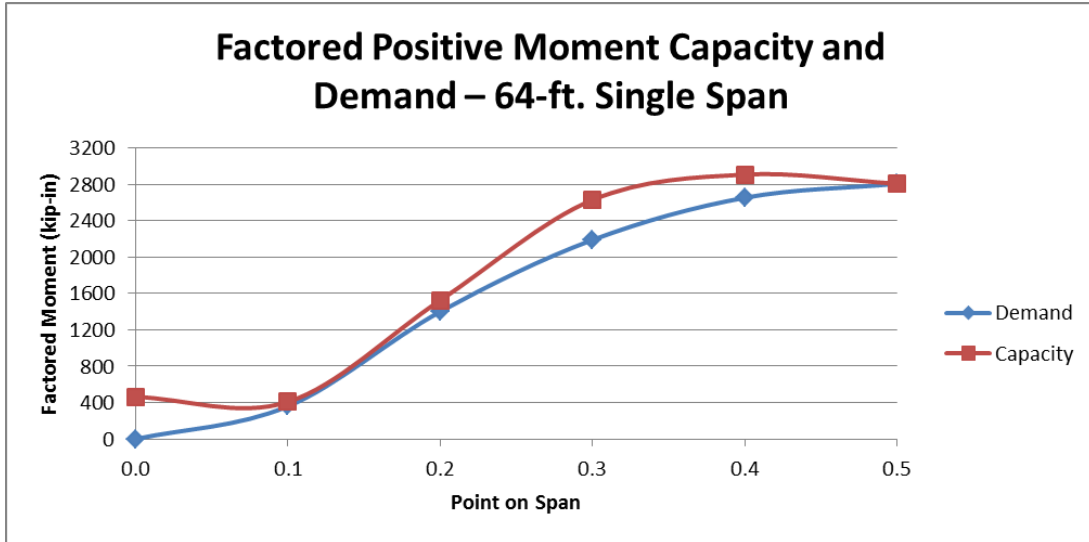

**Figure 3.48: Factored Positive Moment Design of 64-ft. Section**

Figure 3.49 shows the factored negative moment capacity and demand for the 64-ft. haunched slab with new, single-span reinforcement design.

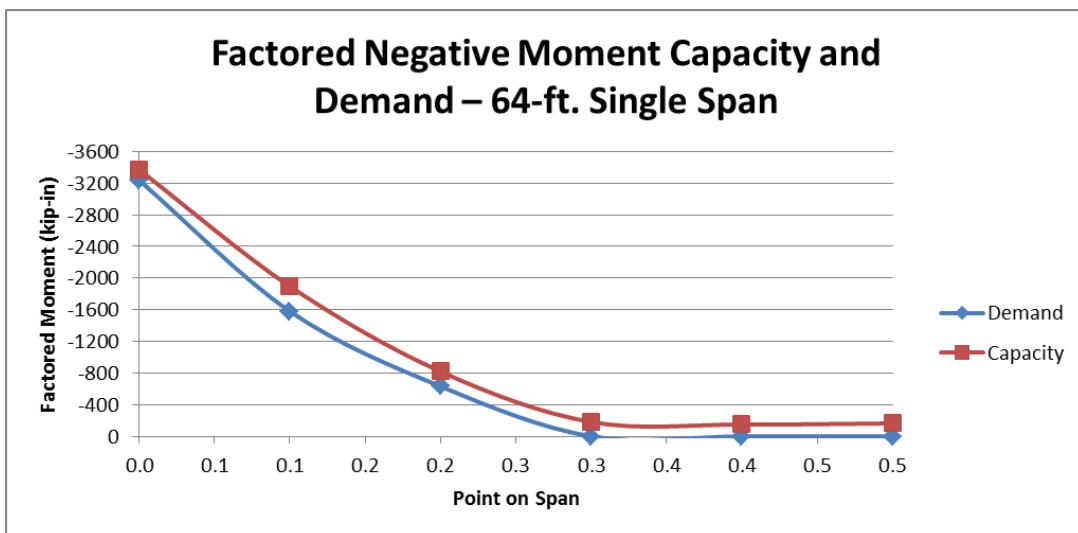

**Figure 3.49: Factored Negative Moment Design of 64-ft. Section**

Figure 3.50 shows the factored positive moment capacity and demand for the 72-ft. haunched slab with new, single-span reinforcement design.

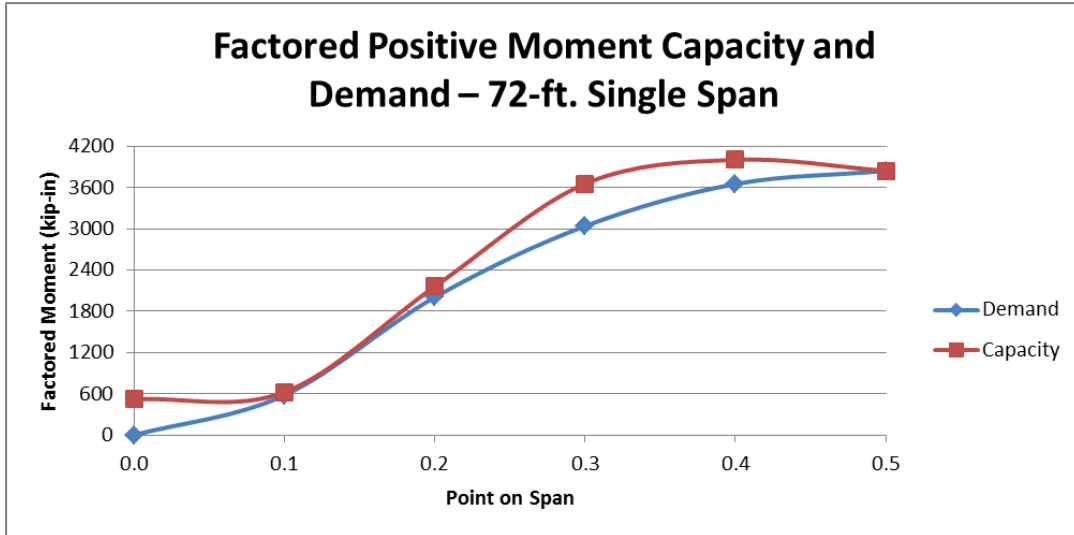

**Figure 3.50: Factored Positive Moment Design of 72-ft. Section**

Figure 3.51 shows the factored negative moment capacity and demand for the 72-ft. haunched slab with new, single-span reinforcement design.

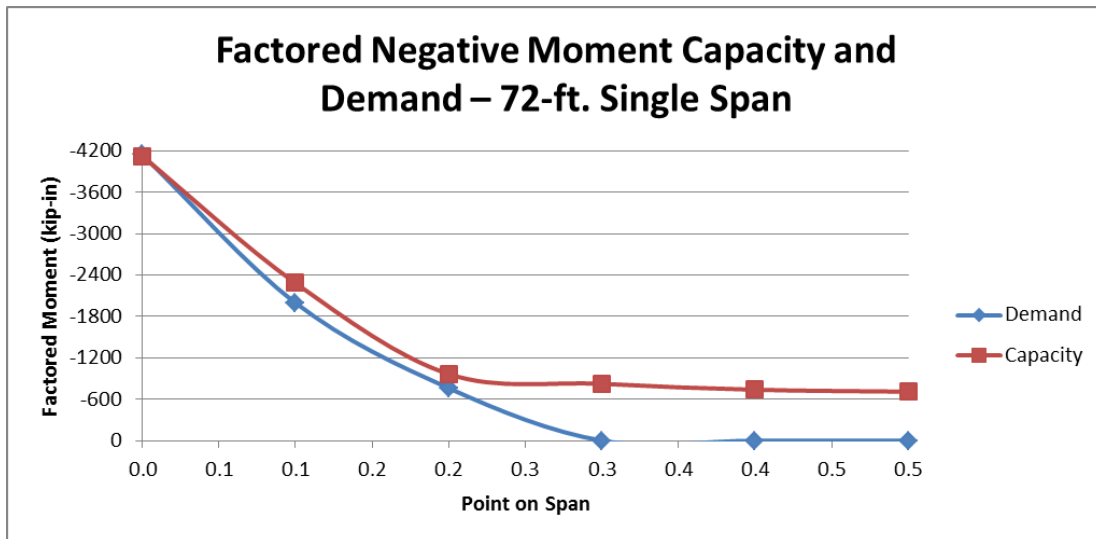

**Figure 3.51: Factored Negative Moment Design of 72-ft. Section**

### *Design Drawings for the Haunched Profiles*

This subchapter shows design drawings for the single-span, haunched-slab bridge system. Figures are provided for each span of the system in plan and section views. The drawings display the longitudinal reinforcement pattern selected in the design phase of the project. For clarity, only part of the reinforcement is shown, thereby making the drawings less cluttered. Plan view separates the structure and demonstrates the reinforcement design for the top and bottom of the slab. Section view is likewise separated showing the longitudinal reinforcement design at the abutment and midspan. Reinforcement design is doubly symmetric about midspan and centerline of each bridge.

Drawings are shown for the 28-ft.-wide roadway. As the narrowest roadway, the influence of design load was greater on this section than for wider bridges. Thus, a reinforcement design that satisfied the 28-ft.-wide section was sufficient for all others of the same span. For simplicity, size and spacing of bars for the 28-ft.-wide bridge were repeated on all other widths. The same pattern was extended to account for the additional width of roadway for these designs. Wider sections were not shown to avoid repetition of similar designs.

To account for width of the abutments, total structural length for all systems is three feet longer than the specified span length. The width of each structure is two foot greater than the specified roadway width. This accounts for placement of the railing. The section below the railing uses a different design than the roadway section. The portion of the bridge under the railing was not considered in preliminary design, therefore no rebar is shown in that location on the drawings. The provided reinforcement is intended to satisfy the needs for traffic within the roadway only.

Dotted lines indicate the centerline and inside face of the abutment, and centerline of the bridge in their respective locations. Bar splice locations were indicated by overlap of the bars.

Bar splice lengths and exact locations are not calculated in preliminary design. The splices show the connection of two different bar sizes. Location of the splice simply indicates the tenth-points between which the splice occurs. The termination point of each rebar is not indicated by drawings. Rather, the termination points shown specify the tenth-point by which each bar must be fully developed. Development length was not calculated in preliminary design. Figure 3.52 shows the reinforcement design for the 32-ft., haunched-slab section in plan view.

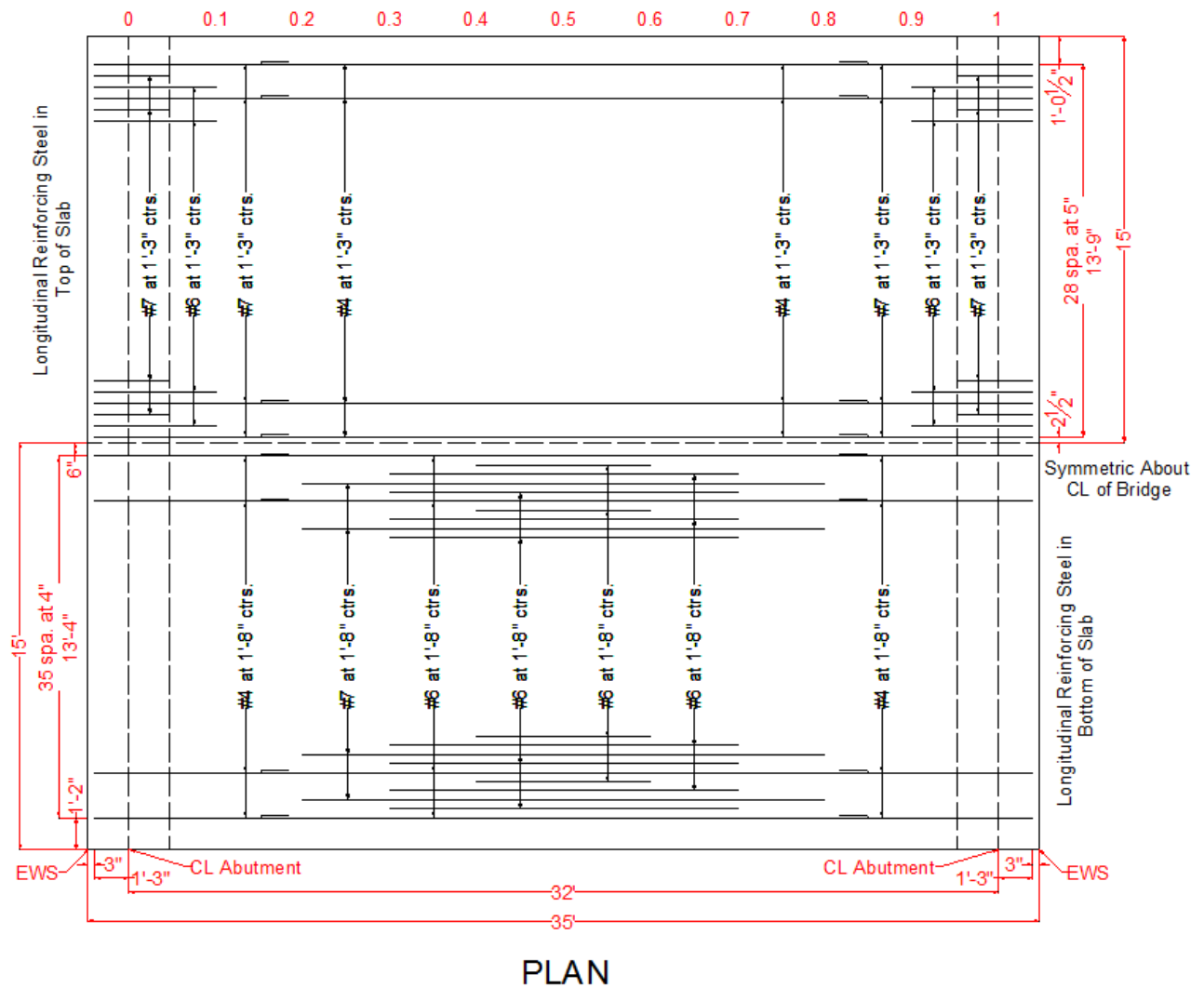

**Figure 3.52: Plan View of 32-ft., Haunched-Slab Section**



Figure 3.53 shows the reinforcement design for the 40-ft., haunched-slab section in plan view.

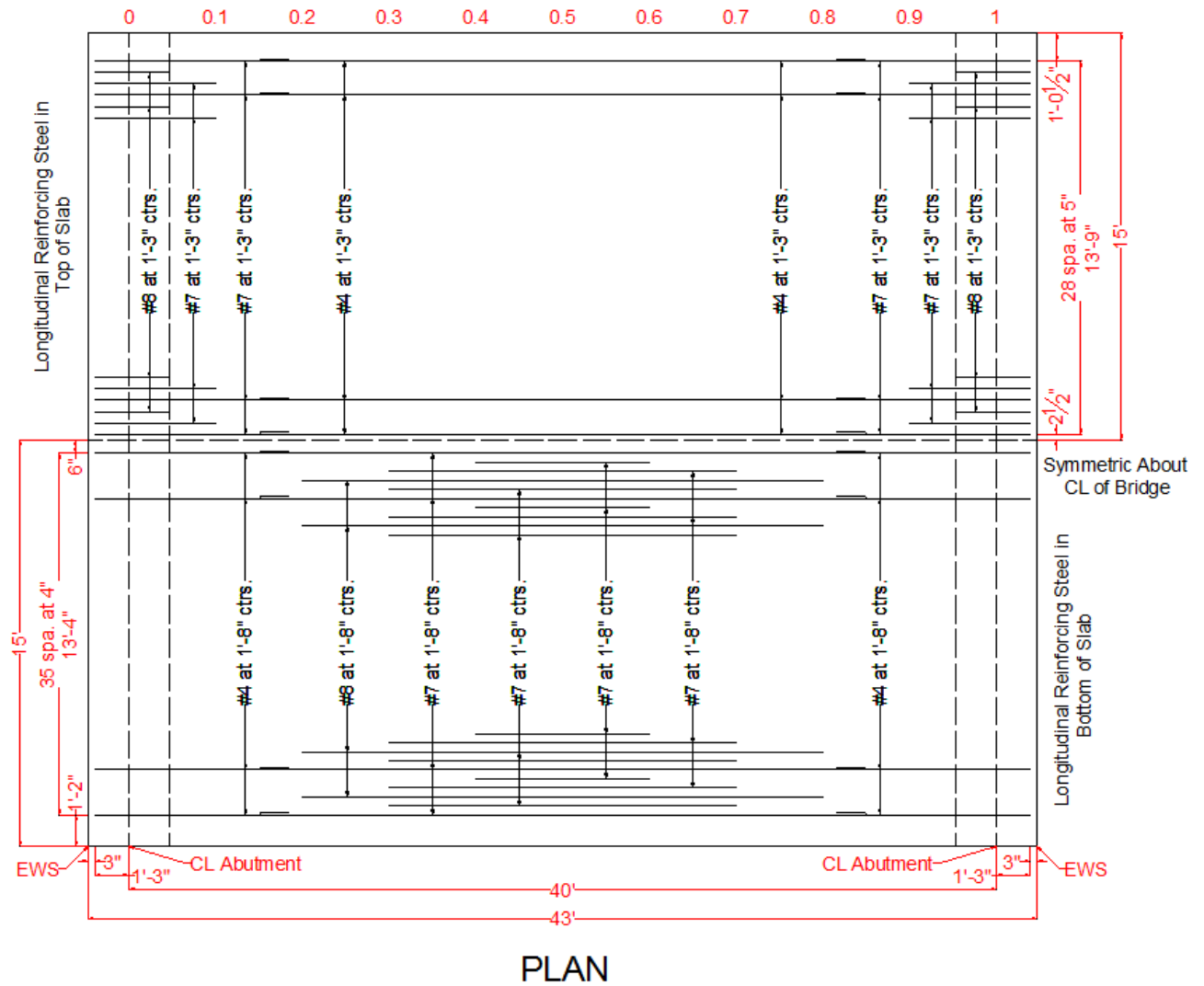

Figure 3.53: Plan View of 40-ft., Haunched-Slab Section

Figure 3.54 shows the reinforcement design for the 48-ft., haunched-slab section in plan view.

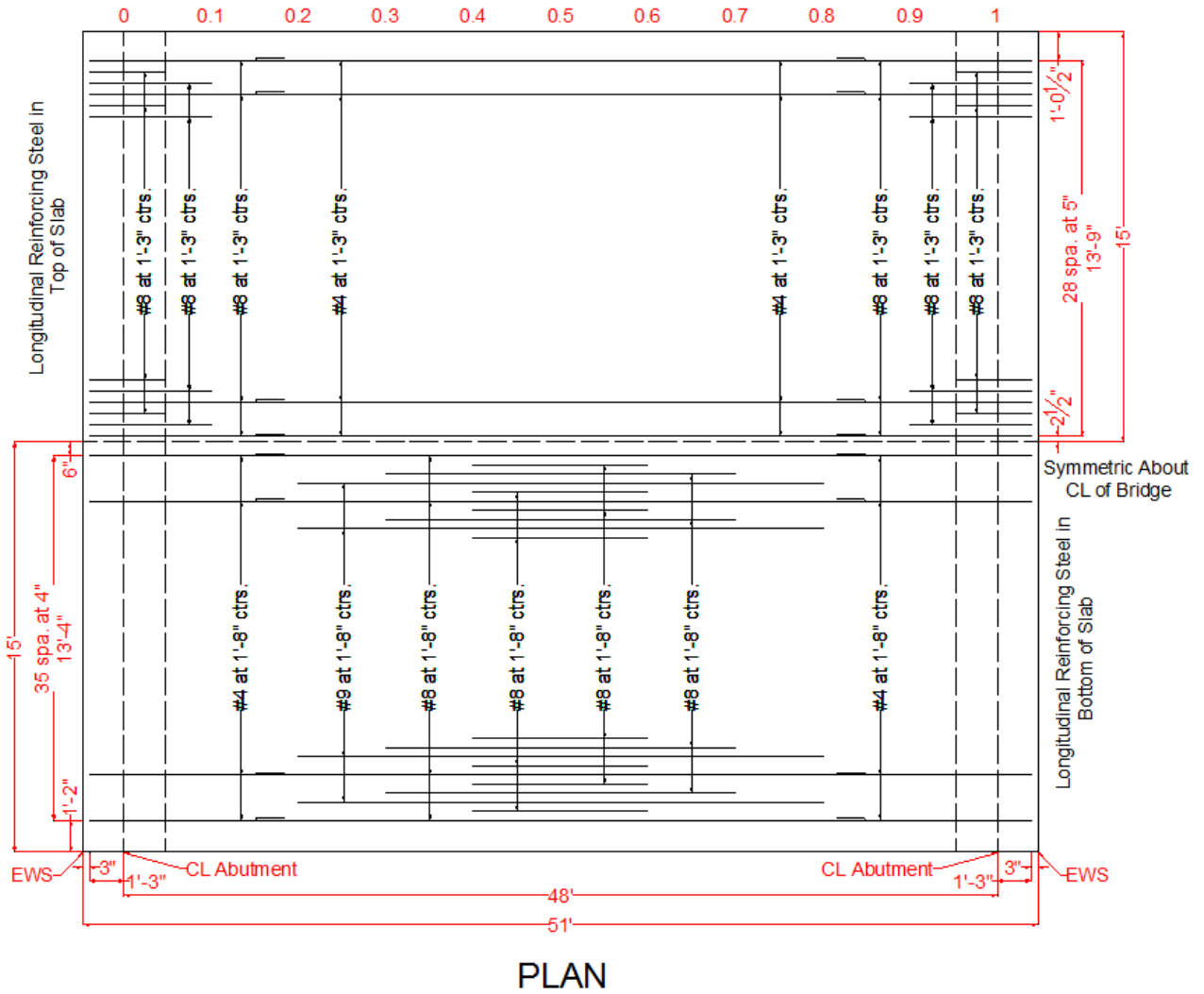
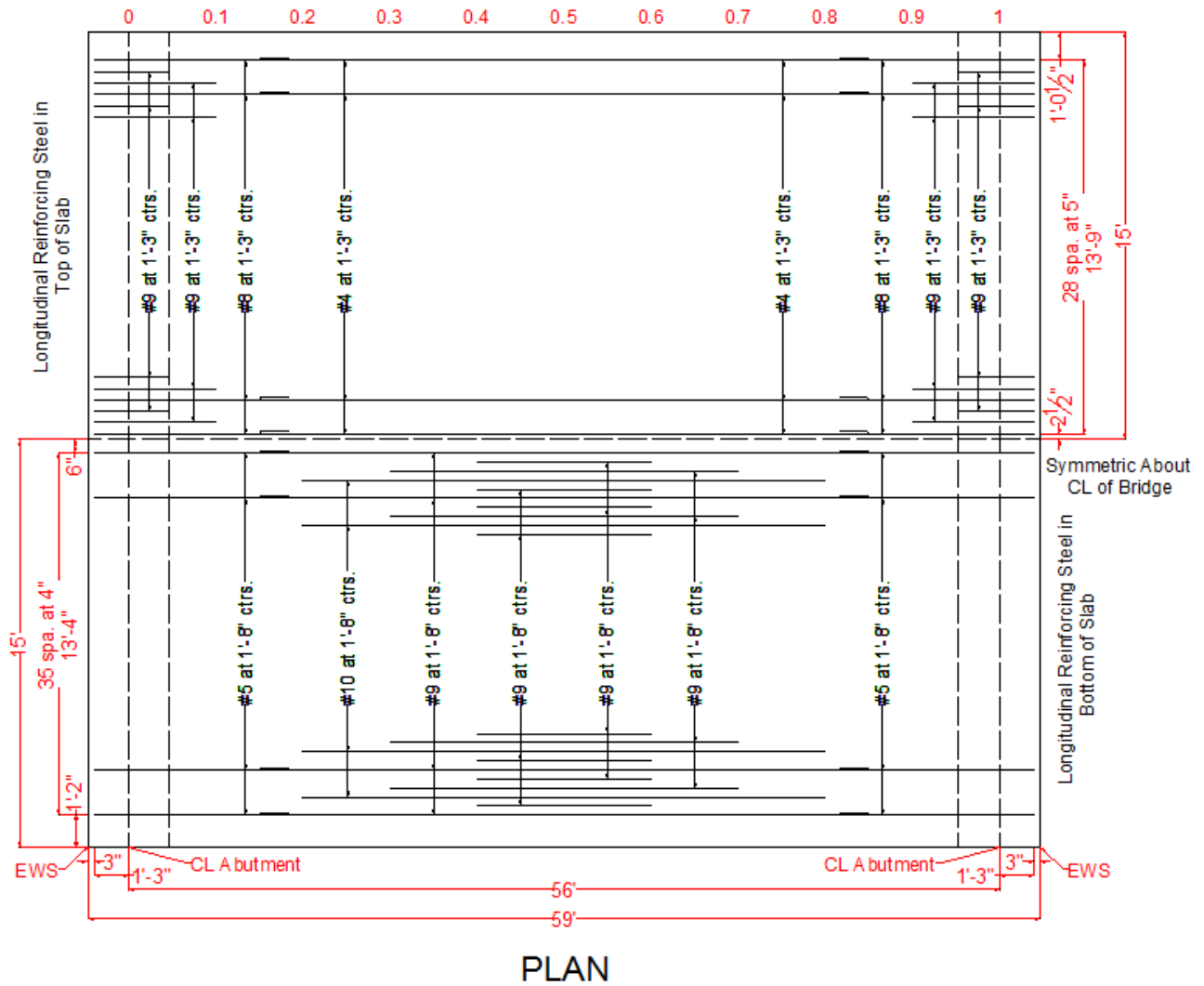

Figure 3.54: Plan View of 48-ft., Haunched-Slab Section

Figure 3.55 shows the reinforcement design for the 56-ft., haunched-slab section in plan view.



**Figure 3.55: Plan View of 56-ft., Haunched-Slab Section**

Figure 3.56 shows the reinforcement design for the 64-ft., haunched-slab section in plan view.

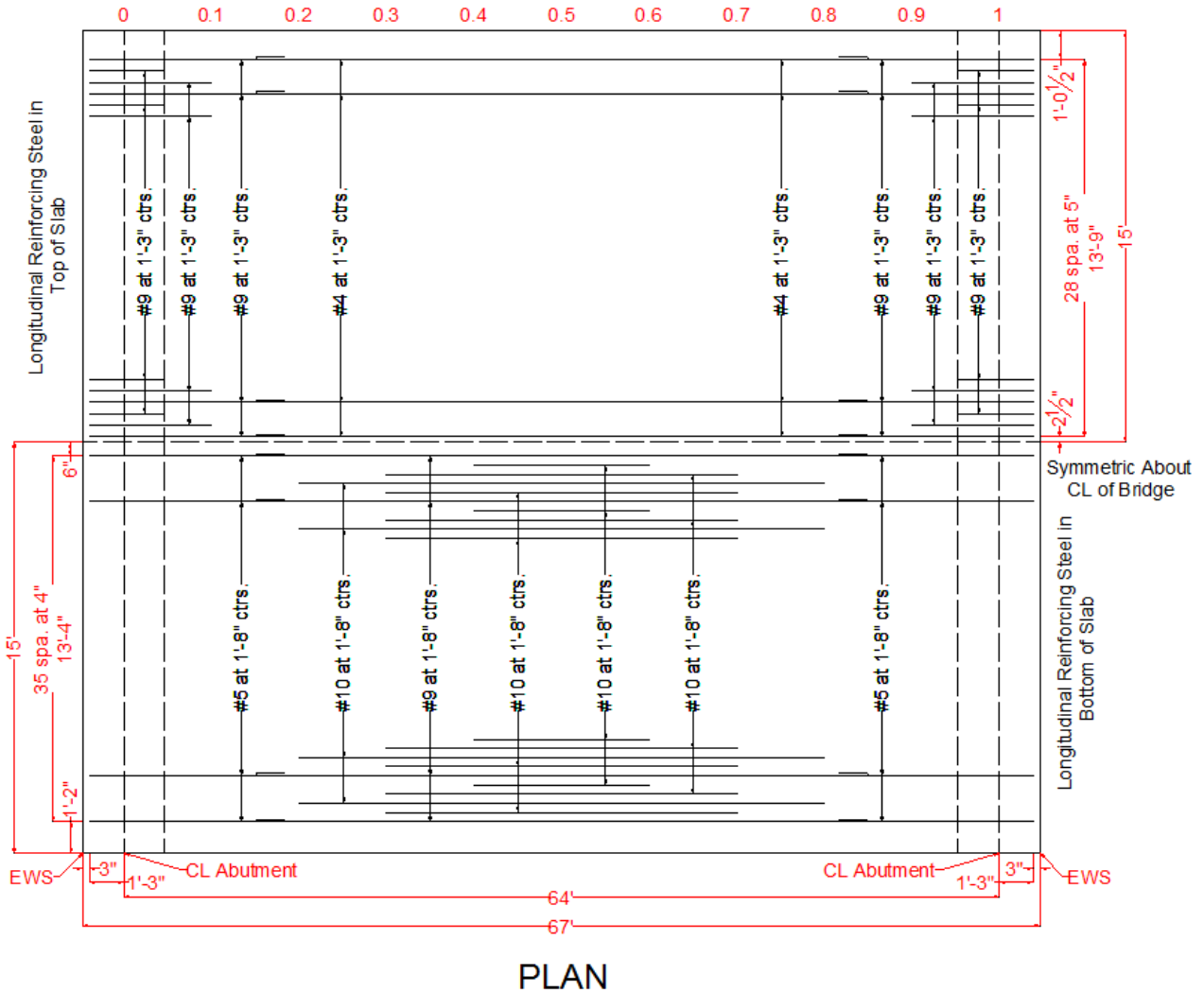
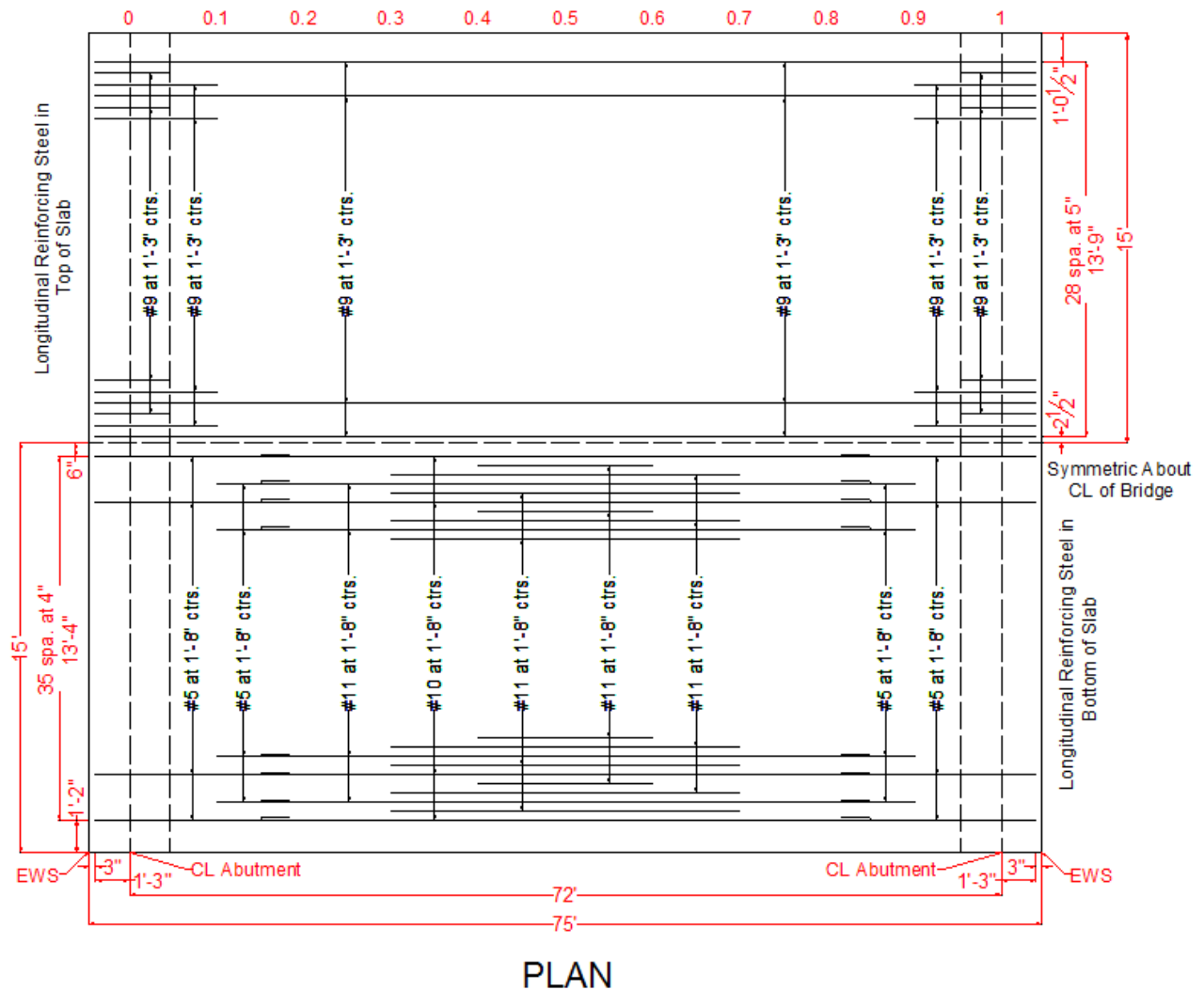

Figure 3.56: Plan View of 64-ft., Haunched-Slab Section

Figure 3.57 shows the reinforcement design for the 72-ft., haunched-slab section in plan view.



**Figure 3.57: Plan View of 72-ft., Haunched-Slab Section**

While the bar sizes changed with span length, the overall pattern and spacing remained consistent for all structures in the system. Thus, the same cross-sectional detail is applicable to all spans. Figure 3.58 shows the reinforcement design of all 28-ft.-wide roadway sections in section view. A cross slope of 1.60% was used in all cases.

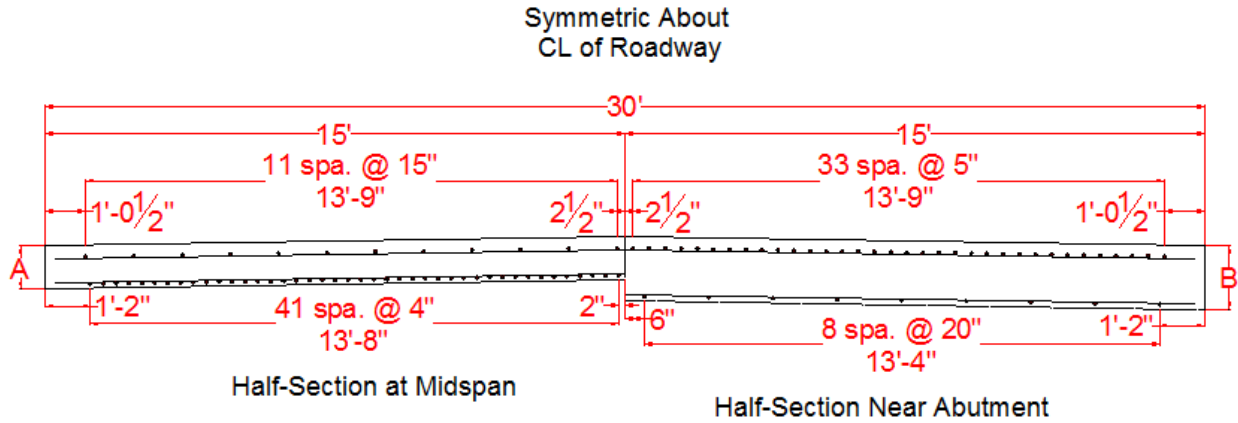

## TYPICAL SECTION OF SLAB

**Figure 3.58: Section View of 28-ft.-Wide Roadway**

Variables A and B correspond to the depth of the slab at midspan and the abutment. Since the slab was integral with the abutment, it technically cannot be differentiated as a unique element at that location. Nonetheless, a value for section depth was needed for flexural design at that location. While the abutment extended to at least a depth of six feet, only the depth corresponding to the theoretical location of the parabolic haunch was used for design at the end of span. Table 3.39 shows these dimensions.

**Table 3.39: Section Depths at Midspan and Abutment**

|             | A                     | B                      |
|-------------|-----------------------|------------------------|
| Span Length | Depth at Midspan (in) | Depth at Abutment (in) |
| 32'         | 13.50                 | 19.88                  |
| 40'         | 14.50                 | 21.69                  |
| 48'         | 15.10                 | 23.44                  |
| 56'         | 16.50                 | 25.44                  |
| 64'         | 18.50                 | 31.19                  |
| 72'         | 20.50                 | 37.00                  |

## **Chapter 4 - Discussion of Precast Solution**

The cast-in-place, single-span, hunched-slab bridge developed in the previous chapter satisfies the requirements for a traditionally constructed, durable, efficient, short-span system. As an alternative to this option, a system intended to minimize construction time was also investigated. This option uses precast concrete and was developed to meet ABC requirements. Reducing user costs associated with detours, delays, and road closures is important to consider when selecting a new or replacement bridge system. However, its costs and benefits must be balanced against those of traditionally constructed facilities when the system is ultimately selected.

The Kansas bridge market makes use of rapidly constructed facilities less often than their traditionally constructed counterparts. Based on the direction of KDOT Bridge personnel, research and design of this type of facility has been de-emphasized within the scope of the project. Nonetheless, an ABC option will still be discussed. Structural analysis and detailed design will not be performed for this structure in this project. Instead, the system and a rationale for its selection are presented based on research provided in the literature search.

Additionally, input from local Kansas precasters was sought to obtain background information regarding economics, ease of fabrication, transportation, and constructability issues for the proposed system. Thus, the selected system will have demonstrated successful use in short-span environments in other states and show potential to perform acceptably in the context of the Kansas bridge environment. Details pertaining to development of the precast option are presented in the following subchapters.

## **Performance Characteristics of Precast Bridge System**

As with the cast-in-place design, constraints on the system must first be identified. Span lengths considered for the precast system are the same as for the cast-in-place option. Waterway openings in the 32-ft. to 72-ft. range remain excellent candidates for use of single-span, precast products. Similar to cast-in-place structures, the precast system must conform to performance characteristics and requirements presented in the previous chapter. Hydraulic and environmental guidelines remain most important in the system's selection and design.

To minimize potential for hydraulic and environmental externalities, use of an oversized, single-span system with substructural elements placed outside the natural channel is again recommended. Oversizing reduces the possibility of waterway constriction and associated effects of contraction scour before, during, and after the stream passes through the structure. Of course, by avoiding a slab in the channel and adhering to all previous hydraulic and environmental guidelines, the new system is expected to properly facilitate AOP.

As a possible drawback to their use, precast superstructures are not monolithic with their substructures. The connection between the precast superstructure and abutment will likely be initially hinged, thus losing the ability to transfer moment due to self-weight between the two elements. Without the benefit of dead load moment transfer, the system will be less slender and structurally efficient than its cast-in-place counterpart. Loss of slenderness is particularly unfortunate since limited headroom may dictate design when height of the waterway opening is minimal. It is undetermined how many situations this will affect, however.

To mitigate loss of continuity between the superstructure and substructure, the span can take advantage of prestressing to make the system more structurally efficient. If acceptable to the bridge owner, prestressed materials will allow reduction in section depth, providing greater freeboard for the river or stream. If concerns over negative moment in a river environment



prevail, the system may still come without prestress. Regardless of this condition, a positive connection should be provided between the superstructure and abutment to prevent washout in flood conditions.

### **Substructural Details for Precast Bridge System**

Due to structural sizes under consideration and presence of a natural channel bottom, the system should rest on a deep foundation. As with a traditional bridge, piles connected to an ordinary abutment will be acceptable substructural components for the precast system, just as for the cast-in-place option. Due to close proximity of the waterway, GRS-IBS will not be considered without an accompanying deep foundation.

The abutment used in the precast system will be different from the one used in the cast-in-place system since the superstructure will not be integral with substructural elements. However, a similar design concept would be acceptable. The abutment may be cast-in-place or precast. A cast-in-place abutment may be used since Kansas bridges don't typically use precast substructures even if superstructures are precast. This design helps satisfy some of the durability concerns associated with precast bridges in Kansas but does not capture full ABC benefit.

As an alternative, a precast abutment could be used, similar to substructural elements found in Texas and Washington, as described in the literature search. Precast abutments have proven successful elsewhere and have the same potential in Kansas. Based on research in those states, connection between the abutment and piles can be achieved through use of a welded embedded-plate or grout pockets. Precast abutments naturally assist in accelerating bridge construction.

Regardless of abutment type, a positive connection is formed with the piles. Determining the means of connection is avoided if cast-in-place abutments are used. Similar to the cast-in-

place system, the abutment can take the form of a beam or wall element, depending on the height of the structure. Shorter waterway openings may dictate use of a shallower abutment beam, while taller openings may require use of an abutment wall. Construction in the stream or river environment suggests mitigation of scour risk. In order to avoid exposure of piles after soil erosion, extending the depth of the abutment element below the design scour depth may be good practice. If deemed excessive, placement of an alternative scour protection material such as riprap or sheet piles is recommended.

### **Comparison of Available Precast Superstructural Options**

With selection of the substructural components finalized, a superstructural system must be chosen. The literature search demonstrates that voided-slab, single-tee, double-tee, inverted-tee, box-girder, and I-girder sections are typically the best fits for the span range of this project. All these sections have been successfully used in short-span applications in other states. Steel sections are not likely to be as economical for spans as short as those considered here. Thus, they have been excluded from further research. A discussion of potential options is presented here.

Since Kansas already has design standards for I-girders and inverted-tee beams, they will not be discussed further. Box girders have the disadvantage of difficulty of inspection. Since the system is enclosed, maintenance staff is unable to inspect inside portions of the section to visually verify the condition of the structure. Due to safety risks posed by this maintenance challenge, box girders will not be considered appropriate for this project. Voided slabs have the same maintenance issue as box girders. Voids in the slab are analogous to the voids in the box section. Naturally, the voids cannot be inspected either. For this reason, voided slabs will not be developed in this project either.

Remaining options consist of the single- and double-tee beams. Both sections achieve similar structural efficiency and may be used for the same span lengths. There are inherent advantages and disadvantages to both options. Both are free of the maintenance and inspection problems discussed previously. They also have application in parking garages, buildings, and other facilities, satisfying precaster concerns for finding a large enough market for the product. A major disadvantage is the relative lack of structural efficiency of these systems. The span-to-depth ratio for single- and double-tee beams is low compared to most competing short-span sections. If headroom is an issue, application of these systems may be a challenge.

Nonetheless, these sections have been successfully implemented in other states. Single-tees can easily be modularized in four-foot widths. Since roadway widths for the project increase in four-foot increments, a four-foot-wide modular section would be especially fitting. Provisions must still be made for the width of railing, which is not included in the roadway. Since the railing must be connected to the section, special considerations must be made for an end section, regardless of whether the railing is cast integral with the section or not. A single-tee system could be developed using two sections: a four-foot-wide modular section to be used for the main portion of roadway and a five-foot-wide end section that integrates the railing.

A major drawback to use of a single-tee section is difficulty of transport. Single-tees are inherently unstable when placed upright, so extra care is required before, during, and after transportation to the construction site. Additionally, a bridge will require six to 11 modular sections depending on width of the roadway. More sections require more transverse joints. Durability concerns associated with joints is potentially the most significant drawback to any precast system. Thus, a system with a large number of joints is less suited for use in the Kansas bridge environment.

To contrast with the single-tee, the double-tee section addresses many of these concerns. The double-tee is stable, making transportation, maneuvering, and placement at the construction site a simpler task. A double-tee will be approximately twice as wide as a single-tee, reducing the number of sections needed to form the full bridge. Reducing the number of sections is beneficial for two important reasons. First, fewer joints are required, improving the system's durability. Second, fewer sections allow the construction to be completed quicker, reducing user costs and serving as a more beneficial system in the spirit of ABC criteria.

The double-tee is not without drawbacks, however. Typical modular widths are roughly eight feet. Eight-foot-wide modular sections do not fit as well as single-tees based on the incremental increases in roadway widths. If the system uses double-tees, a different end section will still be required to accommodate placement of the railing. Modular widths of eight feet will facilitate wider shoulders than required in some cases. Though advantageous from a safety perspective, this practice is less economical. While reducing the number of sections is beneficial from a durability standpoint, it causes difficulty for precasters who seek to benefit from economies of scale in production. Less production yields less economy.

Weight of the sections becomes a concern as span length increases. Some portions of the state have limited access to large cranes for placing members. Limiting the weight of each modular section to 20 tons increases the likelihood the system can be constructed throughout the entire state. This restriction may be an issue for long double-tee sections. Single-tees will not possess this disadvantage. Nonetheless, preliminary design of a double-tee system would verify if weight becomes excessive for longer spans.

## **Selection of Precast Superstructure**

Based on a qualitative comparison of the two options, the author suggests the double-tee section as the recommended precast solution. Since durability is such an important issue, minimizing the number of joints is possibly the best advantage of the system. Further support for this selection is the widespread use of double-tees, such as the NEXT Beam, throughout the Northeast. Bridges in that region are designed with the same concerns in mind, namely, reduced traffic delay, lower project costs, ease of construction, improved chemical and physical durability, and longer service life.

To address other concerns with the double-tee, excessive bridge width in some cases is only a mild disadvantage since it can be offset with increased user safety. While certain economic aspects may be less favorable, use of a precast system indicates that project cost is not the most important factor under consideration. With bridge owner approval, use of prestress will reduce section depth and address limited headroom issues. While minimizing fabrication costs is desirable, balancing this with other concerns is necessary.

The double-tee section could use two different designs. Similar to the NEXT Beam, the system could contain a partial-depth flange or a pre-topped, full-depth flange. The partial-depth flange requires placement of a bridge deck on the construction site. While a cast-in-place deck decelerates construction, it does provide a sufficient transverse connection for adjacent members such that mechanical connectors are not required. It possesses another important benefit for transportation and placement. By having a minimal precast flange, weight of the section is reduced. This may be of value for longer spans in parts of the state that have limited access to large cranes.

The alternative full-depth option utilizes a thicker, more robust flange. It does not require a concrete deck to be placed in the field. This option reduces the number of components required

in the bridge system. Since a cast-in-place deck is unnecessary, this option further reduces field construction time and facilitates ABC practices. For shorter spans, the weight of the full-depth section will not likely prohibit its use. Use of the full-depth flange will require transverse mechanical connections for adjacent members.

The literature search demonstrates use of a few different options for transverse connections. Common transverse connections include grouted shear keys, grouted rebar connection, welded embedded-plates, and post-tensioning. All have been implemented successfully in several states. Post-tensioning is likely the most undesirable of all options due to additional project costs associated with high-grade materials. The other three have shown beneficial performance.

Grouted shear keys are a relatively simple joint, but the keys are prone to shear failure. Grouted rebar connections are used on robust systems such as the NEXT Beam and Minnesota inverted tee. Forming these connections at the plant is more difficult, but testing and empirical use has demonstrated them to be good performers. Welded embedded-plate connections have been used on the Minnesota inverted tee and various Texas projects. Like the grouted rebar connections, they have succeeded under experimental and real-world load conditions. Research has shown a number of viable joint options are available. Since this portion of the project has been de-emphasized, the author is not prepared to make recommendations for joint design. More research specific to this topic is needed for this decision.

Another requirement of the system is to have a mechanical connection between the superstructure and abutment. One option for achieving this is applying the welded, embedded-plate connection between adjacent sections as suggested for the abutment-to-pile connection. Steel plates can be embedded into the abutment and interfacing portions of the double-tee beam.

The plates can be field-welded providing the positive connection needed to prevent the superstructure from being carried away during a flood event.

### **Summary of Precast System**

The precast system selected for recommendation as a short-span bridge system uses a set of modular double-tee beams. The beams can use a pre-topped, full-depth flange or partial-depth flange. The full-depth flange serves as the bridge deck and facilitates faster construction. However, the full-depth flange requires transverse connections. The partial-depth flange requires a cast-in-place deck topping in the field, but does not use transverse connections. A few successful options for connections include grouted shear keys, grouted rebar connections, and welded embedded-plates.

The substructure uses traditional bridge abutments. These may be cast-in-place or precast. One-piece or multi-piece, precast abutments can further accelerate bridge construction. These abutments sit on pile foundations. Connections must be used for all adjacent elements in the substructure. Both the beam-to-abutment and abutment-to-pile connection can make use of the same welded embedded-plate concept. In either case, steel plates are embedded into the face of each concrete element. Adjacent plates can be welded together connecting the beam and abutment. The plate in the abutment can be welded to the steel pile providing the lower substructural connection.

This chapter does not include preliminary design of the precast system due to changes in the scope of the project. However, design concepts presented address concerns related to precast systems. Rigid transverse connections are available to minimize durability problems associated with modular, jointed systems. A positive connection is also provided between the superstructure and substructure. The proposed system likewise satisfies all hydraulic and environmental

requirements for the project. An entire system composed of prefabricated elements can be designed and built to facilitate the most rapid construction of a new or replacement bridge.



## **Chapter 5 - Summary and Conclusions**

Development of a replacement system for reinforced concrete box culverts requires in-depth investigation of regulations, parameters, and guidelines pertaining to design in the short-span setting. Design in this context involves numerous considerations. Like other states, Kansas is experiencing negative effects of aging bridges and box culverts. As these structures reach the end of their design and service lives, new facilities will be needed for their replacement. Due to the large number of projects to be implemented in the future, emphasis should be on ensuring our replacement systems adequately address all concerns of the design process. Conclusions for the project are presented in this chapter.

### **Hydraulic and Environmental Design**

While box culverts have been used extensively throughout Kansas at short stream crossings, undesirable effects are associated with their placement. In several cases, box culverts have exhibited poor hydraulic and environmental performance characteristics. A brief summary of these observed problems are listed here:

- Narrow waterway openings constrict natural stream flow through the structure.
- Waterway constriction causes velocity changes in the vicinity of the culvert.
- Stream velocity changes result in scour of channel bed material.
- Scour can cause jumps in stream flow line elevation at the inlet and outlet of a culvert.
- Flow line jumps can discourage or prevent AOP.

Modern environmental regulations require that manmade structures adequately facilitate aquatic migration. Failure to provide acceptable environmental performance will reduce a system's chances of passing the environmental permitting process.

Research on hydraulic and environmental performance in river and stream settings has led to development of design criteria and protocol for new facilities. Fortunately, a few simple design techniques can be used to mitigate the most common environmental problems. These practices are listed here:

- Provide a waterway opening at least 20% greater than normal stream width.
- Maintain a natural channel bottom.
- Limit manmade changes to stream characteristics in the vicinity of the structure.

Research suggests that oversizing the waterway opening is a good practice and procedure for minimizing effects of waterway constriction and scour. Using a natural channel bottom reduces flow line jumps associated with scour and changes in stream flow characteristics. Avoiding all changes to the stream ensures that flow characteristics conducive to the natural environment are maintained. When these design practices are followed, numerous hydraulic and environmental problems are avoided without requiring mitigation specific to the project site.

### **Evaluation of Existing Solutions**

Currently, a variety of options have been employed to satisfy environmental regulations associated with box culverts throughout the U.S. These systems are listed here:

- Four-sided box culverts with embedded floor slab
- Three-sided box culverts
- Proprietary bottomless culverts
- Short-span, precast concrete bridges

Embedded box culverts offer a simple and inexpensive option, but reformed bed material may be easily washed away after placement. Three-sided culverts mitigate environmental problems, but their typical placement on strip footings is risky in a scour-critical environment. Proprietary bottomless culverts satisfy concerns, but come at an expense since their design details are protected as intellectual property. Conventional bridge systems, such as inverted tees and double tees, mitigate all externalities and show potential to serve as effective solutions. Research of these systems provided design concepts for the precast option. However, development of a cast-in-place system is required for the project as well.

### **Development of Cast-in-Place System**

The centerpiece of this project was development of a cast-in-place design for replacement of box culverts. The intent of this system was to maximize structural efficiency and offer a long service life with minimal durability issues. Another goal of the cast-in-place system was to minimize construction costs. To help accomplish this, emphasis was placed on simplicity of construction, familiarity to contractors, and use of existing construction materials. The initially proposed span range fell between 40 and 70 ft. The three-span, haunched-slab bridge standard used by KDOT has center spans ranging from 32 to 72 ft. This system was a good fit for the span range under consideration.

The center span of the haunched-slab system was selected based on the following benefits:

- Design plans for similar structures had already been developed and implemented in the state of Kansas.
- Forms used to construct three-span bridges can be used for the single-span structure.
- Slab bridges are relatively simple to build.

- The system can be constructed with existing contractor equipment, experience, and knowledge base.
- The system can be fully developed in-house with nonproprietary components.

By using the identical structural profile and forms from the three-span, haunched-slab bridge design, KDOT is able avoid the additional costs and risk associated with development of an entirely original concept. Keeping several elements from existing bridge designs allowed familiarity with the current haunched system to transfer to the new design. This compatibility may result in reduced errors in the field, lower construction costs, and the assurance of durable performance associated with the existing system.

### **Analysis and Design Results**

Analysis and design were used to compare performance of the cast-in-place system based on changes to the superstructural and substructural design. Four important design considerations were evaluated. The first was comparison of performance for haunched- and flat-slab profiles. The second was determination of the influence of substructural and soil conditions. The third was comparing the performance of the single-span system to the three-span system. The fourth was evaluating the appropriateness of the chosen system for the environment being researched.

Comparison of the haunched- and flat-slab profiles demonstrated the following:

- Thicker, haunched profiles attracted greater negative moment near the abutment than the thinner flat profile.
- The flat slab attracted more positive moment at midspan than the haunched slab.
- Preliminary design showed the haunched section required slightly less reinforcing steel than the flat section for the 32-ft. and 72-ft. spans.

Analysis results demonstrated predictable behavior of the profile. Stiff regions attracted greater moment. Since both competing profiles used the same concrete quantity, steel quantity represented the most significant difference between the designs. Based on this result, the haunched profile was determined to be a slightly more efficient section, although both would be acceptable design solutions. Accordingly, it was selected for the remainder of preliminary design.

Analysis and design was performed for the 32-ft. to 72-ft. span range in 8-ft. increments. Each span used the haunched superstructure paired with four different substructures of varying conditions. Each substructural option was used to represent extremes of abutment wall height and soil conditions. Comparison of effects of substructural condition showed the following:

- Short abutment walls and sandy soil conditions yielded a flexible substructure.
  - Shorter walls offered less resistance to rotation of the slab.
  - Sandy soil was less resistant to bending and rotation of piles.
  - The midspan region had higher positive moment demand.
  - The abutment regions had lower negative moment demand.
- Tall abutment walls with clay soils yielded a stiff substructure.
  - Tall wall offered greater resistance to rotation of the slab.
  - Clay soil provided greater resistance to bending and rotation of the piles.
  - The midspan region had lower positive moment demand.
  - The abutment regions had higher negative moment demand.
- Tall walls with clay soil or short walls with sand soil provided intermediate stiffness.
  - Resistance to rotation of the slab and piles was between the extreme conditions.

- Positive and negative moment regions were more balanced than the extreme cases.

The combination of abutment wall height and soil conditions has affected design of the superstructure. For all spans, the positive moment region was more heavily reinforced than the negative moment region. Based on these results, moment demand can be reduced for the midspan region if stiff substructures are placed deeper than required. Drawing moment away from the midspan is a desirable goal for fitting the three-span, haunched profile to the single-span system.

An important goal of the project was to determine if the haunched profile used for the three-span bridge was acceptable for use in the single-span bridge. Acceptability was determined based on the amount of reinforcement needed in the design. Analysis showed the following:

- The substructure attracted moment from the main span similar to end spans in the three-sided system.
- End spans were more effective in distributing moment away from midspan than the substructure in the single-span application.
- Transfer of moment to the substructure was more pronounced for shorter spans than longer spans.
  - The short span required less reinforcement at midspan in the single-span system than in the three-span bridge.
  - The long span required much more reinforcement at midspan in the single-span system than in the three-span bridge.
  - For all single-spans, the amount of negative moment reinforcement near the abutment was less than in the three-span bridge.

Effective and efficient design was achieved for shorter spans, using reasonable bar sizes and spacing. Design remained adequate for longer spans, although bar sizes did become large. The 72-ft. span used #11 bars in the positive moment region of midspan. This matches the largest bar size used in the superstructure of the three-span bridge. Results from analysis and design show the single-span, haunched-slab bridge system can be used effectively throughout the short-span bridge environment.

### **Selection of Precast System**

Preliminary development of the precast option was not undertaken in this project due to its limited potential for use. Some investigation was conducted and a possible solution was found in double-tee sections. Double-tees were considered advantageous for the following reasons:

- Successful use as a short-span system in other states
- Reduced number of modular sections
- Improved durability
- Ease of transport to construction site

Construction of double-tees in the Northeast and Texas indicated prominent use in regions where concerns over performance of the system is especially heightened, similar to Kansas. By selecting a wider section, fewer modular sections and transverse joints were needed. Reducing the number of joints was beneficial at improving the system's durability, since joints are normally the bridge's weak point in this regard. Double-tees are inherently stable for transport from the precast plant to the site. Use of welded embedded-plate connections between non-jointed members satisfied the need for positive connections and drew from successful practice for precast bridges in other states.

## **Chapter 6 - Recommendations for Future Research**

The research to be performed in this project was divided into three phases. This report contains the work completed for Phase I. The scope of the project specified that Phase I involve the selection of two structural systems to serve as replacements for box culverts, the first for maximum structural efficiency and the second for minimizing construction time. These systems were selected based on review of systems used throughout the U.S. In order to fully develop these systems, more research and design needs to be completed. This chapter lists the author's recommendations for KDOT to complete the development of these systems.

### **Superstructural Considerations**

Phase I involved comparison of haunched and flat profiles for the superstructure of the cast-in-place option. This comparison was limited to the 32-ft. and 72-ft. spans, since they represented the extremes of the span range. While analysis and design were more favorable for the haunched section in both cases, results varied by a small margin. While the haunched profile was predetermined based on existing design plans, the flat slab can undergo a much more original design. The flat slab's thickness for each span was selected so that the concrete volume in the superstructure was the same as for the haunched counterpart. This minimized differences between the sections and provided one variable for comparison.

Thickness of a flat slab could be changed, allowing for a different reinforcement design. Researching the effects of these changes will determine if the haunched section is truly more advantageous than the flat section. Since preliminary results were so close, it was determined that either profile would serve acceptably. However, it is recommended that KDOT fully



investigate the design of the flat-slab option to guarantee development of the most economical system. Comparison should also be performed for all span lengths under consideration to provide the most detailed results. The remainder of the design process should proceed based on the most promising system.

Work completed in Phase I was limited to preliminary design of longitudinal reinforcement in the superstructure. To be operational, a full, detailed design of the system must be performed. This includes the most optimal design of transverse reinforcement. Preliminary design showed the transverse reinforcement on the existing three-span, haunched-slab plans was adequate for the single-span system. However, no alterations to the transverse design were made.

While longitudinal design was conducted, it was limited to allocation of sufficient reinforcement at tenth-points on the slab profile. Exact locations of rebar termination and splicing, based on moment demand and development length, were not calculated, nor were required splice lengths determined. Detailed design will require these actions. Additionally, only the most significant, governing load cases were used in the load combinations for preliminary design. Detailed design should include all minor load cases and combinations shown in the code. If deemed worthwhile, more exact analysis methods, including more realistic section properties, may be performed to contrast with the tenth-point approximations demonstrated in this report. Thus, KDOT is recommended to perform a fully detailed design of the new system.

### **Substructural Considerations**

Preliminary design in Phase I was limited to the superstructure. The substructure was considered only to show its effects on load distribution in the slab. Plan development will require a fully detailed design of the substructure, including longitudinal, transverse, and shear reinforcement in the abutment walls. In this report, only maximum and minimum wall heights

were considered. Plan development should include full design for abutment wall heights. KDOT is recommended to develop a complete substructural design.

Preliminary design was limited to consideration of piles as foundation elements. Other foundation options include drilled shafts and strip footings. For cases where a deep foundation is required, drilled shafts present another viable option. Further development of the system should incorporate the effects of drilled shafts in addition to pile foundations.

While the system is intended for use at river and stream crossings, it is expected to be effective at road crossings as well. At road crossings, foundations do not have susceptibility for scour problems. For locations with high soil bearing capacity, pile foundations may be unnecessary and strip footings may serve adequately. This shallow foundation would reduce project costs further. KDOT should design the system to be compatible with strip footings and drilled shafts in addition to pile foundations.

While the substructural design for this project has only considered conventional foundations, other more economical alternatives exist. The literature search described use of GRS-IBS as a means of providing an adequate foundation, while reducing project costs and accelerating construction. GRS-IBS is a promising technology that is being used more frequently. However, like other shallow foundations, it has elevated scour risks. Since the system may be used at road crossings, GRS-IBS can be used with reduced concerns for washout. KDOT is recommended to develop the design of the new system to be compatible with GRS-IBS as well as conventional foundations.

Despite the risks for GRS-IBS at river and stream crossings, these systems have been implemented in those environments in other states. In several instances, these systems are accompanied by a means of scour protection. Sheet piling and riprap are common protective

elements. In some cases, GRS is implemented along with pile foundations. KDOT is recommended to investigate a proper means of protection for GRS-IBS at river and stream crossings. Successful development of this system may allow bridge owners to take advantage of a promising, cost-saving technology in a manner that reduces risk to an acceptable level.

### **Other Considerations**

Preliminary investigation and design considered spans ranging from 32 ft. to 72 ft. These distances are longer than the spans of box culverts. Greater lengths were used to satisfy situations where multiple box culvert barrels were placed back to back. The short end of the span range was increased to account for the additional waterway opening needed to avoid constriction of the river or stream environment. This resulted in the solution taking the form of a traditional bridge.

While useful for a large number of short-span bridges, a market remains for systems shorter than 32 feet. In many cases, the span requirement for a box culvert replacement system may be less than those considered in this project. KDOT should develop a structural system with the same guidelines as this project, but for spans less than 32 ft., addressing very short-span structures as well.

Emphasis for Phase I focused on development of a structurally efficient, cast-in-place system. While the market in Kansas is more limited for a precast, rapid-replacement option, development of this system will have beneficial impact on road users. A significant portion of the literature search was conducted to provide a background for precast, short-span structural systems intended to satisfy ABC requirements.

While extensive, this search was by no means comprehensive and a significant amount of research on this topic remains to be investigated. This subject pertains not only to types of systems used, but also to types and performance of joints used between modular elements,

construction techniques, and economics of a variety of options and alternatives. Since ABC techniques are growing in popularity and may become increasingly useful in Kansas as traffic volumes rise, further research should focus on a short-span, environmentally friendly, ABC option. KDOT is recommended to develop a full design of the superstructure, substructure, foundation, and joints for this system, just as for the cast-in-place option.

### **Closing**

Development of a new bridge system requires in-depth consideration of numerous parameters. Based on investigation of background factors and context, the structural type most appropriate for the given span range was evaluated. While both the flat and haunched profiles were determined to perform acceptably, a single-span, haunched-slab bridge was selected for use. Analysis and preliminary design results confirmed this system could adequately serve as a replacement for box culverts. Final design is necessary for the system's implementation. Throughout the remainder of the research and design process, consideration and application of these additional recommendations will aid in successful development of a comprehensive solution to the short-span, box culvert replacement problem.

## References

- Adams, M., Alzamora, D., & Nicks, J. (2011, March 4). Geosynthetic Reinforced Soil Integrated Bridge System. Federal Highway Administration (FHWA).
- Adams, M., Nicks, J., Stabile, T., Wu, J., Schlatter, W., & Hartmann, J. (2011). *Geosynthetic Reinforced Soil Integrated Bridge System, Synthesis Report*. McLean: Federal Highway Administration (FHWA).
- American Association of State Highway and Transportation Officials (AASHTO). (2008, July). *Bridging the Gap: Restoring and Rebuilding the Nation's Bridges*. Retrieved December 12, 2012, from AASHTO:  
<http://www.transportation1.org/BridgeReport/docs/BridgingtheGap.pdf>
- American Association of State Highway and Transportation Officials (AASHTO). (2010). *AASHTO LRFD Bridge Design Specifications, 5th ed.* Washington, D.C.
- American Concrete Institute (ACI). (2008). *Building Code Requirements for Structural Concrete (ACI 318-08) and Commentary*.
- Arneson, L., Zevenbergen, L., Lagasse, P., & Clopper, P. (2012, April). *Evaluating Scour at Bridges, Fifth Edition*. Federal Highway Administration.
- Baker, C., & Votapka, F. (1990). *Fish passage through culverts*. San Dimas, CA: USDA Forest Service - Technology and Development Center.
- Bardow, A. (2011, July 22).
- Bates, K., Barnard, B., Heiner, B., Klavas, P., & Powers, P. (1999). *Fish Passage Design at Road Culverts*. Washington Department of Wildlife and Fish.
- BEBO Arch Systems (1). (n.d.). *BEBO Arch Systems*. Retrieved January 10, 2013, from <http://beboarch.com/distribution.php>
- BEBO Arch Systems (2). (n.d.). *The BEBO System*. Retrieved January 10, 2013, from <http://beboarch.com/article/artFile/10-111129-BrochureCompleteLowRes.pdf>
- Blank, M., Bramblett, B., Kalinowski, S., Cahoon, J., & Nixon, K. (2011). *Impacts of Barriers on Topeka Shiner Populations*. Western Transportation Institute.
- Bowers, B. (2011, July 13).
- Bureau of Transportation Statistics (BTS). (2013). *Table 1-36: Roadway Vehicles-Miles Traveled (VMT) and VMT per Lane-Mile by Functional Class (a)*. Retrieved May 29, 2013, from U.S. Department of Transportation (USDOT):

- [http://www.rita.dot.gov/bts/sites/rita.dot.gov.bts/files/publications/national\\_transportation\\_statistics/html/table\\_01\\_36.html](http://www.rita.dot.gov/bts/sites/rita.dot.gov.bts/files/publications/national_transportation_statistics/html/table_01_36.html)
- California Department of Transportation (Caltrans). (2002, November 8). *Geotechnical Service Photo Galleries*. Retrieved from <http://www.dot.ca.gov/hq/esc/geotech/photos/support/index.htm>
- California Department of Transportation (Caltrans). (2012, July). *Bridge Design Aids*. Retrieved January 23, 2013, from [http://www.dot.ca.gov/hq/esc/techpubs/manual/bridgemanuals/bridge-design-aids/page/bda\\_6\\_1.pdf](http://www.dot.ca.gov/hq/esc/techpubs/manual/bridgemanuals/bridge-design-aids/page/bda_6_1.pdf)
- Cancelliere, J. (2011, July 8).
- CON/SPAN. (2003). Retrieved December 28, 2012, from <http://www.con-span.com/CON-SPAN/download/wwarea-all-Model.pdf>
- CON/SPAN. (2010). *CON/SPAN Bridge Systems*. Retrieved December 28, 2012, from [http://www.con-span.com/CON-SPAN/nof\\_main.html](http://www.con-span.com/CON-SPAN/nof_main.html)
- CONTECH Engineered Solutions. (2013). *SUPER-SPAN AND SUPER-PLATE*. Retrieved January 13, 2013, from <http://www.conteches.com/Products/Bridges-and-Structures/Plate/SUPER-SPAN-and-SUPER-PLATE.aspx>
- Culmo, M. (2011, November 1). *Accelerated Bridge Construction - Experience in Design, Fabrication and Erection of Prefabricated Bridge Elements and Systems*. Retrieved May 29, 2013, from Federal Highway Administration (FHWA): <http://www.fhwa.dot.gov/bridge/abc/docs/abcmanual.pdf>
- Culmo, M., & Seredarian, R. (2010). Development of the northeast extreme tee (NEXT) beam for accelerated bridge construction. *Precast/Prestressed Concrete Institute*, 86-101.
- Environmental Protection Agency (EPA). (2003, July 24). *Culverts*. Retrieved November 29, 2012, from [http://water.epa.gov/polwaste/nps/urban/upload/2003\\_07\\_24\\_NPS\\_unpavedroads\\_ch3.pdf](http://water.epa.gov/polwaste/nps/urban/upload/2003_07_24_NPS_unpavedroads_ch3.pdf)
- Erickson, G., Garret, P., Gray, M., Levy, A., Marshik, J., McGowen, P., et al. (2002). *Interaction Between Roadways and Wildlife Ecology*. Transportation Research Board (TRB).
- Federal Emergency Management Agency (FEMA). (2009, August 4). *Inspecting bridges in ND*. Retrieved November 7, 2012, from [http://www.fema.gov/photolibrary/photo\\_details.do;jsessionid=111254C578FF65768D9FAA87471AA9C3.WorkerPublic3?id=41802](http://www.fema.gov/photolibrary/photo_details.do;jsessionid=111254C578FF65768D9FAA87471AA9C3.WorkerPublic3?id=41802)
- Federal Highway Administration (FHWA). (2013, May 29). *Accelerated Bridge Construction*. Retrieved May 29, 2013, from <http://www.fhwa.dot.gov/bridge/abc/index.cfm>

- Federal Highway Administration (FHWA). (n.d.). *Fact Sheet 16 - States Across the Country Implement Accelerated Bridge Construction*. Retrieved May 29, 2013, from <http://www.ops.fhwa.dot.gov/wz/practices/factsheets/factsheet16/>
- Fitch, G. (1995). *Nonanadromous Fish Passage in Highway Culverts*. Virginia Transportation Research Council.
- Florida Department of Transportation (FDOT). (n.d.). *LRFD Design Example #2: Cast-in-Place Flat Slab Bridge Design*. Retrieved May 2, 2013, from <http://www.dot.state.fl.us/structures/StructuresManual/CurrentRelease/FlatSlabExample.pdf>
- Frank, B. (n.d.). *Drainage Ditch and Box Culvert*. Retrieved November 7, 2012, from Jacksonville Shells: <http://www.jaxshells.org/wmd1.htm>
- Hansen, B., Johnson, S., Nieber, J., & Marr, J. (2011). *Performance Assessment of Oversized Culverts to Accommodate Fish Passage*. Minnesota Department of Transportation.
- Hunt, B. (2009). *Monitoring Scour Critical Bridges*. Transportation Research Board (TRB).
- HY-SPAN. (n.d.). *The Instant Bridge*. Retrieved August 8, 2011, from [http://hyspanbridge.com/HY-SPAN\\_Brochure.pdf](http://hyspanbridge.com/HY-SPAN_Brochure.pdf)
- Kamel, M., & Tadros, M. (1996). The Inverted Tee Shallow Bridge System for Rural Areas. *Precast/Prestressed Concrete Institute (PCI)*, 28-43.
- Kansas Department of Transportation (KDOT). (2008, November 14). *Kansas Bridge Information*. Retrieved October 31, 2012, from [http://www.ksdot.org/PDF\\_Files/Bridge%20fact%20sheet.pdf](http://www.ksdot.org/PDF_Files/Bridge%20fact%20sheet.pdf)
- Kansas Department of Transportation (KDOT). (2010, July 22). Concrete Bridge Approach Pavement Normal Approach. *KDOT Standard Drawings*.
- Kansas Department of Transportation (KDOT). (2011). *Cell Configuration*. Retrieved June 14, 2011, from [http://kart.ksdot.org/RCB\\_Request/CellConfiguration.aspx](http://kart.ksdot.org/RCB_Request/CellConfiguration.aspx)
- Kansas Department of Transportation (KDOT). (n.d.). Haunched-Slab Bridge Standard Design Plans.
- Kerenyi, K., Jones, S., & Stein, S. (2003). *Bottomless Culvert Scour Study: Phase I Laboratory Report*. Federal Highway Administration.
- Khaleghi, B., Schultz, E., Seguirant, S., Marsh, L., Haraldsson, O., Eberhard, M., et al. (2012). Accelerated bridge construction in Washington State: From research to practice. *Precast/Prestressed Concrete Institute*, 34-49.
- Kosicki, A. (2011, July 29).

- Lagasse, P., Clopper, P., Pagan-Ortiz, J., Zevenbergen, L., Arneson, L., Schall, J., et al. (2009). *Bridge Scour Instability Countermeasures*. Federal Highway Administration (FHWA).
- Lagasse, P., Zevenbergen, L., Splitz, W., & Arneson, L. (2012). *Stream Stability at Highway Crossings, Fourth Edition*. Federal Highway Administration.
- Lee, S. (2011, July 20).
- Lovelace III, G. (2011, July 18).
- Maine Department of Transportation (MaineDOT). (2010, August 16). *FRP Arch Lab Testing Presentation*. Retrieved August 9, 2011, from Bridge in a Backpack: [http://www.maine.gov/mdot/tr/documents/pdf/FRP\\_Arch\\_Lab\\_Testing\\_and\\_Neal\\_Bridge\\_Presentation.pdf](http://www.maine.gov/mdot/tr/documents/pdf/FRP_Arch_Lab_Testing_and_Neal_Bridge_Presentation.pdf)
- Marin III, D. (2008, August). *Accelerated Bridge Construction: Recent TxDOT ABC Projects*. Retrieved October 17, 2012, from Iowa Department of Transportation Accelerated Bridge Construction Workshop: <http://www.iowadot.gov/bridge/abc/Presentations/11MarinTxDOTABCProjects.ppt>
- Massachusetts Department of Transportation (MassDOT). (2010, December). *Design of Bridges and Culverts for Wildlife Passage at Freshwater Streams*. Retrieved May 23, 2013, from [http://www.mhd.state.ma.us/downloads/projDev/Design\\_Bridges\\_Culverts\\_Wildlife\\_Passage\\_122710.pdf](http://www.mhd.state.ma.us/downloads/projDev/Design_Bridges_Culverts_Wildlife_Passage_122710.pdf)
- Menkulasi, F., Mercer, M., Wollmann, C., & Cousins, T. (2012). Accelerating Bridge Construction Using the Precast Inverted T-Beam Concept. *Precast/Prestressed Concrete Institute (PCI)*.
- Minnesota Department of Transportation (MnDOT). (2012, July). *Innovative Bridge Construction for Minnesota Local Roads*. Retrieved October 17, 2012, from Minnesota Department of Transportation. (July 2012). Innovative Bridge Construction for Minnesota Local Roads. Transp<http://www.lrrb.org/media/reports/TRS1203.pdf>
- Minnesota Department of Transportation (MnDOT). (n.d.). *Guidelines for Bridge Design*. Retrieved January 23, 2013, from <http://www.dot.state.mn.us/bridge/stateaid/handbook/Handbook.pdf>
- Mommandi, A. (2011, July 12).
- National Transportation Safety Board (NTSB). (n.d.). *Highway Accident Report*. Retrieved February 25, 2013, from <http://www.nts.gov/investigations/summary/HAR8802.htm>
- Nilson, A., Darwin, D., & Dolan, C. (2010). *Design of Concrete Structures, 14th ed.* New York: McGraw-Hill.
- Piccinin, R., & Schultz, A. (2012). The Minnesota inverted-tee system: Parametric studies for preliminary design. *Precast/Prestressed Concrete Institute (PCI)*.



- Precast/Prestressed Concrete Institute Northeast (PCINE). (2012). *Guidelines for Northeast Extreme Tee Beam (NEXT Beam)*. Retrieved October 17, 2012, from <http://www.pcine.org/cfcs/cmsIT/baseComponents/fileManagerProxy.cfc?method=GetFile&fileID=29E93D11-F1F6-B13E-83B313BBC9C58FF5>
- Richardson, M. (2011, July 7).
- River and Stream Continuity Project (RSCP). (2009). *Continuity Advisory Committee*. Retrieved November 16, 2012, from University of Massachusetts Amherst Extension: [http://www.streamcontinuity.org/introduction/steering\\_committee.htm](http://www.streamcontinuity.org/introduction/steering_committee.htm)
- River and Stream Continuity Project (RSCP). (2011, March 1). *Massachusetts River and Stream Crossing Standards*. Retrieved November 9, 2012, from [http://www.nae.usace.army.mil/reg/Stream/MA\\_RiverStreamCrossingStandards.pdf](http://www.nae.usace.army.mil/reg/Stream/MA_RiverStreamCrossingStandards.pdf)
- Salem, S., Najafi, M., Salman, B., Calderon, D., Patil, R., & Bhattachar, D. (2008). *Use of Trenchless Technologies for a Comprehensive Asset Management of Culverts and Drainage Structures*. Madison: Midwest Regional University Transportation Center, Department of Civil Engineering, College of Engineering, University of Wisconsin, Madison.
- Schall, J., Thompson, P., Zerges, S., Kilgore, R., & Morris, J. (2012, April). *Hydraulic Design of Culverts, Third Edition*. Federal Highway Administration (FHWA).
- Seniw, M. (2011, July 19).
- Tatsuoka, F., Kirakawa, D., Nojiri, M., Aizawa, H., Nishikioru, H., Soma, R., et al. (2009). A new type of integrated bridge comprising geosynthetic-reinforced soil walls. *Geosynthetics International*, 301-26.
- Tokerud, R. (1979). Precast Prestressed Concrete Bridges. *PCI Journal*, 42-56.
- Transportation for America . (n.d.). *The Fix We're In: The State of Kansas' Bridges*. Retrieved December 12, 2012, from Transportation for America: <http://t4america.org/docs/bridgereport/states/bridgereport-ks.pdf>
- U.S. Fish and Wildlife Service (USFWS) (1). (2012, October 24). *Niangua Darter: Improving Streams for Species Recovery*. Retrieved from Endangered Species: <http://www.fws.gov/midwest/endangered/esday/MONianguaDarter.html>
- U.S. Fish and Wildlife Service (USFWS) (2). (2012, November). *Listings of occurrences for Kansas*. Retrieved November 16, 2012, from Species Report: [http://ecos.fws.gov/tess\\_public/pub/stateListingAndOccurrenceIndividual.jsp?state=KS](http://ecos.fws.gov/tess_public/pub/stateListingAndOccurrenceIndividual.jsp?state=KS)
- University of Maine. (2011, May 4). *Bridge-in-a-Backpack*. Retrieved August 9, 2011, from Advanced Structures & Composites Center: [http://www2.umaine.edu/aewc/images/stories/bridge\\_in\\_a\\_backpack\\_flyer\\_web.pdf](http://www2.umaine.edu/aewc/images/stories/bridge_in_a_backpack_flyer_web.pdf)

University of Maine. (n.d.). *Bridge-in-a-Backpack Enhancing Maine's Infrastructure*. Retrieved February 5, 2013, from Advanced Structures & Composites Center:  
<http://www2.umaine.edu/aewc/images/stories/biabme9.11a.pdf>

Washington Department of Transportation (WSDOT). (2011, July). *Substructure Design*. Retrieved June 3, 2013, from WSDOT Bridge Design Manual:  
<http://www.wsdot.wa.gov/publications/manuals/fulltext/m23-50/chapter7.pdf>

Wu, J., Lee, K., Helwany, S., & Ketchart, K. (2006). *Design and Construction Guidelines for Geosynthetic-Reinforced Soil Bridge Abutments with a Flexible Facing*. Washington: National Cooperative Highway Research Program (NCHRP).

## **Appendix A - Calculation of Live Load Based on Equivalent Strip Method**

Appendix A demonstrates the calculation of live load based on the AASHTO equivalent strip method. The appendix is separated into subchapters based on roadway width. Analysis of calculations and parameters in the formulas will show the equivalent strip width is minimized when the roadway width is minimized. All calculations in this appendix pertain to the 32-ft. span. A similar procedure was performed for all other spans, but for brevity, they are not shown here.

The appendix is split into subchapters for the calculation of equivalent strip width, truck loads, and application of the impact factor. First, the equivalent strip width was calculated as a function of the bridge's length, width, and number of loaded lanes. AASHTO HL-93 truck, tandem, and lane loads are presented. They were then divided by the equivalent strip width for the appropriate limit state. Finally, these loads were multiplied by the impact factor appropriate to each limit state. The loads produced after the application of the impact factor are the ones used in design.

## 28-ft. Roadway

### *Calculation of Equivalent Strip Width*

All length units are in feet

$$\text{Span\_Length} := 32$$

$$\text{Bridge\_Width} := 28$$

$$L_1 := \min(\text{Span\_Length}, 60.0) = 32 \quad (\text{AASHTO, Sec. 4.6.2.3, p. 4-46})$$

$$W := \text{Bridge\_Width} = 28$$

$$W_{1\_One\_Lane\_Loaded} := \min(W, 30.0) = 28 \quad (\text{AASHTO, Sec. 4.6.2.3, p. 4-46})$$

$$W_{1\_Two\_Lanes\_Loaded} := \min(W, 60.0) = 28 \quad (\text{AASHTO, Sec. 4.6.2.3, p. 4-46})$$

$$N_L := \text{floor}\left(\frac{W}{12.0}\right) = 2 \quad (\text{AASHTO, Sec. 3.6.1.1.1, p. 3-17})$$

$$E_{\text{One\_Lane\_Loaded}} := \frac{10.0 + 5.0 \cdot \sqrt{L_1 \cdot W_{1\_One\_Lane\_Loaded}}}{12.0} = 13.3055 \quad (\text{AASHTO, Eq. 4.6.2.3-1, p. 4-46})$$

$$E_{\text{Two\_Lanes\_Loaded}} := \frac{\min\left(84.0 + 1.44 \cdot \sqrt{L_1 \cdot W_{1\_Two\_Lanes\_Loaded}}, \frac{12.0 \cdot W}{N_L}\right)}{12.0} = 10.592 \quad (\text{AASHTO, Eq. 4.6.2.3-2, p. 4-46})$$

$$E := \min(E_{\text{One\_Lane\_Loaded}}, E_{\text{Two\_Lanes\_Loaded}}) = 10.592$$

$$E_{\text{Fatigue}} := E_{\text{One\_Lane\_Loaded}} = 13.3055$$

## Calculation of Loads

### Lane and Axle Loads:

$$\text{Lane\_Load} := 0.64\text{kif}$$

$$\text{Axle\_Load}_1 := 8\text{kip}$$

$$\text{Axle\_Load}_{2\_3} := 32\text{kip}$$

$$\text{Tandem\_Axle\_Load} := 25\text{kip}$$

### Equivalent Strip Loads for All Limit States Except Fatigue:

$$\text{Lane\_Load}_{\text{Strip}} := \frac{\text{Lane\_Load}}{E} = 5.035 \times 10^{-3} \cdot \frac{\text{kip}}{\text{in}}$$

$$\text{Axle\_Load}_1_{\text{Strip}} := \frac{\text{Axle\_Load}_1}{E} = 0.7553 \cdot \text{kip}$$

$$\text{Axle\_Load}_{2\_3}_{\text{Strip}} := \frac{\text{Axle\_Load}_{2\_3}}{E} = 3.0212 \cdot \text{kip}$$

$$\text{Tandem\_Axle\_Load}_{\text{Strip}} := \frac{\text{Tandem\_Axle\_Load}}{E} = 2.3603 \cdot \text{kip}$$

### Equivalent Strip Loads for Fatigue Limit State:

$$\text{Axle\_Load}_1_{\text{Strip\_Fatigue}} := \frac{\text{Axle\_Load}_1}{E_{\text{Fatigue}}} = 0.6013 \cdot \text{kip}$$

$$\text{Axle\_Load}_{2\_3}_{\text{Strip\_Fatigue}} := \frac{\text{Axle\_Load}_{2\_3}}{E_{\text{Fatigue}}} = 2.405 \cdot \text{kip}$$

## *Application of Impact Factor*

### Dynamic Load Allowance:

$$IM := 1.33 \quad (\text{AASHTO, Table 3.6.2.1-1, p. 3-30})$$

$$IM_{\text{Fatigue}} := 1.15 \quad (\text{AASHTO, Table 3.6.2.1-1, p. 3-30})$$

### Equivalent Strip Loads for All Limit States Except Fatigue (Including Dynamic Load Allowance):

$$\text{Lane\_Load}_{\text{Strip}} := \frac{\text{Lane\_Load}}{E} = 5.035 \times 10^{-3} \frac{\text{kip}}{\text{in}}$$

$$\text{Axle\_Load}_{1\_Strip\_Impact} := \text{Axle\_Load}_{1\_Strip} \cdot IM = 1.0045 \cdot \text{kip}$$

$$\text{Axle\_Load}_{2\_3\_Strip\_Impact} := \text{Axle\_Load}_{2\_3\_Strip} \cdot IM = 4.0181 \cdot \text{kip}$$

$$\text{Tandem\_Axle\_Load}_{\text{Strip\_Impact}} := \text{Tandem\_Axle\_Load}_{\text{Strip}} \cdot IM = 3.1392 \cdot \text{kip}$$

### Equivalent Strip Loads for Fatigue Limit State (Including Dynamic Load Allowance):

$$\text{Axle\_Load}_{1\_Strip\_Fatigue\_Impact} := \text{Axle\_Load}_{1\_Strip\_Fatigue} \cdot IM_{\text{Fatigue}} = 0.6914 \cdot \text{kip}$$

$$\text{Axle\_Load}_{2\_3\_Strip\_Fatigue\_Impact} := \text{Axle\_Load}_{2\_3\_Strip\_Fatigue} \cdot IM_{\text{Fatigue}} = 2.7658 \cdot \text{kip}$$

## 32-ft. Roadway

### *Calculation of Equivalent Strip Width*

All length units are in feet

$$\text{Span\_Length} := 32$$

$$\text{Bridge\_Width} := 32$$

$$L_1 := \min(\text{Span\_Length}, 60.0) = 32 \quad (\text{AASHTO, Sec. 4.6.2.3, p. 4-46})$$

$$W := \text{Bridge\_Width} = 32$$

$$W_{1\_One\_Lane\_Loaded} := \min(W, 30.0) = 30 \quad (\text{AASHTO, Sec. 4.6.2.3, p. 4-46})$$

$$W_{1\_Two\_Lanes\_Loaded} := \min(W, 60.0) = 32 \quad (\text{AASHTO, Sec. 4.6.2.3, p. 4-46})$$

$$N_L := \text{floor}\left(\frac{W}{12.0}\right) = 2 \quad (\text{AASHTO, Sec. 3.6.1.1.1, p. 3-17})$$

$$E_{\text{One\_Lane\_Loaded}} := \frac{10.0 + 5.0 \cdot \sqrt{L_1 \cdot W_{1\_One\_Lane\_Loaded}}}{12.0} = 13.7433 \quad (\text{AASHTO, Eq. 4.6.2.3-1, p. 4-46})$$

$$E_{\text{Two\_Lanes\_Loaded}} := \frac{\min\left(84.0 + 1.44 \cdot \sqrt{L_1 \cdot W_{1\_Two\_Lanes\_Loaded}}, \frac{12.0 \cdot W}{N_L}\right)}{12.0} = 10.84 \quad (\text{AASHTO, Eq. 4.6.2.3-2, p. 4-46})$$

$$E := \min(E_{\text{One\_Lane\_Loaded}}, E_{\text{Two\_Lanes\_Loaded}}) = 10.84$$

$$E_{\text{Fatigue}} := E_{\text{One\_Lane\_Loaded}} = 13.7433$$

## Calculation of Loads

### Lane and Axle Loads:

$$\text{Lane\_Load} := 0.64\text{kif}$$

$$\text{Axle\_Load}_1 := 8\text{kip}$$

$$\text{Axle\_Load}_{2\_3} := 32\text{kip}$$

$$\text{Tandem\_Axle\_Load} := 25\text{kip}$$

### Equivalent Strip Loads for All Limit States Except Fatigue:

$$\text{Lane\_Load}_{\text{Strip}} := \frac{\text{Lane\_Load}}{E} = 4.92 \times 10^{-3} \frac{\text{kip}}{\text{in}}$$

$$\text{Axle\_Load}_1_{\text{Strip}} := \frac{\text{Axle\_Load}_1}{E} = 0.738 \cdot \text{kip}$$

$$\text{Axle\_Load}_{2\_3}_{\text{Strip}} := \frac{\text{Axle\_Load}_{2\_3}}{E} = 2.952 \cdot \text{kip}$$

$$\text{Tandem\_Axle\_Load}_{\text{Strip}} := \frac{\text{Tandem\_Axle\_Load}}{E} = 2.3063 \cdot \text{kip}$$

### Equivalent Strip Loads for Fatigue Limit State:

$$\text{Axle\_Load}_1_{\text{Strip\_Fatigue}} := \frac{\text{Axle\_Load}_1}{E_{\text{Fatigue}}} = 0.5821 \cdot \text{kip}$$

$$\text{Axle\_Load}_{2\_3}_{\text{Strip\_Fatigue}} := \frac{\text{Axle\_Load}_{2\_3}}{E_{\text{Fatigue}}} = 2.3284 \cdot \text{kip}$$



## *Application of Impact Factor*

### Dynamic Load Allowance:

$$IM := 1.33 \quad (\text{AASHTO, Table 3.6.2.1-1, p. 3-30})$$

$$IM_{\text{Fatigue}} := 1.15 \quad (\text{AASHTO, Table 3.6.2.1-1, p. 3-30})$$

### Equivalent Strip Loads for All Limit States Except Fatigue (Including Dynamic Load Allowance):

$$\text{Lane\_Load}_{\text{Strip}} := \frac{\text{Lane\_Load}}{E} = 4.92 \times 10^{-3} \frac{\text{kip}}{\text{in}}$$

$$\text{Axle\_Load}_{1\_Strip\_Impact} := \text{Axle\_Load}_{1\_Strip} \cdot IM = 0.9815 \cdot \text{kip}$$

$$\text{Axle\_Load}_{2\_3\_Strip\_Impact} := \text{Axle\_Load}_{2\_3\_Strip} \cdot IM = 3.9262 \cdot \text{kip}$$

$$\text{Tandem\_Axle\_Load}_{\text{Strip\_Impact}} := \text{Tandem\_Axle\_Load}_{\text{Strip}} \cdot IM = 3.0673 \cdot \text{kip}$$

### Equivalent Strip Loads for Fatigue Limit State (Including Dynamic Load Allowance):

$$\text{Axle\_Load}_{1\_Strip\_Fatigue\_Impact} := \text{Axle\_Load}_{1\_Strip\_Fatigue} \cdot IM_{\text{Fatigue}} = 0.6694 \cdot \text{kip}$$

$$\text{Axle\_Load}_{2\_3\_Strip\_Fatigue\_Impact} := \text{Axle\_Load}_{2\_3\_Strip\_Fatigue} \cdot IM_{\text{Fatigue}} = 2.6777 \cdot \text{kip}$$

## 36-ft. Roadway

### *Calculation of Equivalent Strip Width*

All length units are in feet

$$\text{Span\_Length} := 32$$

$$\text{Bridge\_Width} := 36$$

$$L_1 := \min(\text{Span\_Length}, 60.0) = 32 \quad (\text{AASHTO, Sec. 4.6.2.3, p. 4-46})$$

$$W := \text{Bridge\_Width} = 36$$

$$W_{1\_One\_Lane\_Loaded} := \min(W, 30.0) = 30 \quad (\text{AASHTO, Sec. 4.6.2.3, p. 4-46})$$

$$W_{1\_Two\_Lanes\_Loaded} := \min(W, 60.0) = 36 \quad (\text{AASHTO, Sec. 4.6.2.3, p. 4-46})$$

$$N_L := \text{floor}\left(\frac{W}{12.0}\right) = 3 \quad (\text{AASHTO, Sec. 3.6.1.1.1, p. 3-17})$$

$$E_{\text{One\_Lane\_Loaded}} := \frac{10.0 + 5.0 \cdot \sqrt{L_1 \cdot W_{1\_One\_Lane\_Loaded}}}{12.0} = 13.7433 \quad (\text{AASHTO, Eq. 4.6.2.3-1, p. 4-46})$$

$$E_{\text{Two\_Lanes\_Loaded}} := \frac{\min\left(84.0 + 1.44 \cdot \sqrt{L_1 \cdot W_{1\_Two\_Lanes\_Loaded}}, \frac{12.0 \cdot W}{N_L}\right)}{12.0} = 11.0729 \quad (\text{AASHTO, Eq. 4.6.2.3-2, p. 4-46})$$

$$E := \min(E_{\text{One\_Lane\_Loaded}}, E_{\text{Two\_Lanes\_Loaded}}) = 11.0729$$

$$E_{\text{Fatigue}} := E_{\text{One\_Lane\_Loaded}} = 13.7433$$

## Calculation of Loads

### Lane and Axle Loads:

$$\text{Lane\_Load} := 0.64\text{klf}$$

$$\text{Axle\_Load}_1 := 8\text{kip}$$

$$\text{Axle\_Load}_{2\_3} := 32\text{kip}$$

$$\text{Tandem\_Axle\_Load} := 25\text{kip}$$

### Equivalent Strip Loads for All Limit States Except Fatigue:

$$\text{Lane\_Load}_{\text{Strip}} := \frac{\text{Lane\_Load}}{E} = 4.817 \times 10^{-3} \cdot \frac{\text{kip}}{\text{in}}$$

$$\text{Axle\_Load}_1_{\text{Strip}} := \frac{\text{Axle\_Load}_1}{E} = 0.7225 \cdot \text{kip}$$

$$\text{Axle\_Load}_{2\_3}_{\text{Strip}} := \frac{\text{Axle\_Load}_{2\_3}}{E} = 2.8899 \cdot \text{kip}$$

$$\text{Tandem\_Axle\_Load}_{\text{Strip}} := \frac{\text{Tandem\_Axle\_Load}}{E} = 2.2578 \cdot \text{kip}$$

### Equivalent Strip Loads for Fatigue Limit State:

$$\text{Axle\_Load}_1_{\text{Strip\_Fatigue}} := \frac{\text{Axle\_Load}_1}{E_{\text{Fatigue}}} = 0.5821 \cdot \text{kip}$$

$$\text{Axle\_Load}_{2\_3}_{\text{Strip\_Fatigue}} := \frac{\text{Axle\_Load}_{2\_3}}{E_{\text{Fatigue}}} = 2.3284 \cdot \text{kip}$$

## *Application of Impact Factor*

Dynamic Load Allowance:

$$IM := 1.33 \quad (\text{AASHTO, Table 3.6.2.1-1, p. 3-30})$$

$$IM_{\text{Fatigue}} := 1.15 \quad (\text{AASHTO, Table 3.6.2.1-1, p. 3-30})$$

**Equivalent Strip Loads for All Limit States Except Fatigue (Including Dynamic Load Allowance):**

$$\text{Lane\_Load}_{\text{Strip}} := \frac{\text{Lane\_Load}}{E} = 4.817 \times 10^{-3} \frac{\text{kip}}{\text{in}}$$

$$\text{Axle\_Load}_{1\_Strip\_Impact} := \text{Axle\_Load}_{1\_Strip} \cdot IM = 0.9609 \cdot \text{kip}$$

$$\text{Axle\_Load}_{2\_3\_Strip\_Impact} := \text{Axle\_Load}_{2\_3\_Strip} \cdot IM = 3.8436 \cdot \text{kip}$$

$$\text{Tandem\_Axle\_Load}_{\text{Strip\_Impact}} := \text{Tandem\_Axle\_Load}_{\text{Strip}} \cdot IM = 3.0028 \cdot \text{kip}$$

**Equivalent Strip Loads for Fatigue Limit State (Including Dynamic Load Allowance):**

$$\text{Axle\_Load}_{1\_Strip\_Fatigue\_Impact} := \text{Axle\_Load}_{1\_Strip\_Fatigue} \cdot IM_{\text{Fatigue}} = 0.6694 \cdot \text{kip}$$

$$\text{Axle\_Load}_{2\_3\_Strip\_Fatigue\_Impact} := \text{Axle\_Load}_{2\_3\_Strip\_Fatigue} \cdot IM_{\text{Fatigue}} = 2.6777 \cdot \text{kip}$$

## 40-ft. Roadway

### *Calculation of Equivalent Strip Width*

All length units are in feet

$$\text{Span\_Length} := 32$$

$$\text{Bridge\_Width} := 40$$

$$L_1 := \min(\text{Span\_Length}, 60.0) = 32 \quad (\text{AASHTO, Sec. 4.6.2.3, p. 4-46})$$

$$W := \text{Bridge\_Width} = 40$$

$$W_{1\_One\_Lane\_Loaded} := \min(W, 30.0) = 30 \quad (\text{AASHTO, Sec. 4.6.2.3, p. 4-46})$$

$$W_{1\_Two\_Lanes\_Loaded} := \min(W, 60.0) = 40 \quad (\text{AASHTO, Sec. 4.6.2.3, p. 4-46})$$

$$N_L := \text{floor}\left(\frac{W}{12.0}\right) = 3 \quad (\text{AASHTO, Sec. 3.6.1.1.1, p. 3-17})$$

$$E_{\text{One\_Lane\_Loaded}} := \frac{10.0 + 5.0 \cdot \sqrt{L_1 \cdot W_{1\_One\_Lane\_Loaded}}}{12.0} = 13.7433 \quad (\text{AASHTO, Eq. 4.6.2.3-1, p. 4-46})$$

$$E_{\text{Two\_Lanes\_Loaded}} := \frac{\min\left(84.0 + 1.44 \cdot \sqrt{L_1 \cdot W_{1\_Two\_Lanes\_Loaded}}, \frac{12.0 \cdot W}{N_L}\right)}{12.0} = 11.2933 \quad (\text{AASHTO, Eq. 4.6.2.3-2, p. 4-46})$$

$$E := \min(E_{\text{One\_Lane\_Loaded}}, E_{\text{Two\_Lanes\_Loaded}}) = 11.2933$$

$$E_{\text{Fatigue}} := E_{\text{One\_Lane\_Loaded}} = 13.7433$$

## Calculation of Loads

### Lane and Axle Loads:

$$\text{Lane\_Load} := 0.64\text{kdf}$$

$$\text{Axle\_Load}_1 := 8\text{kip}$$

$$\text{Axle\_Load}_{2\_3} := 32\text{kip}$$

$$\text{Tandem\_Axle\_Load} := 25\text{kip}$$

### Equivalent Strip Loads for All Limit States Except Fatigue:

$$\text{Lane\_Load}_{\text{Strip}} := \frac{\text{Lane\_Load}}{E} = 4.723 \times 10^{-3} \cdot \frac{\text{kip}}{\text{in}}$$

$$\text{Axle\_Load}_{1\_Strip} := \frac{\text{Axle\_Load}_1}{E} = 0.7084 \cdot \text{kip}$$

$$\text{Axle\_Load}_{2\_3\_Strip} := \frac{\text{Axle\_Load}_{2\_3}}{E} = 2.8336 \cdot \text{kip}$$

$$\text{Tandem\_Axle\_Load}_{\text{Strip}} := \frac{\text{Tandem\_Axle\_Load}}{E} = 2.2137 \cdot \text{kip}$$

### Equivalent Strip Loads for Fatigue Limit State:

$$\text{Axle\_Load}_{1\_Strip\_Fatigue} := \frac{\text{Axle\_Load}_1}{E_{\text{Fatigue}}} = 0.5821 \cdot \text{kip}$$

$$\text{Axle\_Load}_{2\_3\_Strip\_Fatigue} := \frac{\text{Axle\_Load}_{2\_3}}{E_{\text{Fatigue}}} = 2.3284 \cdot \text{kip}$$

## *Application of Impact Factor*

### Dynamic Load Allowance:

$$IM := 1.33 \quad (\text{AASHTO, Table 3.6.2.1-1, p. 3-30})$$

$$IM_{\text{Fatigue}} := 1.15 \quad (\text{AASHTO, Table 3.6.2.1-1, p. 3-30})$$

### Equivalent Strip Loads for All Limit States Except Fatigue (Including Dynamic Load Allowance):

$$\text{Lane\_Load}_{\text{Strip}} := \frac{\text{Lane\_Load}}{E} = 4.723 \times 10^{-3} \frac{\text{kip}}{\text{in}}$$

$$\text{Axle\_Load}_{1\_Strip\_Impact} := \text{Axle\_Load}_{1\_Strip} \cdot IM = 0.9422 \cdot \text{kip}$$

$$\text{Axle\_Load}_{2\_3\_Strip\_Impact} := \text{Axle\_Load}_{2\_3\_Strip} \cdot IM = 3.7686 \cdot \text{kip}$$

$$\text{Tandem\_Axle\_Load}_{\text{Strip\_Impact}} := \text{Tandem\_Axle\_Load}_{\text{Strip}} \cdot IM = 2.9442 \cdot \text{kip}$$

### Equivalent Strip Loads for Fatigue Limit State (Including Dynamic Load Allowance):

$$\text{Axle\_Load}_{1\_Strip\_Fatigue\_Impact} := \text{Axle\_Load}_{1\_Strip\_Fatigue} \cdot IM_{\text{Fatigue}} = 0.6694 \cdot \text{kip}$$

$$\text{Axle\_Load}_{2\_3\_Strip\_Fatigue\_Impact} := \text{Axle\_Load}_{2\_3\_Strip\_Fatigue} \cdot IM_{\text{Fatigue}} = 2.6777 \cdot \text{kip}$$

## 44-ft. Roadway

### *Calculation of Equivalent Strip Width*

All length units are in feet

$$\text{Span\_Length} := 32$$

$$\text{Bridge\_Width} := 44$$

$$L_1 := \min(\text{Span\_Length}, 60.0) = 32 \quad (\text{AASHTO, Sec. 4.6.2.3, p. 4-46})$$

$$W := \text{Bridge\_Width} = 44$$

$$W_{1\_One\_Lane\_Loaded} := \min(W, 30.0) = 30 \quad (\text{AASHTO, Sec. 4.6.2.3, p. 4-46})$$

$$W_{1\_Two\_Lanes\_Loaded} := \min(W, 60.0) = 44 \quad (\text{AASHTO, Sec. 4.6.2.3, p. 4-46})$$

$$N_L := \text{floor}\left(\frac{W}{12.0}\right) = 3 \quad (\text{AASHTO, Sec. 3.6.1.1.1, p. 3-17})$$

$$E_{\text{One\_Lane\_Loaded}} := \frac{10.0 + 5.0 \cdot \sqrt{L_1 \cdot W_{1\_One\_Lane\_Loaded}}}{12.0} = 13.7433 \quad (\text{AASHTO, Eq. 4.6.2.3-1, p. 4-46})$$

$$E_{\text{Two\_Lanes\_Loaded}} := \frac{\min\left(84.0 + 1.44 \cdot \sqrt{L_1 \cdot W_{1\_Two\_Lanes\_Loaded}}, \frac{12.0 \cdot W}{N_L}\right)}{12.0} = 11.5028 \quad (\text{AASHTO, Eq. 4.6.2.3-2, p. 4-46})$$

$$E := \min(E_{\text{One\_Lane\_Loaded}}, E_{\text{Two\_Lanes\_Loaded}}) = 11.5028$$

$$E_{\text{Fatigue}} := E_{\text{One\_Lane\_Loaded}} = 13.7433$$



## Calculation of Loads

### Lane and Axle Loads:

$$\text{Lane\_Load} := 0.64\text{klf}$$

$$\text{Axle\_Load}_1 := 8\text{kip}$$

$$\text{Axle\_Load}_{2\_3} := 32\text{kip}$$

$$\text{Tandem\_Axle\_Load} := 25\text{kip}$$

### Equivalent Strip Loads for All Limit States Except Fatigue:

$$\text{Lane\_Load}_{\text{Strip}} := \frac{\text{Lane\_Load}}{E} = 4.637 \times 10^{-3} \frac{\text{kip}}{\text{in}}$$

$$\text{Axle\_Load}_{1\_Strip} := \frac{\text{Axle\_Load}_1}{E} = 0.6955 \cdot \text{kip}$$

$$\text{Axle\_Load}_{2\_3\_Strip} := \frac{\text{Axle\_Load}_{2\_3}}{E} = 2.7819 \cdot \text{kip}$$

$$\text{Tandem\_Axle\_Load}_{\text{Strip}} := \frac{\text{Tandem\_Axle\_Load}}{E} = 2.1734 \cdot \text{kip}$$

### Equivalent Strip Loads for Fatigue Limit State:

$$\text{Axle\_Load}_{1\_Strip\_Fatigue} := \frac{\text{Axle\_Load}_1}{E_{\text{Fatigue}}} = 0.5821 \cdot \text{kip}$$

$$\text{Axle\_Load}_{2\_3\_Strip\_Fatigue} := \frac{\text{Axle\_Load}_{2\_3}}{E_{\text{Fatigue}}} = 2.3284 \cdot \text{kip}$$

## *Application of Impact Factor*

Dynamic Load Allowance:

$$IM := 1.33 \quad (\text{AASHTO, Table 3.6.2.1-1, p. 3-30})$$

$$IM_{\text{Fatigue}} := 1.15 \quad (\text{AASHTO, Table 3.6.2.1-1, p. 3-30})$$

Equivalent Strip Loads for All Limit States Except Fatigue (Including Dynamic Load Allowance):

$$\text{Lane\_Load}_{\text{Strip}} := \frac{\text{Lane\_Load}}{E} = 4.637 \times 10^{-3} \frac{\text{kip}}{\text{in}}$$

$$\text{Axle\_Load}_{1\_Strip\_Impact} := \text{Axle\_Load}_{1\_Strip} \cdot IM = 0.925 \cdot \text{kip}$$

$$\text{Axle\_Load}_{2\_3\_Strip\_Impact} := \text{Axle\_Load}_{2\_3\_Strip} \cdot IM = 3.7 \cdot \text{kip}$$

$$\text{Tandem\_Axle\_Load}_{\text{Strip\_Impact}} := \text{Tandem\_Axle\_Load}_{\text{Strip}} \cdot IM = 2.8906 \cdot \text{kip}$$

Equivalent Strip Loads for Fatigue Limit State (Including Dynamic Load Allowance):

$$\text{Axle\_Load}_{1\_Strip\_Fatigue\_Impact} := \text{Axle\_Load}_{1\_Strip\_Fatigue} \cdot IM_{\text{Fatigue}} = 0.6694 \cdot \text{kip}$$

$$\text{Axle\_Load}_{2\_3\_Strip\_Fatigue\_Impact} := \text{Axle\_Load}_{2\_3\_Strip\_Fatigue} \cdot IM_{\text{Fatigue}} = 2.6777 \cdot \text{kip}$$

## **Appendix B - Sample Calculations for Limit State Design**

Appendix B shows sample design calculations for the short-span bridge system. Specifically, design in the positive moment region for the 32-ft., haunched-slab section at midspan is included. Identical calculations were carried out at each tenth-point in the span for all spans and profiles under consideration. The appropriate calculations were performed for negative moment as well.

Input parameters used in design are presented first. Calculations are then separated according to strength, service, and fatigue limit states. Strength I limit state considers ultimate moment design. Service I limit state includes provisions for distribution of longitudinal reinforcement, distribution of transverse reinforcement, minimum reinforcement for ductility, and shrinkage and temperature reinforcement. Fatigue limit state pertains to checking and limiting stress ranges in reinforcing steel.

## Input Parameters

Span Length: 32 ft

Location: Five-tenths point (Midspan)

For Positive Moment:

Analyzing a 1-ft. wide strip:

### Inputs:

$$b := 12\text{in}$$

$$f_c' := 4\text{ksi}$$

$$c_{c\_top} := 3\text{in}$$

$$\epsilon_{cu} := 0.003$$

$$h := 13.5\text{in}$$

$$f_y := 60\text{ksi}$$

$$c_{c\_bot} := 1\text{in}$$

$$\text{Length}_{\text{Span}} := 384\text{in}$$

$$M_u := 836.7\text{kip}\cdot\text{in}$$

$$M_s := 520.5\text{kip}\cdot\text{in}$$

$$M_{\text{Range}} := 132.0\text{kip}\cdot\text{in}$$

$$M_{\min} := 0\text{kip}\cdot\text{in}$$

(AASHTO, Sec. 5.5.3.2, p. 5-24)

$$E_s := 29000\text{ksi}$$

(AASHTO, Sec. 5.4.3.2, p. 5-19)

### Transverse Steel:

Transverse Bottom Steel: 1 #5 bar per 12 in

Transverse Top Steel: 1 #4 bar per 16 in

$$A_{5\_bar} := 0.31\text{in}^2$$

(ACI 318-08, Appx. E, p. 439)

$$A_{4\_bar} := 0.20\text{in}^2$$

(ACI 318-08, Appx. E, p. 439)

$$A_{s\_transverse\_bottom} := \left(A_{5\_bar}\right) \cdot \frac{12\text{in}}{12\text{in}} = 0.31\text{in}^2$$

$$A_{s\_transverse\_top} := \left(A_{4\_bar}\right) \cdot \frac{12\text{in}}{16\text{in}} = 0.15\text{in}^2$$

$$s_{\max\_transverse\_bottom} := 12\text{in}$$

$$s_{\max\_transverse\_top} := 16\text{in}$$

### Longitudinal Steel:

Tension Steel: 4 #6 bars and 1 #7 bar per 20 in

Compression Steel: 1 #4 bar per 15 in

$$d_{4\_bar} := 0.50\text{in} \quad (\text{ACI 318-08, Appx. E, p. 439})$$

$$A_{4\_bar} := 0.20\text{in}^2 \quad (\text{ACI 318-08, Appx. E, p. 439})$$

$$d_{6\_bar} := 0.75\text{in} \quad (\text{ACI 318-08, Appx. E, p. 439})$$

$$A_{6\_bar} := 0.44\text{in}^2 \quad (\text{ACI 318-08, Appx. E, p. 439})$$

$$d_{7\_bar} := 0.875\text{in} \quad (\text{ACI 318-08, Appx. E, p. 439})$$

$$A_{7\_bar} := 0.60\text{in}^2 \quad (\text{ACI 318-08, Appx. E, p. 439})$$

$$A_{st} := (4A_{6\_bar} + 1A_{7\_bar}) \cdot \frac{b}{20\text{in}} = 1.42 \cdot \text{in}^2$$

$$A_{sc} := (A_{4\_bar}) \cdot \frac{b}{15\text{in}} = 0.16 \cdot \text{in}^2$$

$$s_{\text{max\_longitudinal\_bottom}} := 4\text{in}$$

$$s_{\text{max\_longitudinal\_top}} := 15\text{in}$$

## Strength I Limit State Design

$$d := h - c_{c\_bot} - \frac{d_{7\_bar}}{2} = 12.06 \text{ in}$$

$$d' := c_{c\_top} + \frac{d_{4\_bar}}{2} = 3.25 \text{ in}$$

$$\beta_1 := \begin{cases} 0.85 & \text{if } f_c' \leq 4 \text{ ksi} \\ 0.85 - 0.05 \cdot \frac{(f_c' - 4 \text{ ksi})}{1 \text{ ksi}} & \text{if } 4 \text{ ksi} < f_c' < 8 \text{ ksi} \\ 0.65 & \text{otherwise} \end{cases} = 0.85 \quad (\text{AASHTO, Sec. 5.7.2.2, p. 5-39})$$

$$A_{st} \cdot f_y = 0.85 \cdot \beta_1 \cdot f_c' \cdot b \cdot c + A_{sc} \cdot \epsilon_{cu} \cdot E_s \cdot \left( \frac{c - d'}{c} \right) \quad (\text{Nilson, Eq. 3.56, p. 102})$$

$$c := \frac{-(A_{sc} \cdot \epsilon_{cu} \cdot E_s - A_{st} \cdot f_y) + \sqrt{(A_{sc} \cdot \epsilon_{cu} \cdot E_s - A_{st} \cdot f_y)^2 - 4 \cdot (0.85 \cdot \beta_1 \cdot f_c' \cdot b) \cdot (-A_{sc} \cdot \epsilon_{cu} \cdot E_s \cdot d')}}{2 \cdot (0.85 \cdot \beta_1 \cdot f_c' \cdot b)} = 2.56 \text{ in}$$

$$a := \beta_1 \cdot c = 2.17 \text{ in} \quad (\text{AASHTO, Sec. 5.7.3.2, p. 5-44})$$

$$f_s' := \min \left[ \max \left[ \epsilon_{cu} \cdot E_s \cdot \left( \frac{c - d'}{c} \right), -f_y \right], f_y \right] = -23.52 \text{ ksi} \quad (\text{Nilson, Eq. 3.55, p. 102})$$

$$c_b := d \cdot \frac{\epsilon_{cu}}{\epsilon_{cu} + \frac{f_y}{E_s}} = 7.14 \text{ in} \quad (\text{Nilson, Eq. 8.15, p. 273})$$

$$\text{Beam\_Column\_Check} := \begin{cases} \text{"OK"} & \text{if } c < c_b \\ \text{"Not Tension-Controlled"} & \text{otherwise} \end{cases} = \text{"OK"}$$

Beam columns are conservatively analyzed as beams as long as  $c$  is less than the balanced  $c$ , ensuring the beam column is in the tension-controlled region:

$$M_n := A_{st} \cdot f_y \cdot \left( d - \frac{a}{2} \right) - A_{sc} \cdot f_s' \cdot \left( d' - \frac{a}{2} \right) = 941 \text{ kip} \cdot \text{in} \quad (\text{AASHTO, Eq. 5.7.3.2.2-1, p. 5-43})$$

$$\frac{c}{d} = 0.212$$

$$\phi_f := \begin{cases} 0.9 & \text{if } \frac{c}{d} \leq 0.375 \\ 0.65 + 0.15 \cdot \left( \frac{d}{c} - 1 \right) & \text{if } 0.375 < \frac{c}{d} < 0.6 \\ 0.75 & \text{otherwise} \end{cases} = 0.9$$

(AASHTO, Fig. C5.5.4.2.1-1, p. 5-27)

$$M_r := |\phi_f \cdot M_n| = 847 \cdot \text{kip} \cdot \text{in} \quad (\text{AASHTO, Eq. 5.7.3.2.1-1, p. 5-43})$$

$$FS_{\text{Ultimate}} := \left| \frac{M_r}{M_u} \right| = 1.012$$

$$\text{Strength\_Limit\_State\_Check} := \begin{cases} \text{"Insufficient Strength"} & \text{if } FS_{\text{Ultimate}} < 1 \\ \text{"OK"} & \text{otherwise} \end{cases} = \text{"OK"}$$

## Service I Limit State Design

### *Distribution of Longitudinal Reinforcement*

$$f_r := 0.24 \text{ksi} \cdot 0.5 \sqrt{f_c'} = 0.48 \text{-ksi} \quad (\text{AASHTO, Sec. 5.4.2.6, p. 5-18})$$

$$E_c := 1820 \text{ksi} \cdot 0.5 \sqrt{f_c'} = 3640 \text{-ksi} \quad (\text{AASHTO, Eq. C5.4.2.4-1, p. 5-17})$$

$$n := \text{round} \left( \frac{E_s}{E_c} \right) = 8 \quad (\text{AASHTO, Sec. 5.7.1, p. 5-36})$$

$$y_g := \frac{b \cdot h \cdot \frac{h}{2} + (n-1) \cdot A_{sc} \cdot d' + (n-1) \cdot A_{st} \cdot d}{b \cdot h + (n-1) \cdot A_{sc} + (n-1) \cdot A_{st}} = 7.03 \text{-in}$$

$$b \cdot y_{cr} \cdot \left( \frac{y_{cr}}{2} \right) + (n-1) \cdot A_{sc} \cdot (y_{cr} - d') = n \cdot A_{st} \cdot (d - y_{cr})$$

$$y_{cr} := \frac{-[(n-1) \cdot A_{sc} + n \cdot A_{st}] + \sqrt{[(n-1) \cdot A_{sc} + n \cdot A_{st}]^2 - 4 \cdot \left( \frac{b}{2} \right) \cdot [(n-1) \cdot A_{sc} \cdot d' + n \cdot A_{st} \cdot d]}}{2 \cdot \left( \frac{b}{2} \right)} = 3.91 \text{-in}$$

$$I_g := \frac{1}{12} \cdot b \cdot h^3 + b \cdot h \cdot \left( \frac{h}{2} - y_g \right)^2 + (n-1) \cdot A_{sc} \cdot (y_g - d')^2 + (n-1) \cdot A_{st} \cdot (d - y_g)^2 = 2740 \text{-in}^4$$

$$I_{cr} := \frac{1}{12} \cdot b \cdot y_{cr}^3 + b \cdot y_{cr} \cdot \left( \frac{y_{cr}}{2} \right)^2 + (n-1) \cdot A_{sc} \cdot (y_{cr} - d')^2 + n \cdot A_{st} \cdot (d - y_{cr})^2 = 992 \text{-in}^4$$

$$S_c := \frac{I_g}{h - y_g} = 424 \text{-in}^3$$

$$M_{cr} := S_c \cdot f_r = 203 \text{-kip} \cdot \text{in} \quad (\text{AASHTO, Eq. 5.7.3.3.2-1, p. 5-45})$$

$$f_s := \min \left[ \begin{array}{l} \frac{n \cdot |M_s| \cdot (d - y_g)}{I_g} \text{ if } |M_s| < M_{cr} \\ \frac{n \cdot |M_s| \cdot (d - y_{cr})}{I_{cr}} \text{ otherwise} \end{array} \right] = 34.21 \text{-ksi}$$

$$\gamma_e := 1.00 \quad (\text{AASHTO, Sec. 5.7.3.4, p. 5-47})$$



$$\beta_s := 1 + \frac{h - d}{0.7 \cdot [h - (h - d)]} = 1.17 \quad (\text{AASHTO, Sec. 5.7.3.4, p. 5-47})$$

$$s_{\max\_DR} := \frac{700 \frac{\text{kip}}{\text{in}} \cdot \gamma_e}{\beta_s \cdot f_s} - 2 \cdot (h - d) = 14.61 \cdot \text{in} \quad (\text{AASHTO, Eq. 5.7.3.4-1, p. 5-46})$$

$$s_{\max\_longitudinal\_bottom} = 4 \cdot \text{in}$$

$$\text{Longitudinal\_Reinforcement\_Check} := \begin{cases} \text{"Excessive Spacing"} & \text{if } s_{\max\_longitudinal\_bottom} > s_{\max\_DR} \\ \text{"OK"} & \text{otherwise} \end{cases} = \text{"OK"}$$

### *Distribution of Transverse Reinforcement*

$$A_{s\_transverse\_factor} := \min\left(\frac{1\text{in}^{0.5}}{\sqrt{\text{Length}_{\text{Span}}}}, 0.5\right) = 0.051 \quad (\text{AASHTO, Eq. 5.14.4.1-1, p. 5-238})$$

$$A_{s\_transverse\_required} := A_{st} \cdot A_{s\_transverse\_factor} = 0.072 \cdot \text{in}^2 \quad (\text{On a per foot basis})$$

(AASHTO, Sec. 5.14.4.1, p. 5-238)

$$A_{s\_transverse\_bottom} = 0.31 \cdot \text{in}^2$$

$$\text{Transverse\_Reinforcement\_Check} := \begin{cases} \text{"OK"} & \text{if } A_{s\_transverse\_bottom} > A_{s\_transverse\_required} \\ \text{"Insufficient Reinforcement"} & \text{otherwise} \end{cases} = \text{"OK"}$$

### *Minimum Reinforcement*

$$M_{I\_required} := \min(1.2 \cdot M_{cr}, 1.33 \cdot |M_u|) = 244 \cdot \text{kip} \cdot \text{in}$$

(AASHTO, Sec. 5.7.3.3.2, p. 5-45 and p. 5-46)

$$M_I = 847 \cdot \text{kip} \cdot \text{in}$$

$$\text{Minimum\_Reinforcement\_Check} := \begin{cases} \text{"OK"} & \text{if } M_I > M_{I\_required} \\ \text{"Insufficient Ductility"} & \text{otherwise} \end{cases} = \text{"OK"}$$

### *Shrinkage and Temperature Reinforcement*

$$A_{s\_min} := \min \left[ \max \left[ 0.11 \text{in}^2, \frac{1.30 \frac{\text{kip}}{\text{in}} \cdot b \cdot h}{2 \cdot (b + h) \cdot f_y} \right], 0.6 \text{in}^2 \right] = 0.11 \cdot \text{in}^2 \quad (\text{AASHTO, Eq. 5.10.8-1, p. 5-124})$$

$$A_{s\_sc} = 0.16 \cdot \text{in}^2 \quad (\text{AASHTO, Eq. 5.10.8-2, p. 5-124})$$

$$A_{s\_transverse\_top} = 0.15 \cdot \text{in}^2$$

$$ST\_Area\_Check := \begin{cases} \text{"Insufficient Longitudinal Steel Area"} & \text{if } A_{s\_min} > A_{s\_sc} & = \text{"OK"} \\ \text{"Insufficient Transverse Steel Area"} & \text{if } A_{s\_min} > A_{s\_transverse\_top} \\ \text{"OK"} & \text{otherwise} \end{cases}$$

$$s_{max\_ST} := \min(3 \cdot h, 18 \text{in}) = 18 \cdot \text{in} \quad (\text{AASHTO Sec. 5.10.8, p. 5-125})$$

$$s_{max\_longitudinal\_top} = 15 \cdot \text{in}$$

$$s_{max\_transverse\_top} = 16 \cdot \text{in}$$

$$ST\_Spacing\_Check := \begin{cases} \text{"Excessive Longitudinal Spacing"} & \text{if } s_{max\_longitudinal\_top} > s_{max\_ST} = \text{"OK"} \\ \text{"Excessive Transverse Spacing"} & \text{if } s_{max\_transverse\_top} > s_{max\_ST} \\ \text{"OK"} & \text{otherwise} \end{cases}$$

### **Fatigue Limit State Design**

$$f_{min} := \frac{n \cdot M_{min} \cdot (d - y_{cr})}{I_{cr}} = 0 \cdot \text{ksi}$$

$$f_{f\_allowable} := 24 \text{ksi} - 0.33 \cdot f_{min} = 24 \cdot \text{ksi} \quad (\text{AASHTO, Eq. 5.5.3.2-1, p. 5-24})$$

$$f_f := \frac{n \cdot M_{Range} \cdot (d - y_{cr})}{I_{cr}} = 8.7 \cdot \text{ksi}$$

$$Fatigue\_Check := \begin{cases} \text{"Excessive Stress Range"} & \text{if } f_f > f_{f\_allowable} & = \text{"OK"} \\ \text{"OK"} & \text{otherwise} \end{cases}$$