

TESTS OF A SINGLE PHASE INDUCTION MOTOR.

F. E. Hodgson

and

J. H. Johnson.

## OUTLINE.

1. Commercial uses.
  - (a) Advantages.
  - (b) Disadvantages.
2. Structure.
  - (a) Stator.
  - (b) Rotor.
3. Theory of operation.
  - (a) Field.
  - (b) Rotor.
4. Current -- Voltage relations.
5. Ratio of transformation.
  - (a) Magnetic leakage.
6. Starting devices.
  - (a) Resistance in armature.
  - (b) Starting compensator.
  - (c) Direction of rotation.
7. Speed regulation.
  - (a) Resistance in armature.
  - (b) Voltage.
  - (c) Frequency.
8. Curve discussion.
9. Heat run.

Commercial Uses.

With the growing electrical industry there is an increasing demand for convenient, efficient and practical means of utilizing electrical energy. The combined efforts of the designer and manufacturer have produced an electric motor to suit the various demands made upon it.

The direct current and synchronous motors still hold their respective places in the conversion of electrical into mechanical energy. While these motors hold a place which, perhaps no other motor can hold, they are at the same time found unsatisfactory in many modern requirements. The question might justly be asked why these motors do not fill all the requirements of an electric motor, why is the induction motor coming into use and what are its advantages?

Probably a strong point in favor of the induction motor is its adaptability to the present use of alternating current; however the synchronous motor with its characteristic faults also holds a place in this field. The shunt and series motor might also be used on alternating current; however the shunt motor has the objection that in the armature the current is in phase with the E.M.F. while the high inductance in the fields gives the currents in them about 90 degrees lag, thus throwing the armature current and field current out of phase with each other. To overcome this objection the field may be excited from a separate E.M.F. differing in phase 90 degrees from that supplied to the armature. A quarter phase machine would do this, one phase furnishing current for the armature while the other supplied the field, but this would load the two phases

PLATE 1

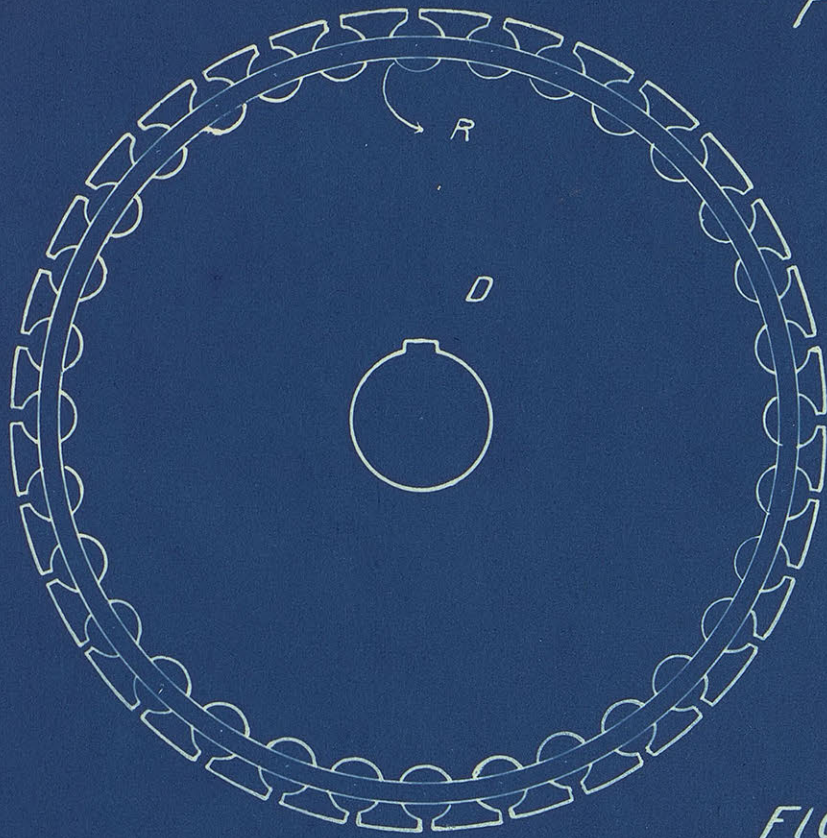
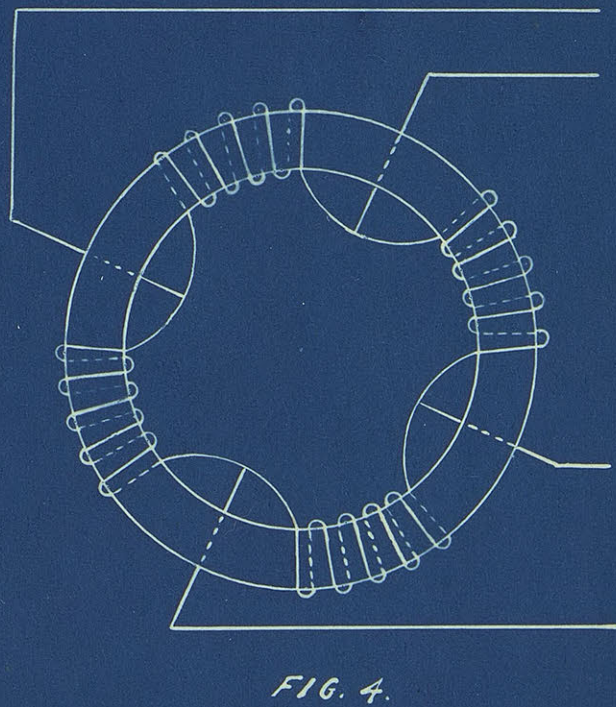
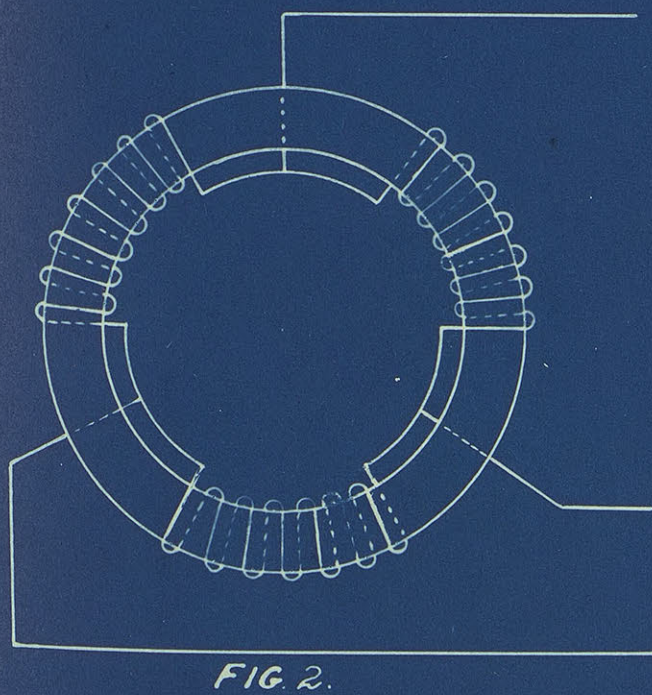
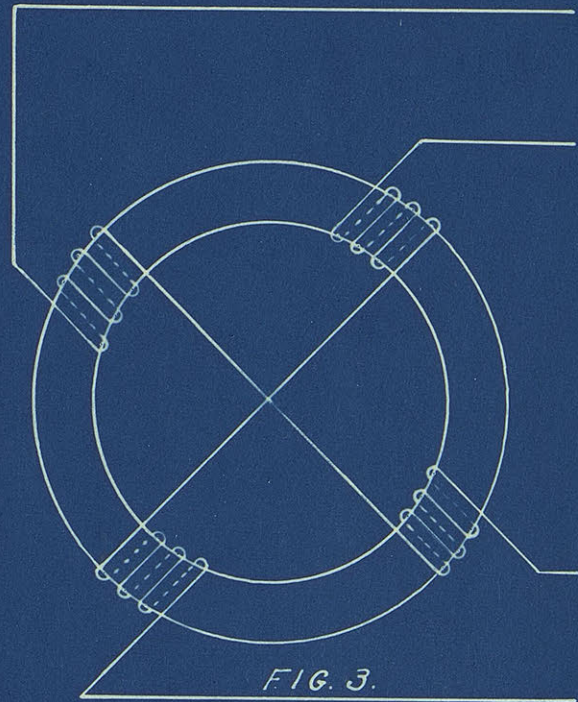
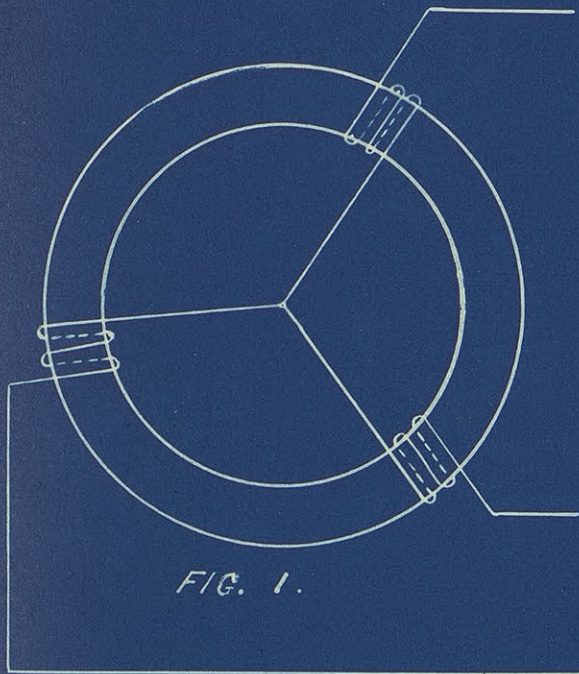

FIG. 1.



FIG. 2.

PLATE 2.



disc shape with partially closed holes on the periphery to receive the secondary windings. Fig. 2, plate 1 shows a rotor of the squirrel cage type. A number of these thin stampings clamped together on the armature shaft constitute the drum. By placing the slots of the stampings all opposite each other a long slot is formed on the drum parallel to the armature shaft. In these slots are placed heavy copper rods which project over at the ends when they are all connected by a heavy copper ring.

If the motor is to be started under load a winding other than the squirrel cage is used. Fig.'s 1 and 2 plate 3 show two common forms of armature winding. Fig. 1 illustrates a three phase winding with resistance in the three legs. This resistance is inserted on starting and can be thrown out by the attendant or by an automatic device when the motor acquires full speed. Fig. 2 shows a winding in which its terminals are brought out to slip rings on the armature shaft. By this means a starting resistance can be inserted in the armature circuit and operated some distance from the motor, the connection being through brushes of slip rings.

THEORY of OPERATION.

If a horse-shoe magnet be held over a compass needle, the needle will take a position parallel to the lines of force, leaving the north pole and entering the south pole of the magnet. If the magnet be rotated it is evident that the needle will rotate to keep its relative position with the lines of force. If a four pole field be placed around the needle and one pair of poles be first excited and then the other, the needle will take the position shown in Fig.'s 1 and 2 Plate 4. If both pair of poles be excited at the same time the needle will assume the position shown in Fig. 3, Plate 4. Now if

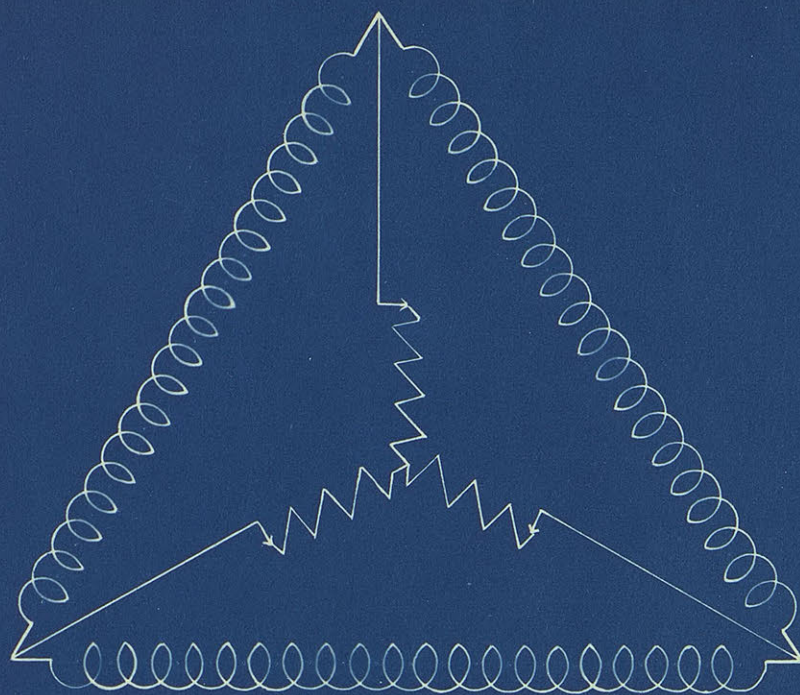

FIG. 1.

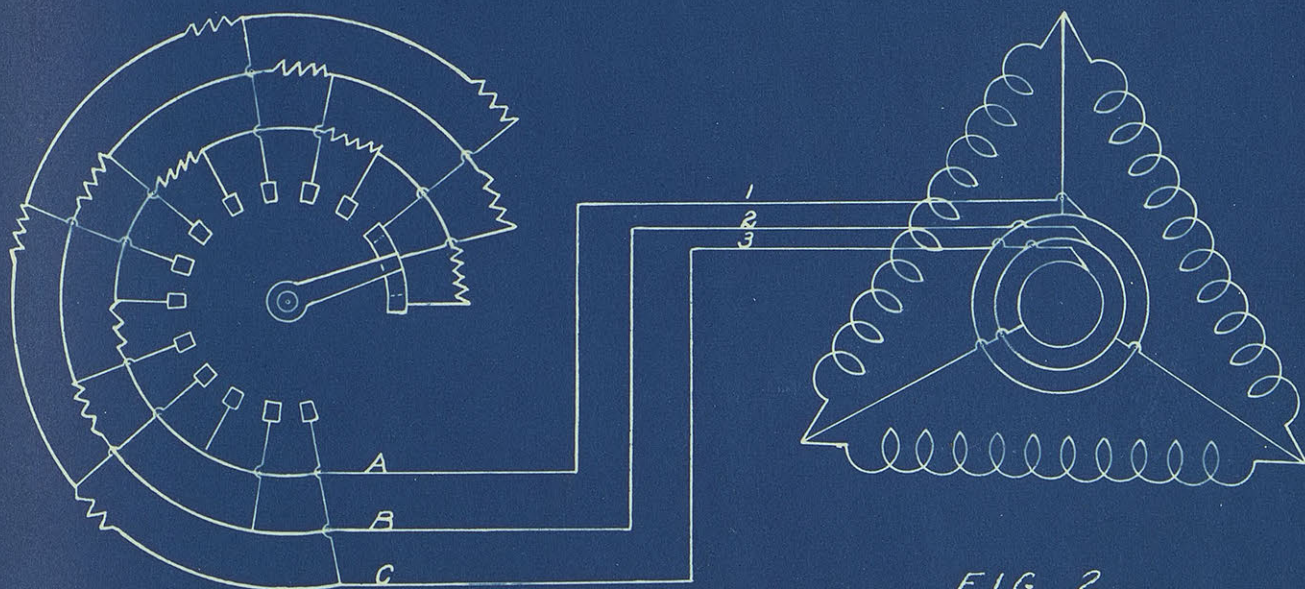

FIG. 2.

unsymmetrically and be unsatisfactory. The series motors have been used to a limited extent, their main objection being the excessive self induction introduced by the alternating field current, and the consequent low power factor, combined with vicious sparking at the commutator.

The synchronous motors do not have sufficient starting torque to bring them up to speed under load. It is therefore necessary to have at hand some auxiliary source of power. The induction or synchronous motor is very satisfactory for polyphase circuits. The synchronous motor has the objection of speed variation.

For the same output the induction motor usually has the advantage in weight, space of installing, minimum repairs, great durability and slight attention. In the point of commercial efficiency it is not difficult to build an induction motor which is fully up to the average efficiency of other motors of similar output. The slip rings are dispensed with leaving no chance for sparking. The polyphase induction motor, unlike the synchronous, can be started under load. (The different methods for starting will be given under "starting devices").

While the polyphase motor has a varied use there are conditions under which the single phase induction motor is considered more desirable. These motors have the advantage of being used on a single phase light circuit of a three phase system, and for motors up to certain sizes they are preferred owing to the comparative small first cost of transformers, line construction etc. The two or three phase motors necessitate either two or three transformers, four or three primary wires, and as many secondary wires from the



transformers to the motors.

#### STRUCTURE.

The induction motor consists of a primary and a secondary member, each provided with a winding. The primary member (commonly called stator) serves as a field and usually receives the alternating impressed E.M.F. from the line. The secondary member (commonly called rotar) serves as an armature on which the rotary field produces the operative torque.

The stator or stationary member of the induction motor is built up of soft laminated iron stampings held firmly in a cast iron case and closely surrounding the rotor. The inner cylindrical surface of this stator is slotted as shown in Fig.1, Plate 1, to receive the primary winding. Each projection of the stator core does not necessarily mean a pole, since a distributed winding is generally used. The slots are insulated with micanite or other insulating material. In some monophase motors there are two distinct windings, one being the running winding always in circuit, the other the starting winding, being in circuit only at starting. The purpose of this latter winding is to provide a magnetization, the action of which, on the rotor circuits produce the starting torque.

In di-phase motors there are two and in ~~the~~<sup>e</sup> phase motors three distinct windings which remain always in circuit. The common winding for the three phase and two phase are shown in plate 2, Fig's 1 and 2 being the star and mesh winding for three phase, while Fig.s 3 and 4 are for two phase winding.

The secondary member is usually the rotating member and is commonly called rotor. The rotor like the stator is built up of soft laminated iron stampings. The rotor stampings are disc shape with

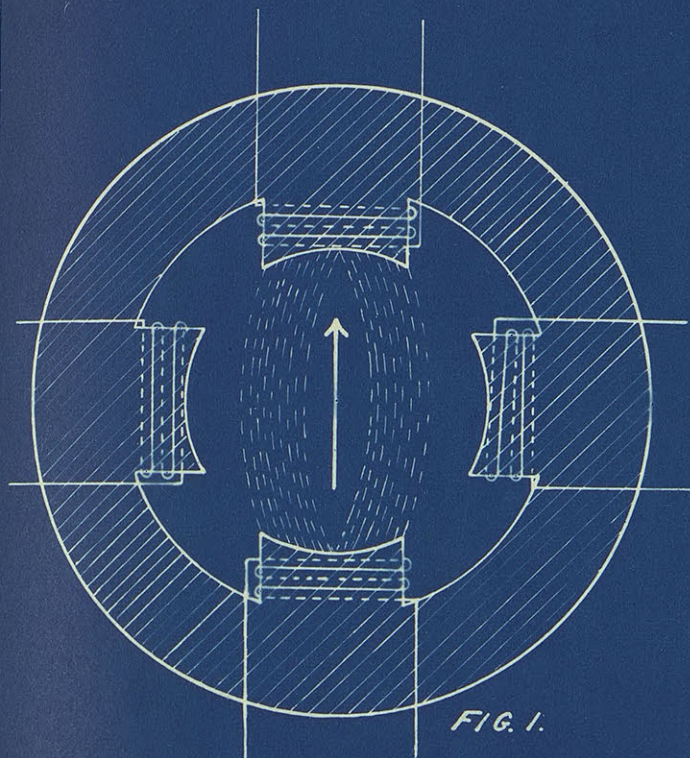

FIG. 1.

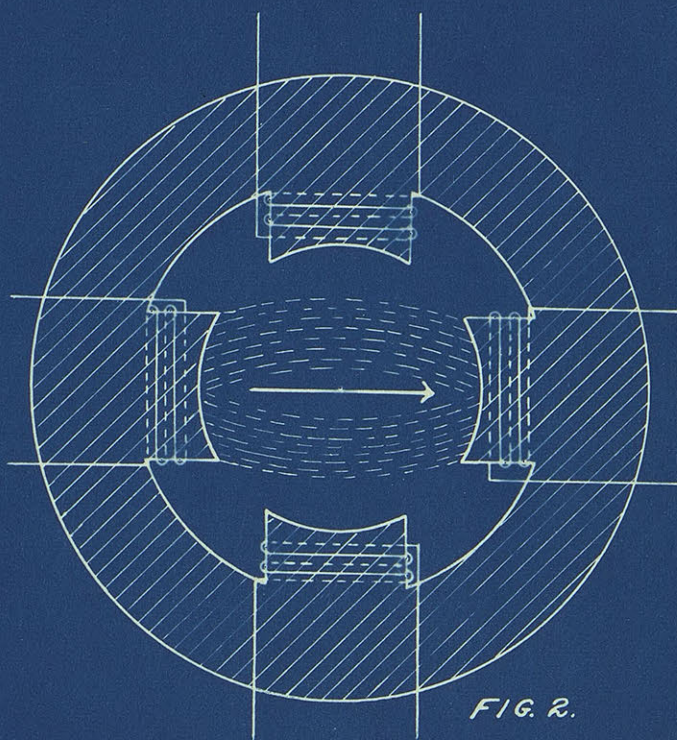

FIG. 2.

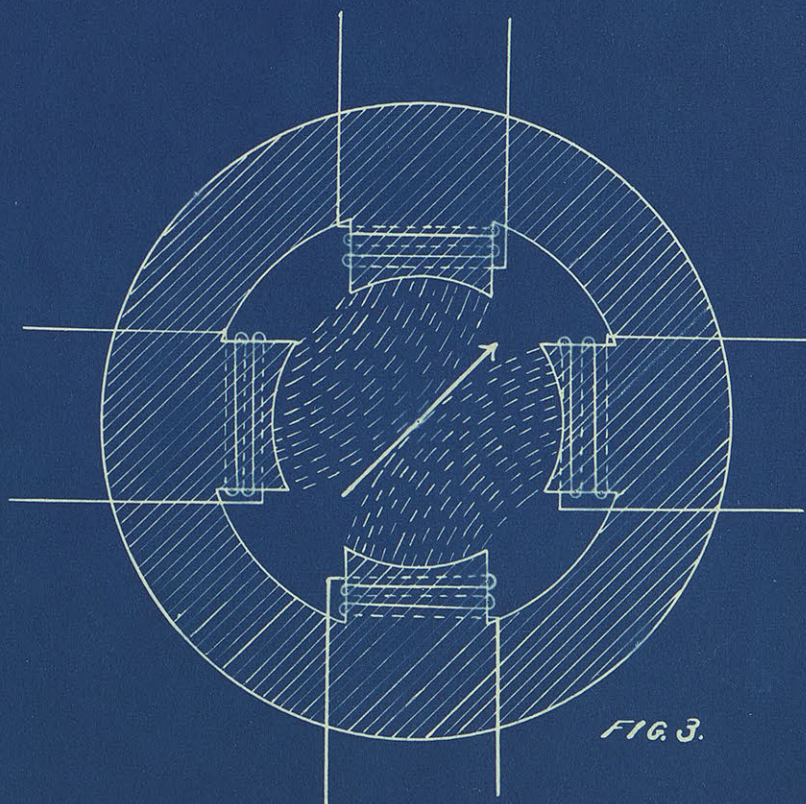

FIG. 3.

these poles be excited with two phase alternating currents one pole will grow weaker while the next is growing stronger and thus the latter will attract the needle. After this pole reaches its maximum strength and begins to die away the next pole begins to increase and thus the needle is kept revolving around in its effort to keep up with the rotating polarity of the field. If, instead of the needle, an iron core or armature with copper conductors parallel to its axis and short circuited on themselves, be placed in the field, rotation will again be produced. The rotation in this case is due to secondary currents being set up in the secondary winding and reacting on the primary winding.

ROTATING STATOR FIELD.

The stator windings are arranged in slots in the stator element Fig. 1, Plate 1, exactly in the same manner as those on the armature of the three phase or two-phase alternator, according as the motor is to be supplied with three or two phase currents.

Fig. 1, Plate 5 shows a cross section of a two phase, four pole induction motor. The stator conductors are shown in section by the small circles; the slots being omitted for the sake of clearness.

Fig. 2, Plate 5, Indicates the connections and current relations of a two phase winding. There are two distinct circuits, the one marked "A" contains all the conductors and carries all the current of one phase, while those marked B constitute the other group of conductors with its phase of 90° from that in A. The cross connections and terminals of only one circuit are shown for the sake of clearness. The conductors of each group are so arranged that the currents are in the opposite direction in adjacent groups as indicated in the figure.

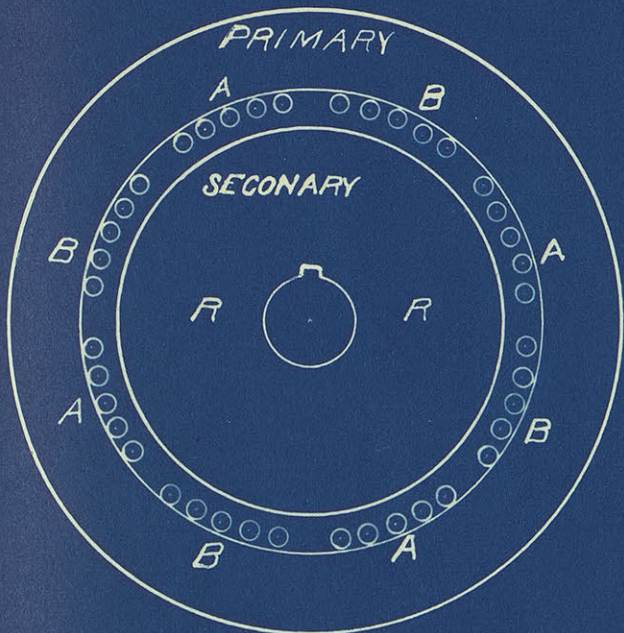

FIG. 1

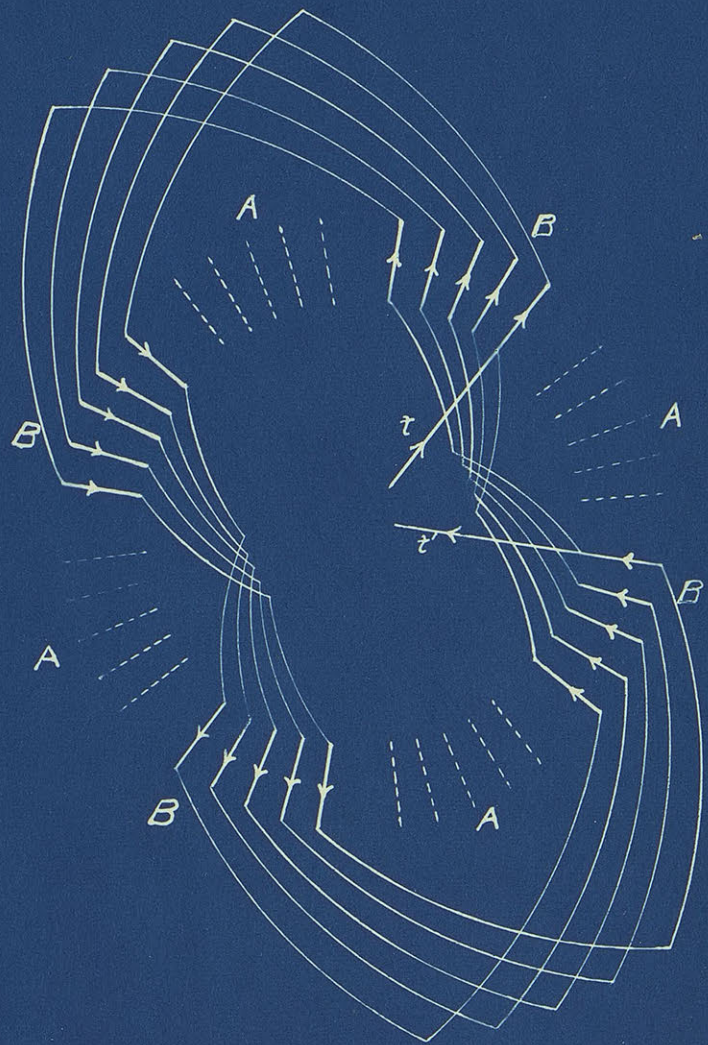

FIG. 2.

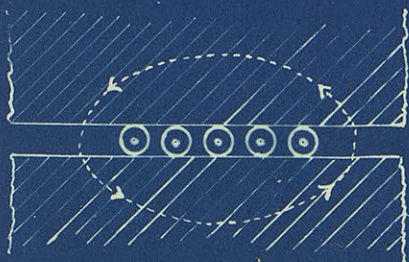

FIG. 3.



FIG. 4.

Fig.'s 3 and 4, Plate 5, show the relative position of the stator conductors and flux path, for the flux set up by the current in these conductors.

In this discussion a small circle with a dot in the center, is to indicate a current flowing out of the plane of the paper toward the observer, while a small circle with a cross in it, is to indicate current flowing from the observer into the plane of the paper, Plate 5, Fig.'s 3 and 4.

The lines A and B, in Fig's 1, 2 and 3, Plate 6 are supposed to show the phase relation in the A and B groups of conductors respectively; while their projection to the right on the current curve shows the current value. The state of affairs when the current in conductor A is a maximum and that in conductor B is zero, is shown in Fig. 1, Plate 6. The dotted lines show the path and direction of the magnetic flux set up by the respective groups of conductors when the current phase and magnitude is as represented by A and B. North poles (N) and south poles (S) indicate where the flux leaves and enters the stator. Figure 2 indicates the relations  $1/8$  of a cycle later when the current in the A conductor has decreased, and the current in B has increased, to the same value. This shows a movement of the poles around the stator to be  $1/16$  of the circumference of the stator. In Fig. 3 is shown the state of affairs after  $1/4$  cycle, when the current in the A conductors has fallen to zero and that in the B conductors increased to maximum.

The poles on the stator have again moved  $1/16$  of the circumference of the stator. Thus it is shown that in this 4-pole motor each quarter cycle moves the N and S poles  $1/8$  of a circumference, or two cycles will move them a complete revolution. Hence in general,

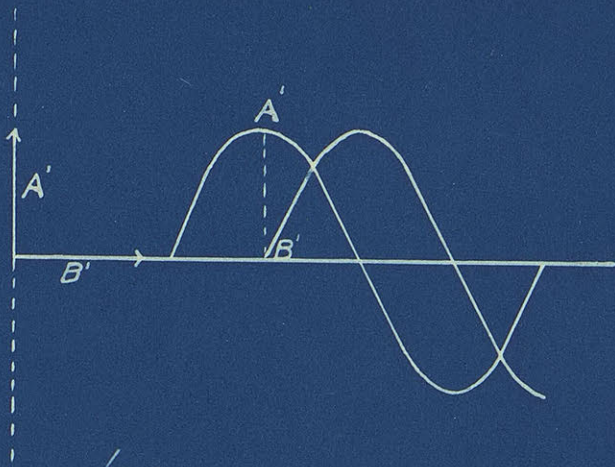

FIG. 1.

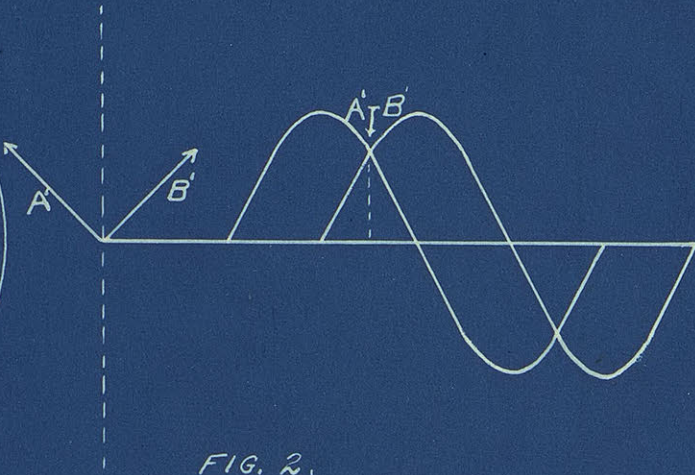
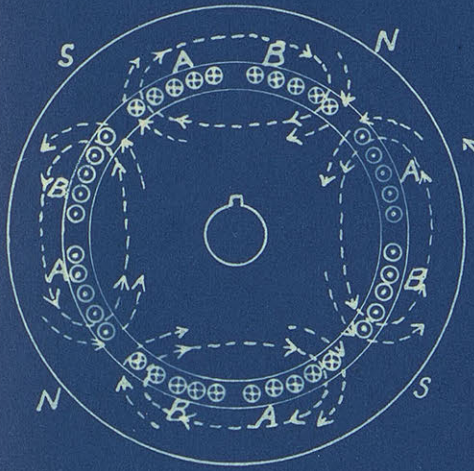

FIG. 2.

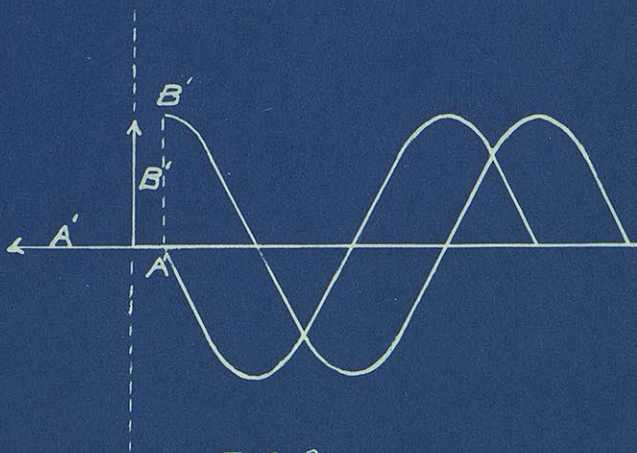
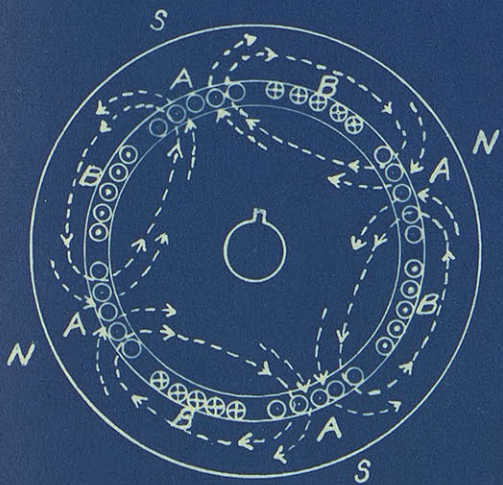

FIG. 3.

if  $n$  is the revolutions per second of the stator magnetism,  $P$  the number of pairs of poles, and  $f$  the frequency of the alternator current applied,  $n = \frac{f}{P}$ . While this clearly represents the rotation of the field in a two phase motor, a similar discussion might be made for other phases.

In the case of a single phase motor the stator coils form a single current fed by a single alternating current. In this the resulting magnetic field preserves a constant direction and simply alternates in sense, as in a stationary transformer; so if the rotor is at rest the alternating currents induced in the rotor coils, produce no torque since the impulses are alternately in opposite directions. If, however, by mechanical means the armature is given an initial velocity, the field exerts a torque and the rotor will increase in speed until nearly in synchronism with the stator field.

#### ROTATION OF SINGLE PHASE ROTOR.

By study of Fig. 1 Plate 7, it would appear that a single phase motor would not start from rest, nor would it run after once being started by mechanical means. Considering Fig. 7, Plate 1, suppose the rotor standing still and the current in the stator increasing from zero to maximum in the direction indicated. While the stator flux is increasing there will be currents set up in the rotor conductors in the direction indicated, thus forming a north pole on the rotor exactly under a south pole on the stator. It is clearly seen that there will be no resultant turning moment to start the rotor nor will it start when the current in the stator changes directions, for we have practically the same condition only that unlike poles are opposite each other, attracting instead of repelling.

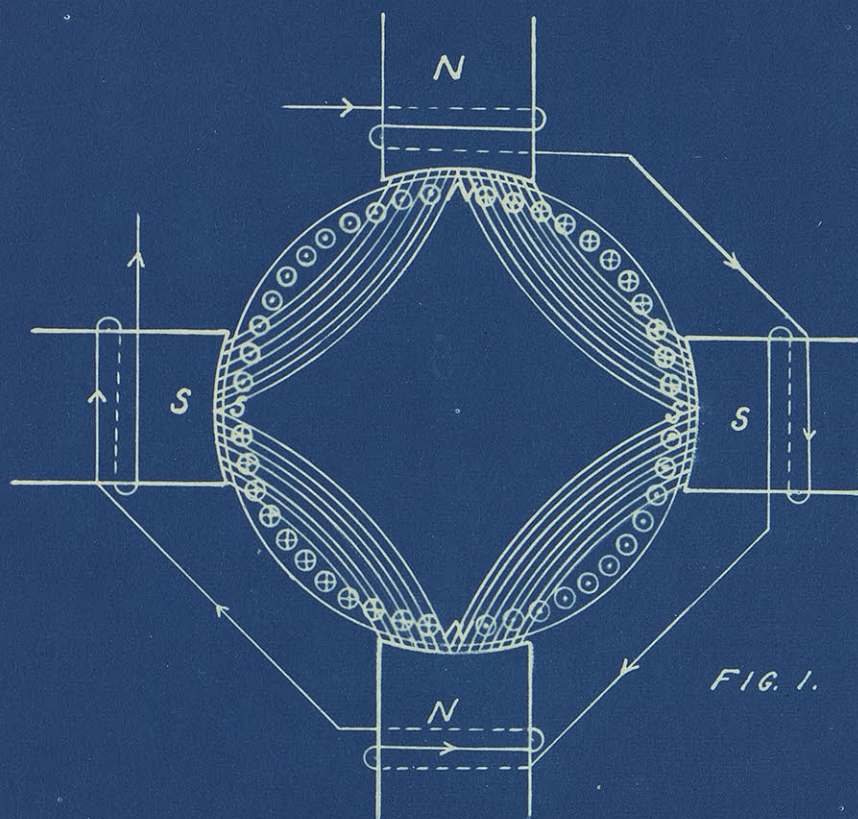

FIG. 1.

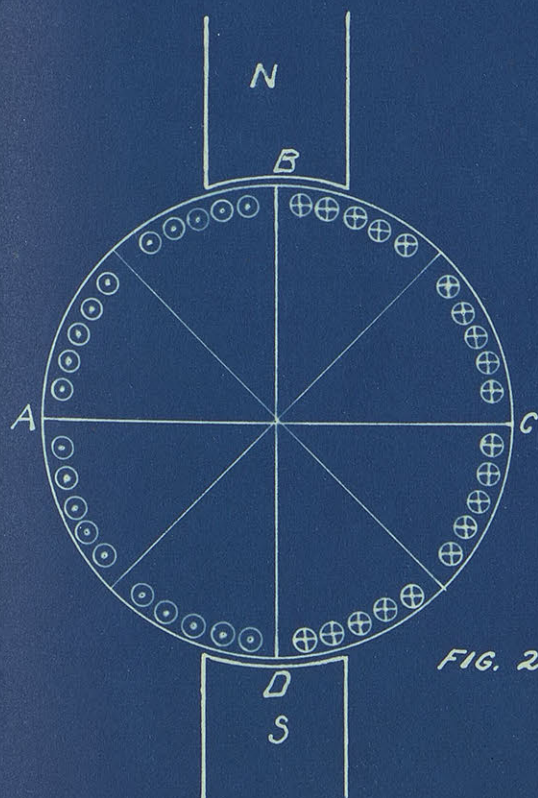

FIG. 2.

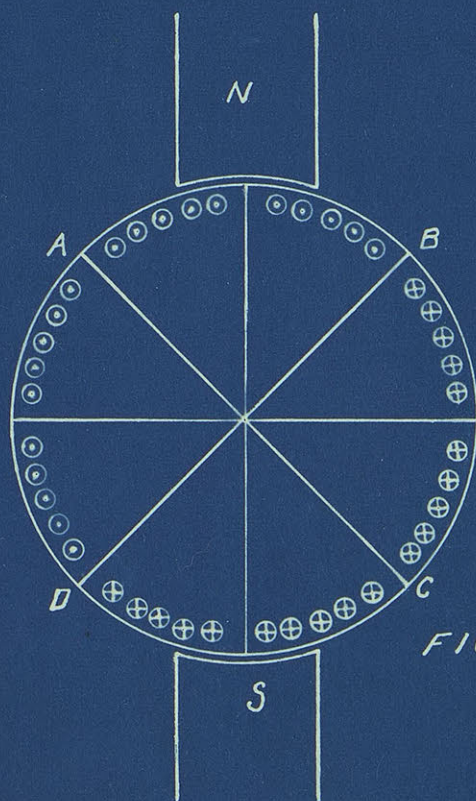

FIG. 3.



Now it appears that if this rotor is given any desired initial velocity, it will never have a torque exerted by the fields. This is clearly true, where the poles are formed on the rotor in the position shown, and this is where the poles would be formed, if it were not for an inductive effect of the rotor winding. The reason why the rotor once set in motion develops a torque in the same directions may be explained as follows.

If the rotor coils have only resistance and no inductance, it is easy to see that for a complete armature, the whole surface of which is covered by coils, the torque will be clock-wise for half the coils and counter-clock-wise for the other half, so the resultant torque is zero. Now if the resistance is small and the inductance fairly large the angle the current in the rotor coils lag behind the rotor E.M.F., will approach  $90^\circ$ . That is the armature will have time to rotate, between the time the E.M.F., is induced and when the current reaches its maximum value. This being the case we do not have the state of affairs shown in Fig. 1 Plate I when the rotor is revolving but instead, the poles on the rotor move out from under those of the stator and there is first a repulsion between poles and then an attraction, thus giving a torque.

Suppose Fig. 2, Plate 7 to represent a section through the rotor with one pair of poles surrounding it. If the rotor is stationary as the pole strength increases from zero to maximum, there will be currents set up in the rotor conductors as indicated in Fig. 2, thus forming a north pole on the rotor under a north pole of the field and a south pole on the rotor under a south pole of the field.

Quadrants a b and b c balance each other, the former tending to rotate in a clock-wise direction. Quadrants c d and d a form

a similar balance,  $c$  and  $d$  giving a clock-wise movement and  $d$  a counter clock-wise movement. The result of all these forces is to allow the armature to remain at rest. Now suppose the armature to be rotated clock-wise. Since there is self-inductance in the rotor winding, a certain time will elapse from the movement the E.M.F. in the rotor is a maximum, to the time the current has reached a maximum. At the moment the field passes through zero the induced E.M.F. is maximum, so by the time the E.M.F. reaches a maximum the field is approximately maximum also. If the rotor be given a starting velocity, by the time the current has increased in value the rotor has turned through the angle shown in Fig. 3, Plate 7, so that the poles on the armature are now in a position to be repelled by one field and attracted by the other. Thus the motor will run on single phase current if once brought up to speed.

The direction of rotation may be in either direction according as it is once started.

#### CURRENT - VOLTAGE RELATIONS.

Since the currents in the rotor of an induction, <sup>MOTOR</sup> are produced by induction from the primary impressed current, the induction motor in its electro-magnetic features is practically a transformer. An alternating current transformer consists of one magnetic circuit, interlinked with two electric circuits, of which one, the primary, receives electrical energy and the other, the secondary, delivers electrical energy. In the induction motor we have the magnetic circuit consisting of the stator and the rotor cores separated by a small air gap, and the interlinked electrical circuits consisting of the stator (primary) and rotor secondary windings. The difference between the transformer and the induction motor is, that in the former the second-

ary is fixed relative to the primary, and the electrical energy induced in the secondary is made use of outside of the transformer; while in the induction motor the secondary is movable regarding the primary, and the mechanical force acting between primary and secondary is used.

If we designate the speed of rotation of the field by  $n$  r.p.m., when the motor is at a standstill the speed of the stator relative to the rotor is  $n$ . In this case the E.M.F. induced in a given rotor conductor is equal to the E.M.F. induced in a stator conductor and of the same frequency  $f$ . Now if the rotor be revolving at a speed  $n'$  the relative speed of rotor and stator field drops to  $n - n'$ , and their respective induced E.M.F.'s are in the ratio  $\frac{n - n'}{n}$  both in value and frequency. The ratio of the rotor speed  $n - n'$  to  $n$  is termed the slip.  $s$ . Hence  $S = \frac{n - n'}{n}$

Thus the induced E.M.F. is  $s$  times the impressed E.M.F. on the stator. If the motor is running light it will revolve but slightly slower than the revolving field, so that only enough E.M.F. is generated to send through the rotor inductors, current enough that its electrical energy is equal to all the losses in the motor. Now if a mechanical load be applied to the pulley of the rotor, the slip will increase and the speed drop. This will cause an increase of E.M.F. in the rotor and thus an increase of current which will supply additional electrical power equivalent to the increase of load. If the strength of the rotating field, which cuts the rotor inductors, were maintained constant, the slip, the rotor E.M.F., and the rotor current would vary directly as the mechanical torque exerted. By increasing the rotor resistance, the same torque would require an increase in slip to pro-

duce an E.M.F. sufficient to send the same current, but the proportionality would still be maintained. However, the field flux cut by the rotor inductors does not remain constant under varying loads. With increase of slip, and thus of rotor current, we have an increase of leakage flux between the rotor and stator. This decrease of flux linked by the rotor inductors not only lessens the torque for the same rotor current but also necessitates a greater slip to produce the same current.

If a number of curves are plotted for an induction motor with resistance in the armature, using per cent slip as abscissa and increasing torque as ordinates it is shown that the maximum torque the motor will give, is the same for different resistances. However, the greater the resistance the slower the motor will run when producing this maximum torque. This principle is utilized to keep down excessive current at starting, and largely increase the starting torque per ampere. The necessity of keeping down current at starting is very important, for these motors on starting with heavy load require very large current while coming to speed. This large current may pull down the line voltage and seriously affect line regulation by virtue of ohmic drop.

Commercial motors vary in slip from one to ten per cent according to design. Small slip does not necessarily mean high efficiency, since the designer may arrange for the losses in the armature or in field as he desires.

The most common voltages for induction motors are from 104 to 550 volts, though some are considerably higher. It is important that the voltage for an induction motor be kept up to its normal value since the output varies as the square of voltage, and if the voltage drops little margin is left for over load.

### RATIO of TRANSFORMATION.

The characteristics of the transformer are independent of the ratio of transformation, other conditions being the same. Doubling the number of turns and at the same time reducing their cross section to one-half leaves the regulation and efficiency of the transformer unchanged. In the same way in the induction motor it is unessential what the ratio of primary to secondary turns is, or the secondary circuit can be wound for for any suitable number of turns provided the same total cross section is used. In consequence the secondary is usually wound so as to have minimum resistance when running.

The induction motor like the transformer has leakage flux which is generated by the current on the conductors, but does not cut the conductors of the other element of the motor. This flux is called leakage flux and has the same effect as placing an inductance in series with the primary outside the stator.

### STARTING DEVICES.

As has previously been stated, if an induction motor with an ordinary squirrel cage armature be started with a load the current is enormous. There are two usual methods ~~to~~ used to prevent this large starting current. One is to insert resistance in the armature circuit, the other is to employ a transformer to reduce the impressed voltage.

The insertion of resistance in the armature circuit for starting has already been referred to under "current-voltage relations". The plan of inserting the resistance within the rotor spider is shown in Fig. 1, Plate 3. The General Electric form is of this type, the resistance being cut out after the motor has attained full speed by pushing a knob on the end of the shaft. Various methods are used for inserting and cutting out this resistance on starting but they all aim

at the same end. Placing the starting resistance external to the motor and inserting it in series with the armature circuit through brushes and slip rings is very good practice. Fig. 2, Plate 3, shows the connections. The resistance can be varied as the motor att<sup>t</sup>ains speed. Some machines are arranged so that the slip rings can be short circuited internally when full speed is attained. and thus avoid the  $I^2R$  loss which would occur in the brush contact during running if the short circuiting switch were placed outside the rings.

The compensator or auto-transformer can be used to largely relieve the line of the heavy starting current. Fig. 1, Plate 8, gives a diagram of the connections for employing a compensator for starting a squirrel cage motor. By this arrangement, provided the motor can start with little load, it is fed from taps on the compensator at such points as will give only enough voltage to start rotation. In practice these compensators are arranged with a number of sets of taps, and that particular set is used which corresponds to the lowest voltage, which, after installing the motor is found to start under the required conditions. If a motor is of a large capacity it may have its own step-down transformer. In this case instead of having a compensator taps may be taken out at suitable points on the secondary winding. Such a scheme is shown in Fig. 2, Plate 8, where connected three-phase transformer is used. The three pole double throw switch provides a starting and a running voltage.

The single phase induction motors have special starting devices to give the rotor an initial starting velocity. The necessity of this has been explained in "Theory of Operation." Different methods are used for acquiring this starting speed, of which a common method is termed "splitting the phase". This is done by having addi-

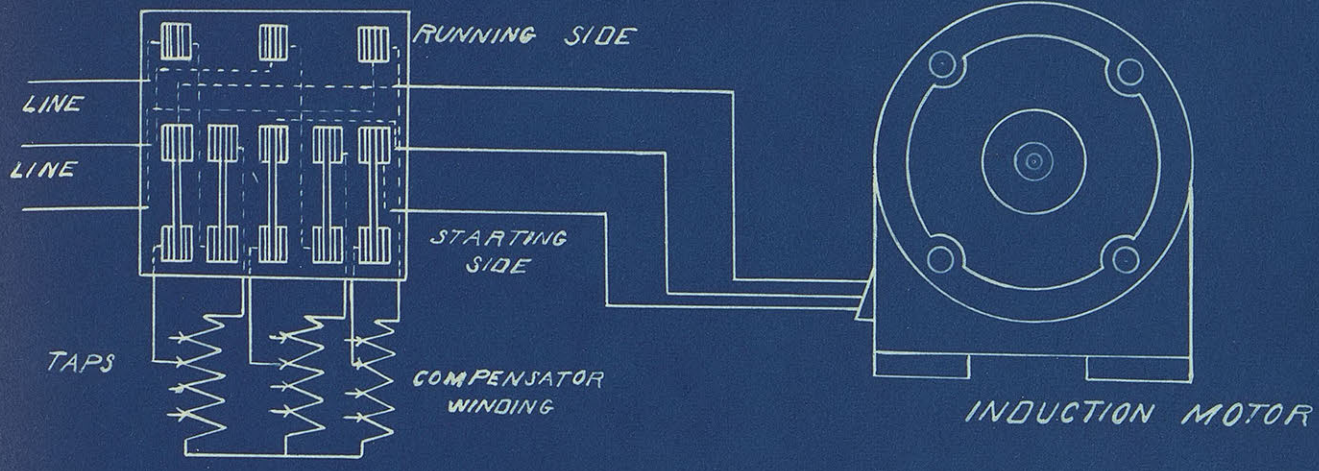

FIG. 1.

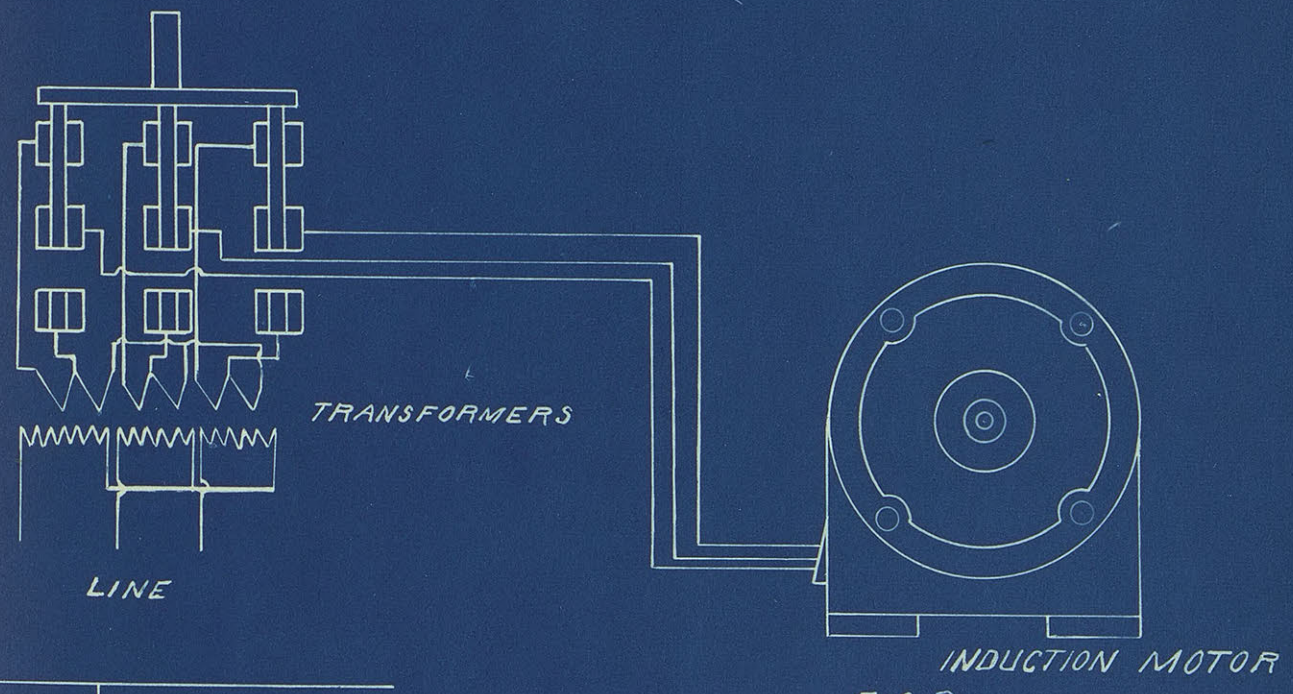

FIG. 2.

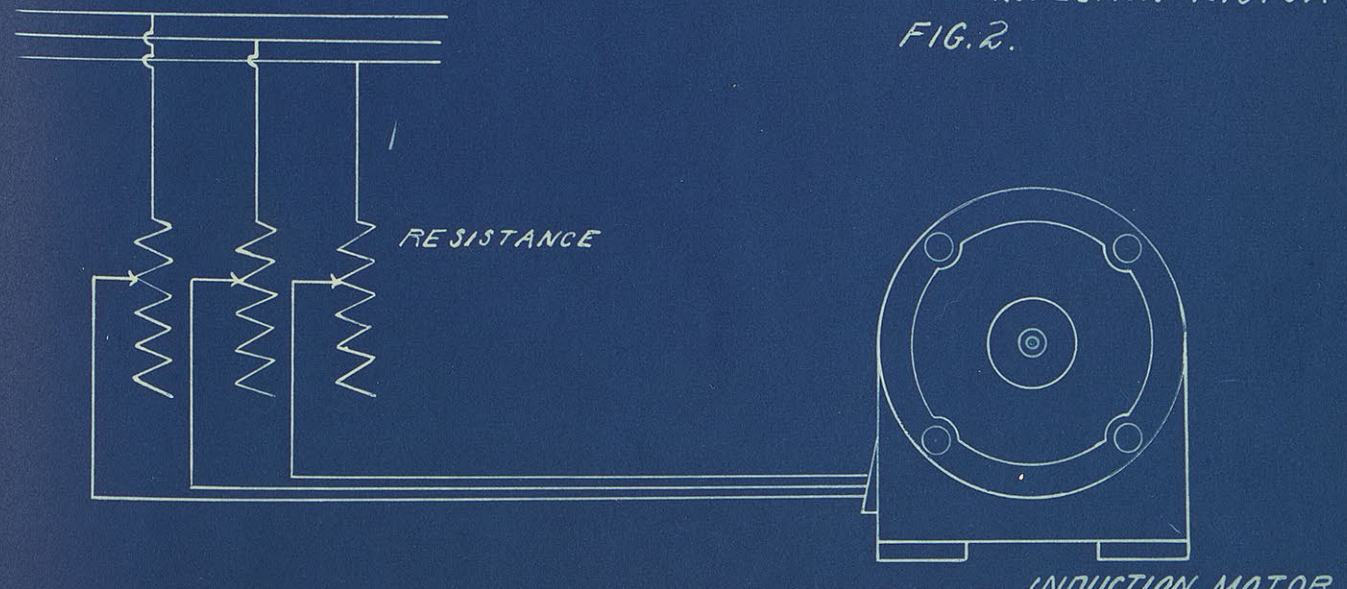

FIG. 3. INDUCTION MOTOR

tional coils on the stator field fed by currents which are out of phase with the current in the main coils. These coils are in shunt with the main coils and have in series with them a high inductive resistance. This makes the shunt current lag nearly 90° behind the phase of the other and thus we have virtually a two phase motor which will come up to speed. After speed is attained the shunt is opened and the motor runs on the single phase circuit. A condenser might be used instead of the inductance in the shunt circuit, thus producing a leading instead of a lagging current.

Another method of starting is that used in the Wagner single phase motor under test. This motor is provided with a commutator to which the rotor windings are connected. The brushes bearing on the commutator are joined together by a conductor of low resistance. The stator is supplied with the single phase current while the rotor is brought up to speed by the induced currents in the rotor windings acting with the stator flux. While running up to speed the armature connections are such as to place the commutator in service. The brushes bearing on the commutator cause the induced armature currents to flow in such a way that their action with the field is similar to that of a direct current series machine. When speed is attained the automatic centrifugal governor acts, short-circuiting all the commutator bars and at the same time lifting off the brushes so the motor runs as a single phase induction motor.

In starting this motor it took five seconds for the brushes to be thrown off, which took place <sup>at</sup> about 1400 R.P.M. When the switch was first closed the armature in circuit read 25 amperes, when the brushes went off 44 amperes and at full load 26 amperes. The voltage when the switch was first closed fell from 104 to 96 volts, and when the brushes went off it dropped to 76 volts.



- SPEED REGULATION. -

The speed of induction motors may be varied by varying the resistance in the armature as already stated for starting, or the resistance may be in the primary. The latter method is called "varying speed by potential control" and offers the advantage of avoiding the use of slip rings. A scheme of connections is given in Fig. 3, Plate 8. Another method of varying the speed is to so arrange the windings as to be able to change the number of poles on the stator. This has the disadvantage of giving only a limited number of definite speeds.

- CURVE DISCUSSION. -

The results of the tests of the motor are shown by the curves on the curve plates 1 and 2. The data for the curves A, C, D, E, F, and G of Plate 1 was all taken on a commercial efficiency test run of the motor. The upper figures of Plate 9 shows clearly connections for the experiment as run in the laboratory.

The voltage was kept constant( or as nearly constant as possible) at 104, normal voltage, while the instruments indicated in the scheme were simultaneously read for successive increase of brake load. The slight irregularity of the points on the curves may be attributed to the following causes: personal error in reading instruments, the difficulty in keeping the speed of the alternator constant and also the motor terminal voltage constant.

The slip was taken by the following method: a disc about 10 inches in diameter was placed on the shaft so as to rotate with it. This disc had four black and four white sectors radiating outward from the center, each black sector corresponding to each of the four poles of the motor field. An arc lamp was connected in parallel over the same E.M.F. source as the motor. As the armature rotated this arc lamp was held so as to throw its light on the black and white surface

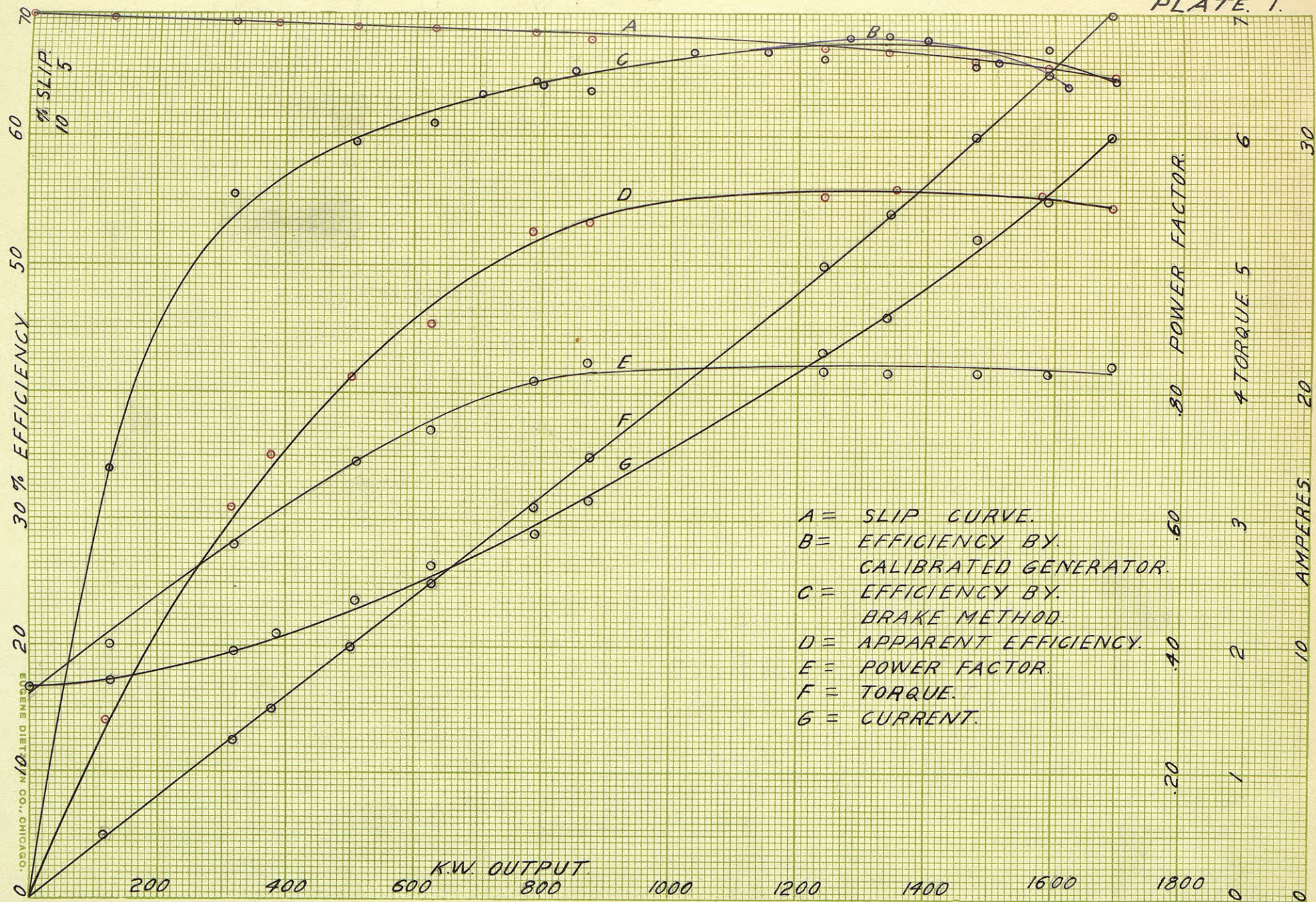

EUGENE DIETZMAN

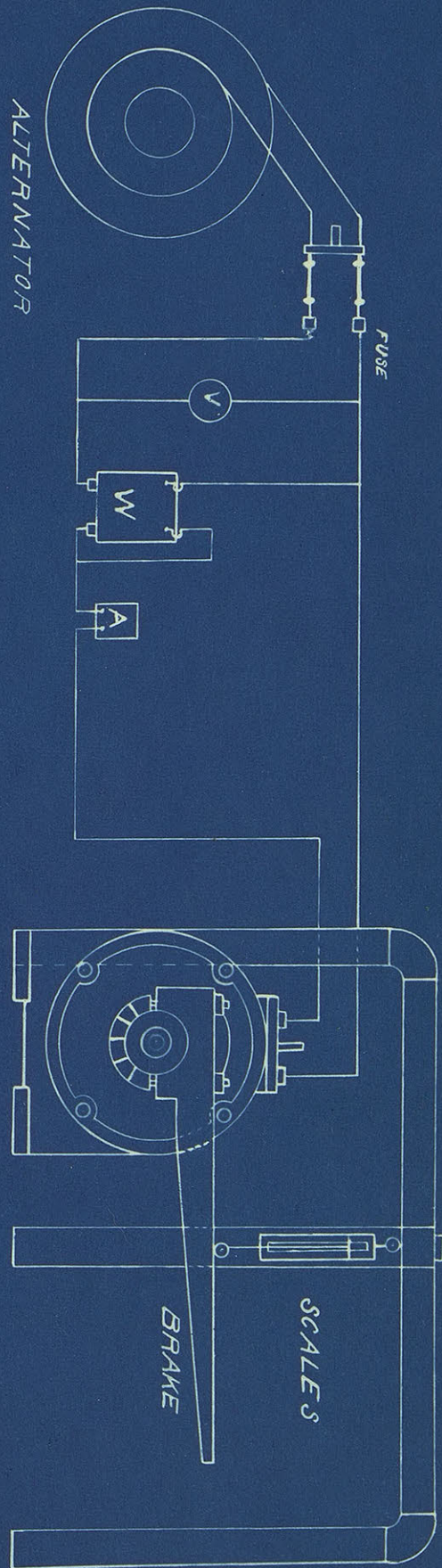

INDUCTION MOTOR

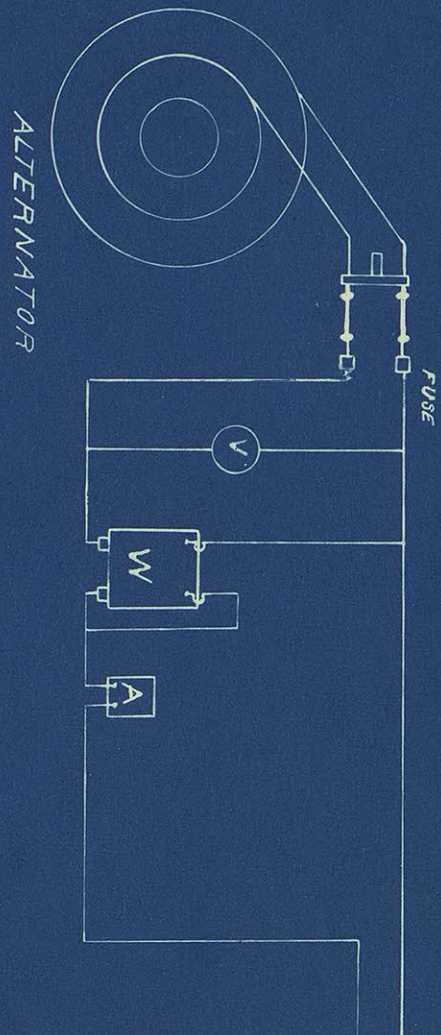

ALTERNATOR

INDUCTION MOTOR

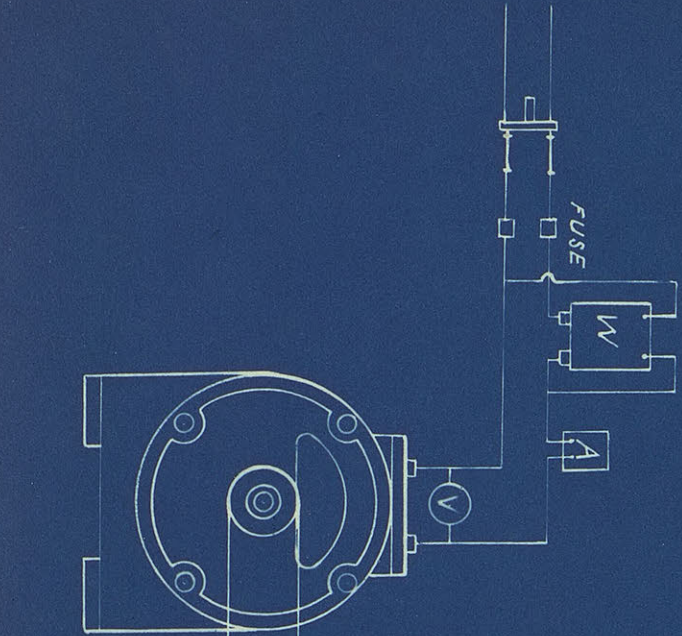

DYNAMO

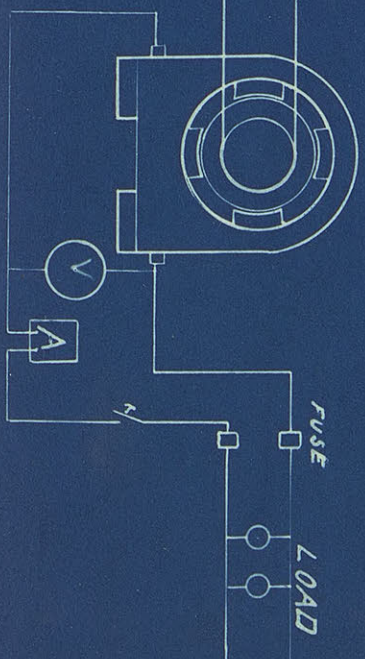

of the disc. This caused the disc to appear to rotate in the opposite direction from that of the rotor. If the number of black sectors which appear to pass backward per minute are counted and this number be divided by 4 we get the number of revolutions the armature lags behind the stator. The ratio of this lag to the stator field velocity is termed the slip. Examining the slip curve A we find it practically straight until about 1100 K.W. output is reached when it begins to fall more rapidly. The reason for this is that the slip has become large enough that it causes considerable leakage flux between the stator and rotor due to the reaction of armature current. The torque is proportional to the square of the useful flux, so that together the increased torque for the larger loads the rotor speed must fall enough that the decreased flux can give a rotor current which acting with the weakened field can give the required torque. Thus as the load comes on, the rotor requires slip in order to give the current required. The larger current weakens the field and hence a limit of current value is reached which, if made larger cuts down torque by excessive reduction of field flux. If the load is increased enough a point is reached where the increasing current due to slip, so weakens the field that the torque can not be increased and the motor breaks down.

The torque curve F on Plate 1 is a straight line up to about 1100 K.W. and from there it curves up showing that torque increases faster than output. The reason for this is;— that speed is a factor in the output, and since slip increases more rapidly from about 1100 K.W. the torque must increase to give the output.

The current curve G, Plate 1, shows a continual faster increase than the output. The output is proportional to the product of rotor amperes and flux cutting the rotor windings. But as the load

increases the armature reaction increases and cuts down the field flux so the current must rise to give the output. If the field remained constant the current would be practically proportional to output.

The power factor curve E shows a proportional increase with output for about half a load then it turns, drops slightly and runs nearly parallel to the abscissa. At small load when the rotor is nearly in synchronism with the stator field there is very little flux cut by the rotor conductors, and hence nearly all the stator flux is used in setting up, self induction. A large angle of lag and a small power factor is the result. As the load comes on the rotor current increases and reacts on the field flux thus leaving less of it to set up the self induction in the field, and the angle of lag is decreased and the power factor raised. This process continues until we have the field flux reacted upon by the large rotor currents to such an extent that a great leakage flux occurs between stator and rotor, increases the angle of lag, and hence decreases power factor.

The data for the efficiency curve C, Plate 1, was obtained by Wattmeter readings for input and brake load for output. It is seen to rise to a maximum efficiency of 67.5% at about 1300 K.W. (.81 full load) and from there it drops. This fall of the curve beyond the maximum point is due to the rotor currents reacting on the flux from the stator, thus decreasing speed to get rotor current and torque, and as the speed goes down the output decreases and with it the efficiency.

The curve B, Plate 1, is another efficiency curve. This was taken by belting the motor to a calibrated generator and loading the generator with lamps. The scheme is shown in the lower figure of Plate 9. The points for this curve as well as ~~for~~ the curve itself are drawn

in purple ink. to distinguish them from curve C. For the larger part of the way the two curves coincide, though about the maximum point this curve rises 1/2% higher and then falls off more suddenly and brakes down at a less load. There is no apparent cause why this curve should rise above the other as it does, ~~after~~ coinciding with with it most of its length. However, if notice is taken of the points for curve C it is seen that they are somewhat staggered from about maximum to the end of the curve. One of the points is a little higher than any on B. ~~These~~ These points were difficult to obtain accurately due to the difficulty of getting both cycles and voltage right at the same time. So the above mentioned reasons are probably the cause of the two curves not coinciding throughout.

The ordinates of curve D, Plate 1 were obtained by dividing output by the product of volts by amperes. It has the same general shape as the real efficiency curve but must fall between it.

The curve A, Plate 2, was taken by clamping the brake tight to the pulley and then taking successive readings of stat~~or~~ torque for different voltages. For each reading the voltage was set at its respective value., then the switch closed and the maximum pull on the scales read. Theoretically the torque varies as the square of the impressed voltage, and the shape of this curve goes toward confirming this theory.

Curve B, Plate 2, was taken by varying the voltage as in A, but here instead of reading static torque the motor was allowed to run up to speed then the brake was tightened until the break down point, the greatest pull on the scales being read. This curve is plotted to double the abscissa of A but shows about the same general shape.

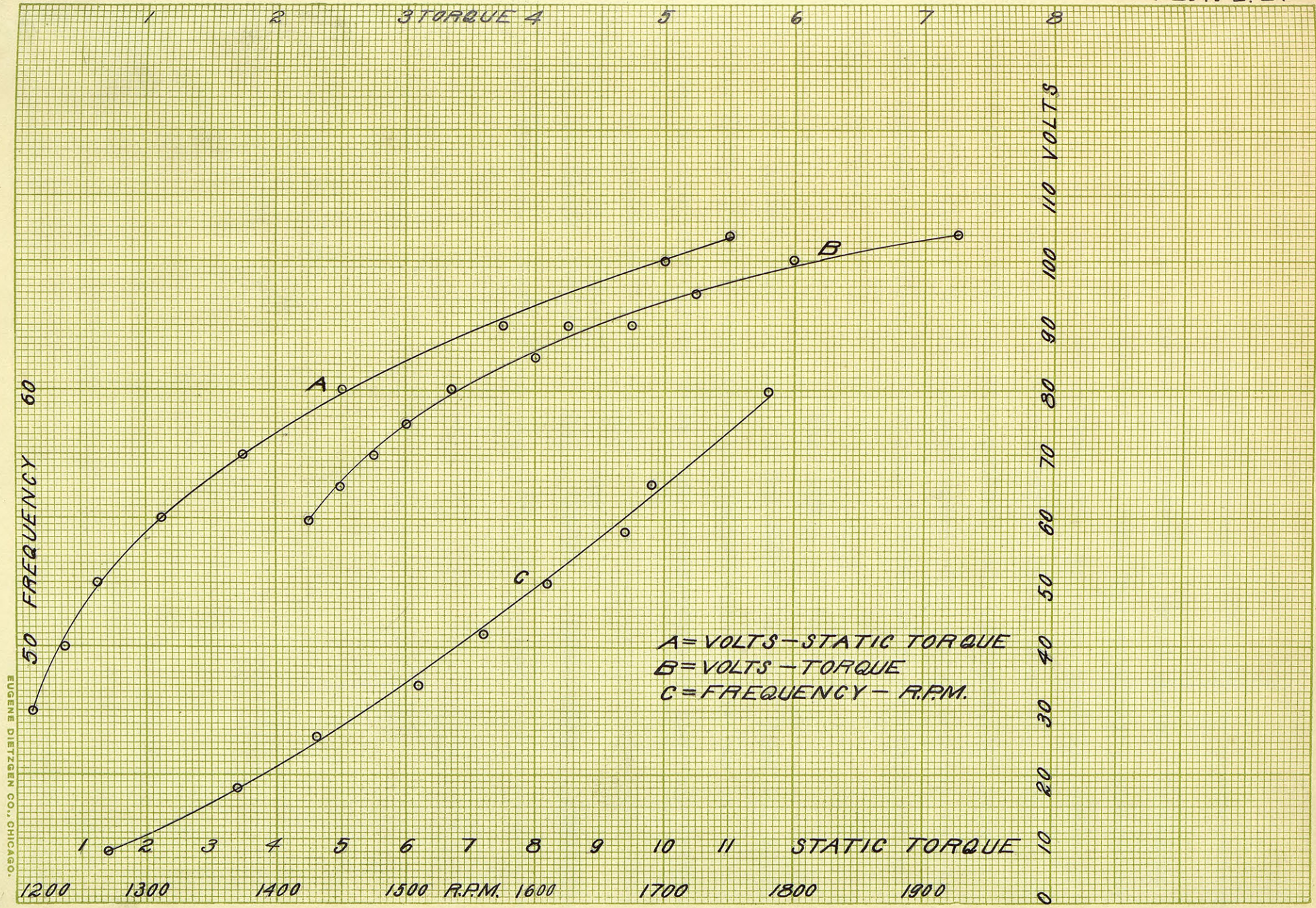

EUGENE DIETZGEN CO., CHICAGO.

Curve C, Plate 2, is a frequency speed curve. In taking this the motor was run with no load, the frequency being changed by changing the speed of the alternator. If there were no losses of any kind this curve would be a straight line. However, owing to increase of loss, in hysteresis, windage eddy currents, and perhaps bearing friction with increase of speed, the speed does not keep up with the increase of cycles, or the cycles increase faster than proportional to speed.

HEAT RUN.

A heat run was made on the machine at full load for about three hours. During this time the temperature of the various parts raised to the value given below, the temperature of the room being 27° C.

Boxing on side next to pulley.	Boxing on Commutator end.	Surface of frame.	Commutator.	Armature.
47.5	48.5	45	57.5	70



- D A T A . -  
 FOR COMMERCIAL EFFICIENCY BY CALIBRATED GENERATOR METHOD.

Watts input to Motor.	Watts Input to Generator.	Output of Generator.	Efficiency of Generator.	Efficiency of Motor.
1112.5	704.6	198	28.1 %	63.3%
1250	800	308	38.5 "	64%
1300	850.5	412.5	48.6 "	65.37%
1552	1035.9	533.5	51.5 "	66.6%
1725	1150	649	56.4 "	66.8%
1875	1280	781	61 "	68%
2062.5	1400	902	64.4 "	67.8%
2287.5	1510	1028.5	67.9 "	66%
2525	1620	1149	70.8 "	64%

## D A T A -

## FOR COMMERCIAL EFFICIENCY BY BRAKE METHOD.

Amperes.	Watts Input.	Pounds.	% Slip.	Watts Output.	Actual% Efficient.	Power- Factor.	Apparent Efficiency.
8.3	287.5	—	—	—	—	.331	—
8.6	370	.5	.333	127.3	34.4	.4125	.142
9.8	575	1.25	.665	317.	55.	.564	.31
10.5	712.5	1.5	.834	382.	52.7	.654	.352
11.8	850	2.	1.11	506.	59.5	.693	.412
13.3	1037.5	2.5	1.415	631	61	.747	.455
14.4	1225.	3.12	1.665	784.	63.8	.82	.527
15.8	1380	3.5	2.275	875	63.5	.84	.532
21.5	1870	5.	3.05	1240	66.3	.835	.552
23.	1975	5.4	3.22	1340	68.	.83	.562
26.	2250.	6.	4.	1475	65.5	.83	.543
27.5	2375	6.5	4.45	1590	67.	.83	.555
30.	2625	7.	5.28	1695	64.5	.84	.543

VOLTS CONSTANT at 104.

CYCLES CONSTANT at 60.

## D A T A .

FOR CYCLE.- SPEED CURVE.

<u>Speed.</u>	<u>Cycles.</u>
1780 - - - -	60.
1690 - - - -	56.4
1670 - - - -	54.5
1610 - - - -	52.5
1560 - - - -	50.5
1510 - - - -	48.5
1430 - - - -	46.5
1370 - - - -	44.5
1270 - - - -	42.

## D A T A .

FOR VOLT - STATIC TORQUE CURVE.

<u>Volts.</u>	<u>Pounds.</u>
104. - - - -	11
100 - - - -	10
90 - - - -	7.5
80 - - - -	5.
70 - - - -	3.5
60 - - - -	2.25
50 - - - -	1.25
40 - - - -	.75
30 - - - -	.25

## D A T A .

For Volt - Torque Curve.

<u>Volts</u>	<u>Pounds.</u>
104 - - -	7.25
100 - - -	6.
95 - - -	5.25
90 - - -	4.75
85 - - -	4.
80 - - -	3.35
75 - - -	3.
70 - - -	2.75
65 - - -	2.55
60 - - -	2.25
50 - - -	1.25