

NONLINEAR ANALYSIS OF THREE-WAY CONTROL VALVE AND  
CYLINDER OPERATING WITH COMPRESSIBLE FLUID

by

ROBERT I-JEN JUNG 265

Diploma, Air Technological College, Taiwan, China, 1950

---

A MASTER'S REPORT

submitted in partial fulfillment of the

requirements for the degree

MASTER OF SCIENCE

Department of Mechanical Engineering

KANSAS STATE UNIVERSITY  
Manhattan, Kansas

1968

Approved by:

*Ralph O. Surgenor*  
Major Professor

## ACKNOWLEDGEMENTS

The author wishes to express his heartfelt gratitude to his major adviser, Dr. Ralph Otto Turnquist, who provided the original idea for this report and constant encouragement during its preparation. He also wishes to express his appreciation to Dr. Preston Essex McNall, Head of the Department of Mechanical Engineering, Dr. Kenneth King Gowdy, Assistant professor of Mechanical Engineering and Dr. S. Thomas Parker, Professor of Mathematics, for being members of the author's advisory committee.

## TABLE OF CONTENTS

	Page
NOMENCLATURE. . . . .	v
CHAPTER I INTRODUCTION. . . . .	1
CHAPTER II DESCRIPTION AND ANALYSIS OF A PNEUMATIC CONTROL SYSTEM FOR AN AIR BLAST CIRCUIT BREAKER . . . . .	3
CHAPTER III DISCUSSIONS OF RESULTS. . . . .	13
CHAPTER IV CONCLUSIONS . . . . .	32
SELECTED REFERENCES . . . . .	34
APPENDIX A. FLOW CHART OF COMPUTER PROGRAM . . . . .	36
APPENDIX B. FORTRAN PROGRAM. . . . .	37

## LIST OF FIGURES

Figure	Page
1. Schematic Representation of an Actuating System for an Air Blast Circuit Breaker . . . . .	4
2. Characteristic Actuator Response Curves, $V_t = 1000 \text{ in}^3$ . . . . .	14
3. Characteristic Actuator Response Curves, $V_t = 500 \text{ in}^3$ . . . . .	17
4. Characteristic Actuator Response Curves, $V_t = 200 \text{ in}^3$ . . . . .	18
5. Actuator Displacement Characteristics, $A_0 = 0.0194 \text{ in}^2$ . . . . .	20
6. Actuator Displacement Characteristics, $A_0 = 0.194 \text{ in}^2$ . . . . .	21
7. Actuator Displacement Characteristics, $V_t = 1000 \text{ in}^3$ . . . . .	23
8. Actuator Displacement Characteristics, $V_t = 500 \text{ in}^3$ . . . . .	25
9. Actuator Displacement Characteristics, $V_t = 200 \text{ in}^3$ . . . . .	26
10. Overshoot Behavior, $V_t = 200 \text{ in}^3$ . . . . .	28
11. Rise Time of Solenoid Control Valve. . . . .	29

## NOMENCLATURE

A	Area of actuating piston, in <sup>2</sup> .
A <sub>O</sub>	Area of control valve opening, in <sup>2</sup> .
$\bar{A}_O$	Normalized area of control valve opening.
B <sub>P</sub>	Viscous damping coefficient, lbf-sec/in.
b	Thickness of the piston, in.
C <sub>O</sub>	Clearance between the piston and cylinder at dead end position, in.
C <sub>R</sub>	Required piston displacement for contacts fully open, in.
C(t)	Distance traveled by piston at time t, in.
C(t) <sub>ss</sub>	Steady-state displacement, in.
$\dot{C}(t)$	Velocity of piston at time t, in/sec.
$\ddot{C}(t)$	Acceleration of the piston at time t, in/sec <sup>2</sup> .
f(t)	Pressure force acting on piston, lbf.
K	Ratio of constant pressure specific heat to constant volume specific heat.
K <sub>S</sub>	Spring constant, lbf/in.
L <sub>C</sub>	Length of the cylinder, in.
M <sub>L</sub>	Mass of load, lbm.
M <sub>L</sub> <sup>i</sup>	Mass of load, lbf-sec <sup>2</sup> /in.
M <sub>P</sub>	Mass of piston, lbm.
M <sub>P</sub> <sup>i</sup>	Mass of piston, lbf-sec <sup>2</sup> /in.
n	Number of time increment.
Patm	Pressure of atmosphere, psia.

$P_c(t)$	Pressure in cylinder at time $t$ , psia.
$\dot{P}_c(t)$	Rate of pressure change in cylinder at time $t$ , lbf/(in <sup>2</sup> -sec).
$P_t(t)$	Pressure in supply tank at time $t$ , psia.
$\dot{P}_t(t)$	Rate of pressure change in supply tank at time $t$ , lbf/in <sup>2</sup> -sec.
$R$	Gas constant, ft-lbf/lbm-°R.
°R	Absolute temperature, degree.
$s$	Laplace transform operator.
$t$	Time, sec.
$t_r$	Actuator response time (time for piston to travel 3 inches).
$\Delta t$	Time increment, sec.
$V_t$	Volume of supply tank, in <sup>3</sup> .
$W(t)$	Mass flow rate at time $t$ , lbm/sec.
$W'(t)$	Mass flow rate at time $t$ , lbf-sec/in.
$\rho_c(t), \rho_c'(t)$	Densities of working fluid at time $t$ , lbm/in <sup>3</sup> .
$\rho_c^i(t), \rho_t^i(t)$	Densities of working fluid at time $t$ , lbf-sec <sup>2</sup> /in <sup>4</sup> .
$\omega_n$	Natural frequency.

## CHAPTER I

### INTRODUCTION

In recent years, the transmission voltage used in electrical power systems has climbed to 700 KV and some considerations have been given to using 1,000 KV. In such EHV (extra high voltage) systems, high performance air blast circuit breakers are being used as a vital element for protection of the power transmission system.

This type of circuit breaker has economic and other advantages over the bulk oil type circuit breakers which have been utilized for many years world wide.

In an air blast circuit breaker, compressed air stored in a fixed volume supply tank is the main operating vital. The compressed air serves three purposes:

1. It provides the energy for opening or closing the circuit breaker contacts on command from a control mechanism.
2. It blasts away the products of the arc and cools the arc column during breaker opening (interruption).
3. It provides a dielectric medium across the circuit breaker contacts, when they are open, and also between live parts and ground.

For a circuit breaker, fast and positive interrupting operation is considered to be of utmost importance. Usually, it demands that interruption must occur within several

hundredths of a second in case of a short circuit in the transmission system due to faults such as falling trees, lightning, etc. Comprehensive discussion and study in recent years has shown a desire for breakers with 2 cycles (e.g.  $\frac{2}{60}$  seconds) interrupting time rather than the present American standard of 3 cycles (1)\*. Benefits of the shorter interrupting time includes reduced arcing damage to lines and cables from faults and higher line loading capability through improved stability because of shorter fault duration time.

In designing a pneumatic control system for an air blast circuit breaker, a primary consideration for its mechanical operation and interrupting time is the operating pressure to be used. Contact velocities and valve operation are mainly a function of the pressure of the air. Beyond the consideration of pressure, the only requirement is that the air be relatively clean and free from liquid water and solid foreign objects. This requirement is imperative for practical, efficient and dependable operation of an air blast circuit breaker.

---

\*Numbers in the parenthese refer to items of references.



## CHAPTER II

DESCRIPTION AND ANALYSIS OF A PNEUMATIC CONTROL  
SYSTEM FOR AN AIR BLAST CIRCUIT BREAKER

In this report, interests are focused upon the response of a piston type actuator driving a spring loaded set of circuit breaker contacts.

The complete system is shown schematically in Fig. 1 and consists of a fixed volume supply tank, a piston type actuator, and an on-off solenoid type control valve.

It is assumed that the actuating system controls the opening and closing of a set of circuit breaker contacts directly, so that considerations of linkage delays and backlash can be eliminated. In an actual circuit breaker, the number of sets of contact is determined by the current capacity requirement of the power transmission system. For instance, in an Allis-Chalmers Type ABM air blast circuit breaker (2), there may be as many as six sets of similar contacts in each phase of the breaker.

As described in Chapter I of this report, in an actual circuit breaker, the compressed air stored in a supply tank serves three functions during breaker operation. Therefore, the air pressure in the supply tank undergoes a considerable drop during an actuating cycle. For example, when a type ABM-500-38,000 circuit breaker executes an opening (interruption) cycle, a supply tank pressure drop of approximately

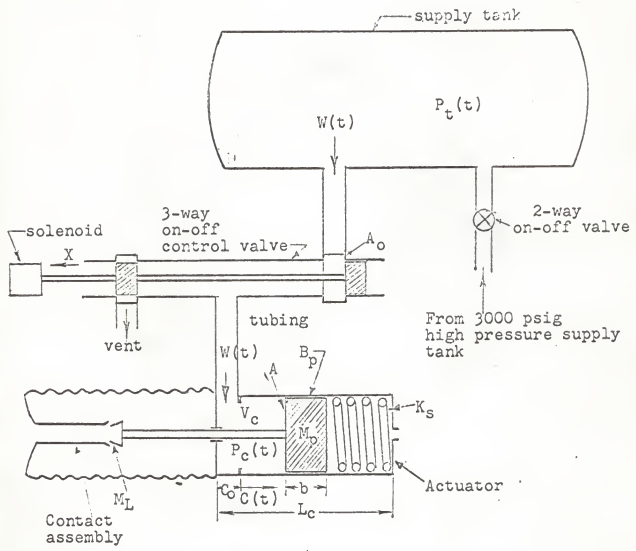

Fig. 1. Schematic Representation of an Actuating System for an Air Blast Circuit Breaker.

36 psi occurs. In this report, the effect of changing supply tank pressure on actuator response time will be investigated.

In order to introduce different drop in supply tank pressure during opening of the breaker contacts, different tank volumes are assumed.

The following parameter values for system components were selected for study in this report. These values were selected as being typical. However, the analysis techniques developed in this report can be applied in general for any desired combination of values of system parameters.

The parameter values selected were:

1.  $V_t = 1,000 \text{ in}^3, 500 \text{ in}^3, 200 \text{ in}^3 \text{ and } 70 \text{ in}^3.$
2.  $A_o = 0.194 \text{ in}^2, 0.097 \text{ in}^2, 0.0485 \text{ in}^2, 0.0277 \text{ in}^2$   
and  $0.0194 \text{ in}^2.$
3.  $K_d = 0.95.$
4.  $A = 3.14 \text{ in}^2.$
5.  $L_c = 8 \text{ in}.$
6.  $C_o = 0.5 \text{ in}.$
7.  $b = 0.75 \text{ in}.$
8.  $M_p = 1.126 \text{ lbm}.$
9.  $M_L = 10 \text{ lbm}.$
10.  $B_p = 1.5 \text{ lbf-sec/in}.$
11.  $K_s = 291 \text{ lbf/in}.$
12.  $C_r = 3 \text{ in.}, 3.5 \text{ in.}, 4 \text{ in}.$

Following assumptions were used in the analysis of the system:

1. The working fluid, air, is a perfect gas (4).  
 $K = 1.4$   
 $R = 53,34 \text{ ft-lbf/lbm-}^\circ\text{R}$
2. The working fluid has constant specific heats.
3. The kinetic energy of the working fluid is negligible.
4. Flow velocity is high enough to consider flow processes as adiabatic.
5. Coulomb type friction is negligible.
6. The supply tank actuating cylinder, control valve and interconnecting lines are rigid.
7. The discharge coefficient of the control valve is constant.
8. Pressure wave effects in the working fluid are negligible.
9. At time  $t = 0$ , the solenoid valve is closed; at time  $t = 0+$ , the solenoid valve is wide open.

Initial conditions assumed were:

1.  $t = 0+$
2.  $P_t(0) = *370 \text{ psig.} = 384.7 \text{ psia.}$
3.  $P_c(0) = P_{atm} = 14.7 \text{ psia.}$

---

\*This is the supply tank pressure used in Allis-Chalmers type ABM air blast circuit breakers (2).

4.  $\theta_t(0) = 530 \text{ }^\circ\text{R.}$
5.  $\theta_c(0) = 530 \text{ }^\circ\text{R.}$
6.  $\rho_t(0) = 0.001136 \text{ lbm/in}^3.$
7.  $\rho_c(0) = 0.0000434 \text{ lbm/in}^3.$
8.  $\dot{P}_t(0) = 0 \text{ lbf/in}^2\text{-sec.}$
9.  $\dot{P}_c(0) = 0 \text{ lbf/in}^2\text{-sec.}$
10.  $C(0) = 0 \text{ in.}$
11.  $\dot{C}(0) = 0 \text{ in/sec.}$
12.  $\ddot{C}(0) = \text{in/sec}^2.$

#### A. Flow Through the Solenoid Control Valve

Consider opening of the breaker contacts. At time  $t = 0+$ , the solenoid valve is wide open, and the pressure ratio is:

$$\frac{P_c(0)}{P_t(0)} = \frac{14.7}{384.7} = 0.0382$$

This ratio, 0.0382, is less than 0.528, the criterion for distinguishing between critical and subcritical flow (3) (4) (5). Therefore, the flow through the control valve at the beginning of an opening cycle is critical.

The equation for critical flow through the solenoid valve is:

$$W'(t) = K_d A_o \sqrt{K \left(\frac{2}{K+1}\right)^{\frac{K+1}{K-1}} \rho'_t(t) P_t(t)} \quad (2.1)$$

In equation (2.1),  $W'(t)$  has the dimensions  $\text{lb} \cdot \text{sec} / \text{in}$ .  $\rho'_t(t)$  has the dimensions  $\text{lb} \cdot \text{sec}^2 / \text{in}^4$ . Converting the dimension of  $W(t)$  to  $\text{lbm} / \text{sec}$ , the dimensions of  $\rho'_t(t)$  to  $\text{lbm} / \text{in}^3$ , and substituting  $K = 1.4$ , equation (2.1) becomes:

$$W(t) = K_d A_o \sqrt{180.5 \rho'_t(t) P_t(t)} \quad (2.2)$$

Equation (2.2) is applicable until the following condition prevails:

$$\frac{P_c(t)}{P_t(t)} > 0.528$$

Then the flow through the solenoid control valve becomes subcritical. The subcritical flow equation is:

$$W'(t) = K_d A_o \sqrt{\left(\frac{2K}{K-1}\right) \rho'_t(t) P_t(t) \left\{ 1 - \frac{P_c(t)}{P_t(t)} \frac{K-1}{K} \right\} \left[ \frac{P_c(t)}{P_t(t)} \right]^{2/K}} \quad (2.3)$$

Converting the dimensions of  $W'(t)$  and  $\rho'_t(t)$  into  $\text{lbm} / \text{sec}$  and  $\text{lbm} / \text{in}^3$  respectively, and substituting  $K = 1.4$ , equation (2.3) becomes:

$$W(t) = 51.9 K_d A_o \sqrt{\rho'_t(t) P_t(t) \left\{ 1 - \left[ \frac{P_c(t)}{P_t(t)} \right]^{0.286} \right\} \left[ \frac{P_c(t)}{P_t(t)} \right]^{1.428}} \quad (2.4)$$

### B. Rate of Mass Flow from the Supply Tank

If the supply tank is considered as a control volume, the equation which defines the rate of mass flow from the tank is:

$$W(t) = - \frac{V_t \dot{P}_t(t) \rho_t(t)}{K P_t(t)} \quad (2.5)$$

Substituting and rearranging yields:

$$\dot{P}_t(t) = \frac{-1.4 P_t(t) W(t)}{V_t \rho_t(t)} \quad (2.6)$$

### C. Rate of Mass Flow into the Actuating Cylinder

Considering the actuating cylinder as a control volume, the rate of mass flow into the cylinder is:

$$W(t) = [AC_o + AC(t)] \frac{\dot{P}_c(t) \rho_c(t)}{K P_c(t)} + \rho_c(t) A \dot{C}(t) \quad (2.7)$$

Substituting  $K = 1.4$  and rearranging gives:

$$\dot{P}_c(t) = \frac{1.4 [W(t) - \rho_c(t) A \dot{C}(t)] P_c(t)}{A \rho_c(t) [C_o + C(t)]} \quad (2.8)$$

### D. Forces Acting on the Actuator Piston

Summation of the forces acting on the piston, yields the force balance equation:

$$P_c(t)A - PatmA - (M'_L + M'_p) \ddot{C}(t) - B_p \dot{C}(t) - K_s C(t) = 0 \quad (2.9)$$

The dimension of  $M_L^i$  and  $M_p^i$  in equation (2.9) is lbf. sec<sup>2</sup>/in. Converting the dimensions of  $M_C^i$  and  $M_p^i$  to lbm, then rearranging, equation (2.9) becomes:

$$\ddot{C}(t) = \frac{386 \{ [P_C(t) - P_{atm}] A - B_p \dot{C}(t) - K_S C(t) \}}{M_p + M_L} \quad (2.10)$$

It is noticed that the above derived equations (2.1) through (2.9) are all nonlinear except equation (2.10). Obviously the solution of these equations needs special treatment.

#### E. Approximate Solution to Obtain the Response of the Nonlinear System (6) (7)

If the values of  $\dot{P}(t)$ ,  $\dot{P}_C(t)$ ,  $\dot{C}(t)$ ,  $\dot{C}(t)$  are considered to be constant for a small time interval  $\Delta t$  which is much smaller than the dominant response time of the system, the following equations apply for calculating the values of  $P_t$ ,  $P_C$ ,  $\dot{C}$  and  $C$  at  $t = 0 + \Delta t$ :

$$P_t(0 + \Delta t) = P_t(0) + \dot{P}_t(0) \Delta t \quad (2.11)$$

$$P_C(0 + \Delta t) = P_C(0) + \dot{P}_C(0) \Delta t \quad (2.12)$$

$$\dot{C}(0 + \Delta t) = \dot{C}(0) + \ddot{C}(0) \Delta t \quad (2.13)$$

$$C(0 + \Delta t) = C(0) + \dot{C}(0) \Delta t \quad (2.14)$$

When a perfect gas undergoes an adiabatic expansion, such as occurs in the solenoid valve, the following equations apply:



$$\rho_t(0+\Delta t) = \rho_t(0) \left[ \frac{P_t(0+\Delta t)}{P_t(0)} \right]^{0.714} \quad (2.15)$$

$$\rho_c(0+\Delta t) = \rho_c(0) \left[ \frac{P_c(0+\Delta t)}{P_c(0)} \right]^{0.714} \quad (2.16)$$

Values calculated using equations (2.11) thru (2.16) can be substituted into equations (2.2), (2.6), (2.8) and (2.10) to compute  $W(0+\Delta t)$ ,  $P_t(0+\Delta t)$ ,  $\dot{P}_c(0+\Delta t)$  and  $\dot{C}(0+\Delta t)$  respectively.

Starting at  $t = 0+2\Delta t$  and continuing in increments of  $\Delta t$ , the Runge-Kutta approximation can be utilized in order to obtain better accuracy in this type of approximate solution.

Using the Runge-Kutta method all equations can be generalized for  $t = 0+n\Delta t$ :

$$P_t(0+n\Delta t) = P_t[0+(n-1)\Delta t] + \frac{\{\dot{P}_t(0+n\Delta t) + \dot{P}_t[0+(n-1)\Delta t]\} \Delta t}{2} \quad (2.17)$$

$$P_c(0+n\Delta t) = P_c[0+(n-1)\Delta t] + \frac{\{\dot{P}_c(0+n\Delta t) + \dot{P}_c[0+(n-1)\Delta t]\} \Delta t}{2} \quad (2.18)$$

$$\dot{C}(0+n\Delta t) = \dot{C}[0+(n-1)\Delta t] + \frac{\{\dot{C}(0+n\Delta t) + \dot{C}[0+(n-1)\Delta t]\} \Delta t}{2} \quad (2.19)$$

$$C(0+n\Delta t) = C[0+(n-1)\Delta t] + \frac{\{\dot{C}(0+n\Delta t) + \dot{C}[0+(n-1)\Delta t]\} \Delta t}{2} \quad (2.20)$$

$$\rho_t(0+n\Delta t) = \rho_t[0+(n-1)\Delta t] \left\{ \frac{P_t(0+n\Delta t)}{P_t[0+(n-1)\Delta t]} \right\}^{0.714} \quad (2.21)$$

$$\rho_c(0+n\Delta t) = \rho_c[0+(n-1)\Delta t] \left\{ \frac{P_c(0+n\Delta t)}{P_c[0+(n-1)\Delta t]} \right\}^{0.714} \quad (2.22)$$

$$W(O+n\Delta t) = K_d A_o \sqrt{180.5 \rho_t(O+n\Delta t) P_t(O+n\Delta t)} \quad (2.23)$$

(If critical flow)

$$W(O+n\Delta t) = 51.9 K_d A_o \sqrt{\rho_t(O+n\Delta t) P_t(O+n\Delta t) \left\{ 1 - \left[ \frac{P_c(O+n\Delta t)}{P_t(O+n\Delta t)} \right]^{0.286} \right\}}$$

$$\times \sqrt{\left[ \frac{P_c(O+n\Delta t)}{P_t(O+n\Delta t)} \right]^{1.428}} \quad (2.24)$$

(If subcritical flow)

$$\dot{P}_t(O+n\Delta t) = \frac{-1.4 P_t(O+n\Delta t) W(O+n\Delta t)}{V_t \rho_t(O+n\Delta t)} \quad (2.25)$$

$$\dot{P}_c(O+n\Delta t) = \frac{1.4 [W(O+n\Delta t) - P_c(O+n\Delta t) A \dot{C}(O+n\Delta t)] P_c(O+n\Delta t)}{A \rho_c(O+n\Delta t) [C_o(O+n\Delta t)]} \quad (2.26)$$

$$\ddot{C}(O+n\Delta t) = \frac{386 \{ [P_c(O+n\Delta t) - P_{atm}] A - B_p \dot{C}(O+n\Delta t) - K_s C(O+n\Delta t) \}}{M_p + M_L} \quad (2.27)$$

Based upon this set of equations, a flow diagram for solving the equations iteratively using an IBM 360 Computer was determined (see appendix A). Then a FORTRAN program was written (see appendix B) for the computation of  $P_t$ ,  $P_c$ ,  $\dot{C}$  and  $C$  with respect to time  $t$  as a variable.

## CHAPTER III

## DISCUSSION OF RESULTS

## A. Actuator Response Characteristics

Initially, data were computed for  $V_t = 1000 \text{ in}^3$ ,  $500 \text{ in}^3$  and  $200 \text{ in}^3$  respectively. (Fig. 2, 3 and 4). Calculated data included piston displacement, piston velocity, supply tank pressure and cylinder pressure as functions of time following a step change in solenoid control valve area from 0 to  $A_0$  at time  $t = 0+$ .

Fig. 2 shows that, for a supply tank volume of  $1000 \text{ in}^3$ , a solenoid valve metering area of  $0.0194 \text{ in}^2$  and an initial supply tank pressure of  $384.7 \text{ psia}$ , the supply tank pressure dropped to  $381.6 \text{ psia}$ , after an elapsed time of  $0.072 \text{ sec}$ . The total supply tank pressure drop for the complete actuating cycle is only  $3.1 \text{ psi}$ .

Note the cylinder pressure curve,  $P_c(t)$ , and the piston velocity curve,  $\dot{C}(t)$ . At the beginning, both  $P_c(t)$  and  $\dot{C}(t)$  increase very rapidly. This tendency persists until  $t = 0.0055 \text{ sec}$ . At this instant, the volume in the cylinder is increasing very rapidly, approximately  $25.13 \text{ in}^3/\text{sec}$ . Apparently because of the rather small value of  $A_0$ , the air flow rate entering the cylinder is not sufficient to keep cylinder pressure increasing and it starts to drop. The decrease in  $P_c(t)$  causes  $\dot{C}(t)$  to slow down.  $\dot{C}(t)$  has its peak value at  $t = 0.0135 \text{ sec}$ . After this  $\dot{C}(t)$  keeps

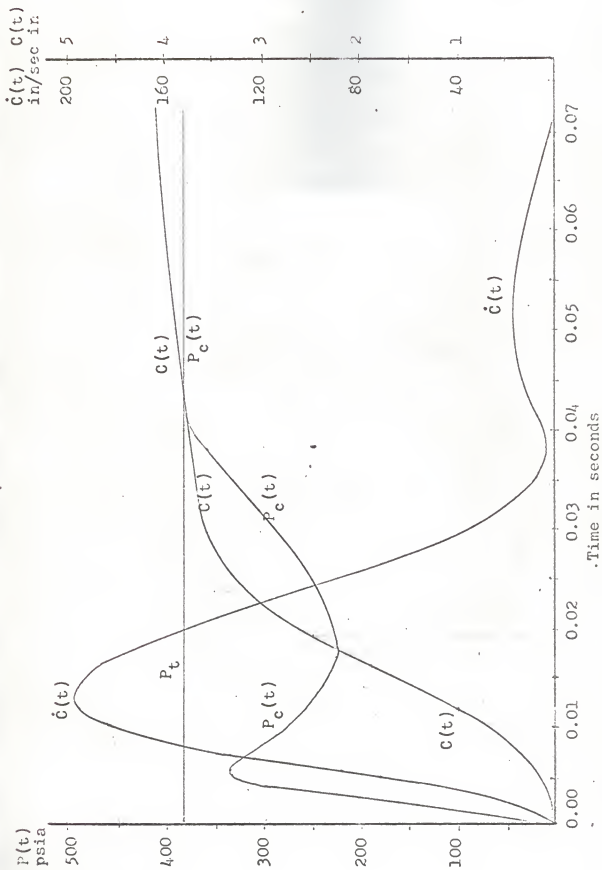

Fig. 2 Characteristic Actuator Response Curves,  $V_t = 1000 \text{ in}^3$ ,  $V_0 = .0194 \text{ in}^2$ .

decreasing and the interaction causes  $P_c(t)$  to increase until it equals the tank pressure  $P_t(t)$  at the time that the piston comes to rest.

Consider the piston displacement curve,  $C(t)$ , it increases very rapidly during the early stages. It increases approximately linearly between  $t = 0.01$  sec and  $t = 0.02$  sec. At  $t = 0.072$  sec the system has very nearly reached its steady state condition and  $C(0.072) = 4.05$  in.

The accuracy of the calculated results can be checked as follows:

At  $t = 0.072$  sec  $\dot{C} \approx 0$  and  $\ddot{C} \approx 0$ , therefore, the force balance equation for the piston is:

$$\left[ P_c(0.072) - P_{atm} \right] A - K_s C(0.072) = 0 \quad (3.1)$$

or

$$C(0.072) = \frac{P_c(0.072) - P_{atm}}{K_s} \quad (3.2)$$

Substituting  $P_c(0.072) = 381.6$  psia,  $P_{atm} = 14.7$  psia,  $A = 3.14$  in<sup>2</sup> and  $K_s = 291$  lbf/in., into equation (3.2) gives:

$$C(0.072) = 3.98 \text{ in.}$$

Compared to the approximate result of the numerical solution the relative error is:

$$\frac{4.05 - 3.98}{4.05} \times 100 = 1.73\%$$

This error is tolerable in this application.

For a tank volume of  $500 \text{ in}^3$ , a valve metering area of  $0.0194 \text{ in}^2$  and an initial supply tank pressure of  $384.7 \text{ psia}$ , Figure 3 shows that the supply tank pressure dropped  $384.7 - 378.7 = 6 \text{ psi}$ .

For  $V_t = 200 \text{ in}^3$ ,  $A_o = 0.0194 \text{ in}^2$  and  $P_t(0) = 384.7 \text{ psia}$ , Figure 4 shows that the supply tank pressure drop for a complete actuating cycle is  $384.7 - 370.6 = 14.1 \text{ psi}$ .

It can be observed that the  $P_c(t)$ ,  $\dot{C}(t)$ , and  $C(t)$  curves for both Fig. 3 and Fig. 4 are very similar to the same respective curves in Fig. 2.

#### B. Actuator Displacement Characteristics

As discussed in Chapter I of this report, for an air blast circuit breaker, the interrupting time (the time required for opening of the contacts) is desired to be less than  $0.033 \text{ sec}$ . (2 cycles). In other words, the time required for the piston (directly connected to the breaker contacts) to move a certain distance is of prime interest in this report.

To emphasize this interest, a distance quantity  $C_r$  is hereby defined.  $C_r$  is defined as the necessary piston displacement so as to acquire complete opening of the contacts. For the purposes of this report,  $C_r$  will be assumed to be 3, 3.5, or 5 inches. Next, a time quantity  $t_r$  is defined as the required response time for the piston to move  $C_r = 3, 3.5$  or 4 inches. These 2 quantities will be used as a basis

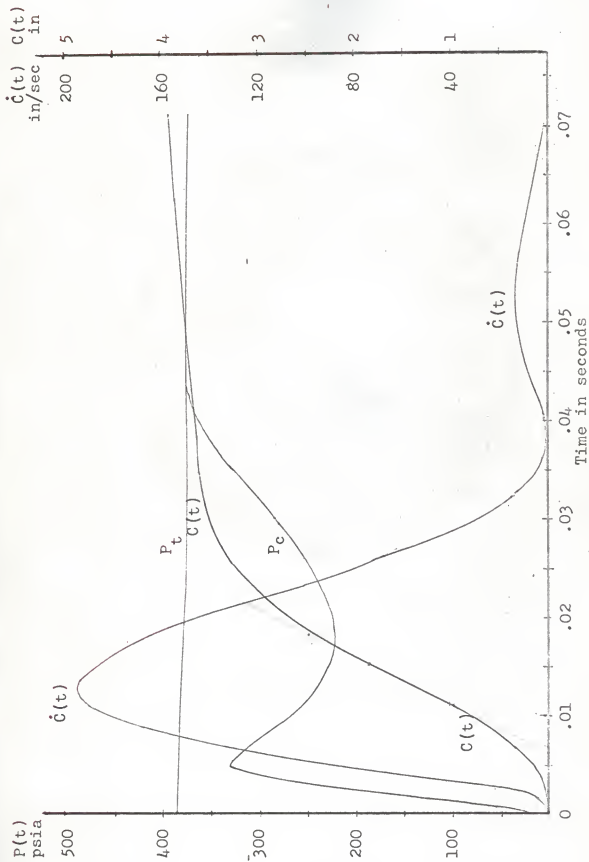

Fig. 3. Characteristic Actuator Response Curves,  $V_t = 500 \text{ in}^3$ ,  $A_0 = 0.0194 \text{ in}^2$ .

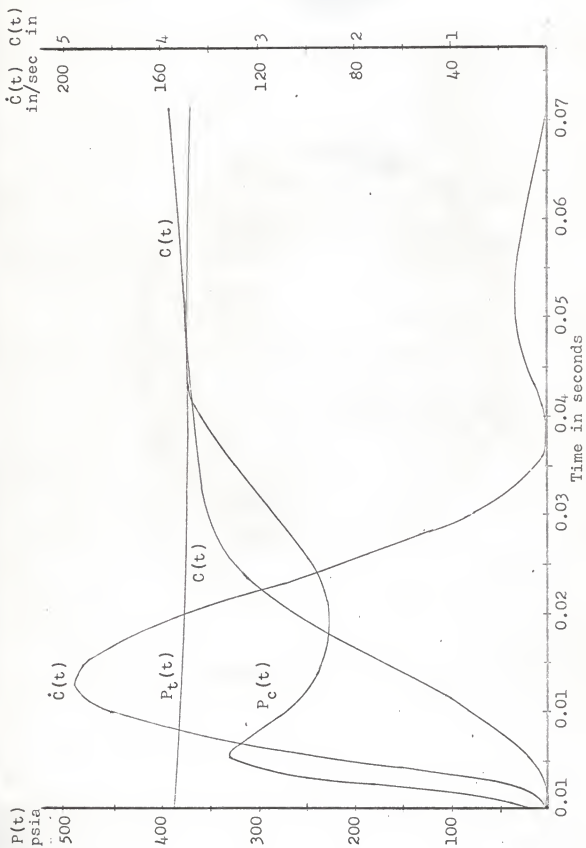

Fig. 4. Characteristic Actuator Response Curves,  $V_t = 200 \text{ in}^3$ ,  $A_0 = 0.0194 \text{ in}^2$ .



for investigating and comparing the approximate actuator displacement vs time curves calculated when certain parameters of the actuating system are varied.

In order to obtain a response characteristic for a simulated tank pressure drop of 36 psi (which corresponds to the supply tank pressure drop experienced in a complete opening of an Allis-Chalmers type ABM air blast circuit breaker), it was necessary to select a supply tank volume of 70 in<sup>3</sup>. Actuator displacement vs time curves for this case are shown in Fig. 5 for  $A_0 = 0.194$  in<sup>2</sup>, and in Fig. 6 for  $A_0 = 0.0194$  in<sup>2</sup>. For convenience of comparison, the actuator displacement curve for a tank volume of 1000 in<sup>3</sup> is also plotted on each figure.

Since piston displacement up to 4 inches is of most interest, the displacement curves in Fig. 5 (as well as in Fig. 6, 7, 8, etc.) are not completely presented for the purpose of simplicity.

In Fig. 5, for a control valve area of  $A_0 = 0.0194$  in<sup>2</sup> and a supply tank volume of  $V_t = 1000$  in<sup>3</sup>, the pressure drop during the complete actuating cycle is only 3.1 psi., as was previously noted.

In the same figure, for the same control valve area and a supply tank volume of 70 in<sup>3</sup>. The pressure drop during the complete actuating cycle is now 35.8 psi. This is approximately the same amount of pressure drop which occurs in the Allis-Chalmer type ABM circuit breaker during an operating cycle.

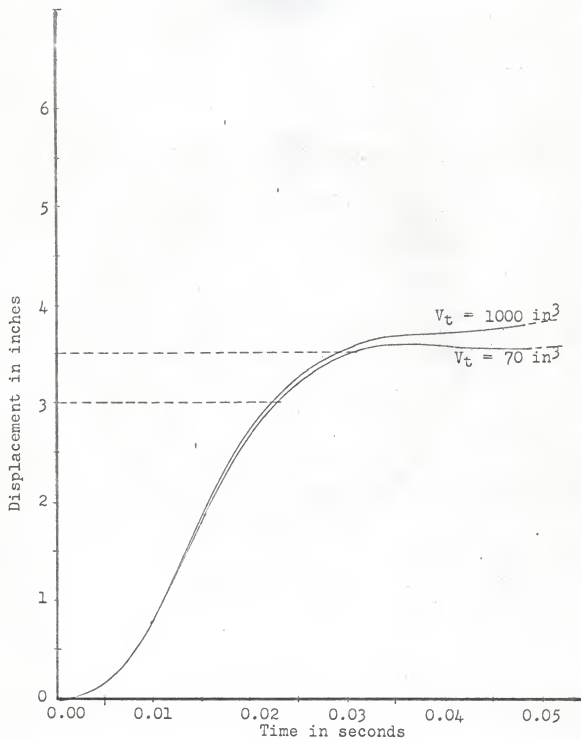

Fig. 5. Actuator Displacement Characteristics  
 $A_0 = 0.0194 \text{ in}^2$ .

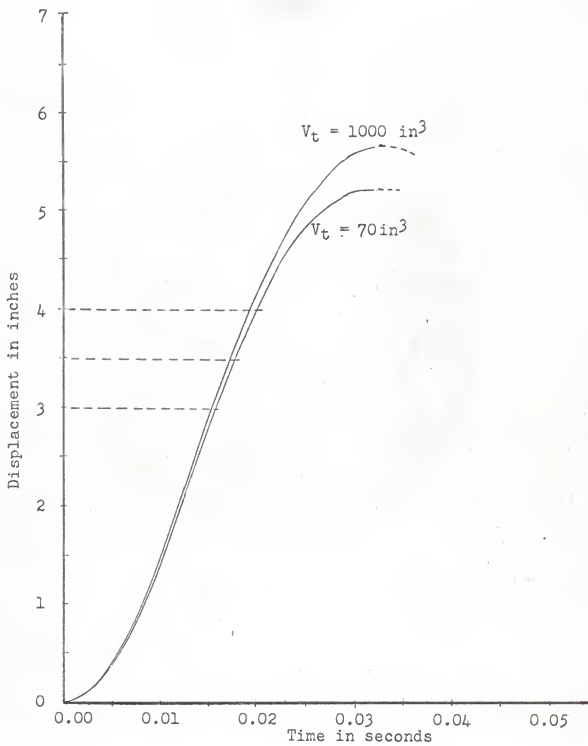

Fig. 6. Actuator Displacement Characteristics  
 $A_0 = 0.194 \text{ in}^2$ .

Comparing the response time  $t_r$  for a displacement of  $C_r = 3$  in. the time difference between these two pressure drops is only 0.0005 sec.

For  $C_r = 3.5$  in., the difference between the two response times is 0.0025 sec.

It can be observed that as time increases the difference in time required to reach a given displacement becomes more significant.

In Fig. 6 for a solenoid control valve area  $A_0 = 0.194$  in<sup>2</sup>, the respective pressure drop of the 1000 in<sup>3</sup> tank and 70 in<sup>3</sup> tank are the same as that of Fig. 5. The response time difference for  $C_r = 3$  in. is also 0.0005 sec.

For  $C_r = 3.5$  in., the  $t_r$  difference is 0.0006 sec which is smaller than that of Fig. 5. For  $C_r = 4$  in., the  $t_r$  difference becomes appreciable, i.e.,  $t_r = 0.001$  sec.

In summary, it can be said that for supply tank pressure drops as large as that experienced in the Allis-Chalmers type ABM circuit breaker, during its opening operation cycle, there is no significant difference in response time for actuator displacements up to 3.0 inches (for the assumed system).

#### C. Effect of Changing Control Valve Metering Area on Response Characteristics

In Fig. 7 five piston displacement curves are shown for a system with a supply tank volume of 1000 in<sup>3</sup> and solenoid control valve areas of 0.194 ( $\bar{A}_0 = 1$ ), 0.097 ( $\bar{A}_0 = 0.5$ ),

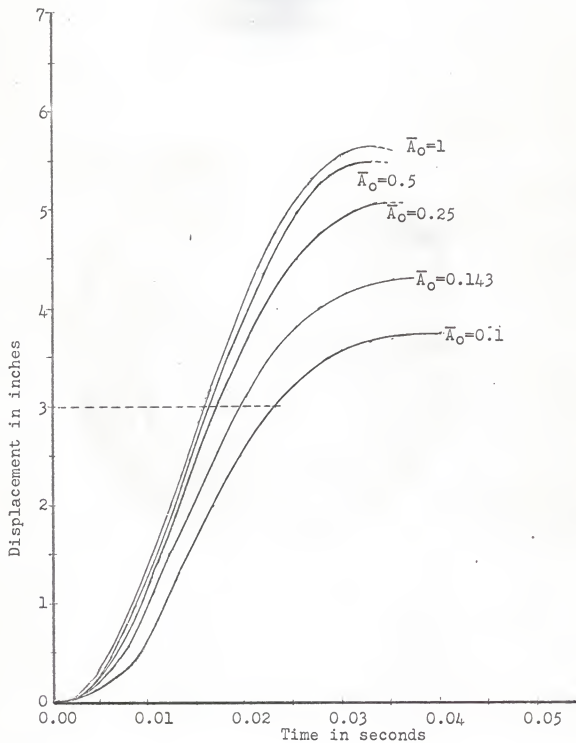

Fig. 7. Actuator Displacement Characteristics  
 $V_t = 1000 \text{ in}^3$ .

0.0485 ( $\bar{A}_O = 0.25$ ), 0.0277 ( $\bar{A}_O = 0.143$ ) and 0.0194 ( $\bar{A}_O = 0.1$ ) in<sup>2</sup> respectively.

Observe the curves plotted in Fig. 7 for  $\bar{A}_O = 1$  the response time for  $C_r = 3$  in. is 0.0155 sec. If the solenoid valve area is reduced by one half,  $\bar{A}_O = 0.5$ ,  $t_r$  is increased slightly to 0.016 sec.

If the valve area is reduced to  $\bar{A}_O = 0.143$ ,  $t_r$  is increased to 0.0195 sec. Finally, if the valve area is reduced to  $\bar{A}_O = 0.1$ ,  $t_r$  increases to 0.026 sec.

It is apparent that the area  $A_O$  of the on-off control valve is a significant parameter as far as response time is concerned. The larger the solenoid valve area, the faster the piston moves, and thereby the shorter the response time  $t_r$ .

Therefore, the response time  $t_r$  of the actuator can be increased or decreased depending on the area selected for the on-off control valve. But one thing must be pointed out here, that a limit for increasing  $A_O$  exists. As the area  $\bar{A}_O$  (Fig. 7) is increased from 0.25 to 1.0. The response time  $t_r$  is only reduced from 0.0192 sec. to 0.0155 sec, (0.0037 sec), while increasing  $\bar{A}_O$  from 0.1 to 0.25, reduced  $t_r$  from 0.028 sec to 0.0193 sec (0.0093 sec.).

Similar relationship between the piston displacement and control valve area can be observed in Fig. 8, for a supply tank volume of 500 in<sup>3</sup>, and in Fig. 9 for a supply tank volume of 200 in<sup>3</sup>.

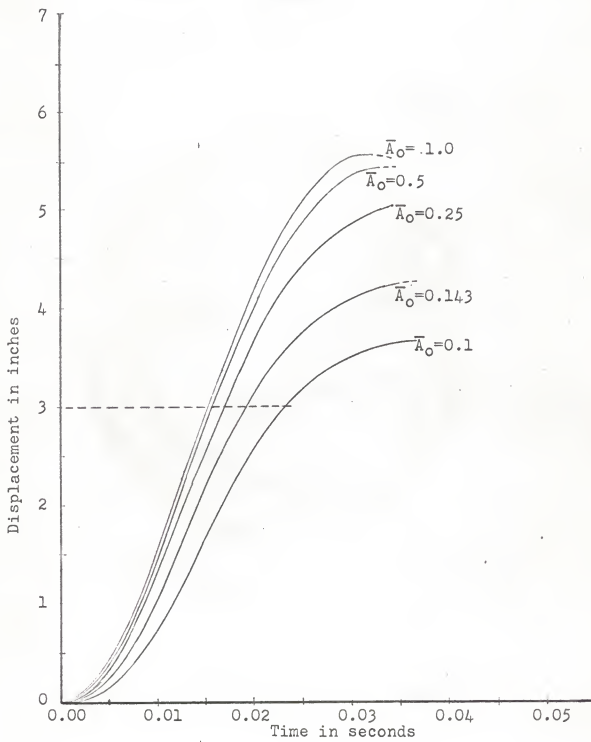

Fig. 8. Actuator Displacement Characteristics  
 $V_t = 500 \text{ in}^3$ .

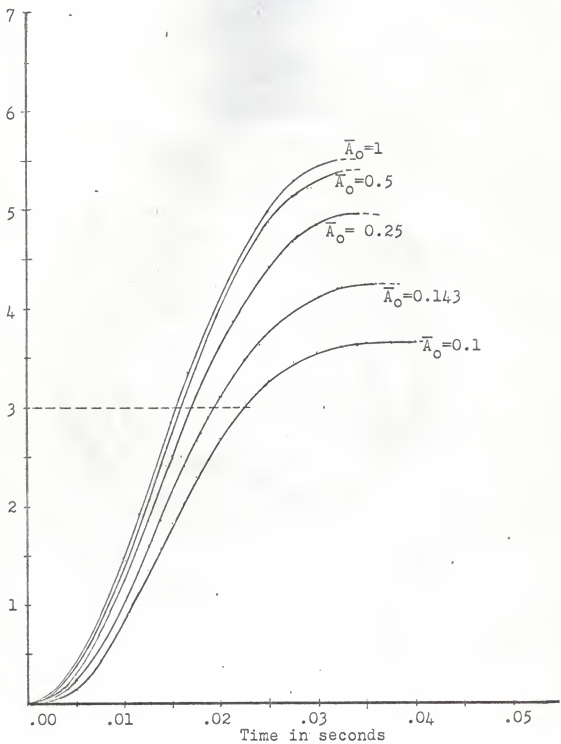

Fig. 9. Actuator Displacement Characteristics  
 $V_t = 200 \text{ in}^3$ .



#### D. Overshoot Behavior of the Piston Displacement

Fig. 10 shows the characteristic response curves for a supply tank volume of 200 in<sup>3</sup> and a solenoid control valve area of  $\bar{A}_0 = 0.5$ . It is observed that both the displacement  $C(t)$  curve and the piston velocity  $\dot{C}(t)$  curve overshoot considerably. The causes of this behavior has to be cleared.

From equation (2.10) in Chapter II. The following actuator transfer function can be derived:

$$\frac{C(s)}{F(s)} = \frac{1}{(M'_L + M'_p)s^2 + B_p s + K_s} \quad (3.2)$$

$F(s)$  is the Laplace transform of the pressure force  $f(t)$  acting on the piston of the actuator and is defined:

$$f(t) = [P_c(t) - P_{atm}] A \quad (3.3)$$

The damping ratio of this system is

$$= \frac{B_p}{2\sqrt{K_s(M'_L + M'_p)}} = \frac{1.5}{2\sqrt{291\left(\frac{10+1.126}{386}\right)}} = 0.259$$

In Fig. 10 the control valve metering area selected is quite large and it can be observed that the pressure force  $P_c(t)$  at time  $t = 0+$  is very nearly constant and constant thereafter.

It is approximately a step input for an underdamped second order system having a damping ratio  $\zeta < 1.0$ . The displacement following a step input would be of the form

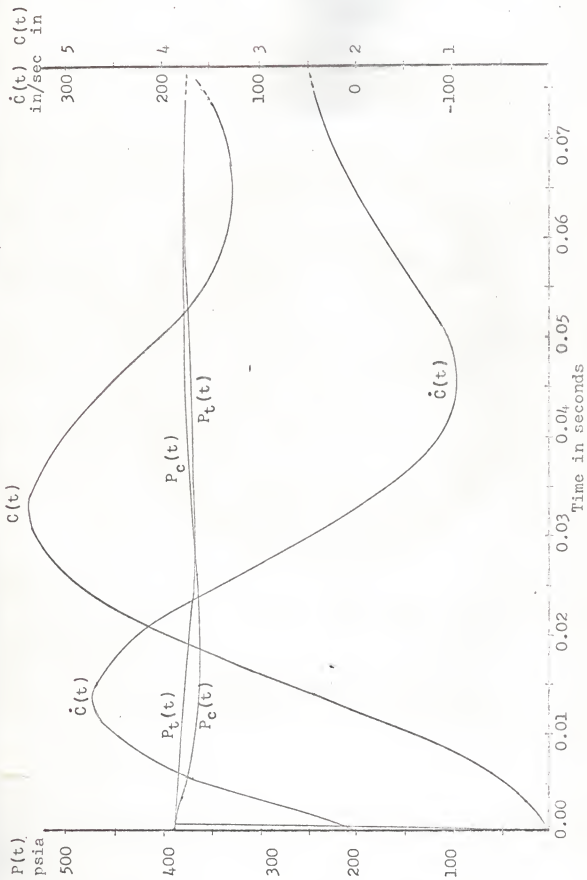

Fig. 10. Overshoot Behavior,  $V_t = 200 \text{ in}^3$ ,  $A_o = 0.097 \text{ in}^2$ .

$$C(t) = \frac{1}{\omega_n^2} - \frac{1}{\omega_n^2 \sqrt{1-\zeta^2}} e^{-\zeta \omega_n t} \sin(\omega_n \sqrt{1-\zeta^2} t + \phi) \quad (3.4)$$

where  $\phi = \text{Cos}^{-1} \zeta$

The oscillatory nature of the  $C(t)$  curve in Fig. 10 is of this form. When the control valve metering area is small (say  $A_0 = .0194 \text{ in}^2$  as in Fig. 2)  $P_c(t)$  deviates considerably from being a step input. The result is that the  $C(t)$  curve shows no overshoot at all.

#### E. Rise time Consideration for Solenoid Control Valve

One more thing should be mentioned here. The 3-way solenoid on-off type control valve discussed in this report was assumed to open instantaneously at time  $t = 0+$ . In the actual case, a finite rise time is required for the solenoid valve to fully open.

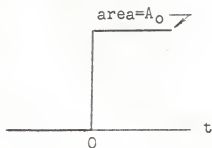

Assumed  $\therefore$  rise time = 0

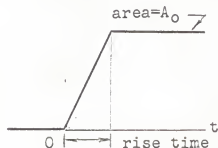

Skinner solenoid control valve rise time = 0.0045 sec.

Fig. 11. Rise Time of Solenoid Control Valve.

This rise time will vary considerably according to the fluid media, and the applied voltage. As a typical example, a Skinner Electric Co. V-5 series three-way solenoid valve requires .0045 sec (AC operation) to fully open if the fluid is air. The response times calculated in this report would probably be .003 to .004 sec. greater in the case of an actual solenoid valve and actuator. Even so, they would still be 0.003 sec. less than the 0.033 sec. response time desired for 2 cycle breaker interruption.

#### F. Selection of $\Delta t$ for Computing Response Characteristics

In numerical approach to the solution of the response characteristics of a nonlinear system, the proper choice of the time increment  $\Delta t$  is very important. The size of  $\Delta t$  for computation is determined by the system parameters and the degree of accuracy demanded. Choice of a large (coarse) value for  $\Delta t$  will cause large error in the computed results, while choice of a small  $\Delta t$  will require more computing iterations. Initially,  $t = 0.0001$  sec. can be selected for a first trial. If the response curve for  $P_c(t)$  comes out with peculiar oscillations of relatively high frequency, this indicates that choice of a smaller value for  $\Delta t$  is required. Usually, this kind of oscillation only occurs over certain time intervals. Therefore, the computer program was written such that the smaller value of  $\Delta t$  was only used in the

effected portion so as to save unnecessary computing iterations. For instance, in computing the results of Fig. 10, a small value for  $\Delta t$  (0.00001 sec.) had to be used in the time interval 0 to 0.032 sec.

CHAPTER IV  
CONCLUSIONS

In this report, the response characteristics of a nonlinear compressible fluid actuating system were investigated. Fluid actuating system of this type are used for controlling the operation of air blast circuit breakers used to protect EHV power transmission systems. Determining the response characteristics of such a system is quite involved because they are nonlinear. Use of approximate techniques to investigate the response resulted in the following conclusions:

1. Numerical techniques can be employed to obtain the approximate response characteristics of such systems. The accuracy of this approach, approximately 2%, is acceptable for engineering design purposes.
2. The analysis made in this report is based on certain assumptions, therefore, some deviation in the performance will be expected in actual case. Specifically, the neglecting of the rise time of the solenoid valve may cause some errors.
3. The response time of the actuator is strongly influenced by the size of metering area of the control valve.
4. The supply tank pressure drop occurring during a complete opening operation did not appreciably

effect the response time for up to 3 in. of actuator travel, for supply pressure drops as large as 36 psi.

5. A large control valve metering area caused  $P_c(t)$  to become approximately a step input. This resulted in overshoot and oscillation in the  $C(t)$  response curves.
6. A limit for increasing  $A_0$  in an attempt to make  $t_r$  small exists. In the system discussed in this report when  $\bar{A}_0$  was increased from 0.25 to 1.0 the decrease in  $t_r$  was only 0.0037 sec.
7. Proper choice of the time increment  $\Delta t$  used for computing the results is important. If a high frequency oscillation appears in the computed results for  $P_c'(t)$ , a smaller  $\Delta t$  should be tried.
8. The system (with  $V_t = 1000 \text{ in}^3$ ,  $A_0 = 0.0194 \text{ in}^2$ ) presented in this report has a response time of 0.0225 sec. for 3 in. of piston travel. If 0.004 sec. is allowed for the rise time of an actual solenoid valve, the response time 0.0265 sec. would still satisfy the interrupting time of 2 cycles.

## SELECTED REFERENCES

1. Meinders, G. J. ' A New HV and EHV Air Blast Circuit Breaker Design. Paper No. 31TP66-110 IEEE Transactions March 1967. New York, The Institute of Electrical and Electronics Engineers, 1967.
2. Allis-Chalmers. Instruction Book, Air Blast Circuit Breaker, Type ABM. Hyde Park, Mass.: Allis-Chalmers Mfg. Co. 1967.
3. Turnquist, Ralph O. Class Notes, Fluid Control System (ME 735) Manhattan, Kansas State University, 1967.
4. Shapiro, Ascher H. The Dynamic and Thermodynamics of Compressible Fluid Flow. New York: The Ronald Press Company, 1953.
5. Blackburn, John F. Fluid Control System. Cambridge, Mass.: Technology Press of M.I.T., 1960.
6. Parker, S. Thomas. Class Notes, Numerical Analysis I (Math 761) Manhattan, Kansas State University, 1967.
7. Conte, S. D. Elementary Numerical Analysis. New York: McGraw-Hill Book Company, 1965.



APPENDICES

APPENDIX A  
FLOW CHART OF COMPUTER PROGRAM

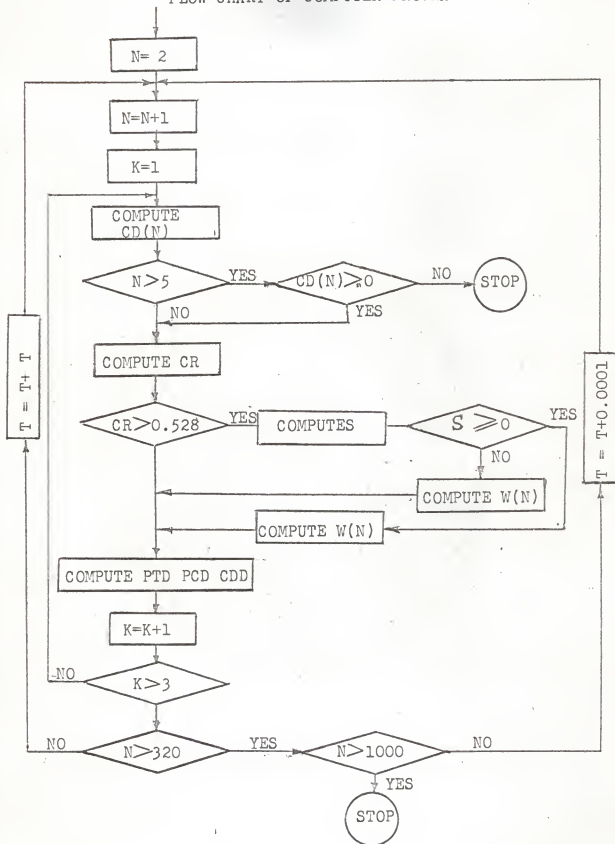

APPENDIX B  
 FORTHRAN PROGRAM

```

NONLINEAR ANALYSIS OF THREE-WAY VALVE AND CYLINDER OPERATION
DIMENSION PT(1000),PC(1000),CD(1000),C(1000),RT(1000),RC(1000)
DIMENSION W(1000)
DIMENSION PTD(1000),PCD(1000),CDD(1000)
200 FORMAT(4F16.8)
READ (1.200) DT,DK,AO,BP,SK,TV,A,CM,PM,PT(1),PC(1),PTD(1)
READ (1.200) PCD(1),CDD(1),CD(1),C(1),RT(1),RC(1),CO
80 FORMAT(F7.5,4E16.8)
95 FORMAT(/5X,1HT,12X,5HPT(T),11X,5HPC(T),9X,8HDC/DT(T),10X,4HC(T))
WRITE (3,95)
T=0.00001
DO 10 N=2,1000
M=N-1
PTD(N)=PTD(M)
PCD(N)=PCD(M)
CDD(N)=CDD(M)
CD(N)=CD(M)
K=1
20 PT(N)=PT(M)+(PTD(N)+PTD(M))*DT/2.
PC(N)=PC(M)+(PCD(N)+PCD(M))*DT/2.
CD(N)=CD(M)+(CDD(N)+CDD(M))*DT/2.
IF(N-5)25,25,88
88 IF(CD(N))131,131,25
25 C(N)=C(M)+(CD(N)+CD(M))*DT/2.
RT(N)=RT(M)*(PT(N)/PT(M)**0.714
RC(N)=RC(M)*(PC(N)/PC(M)**0.714
CR=PC(N)/PT(N)
IF(CR-0.528)30,30,32
30 W(N)=DK*AO*SQR(180.5*RT(N)*PT(N))
GO TO 60
32 S=1.-(PC(N)/PT(N))**0.286
IF(S)40,33,33
33 W(N)=SQR(S)*((PC(N)/PT(N))**1.428))
W(N)=51.9*DK*AO*SQR(RT(N)*PT(N))*W(N)
GO TO 60
40 S=1.-(PT(N)/PC(N))**0.286
W(N)=-SQR(S)*((PT(N)/PC(N))**1.428))
W(N)=51.9*DK*AO*(SQR(RC(N)*PC(N))*W(N)
60 PTD(N)=-1.4*PT(N)*W(N)/(TV*RT(N))
PCD(N)=1.4*(W(N)-RC(N)*A*CD(N))*PC(N)/(A*RC(N)*(CO+C(N)))
CDD(N)=386.0*((PC(N)-PC(1))*A-BP*CD(N)-SK*C(N))/(PM+CM)
K=K+1
IF(K-3) 20,20,70
70 WRITE (3.80) T,PT(N),PC(N),CD(N),C(N)
IF(N-650)10,10,12
12 DT=.0001
10 T=T+DT
131 STOP
END

```

NONLINEAR ANALYSIS OF THREE-WAY CONTROL VALVE AND  
CYLINDER OPERATING WITH COMPRESSIBLE FLUID

by

ROBERT I-JEN JUNG

Diploma, Air Technological College, Taiwan, China, 1950

---

AN ABSTRACT OF A MASTER'S REPORT

submitted in partial fulfillment of the

requirements for the degree

MASTER OF SCIENCE

Department of Mechanical Engineering

KANSAS STATE UNIVERSITY  
Manhattan, Kansas

1968

This report presents a nonlinear analysis of a three-way control valve and cylinder operating with a compressible fluid. The system consists of a supply tank, a piston type actuator, and an on-off type solenoid control valve. Such actuating systems are used to operate air blast type circuit breakers which are used to protect power transmission networks.

The characteristics of compressible fluid flow through valves, plus displacement, velocity, and acceleration equations are derived. Then equations, all nonlinear except one, are solved by numerical method.

Response curves for actuator displacement, actuator velocity, and supply tank pressure at functions of time were calculated and are presented.

The results indicates that the response time of the actuator is most strongly influenced by the size of the metering area of the control valve. It was found that supply tank pressure drops up to 36 psi did not appreciably effect the response time for actuator travels up to 3 inches.

The results also indicate that a large control valve metering area will result in overshoot in the response curves if the damping ratio for the actuator is less than 1.0.