

**THIS BOOK
CONTAINS
NUMEROUS
PAGES WITH
THE ORIGINAL
PRINTING ON
THE PAGE BEING
CROOKED.**

**THIS IS THE
BEST IMAGE
AVAILABLE.**

AN EXAMINATION OF THE EFFECT OF
DIFFERENTIAL SETTLEMENT ON FRAMES

by

DSCHAUYIEN KU

Diploma, Taipei Institute of Technology
Taipei, China, 1962

5248

A MASTER'S REPORT

submitted in partial fulfillment of the
requirements for the degree

MASTER OF SCIENCE

Department of Civil Engineering

KANSAS STATE UNIVERSITY
Manhattan, Kansas
1971

Approved by:

Wayne W. Williams
Major Professor

LD
2668
R4
1971
K8
C.2

CONTENTS

I.	INTRODUCTION	
	1. STATEMENT OF THE PROBLEM	1
	2. PURPOSE OF THE STUDY	1
	3. SCOPE OF THE STUDY	2
II.	REVIEW OF LITERATURE	3
III.	EXAMINATION OF THE EFFECT OF DIFFERENTIAL SETTLEMENT ON FRAMES	6
	(A) PLANE FRAMES	7
	(B) SPACE FRAMES	17
IV.	CONSLUSIONS	36
V.	ACKNOWLEDGEMENTS	38
VI.	REFERENCES	39
VII.	APPENDIX	41

INTRODUCTION

1. Statement of the problem

Damage to a structure is usually attributed to the failure of structural members or of the foundation. In general, the design of a structure is separated into two parts. The structural engineer designs the superstructure only and puts the focus on the fiber stresses in the members subjected to external loads. The soil engineer uses the loads transferred from the superstructure and considers only the soil condition to design the foundation. If a building settles uniformly the stresses in the members of the structure are not increased. However, uniform settlement is usually not the case. Differential settlement must be considered inevitable for most structures unless the foundation is supported by solid rock. Thus differential settlement may govern both the design of the foundation and of the superstructure. If the design of the structure is conservative enough to prevent cracks or large distortions it is considered a good design. When distortions become evident the foundation is immediately suspected even though a change in structural design to prevent large carry-over of loading might have avoided the distress. Both foundation design and structural design should thus take into account the consequences of differential settlement in main load-carrying members. Recognition of this fact can result in considerable savings in construction cost, without reduction in the factor of safety, since a more properly balanced design is produced.

2. Purpose of the study

Conventional structural design of a framed structure involves computation of stresses in the members for the various loading conditions without differential settlement. The stress change in each member of a frame due to yielding supports can be treated by the same techniques. If the differential settlement can be predicted with reasonable accuracy, and if the design of both superstructure and foundation take into account the reactions and moments caused by the settlement, such a procedure may make the structure design more economical and safe.

In this report reinforced concrete frames with multiple stories and bays are analyzed for the purpose of examining the effect of differential settlement on the frames.

3. Scope of the study

Parts of the structure of Haymaker Hall at Kansas State University were taken as examples in order to examine the effect of differential settlement on various superstructures.

The analyses were carried out by using STRUDL II (1)*, a computer program designed by Massachusetts Institute of Technology, for structural analysis. The program was run on the IBM 360/50 computer at the Kansas State University Computing Center.

The computed results were presented and compared to each other in order to examine the effect of differential settlement on the frames.

* Numerals in parentheses refer to corresponding items in
R References.

REVIEW OF LITERATURE

The most important factor which governs the design of a foundation is the determination of the greatest pressure that can be applied to the soil beneath the footing without causing either failure of the loaded area or excessive settlement (2). Methods of computation of settlement are widely discussed. In both Timoshenko's theory of elasticity (3) and Terzaghi's theory of consolidation (4), the settlement is computed under the assumption of the footings not being mutually connected and therefore infinitely capable of adapting themselves to the deformation of the soil. This assumption is misleading, especially in the case of high building structures (5). The rigidity of a superstructure results in lower differential settlement and modifies the patterns of settlement. A rigid structure resists deformation due to soil movement and transfers loads and pressures from points of maximum effect to points of minimum effect, thus reducing differential settlement (5, 6, 7, 8, 9, 10, 11).

Differential settlement has a great effect on the stresses in the members of a structure. After analyzing a five-story, three-bay reinforced concrete frame, Mayerhof (12) pointed out that a differential settlement, $\Delta = 0.315$ inch in a span of $L = 25$ feet caused an increase of 74 per cent in the bending moment in the beam which was subjected to the largest moment prior to settlement.

Reickert (13), who investigated the effect of differential

settlement on the main building of Charity Hospital at Yale University, concluded that cracking is likely to occur in all cases where differential settlement is observed. As the settlement becomes large, flexural strain can be expected in the beams and columns of steel-framed buildings. The magnitudes of these strains are based on the rigidity of the beam-to-column connections, the relative stiffness of beams and columns, the length-depth ratios of the members, and the slopes of the members caused by differential settlement.

The amount of allowable settlement is dependent on the properties of the supporting soil and the rigidity of the structure. The determination of what amount of allowable settlement can be tolerated by a structure has been studied by an evaluation of conditions under which measured settlements have caused distress. Polishin and Tokar (14) analyzed the settlement of structures based upon the data from field observations at 100 sites and summarized the results. This summation was later adapted as the standard code in the U.S.S.R. in 1955 (14). This Standard Code is given in Table 1.

Table 1. Maximum differential settlement criteria by the
1955 U.S.S.R. Building Code#

Description	Sand and hard clay	Plastic clay
Difference in settlement of civil- and industrial-building column foundations:		
a. For steel and reinforced concrete structures	0.002L*	0.002L
b. For end rows of columns with brick cladding	0.007L	0.001L
c. For structures where auxiliary strains do not arise during non-uniform settlement of foundations	0.005L	0.005L
Relative deflection of plain brick walls		
a. For multi-story dwellings and civil buildings		
at $L/H \leq 3$	0.0003L**	0.0004L
at $L/H \geq 5$	0.0005L	0.0007L
b. For one-story mills	0.0010L	0.0010L

After Polshin and Tokar (14)

* L= distance between column centers

** L= length of deflected part of walls

H= height of wall from foundation footings

EXAMINATION OF THE EFFECT OF
DIFFERENTIAL SETTLEMENT ON FRAMES

Parts of an actual nine-story reinforced concrete building, Haymaker Hall at Kansas State University, were used as an example to examine the effect of differential settlement on frames. There is no significance in the study of this building, except for the convenience of using the actual member sizes and the frame dimensions. The following frames were chosen for the desired analyses:

1. One- to five-story, one-bay plane frames with settlement at support 2 (see Fig. 24*).
2. One- to five-story, two-bay plane frames with settlement at
 - a. support 2 (Fig. 25).
 - b. support 3 (Fig. 25).
3. One- to five-story, one-bay space frames with settlement at support 3 (Fig. 26).
4. One- to five-story, two-bay space frames with settlement at
 - a. support 4 (Fig. 27).
 - b. support 5 (Fig. 27).

The member properties are shown in Table 2**.

* Support and joint designations are shown in Figs. 24, 25, 26 and 27 in the Appendix.

** Table 2 will be found in the Appendix.

The analyses are based on the following assumptions:

1. The frame is rigidly fixed to the foundation.
2. The joints are rigid.
3. Deformation of one inch was assumed for the purpose of analysis.

All frames were analyzed by the computer program STRUDL II, developed by Massachusetts Institute of Technology in 1968, with the help of an IBM 360/50 computer at the Kansas State University Computing Center. In using STRUDL II only suitable data cards, which are designed according to the instructions of the "Simplified User's Manual" (1) to describe the problem, are needed for the analysis.

The results, showing the joint moments caused by differential settlement, are presented in Table 3 through Table 8 in the Appendix. The sign convention considers that the moment on the joint is positive when counterclockwise and is negative when clockwise. The units of moment are kip-inches. In the three-dimensional frames, a global coordinate system is used and the moments M_x , M_y and M_z correspond to the x, y and z axes, respectively. The x axis is horizontal, y axis the vertical and the z axis normal to the page (see Figs. 26 and 27). The moment vectors are positive when directed in positive coordinate directions.

(A) Plane Frames

Moments induced in the members of one- to five-story, one-bay plane frames are shown in Table 3.

The moment diagram for the five-story, one-bay plane frame with one inch settlement at the right support is shown in Fig. 1. These results indicate that the moments induced both in upper story columns and cross-beams damp out quickly in one-bay plane frames with an increasing number of stories. The moments induced in the members in the top story of five-story plane frame are approximately zero.

The variation of moments in the top of the first column and first cross-beam of the same joint for various-storied, one-bay plane frames are shown in Fig. 2. The moment induced in member 1 at joint 3 increased significantly in going from a one-story to a two-story frames, while the moment induced in member 2 at joint 3 decreased significantly. The moments both in columns and cross-beam changed only slightly when the number of stories in the frame was greater than two.

Two cases of settlement were considered for the two-bay plane frames. The first case involved a one inch settlement at the middle support and the second case involved a one inch settlement at an external support. The moments induced in the members for different number of stories are listed in Table 4 and Table 5. These computed data indicate that the moments induced in members of two-bay plane frames, especially when subjected to symmetrical settlement, are more significantly affected by the differential settlement than those induced in members of one-bay plane frames affected by differential settlement.

In Fig. 3 and Fig. 4, the moment diagrams are given for

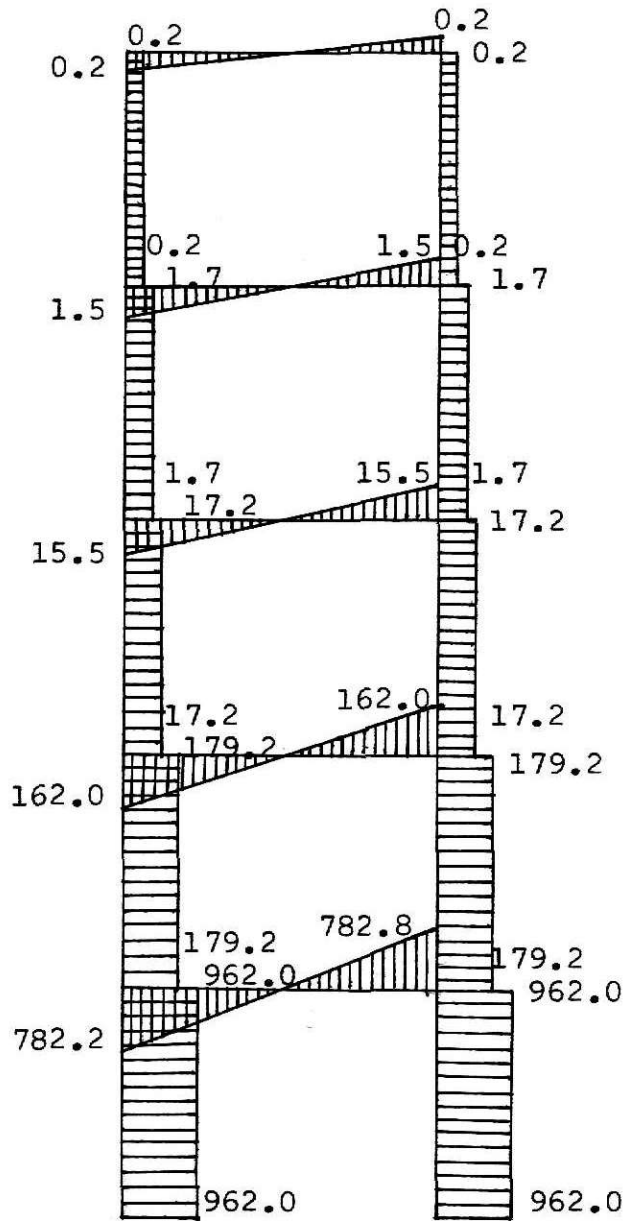

Fig. 1. Moment diagram of five-story one-bay frame with one-inch settlement at right support

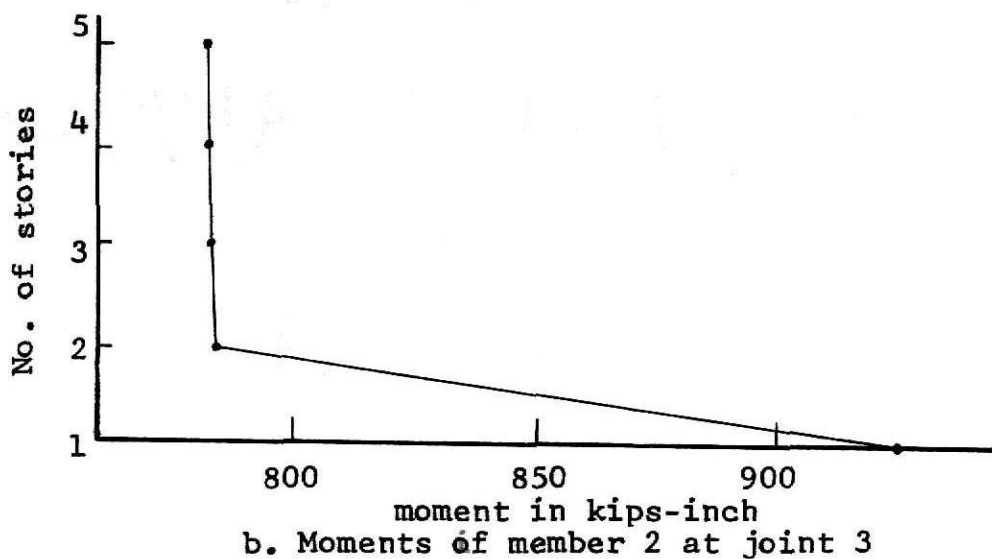
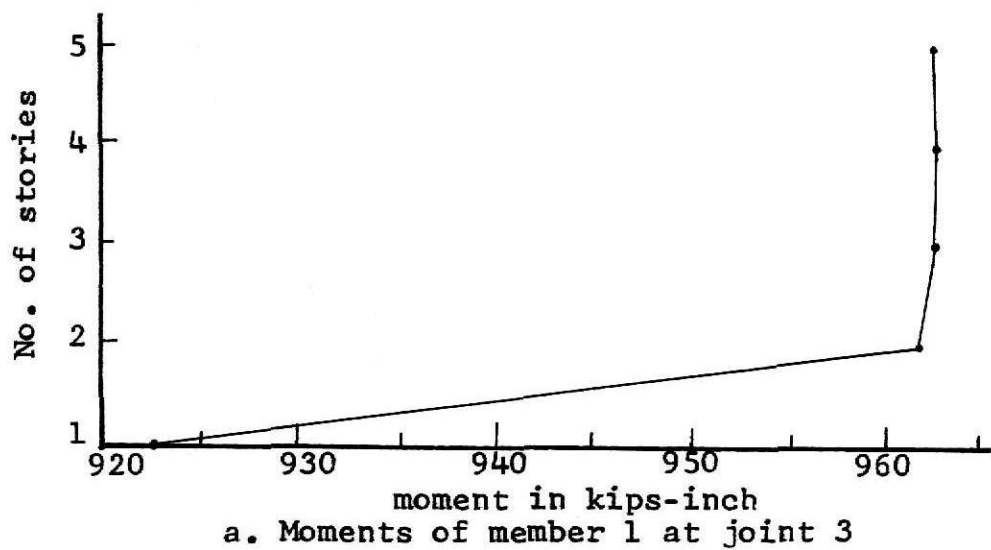

Fig. 2. Variation of moments in members 1 and 2 for different stories in one-bay plane frame with one inch settlement at right support

two five-story, two-bay plane frames subjected to a one inch settlement at support 2 and support 3, respectively. Regardless of the lack of symmetry of settlement, the moments induced in the upper symmetrical cross-beams and columns become equal. This phenomenon may be thought of as being analogous to St. Venant's principle, which says that at a point in a solid which is sufficiently far from the point of application of the loads, the induced stresses are independent of the particular manner in which the loads are applied.

Comparing the moment diagrams of the two five-story, two-bay plane frames the moments induced in the members of the frame with one inch settlement at the middle support, shown in Fig. 3, are, for the most part, larger than those in the corresponding members of the same frame with settlement at the right support as shown in Fig. 4. Thus it can be said that a multi-bay plane frame which is subjected to settlement at an inner support will suffer more distress than that caused by an equal amount of settlement at an external support.

According to the principle of superposition, the moments induced in the members of a five-story, two-bay plane frame subjected to a one inch settlement at the right external support, as shown in Fig. 5c, can be obtained by adding the moments induced in the members of the same frame subjected to half inch symmetrical settlement at the external supports, as shown in Fig. 5a, and the moments induced in the members of the same frame subjected to distributed settlement with a maximum differential settlement of one inch, as shown in Fig. 5b. Using this method,

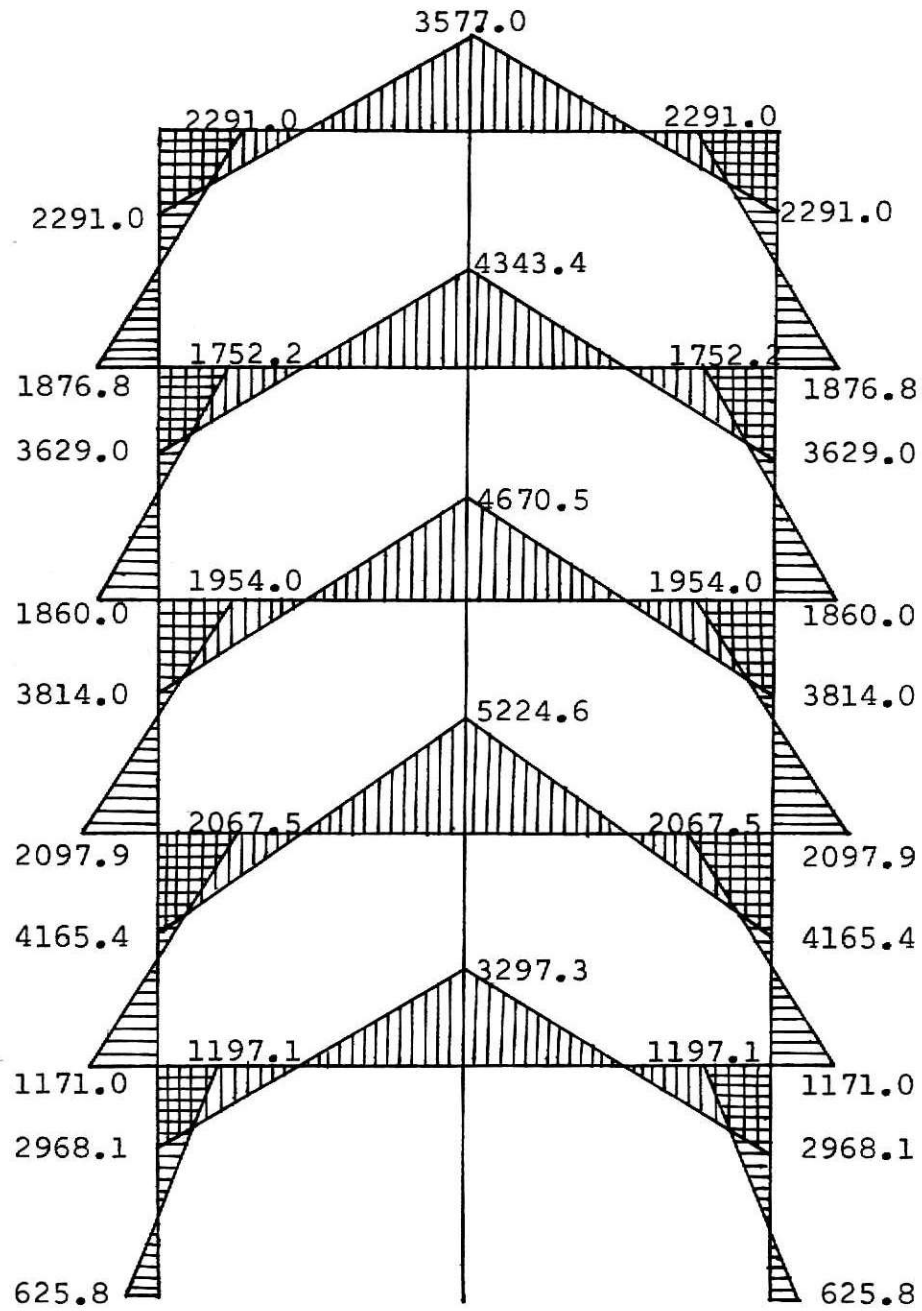

Fig. 3. Moment diagram of five-story two-bay plane frame with one inch settlement at middle support

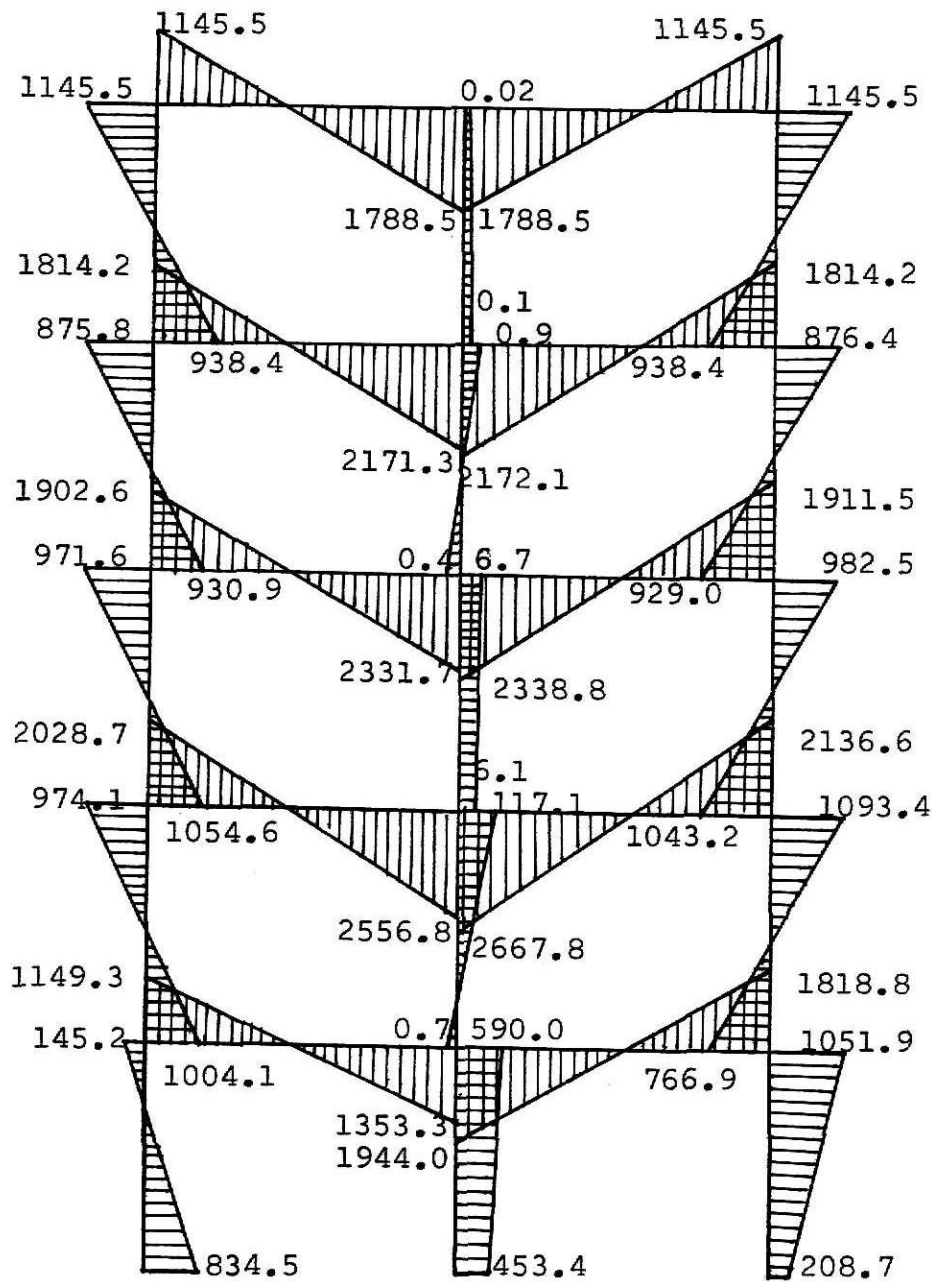

Fig. 4. Moment diagram of five-story two-bay plane frame with one inch settlement at right external support

the moments induced in the members of a five-story, two-bay plane frame subjected to distributed settlement with one inch maximum differential settlement can be computed from Fig. 3 and Fig. 4. This result is shown in Fig. 6. Comparing this moment diagram to those shown in Figs. 3 and 4, it is found that moments induced in the members of the frame subjected to distributed settlement are smaller than those in the other cases, provided that the maximum differential settlements are the same.

The variations of moment induced in different members of these frames are shown as follows:

1. In the one- to five-story, two-bay plane frames with one inch settlement at the middle support, moments induced in member 1 at joint 4, in member 4 at joint 5 and in member 5 at joint 6 are shown in Fig. 7.

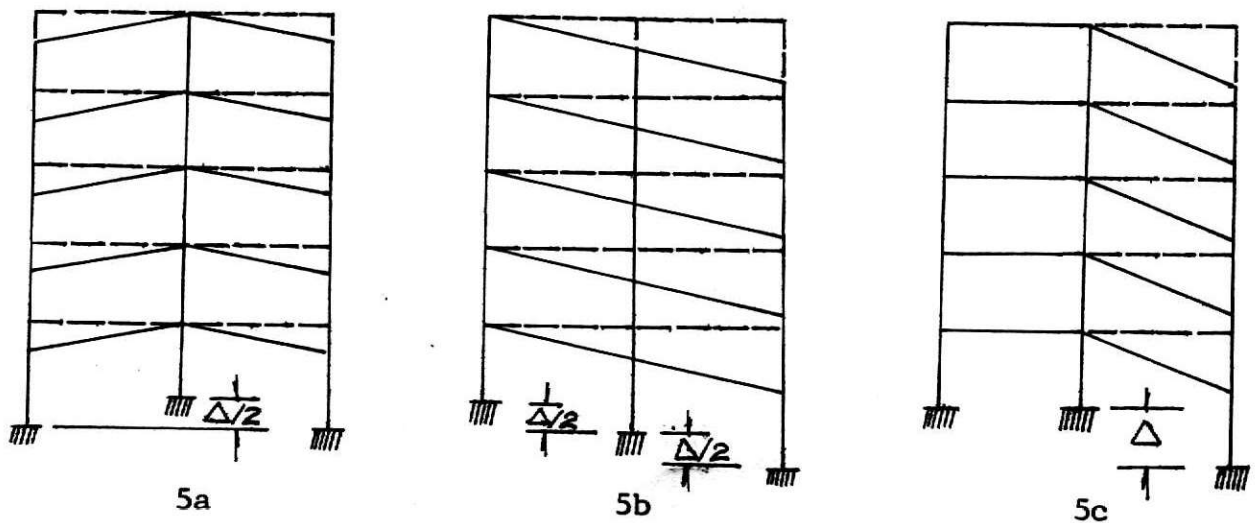

Fig. 5. Principle of superposition

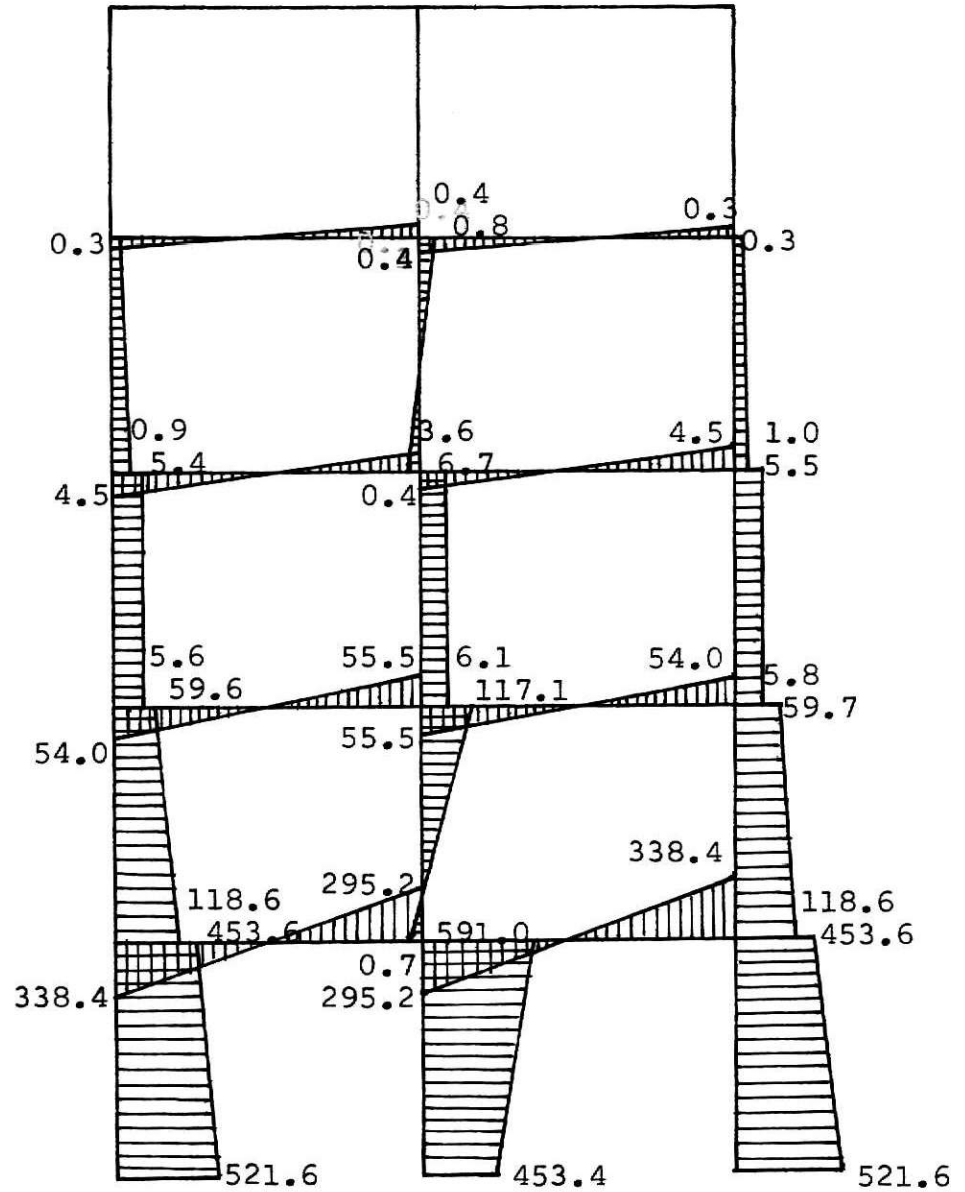
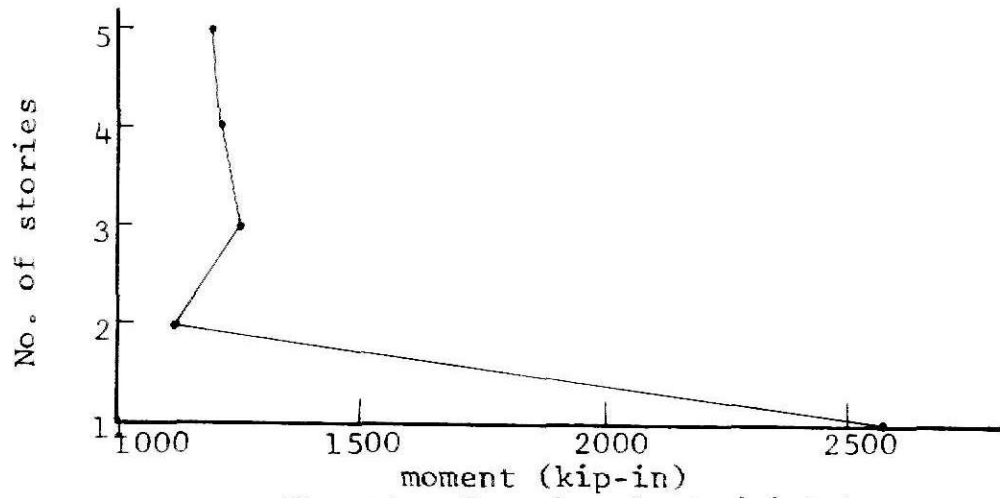
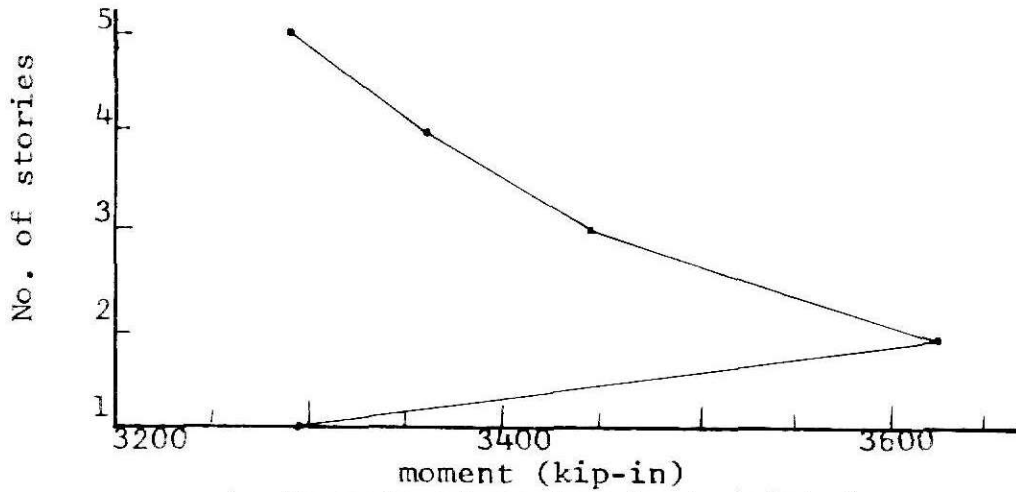

Fig. 6. Moment diagram of five-story two-bay plane frame with linear settlement



a. Moments of member 1 at joint 4



b. Moments of member 4 at joint 5

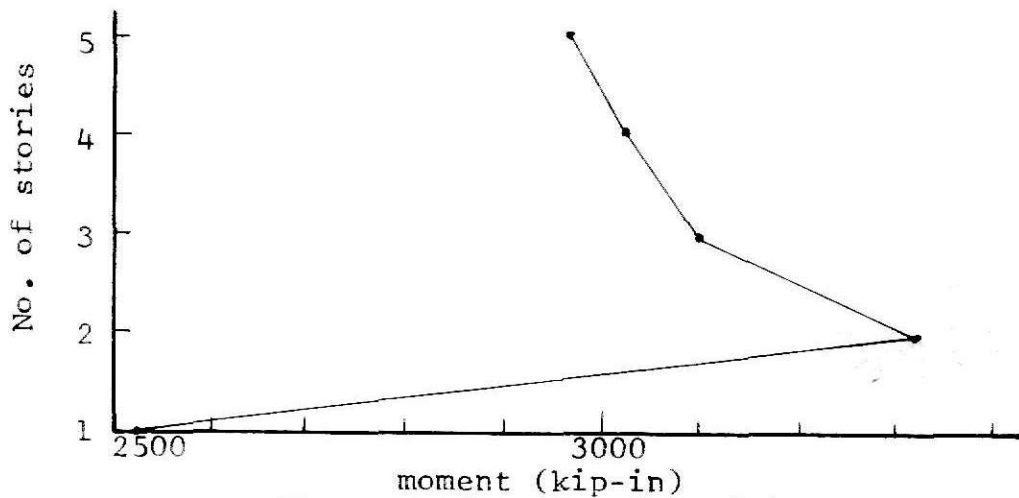

c. Moments of member 5 at joint 6

Fig. 7. Variation of moments in members 1, 4 and 5 for different stories in two-bay plane frame with one inch settlement at middle support

2. In the one- to five-story, two-bay plane frames with one inch settlement at the right external support, moments induced in member 2 at joint 5 and in member 3 at joint 6 are shown in Fig. 8, and in member 4 at joint 4 and in member 5 at joint 5 in Fig. 9.

Upon investigating these figures, it is seen that moments induced in a given column decreased significantly in going from one-story to two-story, then change slightly with an increasing number of stories. The moment induced in cross-beams increased significantly in going from one-story to two-story, then decreased with an increasing number of stories.

(B) Space Frames

Three cases of space frames were considered:

1. One- to five-story, one-bay space frames were subjected to one inch settlement at the right rear support. The induced moments in the members are shown in Table 6-1 to Table 6-5.
2. One- to five-story, two-bay space frames were subjected to one inch settlement at the:
 - a. external rear support, for which moments induced in the members are shown in Table 7-1 to Table 7-5.
 - b. middle rear support, for which moments induced in the members are shown in Table 8-1 to Table 8-5.

The variation of moments in the corresponding members at the same joint of the frames with with a number of different stories is shown as follows:

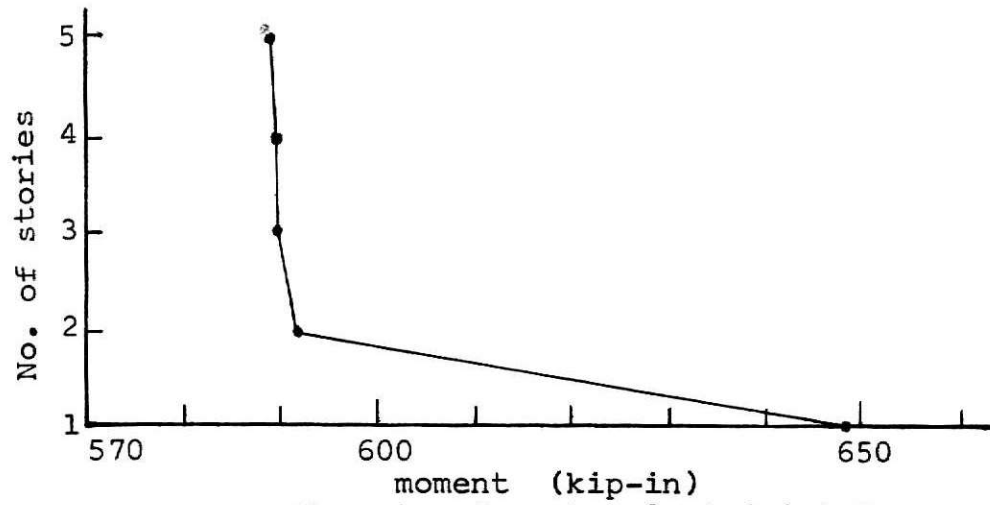

a. Moments of member 2 at joint 5

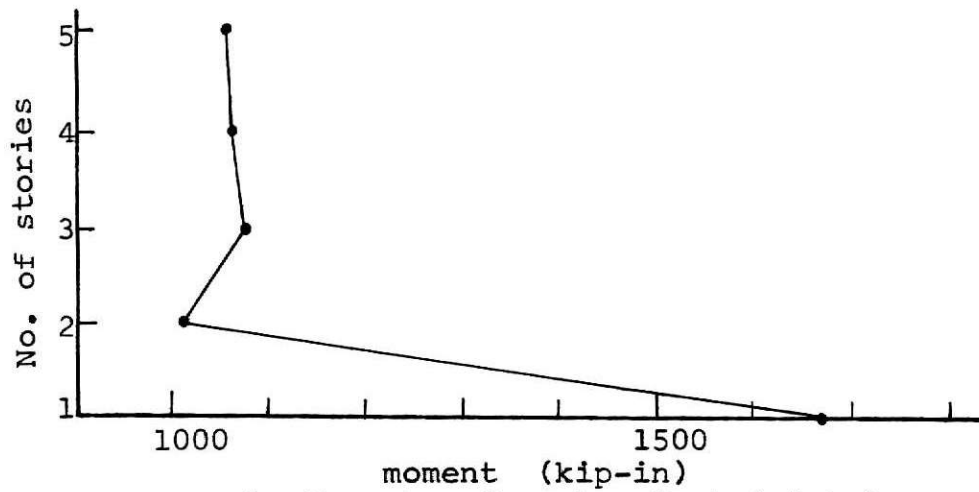

b. Moments of member 3 at joint 6

Fig. 8. Variation of moments in members 2, 3 for different stories in two-bay plane frame with one inch settlement at right external support

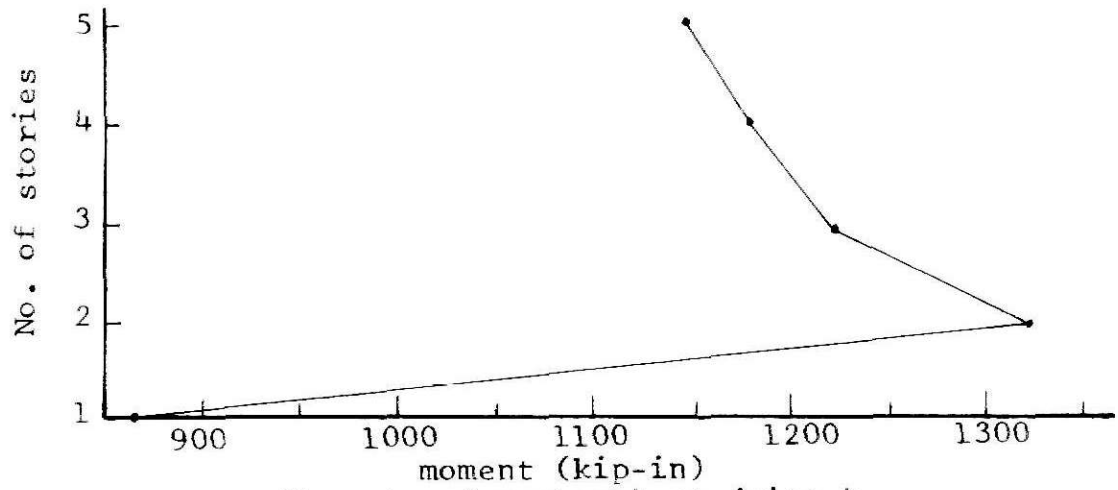

a. Moments of member 4 at joint 4

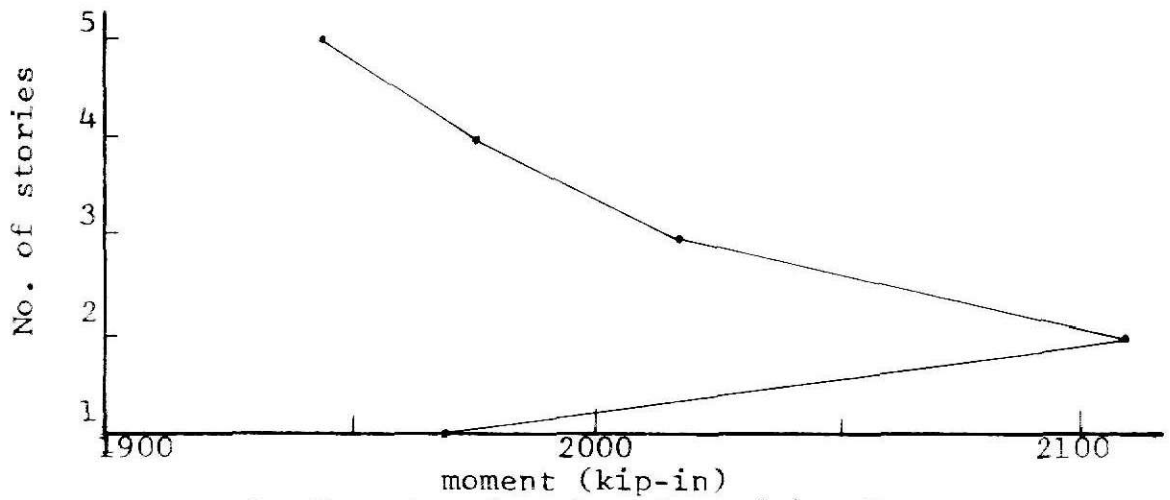

b. Moments of member 5 at joint 5

Fig. 9. Variation of moments in members 4 and 5 for different stories in two-bay plane frame with one inch settlement at right external support

1. In the one- to five-story, one-bay space frames with settlement at support 3, moments induced in member 1 at joint 5 are shown in Fig. 10, in member 2 at joint 7 in Fig. 11, in member 5 at joint 5 in Fig. 12, and in member 6 at joint 7 in Fig. 13.
2. In the one- to five-story, two-bay space frames with settlement at :
 - a. support 4, moments induced in member 1 at joint 7 are shown in Fig. 14, in member 2 at joint 8 in Fig. 15, in member 8 at joint 9 in Fig. 16, in member 9 at joint 9 in Fig. 17, and in member 13 at joint 13 in Fig. 18.
 - b. support 5, moments induced in member 1 at joint 7 are shown in Fig. 19, in member 2 at joint 8 in Fig. 20, in member 7 at joint 7 in Fig. 21, in member 9 at joint 10 in Fig. 22, and in member 13 at joint 8 in Fig. 23.

All of these diagrams of variation of moments include M_x , M_y and M_z in the members corresponding to x, y and z axes, respectively, in the global coordinate system. The asterik on the moment designations denotes the torsional moments.

On investigating the computed data both in one-bay and two-bay space frames, it can be seen that the moments induced in the members are significantly affected by the action of differential settlement..

A comparison of the data for the different frames is

difficult. Only the following comparisons seem evident:

The torsional moments induced in the members were much smaller than the primary bending moments in the same members.

In one-bay space frames, the torsional moments induced in the cross-beams of the lower story are decreased with an increasing number of stories, while those induced in the columns are increased with an increasing number of stories.

Of all the space frames tested the torsional moments induced were highest in the top story cross-beams in the two-story frame.

In the five-story, one-bay space frames the bending moments induced in the members in the upper story are larger than those in the lower story.

The effect of differential settlement on bending moments in the members in the two-bay space frames, which settled at the middle support, is generally greater than those which settled at an external support.

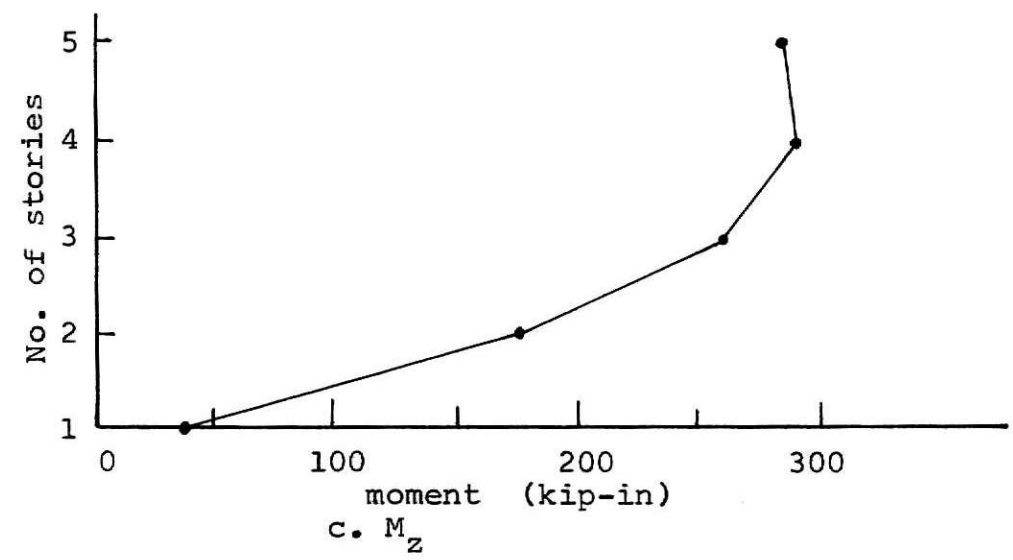
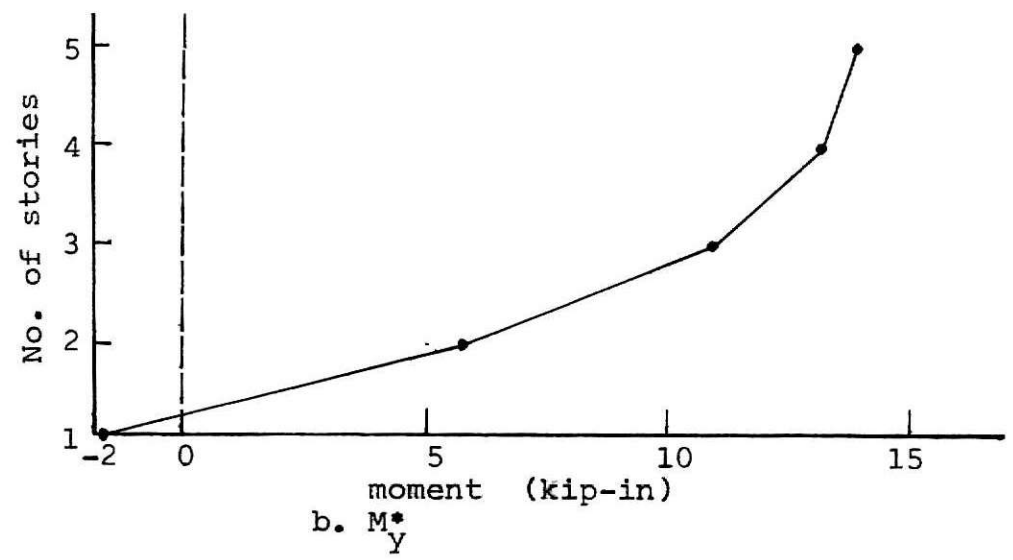
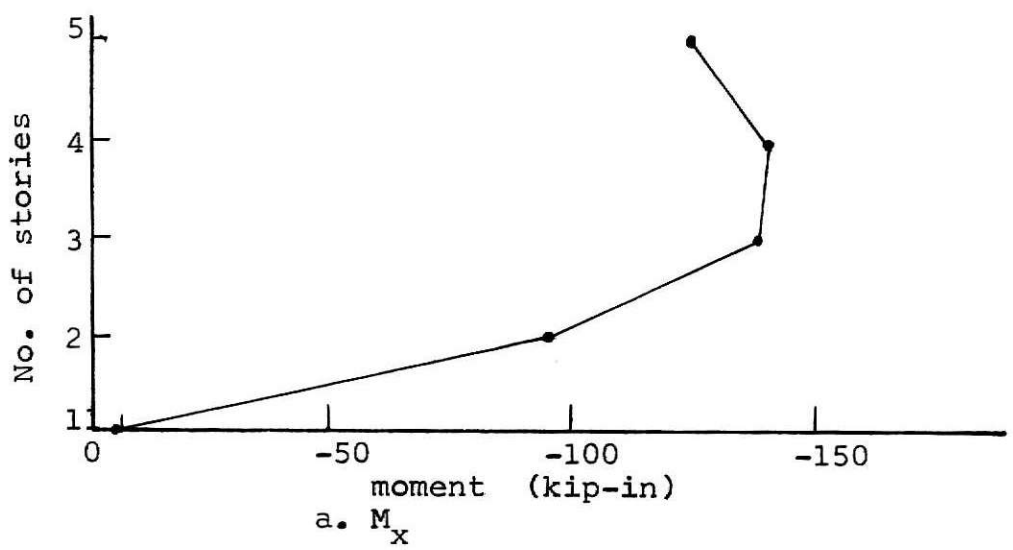

Fig. 10. Variation of moments in member 1 at joint 5 for different stories in one-bay space frames with one inch settlement at right rear support

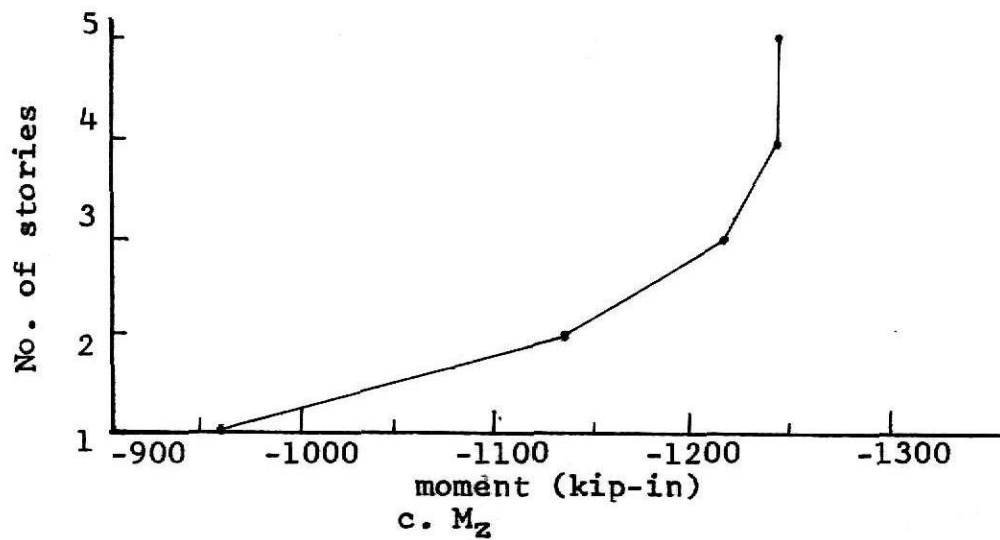
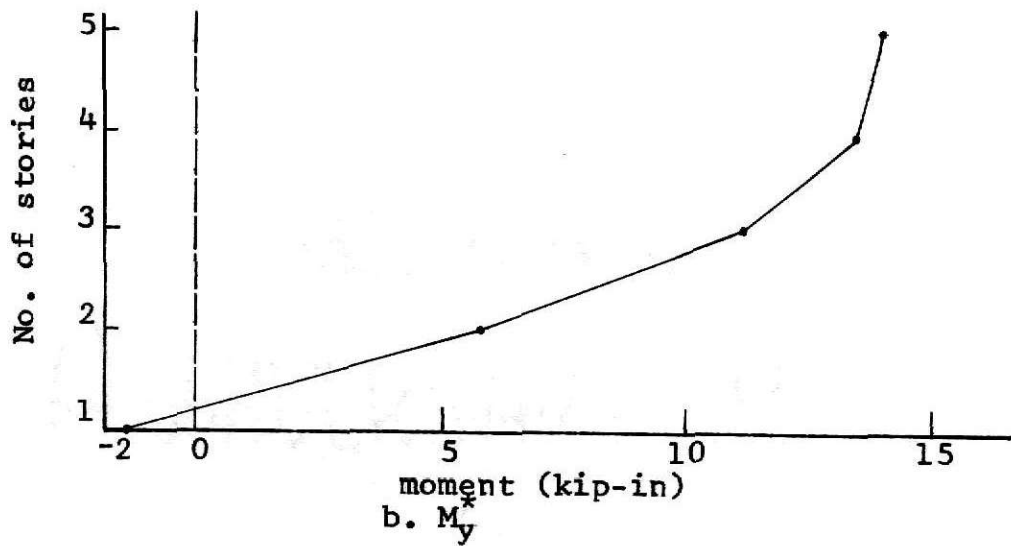
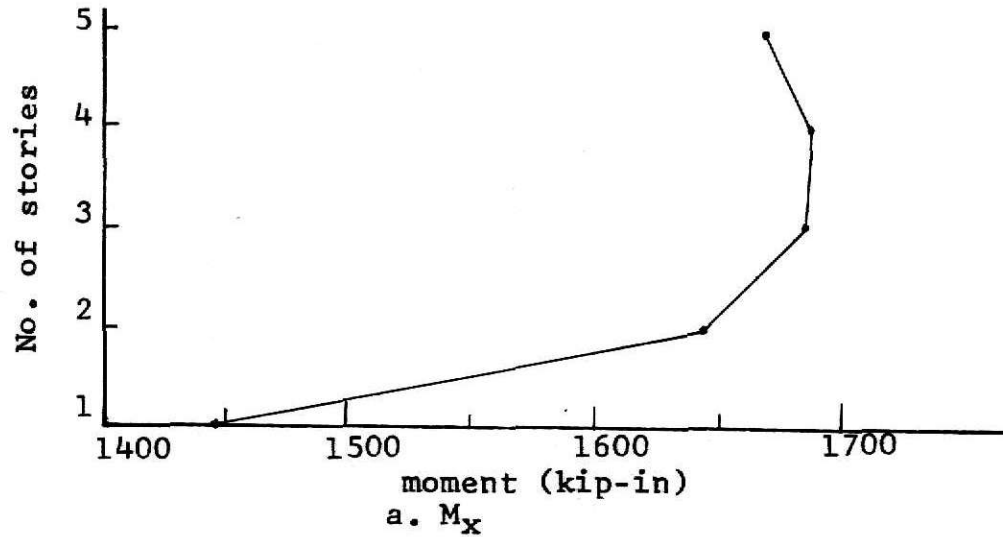

Fig. 11. Variation of moments in member 3 at joint 7 for different stories in one-bay space frame with one inch settlement at right rear support

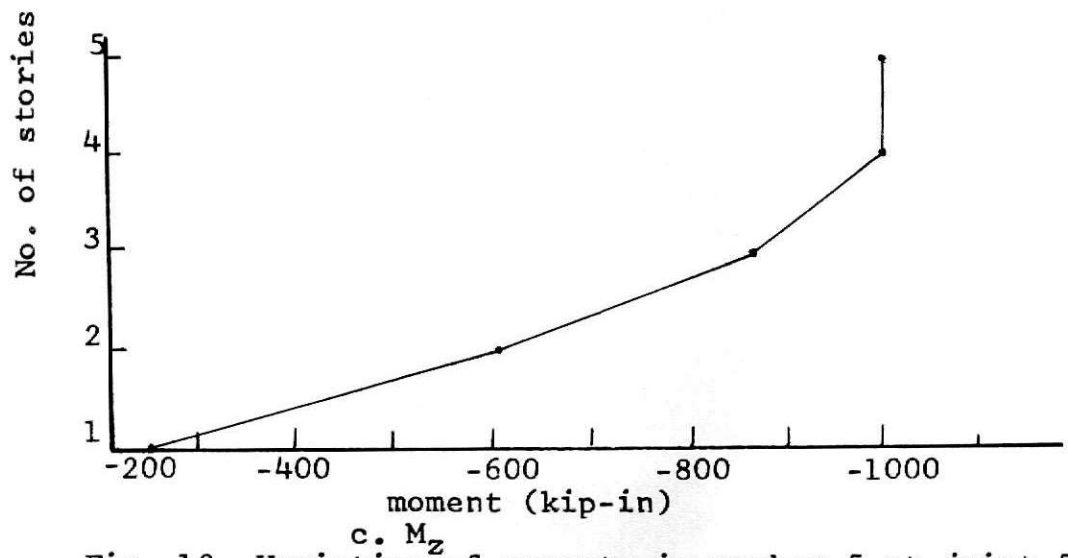
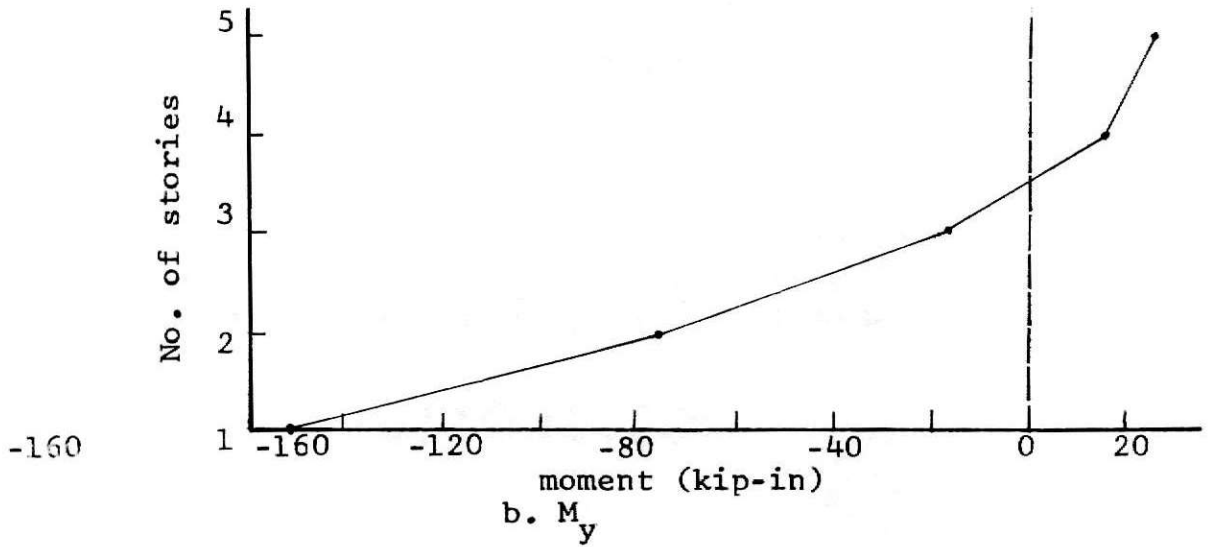
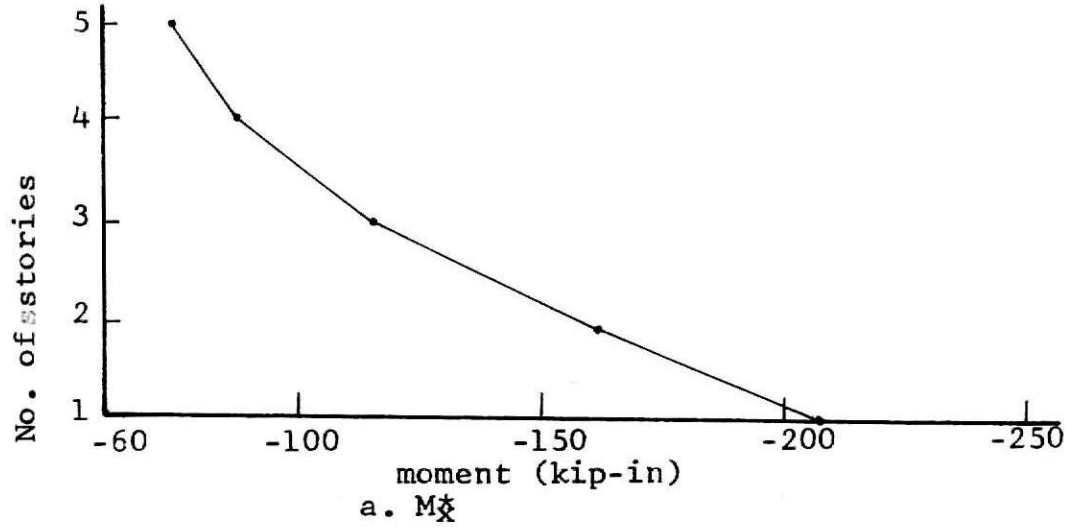

Fig. 12. Variation of moments in member 5 at joint 5 for different stories in one-bay space frames with one inch settlement at right rear support

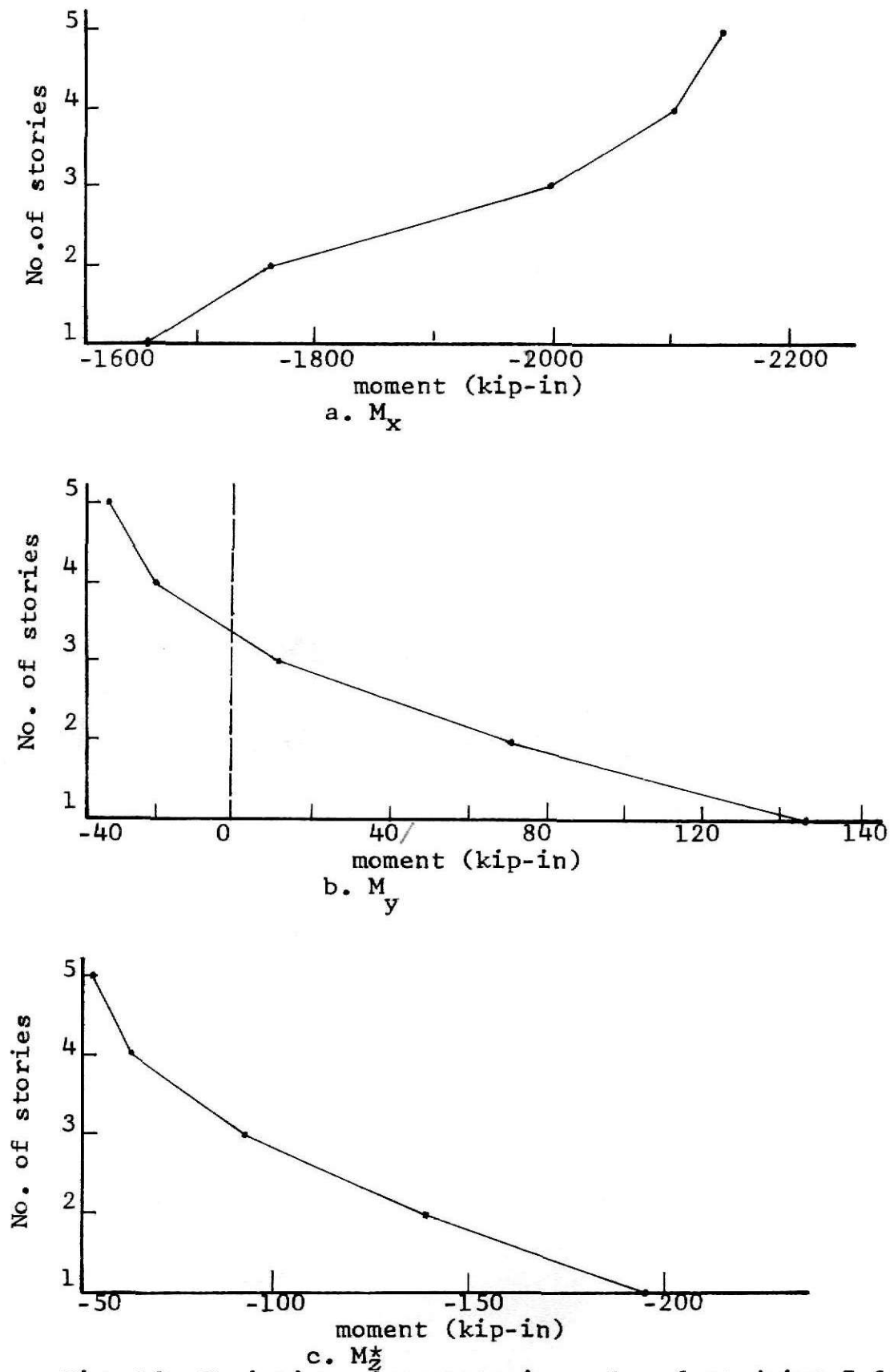

Fig. 13. Variation of moments in member 6 at joint 7 for different stories in one-bay space frames with one inch settlement at right rear support

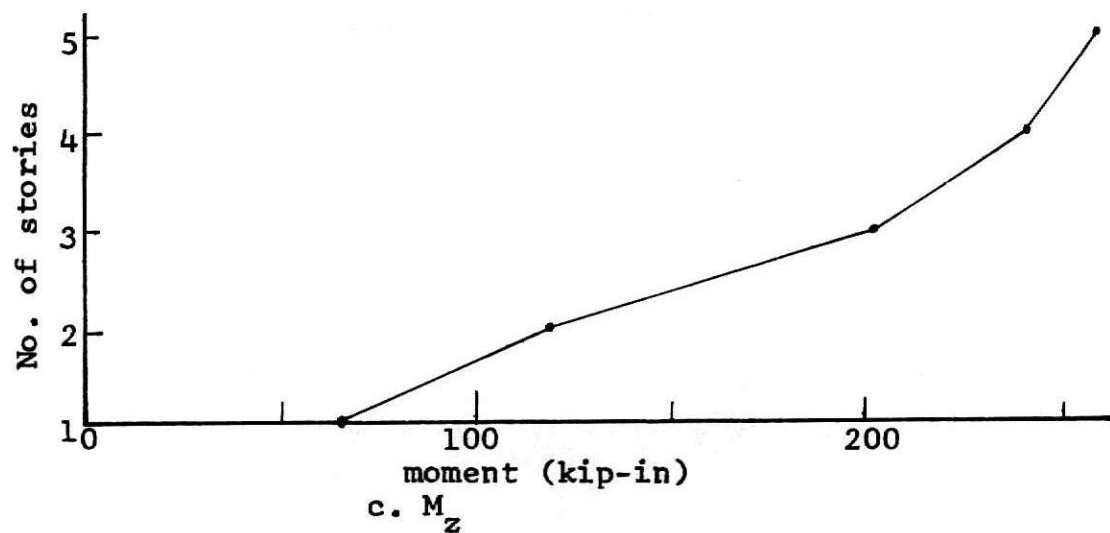
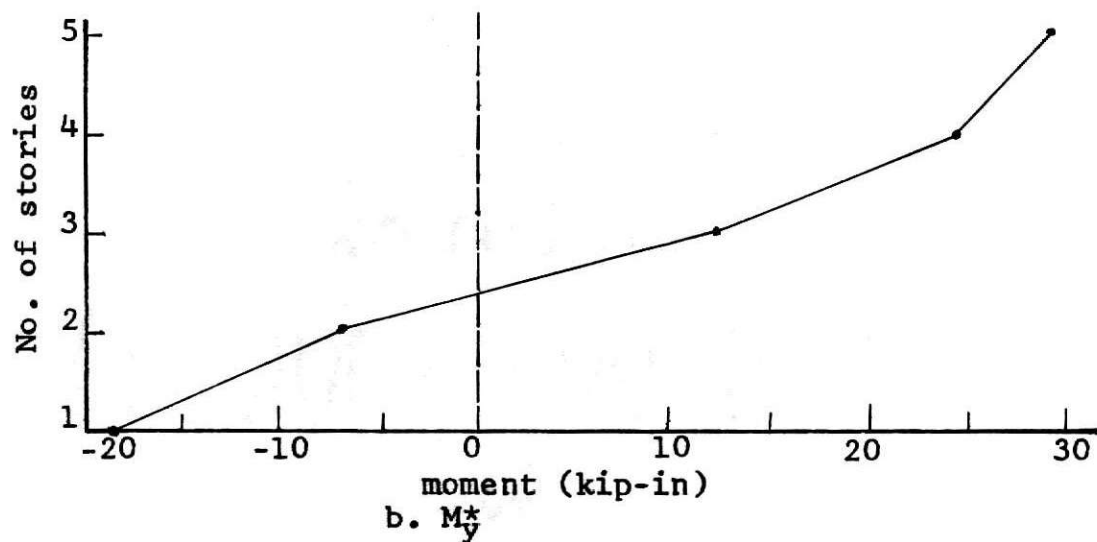
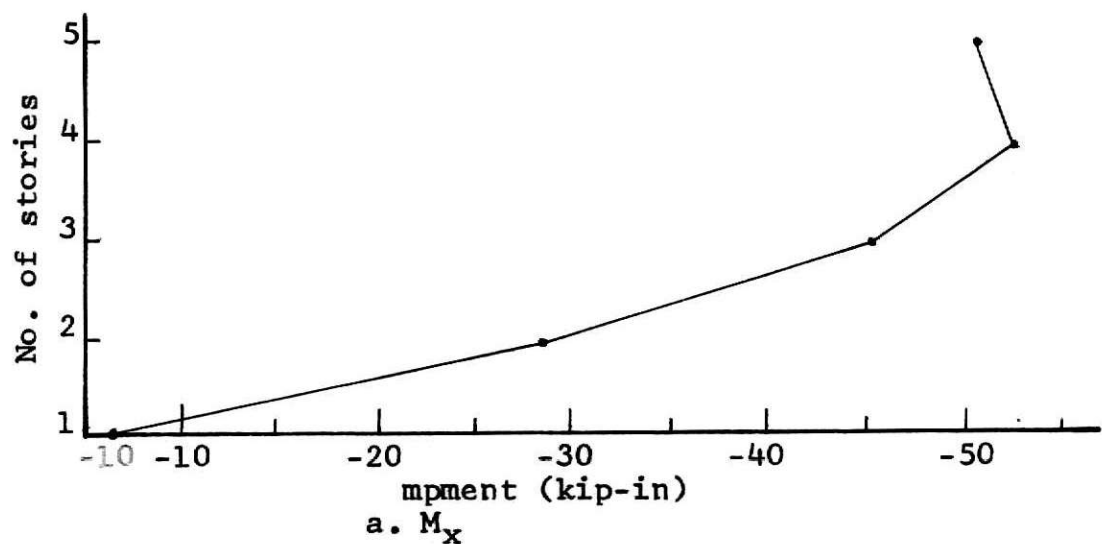

Fig. 14. Variation of moments in member 1 at joint 7 for different stories in two-bay space frames with one inch settlement at right rear external support

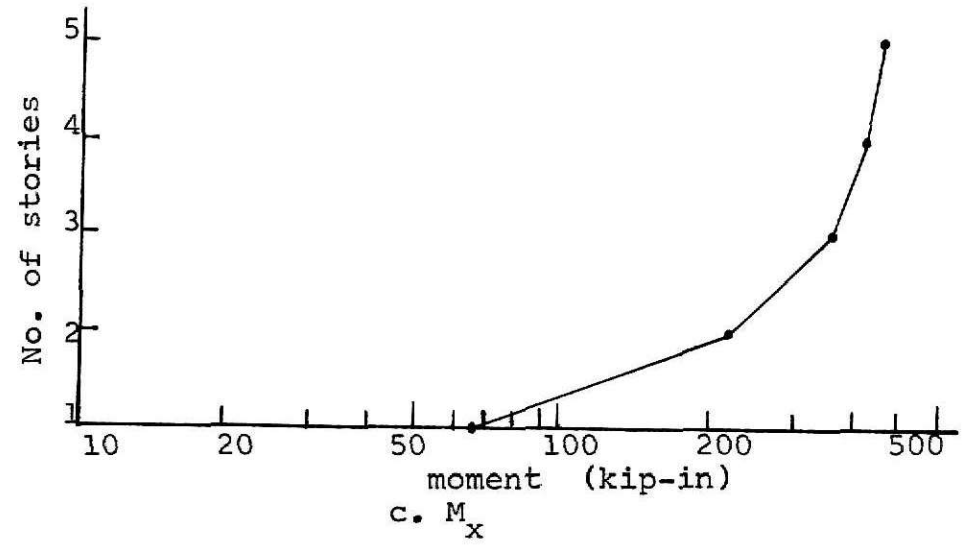
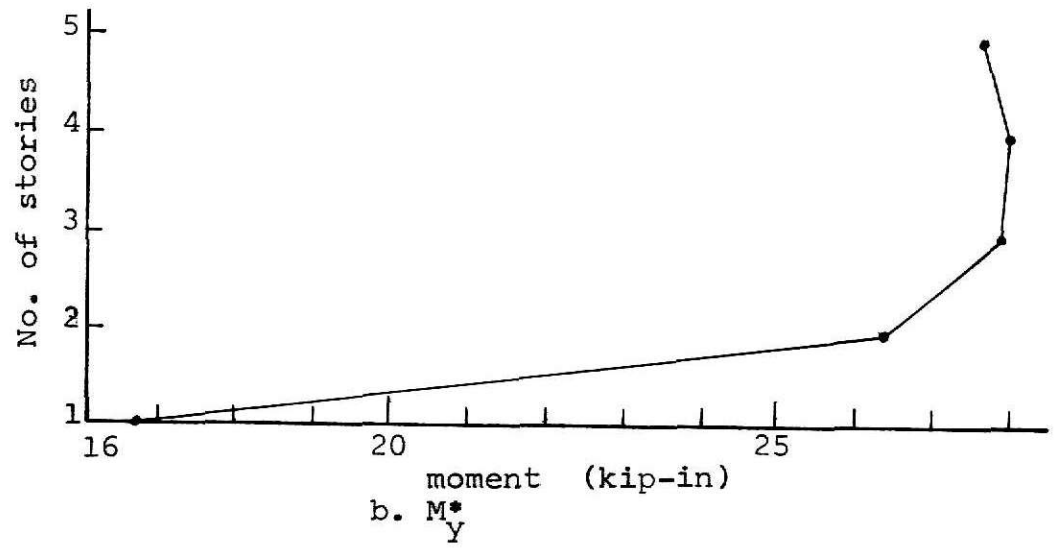
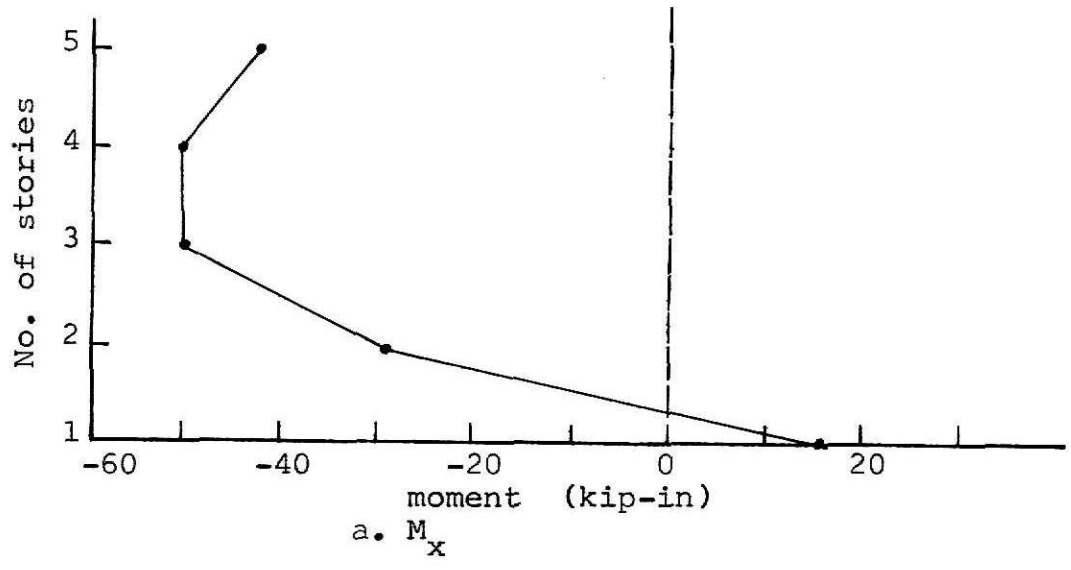

Fig. 15. Variation of moments in member 2 at joint 8 for different stories in two-bay space frames with one inch settlement at right rear external support

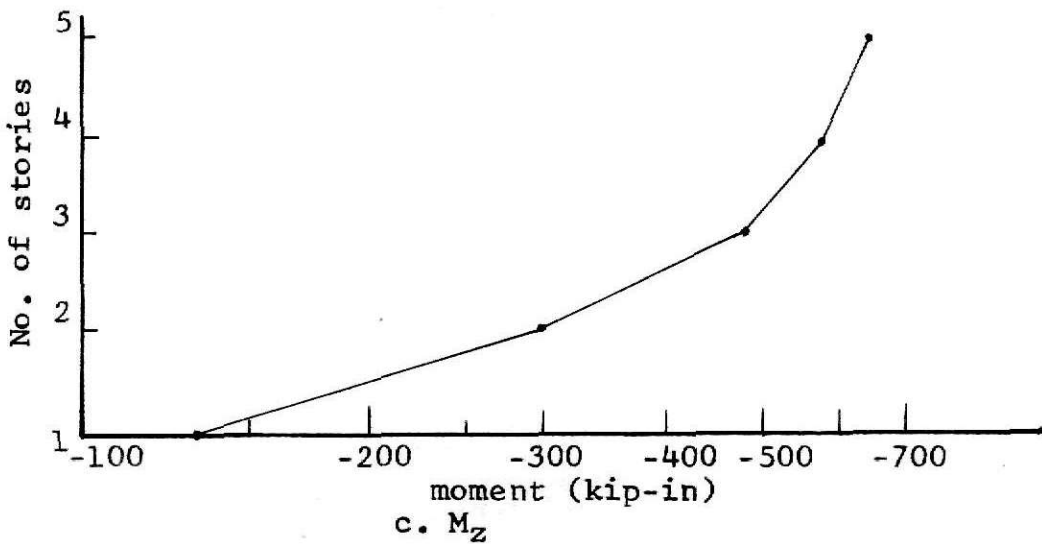
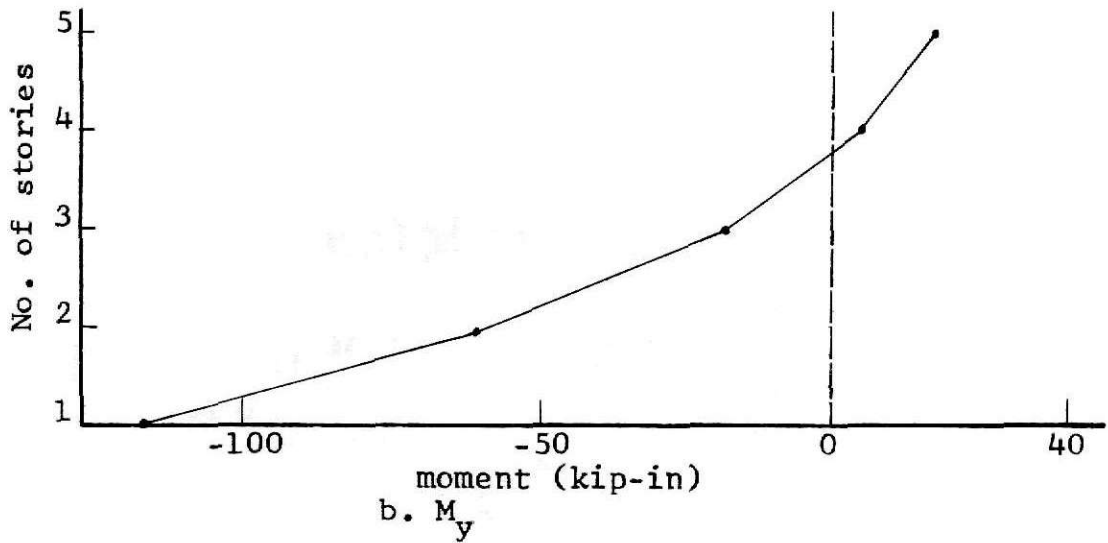
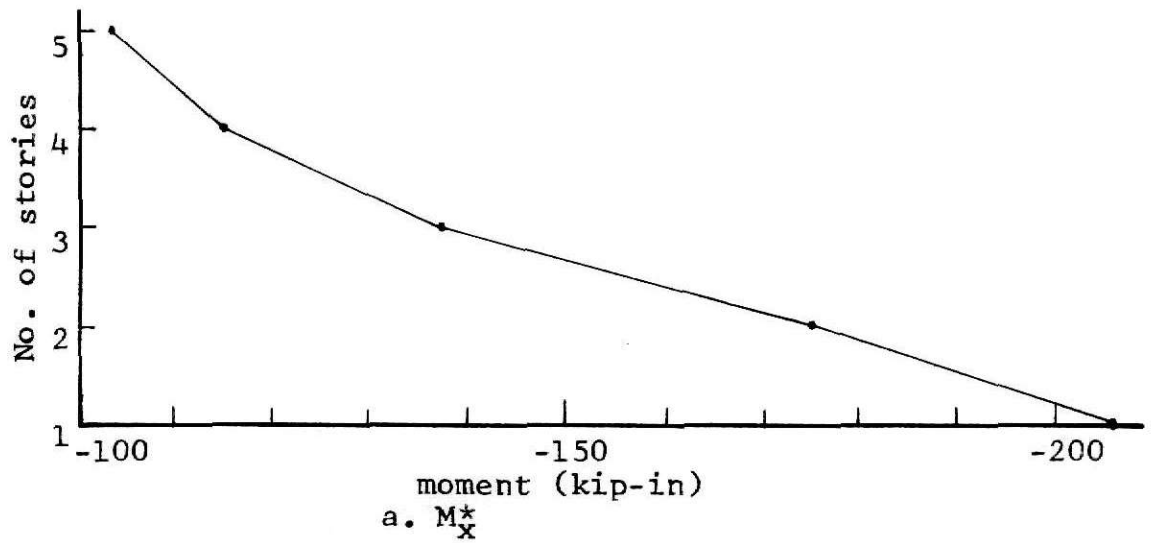
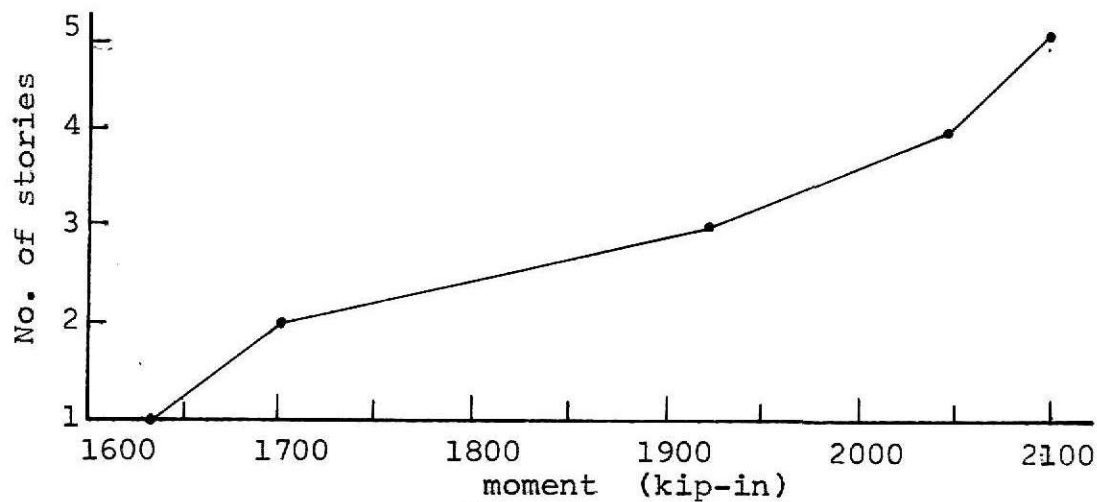
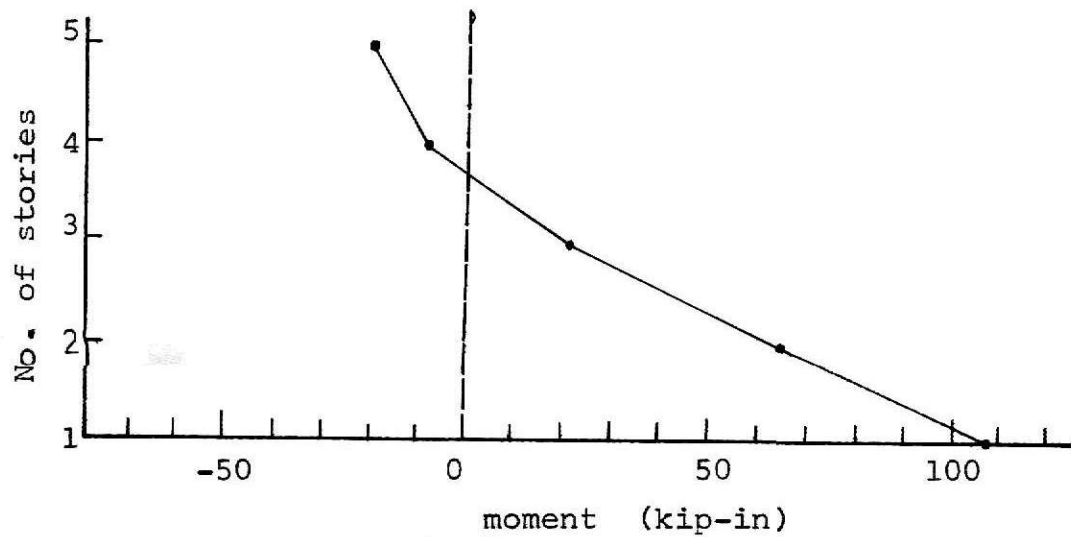

Fig. 16. Variation of moments in member 8 at joint 9 for different stories in two-bay space frames with one inch settlement at right rear external support



a. M_x



b. M_y

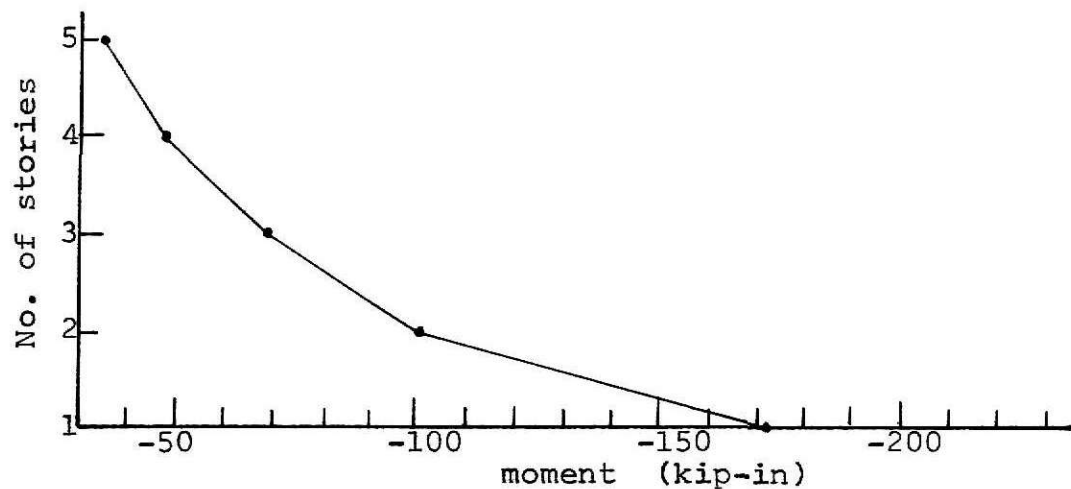

c. M_z^*

Fig. 17. Variation of moments in member 9 at joint 9 for different stories in two-bay space frames with one inch settlement at right rear external support

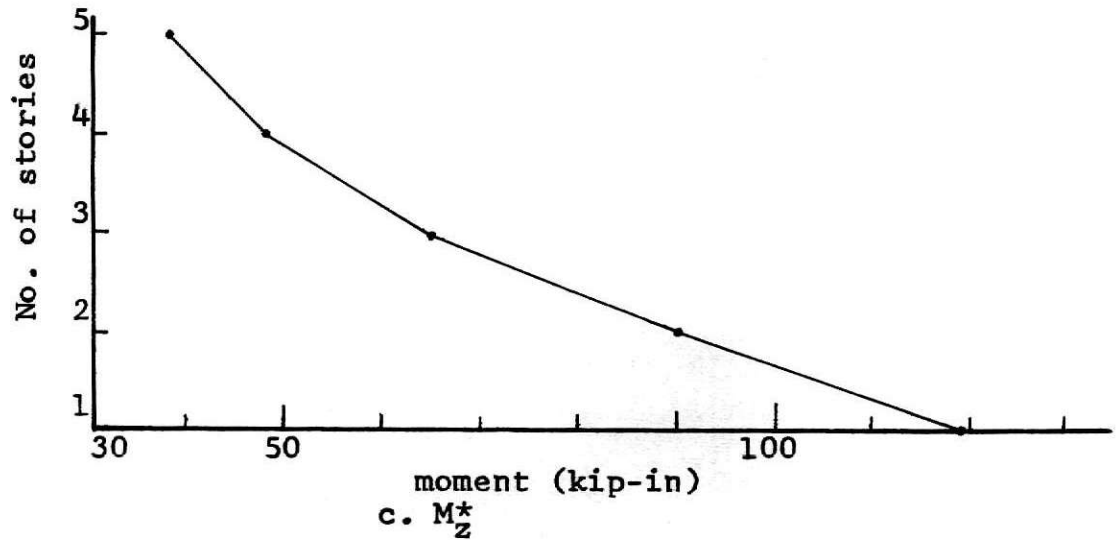
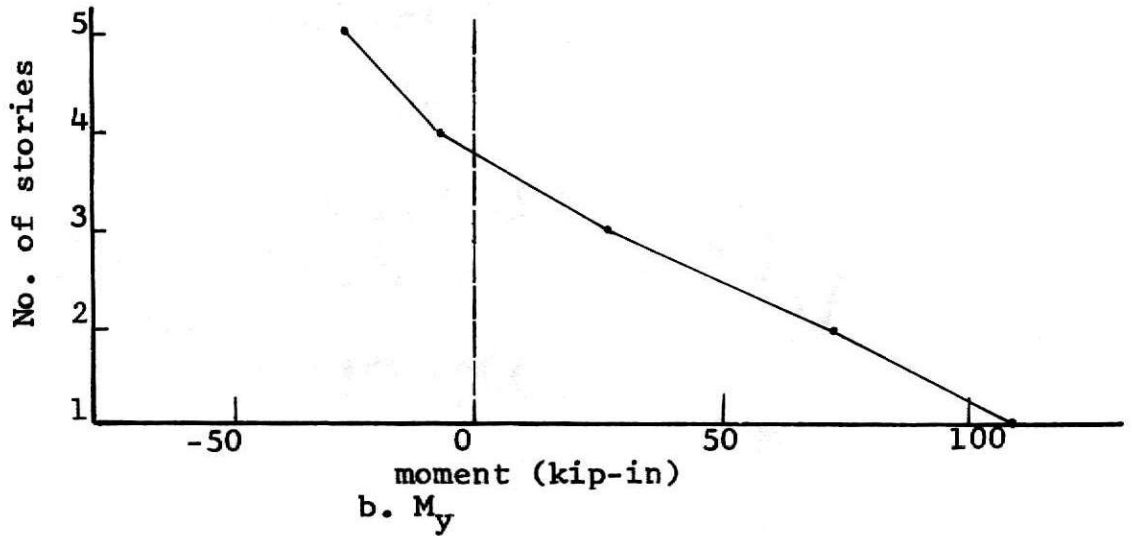
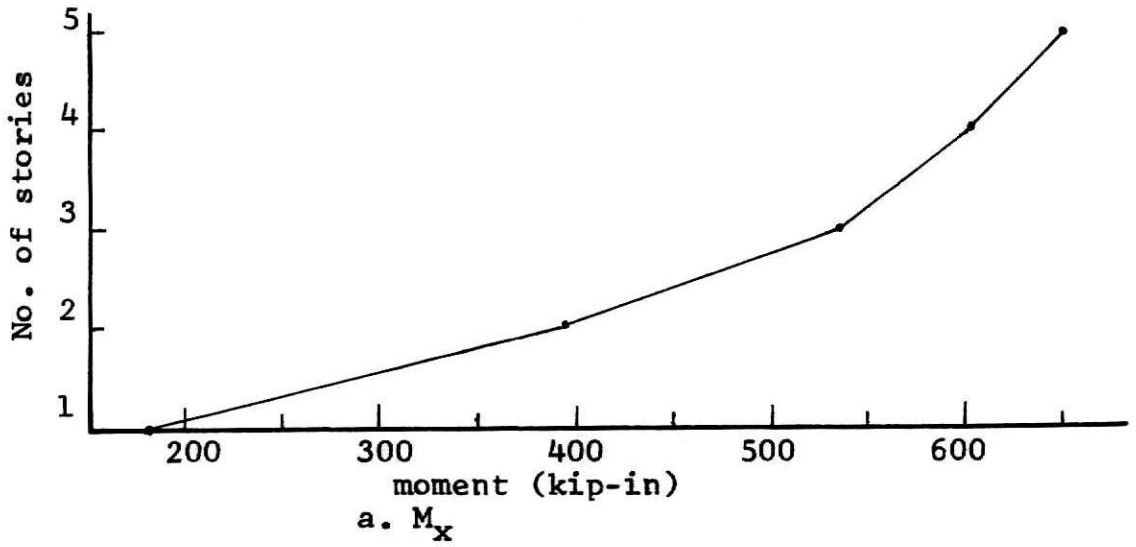

18
Fig. 18. Variation of moments in member 13 at joint 13 for different stories in two-bay space frames with one inch settlement at right rear external support

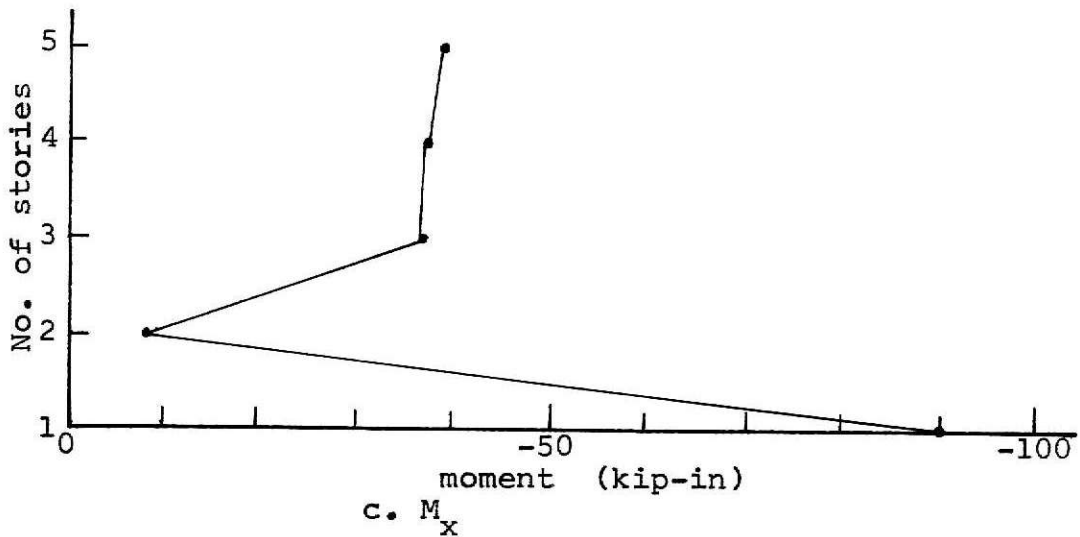
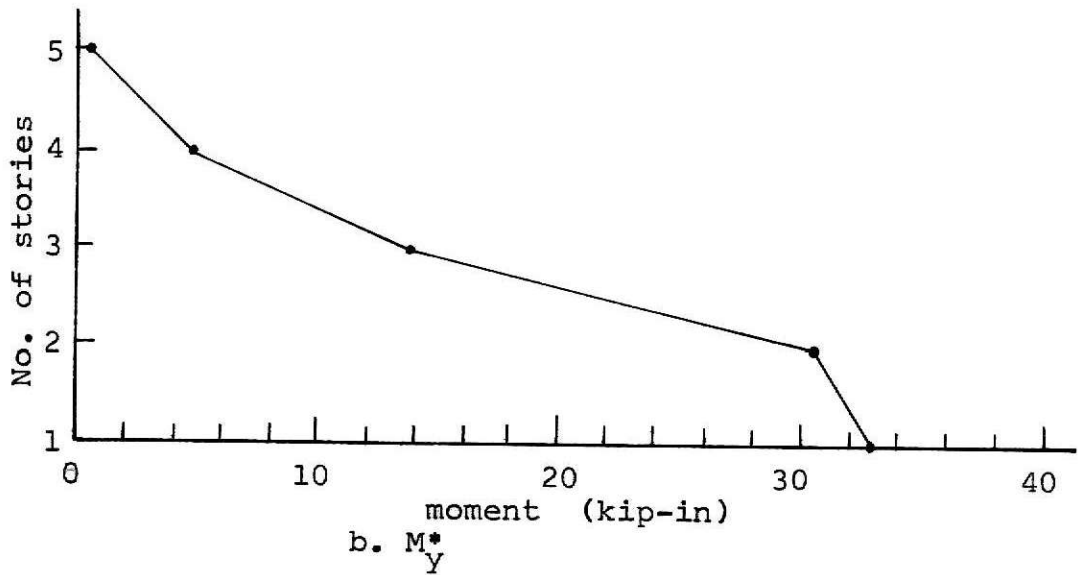
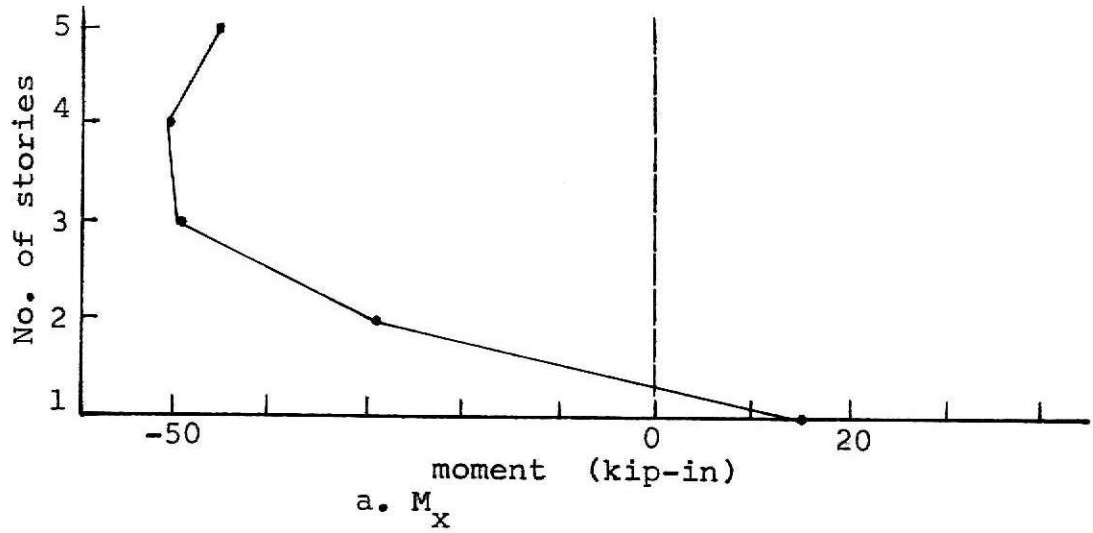

Fig. 19. Variation of moments in member 1 at joint 7 for different stories in two-bay space frames with one inch settlement at middle rear support

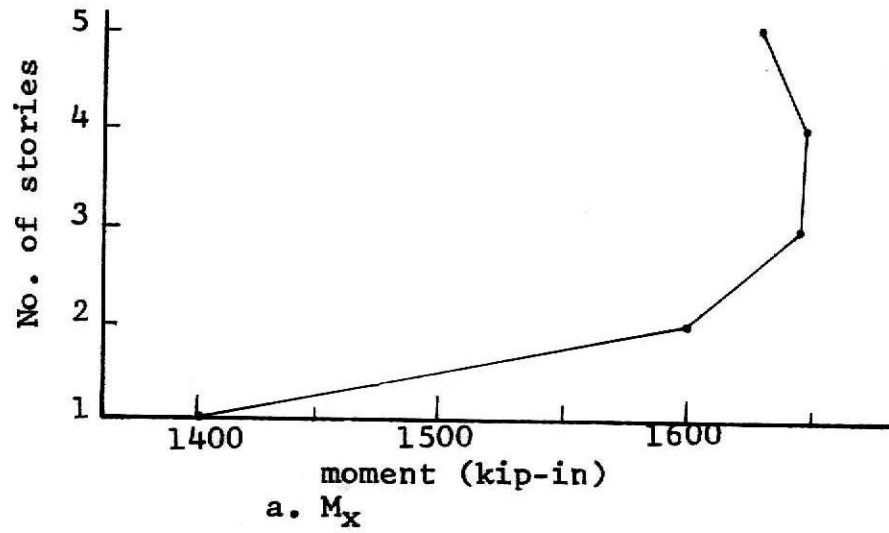

Fig. 20. Variation of moments in member 2 at joint 8 for different stories in two-bay space frames with one inch settlement at middle rear support

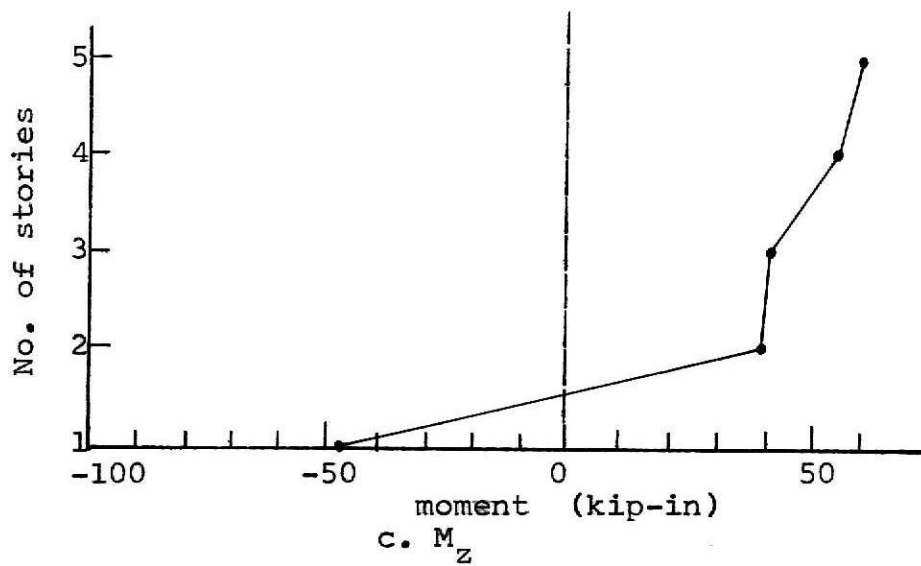
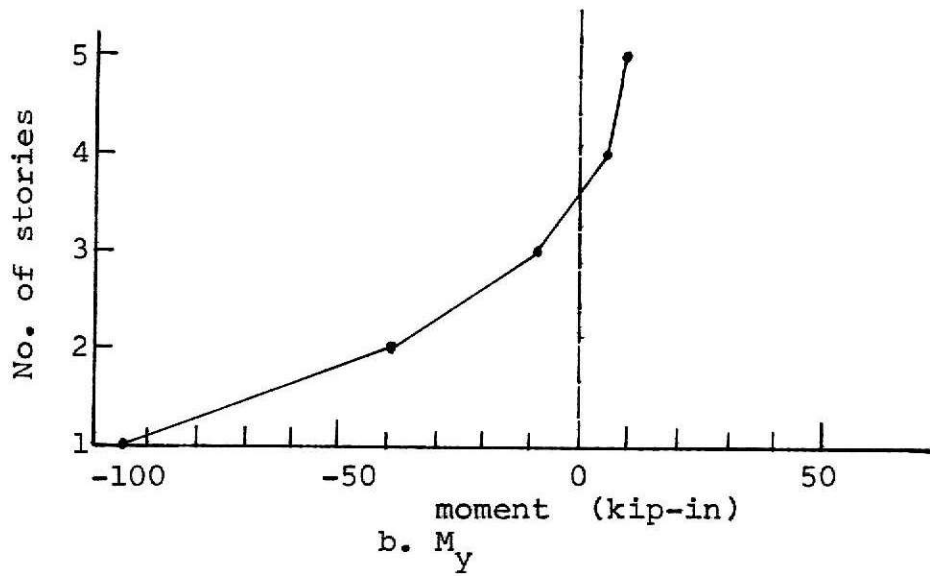
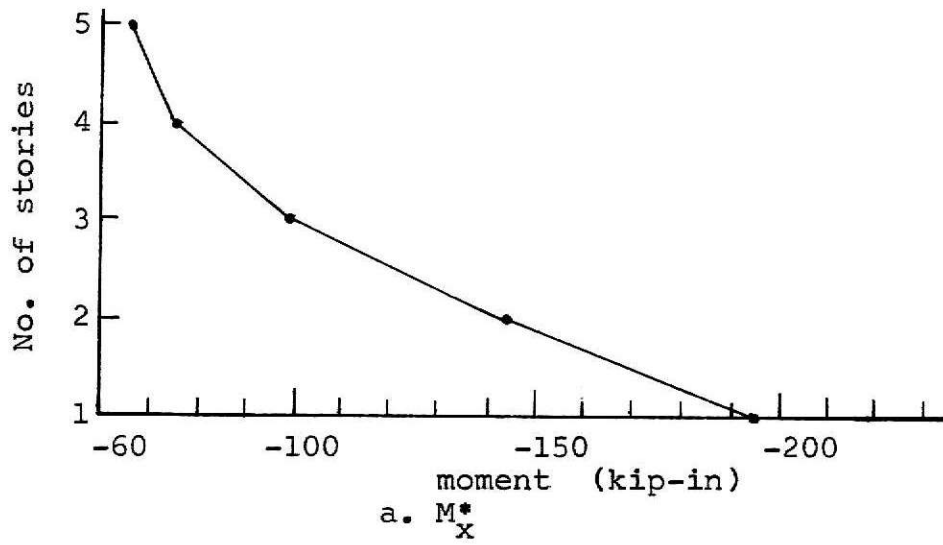

Fig. 21. Variation of moments in member 7 at joint 7 for different stories in two-bay space frames with one inch settlement at middle rear support

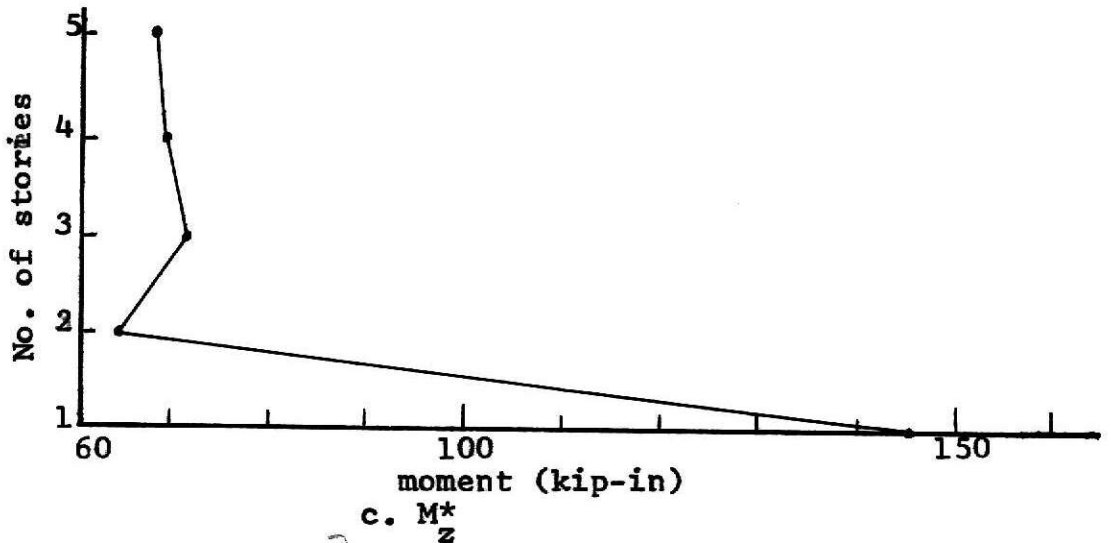
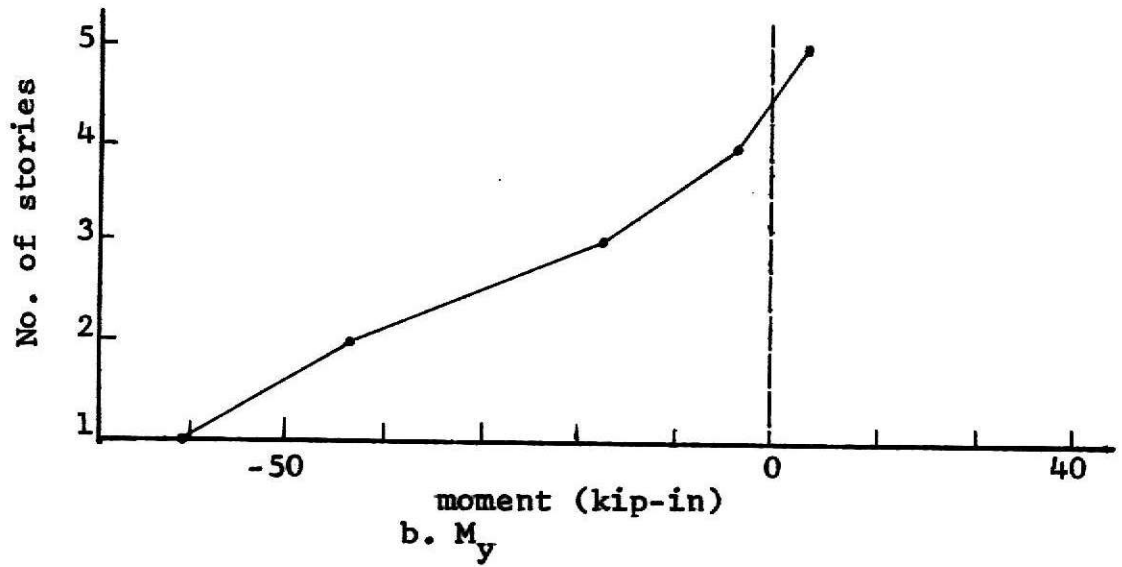
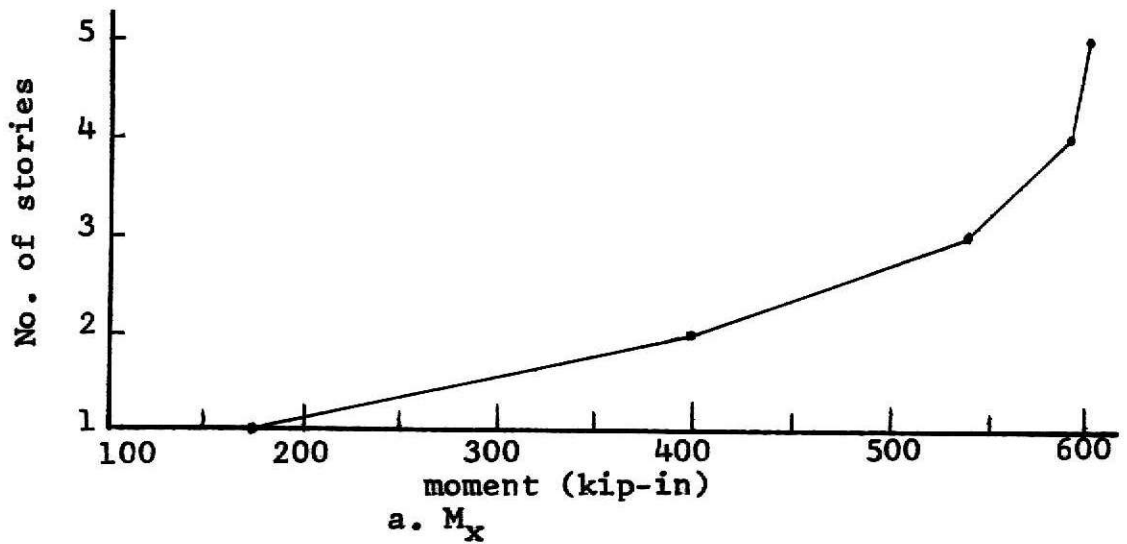
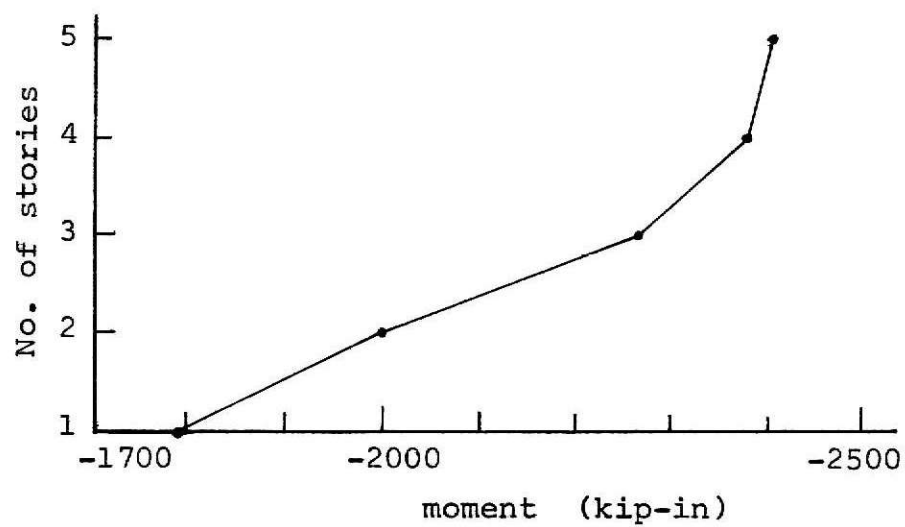

Fig. 22. Variation of moments in member 9 at joint 10 for different stories in two-bay space frames with one inch settlement at middle rear support



a. M_x

b. $M_y = 0$

c. $M_z^* = 0$

Fig. 23. Variation of moments in member 13 at joint 8 for different stories in two-bay space frame with one inch settlement at middle rear support

CONCLUSIONS

A prediction of settlement and allowable bearing capacity is necessary for foundation design. The rigidity of the superstructure results in lower differential settlement and transfers loads and pressures from points of maximum effect to points of minimum effect. A better design may result if stresses caused by possible settlement are taken into account as a loading condition.

In examination of the frames subjected to differential settlement considered in this report the following effects appear:

1. Moments induced in the members both of plane and space frames due to differential settlement are significant.
2. Moments induced in the members both of plane and space frames caused by settlement at an inner support are larger than those caused by settlement at an external support.
3. In one-bay plane frames, the moments induced both in cross-beams and columns are damped out quickly with an increasing number of stories. Differential settlement has a greater effect on the lower members of a one-bay plane frame than on the upper members. The effect on the lower members depends primarily on the amount of settlement rather than on the number of stories.
4. Two-bay plane frames subjected to distributed settlement suffer less distress than those subjected to settlement under one column only.
5. Moments induced in the upper stories of the two-bay plane

frames are much larger than those in corresponding locations in the one-bay plane frames.

6. In one-bay space frames, the torsional moments induced in columns are affected by an increasing number of stories, but those in the cross-beams are not.

7. The torsional moments induced in the cross-beams of the top story of two-story space frames, both with one and two bays, are critical when compared with other frames.

ACKNOWLEDGEMENTS

The writer wishes to express his greatest appreciation to his major advisor Professor Wayne W. Williams, to Dr. Stuart E. Swartz, to Dr. Robert R. Snell and to Dr. Lee R. Calcote for their suggestions and directions during the preparation of this report.

He would like to thank Dr. Jack B. Blackburn, Head of Civil Engineering Department, for his encouragement and offer of financial aid for use of the computer.

REFERENCES

1. M.I.T., STRU DL - A Simplified User's Manual, Massachusetts Institute of Technology, Massachusetts, 1968.
2. Terzaghi, K. and Peck, R.B., Soil Mechanics in Engineering Practice, John Wiley & Sons, Inc., New York, 1962, Ch. IX.
3. Timoshenko, S.P. and Goodier, J.N., Theory of Elasticity, McGraw-Hill Co., New York, 1951.
4. Terzaghi, K., Theoretical Soil Mechanics, John Wiley & Sons, Inc., 1965, Ch. XIII.
5. Chamecki, M., "Structural Rigidity in Calculating Settlements," Journal, ASCE, Soil Mechanics and Foundation Division, Vol. 82, No. SML, January 1956, pp. 1-19.
6. Getzler, Z., "The Virtual Differential Settlement Method," Proceedings, Boston Society of Civil Engineers, Vol. 53, April 1966, pp. 199-218.
7. Pieper, Klaus and Martens, Peter, "Der Einfluss von Stützen-Senkungen auf Stahlbeton-Hochbauten," Die Bautechnik, December 1966, pp. 415-418.
8. Morns, David, "Interaction of Continuous Frames and Soil Media," Journal, ASCE, Structural Division, Vol. 92, No. ST 5, October 1966, pp. 13-44.
9. Taylor, D.W., Fundamental of Soil Mechanics, John Wiley & Sons, Inc., New York, 1948.
10. Sommer, H., "A Method for the Calculation of Settlement, Contact Pressures and Bending Moments in a Foundation Including the Influence of Flexural Rigidity of the

- Superstructure," Proceedings, 6th Intern. Conf. on Soil Mech. and Foundation Engrg., Montreal, Canada, 1965, pp. 197-201.
11. Heil, H., "Studies on the Structural Rigidity of Reinforced Concrete Building Frames on Clay," Proceedings, 7th Intern. Conf. on Soil Mech. and Foundation Engrg., Mexico, Vol. 2, 1969, pp. 115-121.
 12. Mayerhof, G.E., "The Settlement Analysis of Building Frames," Structural Engineer, Vol. 25, 1947, pp. 369-409.
 13. Reickert, F.A., "The Effect of Settlement on Buildings," M.S. Thesis, Yale University, 1940.
 14. Polshin, D.E. and Tokar, R.A., "Maximum Allowable Non-uniform Settlement of Structures," Proceedings, 4th Intern. Conf. on Soil Mech. and Foundation Engrg., London, Vol. 1, 1957, pp. 402-405.

APPENDIX

Table 2.	Properties of members	43
Table 3.	Moments of one- to five-story one-bay plane frames with one inch settlement at right support	45
Table 4.	Moments of one- to five-story two-bay plane frames with one inch settlement at middle support	47
Table 5.	Moments of one- to five-story two-bay plane frames with one inch settlement at right external support	48
Table 6-1.	Moments of one-story one-bay space frame with one inch settlement at right rear support	50
Table 6-2.	Moments of two-story one-bay space frame with one inch settlement at right rear support	51
Table 6-3.	Moments of three-story one-bay space frame with one inch settlement at right rear support	52
Table 6-4.	Moments of four-story one-bay space frame with one inch settlement at right rear support	53
Table 6-5.	Moments of five-story one-bay space frame with one inch settlement at right rear support	54
Table 7-1.	Moments of one-story two-bay space frame with one inch settlement at right rear external support	57
Table 7-2.	Moments of two-story two-bay space frame with one inch settlement at right rear external support	58
Table 7-3.	Moments of three-story two-bay space frame with one inch settlement at right rear external support	59
Table 7-4.	Moments of four-story two-bay space frame with one inch settlement at right rear external support	60

Table 7-5. Moments of five-story two-bay space frame with one inch settlement at right rear external support	63
Table 8-1. Moments of one-story two-bay space frame with one inch settlement at middle rear support	66
Table 8-2. Moments of two-story two-bay space frame with one inch settlement at middle rear support	67
Table 8-3. Moments of three-story two-bay space frame with one inch settlement at middle rear support	68
Table 8-4. Moments of four-story two-bay space frame with one inch settlement at middle rear support	70
Table 8-5. Moments of five-story two-bay space frame with one inch settlement at middle rear support	72
Fig. 24. Five-story one-bay plane frame	44
Fig. 25. Five-story two-bay plane frame	46
Fig. 26. Five-story one-bay space frame	49
Fig. 27. Five-story two-bay space frame	56

Table 2. Properties of members

	Story	1st.	2nd.	3rd.	4th.	5th.
Column	Column size in inches	14x16	12x16	12x16	12x16	12x16
	Vertical bar	4-#8	4-#8	4-#7	4-#8	4-#7
	Tie	11-#2	8-#2	8-#2	8-#2	8-#2
	Moment of inertia in in ⁴	6413	5683	5317	5683	5317
Beam	Beam size in inches	8x18 $\frac{1}{4}$	8x23 $\frac{1}{4}$	8x23 $\frac{1}{4}$	8x23 $\frac{1}{4}$	8x23 $\frac{1}{4}$
	Top bar	1-#5				
	Bottom bar	2-#5	1-#5	1-#5	1-#5	1-#5
	Bent bar		1-#6	1-#6	1-#6	1-#6
	Moment of inertia in in ⁴	4753	9645	9645	9645	9645

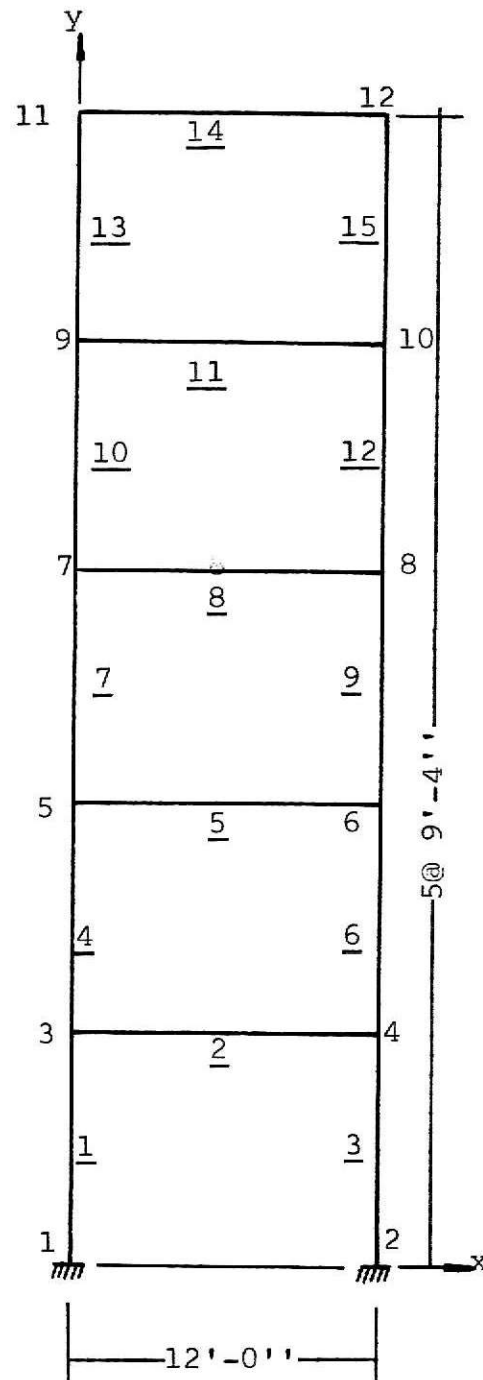

Fig. 24. Five-story one-bay plane frame

ILLEGIBLE DOCUMENT

**THE FOLLOWING
DOCUMENT(S) IS OF
POOR LEGIBILITY IN
THE ORIGINAL**

**THIS IS THE BEST
COPY AVAILABLE**

TABLE 3. MOMENTS OF ONE- TO FIVE-STORY TWO-BAY PLANE FRAMES
WITH ONE INCH SETTLEMENT AT RIGHT SUPPORT

MEM- REF	NODE	STORY				
		1	2	3	4	5
1	1	921.98	961.65	962.02	962.02	962.02
	3	-921.92	-961.65	-962.02	-962.02	-962.02
2	3	921.98	784.12	782.86	782.85	782.85
	4	921.98	784.12	782.86	782.85	782.85
3	4	-921.98	-961.65	-962.02	-962.02	-962.02
	2	921.98	961.65	962.02	962.02	962.02
4	3		177.54	179.15	179.17	179.17
	5		-177.54	-179.15	-179.17	-179.17
5	5		177.54	162.10	161.95	161.95
	6		177.54	162.10	161.95	161.95
6	6		-177.54	-179.15	-179.17	-179.17
	4		177.54	179.15	179.17	179.17
7	5			17.05	17.22	17.22
	7			-17.05	-17.22	-17.22
8	7			17.05	15.49	15.47
	8			17.05	15.49	15.47
9	8			-17.05	-17.22	-17.22
	6			17.05	17.22	17.22
10	7				1.73	1.74
	9				-1.73	-1.74
11	9				1.73	1.58
	10				1.73	1.58
12	10				-1.73	-1.74
	8				1.73	1.74
13	9					0.17
	11					-0.17
14	11					0.17
	12					0.17
15	12					-0.17
	10					0.17

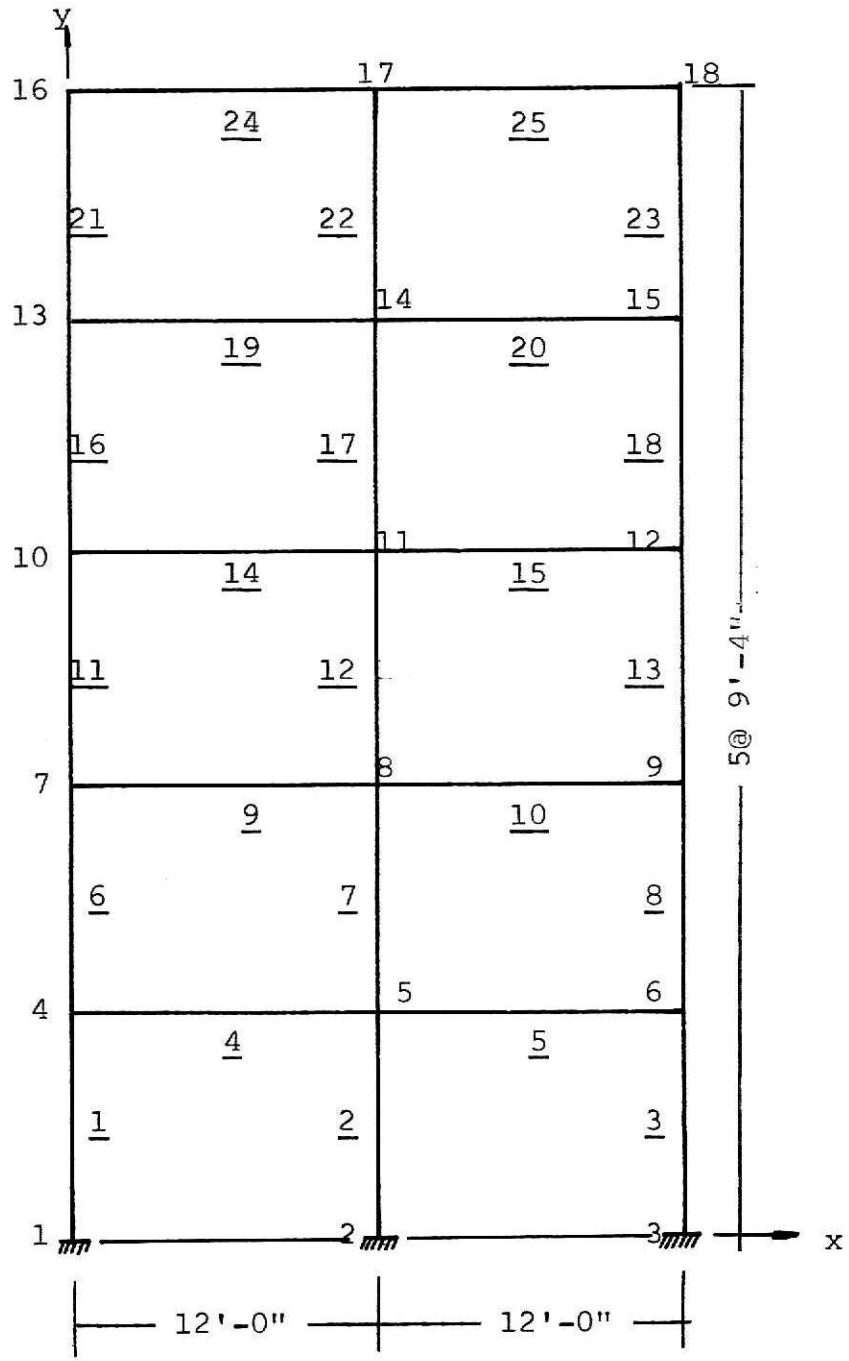

Fig. 25. Five-story two-bay plane frame

TABLE 4. MOMENTS OF ONE- TO FIVE-STORY TWO-BAY PLANE FRAMES
WITH ONE INCH SETTLEMENT AT MIDDLE SUPPORT

MEM- BER	NODE	STORY				
		1	2	3	4	5
1	1	-1215.29	-613.83	-650.55	-633.50	-625.81
	4	-2531.92	-1125.40	-1243.27	-1209.20	-1197.11
2	2	0.00	0.00	0.00	0.00	0.00
	5	0.00	0.00	0.00	0.00	0.00
3	3	1215.29	613.83	650.55	633.50	625.81
	6	2531.92	1125.40	1243.27	1209.20	1197.11
4	4	2531.92	3329.15	3107.14	3030.53	2968.12
	5	3290.62	3623.93	3448.69	3362.27	3297.32
5	5	-3290.62	-3623.93	-3448.69	-3362.27	-3297.32
	6	-2531.92	-3329.15	-3107.14	-3030.53	-2968.12
6	4		-2203.74	-1863.87	-1821.33	-1771.00
	7		-3317.00	-2618.62	-2158.91	-2067.48
7	5		0.00	0.00	0.00	0.00
	8		0.00	0.00	0.00	0.00
8	6		2203.74	1863.87	1821.33	1771.00
	9		3317.00	2168.62	2158.91	2067.48
9	7		3317.00	4857.66	4361.87	4165.35
	8		5485.32	5952.87	5480.51	5224.61
10	8		-5485.32	-5952.87	-5480.51	-5224.61
	9		-3317.00	-4857.66	-4361.87	-4165.35
11	7			-2689.04	-2202.96	-2097.87
	10			-3184.20	-2014.85	-1954.09
12	8			-0.00	-0.00	-0.00
	11			-0.00	-0.00	-0.00
13	9			2689.04	2202.96	2097.87
	12			3184.20	2014.85	1954.09
14	10			3184.20	4329.28	3814.02
	11			4977.78	5182.60	4670.50
15	11			-4977.78	-5182.60	-4670.50
	12			-3184.20	-4329.28	-3814.02
16	10				-2314.42	-1859.94
	13				-2801.94	-1752.23
17	11				0.00	0.00
	14				0.00	0.00
18	12				2314.42	1859.94
	15				2801.94	1752.23
19	13				2801.94	3620.04
	14				4298.57	4343.38
20	14				-4298.57	-4343.38
	15				-2801.94	-3620.04
21	13					-1876.81
	16					-2291.01
22	14					-0.00
	17					-0.00
23	15					1876.81
	18					2291.01
24	16					2291.01
	17					3577.03
25	17					-3577.03
	18					-2291.01

TABLE 5. MOMENTS OF ONE- TO FIVE-STORY TWO-BAY PLANE FRAMES
WITH ONE INCH SETTLEMENT AT RIGHT EXTERNAL SUPPORT

MEM- BER	NODE	STORY				
		1	2	3	4	5
1	1	1129.73	828.28	846.89	838.37	834.52
	4	868.71	111.70	168.30	151.26	145.21
2	2	398.38	451.11	452.42	452.43	452.43
	5	-648.04	-591.84	-580.98	-580.97	-580.97
3	3	-85.56	214.45	196.34	204.86	208.71
	6	-1663.21	-1013.70	-1074.97	-1057.94	-1051.90
4	4	-868.71	-1326.54	-1218.80	-1180.49	-1149.29
	5	-1321.28	-1514.62	-1429.01	-1385.80	-1353.33
5	5	1969.33	2109.32	2019.67	1976.47	1943.99
	6	1663.21	2002.60	1888.34	1850.03	1818.83
6	4		1214.84	1050.50	1029.24	1004.08
	7		1603.08	1024.61	1019.79	974.08
7	5		-2.86	-0.67	-0.69	-0.69
	8		-112.24	-117.06	-117.13	-117.13
8	6		-988.90	-813.37	-792.09	-766.93
	9		-1713.92	-1144.00	-1139.11	-1093.40
9	7		-1603.08	-2374.84	-2126.96	-2028.70
	8		-2686.54	-2920.85	-2684.76	-2556.81
10	8		2798.78	3032.02	2795.75	2667.80
	9		1713.92	2482.81	2234.91	2136.65
11	7			1350.23	1107.17	1054.62
	10			1587.01	1002.01	971.63
12	8			5.88	6.14	6.14
	11			-7.13	-6.69	-6.69
13	9			-1338.81	-1095.79	-1043.25
	12			-1597.19	-1021.84	-982.46
14	10			-1587.01	-2160.18	-1902.56
	11			-2485.33	-2587.77	-2331.72
15	11			2492.46	2594.83	2338.78
	12			1597.19	2169.09	1911.46
16	10				1158.17	930.93
	13				1400.63	875.78
17	11				-0.36	-0.36
	14				-0.88	-0.90
18	12				-1156.25	-929.01
	15				-1401.31	-876.45
19	13				-1400.63	-1814.19
	14				-2148.84	-2171.29
20	14				2149.72	2172.09
	15				1401.31	1814.84
21	13					938.41
	16					1145.47
22	14					0.09
	17					-0.03
23	15					-938.40
	18					-1145.54
24	16					-1145.47
	17					-1788.50
25	17					1788.53
	18					1145.54

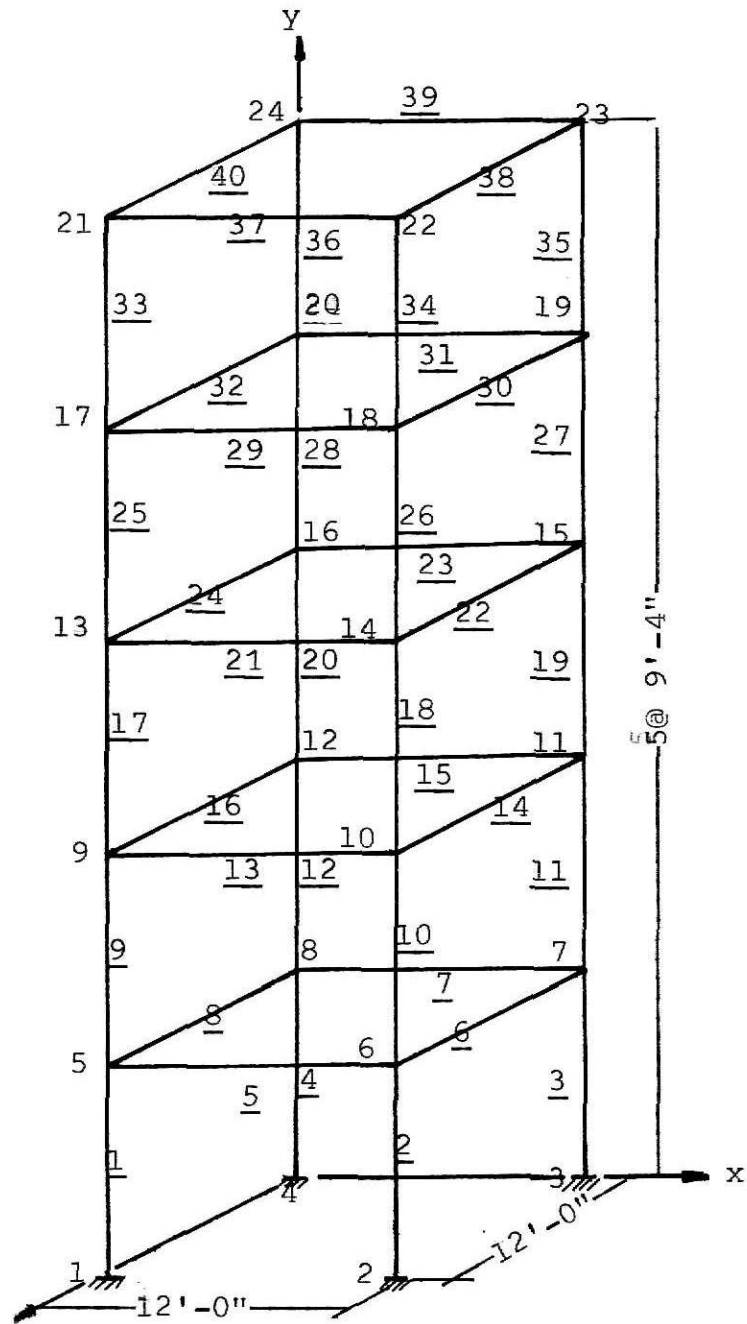

Fig. 26. Five-story one-bay space frame

TABLE 6-1. MOMENTS OF ONE-STORY ONE-BAY SPACE FRAME WITH ONE INCH SETTLEMENT AT RIGHT REAR SUPPORT

MEMBER	JOINT	MOMENT		
		MX	MY	MZ
1	1	-217.87	1.83*	189.43
	5	-7.05	-1.83*	38.34
2	2	-1218.77	1.83*	189.43
	6	1443.70	-1.83*	38.34
3	3	-1218.77	1.83*	723.78
	7	1443.70	-1.83*	-951.55
4	4	-217.87	1.83*	723.78
	8	-7.05	-1.83*	-951.55
5	5	-203.71*	-144.64	-230.95
	6	203.71*	-144.64	-230.95
6	6	-1647.41	146.48	192.62*
	7	-1647.41	146.48	-192.62*
7	7	203.71*	-144.64	1144.17
	8	-203.71*	-144.64	1144.17
8	8	210.76	146.48	-192.62*
	5	210.76	146.48	192.62*

TABLE 6-2. MOMENTS OF TWO-STORY ONE-BAY SPACE FRAME WITH ONE INCH SETTLEMENT AT RIGHT REAR SUPPORT

MEMBER	JOINT	MOMENT		
		MX	MY	MZ
1	1	-675.61	-5.76*	583.03
	5	-97.94	5.76*	181.55
2	2	-869.86	-5.76*	583.03
	6	1643.414	5.76*	181.55
3	3	-869.86	-5.76*	372.04
	7	1643.41	5.76*	-1136.63
4	4	-675.61	-5.76*	372.04
	8	-97.94	5.76*	-1136.63
5	5	-160.83*	-75.06	-605.29
	6	160.83*	-75.06	-605.29
6	6	-1760.41	71.93	139.92*
	7	-1760.41	71.93	-139.92*
7	7	160.83*	-75.06	1379.04
	8	-160.83*	-75.06	1379.04
8	8	561.50	71.93	-139.92*
	5	561.50	71.93	139.92*
9	5	-302.73	-2.63*	283.82
	9	-354.09	2.63*	368.91
10	6	-43.83	-2.63*	283.82
	10	700.66	2.63*	368.91
11	7	-43.83	-2.63*	-102.49
	11	700.66	2.63*	-550.23
12	8	-302.73	-2.63*	-102.49
	12	-354.09	2.63*	-550.23
13	9	-479.40*	-422.40	-807.02
	10	479.40*	-422.40	-807.02
14	10	-1180.06	419.76	438.11*
	11	-1180.06	419.76	-438.11*
15	11	479.40*	-442.40	988.35
	12	-479.40*	-442.40	988.35
16	12	833.49	419.76	-438.11*
	9	833.49	419.76	438.11*

TABLE 6-3. MOMENTS OF THREE-STORY ONE-BAY SPACE FRAME WITH ONE INCH SETTLEMENT AT RIGHT REAR SUPPORT

MEMBER	JOINT	MOMENT		
		MX	MY	MZ
1	1	-1000.23	-10.98*	858.45
	5	-139.01	10.98*	263.72
2	2	-547.09	-10.98*	858.45
	6	1686.33	10.98*	263.72
3	3	-547.09	-10.98*	97.05
	7	1686.33	10.98*	-1219.22
4	4	-1000.23	-10.98*	97.05
	8	-139.01	10.98*	-1219.22
5	5	-114.02*	-14.84	-872.20
	6	114.02*	-14.84	-872.20
6	6	-2001.58	10.70	91.18*
	7	-2001.58	10.70	-91.18*
7	7	114.02*	-14.84	1644.53
	8	-114.02*	-14.84	1644.53
8	8	806.70	10.70	-91.18*
	5	806.70	10.70	91.18*
9	5	-553.67	-6.84*	517.30
	9	-562.49	6.84*	588.49
10	6	201.23	-6.84*	517.30
	10	914.93	6.84*	588.23
11	7	201.23	-6.84*	-334.13
	11	914.93	6.84*	-771.40
12	8	-553.67	-6.84*	-334.13
	12	-562.49	6.84*	-771.40
13	9	-373.74*	-198.80	-1275.35
	10	373.74*	-198.80	-1275.35
14	10	-1592.59	196.43	332.09*
	11	-1592.59	196.43	-332.09*
15	11	373.74*	-198.80	1440.14
	12	-373.74*	-198.80	1440.14
16	12	1285.86	196.43	-332.09*
	9	1285.86	196.43	332.09*
17	9	-349.63	-4.47*	355.03
	13	-457.40	4.47*	445.04
18	10	303.91	-4.47*	355.03
	14	503.11	4.47*	445.04
19	11	303.91	-4.47*	-336.65
	15	503.11	4.47*	-463.42
20	12	-349.63	-4.47*	-336.65
	16	-457.40	4.47*	-463.42
21	13	-442.07*	-518.99	-844.18
	14	442.07*	-518.99	-844.18
22	14	-945.19	514.51	399.14*
	15	-945.19	514.51	-399.14*
23	15	442.07*	-518.99	862.56
	16	-442.07*	-518.99	862.56
24	16	899.47	514.51	-399.14*
	12	899.47	514.51	399.14*

TABLE 6-4. MOMENTS OF FOUR-STORY ONE-BAY SPACE FRAME WITH ONE INCH SETTLEMENT AT RIGHT REAR SUPPORT

MEMBER	JOINT	MOMENT		
		MX	MY	MZ
1	1	-1159.90	-13.30*	989.27
	5	-140.05	13.30*	290.01
2	2	-387.45	-13.30*	989.27
	6	1687.41	13.30*	290.01
3	3	-387.45	-13.30*	-33.76
	7	1687.41	13.30*	-1245.51
4	4	-1159.90	-13.30*	-33.76
	8	-140.05	13.30*	-1245.51
5	5	-87.66*	15.98	-992.40
	6	87.66*	15.98	-992.40
6	6	-2111.86	-20.50	64.76*
	7	-2111.86	-20.50	-64.76*
7	7	87.66*	15.98	1764.71
	8	-87.66*	15.98	1764.71
8	8	917.05	-20.50	-64.76*
	5	917.05	-20.50	64.76*
9	5	-689.34	-8.78*	637.63
	9	-635.45	8.78*	673.51
10	6	336.79	-8.78*	637.63
	10	988.00	8.78*	673.51
11	7	336.79	-8.78*	-454.44
	11	988.00	8.78*	-856.71
12	8	-689.34	-8.78*	454.44
	12	-635.45	8.78*	-856.71
13	9	-296.30*	-73.46	-1519.43
	10	296.30*	-73.46	-1519.43
14	10	-1833.97	72.15	258.21*
	11	-1833.97	72.15	-258.21*
15	11	296.30*	-73.46	1684.04
	12	-296.30*	-73.46	1684.04
16	12	1527.06	72.15	-256.21*
	9	1527.06	72.15	256.21*
17	9	-596.21	-7.48*	587.70
	13	-614.36	7.48*	611.24
18	10	549.67	-7.48*	587.70
	14	660.90	7.48*	611.24
19	11	549.67	-7.48*	-569.11
	15	660.90	7.48*	-629.83
20	12	-596.21	-7.48*	-569.11
	16	-614.36	7.48*	-629.83
21	13	-325.10*	-254.80	-1248.16
	14	325.10*	-254.80	-1248.16
22	14	-1322.50	251.75	284.28*
	15	-1322.50	251.75	-284.28*
23	15	325.10*	-254.80	1264.78
	16	-325.10*	-254.80	1264.78
24	16	1282.18	251.75	-284.28*
	13	1282.18	251.75	284.28*
25	13	-342.72	-4.42*	352.64
	17	-471.63	4.42*	454.84
26	14	336.51	-4.42*	352.64
	18	477.84	4.42*	454.84
27	15	336.51	-4.42*	-350.67
	19	477.84	4.42*	-456.80
28	16	-342.72	-4.42*	-350.67
	20	-471.63	4.42*	-456.80
29	17	-382.93*	-523.70	-799.40
	18	382.93*	-523.70	-799.40
30	18	860.77	519.28	344.56*
	19	860.77	519.28	-344.56*
31	19	382.93*	-523.70	801.36
	20	-382.93*	-523.70	801.36
32	20	854.56	519.28	-344.56*
	17	854.56	519.28	344.56*

TABLE 6-5. MOMENTS OF FIVE STORY ONE-BAY SPACE FRAME WITH ONE INCH SETTLEMENT AT RIGHT REAR SUPPORT

MEMBER	JOINT	MX	MOMENT MY	MZ
1	1	-1214.35	-13.90*	1029.99
	5	-123.92	13.90*	286.67
2	2	-333.01	-13.90*	1029.99
	6	1671.28	13.90*	286.67
3	2	-333.01	-13.90*	-74.49
	7	1671.28	13.90*	-1242.17
4	4	-1214.35	-13.90*	-74.49
	8	-123.92	13.90*	-1242.17
5	5	-75.93*	27.47	-1021.42
	6	75.93*	27.47	-1021.42
6	6	-2137.35	-32.04	53.63*
	7	-2137.35	-32.04	-53.63*
7	7	75.93*	27.47	1793.73
	8	-75.93*	27.47	1793.73
8	8	942.54	-32.04	-53.63*
	5	942.54	-32.04	53.63*
9	9	-742.68	-9.32*	681.12
	9	-638.30	9.32*	685.36
10	6	390.13	-9.32*	681.12
	10	990.85	9.32*	685.12
11	7	2390.13	-9.32*	-497.93
	11	990.85	9.32*	-868.56
12	8	-742.68	-9.32*	-497.93
	12	-638.30	9.32*	-868.56
13	9	-252.15*	-19.74	-1585.65
	10	252.15*	-19.74	-1585.65
14	10	-1900.38	18.97	217.30*
	11	-1900.38	18.97	-217.30*
15	11	252.15*	-19.74	1750.26
	12	-252.15*	-19.74	1750.26
16	12	1594.38	18.98	-217.30*
	9	1594.38	18.98	217.30*
17	9	-703.93	-8.55*	682.98
	13	-646.36	8.55*	654.00
18	10	657.38	-8.55*	682.98
	14	692.91	8.55*	654.00
19	11	657.38	-8.55*	-664.40
	15	692.91	8.55*	-672.59
20	12	-703.93	-8.55*	-664.40
	16	-646.36	8.55*	-672.59
21	13	-247.23*	-125.99	-1419.52
	14	247.23*	-125.99	-1419.52
22	14	-1490.55	124.22	210.87*
	15	-1490.55	124.22	-210.87*
23	15	247.23*	-125.99	1436.12
	16	-247.23*	-125.99	1436.12
24	16	1450.32	124.22	-210.87*
	13	1450.32	124.22	210.87*
25	13	-556.73	-6.78*	554.65
	17	-597.65	6.78*	589.18
26	14	550.40	-6.78*	554.65
	18	603.97	6.78*	589.18
27	15	550.40	-6.78*	-552.66
	19	603.97	6.78*	-591.16
28	16	-556.73	-6.78*	-552.66
	20	-597.65	6.78*	-591.16
29	17	-267.45*	-264.83	-1132.95
	18	267.45*	-264.83	-1132.95
30	18	-1170.74	262.36	232.00*
	19	-1170.74	262.36	-232.00*
31	19	267.45*	-264.83	1134.73
	20	-267.45*	-264.83	1134.73
32	20	1165.24	262.36	-232.00*
	17	1165.24	262.36	232.00*

23	17	-300.14	-4.31*	311.77
	21	-426.51	4.31*	408.31
34	18	299.30	-4.31*	311.77
	22	427.34	4.31*	408.31
35	19	299.30	-4.31*	-311.57
	23	427.35	4.31*	-408.51
36	20	-300.14	-4.31*	-311.57
	24	-426.51	4.31*	-408.51
37	21	-322.88*	-477.53	-698.87
	22	322.88*	-477.53	-698.87
28	23	750.22	473.22	290.56*
	23	750.22	473.22	-290.56*
29	23	322.88*	-477.53	699.07
	24	-322.88*	-477.53	699.07
40	24	749.39	473.22	-290.56*
	21	749.39	473.22	290.56*

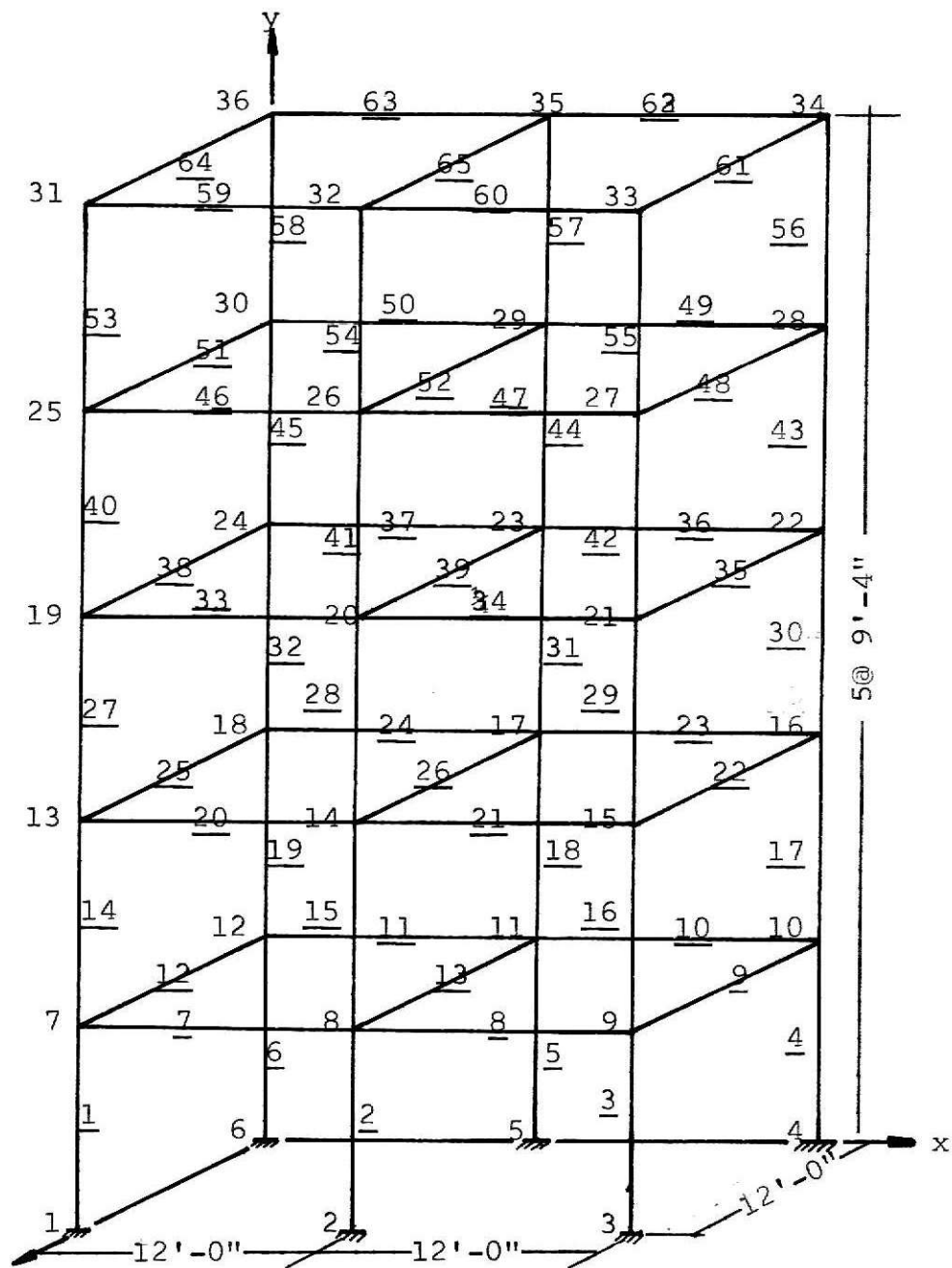

Fig. 27. Five-story two-bay space frame

TABLE 7-1. MOMENTS OF ONE-STORY TWO-BAY SPACE FRAME WITH ONE INCH SETTLEMENT AT RIGHT REAR EXTERNAL SUPPORT

MEMBER	JOINT	MX	MOMENT	
			MY	MZ
1	1	-18.23	18.76*	116.69
	7	-6.10	-18.76*	65.02
2	2	-176.34	-16.98	118.82
	8	15.06	16.98*	67.21
3	3	-1242.07	-14.37*	70.16
	9	1427.78	14.37*	-38.11
4	4	-1242.07	14.37*	-110.83
	10	1427.78	14.37*	-1568.27
5	5	-176.34	-16.98*	280.85
	11	15.06	16.98*	-708.03
6	6	-18.23	18.76*	955.38
	12	-6.10	-18.76*	750.20
7	7	-14.90*	-25.72	-85.43
	8	14.90*	-5.69	-85.92
8	8	-205.93*	-118.70	-99.73
	9	205.93*	-120.16	-132.38
9	9	-1633.72	105.79	170.49*
	10	-1633.72	105.79	170.49*
10	10	205.93*	-120.16	1738.76
	11	-205.93*	-118.70	2008.76
11	11	14.90*	-5.69	-1182.28
	12	-14.90*	-25.72	-730.68
12	7	21.90	44.48	19.51*
	12	21.90	44.48	-19.51*
13	8	175.98	107.41	118.44*
	11	175.98	107.41	-118.44*

TABLE 7-2. MOMENTS OF ONE-STORY TWO-BAY SPACE FRAME WITH ONE INCH SETTLEMENT AT RIGHT REAR EXTERNAL SUPPORT

MEMBER	JOINT	MX	MOMENT MY	MZ
1	1	-105.26	6.91*	336.82
	7	-28.34	-6.91*	119.77
2	2	-482.12	-26.22*	379.05
	8	-28.70	26.22*	210.97
3	3	-958.10	-23.65*	329.97
	9	1602.52	23.65*	111.77
4	4	-958.10	-23.65*	-95.25
	10	1602.52	23.65*	-1101.30
5	5	-482.12	-26.22*	73.36
	11	-28.70	26.22*	-795.80
6	6	-105.26	6.91*	462.70
	12	-28.34	-6.91*	-32.96
7	7	-31.28*	-25.06	-335.6
	8	31.28*	-6.50	-307.90
8	8	-175.09*	-61.88	-268.29
	9	175.09*	-63.33	-296.66
9	9	-1694.60	62.54	99.56*
	10	1694.60	62.54	-99.56*
10	10	-175.09*	-63.33	2224.88
	11	175.09*	-61.88	2303.75
11	11	-31.28*	-6.50	-1144.09
	12	31.28*	-25.06	-928.86
12	7	99.84	17.98	35.21*
	12	99.84	17.98	-35.21*
13	8	395.85	69.78	88.48*
	11	395.85	69.78	-88.48*
14	7	-40.21	14.00*	180.62
	12	-68.85	-14.00*	288.12
15	8	-223.34	-27.63*	276.74
	14	-214.66	27.63*	351.54
16	9	-83.01	-22.86*	85.33
	15	630.08	22.86*	73.19
17	10	-83.01	-22.86*	-1024.01
	16	630.08	22.86*	-1751.68
18	11	-223.34	-27.63*	-275.37
	17	-214.66	27.63*	-470.06
19	12	-40.21	14.00*	997.03
	18	-68.85	-14.00*	1268.55
20	12	-68.10*	-108.09	-312.11
	14	68.10*	-32.19	-299.70
21	14	-487.23*	-347.90	-310.00
	15	487.23*	-355.73	-482.27
22	15	-1117.31	332.87	409.08*
	16	1117.31	332.87	-409.08*
23	16	-487.23*	-355.73	2160.76
	17	487.23*	-347.90	3024.10
24	17	-68.11*	-32.19	-2296.51
	18	68.11*	-108.09	-1244.56
25	12	136.96	122.08	22.98*
	18	136.96	122.08	-22.98*
26	14	633.78	352.47	257.53*
	17	633.78	352.47	-257.53*

TABLE 7-2. MOMENTS OF THREE-STORY TWO-BAY SPACE FRAME WITH ONE INCH SETTLEMENT AT RIGHT REAR EXTERNAL SUPPORT

MEMBER	JOINT	MX	MOMENT MY	MZ
1	1	-212.20	-12.64*	543.84
	7	-45.33	12.64*	202.70
2	2	-685.33	-27.78*	612.87
	8	-49.85	27.78*	346.29
3	3	-649.78	-26.33*	524.96
	9	1642.51	26.33*	166.07
4	4	-649.78	-26.33*	-311.08
	10	1642.51	26.33*	-1223.27
5	5	-685.33	-27.78*	-159.57
	11	-49.85	27.78*	-931.48
6	6	-212.20	12.64*	276.83
	12	-45.33	-12.64*	-48.17
7	7	-38.94*	-10.39	-521.57
	8	38.94*	-1.92	-478.60
8	8	-137.66*	-17.76	-428.35
	9	137.66*	-18.57	-481.54
9	9	-1920.19	18.60	69.92*
	10	-1920.19	18.60	-69.92*
10	10	137.66*	-18.57	2299.81
	11	-137.66*	-17.75	2380.65
11	11	38.94*	-1.92	-891.12
	12	-38.94*	-10.39	-633.59
12	7	191.79	-0.69	-2.04*
	12	191.79	-0.69	2.04*
13	8	533.52	22.53	63.86*
	11	533.52	22.53	-63.86*
14	7	-107.52	-1.56*	320.91
	13	-140.44	1.56*	405.37
15	8	-384.94	-30.63*	496.80
	14	-331.57	30.63*	570.50
16	9	146.02	-26.35*	245.55
	15	826.46	26.35*	294.72
17	10	140.02	-26.35*	-1006.62
	16	824.46	26.35*	-1384.12
18	11	-384.94	-30.63*	-494.18
	17	-331.57	30.63*	-687.87
19	12	-107.52	-1.56*	679.72
	18	-140.44	1.56*	559.22
20	13	-93.29*	-71.80	-729.40
	14	93.29*	-24.49	-656.42
21	14	-399.61*	-174.92	-504.34
	15	399.61*	-181.33	-644.65
22	15	-1480.10	179.94	265.35*
	16	-1480.10	179.94	-265.35*
23	16	399.61*	-181.33	2987.53
	17	-399.61*	-174.92	3394.12
24	17	93.29*	-24.49	-2121.41
	18	-93.29*	-71.80	-1502.24
25	13	299.65	61.18	55.17*
	18	299.65	61.18	-55.17*
26	14	873.73	200.56	206.96*
	17	873.73	200.56	-206.96*

27	13	-65.91	9.06*	268.85
	10	-107.17	-9.06*	364.00
28	14	-235.83	-31.78*	383.30
	20	-278.57	31.78*	436.80
29	15	256.03	-24.97*	84.57
	21	431.47	24.97*	109.53
30	16	256.03	-24.97*	-1338.06
	22	431.47	24.97*	-1620.29
31	17	-235.83	-31.78*	-377.88
	23	-278.57	31.78*	-444.87
32	18	-65.91	9.06*	998.19
	24	-107.17	-9.06*	1135.88
33	19	-92.96*	-160.31	-406.01
	20	92.96*	-62.33	-291.78
34	20	-448.18*	-434.69	-289.26
	21	448.18*	-449.55	-469.86
35	21	-879.65	424.58	360.36*
	22	-879.65	424.58	-360.36*
36	22	448.18*	-439.55	1980.65
	23	-448.18*	-434.69	2690.81
37	23	92.96*	-62.33	-2001.70
	24	-92.96*	-160.31	-1093.86
38	19	200.15	169.36	44.02*
	24	200.15	169.36	-44.02*
39	20	633.78	465.24	244.23*
	23	633.78	465.24	-244.23*

TABLE 7-4. MOMENT OF FOUR-STORY TWO-BAY SPACE FRAME WITH ONE INCH SETTLEMENT AT RIGHT REAR EXTERNAL SUPPORT

MEMBER	JOINT	MX	MOMENT MY	MZ
1	1	-300.13	-24.39*	669.01
	7	-52.44	24.39*	243.27
2	2	-779.33	-27.91*	754.26
	8	-49.95	27.91*	421.17
3	3	-467.80	-28.71*	649.04
	9	1649.75	28.71*	206.11
4	4	-467.80	-28.71*	-427.62
	10	1649.75	28.71*	-1247.63
5	5	-779.33	-27.91*	-300.95
	11	-49.95	27.91*	-1006.34
6	6	-300.13	-24.39*	144.13
	12	-52.44	24.39*	-104.43
7	7	-40.02*	1.98	-641.56
	8	40.02*	3.96	-588.17
8	8	-115.35*	6.78	-524.21
	9	115.35*	7.23	-587.50
9	9	-2047.21	-8.54	47.65*
	10	-2047.21	-8.54	-47.65*
10	10	115.35*	7.23	2370.32
	11	-115.35*	6.78	2436.36
11	11	40.02*	3.96	-741.40
	12	-40.02*	1.98	-478.16
12	7	261.93	-12.45	-22.39*
	12	261.93	-12.45	22.39*
13	8	590.47	-8.55	47.05*
	11	590.47	-8.55	-47.05*
14	7	-169.46	-13.93*	420.68
	13	-187.72	13.93*	504.86
15	8	-465.19	-30.11*	644.17
	14	-370.36	30.11*	719.84
16	9	282.11	-27.40*	333.74
	15	910.64	27.40*	365.49
17	10	282.11	-27.40*	-1075.03
	16	910.64	27.40*	-1450.23
18	11	-465.19	-30.11*	-641.57
	17	-370.36	30.11*	-837.28
19	12	-169.46	-13.93*	560.20
	18	-187.72	13.93*	455.12
20	13	-101.12*	-31.06	-942.35
	14	101.12*	-8.20	-845.26
21	14	-355.89*	-78.05	-655.47
	15	355.89*	-80.90	-841.85
22	15	-1732.36	81.02	214.45*
	16	-1732.36	81.02	-214.45*
23	16	355.89*	-80.90	-2962.02
	17	355.89*	-78.05	-3332.88
24	17	101.12*	-8.20	1720.38
	18	-101.12*	-31.06	1066.61
25	13	439.22	21.84	9.34*
	18	439.22	21.84	-9.34*
26	14	987.13	89.83	174.00*
	17	987.13	89.83	-174.00*

27	13	-150.37	-4.71*	428.15
	19	-176.20	4.71*	461.64
28	14	-381.90	-33.69*	606.89
	20	-360.50	33.69*	621.96
29	15	485.82	-27.52*	261.90
	21	583.22	27.52*	308.60
30	16	485.83	-27.52*	-1297.33
	22	583.33	27.52*	-1268.83
31	17	-381.99	-33.69*	-601.22
	23	-360.50	33.69*	-629.63
32	18	-150.37	-4.71*	620.83
	24	-176.20	4.71*	487.03
33	19	-111.67*	-99.25	-815.55
	20	111.67*	-40.44	-744.46
34	20	-352.82*	-227.48	-472.25
	21	352.82*	-237.97	-614.13
35	21	-1229.04	232.38	-220.08*
	22	-1229.04	232.38	-220.08*
36	22	352.82*	-237.98	2666.88
	23	-352.82*	-227.48	2957.45
37	23	111.67*	-40.44	-1732.76
	24	-111.67*	-99.25	-1227.61
38	19	372.07	90.34	61.08*
	24	372.07	90.34	-61.08*
39	20	816.66	264.50	187.45*
	22	816.66	264.50	-187.45*
40	19	-84.10	4.20*	292.83
	25	-133.95	-4.20*	403.00
41	20	-215.00	-30.27*	407.40
	26	-274.20	30.27*	470.00
42	21	292.89	-21.91*	85.44
	27	414.37	21.91*	117.33
43	22	292.89	-21.91*	-1177.97
	28	414.37	21.91*	-1452.10
44	23	-215.00	-30.27*	-407.61
	29	-274.20	30.27*	-470.93
45	24	-84.10	4.20*	801.66
	20	-133.95	-4.20*	930.94
46	25	-109.67*	-191.32	-458.55
	26	109.67*	-89.13	-450.22
47	26	-391.48*	-444.32	-243.67
	27	391.48*	-465.34	-425.96
48	27	-805.85	443.43	308.64*
	28	-805.85	443.43	-308.64*
49	28	391.48*	-465.34	1760.74
	29	-391.48*	-444.32	2329.49
50	29	109.67*	-89.13	-1634.67
	30	-109.67*	-191.32	-875.39
51	25	243.62	195.52	55.55*
	20	243.62	195.52	-55.55*
52	26	556.02	503.18	223.89*
	29	556.02	503.18	-223.89*

TABLE 7-5. MOMENT OF FIVE-STORY TWO-BAY SPACE FRAME WITH ONE INCH SETTLEMENT AT RIGHT REAR EXTERNAL SUPPORT

MEMBER	JOINT	MOMENT		
		MX	MY	MZ
1	1	-356.48	-29.72*	730.23
	7	-50.83	29.72*	260.24
2	2	-810.18	-27.58*	823.02
	8	-42.12	27.58*	453.89
3	3	-380.70	-30.27*	709.16
	9	1640.31	30.27*	221.15
4	4	-380.70	-30.27*	-484.07
	10	1640.31	30.27*	-1256.49
5	5	-810.18	-27.58*	-369.70
	11	-42.12	27.58*	-1039.07
6	6	-356.48	-29.72*	79.23
	12	-50.83	29.72*	-127.54
7	7	-38.42*	9.66	-697.51
	8	38.42*	8.46	-639.38
8	8	-104.11*	17.95	-568.89
	9	104.11*	19.46	-637.40
9	9	-2098.90	-21.52	-35.04*
	10	-2098.90	-21.52	-35.94*
10	10	104.11*	19.46	2391.37
	11	-104.11*	17.95	2450.76
11	11	38.42*	8.46	-659.90
	12	-38.42*	9.66	-393.35
12	7	301.52	-19.41	-33.26*
	12	301.52	-19.41	33.26*
13	8	602.57	-24.85	37.04*
	11	602.57	-24.85	-37.94*
14	7	-212.27	-19.97*	470.55
	13	-209.13	19.97*	545.17
15	8	-494.76	-29.15*	716.45
	14	-372.52	29.15*	785.28
16	9	354.48	-28.20*	380.32
	15	934.21	28.20*	402.21
17	10	354.48	-28.20*	-1098.94
	16	934.21	28.20*	-1445.04
18	11	-494.76	-29.15*	-713.85
	17	-372.52	29.15*	-902.71
19	12	-212.27	-19.97*	487.66
	18	-209.13	19.97*	372.91
20	13	-99.32*	-3.77	-1054.75
	14	99.32*	6.26	-944.45
21	14	-297.98*	-31.14	-724.85
	15	297.98*	-30.42	-925.79
22	15	-1839.89	30.03	179.42*
	16	-1839.89	30.03	-179.42*
23	16	297.98*	-30.42	2955.69
	17	-297.98*	-31.13	3283.69
24	17	99.32*	6.26	-1502.63
	18	-99.32*	-3.77	-863.04
25	13	521.52	-1.88	-12.70*
	18	521.52	-1.88	12.70*
26	14	1012.27	28.04	151.56*
	17	1012.27	28.04	-151.56*

27	13	-213.06	-14.32*	522.29
	19	-210.28	14.32*	531.65
28	14	-441.18	-32.32*	732.47
	20	-376.31	32.32*	727.93
29	15	607.70	-27.82*	344.16
	21	633.14	27.82*	354.09
30	16	607.70	-27.82*	-1331.23
	22	633.14	27.82*	-1286.23
31	17	-441.18	-32.32*	-726.79
	23	-376.31	32.32*	-735.60
32	18	-213.06	-14.32*	478.33
	24	-210.28	14.32*	388.04
33	19	-113.14*	-48.01	-991.04
	20	113.14*	-16.55	-900.35
34	20	-289.20*	-123.84	-597.09
	21	289.20*	-128.70	-777.62
35	21	-1424.45	124.98	168.57*
	22	-1424.45	124.98	-168.57*
36	22	289.20*	-128.70	2597.56
	23	-289.20*	-123.84	2849.68
37	23	113.14*	-16.55	-1344.36
	24	-113.14*	-48.91	-819.32
38	19	496.56	42.76	17.85*
	24	496.56	42.76	-17.85*
39	20	887.66	139.30	152.88*
	23	887.66	139.30	-152.88*
40	19	-173.14	-8.16*	441.54
	25	-199.30	8.16*	482.38
41	20	-335.29	-31.22*	616.62
	26	-336.75	31.22*	637.18
42	21	502.11	-24.10*	254.96
	27	542.38	24.10*	302.45
43	22	502.11	-24.10*	-1142.75
	28	542.38	24.10*	-1142.37
44	23	-335.29	-31.22*	-616.83
	29	-336.75	31.22*	-638.12
45	24	-173.14	-8.16*	448.23
	20	-199.30	8.16*	356.71
46	25	-118.43*	-114.97	-826.79
	26	118.43*	-53.50	-772.86
47	26	-298.13*	-238.42	-419.52
	27	298.13*	-252.25	-564.50
48	27	-1116.49	247.21	182.20*
	28	-1116.49	247.21	-182.20*
49	28	298.13*	-252.25	2292.45
	29	-298.13*	-238.42	2515.98
50	29	118.43*	-53.50	-1322.74
	20	-118.43*	-114.97	-890.39
51	25	412.37	106.83	56.15*
	20	412.37	106.83	-56.15*
52	26	698.61	288.97	164.98*
	29	698.61	288.97	-164.98*

53	25	-94.64	-0.02*	298.26
	31	-146.74	0.02*	404.72
54	26	-182.15	-28.18*	390.21
	32	-239.45	28.18*	450.99
55	27	275.97	-19.06*	79.85
	33	387.01	19.06*	111.20
56	28	275.97	-19.06*	-967.87
	34	387.01	19.06*	-1202.66
57	29	-182.15	-28.18*	-390.14
	35	-239.45	28.18*	-451.03
58	30	-94.64	-0.02*	580.82
	36	-146.74	0.02*	686.65
59	31	-117.27*	-203.39	-462.85
	32	117.27*	-107.07	-464.26
60	33	-335.61*	-413.79	-189.24
	34	335.61*	-438.93	-375.72
61	33	-722.62	419.86	264.52*
	34	-722.62	419.86	-264.52*
62	34	335.61*	-438.93	1467.18
	35	-335.61*	-413.79	1935.97
63	35	117.27*	-107.07	-1282.21
	36	-117.27*	-203.39	-627.52
64	31	264.01	203.37	59.13*
	36	264.01	203.37	-59.13*
65	32	457.79	492.68	202.61*
	35	457.79	492.68	-202.61*

TABLE 8-1. MOMENTS OF ONE-STORY TWO-BAY SPACE FRAME WITH ONE INCH SETTLEMENT AT MIDDLE REAR SUPPORT

MEMBER	JOINT	MX	MOMENT MY	MZ
1	1	-176.34	-33.13*	-46.53
	7	15.06	33.13*	-104.03
2	2	-1083.96	-0.00*	-0.00
	8	1406.52	0.00*	-0.00
3	2	-176.34	33.13*	46.53
	9	15.06	-33.13*	-104.03
4	4	-176.34	33.13*	1066.47
	10	15.06	-33.13*	2318.47
5	5	-1083.96	0.00*	-0.00
	11	1406.52	-0.00*	-0.00
6	6	-176.34	-33.13*	-1066.47
	12	15.06	33.13*	-2318.47
7	7	-191.03*	-94.44	-46.95
	8	191.03*	-113.00	-13.81
8	8	191.03*	113.00	13.81
	9	-191.03*	94.44	46.95
9	9	175.98	-61.31	-150.98*
	10	175.98	-61.31	150.98*
10	10	-191.03*	94.44	-2469.45
	11	191.03*	113.00	-3191.05
11	11	191.03*	-113.00	3191.05
	12	-191.03*	-94.44	2469.45
12	7	175.98	61.31	150.98*
	12	175.98	61.31	-150.98*
13	8	-1788.60	0.00	-0.00*
	11	-1788.60	-0.00	0.00*

TABLE R-2. MOMENTS OF TWO-STORY TWO-BAY SPACE FRAME WITH ONE INCH SETTLEMENT AT MIDDLE REAR SUPPORT

MEMBER	JOINT	MX	MOMENT MY	MZ
1	1	-482.12	-30.56*	-6.85
	7	-28.70	30.56*	-8.00
2	2	-581.23	-0.00*	-0.00
	8	1602.88	0.00*	-0.00
3	3	-482.12	30.56*	6.85
	9	-28.70	-30.56*	8.00
4	4	-482.12	30.56*	557.06
	10	-28.70	-30.56*	1068.34
5	5	-581.23	0.00*	-0.00
	11	1602.88	-0.00*	-0.00
6	6	-482.12	-30.56*	-557.06
	12	-28.70	30.56*	-1068.34
7	7	-143.80*	-38.27	38.94
	8	143.80*	-55.39	39.61
8	8	143.80*	55.39	-39.61
	9	-143.80*	38.27	-38.94
9	9	395.85	-44.56	-64.35*
	10	395.85	-44.56	64.35*
10	10	-143.80*	38.27	-3153.74
	11	143.80*	55.39	-3447.84
11	11	143.80*	-55.39	3447.84
	12	143.80*	-38.27	3153.74
12	7	295.85	44.56	64.35*
	12	295.85	44.56	-64.35*
13	8	-1990.61	0.00	0.00*
	11	-1990.61	-0.00	-0.00*
14	7	-223.34	-36.85*	-95.29
	13	-214.66	36.85*	-214.93
15	8	100.12	0.00*	-0.00
	14	775.80	-0.00*	0.00
16	9	-223.34	36.85*	95.29
	15	-214.66	-36.85*	214.93
17	10	-223.34	36.85*	2021.04
	16	-214.66	-36.85*	3020.23
18	11	100.12	-0.00*	-0.00
	17	775.80	0.00*	-0.00
19	12	-223.34	-36.85*	-2021.04
	18	-214.66	36.85*	-3020.23
20	13	-419.12*	-247.64	-170.16
	14	419.12*	-315.71	-10.93
21	14	419.12*	315.71	10.93
	15	-419.12*	247.64	170.16
22	15	633.78	-210.79	-385.10*
	16	633.78	-210.79	385.10*
23	16	-419.12*	247.64	-3405.33
	17	419.12*	315.71	-5320.61
24	17	419.12*	-315.71	5320.61
	18	-419.12*	-247.64	3405.33
25	12	633.78	210.79	385.10*
	18	633.78	210.79	-385.10*
26	14	-1614.14	-0.00	-0.00*
	17	-1614.14	-0.00	-0.00*

TABLE 8-3. MOMENTS OF TWO-STORY TWO-BAY SPACE FRAME WITH ONE INCH SETTLEMENT AT MIDDLE REAR SUPPORT

MEMBER	JOINT	MX	MOMENT MY	MZ
1	1	-685.34	-13.68*	-18.88
	7	-49.85	13.68*	-36.62
2	2	-176.64	-0.00*	-0.00
	8	1647.02	0.00*	-0.00
3	3	-685.34	13.68*	18.88
	9	-49.85	-13.68*	36.63
4	4	-685.34	13.68*	587.91
	10	-49.85	-13.68*	1175.10
5	5	-176.64	0.00*	-0.00
	11	1647.02	-0.00*	-0.00
6	6	-685.34	-13.68*	-587.91
	12	-49.85	13.68*	-1175.10
7	7	-98.72*	-8.18	40.02
	8	98.72*	-15.84	50.25
8	8	98.72*	15.84	-50.25
	9	-98.72*	8.18	-40.02
9	9	533.52	-19.28	-71.96*
	10	533.52	-19.28	71.96*
10	10	-98.72*	8.18	-2933.40
	11	98.72*	15.84	-3271.77
11	11	98.72*	-15.84	3271.77
	12	-98.72*	-8.18	2933.40
12	7	522.52	19.28	71.96*
	12	533.52	19.28	-71.96*
13	8	-2261.92	0.00	0.00*
	11	-2261.92	-0.00	-0.00*
14	7	-384.94	-24.79*	-75.35
	13	-331.57	24.79*	-110.65
15	8	417.44	0.00*	-0.00
	14	1015.50	-0.00*	0.00
16	9	-384.94	24.79*	75.35
	15	-331.57	-24.79*	110.65
17	10	-331.57	24.79*	1686.34
	16	-331.57	-24.79*	1043.34
18	11	417.44	-0.00*	-0.00
	17	1015.50	0.00*	-0.00
19	12	-384.94	-24.79*	-1686.34
	18	-331.57	24.79*	-1943.34
20	13	-306.32*	-109.52	84.74
	14	306.32*	-150.43	152.08
21	14	306.32*	150.43	-152.08
	15	-306.32*	109.52	84.74
22	15	873.73	-118.76	-210.18*
	16	873.73	-118.76	210.18*
23	16	-306.32*	109.527	-4489.78
	17	306.32*	150.43	-5515.53
24	17	306.32*	-150.43	5515.53
	18	-306.32*	-109.52	4489.78
25	13	873.73	118.76	210.18*
	18	873.73	118.76	-210.18*
26	14	-2054.18	-0.00	-0.00*
	17	-2054.18	0.00	0.00*

27	13	-235.83	-34.02*	-184.28
	19	-278.57	34.02	-254.49
28	14	425.05	0.00*	0.00
	20	602.85	-0.00*	0.00
20	15	-235.83	34.02*	184.28
	21	-278.57	-34.02*	254.49
20	16	-235.83	34.02*	2336.25
	22	-278.57	-34.02*	2756.17
21	17	425.05	-0.00*	0.00
	22	602.85	0.00*	0.00
32	18	-235.83	-34.02*	-2336.25
	24	-278.57	34.02*	-2756.17
33	19	-355.21*	-289.24	-63.85
	20	355.21*	-372.36	102.52
34	20	355.21*	372.36	-102.52
	21	-355.21*	289.24	63.85
35	21	633.78	-255.22	-318.34*
	22	633.78	-255.22	318.34*
36	22	-355.21*	289.24	-3074.51
	22	355.21*	372.36	-4692.51
37	23	355.21*	-372.36	4692.51
	24	-355.21*	-289.24	3074.51
38	19	633.78	255.22	318.34*
	24	633.78	255.22	-318.34*
30	20	-1313.28	-0.00	0.00*
	23	-1313.28	0.00	-0.00*

TABLE 8-4. MOMENTS OF FOUR-STORY TWO-BAY SPACE FRAME WITH ONE INCH SETTLEMENT AT MIDDLE REAR SUPPORT

MEMBER	JOINT	MX	MOMENT MY	MZ
1	1	-779.33	-4.32*	-19.96
	7	-49.95	4.32*	-37.15
2	2	11.31	0.00*	-0.00
	8	1647.26	-0.00*	-0.00
3	3	-779.33	4.32*	19.96
	9	-49.95	-4.32*	37.15
4	4	-779.33	4.32*	571.77
	10	-49.95	-4.32*	1143.20
5	5	11.31	-0.00*	-0.00
	11	1647.26	0.00*	-0.00
6	6	-779.33	-4.32*	-571.77
	12	-49.95	4.32*	-1143.20
7	7	-75.33*	5.24	54.05
	8	75.33*	2.82	63.96
8	8	75.33*	-2.82	-63.96
	9	-75.33*	-5.24	-54.05
9	9	590.47	-3.91	-70.04*
	10	590.47	-3.91	70.04*
10	10	-75.33	-5.24	-2848.47
	11	75.33*	-2.82	-3177.75
11	11	75.33*	2.82	3177.75
	12	-75.33*	5.24	2848.47
12	7	590.47	3.91	70.04*
	12	590.47	3.91	-70.04*
13	8	-2375.75	-0.00	0.00*
	11	-2375.75	0.00	-0.00*
14	7	-465.19	-13.47*	-86.94
	13	-370.36	13.47*	-139.37
15	8	577.84	0.00*	-0.00
	14	1093.28	-0.00*	0.00
16	9	-465.19	13.47*	86.94
	15	-370.36	-13.47*	139.37
17	10	-465.19	13.47*	1635.24
	16	-370.36	-13.47*	1905.35
18	11	577.84	-0.00*	-0.00
	17	1093.28	0.00*	-0.00
19	12	-465.19	-13.47*	-1635.24
	18	-370.36	13.47*	-1905.35
20	13	-234.78*	-49.84	100.49
	14	234.78*	-69.85	189.79
21	10	234.78*	49.84	-189.79
	15	-234.78*	69.85	-100.49
22	15	987.13	-59.18	-205.12*
	16	987.13	-59.18	205.12*
23	16	-234.78*	49.84	-4028.63
	17	234.78*	69.18	-5053.25
24	17	234.78*	-69.18	5053.25
	18	-234.78*	-49.84	4028.63
25	13	987.13	59.18	205.12*
	18	987.13	59.18	-205.12*
26	14	-2280.28	-0.00	0.00*
	17	-2280.28	0.00	-0.00*

27	13	-381.99	-22.81*	-166.24
	19	-360.50	22.81*	-153.04
28	14	717.45	0.00*	0.00
	20	767.54	-0.00*	0.00
29	15	-381.99	22.81*	166.24
	21	-360.50	-22.81*	153.04
30	16	-381.99	22.81*	1918.16
	22	-360.50	-22.81*	1755.86
31	17	717.45	-0.00*	0.00
	23	767.54	0.00*	0.00
32	18	-381.99	-22.81*	-1918.16
	24	-360.50	22.81*	-1755.86
33	19	-241.15*	-138.73	201.43
	20	241.15*	-187.04	272.10
34	20	241.15*	187.04	-272.10
	21	-241.15*	138.73	-201.43
35	21	816.66	-142.04	-159.00*
	22	816.66	-142.04	159.00*
36	22	-241.15*	138.73	-3894.50
	23	241.15*	187.04	-4690.21
37	23	241.15*	-187.04	4690.21
	24	-241.15*	187.04	3894.50
38	19	816.66	142.04	159.00*
	24	816.66	142.04	-159.00*
39	20	-1673.63	-0.00	0.00*
	23	-1673.63	0.00	-0.00*
40	19	-215.00	-26.12*	-207.39
	25	-274.20	26.12*	-285.67
41	20	422.80	0.00*	-0.00
	26	554.62	-0.00*	-0.00
42	21	-215.00	26.12*	207.39
	27	-274.20	-26.12*	285.67
43	22	-215.00	26.12*	1979.63
	28	-274.20	-26.12*	2383.04
44	22	422.80	-0.00*	-0.00
	29	554.62	0.00*	-0.00
45	24	-215.00	-26.12*	-1979.63
	30	-274.20	26.12*	-2383.04
46	25	-281.81*	-274.02	32.59
	26	281.81*	-355.19	206.56
47	26	281.81*	355.19	-206.56
	27	-281.81*	274.02	-32.59
48	27	556.02	-247.90	-253.08*
	28	556.02	-247.90	253.08*
49	28	-281.81*	274.02	-2636.13
	29	281.81*	355.19	-3964.16
50	29	281.81*	-355.19	3964.16
	30	-281.81*	-274.02	2636.13
51	25	556.02	247.02	253.08*
	30	556.02	247.02	-253.08*
52	26	-1118.25	-0.00	-0.00*
	29	-1118.25	0.00	0.00*

TABLE 2-5. MOMENTS OF FIVE-STORY TWO-BAY SPACE FRAME WITH ONE INCH SETTLEMENT AT MIDDLE REAR SUPPORT

MEMBER JOINT		MOMENT		
		MX	MY	MZ
1	1	-810.18	-0.55*	-21.06
	7	-42.13	0.55*	-39.08
2	2	73.00	0.00*	-0.00
	8	1631.60	-0.00*	-0.00
3	3	-810.18	0.55*	21.06
	9	-42.13	-0.55*	39.08
4	4	-810.18	0.55*	563.30
	10	-42.13	-0.55*	1128.93
5	5	73.00	-0.00*	-0.00
	11	1631.60	0.00*	-0.00
6	6	-810.18	-0.55*	-563.30
	12	-42.13	0.55*	-1128.93
7	7	-65.69*	9.80	60.11
	8	65.69*	9.49	70.49
8	8	65.69*	-9.49	-70.49
	9	-65.69*	-9.80	-60.11
9	9	602.57	2.11	-69.20*
	10	602.57	2.11	69.20*
10	10	-65.69*	-9.80	-2784.72
	11	65.69*	-9.49	-3110.66
11	11	65.69*	9.49	3110.66
	12	-65.69*	9.80	2784.72
12	7	602.57	-2.11	69.20*
	12	602.57	-2.11	-69.20*
13	8	-2309.95	-0.00	-0.00*
	11	-2309.95	0.00	0.00*
14	7	-494.76	-8.23*	-90.23
	12	-372.53	8.23*	-142.95
15	8	636.98	0.00*	0.00
	14	1097.61	-0.00*	0.00
16	9	-494.76	8.23*	90.23
	15	-372.53	-8.23*	142.95
17	10	-494.76	8.23*	1586.59
	16	-372.53	-8.23*	1817.95
18	11	636.98	-0.00*	-0.00
	17	1097.61	0.00*	-0.00
19	12	-494.76	-8.23*	-1586.59
	18	-372.53	8.23*	1817.95
20	13	-198.66*	-26.65	128.96
	14	198.66*	-37.40	219.60
21	14	198.66*	37.40	-219.60
	15	-198.66*	26.65	-128.96
22	15	1012.37	-31.91	-192.12*
	16	1012.37	-31.91	192.12*
23	16	-198.66*	26.65	-3819.63
	17	198.66*	37.40	-4786.33
24	17	198.66*	-37.40	4786.33
	18	-198.66*	-26.25	3819.63
25	13	1012.37	31.91	192.12*
	18	1012.37	31.91	-192.12*
26	14	-2330.75	-0.00	-0.00*
	17	-2330.75	0.00	0.00*

27	12	-441.18	-13.50*	-178.13
	19	-376.31	13.50*	-177.56
28	14	825.82	0.00*	0.00
	20	799.17	-0.00*	0.00
29	15	-441.18	13.50*	178.13
	21	-376.31	-13.50*	177.56
30	16	-441.18	13.50*	1809.56
	22	-376.31	-13.50*	1675.17
31	17	825.82	-0.00*	0.00
	23	799.17	0.00*	0.00
32	18	-441.18	-13.50*	-1809.56
	24	-376.31	13.50*	-1675.17
33	19	-176.06*	-79.79	212.42
	20	176.06*	-107.29	302.26
34	20	176.06*	107.29	-202.26
	21	-176.06*	79.79	-212.42
35	21	887.66	-82.22	-150.72*
	22	887.66	-82.22	150.72*
36	22	-176.06*	79.79	-3416.88
	23	176.06*	-107.29	-4194.03
37	23	176.06*	-107.29	3416.88
	24	-176.06*	-79.79	4194.03
38	19	887.66	82.22	150.72*
	24	887.66	82.22	-150.72*
39	20	-1815.54	-0.00	0.00*
	21	-1815.54	0.00	-0.00*
40	19	-335.29	-15.94*	-186.58
	25	-336.75	15.94*	-179.93
41	20	664.25	0.00*	-0.00
	26	679.82	-0.00*	-0.00
42	21	-335.29	15.94*	186.58
	27	-336.75	-15.94*	179.93
43	22	-335.29	15.94*	1590.98
	28	-336.75	-15.94*	1499.08
44	23	664.25	-0.00*	-0.00
	29	679.82	0.00*	-0.00
45	24	-335.29	-15.94*	-1590.98
	30	-336.75	15.94*	-1499.08
46	25	-179.70*	-137.28	272.28
	26	179.70*	-184.83	353.34
47	26	179.70*	184.83	-353.34
	27	-179.70*	137.28	-272.28
48	27	698.61	-140.38	-126.06*
	28	698.61	-140.38	126.06*
49	28	-179.70*	137.28	-3182.84
	29	179.70*	184.83	-3838.72
50	29	179.70*	-184.83	3838.72
	30	-179.70*	-137.28	3182.84
51	25	698.61	140.38	126.06*
	30	698.61	140.38	-126.06*
52	26	-1402.72	-0.00	-0.00*
	30	-1402.72	0.00	0.00*

53	25	-182.15	-19.04*	-218.41
	31	-239.45	19.04*	-293.52
54	26	362.48	0.00*	0.00
	32	479.72	-0.00*	0.00
55	27	-182.15	19.04*	218.41
	33	-239.45	-19.04*	293.52
56	28	-182.15	19.04*	1557.70
	34	-239.45	-19.04*	1889.31
57	29	362.48	-0.00*	0.00
	35	479.72	0.00*	0.00
58	30	-182.15	-19.04*	-1557.70
	36	-239.45	19.04*	-1889.31
59	31	-218.34*	-235.54	88.13
	32	218.34*	-306.72	275.12
60	32	218.34*	306.72	-275.12
	33	-218.34*	235.54	-88.13
61	33	457.79	-216.49	-205.39*
	34	457.79	-216.49	205.39*
62	34	-218.34*	235.54	-2094.70
	35	218.34*	306.72	-3218.28
63	35	218.34*	-306.72	3218.28
	36	-218.34*	-235.54	2094.70
64	31	457.79	216.49	205.39*
	36	457.79	216.49	-205.39*
65	32	-916.40	-0.00	-0.00*
	35	-916.40	0.00	0.00*

AN EXAMINATION OF THE EFFECT OF
DIFFERENTIAL SETTLEMENT ON FRAMES

by

DSCHAUYIEN KU

Diploma, Taipei Institute of Technology
Taipei, China, 1962

AN ABSTRACT OF A MASTER'S REPORT

submitted in partial fulfillment of the
requirements for the degree

MASTER OF SCIENCE

Department of Civil Engineering

KANSAS STATE UNIVERSITY
Manhattan, Kansas
1971

ABSTRACT

Conventional structural design of a frame structure involves computation of stresses in the members for the conditions without differential settlement. It is evident that differential settlement has a great effect on the stress in the members of a structure. Differential settlement must be considered for most structures unless the foundation is supported by solid rock. The building will be safer if the design of both superstructure and foundation take into account the reactions and moments yielded by differential settlement.

A series of analyses were made for the parts of an actual reinforced concrete building, Haymaker Hall at Kansas State University, to examine the effect of differential settlement on a structural frame. The analyses were performed by using STRUDL II, a computer program developed at Massachusetts Institute of Technology, with the help of the IBM 360/50 computer.

Moments were determined which were induced in the members of one- to five-story, one- and two-bay, plane and space frames by the action of one inch settlement at selected supports for different frames.

Moments induced in members of various frames were presented and the effects were discussed. Variations of moments in the corresponding members at the same joint in one- to five-story configurations were drawn and the effects on the members were compared.