

USING PATTERN LANGUAGE FOR A SINGLE FAMILY HOUSE: TEACHING A
BEGINNING ARCHITECTURE DESIGN STUDIO AT KABUL UNIVERSITY, FACULTY
OF ENGINEERING, DEPARTMENT OF ARCHITECTURE

by

HEMAYATULLAH AZIZI

B.Sc., Kabul University, 2000

A THESIS

submitted in partial fulfillment of the requirements for the degree

MASTER OF SCIENCE

Department of Architecture
College of Architecture, Planning and Design

KANSAS STATE UNIVERSITY
Manhattan, Kansas

2011

Approved by:

Major Professor
Donald J. Watts

Abstract

This thesis assesses concepts of architectural education both globally and regionally but ultimately presents a pedagogy aimed at the special needs of Afghan architectural education that will serve the needs of Afghan society. It is the author's hope that this thesis may aptly establish the first steps for a renewed architectural education at Kabul University, Kabul, Afghanistan. The essence of this thesis presents a carefully reasoned and detailed educational strategy for teaching beginning architectural design.

The new curriculum in the Department of Architecture at Kabul University requires new syllabi to achieve higher academic standards. The new design course syllabus should address the existing problems of Afghan society. This thesis begins by understanding the context and the current problems confronting the Kabul University Department of Architecture. It is by understanding these problems that I can begin to identify a solution. Understanding the Kabul Municipality rules and regulations, familiarity with beginning design terminology, a carefully stated and sequenced course description promoting gradual student improvement, understanding interrelationships between the interior spaces, environmental sustainable design, and finally introducing a new generation of conscientious architects to Afghan society are some of the main objectives for designing this course. Identifying the best strategy for teaching this course was a primary research question. Christopher Alexander's great work, *A Pattern Language* inspired me to select it as the best methodology for my research.

My early research focused upon the creation of a new syllabus for the first semester of architectural design at Kabul University. This new syllabus was launched during the first semester of 2009 in Kabul where I taught the new course alongside a junior Afghan faculty member. Establishing the new course materials for the first semester set the stage for my primary focus of this thesis. That is the creation of the second semester architectural design course using pattern language as my pedagogical framework. This pedagogy is fundamental for establishing architectural studies focused upon meaningful new academic criteria. The ultimate aim of my thesis is to lay the foundation stone for the reincarnation of Afghan architectural identity.

Table of Contents

List of Figures.....	iv
List of Tables	ix
List of Abbreviations	x
Acknowledgements.....	xi
Dedication.....	xii
Introduction.....	xiii
In Search of A Method for Teaching Contemporary Architectural Design in Afghanistan ...	xiii
Chapter 1 - Identifying the Problem of Architectural Education in Afghanistan.....	1
The Context for a New Architecture for Afghanistan.....	1
Inspiration from some Contemporary Regional Architecture.....	3
The Context of Architectural Education in the Engineering Faculty, Kabul University	4
Chapter 2 – Identifying the Objectives of the First Year Architectural Design Studio.....	8
Lessons from Teaching the New First Semester Architectural Design Syllabus	8
Identifying the Objectives for the New Second Semester Architectural Design Syllabus.....	9
Chapter 3 – Identifying the Strategy for Teaching the Second Semester Design Studio	12
An Introduction to Christopher Alexander	12
What Is A Pattern Language?	13
Choosing Pattern Language as a Research and Teaching Methodology	15
Chapter 4 – Applying the Strategy.....	18
A Pattern Language for Contemporary Single Family House Design in Kabul.....	18
List of Patterns	20
Chapter 5 – Conclusion.....	101
Lessons Learned by Writing a Pattern	102
Pattern Language as a Means for Understanding Architecture	103
Future Research	104
References.....	105
Appendix A –First Design Course Syllabus	110

List of Figures

Chapter 1

- Figure 1. An example of new absurd (Pakistani wedding cake) residential house in Kabul in two of wealthy central subdivisions, Shahr-e Naw and Wazir Akbar Khan. (Photos by the author) 1
- Figure 2. New modern construction in Kabul ignores any influence of Afghan climate or culture. (Drawn by the author, adapted from <http://www.guardian.co.uk/commentisfree/2010/jul/05/afghanistan-property-development-investment-kabul>) 2
- Figure 3. Vittorio Gregotti, Menfi City Hall, Sicily, showing contemporary interpretations of Islamic traditions and thick stone wall that is environmentally friendly. (Photos by Watts, Donald, Professor of Architecture) 3
- Figure 4. Students are working in small groups on their class assignment. (Thinking and drafting an interior section of the 10 meter cube), (Photo by the author) 6

Chapter 4

- Figure 1a. Shahrara’s conceptual detailed master plan. Embedded within this subdivision design are regular city blocks having plots for single family houses. (Drafted by Prof. S. Maqbool and the author) 21
- Figure 1b. Subdivisions of an average size typical block based on Kabul Municipality (KM) regulations (Drafted by the author). 22
- Figure 2a. The impact of rear plot houses’ winter shadow on sidewalks increases when it is wet. (Photo by the author)..... 24
- Figure2b. Minimum sun angle, altitude, on Dec. 21, winter, based on Kabul Municipality calculations (Drafted by the author). 25
- Figure3a. Houses in a neighborhood could be disturbed by an unethical architectural design. (Photo by the author)..... 26
- Figure3b. The first floor of house 2 will not receive winter sun unless there is a setback from the boundary wall for house 1 (Drafted by the author). 27
- Figure4a. House property wall’s private and public Elevations. (Drawn by the author) 28

Figure4b. New imported Pakistani designs with massive constructed walls that influence “aesthetically” the public face of the house (Photos by the author).	29
Figure4c. Boundary wall section and plan shows the height and width. It acts like a rectangular ring around the house (Drafted by the author).	29
Figure5a. A typical house and its relation with courtyard and street. (Drafted by the author)..	32
Figure5b. House section in relation to its surrounding neighborhood (Drafted by the author)..	33
Figure6a. A typical rear plot courtyard house. (Drafted by the author).....	34
Figure6b. House 13, based on KM plot subdivisions is located between house 12 and house 14. (Drafted by the author).	35
Figure7a. Benefits of the landscape positively influences not only the building itself, but also the entire neighborhood. (Drawn by the author).	38
Figure7b. The diagram above shows the influence of the site density on the late afternoon temperatures (heat island effect for central urban areas). (Drawn by the author, adapted from http://www.acca.it/euleb/en/glossary/index.html).	39
Figure8a. The grid type subdivided KM plots provide a healthy environment if the rules are respected by the builders. (Drawn by the author).	41
Figure8b. Identification of courtyard terms. A traditional outdoor storage could be designed in the backyard space, but still a one meter distance is required for providing a setback between storage and house (Drafted by the author).	41
Figure8c. A south oriented courtyard has many significant benefits. (Drafted by the author).	42
Figure9a. A traditional courtyard. (Drawn by the author, adapted from Traditional Architecture of Afghanistan, page 193).	44
Figure9b. A 25m. distance between water well and septic tank gives a healthy result. (Drafted by the author).	45
Figure10a. Plan of first and upper level of a traditional house in Kabul. (Drawn by the author, adapted from Traditional Architecture of Afghanistan, page 185).	48
Figure10c. Rooms Orientation (By author, adapted from Neufert: Architects’ Data, page 272)..	50
Figure11a. Careful design leads the guest to find his way to the particular invited room. (Drawn by the author, adapted from Traditional Architecture of Afghanistan, page 190).	52

Figure11b. Interrelationship between the rooms inside the house. The salon is utilized as a guest room. Arrows in orange color indicate the connected indoor with outdoor spaces. (By the author).	53
Figure12a. A staircase is an important connecting structural element of the house. (Photo by the author).	56
Figure12b. Stairways' width (Drawn by the author, adapted from Neufert: Architects' Data, p. 191).	57
Figure12c. Stairways' minimum space requirements for moving furniture, and handrails. (Drawn by the author, adapted from Neufert: Architects' Data, pp. 192 and 193).	58
Figure12d. A typical house section (Drafted by the author).	59
Figure13a. For providing better and comfortable design spaces our private and social activities should be carefully categorized. (Drawn by the author).	60
Figure14a. A frame structure building (Drawn by the author).	63
Figure14b. Senj framing system used inside the walls and top of the roof. (Drawn by the author, adapted from Traditional Architecture of Afghanistan, p.187).	64
Figure14c. Le Corbusier Dom-ino House, 1914 (Drawn by the author, adapted from Architecture: Form, Space, and Order, p. 132).	64
Figure15a. A local building construction (Photo by the author).	66
Figure15b. An example of material misuse that does not match the environment's climate and physical needs. (Photo by the author).	67
Figure15c. An example of construction drawings. (Drawn by author, adapted from Architectural Graphics, p.36).	67
Figure15d. Sufficient use of local material brings comfort and beauty to the house interior and exterior spaces. (Drawing by the author).	68
Figure15e. Double glazed window benefits. (Drawn by the author).	69
Figure16a. A Kabul typical traditional flat roof design. (Drawn by the author, adapted from Traditional Architecture of Afghanistan, p.186).	72
Figure16b. Basic roof forms. (Drawn by the author, adapted from Neufert: Architect's Data, p. 75).	73
Figure16c. The affect of a green roof upon the environment. (Drawn by the author, adapted from Neufert: Architect's Data, p. 82).	75

Figure17a. Main entrance of a modern Kabul house. (Drawing by the author).	78
Figure17b. A House and its boundary wall elevation from the street view. (Drawing by the author).	81
Figure18a. A brick wall that shows variety of traditional patterns. (Photo by the author).	82
Figure18b. Names of brick surfaces. (Drawn by the author).	83
Figure18c. Common cut brick shapes. (Drawn by the author).	83
Figure 18d. Brick masonry (Drawn by author, adapted from Neufert: Architects’ Data, p. 63)..	84
Figure18e. Common arch shapes. (Drawn by the author, adapted from Masonry Design and Detailing, p. 358).	85
Figure18f. A few examples of common Islamic patterns which are widely used on the building elevations (Drawn by the author, adapted from Sense of Unity, p. 30 and 36).	85
Figure 18g. Sun-dried brick, circa 8000B.C. (Drawn by author, adapted from Masonry Design and Detailing, p. 4).	86
Figure18h. Masonry bonds (Drawn by author, adapted from Neufert: Architects’ Data, p. 67)..	87
Figure19a. A typical modern Kabul house design (Photo by Donald Watts, professor of architecture).	88
Figure19b. “In dry regions the solar load consists mainly of the direct and reflected components. However, reflective glazing can be a problem in all climates.” (Drawn by the author, adapted from Heating, Cooling, Lighting, p.139).	89
Figure 19d. Overheated and under-heated periods of the sun rays in Kabul, Afghanistan. (Drawn by the author, adapted from the original design by arch. Faryad, Aashoqullah, by permission of the author).	90
Figure19e. Some useful strategies that help to protect the windows that are faced south from the overheated sunrays. (Drawn by the author, adapted from Heating, Cooling, Lighting, p. 145).	91
Figure 19g. Many small elements can create the same shading effect as one large device. (Drawn by the author, adapted from Heating, Cooling, Lighting, p. 142).	92
Figure 19h. The sun easily outflanks an overhang the same width as the window. Use a wider overhang or vertical fins on each side of the window. (Drawn by the author, adapted from Heating, Cooling, Lighting, p. 149).	93

Figure19i. Horizontal louvered overhangs both vent hot air and minimize snow and wind loads. (Drawn by the author, adapted from Heating, Cooling, Lighting, p. 149).....	93
Figure19j. Traditional overhang constructed to provide shade as well as to protect the house windows and outer mud walls from the rain. (Photo by the author).....	94
Figure20a. Windows' interior and exterior views. (Building design and photos by the author).	96
Figure20b. Windows dominate the entire exterior wall. An old house that is currently used by Agha Khan Foundation as an office room (Photo by prof. Donald Watts).....	96
Figure20c. Wide windowsills can be used as light shelves to reflect light deep into the interior. (Drawn by the author, adapted from Heating, Cooling, Lighting, p.323).....	98
Figure20d. These plans, with contours of equal illumination, illustrate how light distribution is improved by admitting daylight from more than one point. (Drawn by author, adapted from Heating, Cooling, Lighting, p.322).	98
Figure20e. The size and variation of different windowsills according to the rooms' different activities. (Drawn by the author, adapted from Neufert: Architects' Data, p.177).....	99

List of Tables

Table9c. Interrelationship between interior and exterior spaces. (By the author).	47
Table10b. Rooms' physical interrelationships (By the author).	49
Table13b. A semi-private condition occurs when a space is, particularly, occupied by the female inhabitants. Preferably, the second floor bathroom(s) is used by females because it provides more privacy. (By the author).	61
Table15f. Benefits of using double glazing glass. Such glass should be used in modest amounts to reduce both material and energy costs. (www.glassnetwork.com).	70
Table 16d. Roof Structures (By the author, adapted from Neufert: Architects' Data, p.72).	76
Table19c. Examples of fixed shading devices. (By the author, adapted from Architectural Graphic Standards, 2000, p.827).	90
Table19f. Outdoor building overheated and under-heated period (Prepared by Aashoquallah Faryad, by permission).	92

List of Abbreviations

KM = Kabul Municipality

APL= A Pattern Language

mm. = Millimeter

cm. = Centimeter

m. = Meter

Acknowledgements

Professor Donald Watts has been the ideal thesis supervisor. His sage advice, insightful criticisms, and great patient encouragement aided the writing of this thesis in innumerable ways. I would also like to thank my minor committee members, advisors, and other Kansas State University professors from whom I received productive knowledge during my studies. Their steadfast support of this thesis was greatly needed and deeply appreciated.

Dedication

This thesis is dedicated to my Parents; to my father who has always been a source of encouragement and inspiration throughout my accomplishments; to my mother, who continues to learn, grow and develop and who has supported me all the way since the beginning of my studies.

Also this is dedicated to my wife whose motivation and support both physically and spiritually aimed to accomplish my goal. To my sisters who have never failed to give me moral support, for giving all my need during the time I developed my learning system in a quite different environment and for teaching me that even unreachable tasks can be accomplished if it is done one step at a time.

Finally, this thesis is dedicated to all of those who believe in the richness and power of education which I believe, one day, will dominate my entire country.

Introduction

In Search of a Method for Teaching Contemporary Architectural Design in Afghanistan

My responsibility that I have as an educated person is to develop within my profession something fruitful for the future of my country. Bringing the productive result into a non-developed country is only achieved by creating the fundamentals of development that is defined by education. The growth of education lets the Afghan people illuminate the dark corners of society with its quantitative and qualitative aspects. This thesis addresses the important question of how to teach contemporary architectural design in Afghanistan. More specifically, the thesis focuses upon how to teach the beginning architectural design studio. Ultimately, this research presents a process for how to begin to the redefinition of the identity of Afghan architecture.

This thesis builds upon my experiences while mentoring Afghan architecture students at Kabul University in the Department of Architecture during the summer of 2009. The thesis examines the teaching methodology and collaboration between the Afghan architecture professors and myself in reference to beginning design students and courses. The shortages, challenging issues, and other disruptions will be briefly identified to explain the context of teaching a beginning design studio in Afghanistan. This thesis is based on my personal experiences, direct observations, and conversations. Where applicable, I have credited formal and informal sources as an Assistant Professor at Kabul University in the Faculty of Engineering Department of Architecture. I engage beginning design students in second-year studies in the learning of processes, principles, and design vocabulary with the articulation of designs by instrument-aided and freehand drawings, sketching, and model building. I also draw upon experience living and studying outside of Afghanistan. Before teaching the first design studio at Kabul University, I prepared the course syllabus and its requirements as an independent study course with my Kansas State University major professor. I also audited a beginning design course at Kansas State University, College of Architecture, Planning and Design. Furthermore, I observed a full academic session of a beginning design course in a highly ranked American professional architecture program. I have also read a number of journals and articles in order to collect similar situations in other developed countries. All of these sources, and others, are the

ideas that underlie my research. However, this research is experimental because Afghanistan does not have its own specific definition of “a contemporary architectural design”. This thesis constitutes my hypothesis for how to best address this problem. The first chapter presents the context of the problem in three parts:

1. The Context for a New Architecture for Afghanistan
2. Inspiration from some Contemporary Regional Architecture
3. The Context of Architectural Education in the Engineering Faculty, Kabul University

Chapter 1 - Identifying the Problem of Architectural Education in Afghanistan

The Context for a New Architecture for Afghanistan

Afghanistan is a country marked by war, religious fundamentalism, corruption, extreme environmental conditions, and pollution. All resources are limited, when available. These factors have contributed to widespread poverty and a struggling economy, a lack of infrastructure, and deficiencies in education, nutrition, government, and basic human rights. Every aspect of life has been affected. Someone seeking to research and understand the context and tradition of Afghanistan and Kabul University's Faculty of Engineering encounters a complex situation. Kabul University's Faculty of Engineering, in times of stability in the 1960's and 1970's, was the region's leader in engineering, including architectural education. Historical documentation regarding the celebrated Kabul University's Faculty of Engineering tradition is out-of-date or non-existent. Most current architecture professors at Kabul University were trained either under or after the fall of the Taliban. The challenge facing Afghan architecture professors in the Faculty of Engineering is in defining a methodology grounded in Afghan tradition and culture for the built environment. For example, architectural building styles have been imported from Pakistan and do not suit the Afghan four-season climate. By the end of 2001, there were approximately five million Afghan refugees in Pakistan, which included those who were born inside that country during the past twenty years. These statistics give us an idea of the influence



Figure 1. An example of new absurd (Pakistani wedding cake) residential house in Kabul in two of wealthy central subdivisions, Shahr-e Naw and Wazir Akbar Khan. (Photos by the author)

of Pakistani culture and its deep impact into the physical and spiritual body of our country. Indeed, the intensification of this scenario started when this massive flood of Afghan migrants came from our neighbor country, Pakistan, whose history, climate and orientation to the sun is totally different from our country. This is true not only functionally, but also in form. The main problem with imported Pakistani building design is their false interpretation of six vital factors of building design. The terms “historical, economical, geographical, social, religious, and climatic” are included in the essence of architectural design. Thus, the broad question this thesis addresses is: What will be our architectural identity in the future, and how will we implement it in this particular critical time? As a main strategy for the long term this would be an important responsibility for every single patriotic Afghan architect: to enhance the notion of Afghan society by creating the right interpretations of architectural design. Therefore, we can approach the final stage by seeking a stable architectural identity for a war-affected country. There are many challenges that prevent us from reaching our goal. I must focus my attention upon the first steps towards the long term goal of developing an appropriate Afghan architecture. This means, *“Our way is a long way, but we must travel. Everywhere is full of stones and rocks, but we must pass the way”*.(an Afghan poem) My purpose is to reinforce the educational system and start thinking about the ways that guide us to enrich the architectural education as a part of other important educational knowledge that is the first priority of our society.



Figure2. New modern construction in Kabul ignores any influence of Afghan climate or culture. (Drawn by the author, adapted from <http://www.guardian.co.uk/commentisfree/2010/jul/05/afghanistan-property-development-investment-kabul>)

Inspiration from some Contemporary Regional Architecture

Despite the fact that most publications about Afghan architecture focus upon either historical or vernacular architecture, Afghan architectural education must build upon this knowledge by also studying contemporary architectural design that is relevant to either Afghan climate or culture. If we look at the contemporary Islamic buildings in some Middle Eastern countries, obvious lessons can be learned. Recent modern Islamic architecture has entered into a new age of building design and construction. One of the latest examples is the world's tallest building, Burj Dubai. The design is based on Dubai's native desert flower "hemerocallis". Another example is the "Faisal Mosque" named after King Faisal of Saudi Arabia in Islamabad, Pakistan. This mosque was designed by a Turkish architect and planner, Vedat Dalokay, and was completed in 1986. The basic concept for Faisal Mosque is a vernacular tent that is considered the ancient dwelling place for prayers in the Islamic world. In lieu of a traditional dome that was associated with mosques, he created an eight faceted concrete shell that exactly represents a desert tent (<http://www.archnet.org>). Therefore, by looking at these masterpiece designs we conclude that it would be an elegant interpretation to move from traditional, simple designs to a technological contemporary age of building design principles. The problem with our regional contemporary designs is a wrong interpretation by local people of what is considered "contemporary" or "modern". In this chaotic situation, the key answer would be the broad term of "education", and a more precise solution would be "architectural education". However, the positive consequences are not expected in a short term, because establishing a new educational concept requires years and even decades for positive results to be realized. Thus, gathering the brilliant ideas around this notion will create room for reincarnation of noteworthy traditional architecture in contemporary designs.



Figure3. Vittorio Gregotti, Menfi City Hall, Sicily, showing contemporary interpretations of Islamic traditions and thick stone wall that is environmentally friendly. (Photos by Watts, Donald, Professor of Architecture)

The Context of Architectural Education in the Engineering Faculty, Kabul University

More than three decades of chaos, war, and fundamentalism has contributed to Afghanistan's struggling educational system. The Kabul University environment is a unique educational learning opportunity for Afghan students. Most architectural books at the faculty of engineering are outdated and limited in number. After years of patience with the lack of resources, in the summer 2007 the first fifteen updated architectural textbooks were brought to the architecture department by Kansas State University professors. Lack of infrastructure and systems within the university is another challenge for Kabul University. Most semesters begin and end at indefinite times. Usually, it happens at the end of fall semester when the weather becomes cold because there is not a sufficient heating system on campus. Most subjects are taught without having a proper course syllabus. Lack of required discipline to be followed by students, professors, and faculty staff is another problem. Therefore, the numbers of horrible academic miscommunications, shortages and misinterpretations are huge. It will take decades to return to where we have started. Nevertheless, the solution will be to start from a very small corner and give a little light to a dark corner first and then extend it throughout the faculty. Based on this fact, I tried to create a course description as a practical and valuable accomplishment for the beginning design studio. A clearly written course syllabus helps students to remain on their weekly task.

Professors of Kabul University commonly juggle many unusual tasks. They cannot focus all their attention and energy on teaching. The prestigious architecture professors and department at Kabul University has enough esteem and reputation, both historically and academically. However, Afghanistan's instability means many professionals support extended families. For example, one faculty member supported fifteen family members. This means the majority of the Faculty of Engineering professors teach as a supplement to an existing occupation. A Kabul University professor earns approximately four hundred dollars a month for teaching; the same architecture professor can earn five to ten times that working for an engineering firm and construction company. Engineering firms or design companies allow professors to leave their office for one day a week to teach at Kabul University. It means that the firm has the first priority for a faculty professor. The majority of architecture professors at Kabul University have an undergraduate degree. Young professors do not receive any formal training to prepare them for

classroom teaching. Professors, including myself, were teaching without having a clear course objective and course correlation to other classes. The grading system is not according to standard criteria. Meanwhile, most professors teach their classes based on their outside work rather than on an established course syllabus.

One of the outcomes of the Kabul University contract with Kansas State University was a new curriculum for the department of architecture. The new curriculum called for students to use study models as part of their design process. Model making materials are in short supply in Afghanistan. Kansas State students generously donated such supplies that arrived at Kabul University in the summer 2007. During the summer of 2009, I spent three months teaching the beginning design course according to the new course syllabus. This had a great influence on professors' ideas and encouraged them to start working on their individual course manuals. Architecture department professors were encouraged by Kansas State professors, Professor Donald Watts, Professor Dr. Carol Watts, and Assistant Professor Katrina Lewis, to consider continuing their professional studies and pursuing a master's degree outside of Afghanistan. As a product of this, the World Bank Grant project, as a fund provider, supported the future of higher education in Afghanistan and encouraged professors to obtain master's degrees. Based on the contract, three of the members of the Architectural department, including myself, are at Kansas State University to achieve their master's degrees. Our master's degrees will be a great achievement for the future of the entire Department of Architecture at Kabul University.

Students have received the worst impact during the disastrous decades of civil war inside Afghanistan. They struggled greatly during their educational career from the limited resources like textbooks, supplies, and materials. Meanwhile, they suffered from the other social, economic, cultural, ethical, familial, feminine conflicts. Unfortunately, these barriers still exist. Enrollments to the various faculties and departments are based upon chance and social contacts that are signs of governmental corruption in the larger scales. They are enrolled based on their Concord Examination, an annual national test score rather than their interests and talents. Afghan high school graduates receiving the highest Concord scores are provided a tuition free college education. Freshmen wrongly believe that only civil engineers receive important jobs, respect and money. They therefore resist being assigned to study architecture. Despite restrictions for students to change their major once they are registered, they often request to move from one major to another back and forth. Faculty rules have not solved this dilemma. Habits of rote

learning discourage independent thinking which is critically important for architectural design. The beginning design students are more focused on learning technical aspects of a project rather than design principles.

This is caused by the professors' teaching methodology coming from the construction companies where most professors work. For instance, beginning design students are interested on learning how to illustrate the details of a window and its related design vocabulary, rather than strongly focusing on design principles and vocabulary. It is important to separate the teaching materials of a design course from a construction course. The upper level design students confront the same problem because their foundation has been built upon the same methodology without well written course syllabi.

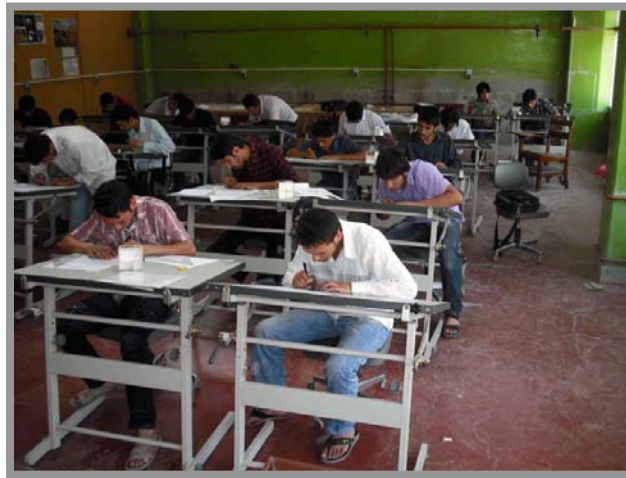

Figure4. Students are working in small groups on their class assignment. (Thinking and drafting an interior section of the 10 meter cube), (Photo by the author)

Essentially, architectural design studios in the faculty of engineering are influenced by the impact of limited access to material, inadequate teaching methodology, and inappropriate study and working atmosphere. In summer 2007, the new donated architectural materials were placed in a storage room isolated by a secure fence from the class area. Professors and students widely started using these materials for constructing their models. In summer 2009, when I spent almost two and half months teaching for the first time the new architectural design course, I tried to find easier ways to build a model during the studio hours. I helped the students improve skills using glue, x-acto knives, chipboard, basswood, and other materials to build their models. All students throughout the program prefer drafting or drawing on the computer rather than

sketching. This preference stems from a faulty interpretation of computers. Students think that the trends have changed and there is no need for freehand sketching anymore. Instructors graded sketching skills using quizzes in which students would stand and produce a sketch in a limited amount of time. This method of evaluation is not used in relation to a fundamental component of design. With great enthusiasm, some local non-governmental organizations (NGOs) and construction companies have established a technical relationship with the department. They provide paper and other supplies in an infrequent manner. The Aga Khan Trust for Culture and the Turquoise Mountain Foundation promote good communication with the department students and professors. Some adjunct professors with regular jobs outside of the university teach as volunteers in the department. They really dedicate their precious time teaching the advanced design classes in the department. Dr. Wasay Najimi provides on and off campus teaching related to ongoing projects of Aga Khan. He is one of the most experienced professors. I strongly suggest collaborations between local architectural institutions for enhancing the level of qualified architectural education and enhancing professional practice. Such collaboration will implicitly encourage competition among professors and students to raise the standards of architectural education and practice in Afghanistan. Currently, there are only two architecture institutions, Kabul University Faculty of Engineering, Department of Architecture and Faculty of Architecture, Polytechnic University.

Chapter 2 - Identifying the Objectives of the First Year Architectural Design Studio

Lessons from Teaching the New First Semester Architectural Design Syllabus

Creating the new curriculum for the Faculty of Engineering, Department of Architecture marked the first step for the development of architectural education at Kabul University. Designing individual course syllabi is the second important step towards this institutional achievement. In the summer of 2009, my major advisor and Kansas State University professor and I co-designed the new first semester second-year design course. This was created to help develop a stronger foundation for the program and it is based on urgency as a first tool for architectural education. This course introduces principles, processes, and vocabularies for depicting constructed form and space, with its functions added to the course syllabus for the second semester. Students use a (10x10x10) cm. cube which is assuming a nine square grid cube in order to better understand how to create an architectural space. Students also use precedent study incorporating plans, elevations, sections, isometrics, oblique, perspectives, and diagrams. In the process of designing this new architectural design course with my Afghan colleague and young assistant professor, I shared some of my observations that I had gathered over the course of a spring semester at Kansas State University, Department of Architecture. We identified issues within the overall curriculum that needed to be introduced in the second-year, assisted in defining the semester exercise, and created a rationale for the course. The student learning outcomes for the course included:

(1) To create an environment of learning focused on drawing through the use of freehand sketching and instrument-aided methods.

(2) To provide an introduction to the techniques of two and three-dimensional visualization of spaces, with an emphasis on drawings that communicate clearly and effectively.

(3) To reinforce the use of various types of drawings introduced in the first year Architectural Drawing Studio.

(4) To teach the students how to imagine and create a three dimensional space in their minds and then to transfer the ideal conceptual design onto a sketch paper.

(5) To start thinking about design of a space, not a unique residential house, the way they are doing now, and developing their ideas for further studies about “space design”.

(6) To teach them to think about the significance of architectural design from both physical and psychological aspects.

(7) To teach the students the significance of some Middle Eastern architectural terms which are important for creating the verbal foundation of a beginning design studio.

(8) To use the new materials that are donated by K-State University students for building their models according to their individual and group designs.

The new course was designed with a syllabus, a semester exercise, a check out paper of the tools for the semester, and a teaching calendar. It was important to create a flexible plan that allowed for unknown constraints. Teaching calendars had to be designed to take into account whether the class would be taught once or twice a week; however, I realized that class activities need more time to practice and see the students' improvements. I suggested that future instructors who are involved with teaching this class should extend the time for teaching this class. Course materials for this first semester architectural design studio are to be found in the appendix of this thesis.

Identifying the Objectives for the New Second Semester Architectural Design Syllabus

The second design course will introduce more architectural design terms, standards, and ideas that will enhance and develop the students primary design knowledge. It will build upon the first design course where students have learned space definition and other related principles like void and mass. The objectives for the new second semester course will be:

- A.** Acquaintance with the current laws and regulations (land use and KM plot subdivisions) based on what has been used for the design of houses in Kabul.
- B.** Understanding that individual attributes of architectural design possess physical, socio-cultural and aesthetic reasons for their existence.
- C.** Understanding that the interrelationships of the individual design attributes occur at a multitude of scales.
- D.** Understanding that architectural design is embedded within a totality of design extending from the minute structure of individual materials to the particular impacts of the sun upon any given design.

E. Introduction to a design process that supports the discovery and development of a contemporary Afghan architectural identity.

The Kabul Municipality has a set of regulations established years ago that has not been updated based on demands for new modern house design. Rules always need to be updated according to the current circumstances. The second design course is when the architecture students start to learn important design terms. This is not possible without understanding the current regulations. Students are not expected to memorize the complete package of KM law, but the intention is to study the rules and start their primary conceptual designs within the existing plot subdivisions. It is also important for professors to create an educational relationship with KM and other related ministries, architects and engineers. It helps them exchange their knowledge in order to improve the future of architectural education.

Good design requires design concepts and terminology that need to be studied, learned, and used in a correct and precise manner. The new design course will allow students to fully engage with the new terms that are used in architectural design. This is an ongoing process that needs to be regularly updated by professors and advanced architects. Students will study good examples versus the existing chaos that has been experienced for ten years. Familiarity with design terminology helps the students to study and evaluate international architectural literary works based on what they learn from the design course. It also helps the students to be not limited by the local design terms. They are expected to think abstractly and imaginatively.

Better learning requires a sequenced course design. The design course has to be established based on a step by step pedagogical method. Since this course is a beginning design studio students are not able to get all of the strategies and learning materials at once. The objective is to gradually improve the basic design knowledge of the students. Unnecessarily imposing many ideas upon the students all at one time has negative impacts on their further accomplishments. Creating designed spaces by the students own desire helps them to realize how important space design is. It is only possible by their daily experience that allows them to interact with their surrounding environment. Therefore, gradual improvement has its long term benefits for both students and professors.

Based on what the students learned from the first design course about the definition of space and its significance in architectural designs, the second design course will teach how to connect these spaces. The house not only consists of internal interconnected spaces, but is also

connected with its larger surroundings. This gives the design cultural meaning. The mass and void spaces significantly impact the interrelationship between the interior spaces. Therefore, these spaces should be studied from different points of view. Psychological needs are as important as physical needs. In other words, according to Roman architect Vitruvius in the early 1st century, a good building should satisfy the three principles of *firmitas, utilitas, venustas* which translate roughly as durability, utility, and beauty. These ancient terms and many new architectural words like economy, sustainability, and environment bring inhabitants of the house both physical and psychological comfort. A modern Kabul house is constructed within a boundary wall. Both the relationship between house spaces with its courtyard and the courtyard with public spaces should be studied.

A good start of the course is always appreciated by the students and professors in an academic atmosphere. Today's architecture students are tomorrow's advanced architects who have the responsibility to bring beauty and comfort to the city. We are not able to compensate for our mistakes by returning to the past. We must be able to take advantage of our time and plan for our future. Finding better strategies brings fruitful results in the long term; therefore, it is important to be consistent and recognize what has the best results for the development of architectural studies. Designing an ideal syllabus is the first step towards a successful architectural education which is only possible by a careful selection of the study materials. In addition, the sequence between individual design courses is also important. The faculty must eventually create new course descriptions for all of the architecture department design courses. The final goal is to introduce a new generation of conscientious architects to Afghan society. Such architects will be better prepared to develop a new and appropriate Afghan architectural identity.

Chapter 3 - Identifying the Strategy for Teaching the Second Semester Design Studio

An Introduction to Christopher Alexander

I have chosen Christopher Alexander's *A Pattern Language* for my research methodology and teaching strategy. Therefore, I am first going to write about Alexander's biography and significant works towards his career as a successful architect and educator.

Christopher Alexander was born in Vienna, Austria in 1936 and grew up in England. He holds a Bachelor's degree in Architecture and a Master's degree in Mathematics from Cambridge University. He also holds a PhD in Architecture from Harvard University. Alexander moved to the United States in 1958 and since 1963 he has lived in Berkeley, California. He taught architecture at the University of California, Berkeley, where he is now an Emeritus Professor of Architecture. Alexander is the president of the Center for Environmental Structure which he founded in 1967. He is the creator of the pattern language theory in architecture and in computer science. He is also the principal author of the famous book *A Pattern Language* published in 1977. Alexander has designed and built more than two hundred buildings on five continents, particularly, in California, Japan, and Mexico. Most of his work has heavily utilized technological innovations designed to build a living architecture, especially for the use of concrete, shell design, and contracting procedures. Alexander has introduced the new form of architecture by looking to the future, but having the roots in the vernacular. He has served his life as a consultant to cities, countries and national governments across the world and has advised corporations, government agencies, architects and planners. Since 1996 he is a member of the American Academy of Arts and Sciences and a member of the Swedish Royal Society. He has received a number of architectural prizes and honors, including the gold medal for research from the American Institute of Architects in 1970. He is now retired from teaching, but continues to be active in his career.

Christopher Alexander is the author of many well-known books and essays. These include: *Notes on the Synthesis of Form*, *A Pattern Language: Towns, Buildings, Construction*, *Timeless Way of Building*, *The Production of Houses*, *A New Theory of Urban Design*, *A Foreshadowing of 21st Century Art: The Color and Geometry of Very Early Turkish Carpets*. Alexander's most known, widely admired, and quoted book is *A Pattern Language*.

What is A Pattern Language?

Christopher Alexander's pattern languages are abstract design tools that have been in use in architecture and urban design for the last thirty years. Pattern language is a network of patterns that model the interplay between design and social interaction in order to create a range of design solutions (Erikson, 1997). It is a valuable resource for refining and inspiring beautiful and responsible design and promotes good design thinking at every level of scale. Alexander in his book *A Pattern Language*, in collaboration with Sarah Ishikawa and Murray Silverstein, tried to teach how an elaborated set of patterns empower everyone to design and build at any scale. *A Pattern Language* is perhaps the first complete book written in hypertext fashion. In the year 2000, he established the PatternLanguage.com website and became the chairman of the board. "In these postmodern times of distortional post-structural theories and cynical de-constructivist designs, Alexander's work is a beacon illuminating a way to make the world more robust, beautiful, and kind... this vision and work may well inspire a new generation of practitioners and thinkers, and so a virtuous circle may proceed." (David Seamon, Professor of Architecture, Kansas State University). More recently, pattern language has been adopted by other technology related design disciplines. Pattern languages have extensively been used in object-oriented computer programming (Gamma et al, 1995), interaction design (Erikson, 1997), and more recently games design (Kreimeier, 2002). "Why we called it 'A Pattern language' with the emphasis on the word 'A,' and how we imagine this pattern language might be related to the countless thousands of other languages we hope that people will make for themselves, in the future." (APL, p. xvi) Alexander's developed list of 253 patterns shows how architecture connects people to their surroundings in an infinite number of ways, most of which are subconscious. A Pattern Language is a structured method of describing good design practices within a field of expertise. "Pattern Language offers one practical means for translating feeling into action and environmental concern into environmental design." (G. Coates & D. Seamon, p.332). The significant value of this methodology is that a majority of people with ordinary intelligence can use the method of APL to effectively solve a vast design problem. Alexander clarifies that pattern language like other languages consists of vocabulary, syntax, and grammar that eases the process of understanding. "A pattern language gives each person who uses it the power to create an infinite variety of new and unique buildings, just as his ordinary language gives him the power to create an infinite variety of sentences." (*The Timeless Way of Building*, p.

xi) Since more than thirty years has passed from APL publication, probably most of statistics have been changed as it is dated, but the philosophical approach is still stable. It is very unfortunate that thirty three years after APL's publication, there are architects and designers who have never heard of his work. Therefore, I want to introduce this valuable book especially to the Afghan architecture society of students, professors, and architects.

I chose APL's methodology for my research because the sequence of the patterns teaches us a number of lessons which give us a precise study method. Based on APL methodology, "patterns are ordered, beginning with the very largest, for regions and towns, then working down through neighborhoods, clusters of buildings, buildings, rooms and alcoves, ending finally with details of construction." (APL, p. xii) The largest-scale pattern in my developed patterns for the second semester design studio is a Kabul Municipality block. These subdivision plots normally consist of twenty plots. I created the beginning design studio's list of patterns based on a language that is acceptable for all design students to speak and understand. The essence of these patterns is that they are designed as a set of twenty most important patterns for beginning architectural education.

My patterns are presented as a straight linear sequence that is appropriate for my teaching objectives. The beauty of these patterns is the sequence based on their connection to each other. The first and largest pattern is the KM block subdivision. Then, gradually this sequence goes to more elaborate details; design concepts and other recommended construction materials. As the patterns evolve into more detailed patterns the quantity of information grows. Each pattern describes a specific attribute of the house or its surrounding environment. In order to understand the significance of individual patterns the same overall format of the patterns has been maintained. First, the title of the pattern describes the pattern together with a particular number. Second, a picture for more clarification of the pattern has been shown that frequently illustrates the existing circumstances, whether good or bad. Third, with a bold headline, in two or three sentences the essence of the pattern is given. Then an introductory paragraph talks about the context of the pattern. My research presents each pattern from three essential perspectives that are the most fundamental components of design. These are basic design factors, physical factors, and socio-cultural factors. At the end of each developed pattern, for additional studies, a series of resources and references are listed. Within the text of each pattern, charts and diagrams as well as pictures are added for more clarification of the pattern's theme. This format is repeated in

order to simplify the language of the pattern and promote better understanding. This format is also very useful for the students' future practical design and construction work.

Choosing Pattern Language as a Research and Teaching Methodology

Using APL methodology for my research directly answers my teaching objectives identified in chapter two. Understanding KM's regulations allows the students to start from an existing situation. The students need to understand and obey the current planning laws. My APL format presents some important laws in a better method that helps students to remember it in the long term. The logic of the APL format, reinforced with pictures, helps professors explain in a better manner and students remember it. The other benefit of APL is its reference part that helps them to browse for further studies upon the particular pattern theme. The internet facility available at the Kabul University Faculty of Engineering allows the students to find additional related information to thousands of web sites. That is why some online sites are also included in the list of references.

Another advantage of the APL format is its smooth, well organized classification of the patterns that structures the class schedule. For instance, for the whole package of the patterns if we spend one class hour on each pattern we need 20 days which is appropriate based on the course schedule. Basically, a design course studio offers two days in a week, and the length of a normal semester in Kabul University is about 16 weeks. Students will receive a copy of the pattern prior to coming to class so they have a chance to review the pattern. They highlight and note the new words and terms in order to participate actively in class. Therefore, as the patterns develop, the design terms are slowly added to the students' academic terminology. According to Alexander, "A pattern language has the structure of a network." (APL, p. xviii) All the information is not included in an individual pattern because for this course it would be unwise to put all of the new design terms together at once.

The essence of an APL method is its step by step creation of individual patterns. "The sequence of patterns is both a summary of the language, and at the same time, an index to the patterns." (*A Pattern Language*, p. xix) This methodology achieves my important objective which is a step by step learning process. It has been tested for years in academic environments that a sequenced course schedule creates productive outcomes. Therefore, the written patterns are concrete and specific and can be interlocked and extended like a language in unlimited ways.

Students daily experiences from their environment teaches them to react with their surroundings in the same manner. It means that sequenced learning process acts like a chain or prayer beads that connect to each other in a regular means, but represent one idea. The history of humankind has not emerged at once, but gradually. Therefore, improving the learning procedure requires regular sequenced study.

Understanding the relationship between spaces has a significant role in architecture. Unfamiliarity with our surrounding ecology, whether nature or society, turns us into a rigid body that does not fit anything. “Alexander argues that we must understand how people and place mutually relate in both constructive and destructive ways.” (Gary J. Coates and D. Seamon, p. 350) It means if we, as a part of “whole”, do not know how to interact with our surroundings we will amortize the environment. In addition, it has a great impact upon the ethics of the society as a whole. Alexander defines wholeness as: “the source of coherence in any part of the world” (Alexander 2002a, p. 90) The main aim is to understand how the parts of a made thing, whether a crafted object, art work, building, neighborhood or city appropriately work together and have a fitting place within the whole. A pattern language format teaches us how to achieve this goal. We are not the abstract, independent owner of our property but have a circle of responsibilities that limits our unrestrained freedom.

According to Coates and Seamon, one of the advantages of APL is that it transfers design into a shared learning process. This allows environmental design and management to become an ongoing part of the particular project (G. J. C and D. S, p. 349). This thesis develops particular patterns appropriate for the students’ assigned design project. Students learn the methodology of APL and use it as a design tool. Through learning this methodology, they can also apply it in future studies and practice. It sparks the student’s mind to combine theory with practice, and teaches the importance of research in the design process.

Alexander argues that each place requires its own pattern language. (APL, p. xxxviii) Thereby, it helps the students to understand the value of space related to place. Generating a list of patterns with specific numbering, for better identification of the patterns, helps the students to understand the value of each theme. There are psychological, cultural, and environmental problems as well as physical problems that need to be classified for individual recognition. We cannot heal any disease without a precise diagnosis of the particular problem. The proposed APL methodology integrates fundamental design factors to create better solutions that have a positive

environmental impact. The methodology of APL begins to develop an Afghan architectural education dedicated to finding our Afghan architectural identity.

Chapter 4 – Applying the Strategy

A Pattern Language for Contemporary Single Family House Design in Kabul

Why is a contemporary single family house a good subject for the second semester architectural design course? Mankind started searching for better ways of life that provided a secure, safe, and comfortable place for living. They generously shared their cultural history in order to improve their environmental condition. Primitive man needed a safe space for his vital activities like eating, sleeping, and protection from the fury of nature, animals, and enemies. Louis Kahn says, “It is good for the mind to go back to the beginnings because the beginning of any established human activity is its most wonderful moment.” (A. Szabo and T.J. Barfield, p. xix). Later, as the quality of life improved and man learned the new ways of life, the definition of shelter also changed. This living space has meant not only a secure place for living, but other important values imported from the prehistoric cave. Durability, psychology, economy, sustainability, and aesthetics are some of the most noteworthy terms that gradually entered into this morphology of life. Therefore, the house carries numerous significant values.

Afghan vernacular architecture also had its ups and downs during its history. The traditional Afghan *qala* is considered an indigenous kind of courtyard house in Afghanistan. These housing clusters were surrounded by massive *pakhsa* (pressed mud) walls that represented ancient fortifications. (A. Szabo and T. J. Barfield, p. 141). Probably the *qala* is the only housing type similar to today’s single family courtyard housing. Single family house, single detached dwelling, or separate house are some of the names used for this type of residential design that are not attached with other buildings. A single family house is an opposite name for a multi family dwelling. The Kabul Municipality subdivides new urban land into a grid of streets and urban blocks. Each block is commonly divided into an average of twenty single house plots. A single family house means that the building is only occupied by one household or family; however, in an Afghan traditional house there are more inhabitants (parents, brothers, sisters; based on the size of the house). A boundary wall isolates the house property from the public and neighbors’ property. This wall also provides secured and private space for the households. This will be discussed in detail in the first forthcoming patterns.

Based on discussions with senior faculty there are many schools of architecture that use a contemporary single family house as a primary design project for the beginning design studio. A house has several important reasons for being the first project. Students are familiar with their surrounding environment where they have grown and experienced their first steps of life. They understand their house spaces and know how to define the relatively interconnected parts. They recognize dimensions and some design advantages as well as disadvantages because they have lived within this space for a long time. This experience helps them identify design problems in a better and more conscious method. Houses are microcosms of larger scale architectural projects. Houses are small in size but contain many important design lessons. The design of a house is a complicated issue. It requires understanding individual family members' physical and psychological needs and requires concise study and sufficient time, even for professional architects. Houses are more unique in design rather than the design of public buildings. Students also learn from the variety of furniture and fixtures that are used in a house; understanding the human scale, dimensions, proportions, form and function. Studying the other types of houses like, duplex, triplex, multi-family apartment building, attached, semi-detached houses could be found in the advanced design course syllabi.

For Afghan students, the model contemporary single family house is located in Kabul because the capital city confronts many problems. Uncontrolled population, pollution, security, and other environmental impacts have caused many serious problems for inhabitants. Architecture students must be critical of foreign designs introduced in Kabul. The existing image of the capital and the non uniformity and lack of architectural identity is a shocking picture to an observer. Kabul, as a symbol of the country, needs adequate research for its unique design, physical and socio-cultural problems. My research has created twenty specific patterns that identify crucial design criteria for a contemporary single family Kabul house. These patterns will serve as valuable lessons for beginning design students and establish a rigorous method by which architectural design will be studied in the Department of Architecture, Kabul University.

List of Patterns

1. Typical New 500m² Plot Urban Housing Blocks in Kabul City
2. Sunny Winter Sidewalk
3. Allowing Sunlight into Neighbor's Courtyard
4. Property Boundary Walls
5. House Cross-section in Relation to Courtyard and Neighbors
6. Mass/Void Relationship of Houses and Courtyards
7. Landscape Impacts upon the Microclimate of the Neighborhood
8. Zoning the Courtyard
9. Zoning the House in Relation to the Zones of the Courtyard
10. Internal Zoning of the House
11. Zoning the House in Relation to the Zones of the Courtyard for Family and Guests
12. Vertical and Horizontal Circulation
13. Degrees of Publicness for Internal Household Activities
14. Primary Structural Systems for a Contemporary Kabul House
15. Primary Structural Materials for a Contemporary Kabul House
16. Roof Design
17. The Form of Primary and Secondary Elevations
18. Exterior Finish Materials for Primary and Secondary Elevations
19. Overhanging Slabs (shading devices) and its relation to the House
20. Windowsill and its Significance

1. Typical New 500m² Plot Urban Housing Blocks in Kabul City

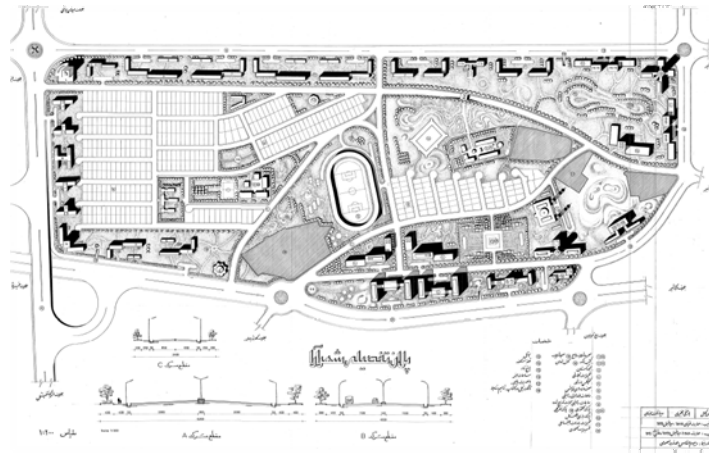

Figure 1a. Shahrara's conceptual detailed master plan. Embedded within this subdivision design are regular city blocks having plots for single family houses. (Drafted by Prof. S. Maqbool and the author)

Based on historical documents it would be reasonable if we have a block of ten plot divisions in a series of two rows which becomes a total number of twenty plots that are surrounded by minor streets.

The urban planning procedure of plot blocks is a common design strategy in numerous Islamic Middle Eastern countries; however, in most parts of the Arab world it is not organized as (Figure 1b) shows. According to the 1978 Kabul Master Plan and elaborated in Kabul Municipality regulations, the subdivision of residential areas are formed, mainly, in (25m x 12m)=300m², (20m x 20m)=400 m², and (25m x 20m) = 500 m² urban blocks. While in older distributions of the land there were larger geometric subdivisions like 800 m², and 1000 m² new subdivisions are limited to 500m².

Basic Design Factors:

First take one plot out of a block division and point out the dimensions and then multiply it by ten and two for finding the length and width of one city block.

Length of block = (20x10) m. = 200m.

Width of block = (25x2) m. = 50m.

It is understandable that a maximum of 200 meters for a minor street with a 12m width, including two walkways, will make a good subdivision.

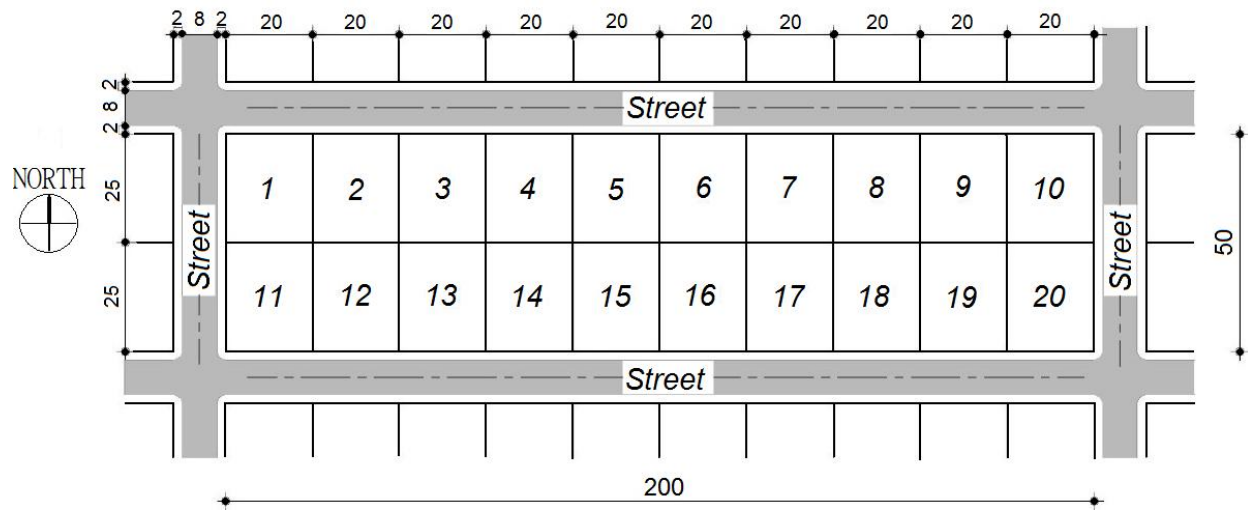

Figure 1b. Subdivisions of an average size typical block based on Kabul Municipality (KM) regulations (Drafted by the author).

Physical Factors:

The individual plots include space for a house design, hard-scape, a courtyard, and landscape. This provides for natural ventilation and north-south orientation and is a good design concept. Based on the sun orientation individual rooms of a house could be designed and placed according to their functions. It means (25 x 20) dimensions is a rectangle that gives a variety of design options with the depth of the plot oriented north and south. This would include a courtyard as a focal point for the landscape of the house. Ideally, maintaining the compass orientation of the block is preferred. However, topographic irregularities of the city land form can cause special orientations.

Socio-Cultural Factors:

This pattern lets the people interact in a social life characteristic of an Islamic society. It means the way these subdivisions interact is a kind of social activity that lets the people be aware of their daily activities. It is because Islamic societies are relatively dependent on each other. The pattern promotes both congregation and privacy. Fathy defined tradition as the social analogy of personal habit. Therefore, vernacular architecture should be considered as the mother of contemporary architectural designs. “Placed and built anonymously, the houses express isolation,

lack of relationship, and fail altogether to help create human bonds in which people feel themselves part of the fabric which connects them to their fellow men.” (Alexander, p. 24) In most Islamic countries for thousands of years “congregation” was defined as a base for most social activities. There are many lessons to be learned from togetherness; “unity” will be the first term that traditionally comes from the history of collective built form. Traditional collective built form continued for years until famous architects worked for its reorganization and promoted alternative forms of living. The significance of such subdivisions is important from religious and cultural perspectives.

References:

- Alexander, Christopher. (1985). *The Production of Houses*. New York, Oxford University Press.
- Fathy, Hassan. (1986). *Natural Energy and Vernacular Architecture*. Chicago and London: University of Chicago Press.
- Ministry of Justice. (2000). *Afghan Official Jrydh: Municipality Law*. Ministry of Justice Press. Kabul, Afghanistan

2. Sunny Winter Sidewalk



Figure 2a. The impact of rear plot houses' winter shadow on sidewalks increases when it is wet. (Photo by the author)

Streets and sidewalks are public interconnections like the veins in a human body. Buildings in a residential area should not interrupt public walkways, particularly in snowy cold winters.

In most residential areas of Kabul people suffer while passing beside the higher buildings. During the cold days of winter the building's height does not let the sunshine melt the mass of snow that remains on the ground for days. This creates numerous accidents for people that have to walk through these slippery walkways. The solution for this serious problem would be to reduce the height of the buildings in residential areas, and create rules for designers and building contractors in order to know the "limits" and implement the design precisely. One suggestion will be the height limit of 10 meters, for a single house family.

Basic Design Factors:

The sun elevation or altitude angle in December 21 at 12:00 noon is 31° in Kabul. Recently, in most residential areas of Kabul, people do not follow the governmental regulations. This will cause huge problems in the long term. Basically, the limit of 10 m height provides a better option so that sunshine, figure 2b, reaches the north walkway. It is happening while the sun elevation has its MINIMUM angle; therefore, it means before and after this particular time the sun warmth is gradually expanded on a larger surface of the street.

Physical Factors:

However, as the section diagram, (Figure2b) illustrates the right sidewalk is under the effect of sun warmth which is the south side of the north plot, but it is all right with the left sidewalk as the sunshine affects it in the morning in wintertime. According to Fathy (p. 42),

“For the direct rays of the sun, it is sufficient to know the angles of declination and altitude for the summer and winter solstices (21 June and 21 December, respectively) and the autumnal and vernal equinoxes (21 September and 21 March, respectively), from which the position of the sun at any time of day on any intermediate date can be deduced.”

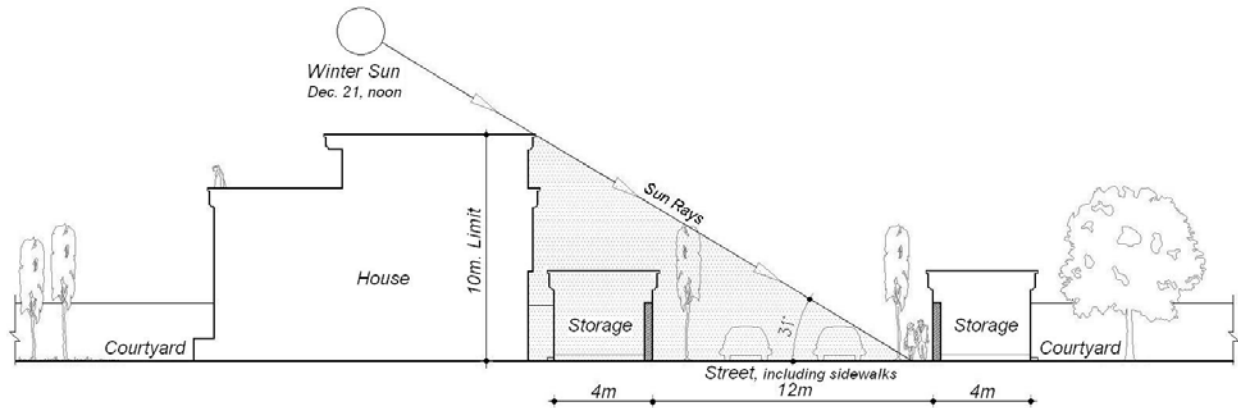

Figure2b. Minimum sun angle, altitude, on Dec. 21, winter, based on Kabul Municipality calculations (Drafted by the author)

Socio-Cultural Factors:

If we look at some Afghan vernacular designs there is a separate, one story building, storage for some extra equipment and other activities like a laundry or guard room, located between the entry wall of a courtyard and the house. If we value this traditional structure as a solution for providing backup to the main building, the winter sun will act more effectively by bringing warmth to the sidewalks. This storage also provides the required privacy for the second and upper floors of the building when people pass the walkways. It will be more effective if the width of the storage building is 5m including a minimum one meter sidewalk between the main building and the storage.

References:

- Fathy, Hassan. (1986). *Natural Energy and Vernacular Architecture*. Chicago and London: University of Chicago Press.
- Ministry of Justice. (2000). *Afghan Official Jrydh: Municipality Law*. Ministry of Justice Press. Kabul, Afghanistan.

3. Allowing Sunlight into Neighbor's Courtyard



Figure3a. Houses in a neighborhood could be disturbed by an unethical architectural design. (Photo by the author)

Despite the fact that residential areas are considered as private properties, it does not mean we can interrupt others rights. Respectfulness in all corners of life is needed among neighbors. Natural resources are a gift of nature for mankind in an equivalent manner.

There are a series of written regulations for society's guidance, but dramatic infractions are getting enlarged. It is because no sufficient inspection is organized for implementation of these regulations. Recently, in most residential courtyards, the setback distance from the boundary wall is not obeyed, creating huge problems of ownership. Jamel Akbar says, "Need and control without harming others have been the main prerequisites for establishing ownership." (p. 26)

Basic Design Factors:

In figure (1b) the subdivisions from 2-9 are the rear side lots with lower cost, from 12-19 are the "front" lots "silver" with higher cost, and 1, 10, 11, and 20 are considered as "golden" in accordance with given variety of design options . Based on Kabul Municipality (KM) given maps, there is a traditional storage design in front of the house 1, figure (3b) in a front type lot which pushes the house footprint area until a one meter distance from the north boundary wall. In this critical seasonal circumstance, Dec. 21, the efficiency of winter sun will be reduced as the shade of house 1 penetrates inside of the house 2, in the first floor. An operational solution is possible by switching the storage to the north wall. This shift, figure (3b) sun rays 2, provides a void space in the back of house 1 so that house 2 will be benefited by the sun warmth.

Physical Factors:

Sunlight provides the enormous source of natural energy that all living species are dependent upon. The sun with its overflowing warmth shines generously to all of its surrounding phenomena. Inevitably, sun rays could be reduced according to seasonal declination angles that provide a variety of negative and positive design options. By assuming the minimum sun rays in a winter short day, the shadow of house 1, figure (3b) could be problematic for house 2. Sunshine could be captured by an appropriate design variant.

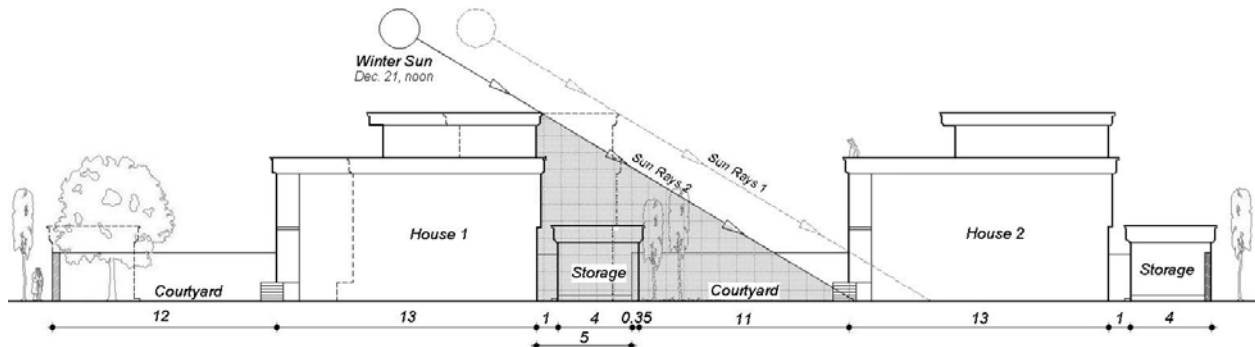

Figure 3b. The first floor of house 2 will not receive winter sun unless there is a setback from the boundary wall for house 1 (Drafted by the author).

Socio-Cultural Factors:

There is a potential conflict between neighboring houses being open to sunlight but lacking visual privacy between each other. As figure (3b) illustrates, many negative social consequences emerge from a face to face building interaction. Frequently it has been seen that based on traditional and religious comprehension, many conflicts have been created. This problem could be solved by consideration of the house 1 setback from the perimeter wall, and minimizing the number and area of the building openings in the north elevation.

References:

- Akbar, Jamel. (1988). *Crisis in the Built Environment: The Case of the Muslim City*. Tien Wah Press, Singapore.
- Brown, G. Z. and DeKay, Mark. (2001). *Sun, Wind and Light*. John Wiley and Sons, Inc. Canada.
- Fathy, Hassan. (1986). *Natural Energy and Vernacular Architecture*. Chicago and London: University of Chicago Press.
- Ministry of Justice. (2000). *Afghan Official Jrydh: Municipality Law*. Ministry of Justice Press. Kabul, Afghanistan.

4. Property Boundary Walls



Figure4a. House property wall's private and public Elevations. (Drawn by the author)

Boundary walls in residential areas are constructed for both security and privacy purposes. These traditional massive walls have to adapt to the other elements of the building. They also act like a transition element between house, street and neighbors as they face not only to the house but also the public.

In a Kabul courtyard, the boundary wall plays an important role for identification of the land layout. A boundary wall physically protects the site from animals, thieves, and gives a psychological privacy to the households. It also serves to demarcate the boundary of the house property. The boundary wall should be built before the construction of the house begins because it can protect the site and the materials which are going to be used for the house construction. It is reasonable to construct the boundary wall with a limited height and width since there is a series of continuous walls shared between neighbors (figure 4c).

Basic Design Factors:

Recently in most parts of residential areas in Kabul people construct a boundary wall around their property according to their personal preferences (figure 4b) which does not match any of the Kabul Municipal codes. A height of 2.5m and width of 0.35m is suggested for a boundary wall. The height of 2.5m will provide cultural and religious privacy, but it does not connote fortification.



Figure4b. New imported Pakistani designs with massive constructed walls that influence “aesthetically” the public face of the house (Photos by the author).

Physical Factors:

There will not be any negative effect of the boundary wall on natural ventilation of the house because the wind does not blow in a straight direction. Naturally, wind blows in every direction (figure 4c). It also provides large amounts of shade from the west boundary wall in the late afternoons. The least shade, in a sunny afternoon around 4pm, would be double the height of the wall on the ground. Furthermore, the front wall, attached with the street, acts like a sound barrier that restricts the street noise produced by passing vehicles and other types of traffic.

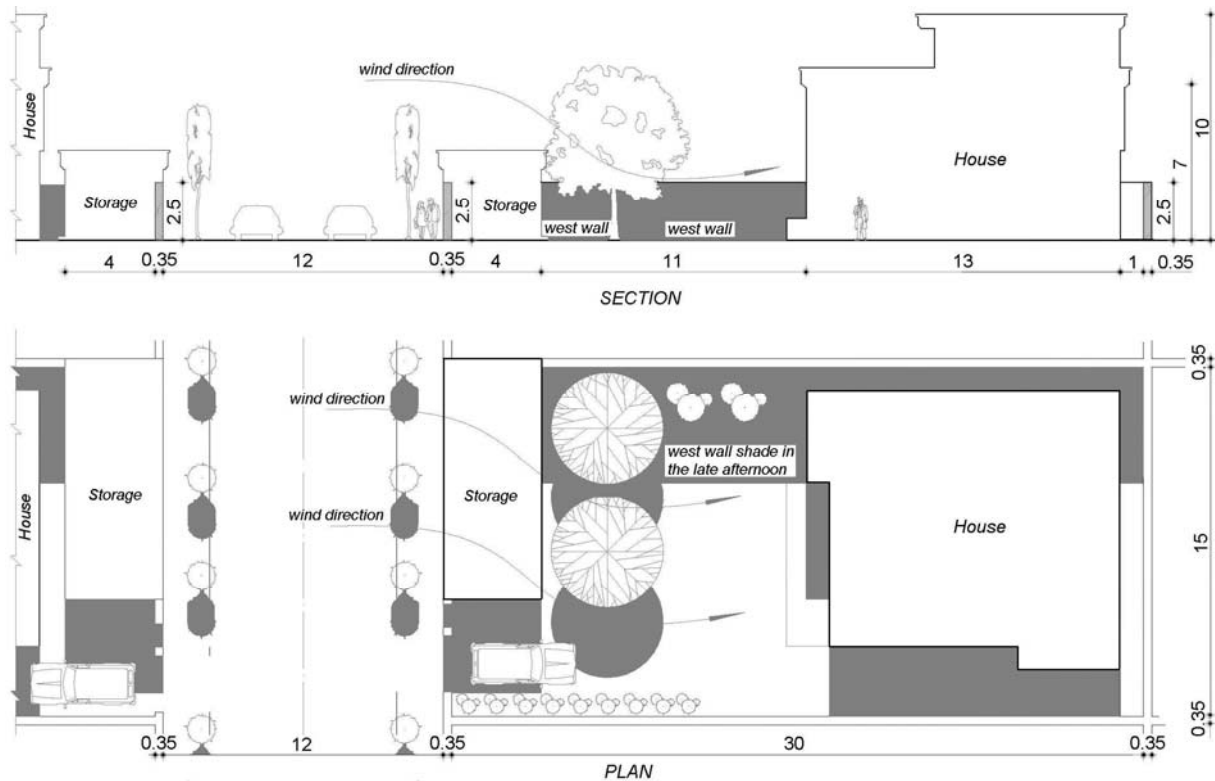

Figure4c. Boundary wall section and plan shows the height and width. It acts like a rectangular ring around the house (Drafted by the author).

The other physical impact that a courtyard wall brings to the house is the sun exposure. It is discussed by John S. Reynolds with a suggested formula:

Assume that nature plays the most significant role in usefulness of the courtyard, therefore, the “aspect ratio, or degree of openness to the sky is paramount”

$$\text{Aspect ratio} = \frac{\text{area of the courtyard floor}}{(\text{average height of surrounding walls})^2}$$

As the “aspect ratio” increases the courtyard opens to sky. This opening allows heat of the sun by the day and cold by the night. The effect of wind is also considered as cooling enters the courtyard by radiation.

Contrarily, the expansion of shadow at the courtyard surface deals with the winter sun by its minimum angle (in Kabul 32° in Dec. 21). This formula indicates the solar shadow by the walls:

$$\text{Solar shadow index} = \frac{\text{South wall height}}{\text{north-south floor width}}$$

Therefore, as the solar shadow index increases, the effect of south wall by spreading its shadow all around the courtyard ground surface will be greater which decreases the sun exposure. (*Courtyards*, p.16)

Socio-Cultural Factors:

Traditionally, construction begins on an auspicious day because the boundary wall protects the house from thieves and other social and environmental damages. Construction of the boundary wall is a declaration of ownership. The boundary wall should not be taller than the first floor of the house but should be tall enough to give the household a sense of privacy. In addition since a boundary wall faces the street, which is a public face, its form needs to be something acceptable for the community. My particular suggestion would be to enhance the society’s ethical education rather than build artificial massive walls to protect their privacy since we have experienced that no metal wall could protect the spiritual privacy. Jamel Akbar in the *Crisis in the Built Environment* says, “Education, not housing projects, is the best investment for a society’s wealth.” (p.185)

Several possibilities exist for the eventual diminution of the boundary wall. In one instance, new housing subdivisions may occur whereby a boundary wall surrounds a collection of individual

houses. Another possibility would be the transformation of a massive solid wall into more of visual screen that would obscure but not totally block views from the street. A boundary wall provides variety of patterns of shade throughout the day and seasons. Various individual and group activities can be seen to follow these patterns of shade.

References:

- Akbar, Jamel. (1988). *Crisis in the Built Environment: The Case of the Muslim City*. Tien Wah Press, Singapore.
- Brown, G. Z. and DeKay, Mark. (2001). *Sun, Wind and Light*. John Wiley and Sons, Inc. Canada.
- Ministry of Justice. (2000). *Afghan Official Jrydh: Municipality Law*. Ministry of Justice Press. Kabul, Afghanistan.
- Reynolds, John S. (2002). *Courtyards: Aesthetic, Social, and Thermal Delight*. New York: John Wiley & Sons, Inc.

5. House Cross-section in Relation to Courtyard and Neighbors



Figure5a. A typical house and its relation with courtyard and street. (Drafted by the author)

A house with other residential buildings in a single block of plots has its connection and relation of neighborhood that must to be taken into consideration. This relation could be a set of rules and regulations that need to be respected equally by all of the neighbors.

Living in a community requires a series of social regulations that promotes vitality. Once an owner of a plot starts to implement a house design, there is no intervention of the developer, builder or government. Therefore, it is the production of a particular family's hopes, desires and dreams. "In order to make this possible, there must be some system of rules, some pattern language, or some other similar flexible instrument which makes it possible for families to do this in a competent way." (Alexander, *Production of Houses*, p. 157)

Basic Design Factors:

Most of the time problems emerge from misinterpretation of the architectural and other engineering drawings since there is no specialist for implementation. Unfortunately it has become a bad custom to ignore the drawings and marginalize it by the owner and builders of the house. The project design is not only an important task prior to the construction but it is also very important during the construction process. People think if they hire an architect for implementation of their house it will double the cost of the project. However, a competent architect's design can prevent many serious long term problems.

Physical Factors:

Ecologically, a building without its landscape and hard-scape does not have any attraction, and it will not be sustainable with its environment. In other words, building without landscape is like a body without soul. Trees and other natural green sources provide sufficient privacy and natural beauty to the environment of the house that needs to be planted based on landscape rules (see pattern number 7, Landscape Impacts upon the Microclimate of the Neighborhood).

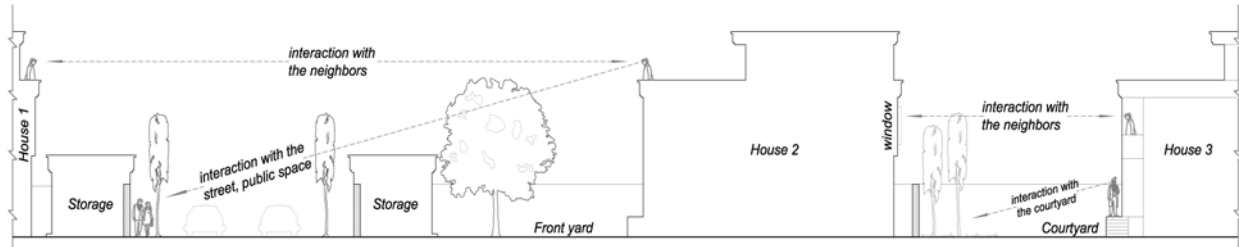

Figure 5b. House section in relation to its surrounding neighborhood (Drafted by the author).

Socio-Cultural Factors:

Social life has its own unique definitions that are defined by a series of social rules and regulations. If we look at (figure 5b) we can find a number of connections between the house and its neighborhoods both private and public. The greatest impact of a single house in a block is its relation to adjacent neighbors and the street which is the public face of the house. Therefore, neighbors should respect each other in order to establish a communal living environment. In a poor country like Afghanistan houses cannot be built without a dense interconnection with neighborhood, thus respecting the social rules based on the cultural circumstance will definitely have positive consequences.

References:

- Alexander, Christopher. (1985). *The Production of Houses*. New York, Oxford University Press.
- Ministry of Justice. (2000). *Afghan Official Jrydh: Municipality Law*. Ministry of Justice Press. Kabul, Afghanistan.

6. Mass/Void Relationship of Houses and Courtyards



Figure 6a. A typical rear plot courtyard house. (Drafted by the author)

The single house in relation to its surrounding neighborhood interacts like two neighbors face to face. The height, material, color, mass, void, and other elements talk to its surrounding phenomena whether private or public. According to ‘shariah’ (Islamic legal system) “there should be neither harming nor reciprocating harm.” (p. 26)

People often think that once they inhabit a desired constructed house they comfortably do not need to think about what is happening behind a party wall. This it is not true because social life is a consequence of many human activities that let them live within a respected territory. Akbar in the *Crisis in the Built Environment* says, “The owner who resides in his house has a relationship with his neighbors and the society at large” (p.26). This humanitarian environment is based on some social and physical contracts that should be respected by all of the neighborhood in the same manner.

Basic Design Factors:

A house design, for a number of reasons, has its mass and void spaces that let the house form and function interact with its environmental context. By looking at plot number (3) in figure 6b and its relationship with other houses in the same block, we understand the interconnections could result in negative and positive effects. A building has its value upon its mass and void spaces that make sense to its surroundings. If these mass and void volumes are not designed appropriately it will have serious environmental impacts. Architects make decisions about the degrees of

building efficiency upon its environment. The hierarchy of different levels and height of the house and its interaction with other houses in the same block is one of the important design and construction goals. Appropriate design of balconies can utilize the mass/void pattern of structural elements without any visual interruption to the neighborhood. South as a sunny face and north as a shady face of the house, will be the best sides for the design of balconies. Other openings also based on their directions need to be small or large in their sizes. The result of a concise design brings a productive life into the interior and exterior spaces of the house.

Physical Factors:

House shade has both negative and positive aspects for its neighborhood, according to the seasonal sun solstice, if the architect provides the rules of design and its consequences for the house itself and its surroundings. Windows and other openings of the house are important physical elements that let the warm sun inside the rooms during the cold winter time. At the same time windows are good design voids that provide natural ventilation into the interior spaces. In Kabul, most of the time wind blows from the north direction; therefore, a north-south cross ventilation is recommended. For a cross ventilation, even, smaller openings do the work since larger openings allow the cold air to enter the house in the winter time.

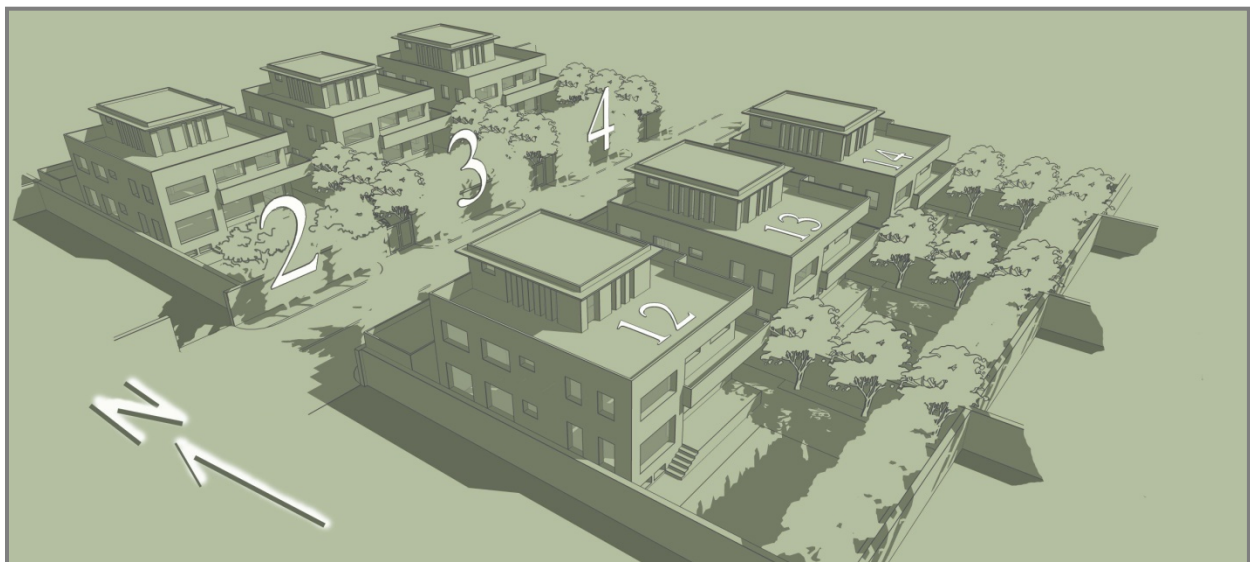

Figure6b. House 13, based on KM plot subdivisions is located between house 12 and house 14. (Drafted by the author)

Preferably, the most openings are recommended in the south façade of the house rather than east and west. It is also important to take the full advantage of east and west openings in the sunny

days of the winter, but a longer sill is suggested for respecting the privacy issues (the openings' issues will be discussed in the coming patterns in more detail). Constructing too many openings in the north face has its negative and positive effects. It is positive for providing natural ventilation during the summer hot days and negative for cold nights of the winter, in a Kabul seasonal circumstance. South face larger openings let the inhabitants of the house to take the positive advantage of natural beauty of the courtyard and enjoy the warm and cold weather based on different seasonal time.

Socio-Cultural Factors:

Christopher Alexander argues it is important to design and construct a housing process “in which human feeling and human dignity come first.” Not only that but also their own knowledge as the real householders and based on their cultural circumstances, their “social bonds” should be taken into consideration (*The Production of Houses*, p. 16).

House (13) in east has face to face interaction with house (14) and in west with house (12), (see figure 6b). At the same time its north face meets the street and south faces the courtyard. The north face could be respected by the public if it is beautiful and does not harm the daily street social life (some of the height considerations are discussed in pattern 2). The house form from the pedestrian street observer can portray the angry or glad face of the owner. Therefore, it is very important to design the public face of the house in a manner that would be acceptable for the people who pass the house based on their everyday activities. Note that the public face of a courtyard house could be north or south, base on ‘KM’ plot subdivisions. Windows which are located on the east and west side of the house makes a lot of communal sense to those houses householders. These neighbors will adapt themselves according to each other’s reactions. Numerous social conflicts are observed with the wrong interpretation of window design in a neighborhood. Nothing reduces the conflicts unless people come up with their own behavior and attitude towards their ways of life. A traditional courtyard design in a Kabul house would provide a number of activities in its outdoor space. People like to spend substantial amounts of their leisure time out of house as they are tired after a busy day. Summer evenings are appropriate time for family gatherings as the day’s hot temperature reduces and colder night comes on. Therefore, it is very important to enjoy one’s time without bothering the neighbors.

In a courtyard any kind of temporary activity is possible. The arcades as the extension part of the rooms could be used as an open kitchen and dining, preferably, in front of the kitchen. By having such a nice open space with fresh air (depends of the seasonal and time circumstances) group activities are enjoyably welcomed because the dark and small rooms do not have sufficient atmosphere for these group activities. The efficiency of the activity could be increased by doing it in a fresh and pleasant space. Whenever the climate is not mild still the activity is possible by moving to a shady and protected arcade. The courtyard provides a good playground for the children. A ground has both hard and soft surface; hard for the toys with wheels and soft with other types of activities like digging, playing with earth and channeling the water. It is not only a safe place for children to play but they learn as they observe and think about the nature's phenomena. For taking a nap during the hot afternoons of the summer time, the shade of arcade is a good place to enjoy and relax since a little breeze blows most of the time. Security remains an important issue in courtyards as well as for house itself. The single controlled gate will not be the only vulnerable way to the courtyard; sometimes the opening to the sky makes problems. In some smaller courtyards, a chicken-wire will discourage both burglars and bats. Keeping a dog will be reasonable for the security of house. (*Courtyards*, p. 57, 58, and 59)

References:

- Alexander, Christopher. (1985). *The Production of Houses*. New York, Oxford University Press.
- Akbar, Jamel. (1988). *Crisis in the Built Environment: The Case of the Muslim City*. Tien Wah Press, Singapore.
- Ministry of Justice. (2000). *Afghan Official Jrydh: Municipality Law*. Ministry of Justice Press. Kabul, Afghanistan.
- Reynolds, John S. (2002). *Courtyards: Aesthetic, Social, and Thermal Delight*. New York: John Wiley & Sons, Inc.

7. Landscape Impacts upon the Microclimate of the Neighborhood

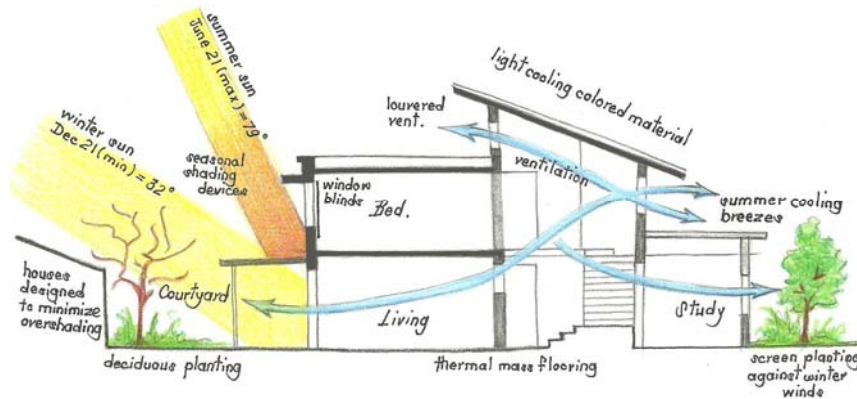

Figure 7a. Benefits of the landscape positively influences not only the building itself, but also the entire neighborhood. (Drawn by the author)

Building without landscape is like a body without soul. Providing landscape for a building converts it to a living body that breaths and helps its inhabitants live with nature. Landscape is a vital phenomenon of the house that provides a variety of microclimate options.

Green areas are considered the earth's substantial embodied components that provide not only a natural aesthetic but an intrinsic part of the ecological system. The building designer must take advantage of the favorable microclimate characteristics and mitigate the adverse climatic features since the air's many harmful gases are absorbed by these primitive living species. Also it is important to remember that the site layout of a building or a group of buildings alters the microclimate of the site.

Basic Design Factors:

Deficiencies in urban design and building regulations have adverse consequences on the urban climate and environmental efficiency of buildings. The increasing number of buildings in urban areas and industrialization has a deteriorating effect on the urban microclimate. Subdivided courtyard housing plots in Kabul are located on the back of commercial buildings. These commercial areas more likely are dense hard-scape spaces without greenery. Therefore, it is logically understandable to compensate these heat producing structures by increasing the

landscape of residential areas. Otherwise, the negative effect of a “heat island” will greatly impact the region’s microclimate.

Physical Factors:

As a consequence of heat balance, air temperatures in dense urban areas are higher than the temperatures of the surrounding rural country. “Excessive or unprotected paving can cause hot spots and unwanted glare around our dwellings.” (*Desert Housing*, p.17) The phenomenon is known as a "heat island" (figure 7b). In this aspect, the more sustainable and easy to use vegetation and water bodies reduces the heat island effect. Vegetation and water bodies for cooling purposes can be considered as a renewable heat sink, in a similar way that the sun is a renewable heat source for heating purposes. Afghanistan has an arid climate which does not have a sufficient rate of rainfall during the year and continuous drought has its negative impact upon vegetations and other green landscape. By limiting the building footprint and other hard-scape areas people can expand landscape areas. One of the important reasons that people prefer living in a courtyard type house is its available ground for planting and vegetation. Therefore, by increasing the green area in a neighborhood and its natural effects upon the region’s climate, the housing health is enhanced.

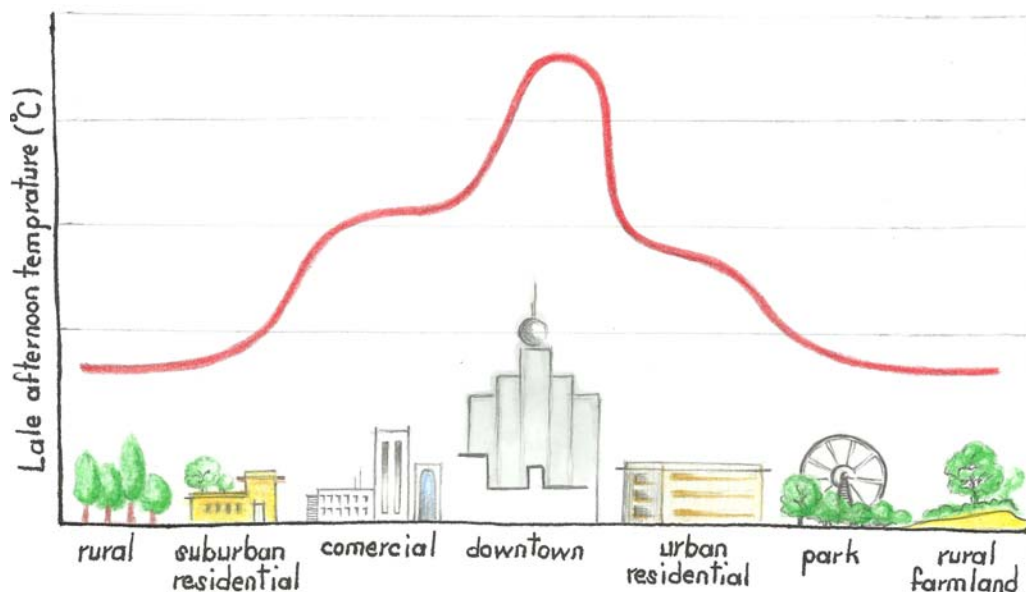

Figure7b. The diagram above shows the influence of the site density on the late afternoon temperatures (heat island effect for central urban areas). (Drawn by the author, adapted from <http://www.acca.it/euleb/en/glossary/index.html>)

Socio-Cultural Factors:

Traditionally in Afghanistan, rural areas are greener compared to the cities. That is why mature people like to live in rural areas rather than more urbanized areas because green gives a sense of sustainability with the nature of the region. Living either in rural areas or the city does have their advantages and disadvantages of social circumstances. In recent years, after the new changes that are the consequences of security and economic circumstances, people prefer to live in the cities. Most people who moved from rural areas to the city transferred their rural cultivating experience to the cities and provided greener spaces into their courtyards. Indeed, if we go back about 40 years, most parts of the current subdivided Kabul blocks were cultivated grounds that indigenous farmers worked upon. After increasing the density, in the city, these grounds were converted to residential areas. Some of those farmers built their beautiful houses by allocating half or more of their building footprint for vegetations. Such a consequence provides a healthier environment.

References:

- Ministry of Justice. (2000). *Afghan Official Jrydh: Municipality Law*. Ministry of Justice Press. Kabul, Afghanistan.
- N. Clark, Kenneth and Paylore, Patricia. (1980). *Desert Housing: Balancing Experience and Technology for Dwelling in Hot Arid Zones*. Tuscan, Arizona, US.
- Euleb, European High Quality Low Energy Buildings website. (2006). <http://www.acca.it/euleb/en/glossary/index.html>.

8. Zoning the Courtyard

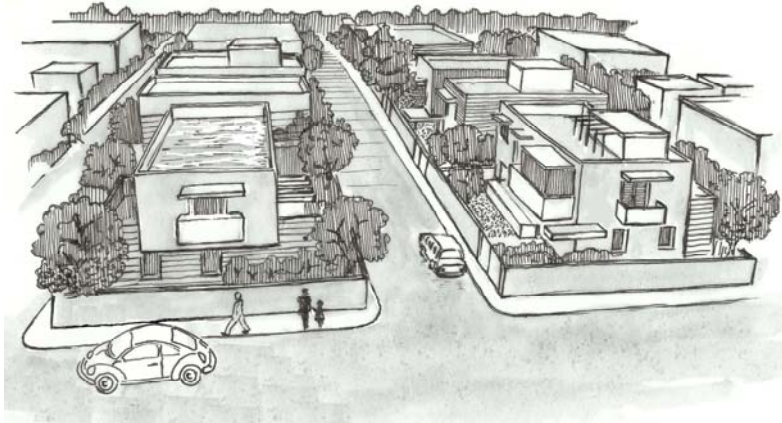
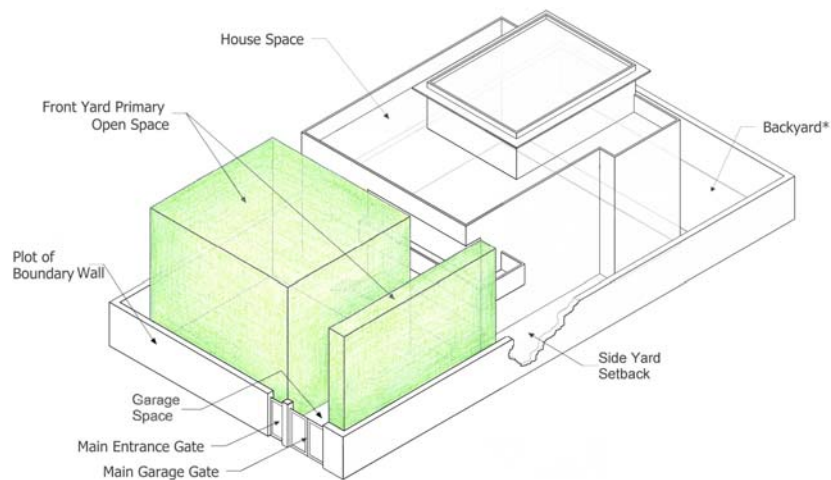

Figure8a. The grid type subdivided KM plots provide a healthy environment if the rules are respected by the builders. (Drawn by the author).

Zoning of the courtyard is as important as the zoning of the house itself. Based on the shape of the KM plot zoning, the best orientation for a Kabul courtyard will be south of the main building.

One of the important reasons that people prefer to live in a courtyard house in lieu of living in an apartment is its similarity to a traditional small garden. Nevertheless, its zoning is important, according to the orientation of the sun and its relation to the house. “In a healthy town every family can grow vegetables for themselves. The time is past to think of this as a hobby for enthusiasts; it is a fundamental part for human life.” Alexander, (p. 819)



*Figure8b. Identification of courtyard terms. *A traditional outdoor storage could be designed in the backyard space, but still a one meter distance is required for providing a setback between storage and house (Drafted by the author)*

Basic Design Factors:

Zoning of a courtyard is as important as the house by itself. Based on the geographic location of Kabul located in the northern hemisphere, south orientation is the best zoning option for a green area like a courtyard. According to KM typical architectural design (figure 8c), the location of traditional storage is in front of the house (south side of the house). I propose moving this storage from its previous location to the back of the courtyard in order to give a setback for many reasons discussed in pattern 2. It is also important that all of neighborhood courtyards in a series of the city block should have the same orientation because this helps them, equally, benefits from the sun and other upcoming physical factors.

Physical Factors:

Naturally, in a south oriented site with the house footprint located in the north of the plot, almost all types of vegetations and trees are planted and grown. It is the consequence of the sun and its substantial organic influences upon the earth's living species. Therefore, the orientation of the sun is one of the key reasons for the determination of the courtyard zoning. Those plots which are located along the south side of the city block ('11-20' figure 1b) and considered as a south facing to the street, are more vulnerable to street dust and noise from the front side. The front yard of the house could be protected by a boundary wall and trees from the dust and noise.



Figure8c. A south oriented courtyard has many significant benefits. (Drafted by the author)

A south oriented courtyard is discussed in *Environmental Design of Urban Buildings*, “In addition to the creation of a pleasant and ‘energy concentrating’ sun pocket...the same configuration acts as a buffer against the wind and street pollution (e.g. traffic, noise, dirt and particles) as well as providing efficient land use.” (p. 6). Conversely, for those houses which connect to the street from the north (‘1-10’ figure 1b), the height of the boundary wall and reducing the area of north facing openings will be necessary.

Socio-Cultural Factors:

Because all Middle Eastern countries are located in the north hemisphere, zoning the traditional courtyard in the south has a sense of commonality. People use this courtyard for many reasons; to take the advantage of warm sunny days during the cold weather of the Kabul winter, a place for family congregation, providing space for greenery, providing psychologically friendly atmosphere, space for the children’s playground, better environment for elder persons of the family and so forth. The only zoning consideration that provides a variety of activities will be located at the south orientation. As Alexander identifies for an open courtyard, “courtyards which live” (p. 563) has identical values as the main house. In a traditional Afghan courtyard, elders in the winter sunny days or summer’s evenings take the advantage of this open area by doing numerous social activities. Simultaneously, there is a strong connection between the living room or salon of the house and the courtyard as the family enjoys their conversation when they sit together.

Footnote:

Front plot: is the local name for those plots which have a garage door to the street from the north.

Rear plot: is the local name for those plots which have a garage door to the street from the south.

References:

- Christopher, Alexander, Ishikawa, Sara, Silverstein, Murray, Jacobson, Max, Fiksdahl-King, Ingrid, Angel, Shlomo. (1977). *A Pattern Language: Towns, Buildings, Construction*. Oxford University Press, NY.
- Ministry of Justice. (2000). *Afghan Official Jrydh: Municipality Law*. Ministry of Justice Press. Kabul, Afghanistan.
- Santamouris, Mat. (2006). *Environmental Design of Urban Buildings: An Integrated Approach*. Bath Press, UK.

9. Zoning the House in Relation to the Zones of the Courtyard

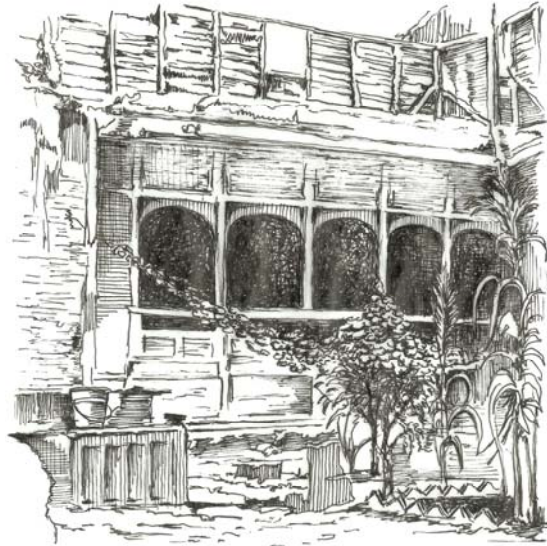

Figure9a. A traditional courtyard (Drawn by the author, adapted from Traditional Architecture of Afghanistan, page 193)

There is an inevitable relationship between zoning of the house and zoning of the courtyard because the house is oriented based on the layout of the courtyard.

Before introducing the zoning of the house in relation to the zones of the courtyard it is important to identify numerous activities which occur inside the courtyard. The activities are connected to the natural and manmade objects, inside the courtyard. Once we recognize these courtyard activities we can easily decide what will be the best zoning option for the house and its courtyard. These are the major design parameters inside a courtyard that affect the zoning of the house and its courtyard:

- Neighbor building openings
- Neighbor building height
- Neighbor building shade
- Location of trees
- Location of water well
- Location of septic tank
- Location of the garage
- Location of storage room
- Distance from boundary wall
- Front yard privacy

Basic Design Factors:

All of the above stated parameters should be included, with their solutions, in architectural design drawings. By resolving these parameters in an appropriate manner the courtyard and house can desirably interact with its surrounding environment. Careful design of these elements brings environmental benefits not only for the house occupants but also for the neighborhood. A healthy environment will be the consequence of a successful design made possible by appropriate design decisions. The house, by itself, contains the appropriate rooms designed to connect to each other based on their functions. These rooms have a relationship not only among themselves but also with outdoor spaces. Positive interrelationships make the inhabitants of the house happy and grateful of their neighbors.

Physical Factors:

Inappropriate zoning of the house causes environmental damage whether by the inhabitants or the neighbors. Building openings should be placed appropriately based on the sun orientation and wind direction. The south elevation can bring the most sunlight and passive heating into a building. The east elevation is the second best orientation followed by the west orientation. North openings admit only indirect light and cold weather that is not good for the health of the householders. The negative consequence of nonobservance of the building height with its shade

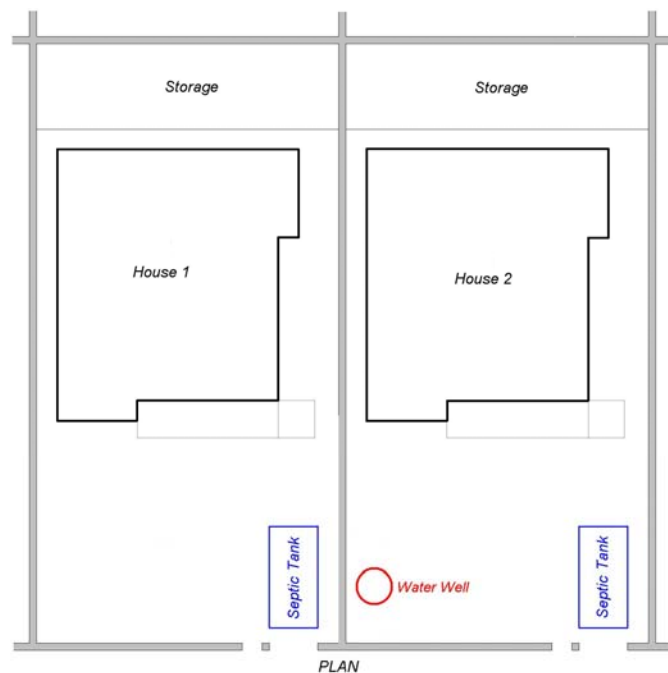

Figure9b. A 25m. distance between water well and septic tank gives a healthy result. (Drafted by the author)

is a great damage for the neighbor's possession. The building shade causes slippery injuries on the icy hardscapes in the house backyard and side setbacks. Reasonable planting of the trees is good for the health of the environment. Avoid planting the trees too close to the building foundations and other hardscape elements which causes huge physical damage. Location of the water well and septic tank should be completely separated from each other. The rule of 25meters will be a reasonable suggestion. In some previous courtyard housing plots it has been seen that people placed their septic tank appropriately underneath of the car parking area and drilled a water well in a distant location from the septic tank, unaware of the neighbor's septic tank that had been located in a distance of approximately two meters behind the property wall (figure 9b).

Socio-Cultural Factors:

Based on Islamic urbanism rules and regulations and some traditional facts the side openings of the house should be minimized in size or at least have enough height from the floor level of the room. This is applied for the second and upper floors of the buildings since the first floor of the house is surrounded by the boundary wall with a height of two and half meters. Constructing fixed louvers will be another solution for letting the natural air and light inside the rooms and providing privacy for both of the neighbors. It is understandable that providing privacy will not be possible unless social ethics is increased by individuals. Front yard privacy is one of those issues that could not be ensured if the neighbors do not share responsibility. Separate from these there is an in depth relationship between interior zones of the house and the courtyard elements. Chart 9c shows these interrelationships that influence the design strategies based on socio-cultural factors.

Identification of Primary Relationships between Courtyard Zoning and House Interior Zoning		<i>Interior Zones of House</i>								
		Salon/Guest	Dining	Kitchen	Family Sitting R.	Bathroom	Toilet	Master Bedroom	Bedrooms	Indoor Storage
<i>Courtyard Elements</i>	House Massing Placement									
	Hardscape	+	+	+	+					
	Foreyard	+	+		+			+		
	Backyard			+		+	+			
	Boundary wall	+		+	+					
	Side setback	+		+	+	+	+			
	Main door to street	+								
	Garage	+								
	Outdoor Storage			+						

Table9c. Interrelationship between interior and exterior spaces. (By the author)

References:

- Samizay, Rafi and Hallet, Stanley Ira. (1980). *Traditional Architecture of Afghanistan*. Garland STPM Press, New York.
- Ministry of Justice. (2000). *Afghan Official Jrydh: Municipality Law*. Ministry of Justice Press. Kabul, Afghanistan.

10. Internal Zoning of the House

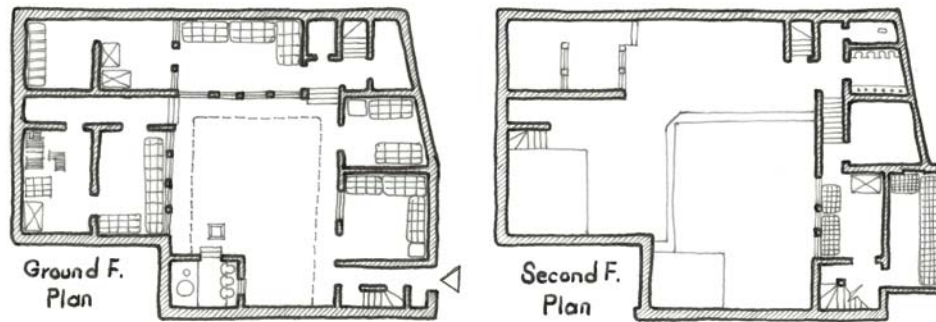

Figure 10a. Plan of first and upper level of a traditional house in Kabul. (Drawn by the author, adapted from *Traditional Architecture of Afghanistan*, page 185)

The internal zoning of the house is as important as its exterior. Interrelationship of the individual rooms and their unique function defines the zoning in relation to the house. This zoning occurs both horizontally in plan and vertically in cross section.

Basically, a house design starts with the composition of the spaces and individual room arrangements in relation to their functions. These rooms functionally tie together according to the activities that identify limitation of their existence. It is always a complicated issue once the designer of the house decides to think about the basic elements of design that influence the arrangement and subdivisions of the spaces.

Basic Design Factors:

The architect starts evaluating the aspects of design in his/her mind based on the basic design circumstances. Listing the extra demands and needs of the client facilitates and accelerates the design procedure. For instance, negotiation with the owner has bilateral benefits for the ease of the design and construction complexity. Most of the time the owner does not know anything about the rules that bring dramatic efficiency, beauty and cost reduction in the project which is feasible with a logical conversation. A well oriented room according to its function not only facilitates the interior activities for the users but also is economically beneficial. The designer should take this into his/her consideration that some of rooms according to their functions physically attach to each other but at the same time interrupt some of the activities. For instance, it is more economical if a kitchen and a toilet or bathroom is attached but functionally they

interrupt the physical space. Matrix 10b shows the immediate and obligatory interconnection of the rooms.

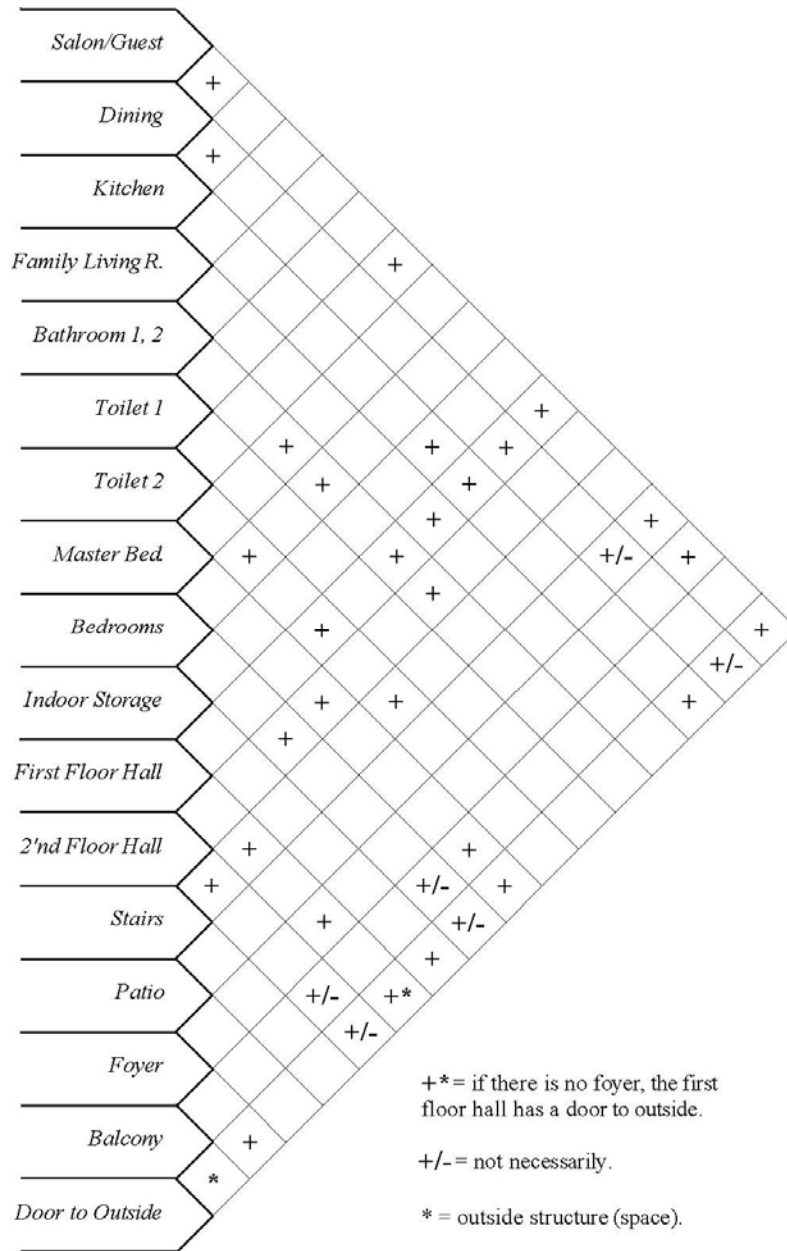

Table 10b. Rooms' physical interrelationships (By the author)

Physical Factors:

Strategic placement of the rooms provides natural health to the house environment and is a free energy source in all seasons of the year. Benefits of natural sunlight are as significant as the ventilation of the rooms with their openings to the direction of the natural wind. Kabul climate,

with its four distinct seasons, gives a variety of design opportunities if studied comprehensively. According to the Kabuli's traditional expression, "in a room in which the sunlight enters, a doctor (physician) will not enter." Best sun orientation for rooms is shown in figure 10c, Neufert Architects' Data. The given examples in "Neufert Architects' Data" frequently apply for Kabul conditions as well. This valuable book has been used for years by Afghan students and architects as a standard guideline.

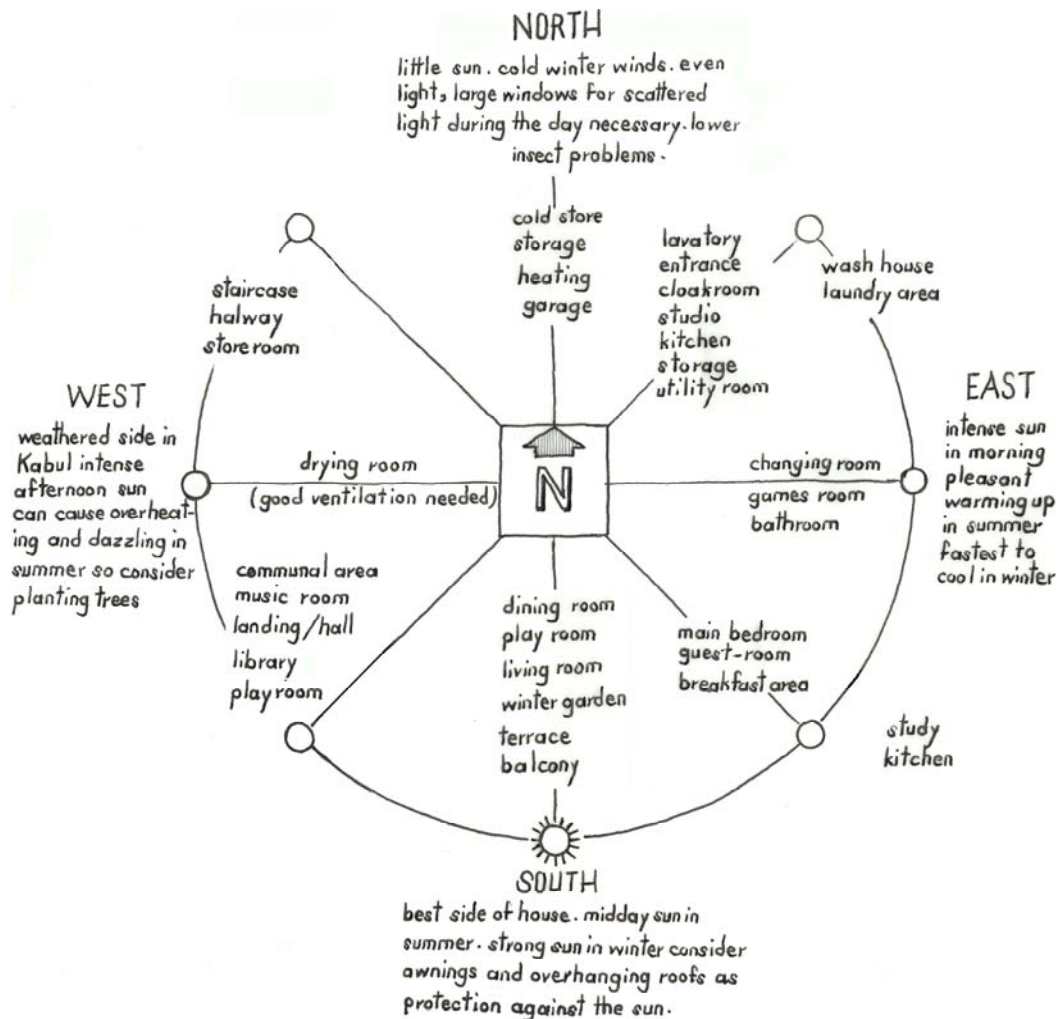

Figure 10c. Rooms Orientation, (By the author, adapted from Neufert: Architects' Data, page 272)

Socio-Cultural Factors:

The house main entrance, main hall and salon are considered the social spaces of the house that greet a stranger or guest. Therefore, the sequence of these elements should be designed in a way that does not interrupt the house private spaces. Privacy is the most important element for a

traditional Afghan house design. The authors of *Responsive Environments* argue, “If everywhere were accessible to everybody, physically or visually, there would be no privacy. But one of our basic sources of choice stems from our ability to live both public and private roles. For this capacity to flourish, both public places and private ones are necessary.” (p.12). Traditionally, most Kabulis provide the guest room separate from the family house area which is more likely to be adaptive in *qala*, traditional Afghan fort, type housing where more space was provided. In a modern subdivision housing area, Wazir Akbar Khan (about 40 years ago), a very significant change has taken place with a great tendency of the more urbanized population. In the current situation, by having a limited subdivided area, 500m², the guest is welcomed into the main house by making a sufficient design strategy. It means, direct connection of the entrance door with salon as a guest room will solve the obstacle of privacy. My particular suggestion is to design a foyer that provides space for two doors, one to the salon and another to the whole family area. The foyer is discussed in the next pattern.

References:

- Samizay, Rafi and Hallet, Stanley Ira. (1980). *Traditional Architecture of Afghanistan*. Garland STPM Press, New York.
- Bentley, Ian, Alcock, Alan, Murrain, Paul, McGlynn, Sue, and Smith, Graham. (1994). *Responsive Environments: A manual for Designers*. Hartnolls Ltd, Bodmin, Cornwall, London, Great Britain.
- Neufert, Ernst, Neufert, Peter, Baiche, Bousmaha, Walliman, Nicholas. (2002). *Architects' Data*. 3rd ed. Wiley-Blackwell.
- Ministry of Justice. (2000). *Afghan Official Jrydh: Municipality Law*. Ministry of Justice Press. Kabul, Afghanistan.

11. Zoning the House in Relation to the Zones of the Courtyard for Family and Guests

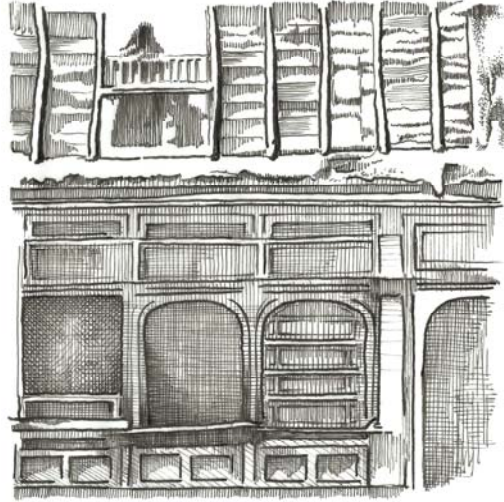

Figure 11a. Careful design leads the guest to find his way to the particular invited room. (Drawn by the author, adapted from Traditional Architecture of Afghanistan, page 190)

Careful distinctions must be made in the interactions of house occupants and guests when zoning the house and courtyard.

Building upon the requirements of pattern 9, Zoning of the House in Relation to the Zones of the Courtyard, it is important for both the house occupants and guests to find their way spontaneously to the house by clearly communicated design. An Afghan house design is as important to individual groups of the guests as to the householders since Afghan people are widely known for their warmth and gracious hospitality. The designer should take into consideration both individual and group activities for different age, sex, and social status.

Basic Design Factors:

One of the important design issues which an architect needs to know is the variation of age, sex, and social relationship with household guests. Thoughtful and precise placing of the rooms based on individual needs brings comfort for the family. At the same time analyzing the closest accessibility of the guest room to the entrance door brings comfort for the guests.

Physical Factors:

Mental calm is as important as physical comfort for the older adults. Older adults need more comfort according to their natural body and mind circumstances. Finding a peaceful atmosphere with a warm sun during the cold weather of Kabul winter is one of the natural necessities that every senior of the family desires. The best suggestion for older family members will be the upper level of the house which is more quiet.

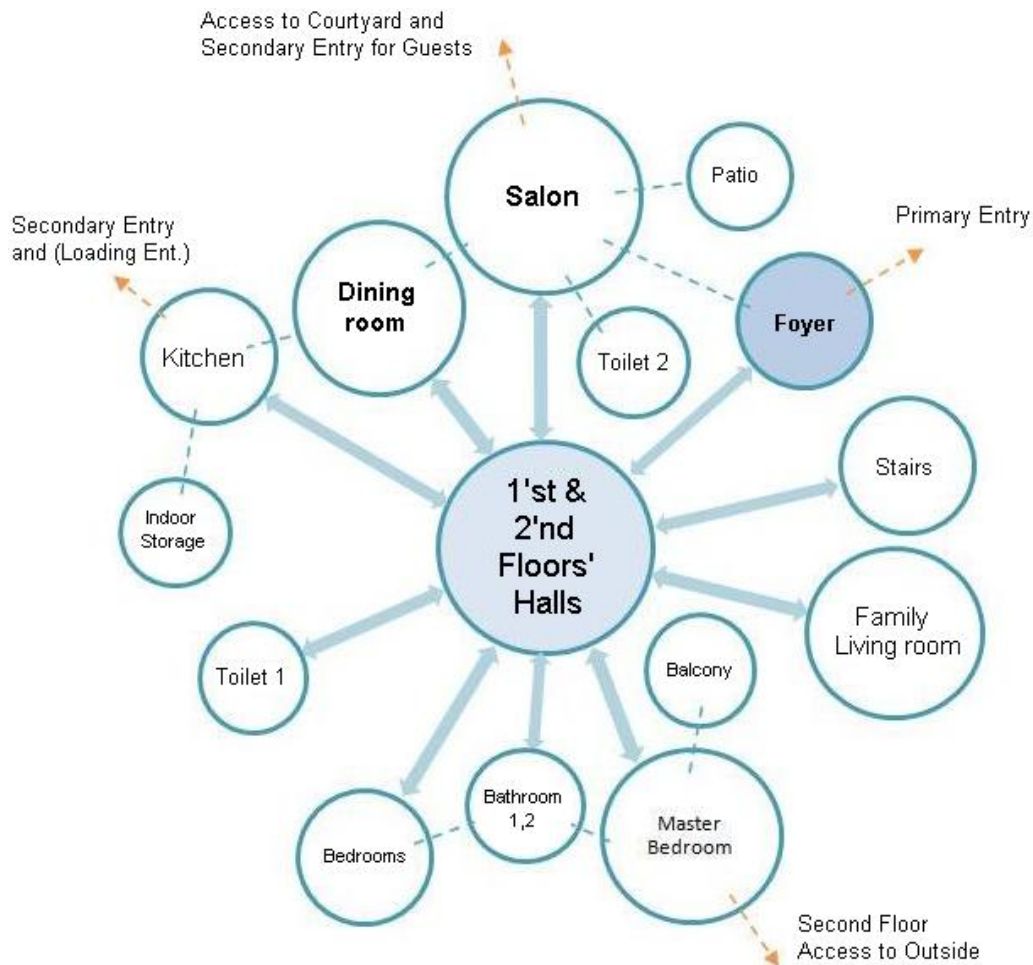

Figure 11b. Interrelationship between the rooms inside the house. The salon is utilized as a guest room. Arrows in orange color indicate the connected indoor with outdoor spaces. (By the author)

Simultaneously, the best orientation for receiving the natural sun's warmth, until the dusk, will be the south face of the house which is facing the front yard. Designing such a room with a small appropriate balcony that faces the courtyard front yard allows the grandparents to take the advantage of natural sunny winter days and look at the yard from an upper eye level. Children

with their limited abilities need more care by the older members of the family. The childcare for a housewife is as important as her other house tasks. She should take care of the children while she is doing her daily activities. A multi-task is possible if the playground is near to the place she is cooking, dish washing, cloth washing, ironing or doing other similar activities. These opportunities are only possible by a good design resolution taking place based on architect and householders negotiation. This importance will not be possible until a list of detailed requirements is prepared by the householders.

Socio-cultural Factors:

According to our prepared list of project requirements, the architect starts his first draft. The architect needs to present his first draft to the owner/client in order to see what is wrong and what is right since he has an intermediary role between the client and builder. Basically, a moderate family has 5-10 members consisting of parents, little children, and elder children. Culturally, Afghan families are very connected to each other; in some cases, probably, it could be a consequence of the poverty. Most of the time the grandfather (father's father) and grandmother (father's mother) live with his/her elder son. Elders of the family are respected according to their age by younger members. Probably, it is a bond that has culturally taken place and a social expectation reinforces it. The first priority is the female children of the family who have their own requirements both naturally and culturally. After they reach puberty, they need individual rooms in which they have their own private space for study, entertainment, and rest. The second priority will be male children of the family who also need a space to make according to their desires. It is understandable that adult family members watch a TV program or movie that is not suitable for younger ones as the non-consideration of such a mistake brings cultural violence and abuses. If separate rooms are provided for individuals, according to their age, sex and social needs, with different entertainment centers, the consequence will be positive. Guests as outsiders should be separated from the house private area. A newcomer must not have access to the house intimate places; he/ she should find his path from the entrance door to the guest room, and the toilet should be accessible from the guest room. Based on Afghan culture, if the guest is a non-intimate male, then only males can visit him and serve him. The same aspect applies to a female guest who visits the female householders. Some of the visitors spend a night in the house especially during the long nights of the winter people have reduced work and the

schools are closed. Designing a toilet attached to the guest room will solve the problem of finding a door in the darkness. “If everywhere were accessible to everybody, physically or visually, there would be no privacy. But one of our basic sources of choice stems from our ability to live both public and private roles.” (*Responsive Environments*, p. 12)

Appropriate design of the rooms based on their functions, in both lower and upper levels are one of the key points for circulation of the house. Based on Afghan culture, a guestroom should be separated from the other private areas. That is why it will be good if the guestroom be placed close to the entrance door of the house. It is better if the guestroom door is separated from the entire house areas by a foyer (vestibule). More private areas like bedrooms should be away from the outsiders’ eye and touch. Bedrooms also need more peaceful atmosphere for relaxation and study. Traditionally, people have served the lunch and dinner in the same room in which a guest was sitting. This social custom has changed. Now, most Kabulis have their meals in a common dining room. This new social trend has encouraged the design of the dining room to be attached to the salon and kitchen (see figure 11b). The kitchen has a door to the dining (could be an opening like a window) for better service of the food. If only a window connects these two rooms together, at least, two persons are required to carry the food from kitchen to the dining. A big opening between salon and dining provides larger space in case there is a wedding celebration or other special occasions. In bigger parties the central hall also works and lets a number of guests to use the space. Therefore, a wide hall design is preferred rather than a narrow corridor. Recently, clients for new houses also want a good, naturally ventilated basement space. This space could be used for both ceremonial and rainy days. It is important that the generously sized stairway also connects to the basement.

References:

- Bentley, Ian, Alcock, Alan, Murrain, Paul, McGlynn, Sue, and Smith, Graham. (1994). *Responsive Environments: A manual for Designers*. Hartnolls Ltd, Bodmin, Cornwall, London, Great Britain.
- Samizay, Rafi and Hallet, Stanley Ira. (1980). *Traditional Architecture of Afghanistan*. Garland STPM Press, New York.

12. Vertical and Horizontal Circulation



Figure12a. A staircase is an important connecting structural element of the house. (Photo by the author)

For a multi-story house, the vertical relationship of the rooms is as important as the horizontal relationships. Stairways have a significant role for connecting the lower floor areas to upper floors.

Modern Afghan houses are now using more hallways as a means of separating different members of the family. The typical modern Afghan house requires only one stairway to the upper levels. In a traditional Kabul house with limited available local material, a single floor design is preferred. However, multi-floor housing can also be used. In the old city of Kabul multi-floor housing (two, three, and four) was built because it was a dense area. The structure of the older houses was quite different from the modern houses. New construction methods allow for taller buildings.

Basic Design Factors:

A stair, ramp, and elevator are considered the basic design elements for the building's vertical circulation. These elements of design take place appropriately based on the building's function. A two or three story house can easily and comfortably be connected by a single stairway. This stairway should be designed in a place that is accessible to the entire household. The best option is the hall that is connected to all of the rooms (see figure 11b, bubble diagram), and the best orientation for a stair is north since it is only used for a few minutes. If a stairway is designed in

south, east or west of the house it takes another rooms' place which is occupied for more amount of time. Therefore, by force, the stair is pushed away from exposure to the sun. The designer should consider a rooftop window as a means of obtaining sunlight into the stairwell. The overall form of the stair impacts both the interior and exterior form of the house. The stair is an important aesthetic feature of the house. A stair shape (one line, L shape, U shape, etc.) identifies its footprint and, therefore, maximizes and minimizes the hall area. Important horizontal relationships occur between salon, guest room, dining room, kitchen, and family room. These activities commonly occur on the first floor. Other activities, like bedrooms, are considered as private areas and are located on upper floors. (Figure 12b)

Physical factors:

A stairway's design and construction is considered the most complicated task among the elements of the house. The step's rise and run dimensions, the handrail height and durability, and sufficient light to avoid falling (particularly for older members of the family) are some important design requirements for a stairway. The energy that is required for climbing stairs, on average, is seven times more than energy needed for traveling horizontally. Physiologically, the most comfort angle for a stair slope is 30°. The ratio of rise and run is:

rise of step, R = 17cm.

run of step, r = 29cm.

The angle of rise is taken from an adult's stride (about 61-64cm), therefore, the least energy will be required if we follow this formula: **2 (rise) + (run) = 63cm = 1 stride.**

Handrails are installed for more comfortable climbing of stairs, safety purposes, and protection of the stair's side walls. The height of handrail varies according to the age of inhabitants. The recommended handrail height for adults of the family is (85-90) centimeters and for the children

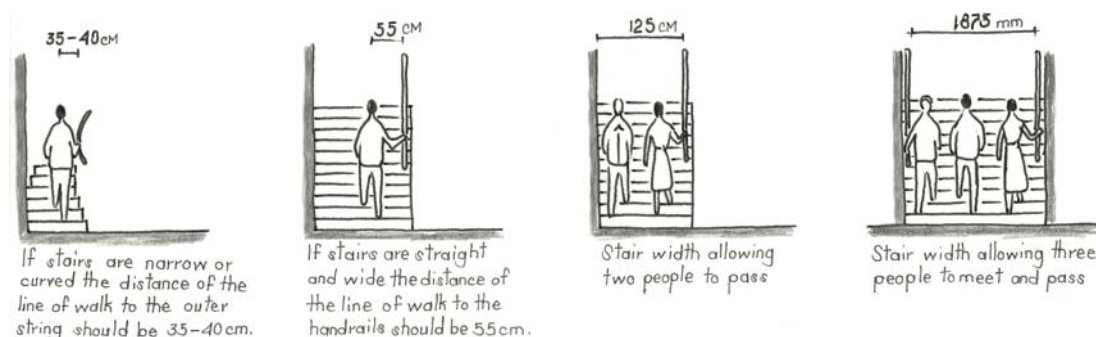

Figure 12b. Stairways' width (Drawn by the author, adapted from Neufert: Architects' Data, p. 191)

about 60cm. The width of the stairway varies based on the number of occupants and also for vertical moving of large furniture, not less than 1m is recommended. (*Architects' Data*, pp.191-193) An optimum stair width will be (125-140) cm. It is also important to keep the same width in landings for better movement.

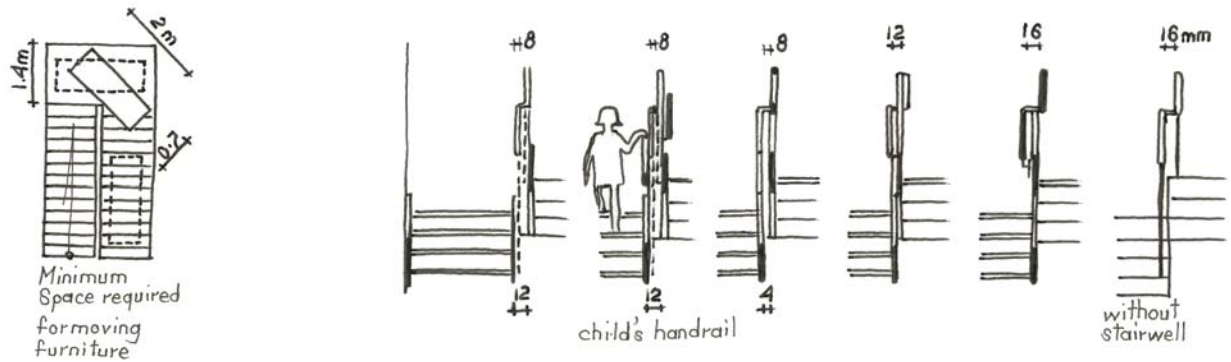

Figure 12c. Stairways' minimum space requirements for moving furniture, and handrails. (Drawn by the author, adapted from Neufert: *Architects' Data*, pp. 192 and 193)

The landing also provides for temporary relaxation. It is a place for a deep breath for older members of the family. Bringing sufficient light into the stairway prevents the sudden injuries and helps the stair climber to better watch his/her steps. Hallways also have the same value as stairways since without a hallway it will not be possible to access the stairway. Since hallways are used for special celebrations as well as everyday use, it is important to have enough width and length in order to provide sufficient space for parties. In most designs the hallways receive their natural light through windows placed in the stairway. Sometimes for some specific purposes designers add a few steps in a hallway. It is better to provide it in a corner, not along the entire width of the hall. Otherwise, avoid designing a single step since architects say “one step is no step” because it is not safe.

Socio-cultural factors:

“A staircase is not just a way of getting from one floor to another. The stair is itself a space, a volume, a part of the building; and unless this space is made to live, it will be a dead spot, and work to disconnect the building and to tear its processes apart.” (*A Pattern Language*, p. 638) Since the hall has important value for special celebrations and gatherings, the staircase also has its significance as a vertical connector. Therefore, it is important to provide appropriate space for a staircase that allows enough natural light, comfort, and access to the upper levels. During occasions, the hall is converted to a crowded and busy place that blocks the stairway. This

shortage can be solved by better arrangement of the plan. Misplacement of the staircase interrupts the house activities particularly during the social occasions. From the religious point of view, a staircase should have enough privacy both physically and psychologically. Two strategies are applicable:

1. Constructing a clerestory or skylight above the stairwell.
2. Installing opaque glass or fixed louvers.

A designer decides which strategy works. Inhabitants should psychologically feel that they are not seen by neighbors and it is only possible if they are protected by a good design solution. Most of the time installation of a clerestory or skylight is refused by placing a water reservoir tank room instead. This is preferred because a water reservoir tank is installed on the top of the structure. Socially, elder members of the family are respected the most; therefore, usually the one or two rooms of the second floor are occupied by the owner's parents. A stairwell as a transition element between the levels should provide enough comfort for older adults of the family.

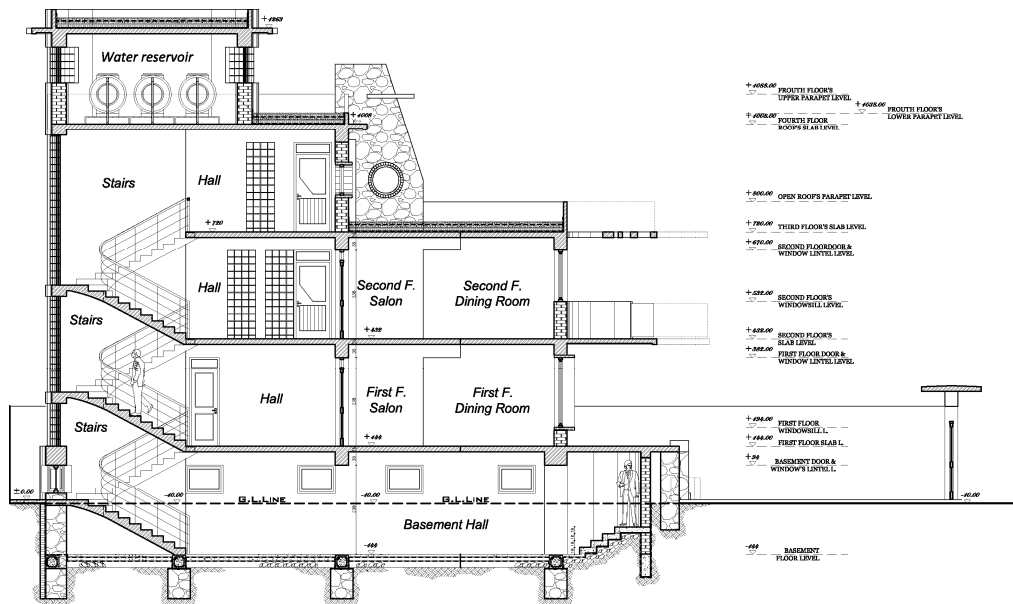
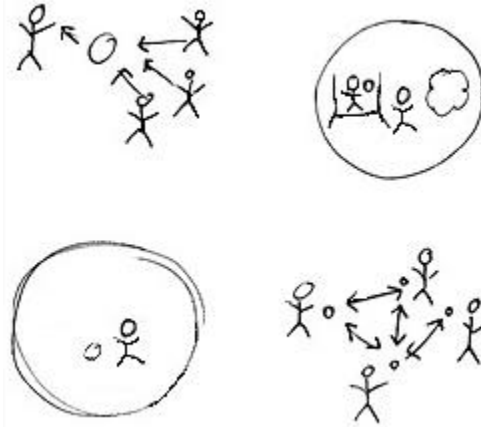

Figure 12d. A typical house section (Drafted by the author)

References:

- Alexander, Christopher, Ishikawa, Sara, Silverstein, Murray, Jacobson, Max, Fiksdahl-King, Ingrid, Angel, Shlomo. (1977). *A Pattern Language: Towns, Buildings, Construction*. Oxford University Press, NY.
- Neufert, Ernst, Neufert, Peter, Baiche, Bousmaha, Walliman, Nicholas. (2002). *Architects' Data*. 3rd ed. Wiley-Blackwell.
- Ministry of Justice. (2000). *Afghan Official Jrydh: Municipality Law*. Ministry of Justice Press. Kabul, Afghanistan.

13. Degrees of Publicness for Internal Household Activities



*Figure 13a. For providing better and comfortable design spaces our private and social activities should be carefully categorized.
(Drawn by the author)*

A house plan shows the horizontal circulation. If a house is seen from above it has a set of relationships with its courtyard and neighbor houses.

In a (25x15) m. municipal plot type, the house is not the only design element that exists in a courtyard boundary. There are other important elements like boundary wall, hardscape area, landscape area, and so forth that are both, technically and psychologically connected to the house. Additionally, its relationship with the public street and two or three adjacent neighbors needs to be studied. Degrees of publicness arise from the collective relationships of both exterior and interior elements.

Basic Design Factors:

A typical house in a normal plot has a basement, first floor, second floor, and a third half-floor that is shared with a useable roof area in front of it. If we elaborate a house into its rooms, individual rooms in all of the floors share particular relationships with each other. More public rooms (space) are located in the basement and first floor and more private spaces in the second floor. The table below shows the individual room's public, private, or semi-public/semi-private quality:

Degree of publicness Spaces	Public	Semi-Public/ Semi-Private	Private
Salon	+		
Dining	+		
Kitchen		+	
Family Living Room		+	
Bathroom 1, 2		+	
Toilet 1	+		
Toilet 2	+		
Master Bedroom			+
Bedrooms			+
Indoor Storage	+		
First Floor Hall	+		
2'nd Floor Hall		+	
Staircase	+		
Patio	+		
Foyer	+		

Table13b. A semi-private condition occurs when a space is, particularly, occupied by the female inhabitants. Preferably, the second floor bathroom(s) is used by females because it provides more privacy. (By the author)

Physical factors:

Providing different rooms at the same level facilitates the physical activities particularly during the rush hours of the day inside the kitchen and other public rooms. Avoid designing one step changes in level. The required physical space in a sitting room is 3m³/ person. If we have a 2.55m ceiling height in the rooms the salon will be an exception because it is a space that requires more room during the celebrations and other gathering activities. Therefore, two solutions will be possible:

- Increasing the height of the ceiling.
- Increasing the depth of the floor by providing two or more steps.

For only one floor house it is possible to choose option 1, and if the house has two or more floors the best option will be to provide more space by increasing the depth of the floor.

Socio-cultural factors:

In traditional Afghan houses such as those located in the old city of Kabul there is circulation through rooms which decreases the functioning of the rooms. Rooms had two functions; the function of a room for daily activities and a pathway to access the next room. It means when a

room was occupied by one or more family members, many interruptions occurred. For instance, if a group of family members are watching TV, access to the next room is impossible unless interrupting their activity by crossing the room. In that type of design there is no main hall to connect the individual rooms. It creates the problem of privacy. Therefore, the new designs of houses having a main hall like a square for connecting many paths to cross provides the privacy of the individual rooms. New designs providing hallways at the center give the house the privacy without overlapping different activities. The first floor level has more public spaces than the second floor where the room's function are more private. In such an organization privacy can be ensured as the horizontal circulation keeps all the rooms at the same level and the staircase remains the only way for connection to different levels.

References:

- Neufert, Ernst, Neufert, Peter, Baiche, Bousmaha, Walliman, Nicholas. (2002). *Architects' Data*. 3rd ed. Wiley-Blackwell.
- Ministry of Justice. (2000). *Afghan Official Jrydh: Municipality Law*. Ministry of Justice Press. Kabul, Afghanistan.

14. Primary Structural Systems for a Contemporary Kabul House

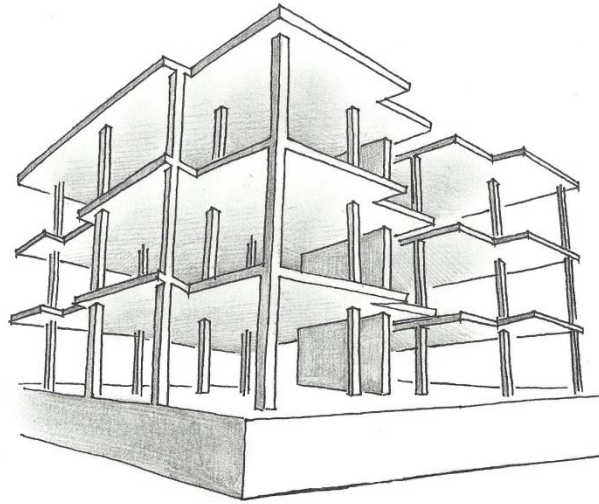

Figure14a. A frame structure building (Drawn by the author)

A building, like a body, needs a strong skeleton in order to protect it from both live and dead loads. A concrete frame structure with fired brick walls is the best suggested structural system for a modern Kabul house.

Traditional thick load bearing walls were used in the old city of Kabul. In addition, for multi-story houses a “senj” framing system was widely used for more strengthening of the main structure (*Traditional Architecture of Afghanistan*, p.189). This method of vernacular architecture with its available local material and workmanship was a low cost construction which had a variety of environmentally positive aspects. To some extent it does not apply to new construction because Kabul’s population is growing and within this growth size does matter. Now, those old traditional construction methods are not used because of the new form of the city.

Basic Design Factors:

A concrete frame structure adapts very well in a limited plot size because reinforced concrete structures are easily constructed within a square or rectangular form. Most of the time architects are not happy with frame structure systems, particularly in residential houses, because they do not want to stick their ideas within a frame. The strength aspect of a building is always controversial among architects and structural designers. The regularity of a frame structure limits the architect’s freedom in design forms, but it is not necessary to use a totally column and frame

system. Consulting a structural designer will identify the best design solution for the plan layout of the columns based on the wall configuration.

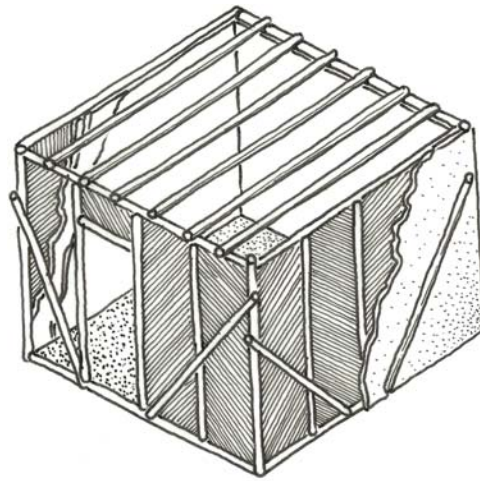

Figure 14b. Senj framing system used inside the walls and top of the roof. (Drawn by the author, adapted from Traditional Architecture of Afghanistan, p.187)

Physical factors:

Preferably, in a Kabul Municipality block subdivision with its limited given areas, the best structure system that reduces the wall thicknesses will be a frame structure with fired brick. It also helps a multi-floor building to be more stable in case of earthquake and other social and natural impacts. Eventually, as the area of the plot is reduced, vertical expansion of the house is needed. Therefore, a multi-story structure system will be the only solution that makes the structure more stable. Earthquakes are a natural phenomenon that causes irreparable bodily and economic damage. According to Nicholas Ambraseys, a Greek engineering seismologist,

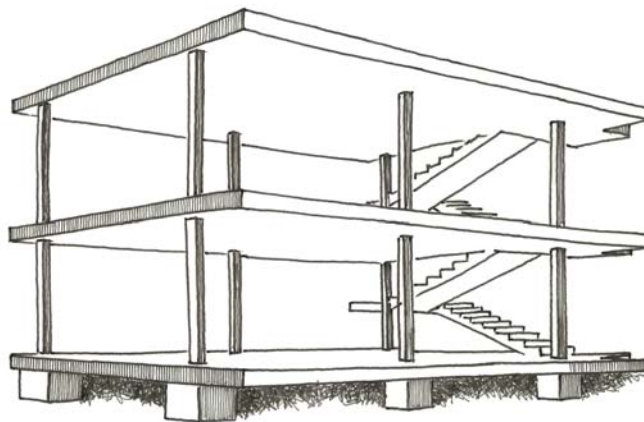

Figure 14c. Le Corbusier Dom-ino House, 1914 (Drawn by the author, adapted from Architecture: Form, Space, and Order, p. 132)

“...north-eastern Afghanistan, near and north of the capital, Kabul, has a long history of damaging deep and shallow earthquakes.” He also warns that future possible damages as a consequence of earthquakes will recur in that region. (*N. Ambraseys*, p. 13) Therefore, to resist such a disaster the best suggested solution is a proper frame design that comes after a complete structural design. A frame design includes foundations, columns, beams, and slab design that is possible after a completed set of architectural drawings is given to the structural designer.

Socio-cultural factors:

Reinforced concrete frame structures grew in popularity after the modern architectural designs in Kabul’s Shahr-e Naw (new city) and Wazir Akbar Khan. Stable economic, political, and cultural relationships with neighbor countries, in particular the former Soviet Union, imported new building materials as well as other aspects of life. The imported steel rebar from Russia is both higher quality and also cheaper compared to other neighboring countries. Two Afghan cement factories, Jabal Al-Saraj (1957) and Ghorī (1962) fulfilled the national demand of Afghan modern construction. These cement factories stopped manufacturing for a number of years during the civil war, but reopened (2004) by a governmental subsidy to some private manufacturers in order to encourage the private sector. A building is called environmentally friendly if local materials are extensively used in the building. In particular it is mostly appreciated in the third world countries. In Afghanistan a variety of building materials are available but more than 90% of these materials are imported from foreign countries which is not cost effective in the long term. Therefore, it is the government responsibility to encourage the private sector to spend on local factories. Geologically, Afghanistan is rich of having variety of raw materials, but ensuring security and economy still will be a key issue.

References:

- Samizay, Rafi and Hallet, Stanley Ira. (1980). *Traditional Architecture of Afghanistan*. Garland STPM Press, New York.
- Ambraseys, Nicholas. *Earthquakes in Afghanistan*. Dept. of Civil Engineering, Imperial College, London. SW7 2BU, UK.
- D.K. Ching, Francis. (2007). *Architecture: Form, Space, and Order*. 3’rd ed. John Wiley and Sons, Inc. USA.

15. Primary Structural Materials for a Contemporary Kabul House



Figure15a. A local building construction (Photo by the author)

A building can be regarded as a third skin (clothing is the second skin), providing protection and channeling positive energy in a beneficial way. This skin should be carefully selected with sufficient building material.

Choosing the best materials to protect the building from natural and social impacts has always been controversial among people who suffered from the threats of nature. “The use of energy in buildings raises concern not only for the consumption in use, but also for the embodied energy in materials. This introduces detailed issues about the choice of materials in construction.” (*Environmental Design of Urban Buildings*, p. 46) Sustainable building materials call for those that have the efficiency of strength, beauty, and thermal stability and are resistant to its surrounding environment. The building by itself is called “Green building” which is the practice of creating structures and using processes that are environmentally responsible and resource-efficient throughout a building's life-cycle: including design, construction, operation, maintenance, renovation, and demolition (Fischer, p.6). The excessive and unnecessary use of glass and other particular materials has brought the lack of identity to most buildings in Kabul. This is the consequence of mismanagement and lack of professional supervision. Imported building materials from neighbor countries are not adapted to Afghanistan’s climate, culture, and physical needs and create many environmental problems.



Figure15b. An example of material misuse that does not match the environment's climate and physical needs. (photo by the author)

Basic Design Factors:

Construction materials should be identified by the architect in architectural design drawings. A well detailed drawing package includes a series of studies done by the design team concerning the specific region's climate and culture. Ching says we must use design drawings to transfer experiential qualities to the spatial compositions of the designed environment. Thereby, these design drawings, by detailed illustrations of solid and void spaces, fulfill the primary and secondary needs of design. Construction drawings also help the builder of the house or manufacturer to implement the design in a shorter amount of time, better quality, and a more precise way. These drawings, as an important part of legal documentation, rely on "abstract conventions" with specifications, dimensions, and further explanations included. (*Architectural Graphics*, p.36)

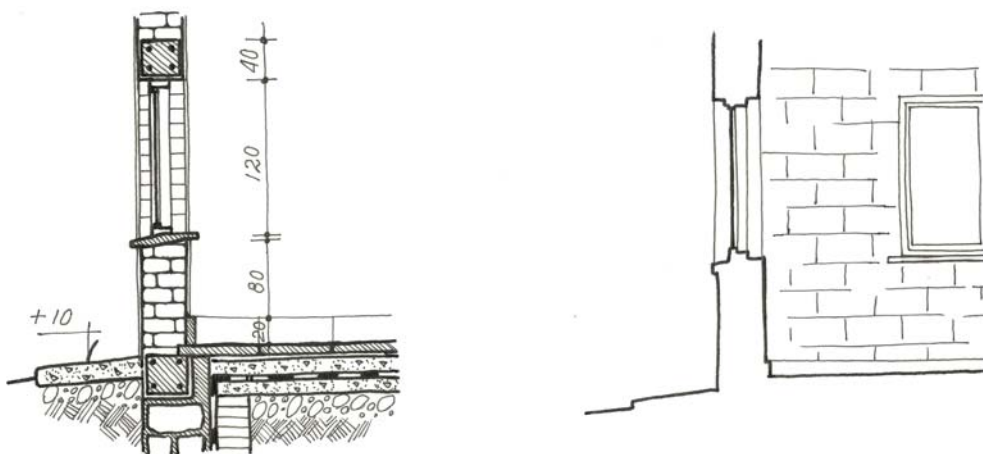

Figure15c. An example of construction drawings. (Drawn by author, adapted from *Architectural Graphics*, p.36)



Figure15d. Sufficient use of local material brings comfort and beauty to the house interior and exterior spaces. (Drawing by the author)

Physical factors:

The physical impacts upon a building directly depend on the amount of openings, zoning, and building materials. Geographically, different regions have their unique climates. Unfortunately, it is now very common for both builders and clients to copy some building designs from neighbor countries or any other part of the world based on their personal interests. It is very unfortunate that both clients and builders do not pay attention to the KM laws and regulations which are vital for the health of a dense city like Kabul. Also, governmental authorities hesitate in both development and implementation of these regulations.

Walls, roofs, and floors are considered the important parts of a building skin. The components of the skin openings are windows, doors, and skylights which need to be designed in detail for the energy needs in different seasons of the year. Even the color of interior and exterior spaces plays an important role in absorbing or reflecting radiation. Darker colors absorb radiation while lighter colors reflect radiation. Both interior and exterior surface colors keep the building either cool or warm (*Sun, Wind and Light*, p. 213). Wall openings (doors, windows, and skylights) based on strategic zoning of the house are as important as wall thickness and materials. It is very true that the thickness of the exterior walls wastes the interior and exterior useful areas, but at the same time it is important to enhance the energy efficiency based on natural seasonal warm and

cold air conditions. My suggested exterior wall thickness is 40 cm. because a less than suggested dimension cannot control the energy wastage in the cold winter nights and summer hot days when the temperature goes to its maximum point. Contrarily a more than 40cm thickness will bring the problem of area (space) and budget wastage. In some smaller interior slab areas (as per structural designer advice) the wall thickness could be reduced to 15 cm to 25 cm. I also suggest a faced (exposed) or plastered local fired brick wall construction for interior and exterior walls. Strategic placement of the doors, windows, and skylights for required amount of daylight, cross ventilation, and passive energy is another important factor that reduces the consumption of overall house energy. In Kabul, the south façade of a building receives the most amount of sun and energy and the north receives the least. East and west faces are more dependent to the sun direction, east in the mornings and west in the afternoons. Therefore, the greater amount of openings should be designed, in the order, of the south, east and west façades and the least of openings (according to the rooms function) can be placed in the north facade. Exterior door and window material selection is another issue that an architect needs to precisely design and include in his/her design drawings. For an exterior door and window a double glazed frame with 4mm glass is suggested. Further information is added in table 15f. All the windows have open and fixed parts that provide desired thermal comfort to the inhabitants.

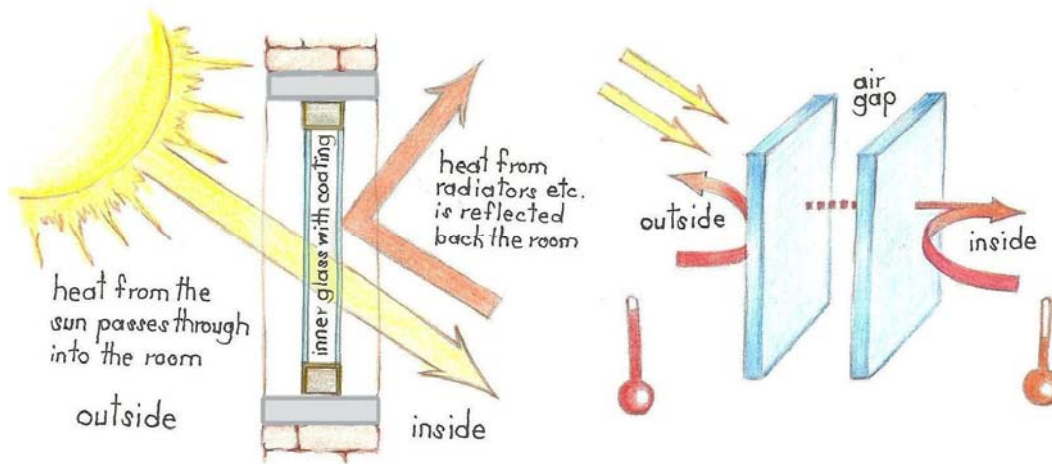

Figure 15e. Double glazed window benefits. (Drawn by the author)

Energy Saving	<ul style="list-style-type: none"> ○ The sealed air space layer makes the insulation capability of double glazing units about twice that of single glazing. If heat absorbing tinted glass or heat reflective glass is used, the load on the cooling system will be greatly reduced.
Interior Comfort	<ul style="list-style-type: none"> ○ Double glazing units have high insulation properties and this reduces the uncomfortable solar heat radiation from the window. Therefore providing a pleasant interior working and living environment.
Sound Reduction	<ul style="list-style-type: none"> ○ Double glazing units have a good sound reduction capacity. It's especially effective if different glass thickness is used in the double glazing units combination so that the glass will not resonate simultaneously at their critical frequency.
Dew Condensation	<ul style="list-style-type: none"> ○ With single glazing, dew condensation will occur when there is a large temperature difference between the outside and inside of a room. But with double glazing units, the good insulation of the air layer prevent the glass from becoming cold and consequently harder for dew to condense on the glass surface

Table15f. Benefits of using double glazing glass. Such glass should be used in modest amounts to reduce both material and energy costs. (www.glassnetwork.com)

Socio-cultural factors:

Subtle material selection for the design of a house brings the sense of sustainability that is one of the requirements of a local modern design concept. The old city of Kabul with the traditional usage of material and craftsmanship does not exist anymore. Agha Khan is one of those exceptional foundations that work in a very patient manner with their innovative local factories in order to preserve some elite Afghan traditional housing styles. Unfortunately, it is not practical to spend money on such kind of vernacular styles as the demand for the new housing styles has grown. The particular projects that Agha Khan Foundation is doing has a lot of value that illustrates an edge of Kabul vernacular architecture, but as a consequence of new trends Kabul population is getting enlarged and within this growth the old terminology of architecture should be reinterpreted. Reinterpretation of Kabul architectural design does not mean imported Pakistani and other futile contradictory designs. This is a sign of ignorance. It means step by step creative resiliency towards the ultimate architectural resolution. Kabul as a symbol of the entire country should show its own architectural identity. Building material as with clothing has a significant role for the body's health and aesthetics. The quality of this clothing based on seasonal climate varieties and aesthetic aspects should be considered. Exposed local fired brick has a natural

beauty for the building form if it is implemented elegantly. A number of Islamic textures can be incorporated in its composition in response to the whole building proportion. The special hierarchy of building elements in combination with elegant material usage and professional craftsmanship will bring the desired identity to the house and to the city as a whole.

References:

- Brown, G. Z. and DeKay, Mark. (2001). *Sun, Wind and Light*. John Wiley and Sons, Inc. Canada.
- Ching, Francis D.K. (2003). *Architectural Graphics*. John Wiley and sons, Inc., New York.
- Santamouris, Mat. (2006). *Environmental Design of Urban Buildings: An Integrated Approach*. Bath Press, UK.
- Fischer, Eric A. (July 20, 2010) *Issues in Green Building and the Federal Response: An Introduction*. Congressional Research Service.
- Glass Network Sdn. Bhd. (2007). *Double Glazing Glass*. Retrieved from: www.glassnetwork.com
- Glass Network Sdn. Bhd. (2007). *Benefits of Using Double Glazing glass*. Retrieved from: www.glassnetwork.com
- www.ardleigh.ie/page2.php

16. Roof Design

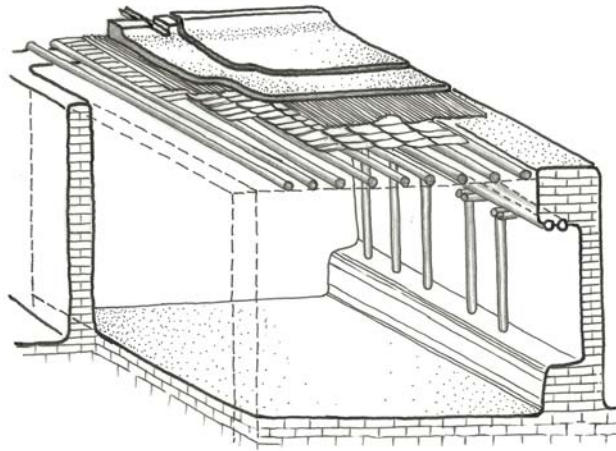

Figure 16a. A Kabul typical traditional flat roof design. (Drawn by the author, adapted from Traditional Architecture of Afghanistan, p.186)

The roof is one of the important elements of the third skin (as the hat for a head), protects the building from physical, natural, and other environmental impacts. It is sensible to wear a fur hat with ear flaps on snowy days and a straw hat in hot weather.

The roof receives the most moisture and water in the winter and the most heat in the summer; that is why it is a primary design priority. Most Kabul roofing design does not match the climate and regional demands. There are many causes that have created this huge problem. Imported foreign building forms and materials introduce basic problems for roof design in Kabul. Lack of professional craftsmanship and durable material and technology are other problems. Familiarity with International Building Codes and standards encourages a building roof to be aesthetically beautiful in form and physically sustainable in function. Ignoring the climate factor in roof design forgoes the possibility of achieving a sustainable building.

Basic Design Factors:

A typical roof design which is a result of imported designs from abroad having different climate conditions harms not only the building by itself but also the form of the city. The traditional Kabul house roof types are not as responsive compared to a variety of new available methods based on the region's climate. A sufficient set of architectural drawings presents the primary

structure of a roof that responds to the region’s climate and overall building form. In a modern Kabul house at least two types of roofs are common:

1. Flat roof design

- Asphalt roof, for roofs that are not used for any activities.
- Terrazzo tiled roof, for roofs that are used for some activities according to Afghan traditional culture.

2. Pitch roof design

- Flat Sheet Metal Roof, for roofs with less than 30 degrees of slope; this roof type is widely used and is built for the cold climate areas that have little or no snow during the winter.
- Corrugated Sheet Metal Roof, for roofs with more than 30 degrees of slope; this type of roof is commonly designed and built for the cold climate areas that have heavy amounts of snow during the winter.

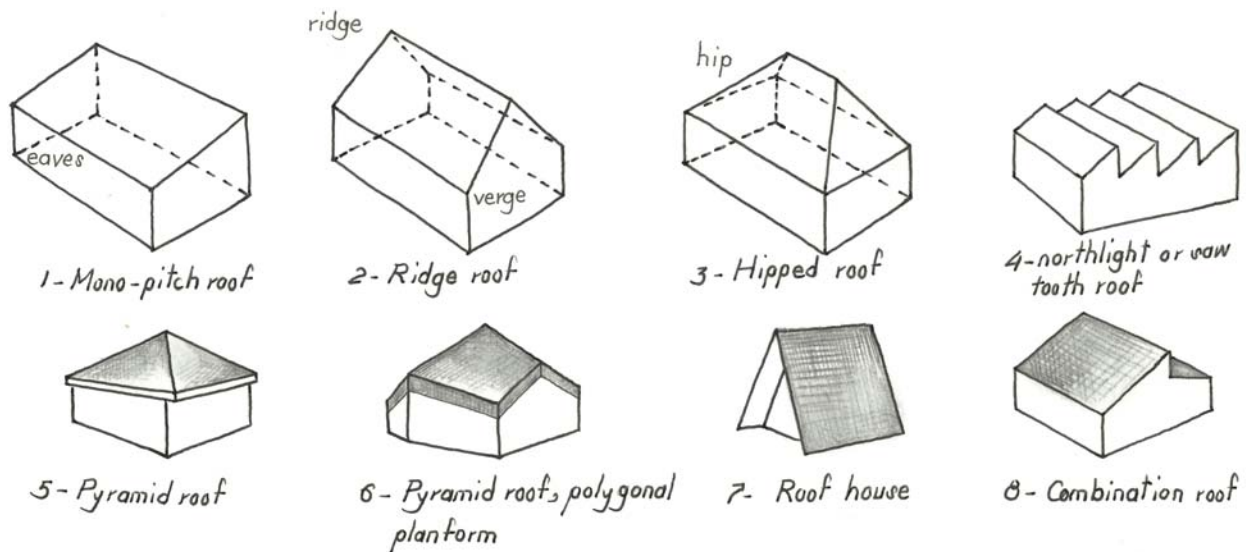

Figure 16b. Basic roof forms. (Drawn by the author, adapted from Neufert: Architect’s Data, p. 75)

Physical factors:

An appropriately designed roof provides necessary protection from the weather. It is necessary for maintaining the health of the building occupants. A sustainable roof must first be simply a “good” roof. The term “good” means charged with the critical role of keeping the weather outside a structure. Dependability is the most essential feature of a roof. This means a roof should match the climate circumstances. Roofing materials comprise 12% to 15% of

construction and demolition waste. A well installed, more than fifty years rated roof can reduce roofing waste by 80% to 90% over its life time. Keeping the roof insulation dry is another key factor for most insulating works because if during the construction the roof gets wet it will be less effective. In addition, some other key considerations are sufficiently useful, for instance, color, insulation, weight, and some others. Lighter colors provide for better reflection of solar radiation (more precisely, high reflectivity) reduces heat gain and improves summertime comfort. Some roofing options incorporate additional insulation or radiant barriers, helping to maintain comfort and reduce ongoing energy use. Heavier roofing requires a more substantial structure, and larger or more numerous support members increase resource use and cost. The resistance to water, sun, pests, and chemical breakdown that make tires, rubber, and many plastics poor candidates for disposal in our landfills also help these materials perform brilliantly as roofing. Even the most durable roofing will eventually need to be replaced. For instance, asphalt composition shingles and some plastic products can be ground up and recycled into new roofing, or into asphalt pavement.

For a cold climate area like Kabul if the slope of a roof is less than 30 degrees it cannot sustain the overloaded snow for a long time. Once the load of snow stands for a while, it influences greatly upon the roof's materials and water tries to find a way to enter inside the slab. Meanwhile, once the water starts to absorb into the slab, the concrete, steel bars, plaster erodes. According to Williamson, Radford, and Bennetts who introduce architecture sustainability into three images, natural, cultural, and technical, a roof design has three of mentioned images that need to be taken into consideration. The natural image talks about the building's environment, which has to match each other. In other words, a building's roof has to be environmentally friendly; otherwise, it cannot sustain versus the fury of the nature. Jim Dodge in his *Living by Life* article says: "No matter how great our laws, technologies, or armies, we can't make the sun rise every morning nor the rain dance on the golden-back ferns." (1981, p. 6).

For a roof design more in harmony with nature, a green roof could be considered. For reducing the heat island a green roof is mostly appreciated which makes the image of nature more powerful; therefore, a house becomes friendly with its environment. It is important to note at this

time that the necessary skills and materials for successful green roof construction is missing in Kabul. This may change in the foreseeable future.

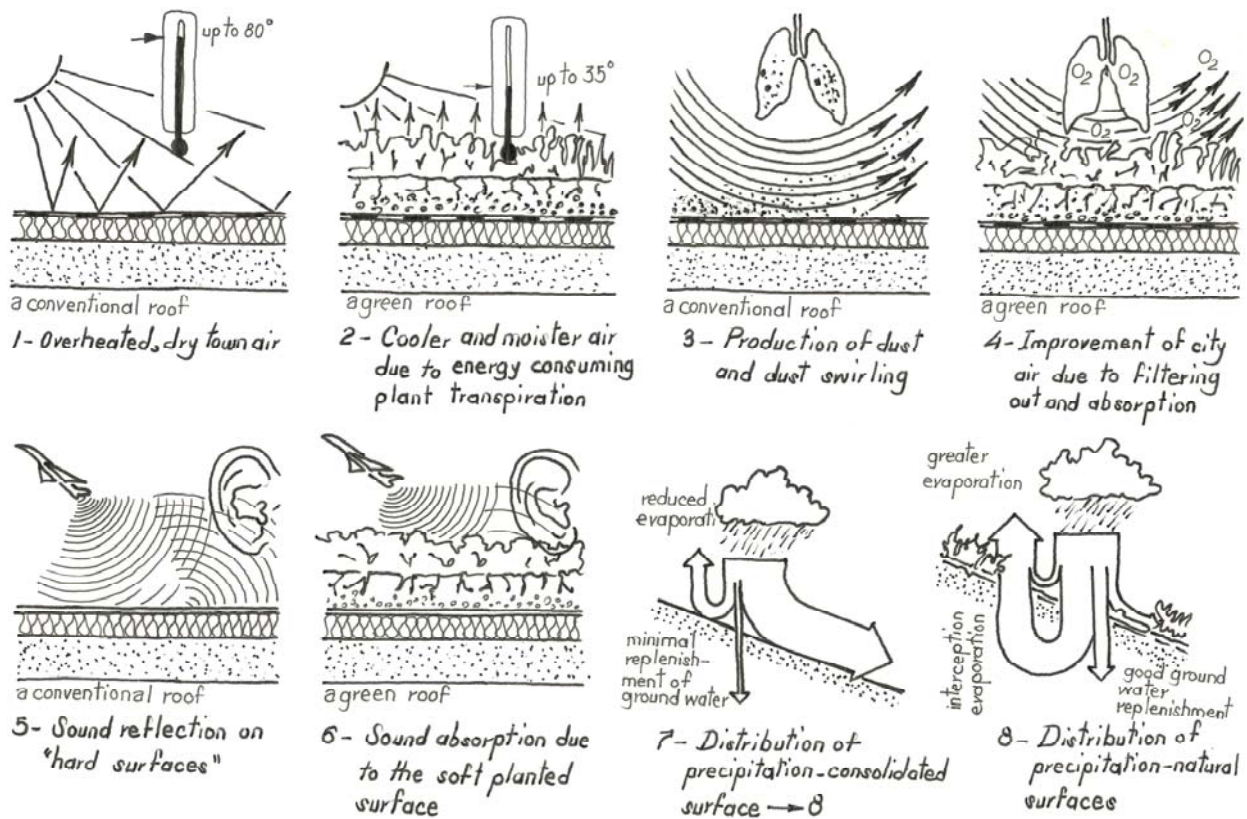

Figure 16c. The affect of a green roof upon the environment (Drawn by the author, adapted from Neufert: *Architect's Data*, p. 82)

Socio-cultural factors:

Psychologically, even though, a person can resist in cold weather with a thin dress, it seems out of sync with its surroundings. A similar situation could happen during the hot summer weather if a person comes out of his or her house wearing very heavy coat and clothes. Likewise, the roof represents the value of an umbrella on a rainy day. If a person goes out of his room without having an umbrella, soon he or she gets an illness, and illness is the first step towards death. Architectural building design stands for two major terms, form and function. Therefore, a building is not called aesthetically sustainable, unless the building form has its elegant form elements. One of the important factors of the beauty of our surrounding nature is called proportion. Most graceful artificial products are copied from our natural surroundings. If the term proportion is eliminated from the elements of aesthetics, an architectural design is incomplete. Therefore, since a roof contains the most dominant form of the building design, it

has to fit with the other parts of the whole building's body. A building's roof acts like a hat on the head of a person. Just as a good foundation responds to the earth, a good roof responds to the sky.

The aesthetic of architectural form represents almost half the value of architectural design. Therefore, the house does not have any architectural value if we eliminate the term "aesthetic". The form of a building not only represents the building beauty but also a great meaning for cultural circumstances. The form of a building represents the dress of a culture, which is important for national identity. The famous 20th century architect Le Corbusier wrote: "You employ stone, wood, and concrete, and with these materials you build houses and palaces: that is construction. Ingenuity is at work. But suddenly you touch my heart, you do me good. I am happy and I say: This is beautiful. That is Architecture". (*Toward an Architecture*, p. 143)

In the late 20th century a new concept was added to those included in the compass of both structure and function, the consideration of sustainability. In order to satisfy the contemporary natural characteristics of a house, the roof should be constructed in a manner which is environmentally friendly in terms of the production of its materials, its impact upon the natural and built environment of its surrounding area and the demands that it makes upon non-sustainable power sources for heating, cooling, water and waste management. Therefore, roof design and construction must be studied from a sustainability standpoint. For such a poor country like Afghanistan, with its unique housing design needs, experimental assessment will be the only solution for finding appropriate answers for most research questions. Table 16d shows some suggested roof structures that introduce durability of some pitch roofs and the economical aspects.



	Simply Supported Roofs	Are always more expensive than couple roofs and are only used in exceptional cases.
	Roofs with Two Hangers	Almost always is the most economical construction.
	Purlin Roofs with Three Hangers	Are only considered for very wide buildings.

Table 16d. Roof Structures (By the author, adapted from Neufert: *Architects' Data*, p.72)

References:

- Samizay, Rafi and Hallet, Stanley Ira. (1980). *Traditional Architecture of Afghanistan*. Garland STPM Press, New York.
- Neufert, Ernst, Neufert, Peter, Baiche, Bousmaha, Walliman, Nicholas. (2002). *Architects' Data*. 3rd ed. Wiley-Blackwell.
- Williamson, Terry, Radford, Antony and Bennetts, Helen. (2005). *Understanding Sustainable Architecture*. Spon Press, 270 Madison Ave, New York.
- Dodge, Jim. (1981). *Living by Life: Some Bioregional Theory and Practice*
- Cohen, Jean-Louis. (2007). "Introduction" to *Toward an Architecture*. Los Angeles: Getty Research Institute.
- <http://en.wikipedia.org/wiki/Hat>

17. The Form of Primary and Secondary Elevations



Figure17a. Main entrance of a modern Kabul house. (Drawing by the author)

The house elevations are important features of the house that represent its exterior form. As people are known by their customs and clothes, houses are known by the image of their exterior form.

In the past, a house was considered as shelter for protection of unarmed man from enemies, animals, and wild nature. Now, the house has more value than those primary factors. A house form reflects upon physical and cultural impacts which people experience based on environmental changes. “Every people that has produced architecture has evolved its own favorite forms, as peculiar to that people as its language, its dress, or its folklore.” (*Architecture for the Poor*, p. 19) The new forms of houses in Kabul are imported from foreign countries and lack of local identity. Christopher Alexander resembles the design and construction of today’s housing problems to a grim business, “...an uphill struggle against the relentless surge of technology and bureaucracy, in which human feeling has almost been forgotten.” He continues that there is no real meaning of beauty, no definition of place for living, and social connection between the people (*Production of Houses*, p.14). So long as, people are not familiar with better forms of houses, this negative course will continue.

Basic Design Factors:

There should be a set of rules to identify and limit the features and form of the houses in a modern Kabul house. A typical set of architectural drawings of the house design (plans, elevations, sections, and a few construction details) are given by the Kabul Municipality. These

are never constructed by the client. The plot owner has almost complete freedom even if small conflicts happen during and after the house construction between the neighbors. The existing forms of the copied houses from abroad are more responsive to those countries' climate and culture, not Kabul. In a Kabul plot subdivided condition a single house has one primary and three secondary elevations that are identified based on the house directions as discussed in earlier patterns. Architecturally, a house form depends upon several physical, psychological, and cultural circumstances. An architect composes these elements in order to create a living space. A combination of figural and set piece formal organization is suggested for an ideal modern Kabul house. We can call it "set piece" because the design requires a single compact mass. Symmetrical qualities of a set piece design should be limited to the use of local symmetries. The main characteristic of "figural" is the clear juxtaposition and/or overlap between two forming systems of figures. A figural design can express the interaction of a conventional frame with a contrasting contemporary insertion. Such a composition can reflect the continuity and change occurring in Afghanistan today.

Physical factors:

Despite the fact as Rapoport argues that, "...the house is not purely a physical thing." (*House Form and Culture*, p. 49), physical factors have the first priority in a building form. A house form depends on a series of patterns that connects to each other and each element by itself should respond to the whole and the whole to the parts. First, a house form must respond to the climate, whether it is hot, cold, or mild, sunny, windy, or cloudy. "As for natural lighting, the effectiveness of natural ventilation and appropriate temperature levels in the interior of a building are, to a large extent, determined by the building design." (*Environmental Design of Urban Buildings*, p. 41) The form of the house emerges from the appropriate combination of shapes that plans and elevations provide. All the elements of design tie together and by their appropriate composition a building form arises. The overall form must be studied in three dimensional representation of drawings and/or models. These elements must not be designed randomly, but with conscious design factors and a series of primary calculations. For instance, a cantilever slab or balcony that provides beautiful form for a particular elevation needs to be designed on an appropriate façade of the house in a manner that does not interrupt the daylight and sun warmth. The size of a balcony, its width and distance from the building surface are

important variables that need to be calculated. As discussed, the exterior wall thickness of the house (pattern # 15) influences the form of the building. “The building’s Skin Thickness should be enough to accommodate the required insulation. [heating and cooling]” (*Sun, Wind and Light*, p.214) A cross ventilation system is suggested, as a natural solution, for a non-technological country like Afghanistan. Therefore, it is important to choose, design, and construct beautiful windows to provide the natural ventilation and sunlight control. “The size, number, and orientation of windows greatly affect the building’s energy use for heating.” (*Sun, Wind and Light*, p.244) Balconies based on their function and form are designed not only on South and North facades of the house, but also, occasionally placed on East and West facades of the house. Therefore, it is reasonable to include this beautiful element of design into the form of the house according to its function. I would make a statement about the importance of projected and recessed portions of a building elevation in terms of shade and shadow. This gives greater visual depth to the elevation. This is shown in figure 17c.

Kabul has experienced unexpected warmer winters compared to 20 to 30 years ago. However, at least one time during the winter, this region receives a 60 cm. snowfall. This calls for ground stone masonry work that is provided for the foundations of the house walls.

Socio-cultural factors:

The street facade is the primary elevation of the house and it communicates the primary values of the owner. Therefore, it is important for a designer to be familiar with the design elements and cultural values. Public primary facades of the house and the main gate with its connected boundary wall have much social value. The surrounding public visually interacts with the house on a daily basis. Traditionally, a house form presented the cultural values from the past. However, new houses should reflect the emergence of a new country. The facades of the house should communicate with the observer, and the observer distinguishes the primary and secondary elevations of the house by spontaneous manner of visual communication. An elegant choice of construction material gives a desirable beauty to the elevation of the house to be enjoyed by all. Preferably, local building materials are suggested, particularly, for the primary elevations of the house because local materials are easily available, cost effective, and environmentally friendly. In addition, using local materials allows the use of skilled local labor. In a modern Kabul house

the house by itself is not the only element of form, but also the boundary wall and other elements of the courtyard are included to the form of the building (figures 17b).



Figure 17b. A House and its boundary wall elevation from the street view. (Drawing by the author)

References:

- Alexander, Christopher. (1985). *The Production of Houses*. New York, Oxford University Press.
- Brown, G. Z. and DeKay, Mark. (2001). *Sun, Wind and Light*. John Wiley and Sons, Inc. Canada.
- Rapoport, Amos. (1969). *House Form and Culture*. Prentice-Hall, Inc. Englewood Cliffs, N.J.
- Fathy Hassan. (1973). *Architecture for the Poor: An Experiment in Rural Egypt*. The University of Chicago Press, Ltd., London.

18. Exterior Finish Materials for Primary and Secondary Elevations



Figure 18a. A brick wall that shows variety of traditional patterns.
(Photo by the author)

The exterior building skin, as with human clothing, should respond to climate and culture. Therefore, it is important to find out what costume goes along with the customs and weather of the place.

The existing architectural form of Kabul has been greatly influenced by the misuse of construction materials. The excessive usage of glass, not only in public buildings but also in houses, has greatly impacted the physical body of the city. There is a thoughtless chaos of new house design. None of designs has a unique definition of Afghan architecture. This lack of harmonization is a result of an insufficient set of rules and specifications for identifying the building materials and other building codes. This is one of the important tasks of Afghan government authorities. In order to take this positive step the private sector should be encouraged and supported in the long term for investment in qualitative and quantitative production. The intention is to create and identify an authentic form for the house that naturally responds to the environment and that is not possible unless the appropriate materials are used.

Basic Design Factors:

For an appropriate desired architectural design which is prepared by an architect, all the details should be included in order to implement the successful final construction. Ching points out that as the scale of an elevation increases, more details are needed. It will be more complicated when all the masonry bonds with its detailed textures and patterns are included. The weaving and bonds of bricks in different parts of the exterior and interior walls and other elements of structure

should be precisely designed and drafted. When large-scale building elevations are needed, a series of elevation studies plus building construction knowledge will be extremely useful. In order to realize the actual size of materials and for better understanding of the required proportions, human scale figures help to see how the specific materials work appropriately. (*Architectural Graphics*, p.67) A manufacturer's catalog, describing building parts like doors and windows, will help the designer to choose the best option that fits the design. It is also important to choose the real exposed materials for both the exterior and interior elevations of the house. Illustrated below are the basic characteristics of the brick.

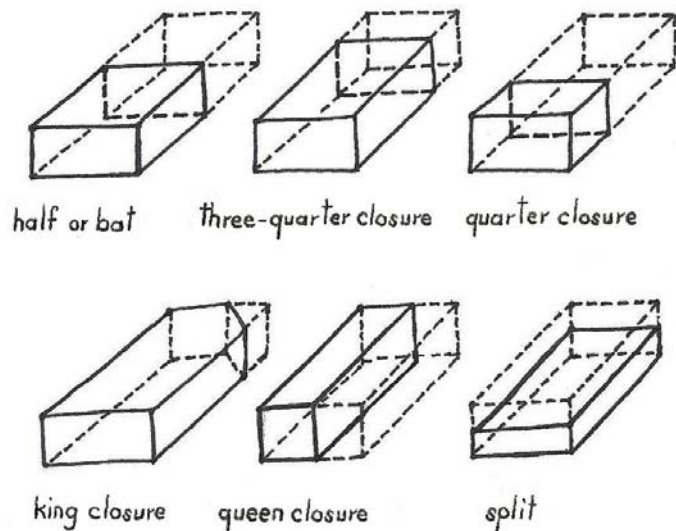
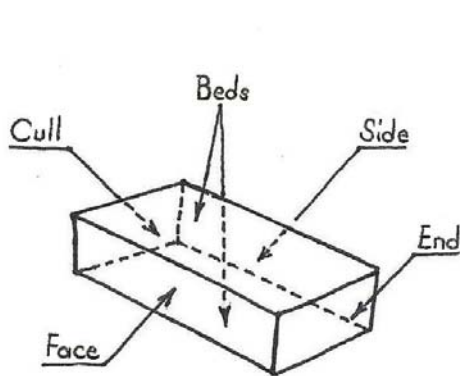

Figure18b. Names of brick surfaces.

Figure18c. Common cut brick shapes. (Drawn by the author)

Physical factors:

People have used brick as a building material for many millennia. The primitive brick was made of clay and dried in the sunshine. Those earliest brick was called adobe brick and still in broad use throughout the world. (*Building with Masonry*, p. 4) Because the brick is not load bearing, the pattern of its construction can receive more aesthetic attention. For a Kabul climate the best available material for the exterior walls to keep the building interior warm in winter and cold in summer is fired brick. I strongly suggest this light, environmentally friendly, cost effective, easily formed, and widely used material for modern Kabul house construction. Based on decades of regional experience fired brick reduces the heat effects in the summer time as the chemical property of clay works like a thermal insulation in comparison to exposed concrete. Furthermore, the adhesive property of the fired brick with the mortar helps strengthening of a non-framed structure.

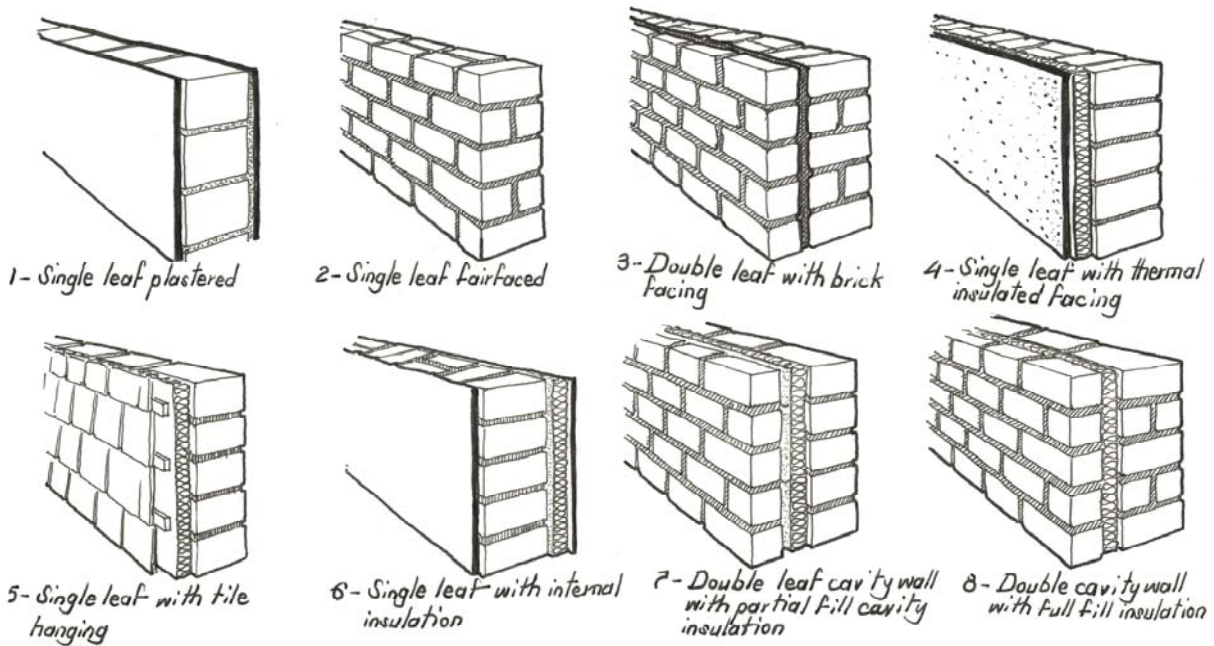

Figure 18d. Brick masonry (Drawn by the author, adapted from Neufert: *Architects' Data*, p. 63)

The designer can, with some experience, create form that guides and shapes those energy flows of sun, wind, and light. (*Sun, Wind and Light*, p.xiv) Appropriate placement of the exterior windows provides cross ventilation and increases the natural air circulation inside the rooms in the hot days of summer. Well insulated exterior walls are necessary, otherwise “increasing the wall surface exposed to the sun will consequently transform concrete buildings into ovens in summer.” (*Crisis in the Built Environment*, p. 143) Stone is an impervious construction material that separates vulnerable building materials from moisture. However, there is no ground moisture danger in most parts of the city but still damp insulation materials are suggested; particularly, for those houses with a basement.

Socio-cultural factors:

Traditionally, a combination of brick and stone are considered the primary materials for building construction. Vernacular and regional architecture of Afghanistan shows that *Pakhsa* (a mixture of mud and straw) has been used for thousands of years. However, those materials do not respond to the demands of modern house construction. Mud brick construction for decades has dominated the entire zone of Kabul. However, it deteriorates from rainwater without a protective plaster coating.

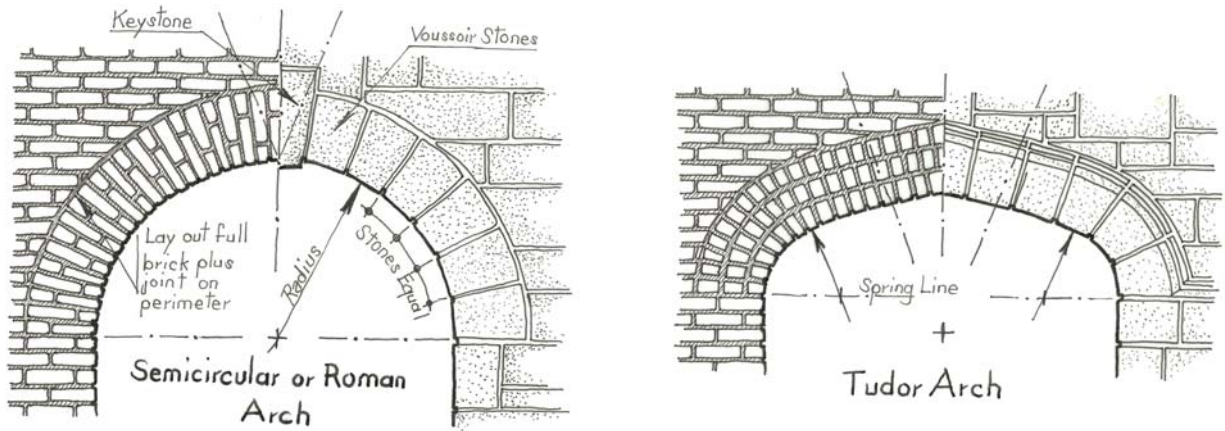

Figure 18e. Common arch shapes. (Drawn by the author, adapted from *Masonry Design and Detailing*, p. 358)

Islamic art and architecture is dominated by a variety of decorations. “It is one of the unifying factors that, for thirteen centuries, have linked buildings and objects from all over the Islamic world across an enormous geographic span, from Spain to China and Indonesia.” (*Surface, Pattern and Light*, p. 161) However, there has not been only one type of decoration for any particular type of building. The patterns always have their unique geometric principles that need to be provided according to the building surface proportions. Culturally, patterns have a lot of meaning in Islamic architecture; therefore, it is recommended to take advantage of its beautiful forms and include it on the building elevations.

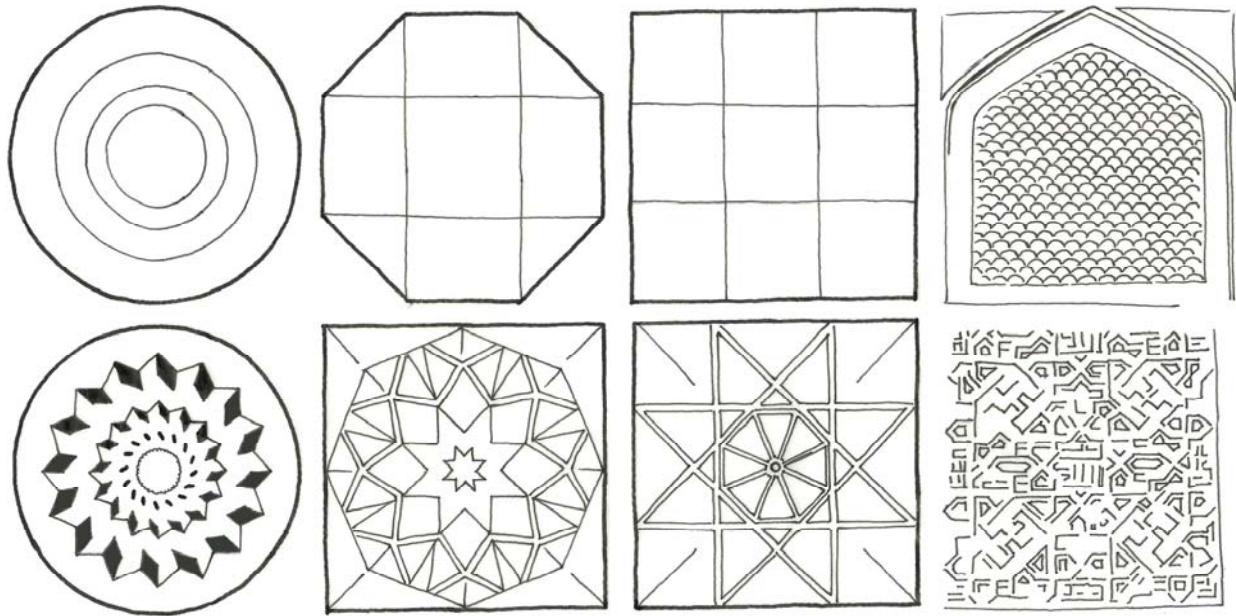

Figure 18f. A few examples of common Islamic patterns which are widely used on the building elevations (Drawn by the author, adapted from *Sense of Unity*, p. 30 and 36).

Preferably, local fired brick with its durability and beauty remains the common interior and exterior building material. Brick provides a variety of beautiful architectural bonds that simply gives a sense of identity to the house. It is not always acceptable to design and construct all of the exterior walls with the exposed fired brick but it is suggested to provide most important parts of the exterior facades. Moreover, plastered concrete provides a beautiful form for the exterior elevations of the house, but the composition still will be a difficult issue. Care must be taken in the use of color in the facades. Some fired brick factories are producing good quality construction brick around Kabul.

Stone masonry with its beautiful natural forms remains as a second common material for the foundation of the house and in some other parts. It is specially recommended for those parts of the house that are considered a focal point. For instance, a house entrance can be emphasized by stone. Stone is also used for the boundary walls because it creates a durable and secure barrier against environmental impacts.

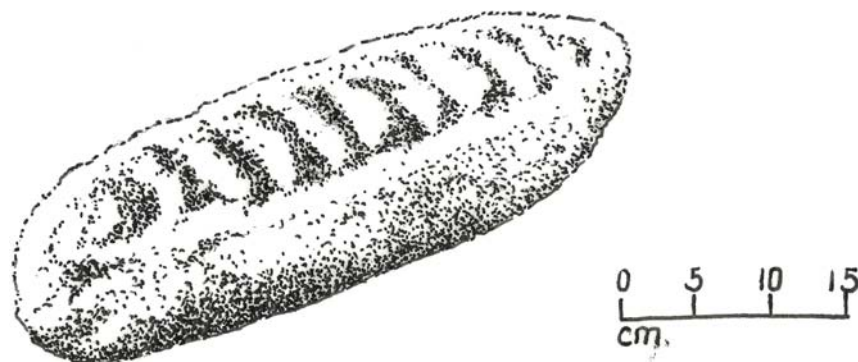

Figure 18g. Sun-dried brick, circa 8000B.C. (Drawn by author, adapted from Masonry Design and Detailing, p. 4)

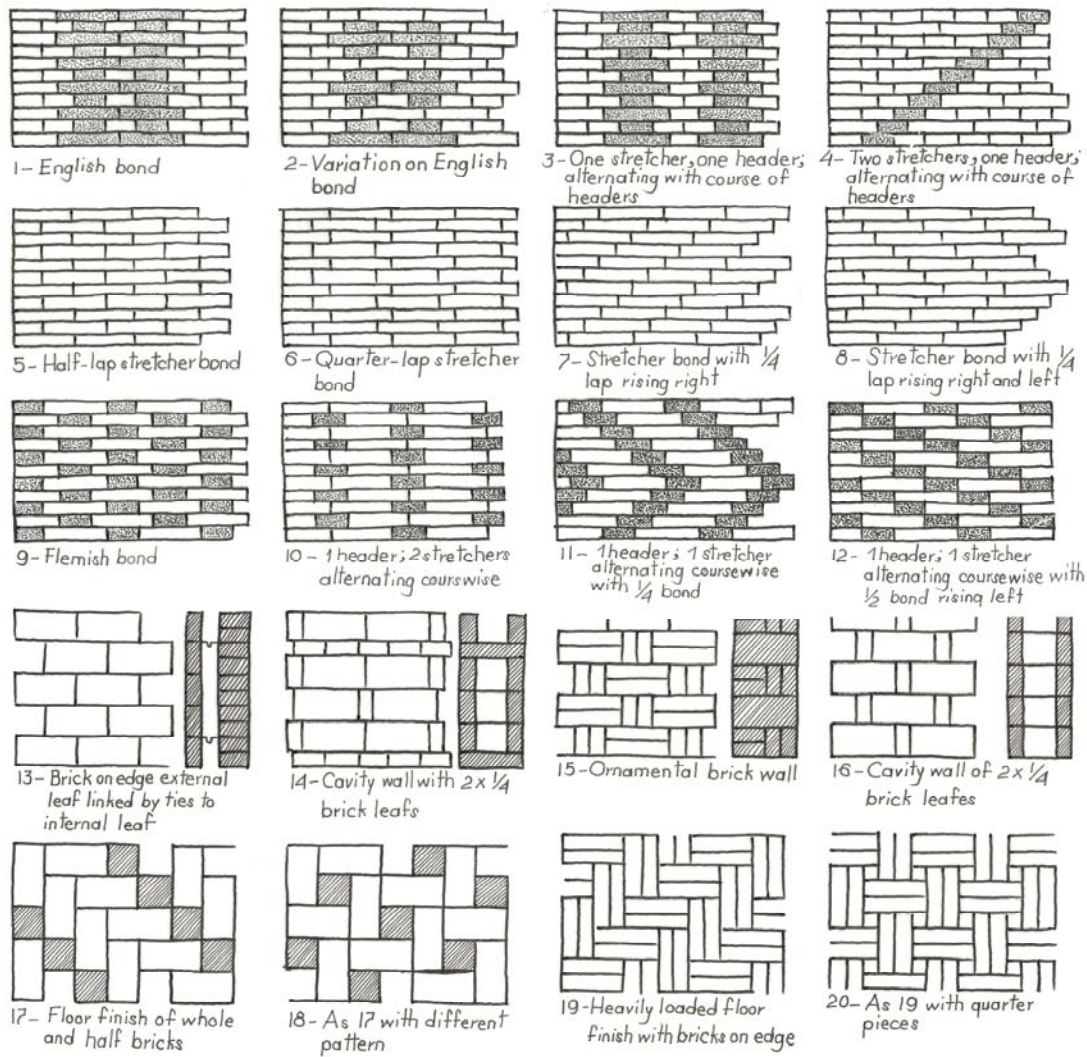

Figure 18h. Masonry bonds (Drawn by the author, adapted from Neufert: *Architects' Data*, p. 67)

References:

- Ardalan, Nader and Bakhtiar, Laleh. (1979). *The Sense of Unity: the Sufi Tradition in Persian Architecture*. Chicago: University of Chicago Press.
- Akbar, Jamel. (1988). *Crisis in the Built Environment: The Case of the Muslim City*. Tien Wah Press, Singapore.
- Brown, G. Z. and DeKay, Mark. (2001). *Sun, Wind and Light*. John Wiley and Sons, Inc. Canada.
- Ching, Francis D.K. (2003). *Architectural Graphics*. John Wiley and sons, Inc., New York.
- Beall, Christine. (1997). *Masonry Design and Detailing: For Architects, Engineers, and Contractors*. 4th ed. McGraw-Hill, New York.
- Kreh, Richard. (1998). *Building with Masonry: Brick, block and Concrete*. The Taunton Press, Inc. Newtown, CT.
- Ernst J. Grube... [et all.]. Edited by George Michell. (1978). *Architecture of the Islamic World: Its History and Social Meaning*. London: Thames and Hudson.

19. Overhanging Slabs (shading devices) and its Relation to the House



*Figure19a. A typical modern Kabul house design
(Photo by Donald Watts, professor of architecture)*

“The sun control device has to be on the outside of the building, an element of the façade, an element of architecture. And because this device is so important a part of our open architecture, it may develop into characteristic form.” (Marcel Breuer, 1955)

The positive advantages of overhanging slabs are greatly appreciated in the four seasons of the year. It has been applied throughout history and is seen in all cultures. The effect of these beautiful architectural structures is obviously seen on classical, vernacular and contemporary designs. Overhanging slabs protect the house outer skin from the severe overheated sunlight that affects the inside temperature during the hot days of summer. They also give beauty to the elevations of the house. If overhangs are not appropriately designed it is better to forget it because it increases the cost of the project without any function and form. Unfortunately, overhanging slabs are not appropriately used in the new house designs in Kabul because the builders do not have sufficient knowledge about the complicated principles of overhang design. Therefore, I warn the Kabul Municipality and other related ministries that the continuation of such circumstances does not only damage the environment but also completely damages the Afghan building form. A number of famous architects have studied the significance of shading and used it as a strong form of the building. Frank Lloyd Wright is one of those great architects who used shading strategies in most of his buildings by designing huge overhangs for both thermal and aesthetics purposes. Le Corbusier, the French modern architect, invented the brise-soleil (sun-breaker) which was a fixed structural sunshade. (*Heating, Cooling, Lighting*, p. 136-

138) Sun radiation is intense in the south and then in the east and west directions of the house. “Shading devices are an essential technique of avoiding unwanted solar gains, but need to respond in design to orientation.” (*Environmental Design of Urban Buildings*, p. 58) Concrete paving, walls, and other buildings with brighter (white) colors cause reflected solar radiation through the house windows (figure 19b).

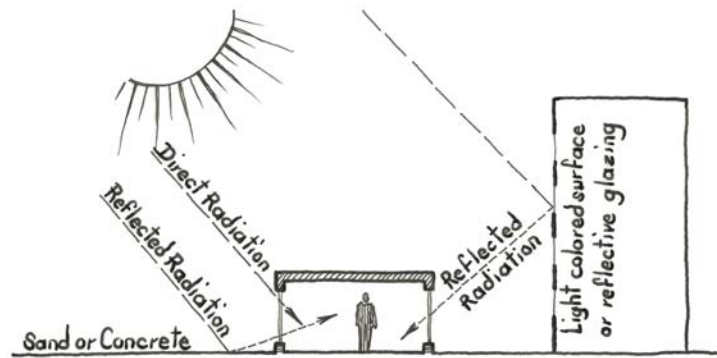

Figure 19b. “In dry regions the solar load consists mainly of the direct and reflected components. However, reflective glazing can be a problem in all climates.” (Drawn by the author, adapted from *Heating, Cooling, Lighting*, p. 139)

Basic Design Factors:

All types of shading devices can bring comfort to the house inhabitants. It is very important to study the particular region’s overheated and under-heated periods of sun angles. The total solar load consists of three components; “direct, diffuse, and reflected radiation.” (*Heating, Cooling, Lighting*, p. 139) For prevention of the passive solar heating, in the hot summer days when the angle of the sun comes to its maximum point, constructing a shading device is suggested. It is important to give function to the forms of the building; “In any good architecture, building elements are usually multifunctional.” (*Heating, Cooling, Lighting*, p. 134) Figure 19c shows some variations of horizontal overhangs, vertical fins, and eggcrate, which is a combination of the first two.

However, the type, size, and location of shading devices depends on the size of the direct, diffuse, and reflected solar load. The effect of reflected radiation can be reduced by strategic planting. This is possible by enlarging the green areas outside of the house as discussed in earlier patterns. The direct solar radiation is better controlled by the artificial shading devices if it is calculated precisely based on the overheated period of the solar radiation in the summer time. Carefully designed perforations or louvers in overhangs and fins allow them to maintain the same shading characteristics but still reflect light into the space (*Millet et al.*, 1981, p. 333).

			Descriptive Name	Best Orientation	Comments				Descriptive Name	Best Orientation	Comments
1			Overhang Horizontal panel	South, East, West	Traps hot air can be loaded by snow and wind	5			Vertical fin	East, West, North	Restricts view. For north facades in hot climates only.
2			Overhang horizontal louvers in horizontal plane	South, East, West	Free air movement. Snow or wind load is small.	6			Vertical fin slanted	East, West	Slant toward north. Restricts view significantly.
3			Overhang horizontal louvers in vertical plane	South, East, West	Reduces length of overhang. View restricted also available with miniature louvers.	7			Eggcrate	East, West	For very hot climates. View very restricted. Traps hot air.
4			Overhang vertical panel	South, East, West	Free air movement. No snow load. View restricted.	8			Eggcrate with slated fins	East, West	Slant toward north view very restricted. Traps hot air. For very hot climates

Table 19c. Examples of fixed shading devices (by the author, adapted from Architectural Graphic Standards, 2000, p.827)

Overhang design can have disadvantages as well as advantages; for instance, it reduces the daylight effect. A 1.8m horizontal overhang outside a 7.3m deep room produces a reduction in illumination of 39% near the window and 22% near the rear wall (B. H. Evans, 1981, p. 62). Other studies predict reductions in illumination of 50% from exterior vertical fins at 45° to the building surface. (Ander and Navvab, 1983, p. 180).

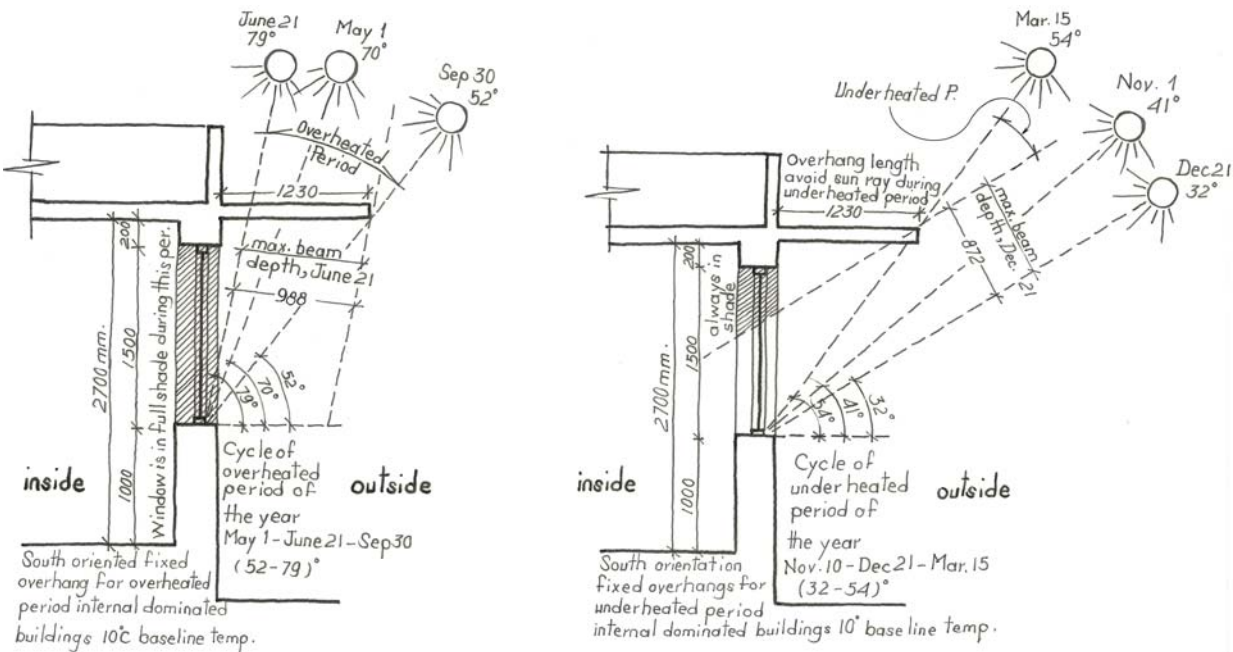

Figure 19d. Overheated and under-heated periods of the sun rays in Kabul, Afghanistan. (Drawn by the author, adapted from the original design by arch. Faryad, Aashoquallah, by permission of the author)

Physical Factors:

Sunlight is an unlimited natural resource that is vital for all living species. Despite sunlight's positive advantages, we need to protect our body from harmful excess. In the hot days of summer, building materials can transfer too much heat to a building interior. Fortunately, Kabul does not have long exhaustive summers. Still, house inhabitants suffer from direct radiation of the sun during the overheated period of the year. Many strategies are possible in order to control excessive sunlight. Some design strategies using either natural or built elements are shown in figure 19 e.

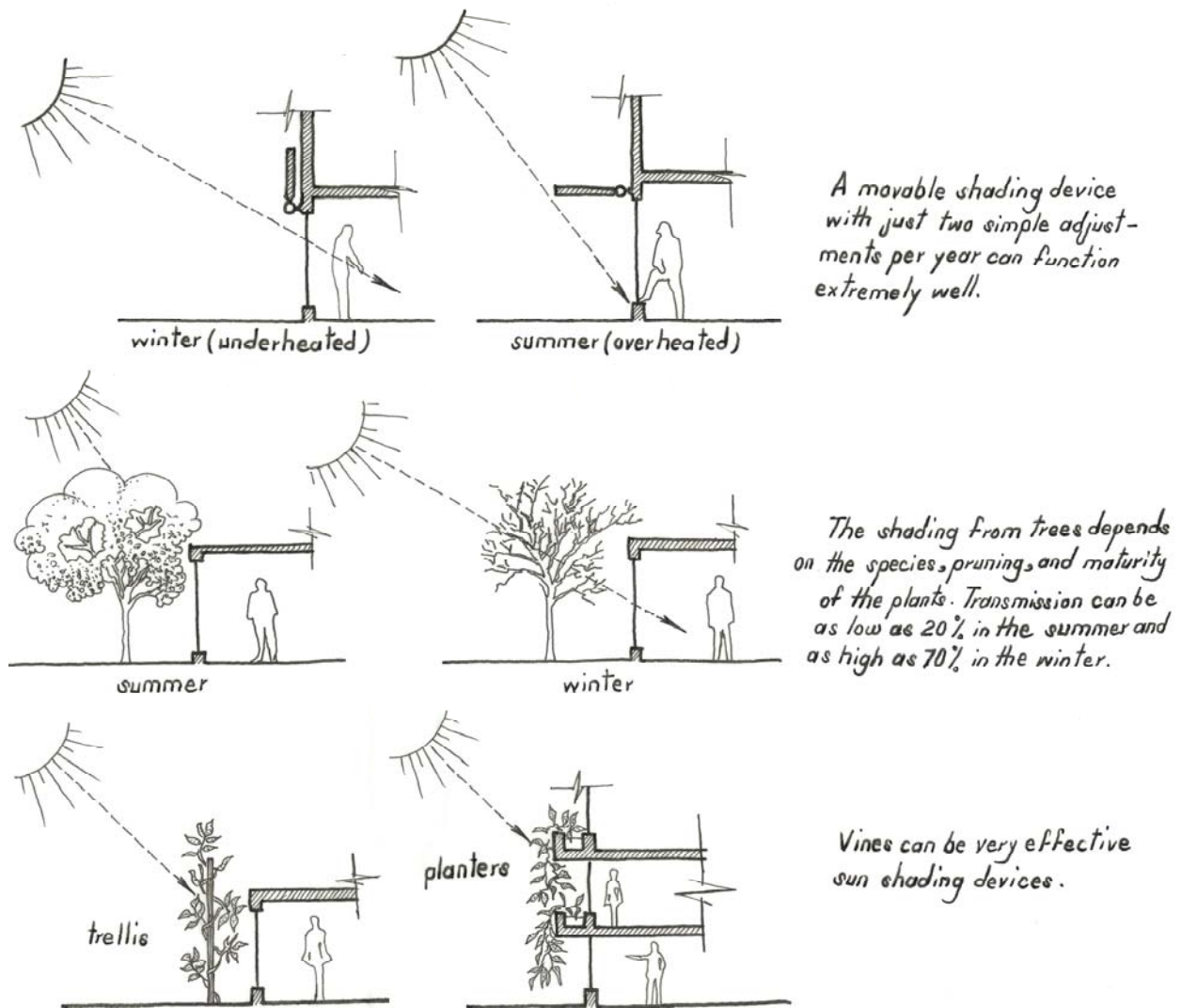

Figure 19e. Some useful strategies that help to protect the windows that are faced south from the overheated sunrays (Drawn by the author, adapted from Heating, Cooling, Lighting, p. 145)

“Daylight-enhancing shades can protect windows from solar gain while preserving sky view, reflecting daylight, and reducing glare.” (*Sun, Wind and Light*, p.260) Both local and international building strategies show ways to reduce the solar overload. Table 19f shows the overheated and under-heated periods for Kabul’s climate.

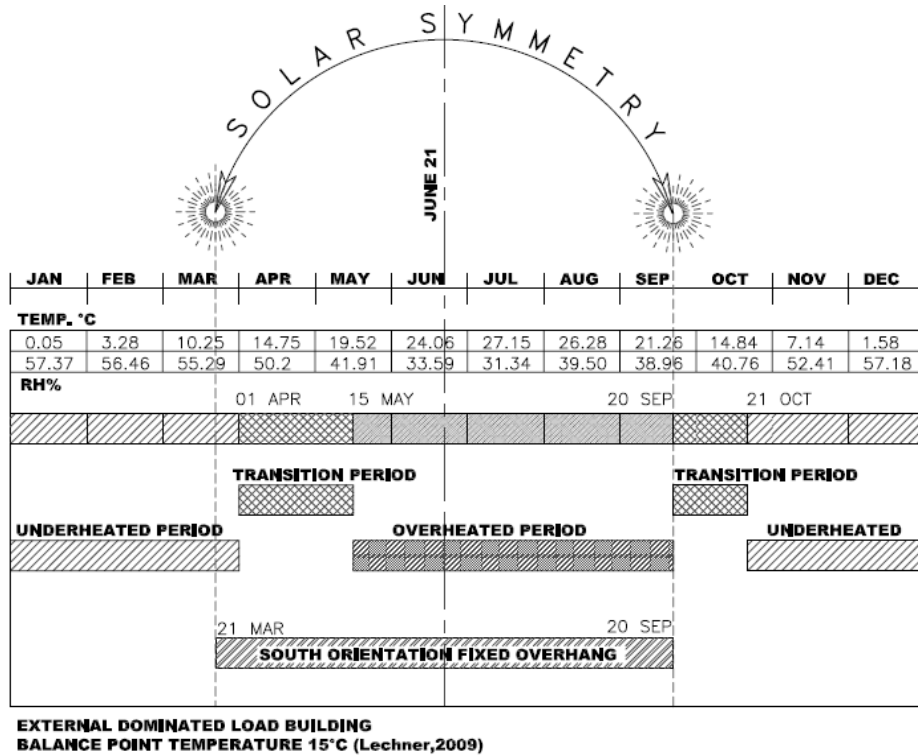

Table 19f. Outdoor building overheated and under-heated period (Prepared by Aashoqullah Faryad, by permission)

Shading is also provided by the surrounding environment. For instance, neighboring houses, trees, and land forms provide shading. External shading devices are the most effective barriers against the sun and they also have the most impact upon the aesthetics of a building. (*Heating, Cooling, Lighting*, p. 140)

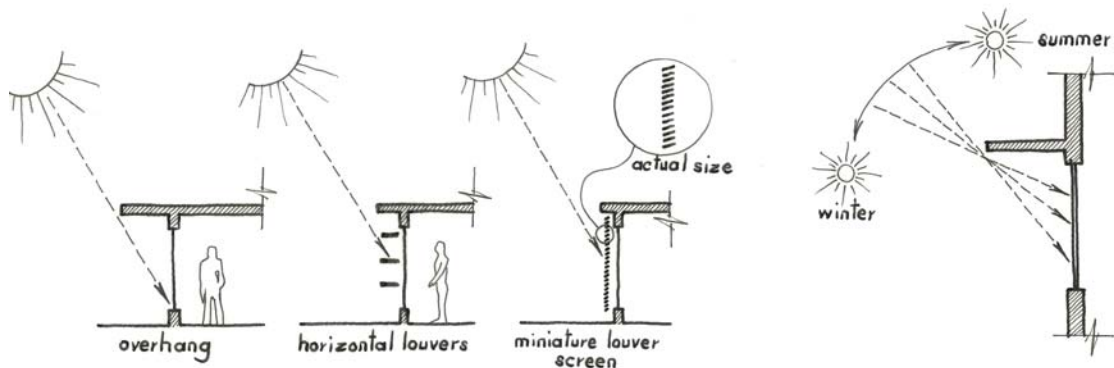

Figure 19g. Many small elements can create the same shading effect as one large device. (Drawn by the author, adapted from *Heating, Cooling, Lighting*, p. 142)

For a short period of time during the summer, the sun rises from the northeast. This means we need to design a shading device on the north face of the house. The best shading device is vertical fins (figure 19h). The more effective condition for the fixed devices is a combination of vertical and horizontal overhangs and fins that vary based on physical condition of different orientations.

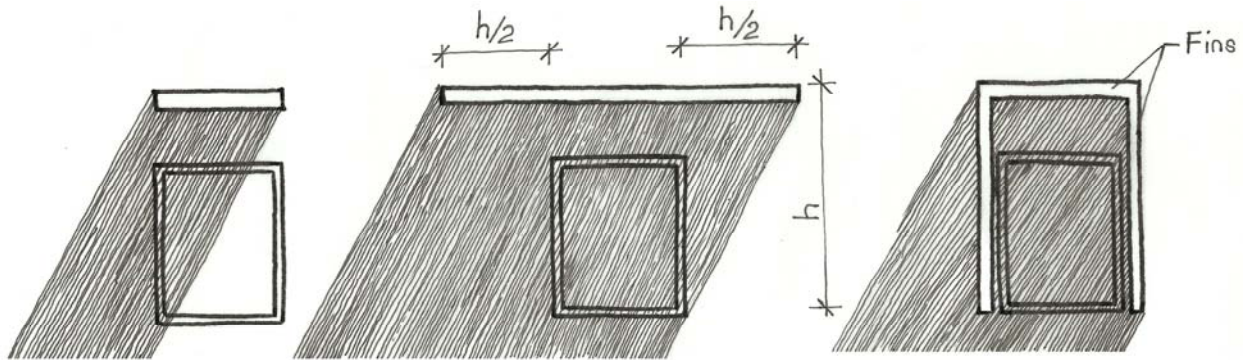

Figure 19h. The sun easily outflanks an overhang the same width as the window. Use a wider overhang or vertical fins on each side of the window. (Drawn by the author, adapted from Heating, Cooling, Lighting, p. 149)

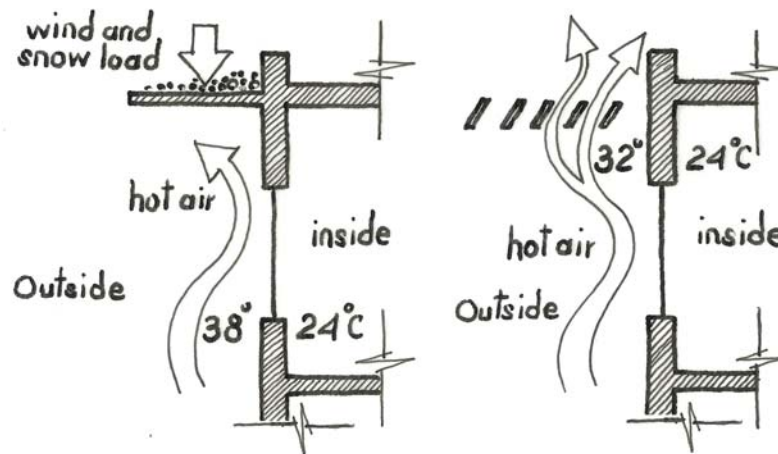

Figure 19i. Horizontal lowered overhangs both vent hot air and minimize snow and wind loads. (Drawn by the author, adapted from Heating, Cooling, Lighting, p. 149)

However, overhanging horizontal louvers not only increases the daylight efficiency but also allows free air movement and minimizes the snow or wind load, as option 2, figure 19c illustrates. According to Olgyay and Olgyay, “the open overhang also allows the circulation of air within the shading device itself, reducing heat transfers from it to the interior spaces.” (Olgyay and Olgyay, 1957, p. 105). The horizontal louvers (figure 19i) reduce the building dead and live loads. It lets the snow and wind pass through. In the hot weather of summer it does not

collect the hot air near the window, underneath the overhang. It is also aesthetically beautiful since the architect prefers textured and light elements of structure rather than heavy elements. The use of overhangs is also recommended for the entrance of the house, whether it is on the north or south sides because of rain and snow. These structural elements protect the entrance from slippery conditions.

Socio-Cultural Factors:

“Historical allusion can be especially appropriate when there are functional advantages as well as aesthetic benefits.” (*Heating, Cooling, Lighting*, p. 134) Traditional architecture of Afghanistan has experienced the use of *borya* rush-mat that goes along with traditional mud brick construction. The overhang of wooden beams (figure 19j) is used for providing shade and protection of the outer walls from rain. People also use interior curtains, as a part of Afghan custom, for both aesthetic and privacy purposes. It is widely used for decoration and privacy of interior spaces because curtains are easily decorated in a variety of ways.

The new imported Pakistani designs, as previously discussed, with its huge deformed overhangs neither has function nor form to fulfill today’s Kabul housing demand. The best design option for overhangs is a variety of fixed overhang and fins if the required calculations are precisely done by the architect.



Figure 19j. Traditional overhang constructed to provide shade as well as to protect the house windows and outer mud walls from the rain. (Photo by the author)

The advantages of a moveable shading device are also appreciated. “Fixed external devices are clearly less flexible than retractable or adjustable ones.” (*Neufert, Architects’ Data*, p.178)

For the east and west facades of the house which are facing the neighbors, design of vertical fin slanted 6 (figure 19c) is recommended because it has both the shading advantage and

also privacy. It restricts the view significantly and it is a good visual barrier for both neighbors. The variety of overhang and fin forms that are available with good design decisions contributes beauty to the house elevations. Attractive public facing elevations are appreciated by everyone and enhance the beauty of the city.

References:

- Breuer, Marcel. (1955). *Sun and Shadow, The Philosophy of an Architect*. New York: Dodd, Mead.
- Hoke, John R. (2000). *Ramsey/Sleeper Architectural Graphic Standards*, 10th ed. New York: Wiley.
- Millet, M., J. Lakin, and J. Moore. (1981). *Light without Heat: Daylight and Shading*. American Section of the International Solar Energy Society.
- Evans, Benjamin H. (1981). *Daylighting in Architecture*. New York: McGraw-Hill.
- Ander, G. D., and M. Navvab (1983). *Daylight Impacts of Fenestration Controls*. Proceedings of the 8th National Passive Solar Conference. Boulder, CO: American Solar Energy Society.
- Olgyay, Adlar, and Victor Olgyagy. (1957). *Solar Control and Shading Devices*. Princeton, NJ: Princeton University Press.
- Brown, G. Z. and DeKay, Mark. (2001). *Sun, Wind and Light*. John Wiley and Sons, Inc. Canada.
- Neufert, Ernst, Neufert, Peter, Baiche, Bousmaha, Walliman, Nicholas. (2002). *Architects' Data*. 3rd ed. Wiley-Blackwell.
- Lechner, Norbert. (1991). *Heating, Cooling, Lighting: Design Method for Architects*. John Wiley and Sons, Inc.
- Santamouris, Mat. (2006). *Environmental Design of Urban Buildings: An Integrated Approach*. Bath Press, UK.

20. Windowsill and its Significance



Figure20a. Windows' interior and exterior views. (Building design and photos by the author)

***The windowsill is a threshold joining
the inside and outside of the house.***

All openings of the house, doors and windows, have significant value for providing light, warmth, ventilation, and beauty to the house. I have already discussed how to strategically place the windows, based on the functions of the rooms. Now, some elaborated functions of the windows need to be discussed in order to take the full advantage of these significant elements of the house. The windowsill is as important as the window lintel because it can control the light as well as privacy and other valuable aesthetic, physical, and social factors.



Figure20b. Windows dominate the entire exterior wall. An old house that is currently used by Agha Khan Foundation as an office room (Photo by prof. Donald Watts)

Basic Design Factors:

“If daylight is considered to be essential for the use to which a room will be put, then windows are an unavoidable necessity.” (*Neufert, Architects’ Data*, p. 176) Appropriate placement of the windows is an important and challenging issue of the architectural design for both the form and function of the house. This is because of many variations available to the architect. In an architectural drawing not only the size and dimensions of the window should be included, but also the type and elaborated details of the window should be clarified. It must be taken into consideration based on design of the window and its material, whether it is a local wooden frame or prefabricated, to calculate the size of the window based on its facing to the four orientations of the house. The house planning in relation to the orientation is necessary, “The main habitable areas should be oriented to the solar side” for instance, the kitchen preferably oriented on the east to receive the morning sun and the living room facing the afternoon and early evening sun. The secondary spaces like bathrooms, storage, and garage can be situated on the non-solar side. (*Environmental Design and Urban Buildings*, p. 56). A windowsill can be as low as the room’s floor level. Alexander says “Everybody loves window seats, bay windows, and big windows with low sills and comfortable chairs drawn up to them.” (*A Pattern Language*, p. 834), but a good design decision identifies the size and other important factors. Both, the form of the building and orientation are important for a successful daylighting design. Generally, the selection of finishes happens at the end of the design process, but for providing effective daylight through the windowsill it must be considered earlier. (*Heating, Cooling, Lighting*, p. 319) Windowsill height varies according to the function of the rooms. For instance, if it is a study room preferably the study table is placed close to the window; therefore, the windowsill depends on the height of the study table. A kitchen window also cannot have a windowsill lower than 85cm. This is based on the height of the working surface. A few examples of different types of windows and windowsills are illustrated in figure 20e.

Physical Factors:

Windows are the important elements of the house that connect the inhabitant’s spiritual and psychological relationship to the outside world. Windows bring sun warmth, fresh air, and a sense of nature as well as authentic beauty to the house inhabitants. Typically, the height of a lintel is mostly dependent on the size of the beam, the primary variables for increasing and

decreasing window size are the sill and two sides of the window. Sunlight does not always enter a room directly; it also enters by reflection from a windowsill. Therefore, it is important to design the window sill size and color appropriately.

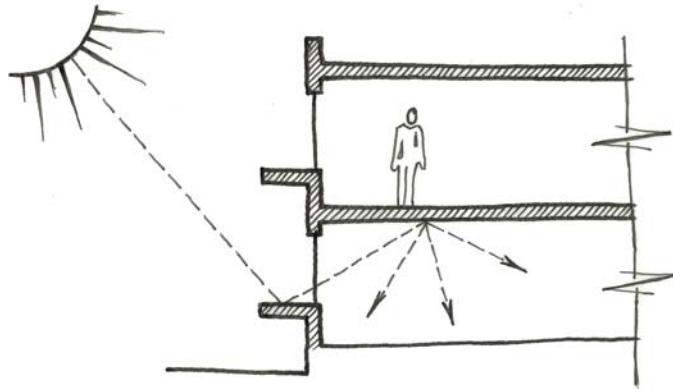

Figure20c. Wide windowsills can be used as light shelves to reflect light deep into the interior. (Drawn by the author, adapted from *Heating, Cooling, Lighting*, p. 323)

The color of the window frame also has much value for the window's durability and beauty. Lighter colors are recommended for an exterior windowsill and window frame. White color is the one that particularly reflects the sunrays more effectively. "By means of reflectors and diffusers small window areas can collect large amounts of daylight." (*Heating, Cooling, Lighting*, p. 322) Therefore, we can increase the effective size of the windows by designing lower sills and using two or three smaller windows instead of one large window at the center of the exterior wall.



Figure20d. These plans, with contours of equal illumination, illustrate how light distribution is improved by admitting daylight from more than one point. (Drawn by author, adapted from *Heating, Cooling, Lighting*, p. 322)

For houses having radiators underneath of the windows, the lowest windowsill height is 50cm. Given the illumination requirements, the design can then determine the windowsill height. (*Sun, Wind and Light*, p. 166) Because of summer overheated air and winter cold air the size of windows should not be greater than 20% of the floor area for each room. (*Heating, Cooling,*

Lighting, p. 322) It is also important if a windowsill has enough space for a person to safely clean the glass.

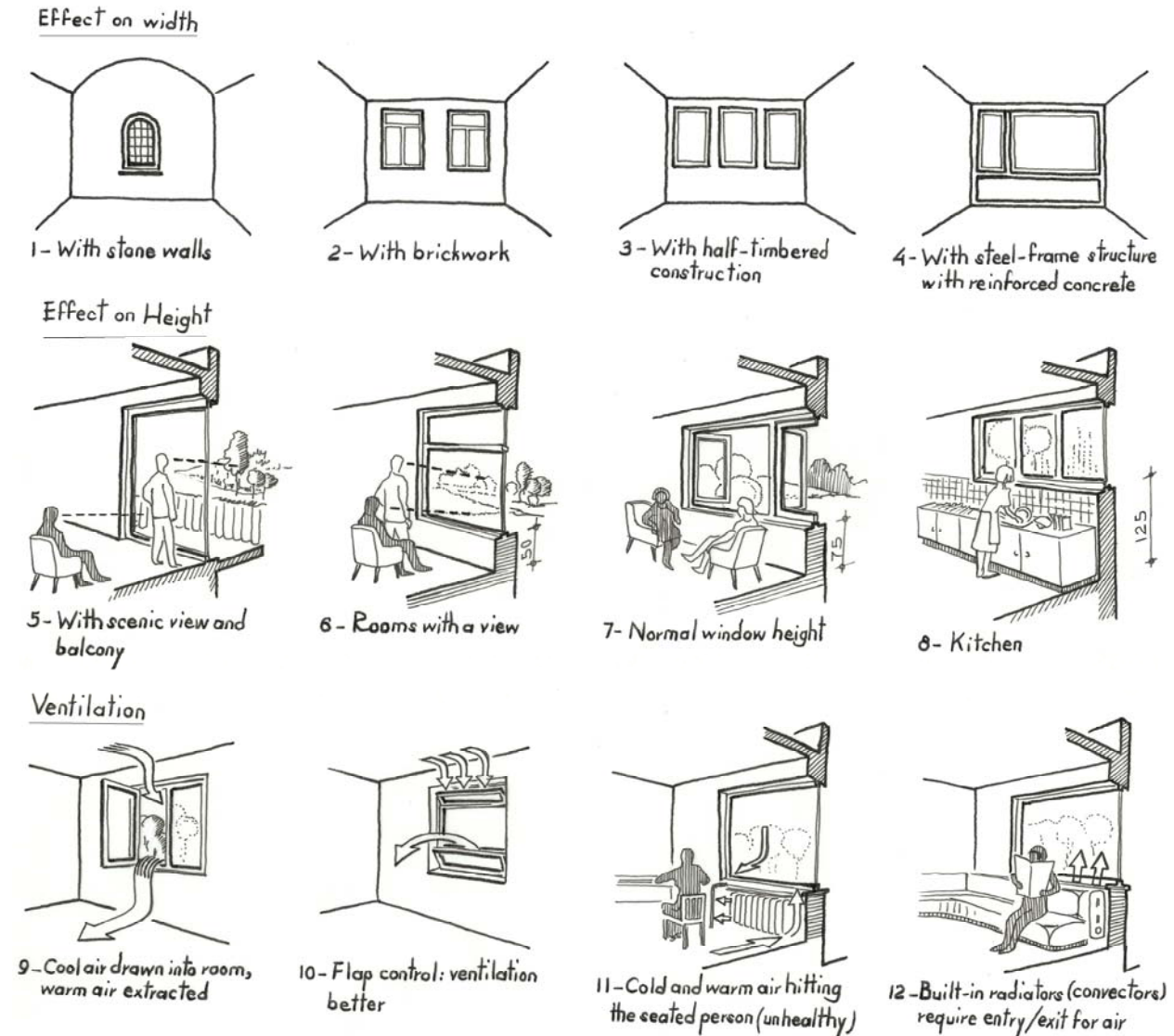

Figure 20e. The size and variation of different windowsills according to the rooms' different activities (Drawn by the author, adapted from Neufert: Architects' Data, p. 177)

Socio-Cultural Factors:

Based on the Afghan culture, a window has a direct impact on the house privacy. This value comes from the past, both religiously and traditionally which are important social factors that influence the design of the windows. This issue is particularly important for houses based upon Kabul Municipality block subdivisions having close adjoining houses to the east and west. This issue of adjoining house privacy needs more public understanding. The best design suggestion is

to decrease the size of windows on these orientations by controlling the height of the windowsill. Another possibility is to use obscure glazing in these windows, but it is rarely accepted by the neighbors because of a psychological mistrust. People, based on their cultural background, need to be assured psychologically as well physically. Another method is to strategically design louvers as the shading device that also provides desired shade and privacy to the house. It has always proved that no social meanings, including privacy can be respected by constructing massive walls and barriers. The level of education and culture must be developed. “What is good for educated individuals is often misused by the uneducated...we have all heard of high-quality projects misused by occupants...Education, not housing projects, is the best investment for a society’s wealth.” (*Crisis in the Built Environment*, p. 185)

References:

- Brown, G. Z. and DeKay, Mark. (2001). *Sun, Wind and Light*. John Wiley and Sons, Inc. Canada.
- Neufert, Ernst, Neufert, Peter, Baiche, Bousmaha, Walliman, Nicholas. (2002). *Architects' Data*. 3rd ed. Wiley-Blackwell.
- Lechner, Norbert. (1991). *Heating, Cooling, Lighting: Design Method for Architects*. John Wiley and Sons, Inc.
- Akbar, Jamel. (1988). *Crisis in the Built Environment: The Case of the Muslim City*. Tien Wah Press, Singapore.
- Christopher, Alexander. (1977). *A Pattern Language: Towns, Buildings, Construction*. Oxford University Press, NY.
- Santamouris, Mat. (2006). *Environmental Design of Urban Buildings: An Integrated Approach*. Bath Press, UK.

Chapter 5 - Conclusion

“A liberal education is at the heart of a civil society, and at the heart of a liberal education is the act of teaching.” (A. Bartlett Giamatti)

The intention of this thesis is to place the foundation stone of a design course that has not been updated for a long time, and to strengthen the pathway of future studies. Although, this is only an introduction towards this issue, it is as important as spirit for the body in an educational environment. A beginning design course has more value compared to the upper levels of design. It is because for the first time students learn the alphabet of design. It is critically important to know where and how architectural design education begins. This thesis provides explicit written materials to help guide students and professors. They will follow a specific framework that systematically exposes them to fundamental design concepts. They will have written documentation for the first time with its related sources and course schedule.

In this thesis I argue that without a precise and well prepared methodological pedagogy a design course cannot be successful. Afghan society has its unique definitions to which most architectural theories cannot be effectively applied. Therefore, as a long term but more lucrative way I chose Alexander's *A Pattern Language* methodology because it has several experimental values. He has written his book in a crucial time in which as he explains, “For most of the world's housing, ...has been reduced to ..., an uphill struggle against the relentless surge of technology and bureaucracy, in which human feeling has almost been forgotten.” (*Production of Houses*, p. 14) This method allows professors to follow an exclusive strategy for preparing other department's course descriptions and variety of learning benefits which I have talked about it in chapter three. In addition, this method is widely applicable and unlimited in design and construction applications. “...in a healthy society there will be as many pattern languages as there are people even though these languages are shared and similar.” (*A Pattern Language*, p. xvi) To some extent, these patterns are the essence of my thesis that represents the core of my research. My created patterns illustrate the relationship between people and construction and it is more about human behavior and quality of life rather than excessive decoration.

Lessons Learned by Writing a Pattern

The necessity of consistently following a template of questions requires a mental discipline. It is a key concept to stay with the same format for the entire list of patterns that need to be developed. Basic design factors, physical factors, and socio-cultural factors are the three created steady ingredients of these patterns that are designed in accordance with the particular course capacity. Creating the complete list of patterns, whether required for a design course or design and construction project, needs sufficient time and broader studies devoted to that particular subject. Patterns begin from the very largest scale and then, by a smooth sequenced order, descend to smaller and more detailed scales. It is very important to have the discipline of carefully isolating the subject into separate, individual concepts. Often when trying to write one pattern, two or three concepts arose and they became new, separate patterns. The researcher must be careful to remain focused upon the specific concept of a particular pattern and not mix numerous concepts together into one pattern description. Therefore, it must be taken into consideration to avoid a mixed system. Sometimes, the theme of one pattern overlaps into another, but it should be carefully organized to isolate the detailed concepts in individual patterns. This is because, in the end, all patterns bear some direct or indirect relationship to each other. If a single pattern carries two or more ideas at the same time, it gets complicated to be understood. The beauty of pattern language is that it allows one to identify the structure of these conceptual relationships. This promotes both better incremental learning for the beginning student and the potential for advanced research into very specific design issues that may have unforeseen major impacts upon a resultant design. The researcher should always ask who the audience of the prepared list of patterns, and what the project is.

I have also been thinking for a long time about an applicable strategy that gives the right impression to people who do not have any idea about appropriate design for a particular region. Demonstrating to land owners a better idea of living space and beauty is a lifetime campaign since people are stereotypical thinkers. Constructing a model housing project for people's awareness needs sufficient power and money which is not applicable in such an unfavorable situation. People's awareness is only possible by the remedy of education. Focus on architectural education definitely gives fruitful results in the long term. It is a long procedure but it is more stable and more productive.

Pattern Language as a Means for Understanding Architecture

I see much potential for implementation of this method by both architecture professors and students. “The social revolution which our principles imply can happen, on a large scale, almost anywhere, and under almost any cultural conditions.” (*Production of Houses*, p. 350) We need an environmentally responsive housing system which is not possible unless the unique design, physical, and socio-cultural factors of that particular region are studied. These patterns can be developed for the upper design classes whether their class projects are residential or public design; whereas the aim of this thesis is to provide a conceptual foundation based on academic requirements.

Just as building design cannot be copied and imported from a different part of the world; neither can a course syllabus if it does not meet that particular region’s physical and social character. Since beginning my research, I learned a number of lessons: first, I learned how a course description is responsive for the actual semester course. Second, before starting to design a course manual a professor needs to assess the course materials from the student point of view. Third, including all design terms, theories, and principles at one time, or in a short amount of time, has a negative impact upon the pedagogical system. Therefore, it is important to have a sequenced course design that professors and students can build upon. The design acts like a language; if it is not as fluent as reading, writing, and speaking, it will not be understood. Just like any language, continued practice is absolutely necessary. I have studied a number of theories in order to find a better methodology for teaching a beginning design studio, but what I preferred and found more effective is Alexander’s *A Pattern Language*. This theory is not only practical for teaching this class but also I suggest the same methodology for designing the upper design courses. The beauty of this method is its step by step teaching and learning process that fosters a better learning facility. By having this framework professors will be able to create their own pattern language of individual courses. This also helps the professors to upgrade the course materials by a sequenced scheme. I present this methodology in the hopes of further research in the Afghan architecture field because compared to other theories it has a proven and valid outcome. This method yields a broad and powerful construct for design that is appropriate for Afghan society.

Future Research

Sustainable design has to be widely studied by young professors and students who are going to be future architects. In today's world sustainable architecture is an outcome of natural hurdles and growth of technology by which we can prevent the negative environmental impacts upon the body of our city. Kabul's population is unpredictably growing. The city planning and housing systems are no longer responsive to its inhabitants' vast demands. Kabul's uncontrolled growth transformed the city into a nonliving place. Inhabitants really suffer from this massive expansion. House design is almost dominated by imported foreign influences which are an outcome of design and construction illiteracy. For more detailed investigations of the design for human behavior, students and professionals may learn from the work of Aashoqullah Faryad and Jamshid Habib's research. Their works will open the doors of further academic discussions. These valuable dialogues allow the architects to seek better ways of appropriate construction materials and sustainable design that is widely missed, or forgotten, from our building design. "Sustainable architecture is a revised conceptualization of architecture in response to a myriad of contemporary concerns about the effects of human activity." (*Understanding Sustainable Architecture*, p. preface) Afghan architects must also consider sustainability so that their designs will be responsive to that particular region's environment. "The design of a place affects the choices people can make, at many levels." (*Responsive Environment*, p. 9)

This thesis seeks a modern Afghan architectural design philosophy that yields an appropriate strategy for students, professors, architects and other professionals. Furthermore, the format of A Pattern Language is organized and improved with charts and illustrations that allow nonprofessionals to learn from and construct their own houses. My thesis hopes to contribute toward further accomplishments in search of our Afghan architectural identity that is an essential part of the Afghan nation's reconstruction of itself. This is definitely a possible Afghan dream.

References

- Akbar, Jamel. (1988). *Crisis in the Built Environment: The Case of the Muslim City*. Tien Wah Press, Singapore.
- Alexander, Christopher. (1979). *The timeless Way of Building*. New York: The Oxford University Press.
- Alexander, Christopher, Ishikawa, Sara, Silverstein, Murray, Jacobson, Max, Fiksdahl-King, Ingrid, Angel, Shlomo. (1977). *A Pattern Language: Towns, Buildings, Construction*. Oxford University Press, NY.
- Alexander, Christopher. (1985). *The Production of Houses*. New York, Oxford University Press.
- Ambraseys, Nicholas. *Earthquakes in Afghanistan*. Dept. of Civil Engineering, Imperial College, London. SW7 2BU, UK
- Ander, G. D., and M. Navvab (1983). *Daylight Impacts of Fenestration Controls*. Proceedings of the 8th National Passive Solar Conference. Boulder, CO: American Solar Energy Society.
- Ardalan, Nader and Bakhtiar, Laleh. (1979). *The Sense of Unity: the Sufi Tradition in Persian Architecture*. Chicago: University of Chicago Press.
- Beall, Christine. (1997). *Masonry Design and Detailing: For Architects, Engineers, and Contractors*. 4th ed. McGraw-Hill, New York.
- Bentley, Ian, Alcock, Alan, Murrain, Paul, McGlynn, Sue, and Smith, Graham. (1994). *Responsive Environments: A manual for Designers*. Hartnolls Ltd, Bodmin, Cornwall, London, Great Britain.
- Brown, G. Z. and DeKay, Mark. (2001). *Sun, Wind and Light*. John Wiley and Sons, Inc. Canada.
- Canizaro, Vincent (Ed.). (2007). *Architecture Regionalism: Collected Writings on Place, Identity, Modernity, and Tradition*. New York: Princeton.
- Ching, Francis D.K. (2003). *Architectural Graphics*. John Wiley and sons, Inc., New York.
- Ching, Francis D.K. (2007). *Architecture: Form, Space, and Order*. 3rd ed. John Wiley and Sons, Inc. USA.

- Coates, Gary J. and Seamon, David. (1993). "Promoting a Foundational Ecology Practically Through Christopher Alexander's Pattern Language: The Example of Meadowcreek". In *Dwelling, Seeing, and Designing: Toward a Phenomenological Ecology*. David Seamon, ed. Albany, NY: SUNY Press. (pp. 331-54).
- D. Frank, Lawrence, Engeleke, Peter O., and L. Schmidt, Thomas. (2003). *Health and Community Design: The Impact of the Built Environment on Physical Activity*. Washington, DC: Island Press.
- Dodge, Jim. (1981). *Living by Life: Some Bioregional Theory and Practice*. *CoEvolution Quarterly* 32 winter. (pp. 6-12).
- El Khoury, Pierre. (2000). *Contemporary Architecture for the Lebanon and the Middle East*. Beirut, Lebanon.
- Erikson, Tom and John Thomas. (1997). *Putting It All Together: Toward a Pattern Language for Interaction Design Summary Report of the CHI '97 Workshop*. Online Article.
- Ernst J. Grube... [et all.]. Edited by George Michell. (1978). *Architecture of the Islamic World: Its History and Social Meaning*. London: Thames and Hudson.
- Faryad, Aashoqullah. (2011). *Strategies for Minimizing Thermal Energy Transfer in Traditional Brick Masonry Bearing Wall Construction in Kabul, Afghanistan*. Master of Science in Architecture Summary Research Paper, (unpublished). Department of Architecture, Kansas State University.
- Fathy, Hassan. (1986). *Natural Energy and Vernacular Architecture*. Chicago and London: University of Chicago Press.
- Fathy Hassan. (1973). *Architecture for the Poor: An Experiment in Rural Egypt*. The University of Chicago Press, Ltd., London.
- Gamma, E., Helm, R., Johnson, R. & Vlissides, J. (1995). *Design Patterns: Elements of Reusable Object Oriented Software*. New York: Addison-Wesley.
- Guy, Simon. (Feb. 2001). *Reinterpreting Sustainable Architecture: The Place of Technology*. *Journal of Architectural Education*, (p. 140-148). School of Architecture, Planning and Landscape, Newcastle Upon tyne.
- Habib, Jamshid. (2010). *An Overview of Some Key Researches and Topics in Environment-Behavior Studies and Some Implications for Architectural and Environmental Design*. Master of Science in Architecture Thesis. Department of Architecture, Kansas State University.

- Hagan, Susannah. (Summer 1998). *The Good, the Bad and the Juggled: The New Ethics of Building Materials*. The Journal of Architecture, Volume 3.
- Heschong, Lisa. (1979). *Thermal Delight in Architecture*. Cambridge, MA: MIT Press.
- Hoke, John R. (2000). *Ramsey/Sleeper Architectural Graphic Standards*, 10th ed. New York: Wiley.
- King, Anthony D. (1980). *Buildings and Society: Essays on the Social Development of the Built Environment*. London.
- Kreh, Richard. (1998). *Building with Masonry: Brick, block and Concrete*. The Taunton Press, Inc. Newtown, CT.
- Kreimeier, Bernd. (2002). *The Case for Game Design Patterns*. Gamasutra.com.
- Kultermann, Udo. (July 1999). *Contemporary Architecture in the Arab State: Renaissance of a Region (Hardcover)*. McGraw-Hill Professional.
- Lechner, Norbert. (1991). *Heating, Cooling, Lighting: Design Method for Architects*. John Wiley and Sons, Inc.
- Love, Timothy. *Kit of Parts Conceptualism: Abstracting Architecture in the American Academy*.
- Millet, M., J. Lakin, and J. Moore. (1981). *Light Without Heat: Daylight and Shading*. American Section of the International Solar Energy Society.
- Ministry of Justice. (2000). *Afghan Official Jrydh: Municipality Law*. Ministry of Justice Press. Kabul, Afghanistan.
- National Conference for the Beginning Design Student, <http://www.beginningdesign.org/>.
- N. Clark, Kenneth and Paylore, Patricia. (1980). *Desert Housing: Balancing Experience and Technology for Dwelling in Hot Arid Zones*. Tuscan, Arizona, US.
- Neufert, Ernst, Neufert, Peter, Baiche, Bousmaha, Walliman, Nicholas. (2002). *Architects' Data* (3rd ed.). Wiley-Blackwell.
- Orr, David. (1992). *Ecological Literacy: Education and the Transition to a Postmodern World*. State University of New York Press, Albany.
- Olgyay, Aladar and Olgyay, Victor. (1957). *Solar Control and Shading Devices*. Princeton, NJ: Princeton University Press.

- Rapoport, Amos. (1969). *House Form and Culture*. Prentice-Hall, Inc. Englewood Cliffs, N.J.
- Relph, Edward. (1976; reprint 2009). *Place and Placelessness*. London: Pion.
- Reynolds, John S. (2002). *Courtyards: Aesthetic, Social, and Thermal Delight*. New York: John Wiley & Sons, Inc.
- Samizay, Rafi and Hallet, Stanley Ira. (1980). *Traditional Architecture of Afghanistan*. Garland STPM Press, New York.
- Seamon, David, editor. (1993). *Dwelling, Seeing, and Designing: Toward a Phenomenological Ecology*. Albany, NY: SUNY Press.
- Seamon, David. <http://www.pps.org/articles/calexander/>
- Seta, M. Low, E.C. (1987). *Housing, Culture, and Design*. Pennsylvania: University of Pennsylvania Press.
- Steele, James- Sobin, Harris and James, Kathleen. *Architects and the Reinterpretation of Tradition*. volume seventy-four/ IASTE. 74-94.
- Talen, Emily. (2008). *Designing for Diversity: Exploring Socially Mixed Neighborhoods*. NY: Architectural Press.
- Szabo, Albert and J. Barfield, Thomas. (1991). *Afghanistan: An Atlas of Indigenous Domestic Architecture*. 1st ed. University of Texas Press, Austin.
- Williamson, Terry, Radford, Antony and Bennetts, Helen. (2005). *Understanding Sustainable Architecture*. Spon Press, 270 Madison Ave, New York.
- Wu, Jianguo. (2008). *Making the Case for Landscape Ecology: An Effective Approach to Urban Sustainability*. Landscape Journal. Board of Regents of the University of Wisconsin System.
- <http://www.beginningdesign.org/>
- http://www.beginningdesign.org/Non-Conference/BBDP3/pdf/BBDP3_MarkovichN_Textures.pdf
- http://www.beginningdesign.org/Non-Conference/BBDP3/pdf/BBDP3_ThompsonJ_Projects.pdf
- http://www.beginningdesign.org/Non-Conference/BBDP3/pdf/BBDP3_FaireyJ_FormandImagination.pdf

- http://www.beginningdesign.org/NCBDS/25/pdf/LiptakM_Creative_Criticality.pdf
- http://www.beginningdesign.org/NCBDS/25/pdf/HoagR_Writing_in_Design.pdf
- Glass Network Sdn. Bhd. (2007). *Double Glazing Glass*. Retrieved from: www.glassnetwork.com
- Glass Network Sdn. Bhd. (2007). *Benefits of Using Double Glazing glass*. Retrieved from: www.glassnetwork.com
- www.ardleigh.ie/page2.php
- <http://en.wikipedia.org/wiki/Hat>
- www.free-ed.net

Appendix A – First Design Course Syllabus

Schedule:

PROJECT 1 Human Scale

NOTE: 1 Period= 1.5 hour of class meeting

Assignment 1, Human Dimensions

- Review of the orthographic drawings in Ching, *Design Drawing* pages (124-130)

1 period

- Draw your own body dimensions in a definite proportion (different positions, standing with open arms, sitting, laying down etc.) according to your instructor's direction.

1 period; Total=2 periods

Assignment 2, One Point Perspective

- Draw a 10 meter cube frame, standing (Station Point) 15m. in front of the cube and 2m. off center.
- Draw into the perspective 1 scale figure standing 1m. in front of the cube.
- Draw into the perspective 1 scale figure standing inside the cube frame.

Total=3 periods

PROJECT 2

Assignment 1, Subdividing the Square and the Cube

- Introduction

1 period

- Trace layout

1 period

- Final Drawing with title box.

1 period; Total=3 periods

Assignment 2, Finding the Inner Cube

- Draw a 10m. cube and find the central sub cube inside it. Use an A-3 sheet of paper.

Total=1 period

Assignment 3a, Drawing 3 Architectural Planes within the Cube

- Draw and compose three planes according to your understanding. Design on trace with teams of 2. Use an A-3 sheet of paper.

1 period

- Final drawing by each student, individually.

Use an A-3 sheet of paper.

1 period; Total=2 periods

Assignment 3b, Constructing the Cube Frame

- Construct a (10x10x10) m. cube frame. Teams of 2 because of too many students. Go slow and be accurate.

Total = 2 periods

Assignment 3c, Constructing the Composition

- Construct your composed compositions. This allows time for questions and starting over after making mistakes.

Total = 2 periods

Assignment 3d, Constructing the Perimeter Walls of a Courtyard

- Construct the perimeter walls of a courtyard according to the given dimensions.

Total = 1 period

Assignment 4A, Locating 3 Plane Composition within Perimeter (*design discussion*)

- Locate the 3 plane composition (cube) within the perimeter walls of courtyard. Discuss the spatial relationships of the student teams.

Total = 1 period

Assignment 4B1, Locating Slots within the Cube Frame (*design discussion*)

- Discuss the best ideas for where to place the slots.

1 period

- Cutting the slots.

1 period

- Locating the composed slots within the cube frame

1 period; Total = 3 periods

Assignment 4B2, Locating Slots

- Think about a SECOND composition of slots.

1 period

- Cutting the slots.

1 period; Total = 2 periods

Assignment 4B3, Cutting Slots

- Cutting the slots for the chosen design.

1 period

- Cutting the slots.

1 period; Total = 2 periods

Assignment 4C, Beams and Columns are added onto the Cube

- Add columns and beams on to the frame where edges of planes are located.

1 period

- Construction

1 period; Total = 2 periods

Assignment 4D, Beams and Columns are added onto the Cube

- Columns and beams are added to top, front and back to clearly show the proportions of the spaces.

1 period

- Construction

1 period; Total = 2 periods

Assignment 4E, Planes are added onto the Cube

- Add planes on top, front and back in ways to strengthen the presence of each space.

1 period

- Construction

1 period; Total = 2 periods

Assignment 5, Orthographic Drawings*

- Draw all required levels' plans. Use an A-3 sheet of paper or tracing paper.

1 period

- Draw 4 required elevations. Use an A-3 sheet of paper or tracing paper.

1 period

- Draw 2 sections (cross and longitudinal)

1 period; Total = 3 periods

Assignment 6, Oblique Drawing*

- Draw an oblique view of the constructed cube (composed slots and frame). Use an A-3 sheet of paper. According to the instructor's instruction

Total = 2 periods

Assignment 7, Perspective Drawing*

- Draw a one point perspective of the constructed cube (composed slots and frame). Use an A-3 sheet of paper. According to the instructor's instruction

Total = 2 periods

Assignment 8, Composing All Drawings-

- Composing all drawings of 5, 6 and 7. Use an A-3 sheet of paper.

Total = 1 period

Assignment 9, Final Drawing*

- Prepare the final drawing of assignment 8

Total = 2 periods

Assignment 10, Final Presentation*

- Be prepared for final presentation of model and drawings.

Total= 2 periods

G. total= 42 periods

No.	(Design 1) Marks Summery sheet			
	Activity Name	Sub-activity name	Points	Total Points
1	Home works		15%	15%
2	Class work	Modeling	15%	20%
3		Paper work	5%	
4	Quizzes		10%	10%
5	Attendance		5%	5%
6	20% exam		20%	20%
7	Final exam	Presentation	10%	30%
8		Oral exam	20%	
9	Total		100%	

Check Out the Tools for the Semester

Faculty of Engineering Department of Architecture: Mar. 10.2009		Student Number																														Remarks
Tools' Number	TOOLS																															
1	T-square																															
2	(30°-60°) triangles																															
3	45° triangles																															
4	eraser shield																															
5	metal edge																															
6	x-acto knife																															
7	Cutting matt																															
8																																
Date received																																
Date returned																																
Signature																																

Project 1, Assignment 1

Introduction:

Without knowing our own body dimensions and its appropriate natural proportions which is the base of every manmade object, we cannot design in a proper way. Nature is the first theme of imitation for humankind.

In a prompt look at our surrounding materials, obviously we can see the great impact and influence of the natural phenomena. Therefore, as a first assignment we should know our body dimensions for instance, the height and the width of our body, the length of our arms, legs and etc.

Vocabulary:

You will need to learn important technical words in order to use the English textbooks. Study the English words that describe the sketches on the accompanying pages of this assignment.

Student Learning Objectives:

- To become familiar with their own body dimensions.
- To strengthen the idea that “we are designing for human use.”
- Learning to think of human proportions and scale in three dimensions.
- Learning to draw two and three dimensional human scale.
- To strengthen their free hand skill as a primary design tool.

Particular Design Issues of the

- Learning all the human body scales according to its natural dimensions.
- Free hand sketching.
- Comparing the human body dimensions with building and furniture dimensions.
- Learning to draw particular positions of the human body.

Design requirements:

- Draw required drawings onto an A4 sheet at scale 1:25.
- Required drawings shown by red dots on accompanying pages of assignment.

Evaluation criteria:

- Accurate dimensions and proportions
- Free hand sketching ability
- Know the different methods of representing the human body

Readings:

See Ernst and Peter Neufert, *Architects' Data*, “Man: Dimension and space requirements, Body measurements” pages 2, 3 and 4 of this assignment.

Schedule: See separate schedule for projects 1-10. (The schedule will be announced by the instructor)

Required Materials and Equipment:

PROJECT 1, ASSIGNMENT 1: Human Scale

Material:

- use an A-4 sheet white paper.

Equipment:

- pencils
- eraser
- tape
- scale

Project 1, Assignment 2

Introduction:

Perspective is a type of drawing that tries to show a design in a natural three dimensional way. In order to make a perspective, the student must know three things:

1. How to draw a perspective
2. The exact size and shape of the objects to be shown
3. The exact position where the observer is located.

Different types of perspective drawings can be found in the architectural drawing course textbook, *Design Drawing* by Francis D.K. Ching.

Vocabulary:

You will need to learn important technical words in order to use the English textbooks.

Station Point (S.P) = محل ایستادن شخص, Picture Plane (P.P) = سطح تصویر, Ground Level (G.L)= لیول زمین, Line of Sight (L.S) = خط دیدگاه, Cone of Vision (C.V) = مخروط دید, Horizon Line (H.L) = خط افق, Eye Level (E.L)= خط نظر, Vanishing Point (V.P) = نقطه فرار

Student Learning Objectives:

- To be able to accurately draw a perspective for a specified view.
- Learning to transfer two dimension drawing information into a three dimensional perspective.
- Learning to think of human proportions and scale in three dimensions.

Particular Design Issues of the Project:

- Technical precision of drawing
- Proper use of drawing equipment
- Learning the method of one point projected perspective

Design requirements:

- Draw required perspective onto an A3 and an A4 sheet as shown.

Evaluation criteria:

- Accurate dimensions and proportions.
- High quality of drawn lines.
- Line hierarchy using weights of pencil leads.

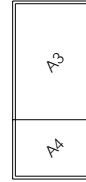

Readings:

See Francis D. K. Ching, *Design Drawing*, “Perspective Drawings” pages (201-203) and (226-231).

Schedule:

See separate schedule for projects 1-10. (The schedule will be announced by the instructor)

Required Materials and Equipment:

Material:

- use an A-3 and A-4 size sheets of white paper.

Equipment:

- T-square
- pencils
- eraser
- erasing shield
- tape

PROJECT 1

Assignment 2: One Point Perspective

- Draw a 10 meter cube frame, standing (SP, station point) 15m. in front of the cube and 2m. off center of cube frame.
- Draw into the perspective 1 scale figure standing 1m. in front of the cube.
- Draw a 5m square grid onto the floor of the cube.
- Draw into the perspective 1 scale figure standing inside the cube frame.

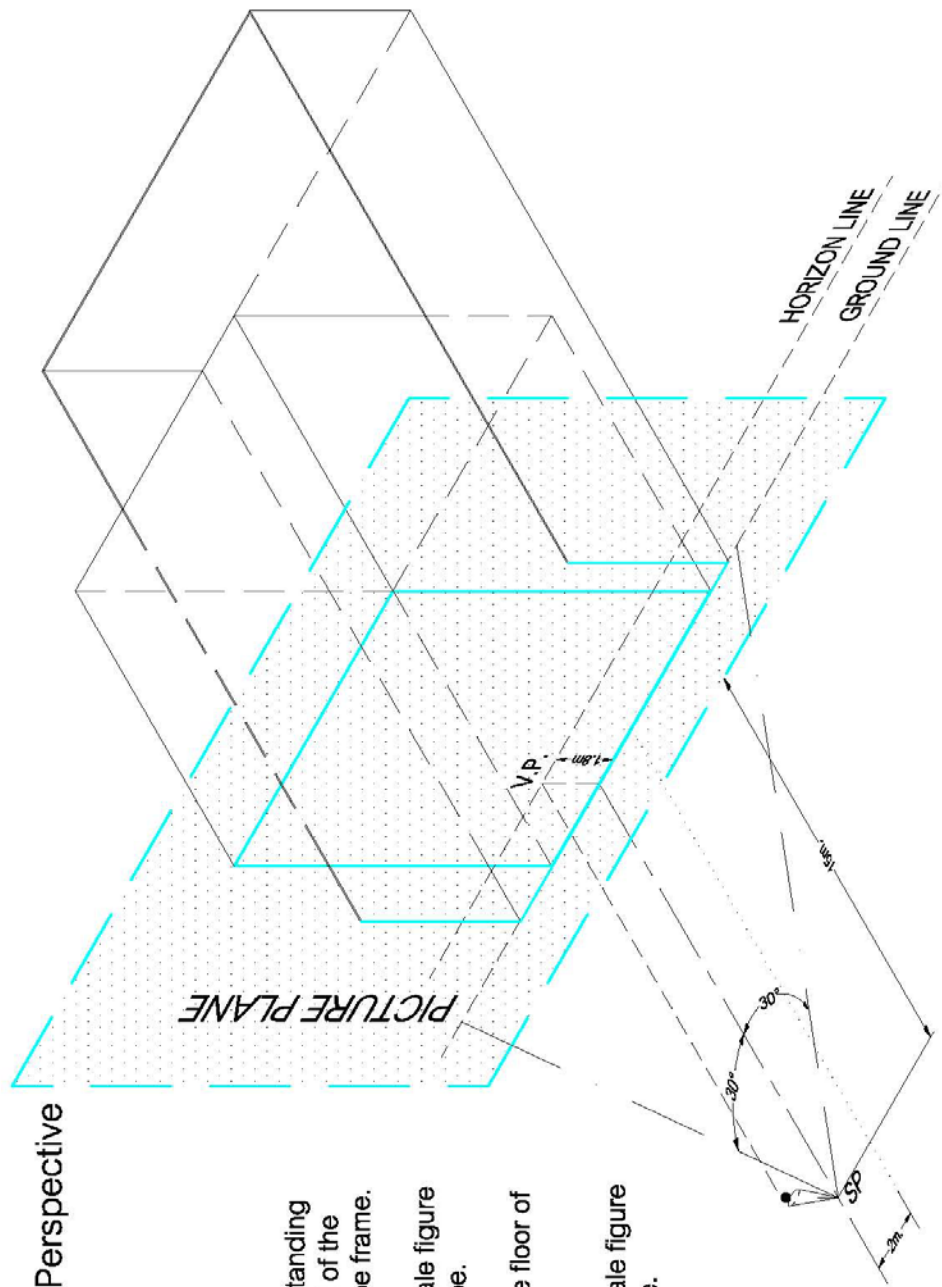

Assignment for Students:

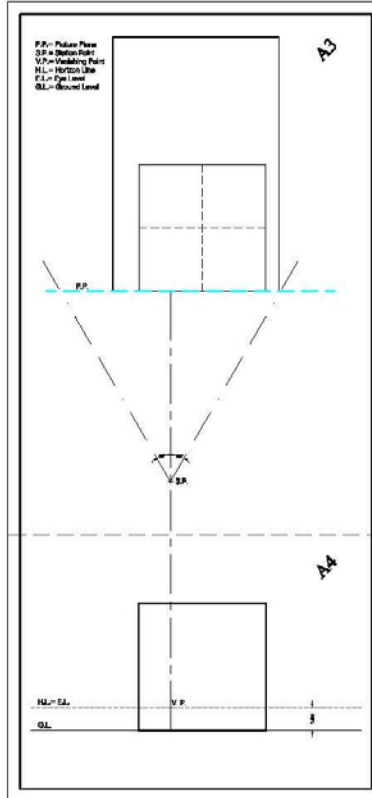

Instructors' guidance:

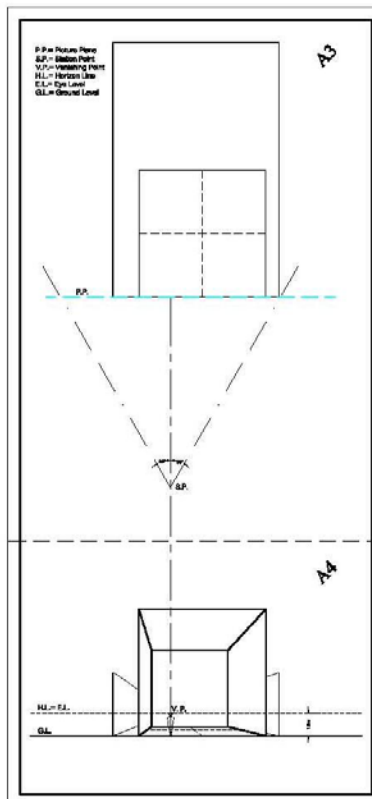

Project 2: The 10 Meter Cube

Introduction:

The purpose of architecture is to design carefully constructed spaces for the health and enjoyment of human life. As you learn the value of habitable space, you will understand an essential difference between architects and engineers. Whereas engineers draw and design solid objects, architects draw and design space. The creation of culturally appropriate space lies at the heart of architecture. Such architecture is the built expression of the values, beliefs and expectations of a culture.

The purpose of this project is to help you visualize the creation of space. You will do this making drawings and making models. You will be asked to look carefully at what spaces you are making and learn to discuss the qualities of these spaces.

Vocabulary:

You will need to learn important technical words in order to use the English textbooks.

- Form=شکل
grid=شبكة چهارخانه , square=مربع , mass=كتله / cube=مكعب ; void=فضای خالی / cell=حفره , حجره
- Structure=ساختمان
column=پایه , ستون , beam=تیر , گادر
- Relationships=ارتباطات
center=مرکز , وسط , edge=لبه , کنار , proportion=تناسب , regulating lines=خطوط تنظیم , spatial=فاصله ای , فضائی ,
hierarchy=سلسله مراتب فضائی , primary=مقدماتی , اولیه , secondary=درجه دوم , ثانویه , tertiary=سومین , ثالثه ,
symmetry=تناظر , تقارن , asymmetry=نا متناظر , عدم تقارن , equilibrium or balance =تعدادل , abstract=غیر , خیالی , مطلق ,
عملی , contrast=اختلاف , تقابل , تباین , tectonics=ساختمان زمین

Student Learning Objectives:

- To learn to see and imagine space
- To begin composing a collection of spaces
- To become able to think about and represent design issues abstractly.
- To become aware of the use of diagrams as an aid to architectural thinking.
- To examine basic geometric design principles.
- To represent the information with clarity and appropriate contrast.
- To develop good drawing and model building skills.
- To learn to use equipment and materials in a professional way

Particular Design Issues of the Project:

- Principals of geometric structure
- Regulating lines, square
- Equilibrium: symmetry versus asymmetry
- Center versus edge
- Primary versus secondary spaces
- Multiple and overlapping spatial readings
- Sequence and movement
- Implied tectonics

Design Requirements:

- This project requires both drawings and a model that are done in a series of steps.

Evaluation criteria:

- Ability to recognize and identify architectural space, and examine its basic geometric properties.
- Graphic quality of diagrams expressing abstract architectural thinking.
- Care in execution of diagrams: line hierarchy, line quality, page arrangement, and with clarity and appropriate contrast.

Readings:

See Francis D. K. Ching, *Design Drawing*, "Elevation Oblique Drawings" pages 187-189.

Schedule:

The work schedule (time) is limited in order to manage the sequence of the design in the proper order. (The schedule will be announced by the instructor).

Project 2, ASSIGNMENT 1: Subdividing the square and the cube

Material:

- use an A-3 sheet of white canson paper.
- overlay this sheet with tracing paper to use for initial layout.
- each student makes a drawing of page 2 where the length of the side of a square is 4cm.

Equipment:

- T-square
- pencils
- eraser
- erasing shield
- tape

OBLIQUE DRAWING AND ANALYSIS

Assignment 1: Subdividing the Square and the Cube

- See Instructions page 15



1, Square

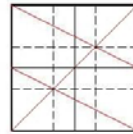

graphically dividing
a square into 9 equal squares

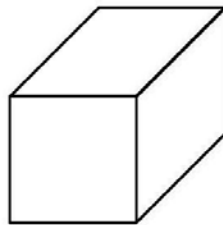

2, Cube / Mass

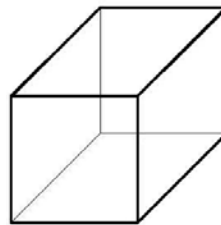

3, Cell / Void

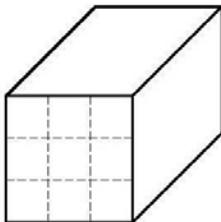

4, Subdivide Front Plane

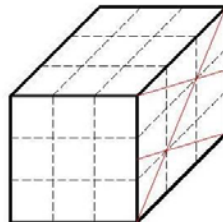

5, Subdivide Cell Edges

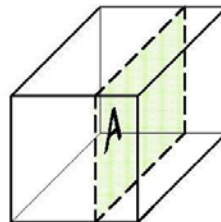

6, Dash Line Inside
Plane A (make dash line
through third point
crossing)

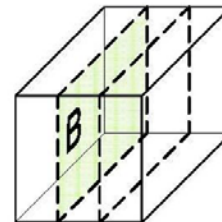

7, Dash Line Inside Plane B

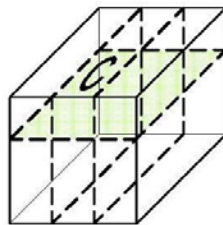

8, Short Dash Line Top
Inside Plane C

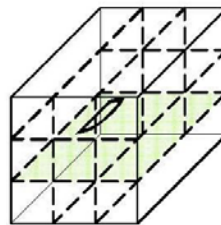

9, Short Dash Line
Bottom Inside Plane

Project 2, ASSIGNMENT 2: Finding the inner cube

Material:

- use an A-3 sheet of white canson paper.
- overlay this sheet with tracing paper to use for initial layout.

Equipment:

- T-square
- pencils
- eraser
- erasing shield
- tape

Assignment 2: Finding the Inner Cube

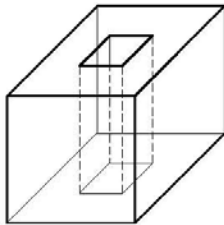

1, Step One

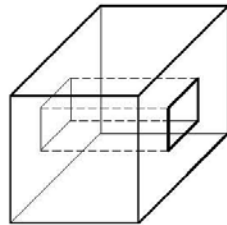

2, Step Two

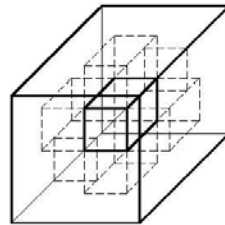

3, Step Three

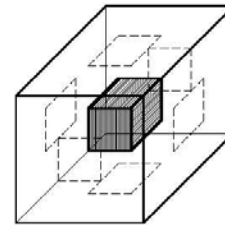

4, Step Four

Assignment 3a: Drawing 3 Architectural Planes Within the Cube

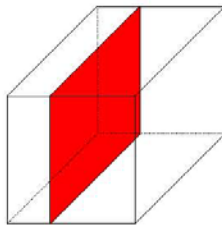

1, YZ Plane
(3x3)

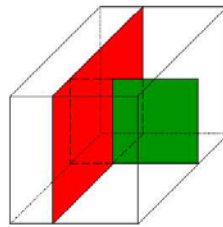

2, XZ Plane
(2x3)

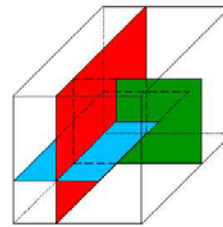

2, XY Plane
(2x3)

1. Rule: Each plane must lie inside the cube.
2. Rule: Each plane must follow one of the 1/3 subdivisions.
- 3a. Rule: Allow the 3rd plane to either touch or intersect the other planes.
- 3b. Explore alternative positions of the 3rd plane.
4. Optional: A 1x1x1 mass cube can also be added.

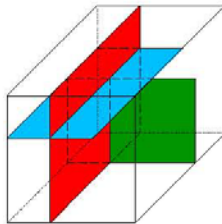

4, Example A

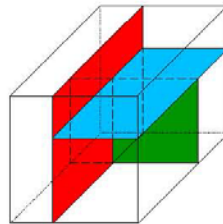

5, Example B

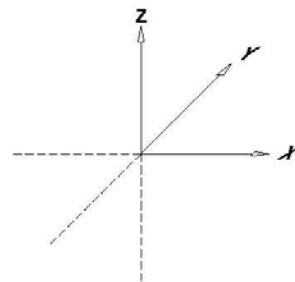

Project 2, ASSIGNMENT 3a: Drawing 3 architectural planes with the cube

Material:

- use an A-3 sheet of white canson paper.
- overlay this sheet with tracing paper to use for initial layout.

Equipment:

- T-square
- pencils
- colored pencil
- eraser
- erasing shield
- tape

Project 2, ASSIGNMENT 3b: Constructing the cube frame

Material:

- use 1/8"= 3mm. square section bars wood stick
- Elmer's glue

Equipment:

- cutting mat
- metal straight edge
- X-Acto knife

Assignment 3b: Constructing the Cube Frame

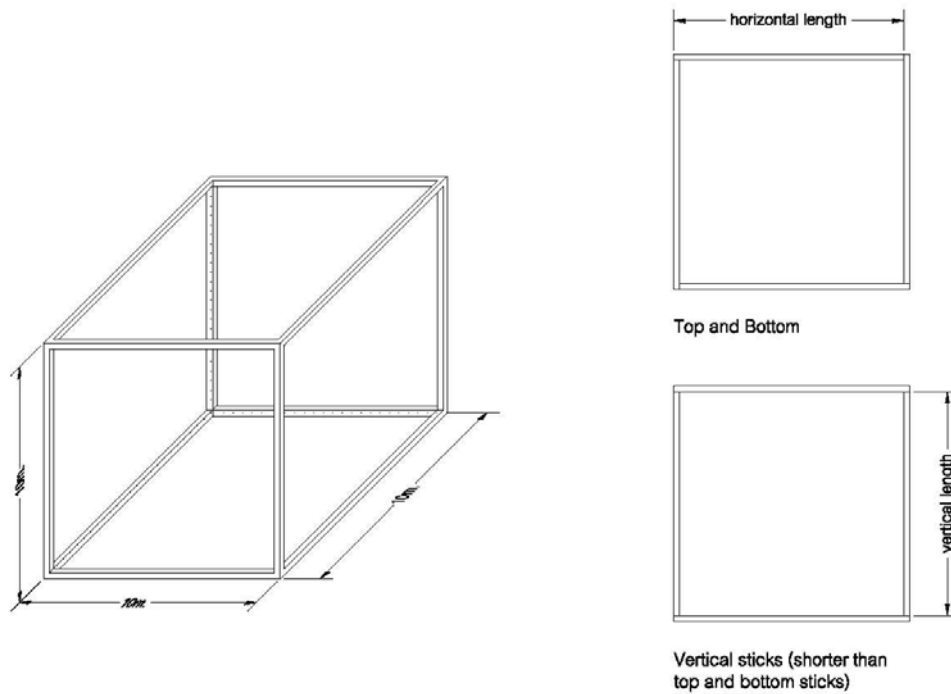

1. Rule: Construct a (10x10x10)m. cube frame at scale 1:100m.
2. Rule: Be sure that inside dimension of the frame is the same for all 3 dimensions.

NOTE: Pay attention that all lengths of the sticks can NOT be the same.

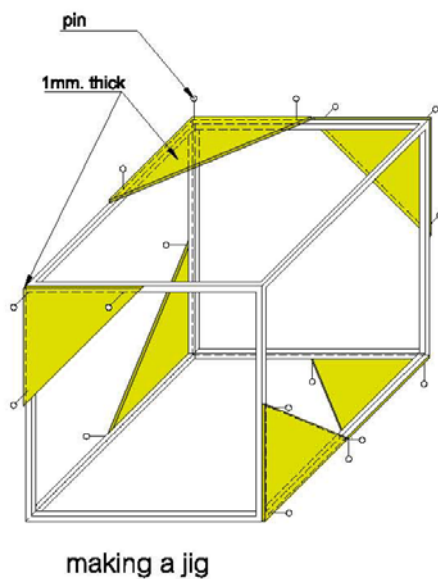

- use pins, rubber bands, or clamps and small triangles to keep the frame square while the glue is drying.

Project 2, ASSIGNMENT 3c: Constructing the 3 plane composition

Material:

- 3mm. thick cardboard or foam core
- Elmer's glue

Equipment:

- pencils
- straight edge
- cutting mat
- metal straight edge
- X-Acto knife

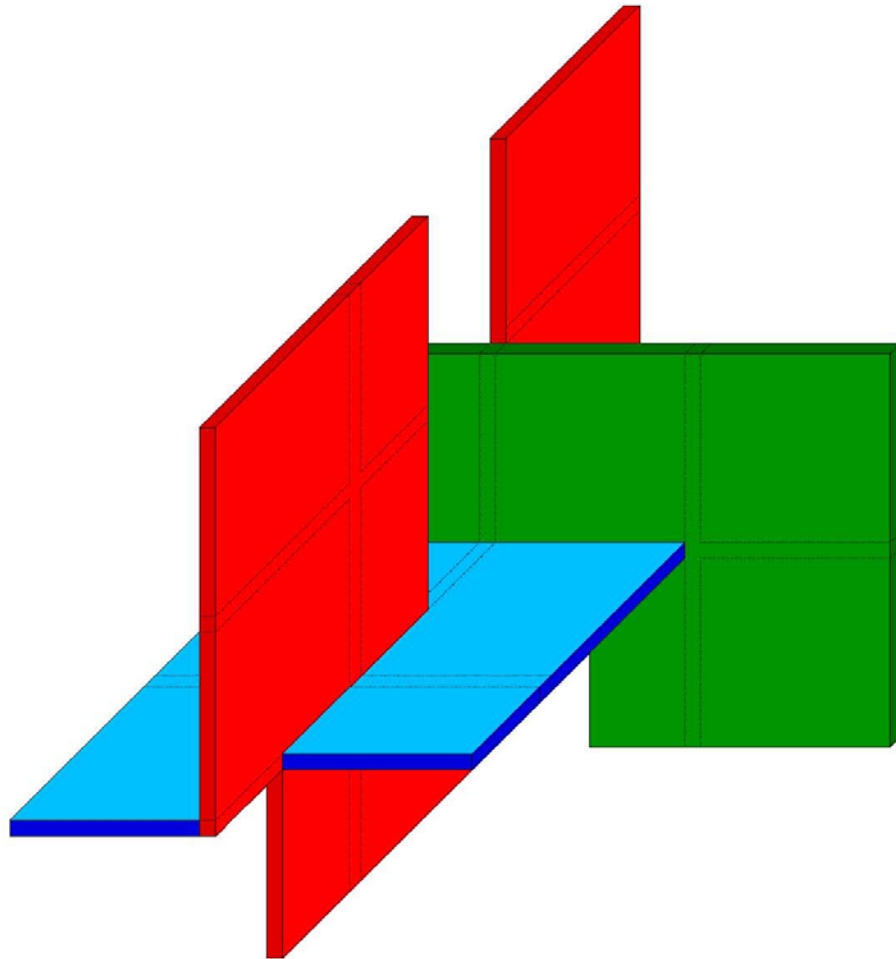

EXAMPLE A: With connection slots

ASSIGNMENT 3c: Constructing the Composition

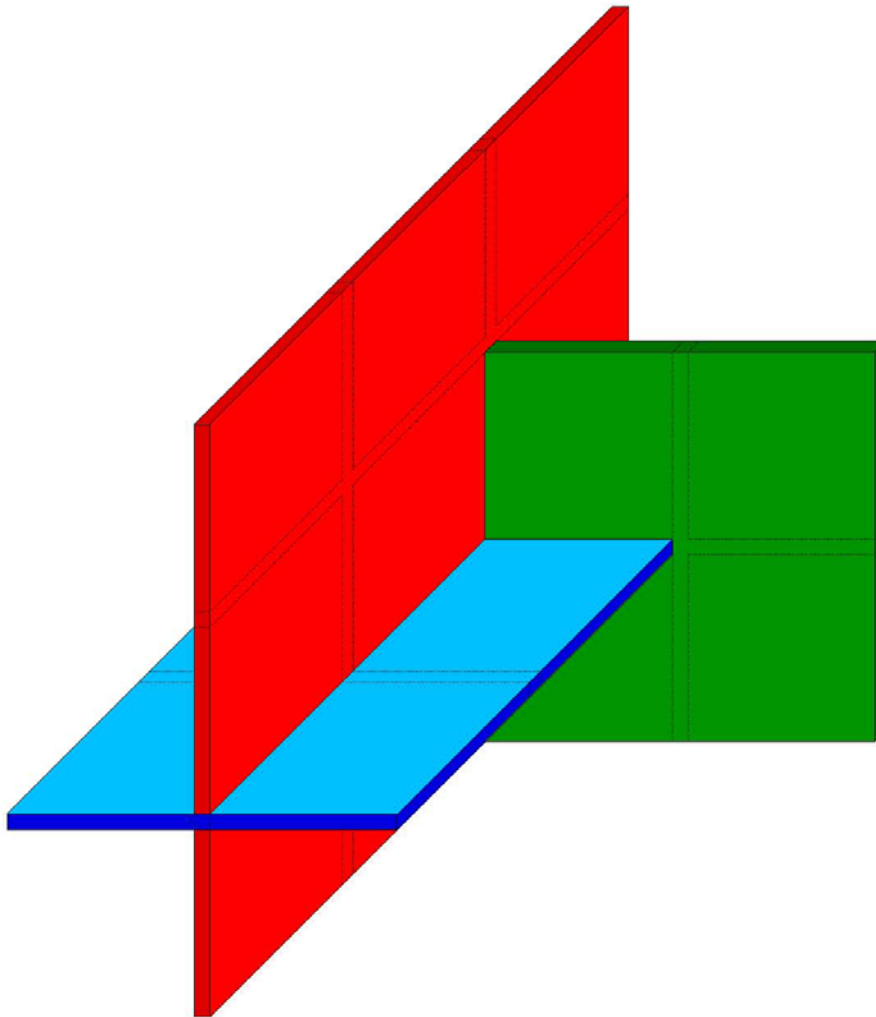

1. Each student selects their favorite composition for assignment 3a.

2. Measure exactly the inside dimension of the cube frame for assignment 3b.

3. Draw carefully each plane of assignment 3a such that the 3 cell length all planes follows rule 7.

see drawing on page 6

4. Rule: Lightly draw onto all planes the location of the $\frac{1}{3}$ divisions of the cube.

5. Rule: Carefully cut all planes to have 90° corners.

6. Rule: Carefully make smooth and straight edges for each plane.

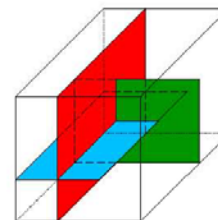

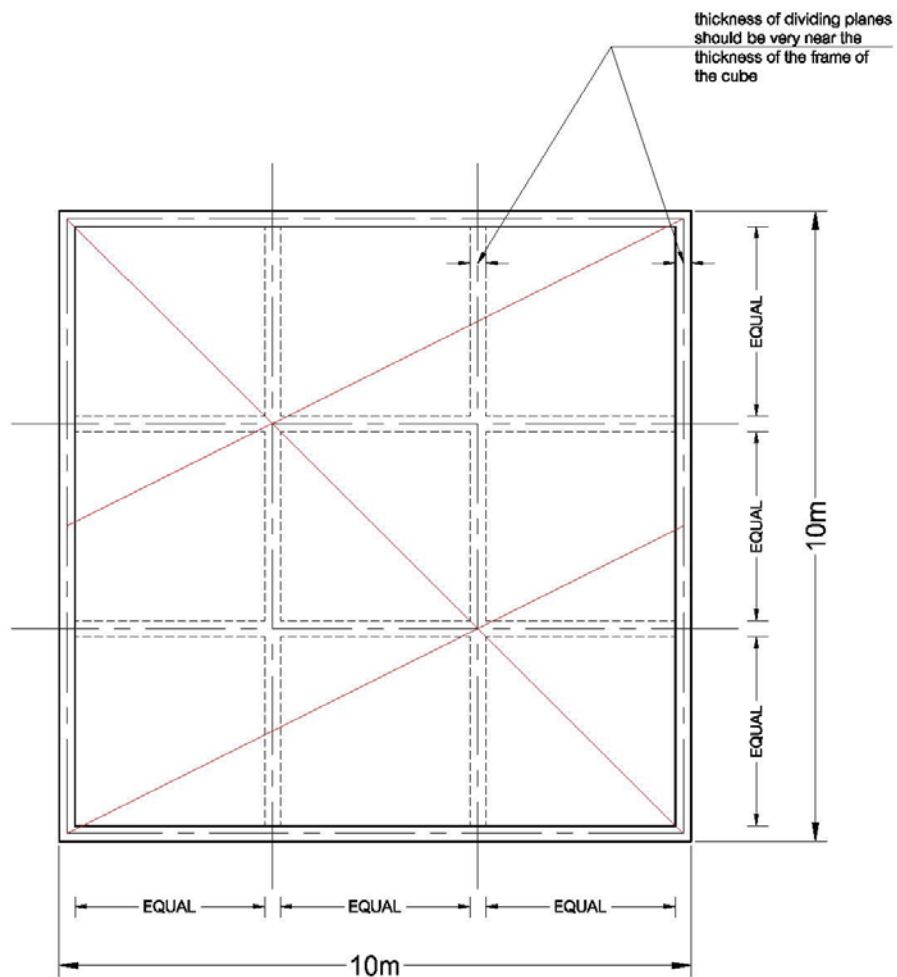

7. Rule : Correctly Drawing the Size and Locations of Subdividing Planes

1. Use the INSIDE dimension of the cube frame for the length of the dividing plane.
2. Use the graphic technique for finding the third point subdivisions of the square.
3. Draw dotted lines to show the thickness of the dividing planes.

Putting the 3 Planes Together:

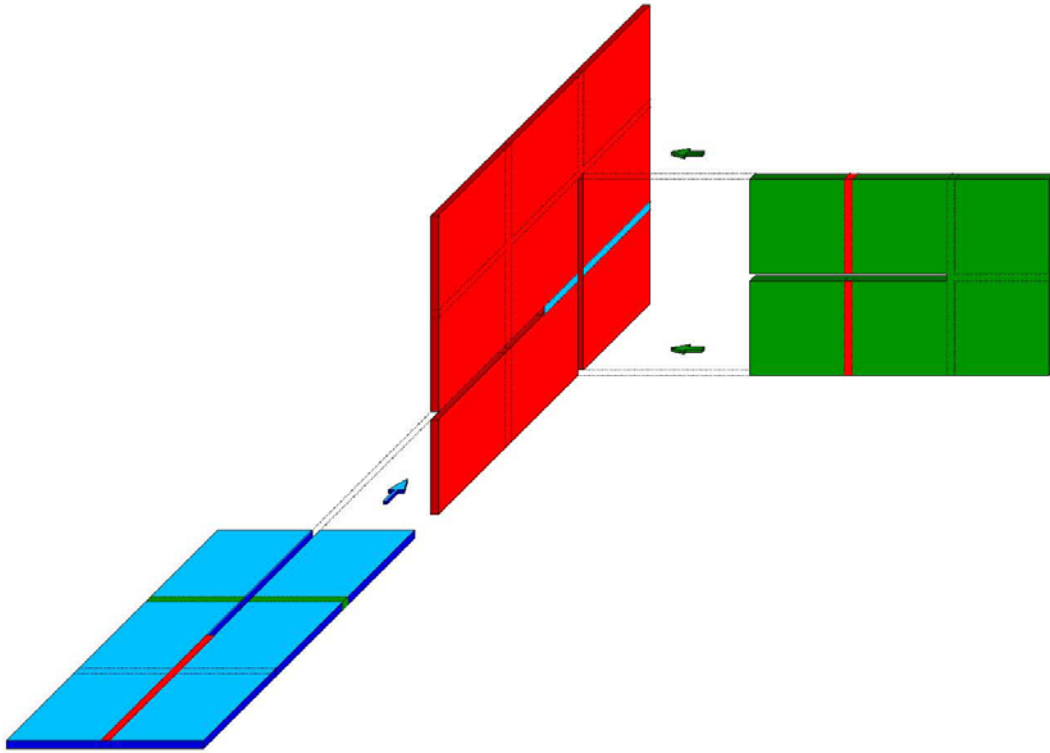

- According to the figure join the composition of planes and glue them as well.
- Make sure that the angles between the planes are 90 degrees.

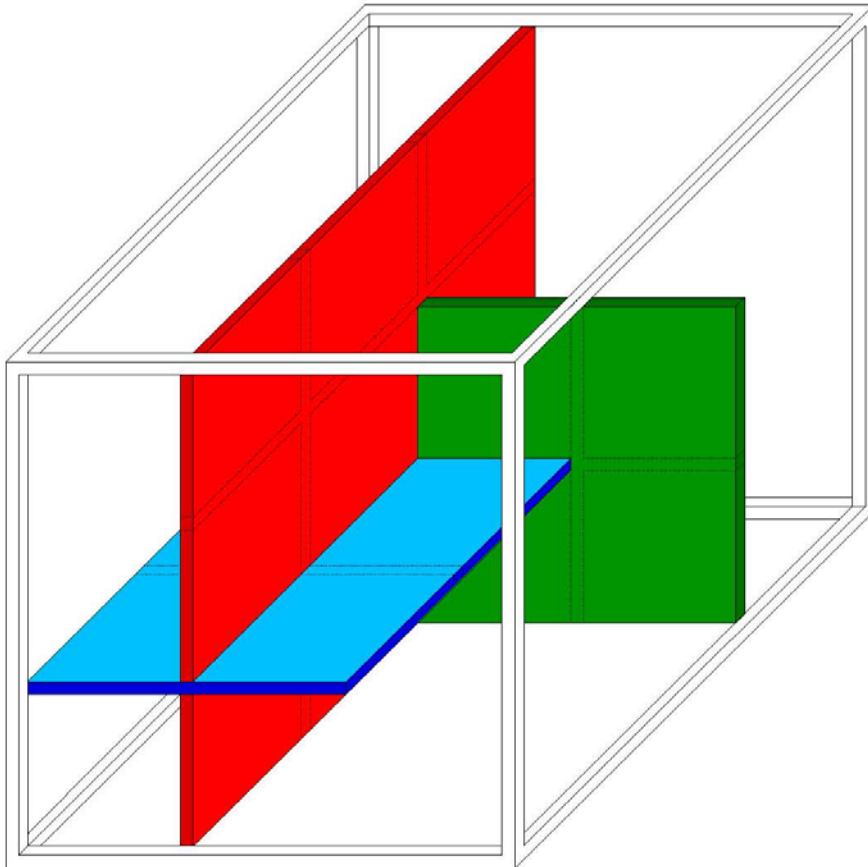

Place the composition of planes inside the cube frame. Do NOT glue planes and frame together.

Project 2, ASSIGNMENT 3d: Constructing the perimeter walls of a courtyard

Material:

- 5mm. thick card board or foam core
- Elmer's glue

Equipment:

- pencils
- straight edge
- cutting mat
- metal straight edge
- X-Acto knife

Assignment 3d: Constructing the Perimeter Walls of a Courtyard

MATERIALS:

- use $\frac{1}{4}$ " \approx 5mm. thick [white foamcore board]
- use Elmer's glue
- use metal straight edge for cutting
- use X-Acto knife for cutting
- use cutting mats so as to not destroy Japanese drawing boards.
- need metric scale
- need T-square and triangles

DIRECTIONS:

- Construct the ground and surrounding walls at scale 1:100m.
- Construct corners according to Detail A.

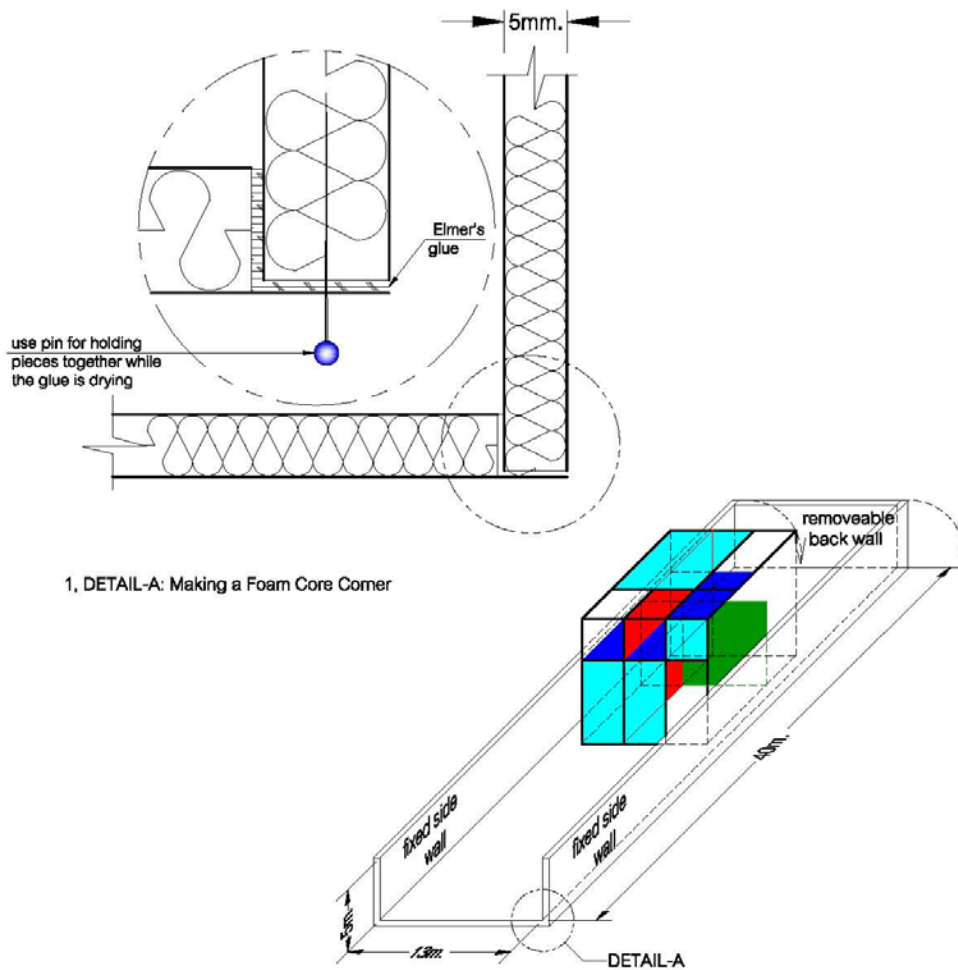

IMPORTANT NOTE: As many as 4 students can share one of these courtyard models.

Project 2, ASSIGNMENT 4A: Locating 3 plane composition within the perimeter walls

Material:

- more card board or foam core as needed
- more wood sticks as needed

Equipment:

- pencils
- straight edge
- cutting mat
- metal straight edge
- X-Acto knife

Project 2, ASSIGNMENT 4B1: Locating Slots within the Cube Frame

Material:

- more card board or foam core as needed
- more wood sticks as needed

Equipment:

- pencils
- straight edge
- cutting mat
- metal straight edge
- X-Acto knife

Project 2, ASSIGNMENT 4B2: Locating Slots

Material:

- more card board or foam core as needed
- more wood sticks as needed

Equipment:

- pencils
- straight edge
- cutting mat
- metal straight edge
- X-Acto knife

Project 2, ASSIGNMENT 4B3: Cutting Slots

Material:

- more card board or foam core as needed
- more wood sticks as needed

Equipment:

- pencils
- straight edge
- cutting mat
- metal straight edge
- X-Acto knife

Project 2, ASSIGNMENT 4C: Beams and Columns are added onto the Cube

Material:

- more card board or foam core as needed
- more wood sticks as needed

Equipment:

- pencils
- straight edge
- cutting mat
- metal straight edge
- X-Acto knife

Project 2, ASSIGNMENT 4D: Beams and Columns are added onto the Cube

Material:

- more card board or foam core as needed
- more wood sticks as needed

Equipment:

- pencils
- straight edge
- cutting mat
- metal straight edge
- X-Acto knife

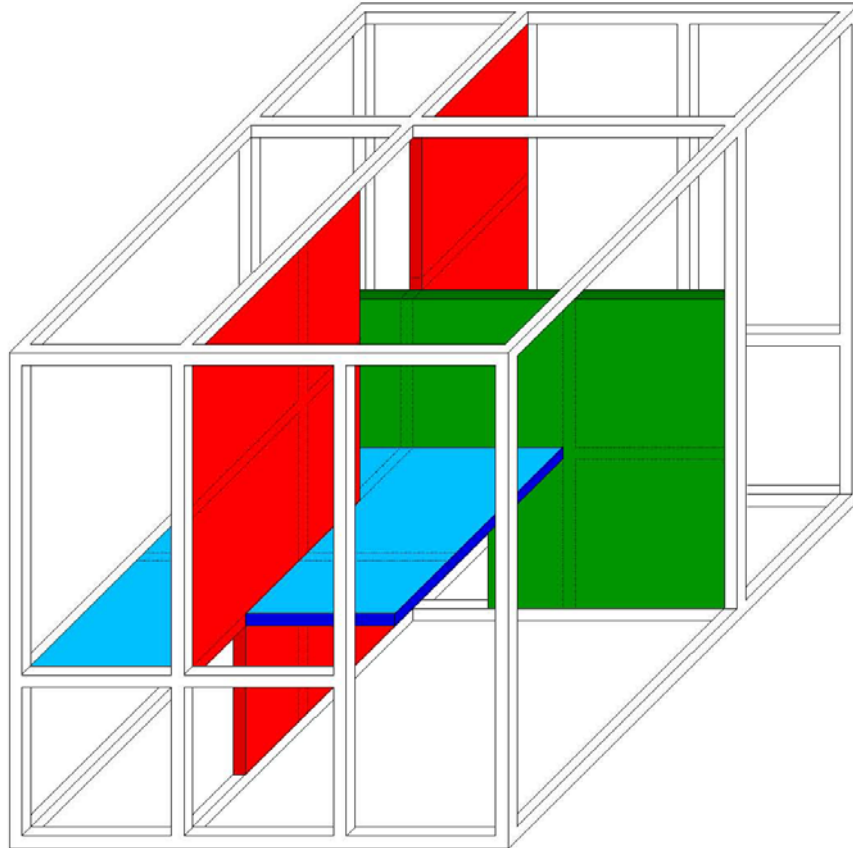

Perimeter Beams and Columns are Added Onto Edges of the Subdivision Planes

NOTE: Additional perimeter beams and columns can be added to better define the inside spaces

Project 2, ASSIGNMENT 4E: Planes are added onto the Cube

Material:

- more card board or foam core as needed
- more wood sticks as needed

Equipment:

- pencils
- straight edge
- cutting mat
- metal straight edge
- X-Acto knife

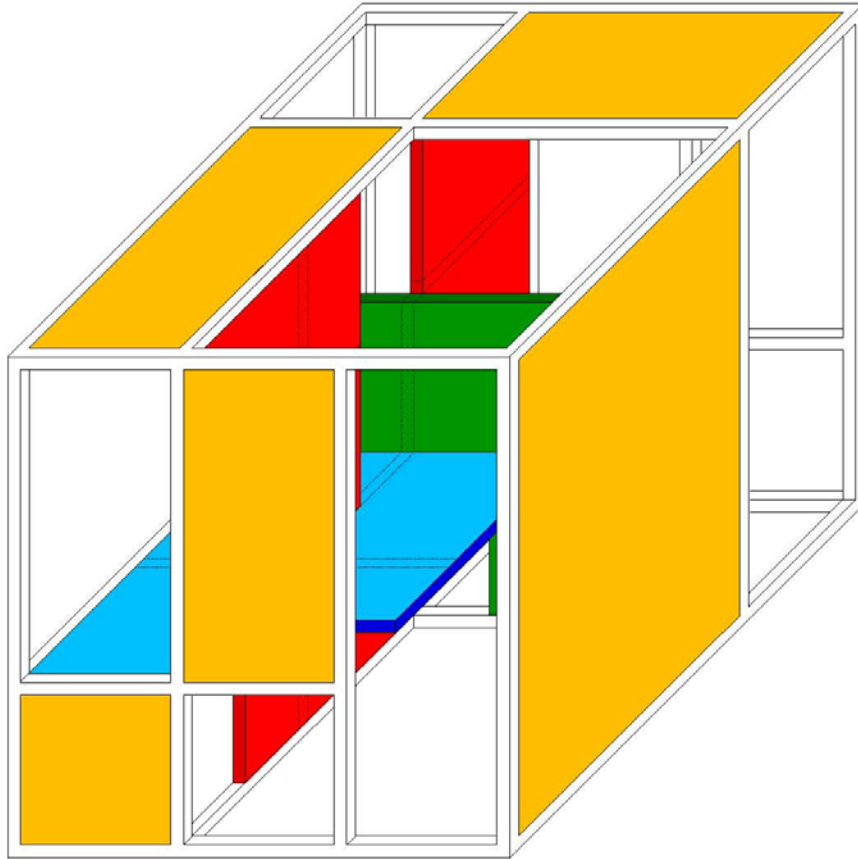

Adding planes on the outside of the cube to strengthen the definition of the interior spaces.

Project 2, Assignment 5, Orthographic Drawings

Introduction:

As multi-view drawings imply the drawing types like plans, elevations, and sections each of them represents an orthographic projection of a specific object or construction. Actually these orthographic views are a kind of graphic projection which does not match optical reality, what our natural eye lets us see.

Orthographic projection is a system of projection which represents an object by projecting lines perpendicular to the picture plane. To construct an orthographic projection, we draw parallel projectors from the various points in the object to intersect the picture plane at right angles. We then connect the projected points in their proper order to obtain the view of the object on the picture plane. We refer to the resulting image on the picture plane as an orthographic view.

Vocabulary:

You will need to learn important technical words in order to use the English textbooks. poche= سیاه کردن , plan= پلان , section= مقطع , elevation= نما , ارتفاع , multiview= چندنمایی , optical= بصری , perpendicular= عمودی , projection= پرتاب , ایستاده

Student Learning Objectives:

- To accurately cut a horizontal and vertical sections through a design.
- To accurately show what materials are cut and what are not.
- To accurately present a series of plans upon a sheet.
- To accurately draw and present elevations.
- To accurately draw and present sections.

Particular Design Issues of the Project:

- Correct translation of information in model presented in orthographic drawings.
- Correctly constructing and drawing plans, elevations, and sections
- Graphically composing the drawings to be easily read as a group.

Design Requirements:

- PLANS, draw at scale 1:200 plans for ground level, second level, and roof top level.
- PLANS, draw the courtyard together with the ground level plan of the cube.
- PLANS, compose the three plans in a vertical manner as shown in Ching, *Design Drawing*, p. 142
- ELEVATIONS, draw at scale 1:200 elevation of all four sides of the cube.
- Include the courtyard as part of the elevations.
- SECTIONS, draw at scale 1:200 the cross sectional and longitudinal sections of the design.
- Students should choose the best location for taking the sections in order to show the inside and outside space most clearly. Sections must include both the cube and the courtyard.

Evaluation Criteria:

- Correctness, completeness, craft of drawing.
- Line quality and line hierarchy.

Readings:

See Francis D. K. Ching, *Design Drawing*, pages (134-163).

- Plan Drawings, pages 134-142
- Building Elevations, pages 148-153
- Building Sections, pages 154-163

Schedule:

See separate schedule, assignment 5 (orthographic drawings).

Project 2 Assignment 5: Orthographic Drawings

- Draw all required levels' plans. Use an A-3 sheet of paper or tracing paper.
- Draw 4 required elevations. Use an A-3 sheet of paper or tracing paper.
- Draw 2 sections (cross and longitudinal)

Material:

- use an A-3 sheet of white canson paper.
- overlay this sheet with tracing paper to use for initial layout.

Equipment:

- T-square
- pencils
- colored pencil
- eraser
- erasing shield
- tape

Project 2, Assignment 6, Oblique Drawing

Introduction:

Oblique projection is one of three major types of projection drawing. The images that emerge from oblique projections belong to the pictorial family of 3D (three dimensional) drawings but are specified from the isometric and diametric views that develop from orthographic projection. In oblique projection, a principal face or set of planes in the object is oriented parallel to the picture plane as in orthographic multi-view drawing, but the image is transmitted by means of parallel projectors oriented at any angle other than 90° to the picture plane. We keep the length and height of the object as its true size, but we can reduce the length of the width $\frac{1}{2}$, $\frac{2}{3}$, and $\frac{3}{4}$ of the true length. The angle that we draw for the depth can be (30°, 45°, 60°, and 75°). See *Design Drawing*, p. 186

Vocabulary:

You will need to learn important technical words in order to use the English textbooks.

pictorial= وسایل تصویری , parallel= موازی , dimensional= بُعدی , principal= مهم ، اصلی , transmitted= انتقال داده شده , oriented= متمایل به، جهت دار

Student Learning Objectives:

- To accurately draw and present an oblique drawing.
- To accurately show what is required for an oblique drawing.
- To accurately know the usage of an oblique drawing and its prevalence and excellence in comparison with other types of drawings.

Particular Design Issues of the Project:

- Technical precision of drawing
- Proper use of drawing equipment

Design Requirements:

- Draw the oblique view of the composed cube with its inside slots in an A-3 size sheet.
- Use a 1/200 scale for this drawing.
- For further information about oblique drawings in general definition, see Francis D.K. Ching, *Design Drawing*, pages (186, 187).

Evaluation Criteria:

- Correctness, completeness, craft of drawing.
- Line quality and line hierarchy.
- Required accuracy for these types of drawings according to instructions in Ching's mentioned book.

Readings:

See Francis D. K. Ching, *Design Drawing*, pages (186-191).

Schedule:

See separate schedule, assignment 6 (oblique drawing).

Project 2, Assignment 6: Oblique Drawing

- Draw an oblique view of the constructed cube (composed slots and frame). Use an A-3 sheet of paper. According to the instructor's instruction

Material:

- use an A-3 sheet of white canson paper.
- overlay this sheet with tracing paper to use for initial layout.

Equipment:

- T-square
- pencils
- colored pencil
- eraser
- erasing shield
- tape

Project 2, Assignment 7, Perspective Drawing

Introduction:

Perspective is a type of drawing that tries to show a design in a natural three dimensional way. In other words, perspective gives objective definition for the spaces which are subjective, before they do exist. The term perspective, however, most often brings to mind the drawing system of linear or artificial perspective.

Linear perspective is the art and science of describing three-dimensional volumes and spatial relationships on a two-dimensional surface by means of lines which converge as they recede into the depth of a drawing. In any rectilinear object, as a cube, each of the three principal sets of parallel lines has its own vanishing point. Based on these three major sets of lines, there are three types of linear perspective: 1-, 2-, and 3- point perspectives.

Different types of perspective drawings can be found in the architectural drawing course textbook, *Design Drawing* by Francis D.K. Ching, (201 and 225).

Vocabulary:

You will need to learn important technical words in order to use the English textbooks.

objective = عینی، دارای وجود خارجی، subjective = درون گرایی، ذهنی، rectilinear = دارای مسیر مستقیم راست خطی،
There are similar words for this assignment, see page 5, project 1, Assignment 2.

Student Learning Objectives:

- To be able to accurately draw a perspective for a specified view.
- Learning to transfer two dimension drawing information into a three dimensional perspective.
- Learning to think of human proportions and scale in three dimensions.
- Learning to draw a perspective with different positions of eye level.

Particular Design Issues of the Project:

- Technical precision of drawing
- Proper use of drawing equipment
- Learning the method of one point projected perspective
- Learning variety of possible ways to change the eye level

Design Requirements:

Draw required perspective onto an A3 and an A4 sheet as shown

Evaluation Criteria:

- Accurate dimensions and proportions.
- High quality of drawn lines.
- Line hierarchy using weights of pencil leads.

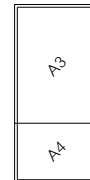

Readings:

See Francis D. K. Ching, *Design Drawing*, “Perspective Drawings” pages (201-203) and (226-231).

Schedule:

See separate schedule for projects 1-10. (The schedule will be announced by the instructor).

Project 2, Assignment 7: Perspective Drawing

- Draw a one point perspective of the constructed cube (composed slots and frame). Use an A-3 sheet of paper. According to the instructor's instruction

Material:

- use an A-3 sheet of white canson paper.
- overlay this sheet with tracing paper to use for initial layout.

Equipment:

- T-square
- pencils
- colored pencil
- eraser
- erasing shield
- tape

Project 2, Assignment 8, Composing all Drawings

Introduction:

Drawing is a system of design. Neither the appropriate choice of viewpoint nor beauty of technique is sufficient without a concern for composition. In composing a drawing, we control the fundamental graphic elements of line, shape, and tone into coherent figure-ground patterns which convey visual information. Through the organization and relationship of these elements, we define both the content and the context of a drawing. Planning this composition is therefore critical to the message it communicates. *Design Drawing* by Francis D.K. Ching,(303 and 313).

Vocabulary:

You will need to learn important technical words in order to use the English textbooks.

sufficient = شایسته ، کافی، بسنده، composition= آرایش، ترکیب، coherent= دارای ارتباط منطقی ، مربوط ، محتوا، مضمون = content ، context= متن ، مفهوم، مفهومی، critical= حیاتی، مهم، بحرانی، focal point= نقطه مرکزی یا کانونی

Student Learning Objectives:

- To be able to accurately choose or cut the drawing sheets according to the required scale of drawings.
- To be able to accurately compose the drawing sheets.
- To create visual interest and movement, place the focal point of a drawing.
- Learning to arrange from left to right (English and technically) and right to left (for our local clients).

Particular Design Issues of the Project:

- Recheck and ensure about the number of required drawings for the specific design
- Technical requirements for drawings
- Proper use of drawing equipment

Design Requirements:

- Proper position orientation and labeling of drawings
- Graphic unity of four sheets into one visual composition

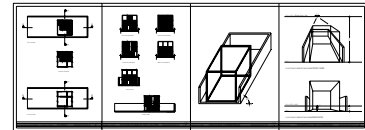

Evaluation Criteria:

- Proper preparation of the title box and other required letterings.
- Accurate sequence and coherence of drawing sheets.
- Accurate sequence of sheet numbers.

Readings:

See Francis D. K. Ching, *Design Drawing*, “Drawing Composition” pages (303-321).

Schedule:

See separate schedule for projects 1-10. (The schedule will be announced by the instructor).

Project 2, Assignment 8: Composing All Drawings

- Composing all drawings of 5, 6 and 7. Use an A-3 sheet of paper.

Material:

- use an A-3 sheet of white canson paper.
- overlay this sheet with tracing paper to use for initial layout.

Equipment:

- T-square
- pencils
- colored pencil
- eraser
- erasing shield
- tape

Project 2, Assignment 9: Final Drawing

- Prepare the final drawing of assignment 8

Material:

- use an A-3 sheet of white canson paper.
- overlay this sheet with tracing paper to use for initial layout.

Equipment:

- T-square
- pencils
- colored pencil
- eraser
- erasing shield
- tape

Project 2, Assignment 10, Final Presentation

Introduction:

The purpose of presentation drawings is to communicate strongly and simply the main idea of the design. These drawings describe a design proposal in a graphic method intended to persuade an audience of its value. The audience may be a client, a committee, or merely someone browsing for an idea. Whether produced to assist the client's imagination or to obtain a commission, either privately or through a competition, presentation drawings should communicate as clearly and accurately as possible. Although the drawings that include a presentation may be excellent two-dimensional graphics worthy of an exhibition, they are simply tools for communicating a design idea, never ends in themselves. *Design Drawing* by Francis D.K. Ching, (323 and 337).

Vocabulary:

You will need to learn important technical words in order to use the English textbooks.

Merely= محضاً، فقط، صرفاً، browsing= جستجو، worthy= سزاوار، شایسته، exhibition= نمایشگاه، ارائه، نمایش،

Student Learning Objectives:

- To be able to accurately present the drawings according to the book, *Design Drawing*, pages (324-331).
- To be able to know what are required for a presentation drawing.
- To know how to create a presentation drawing in order to grasp the viewers' interest.
- To improve some additional artistic skills for presenting a presentation drawing.

Particular Design Issues of the Project:

- Make sure that you have seen different kinds of rendering and other drawing improvement methods.
- Make sure to include all the design requirements, for instance, Plans, Elevations, Sections, etc.
- Practicing particular graphic methods for showing backgrounds and foregrounds of objects and space.

Design Requirements:

- Proper position orientation and labeling of drawings
- Graphic unity of four sheets into one visual composition

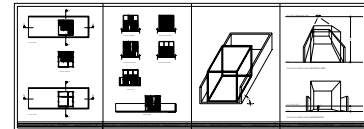

Evaluation Criteria:

- The influence and grace of design presentation on visitors.
- Accurate sequence and coherence of drawing sheets.
- The principles of unity and continuity of design drawing with the sheets' boundary according to the norms.

Readings:

See Francis D. K. Ching, *Design Drawing*, "Presentation Drawing" pages (323-337).

Schedule:

See separate schedule for projects 1-10. (The schedule will be announced by the instructor).

Project 2, Assignment 10: Final Presentation

- Be prepared for final presentation of model and drawings.