

DEVELOPMENT OF A SIMPLIFIED COMMERCIAL-SCALE AQUAPONIC
FACILITY FOR IMPLEMENTATION IN NORTHERN UGANDA

by

EMILY WICOFF

B.S., Kansas State University, 1998

A THESIS

submitted in partial fulfillment of the requirements for the degree

MASTER OF SCIENCE

Department of Civil Engineering
College of Engineering

KANSAS STATE UNIVERSITY
Manhattan, Kansas

2011

Approved by:

Steven Starrett, Ph.D., P.E., D.WRE, F.ASCE
Major Professor

Copyright

EMILY WICOFF

2011

Abstract

Current aquaponic technology ranges from backyard hobbyist to technologically advanced commercial production. A single source for protein (fish) and nutrients/vitamins (vegetables), development of a technologically simplified commercial-scale system is a realistic solution for many impoverished nations.

This study develops a simplified aquaponic facility to be implemented in rural northern Uganda. Research objectives were to: (1) identify simplified commercial-scale system design components, (2) establish a water quality baseline, (3) identify plant/tilapia production ratios, (4) identify construction materials available in northern Uganda, (5) integrate culturally familiar elements, (6) complete preliminary facility design, and (7) calculate facility water balance.

The study established that a viable simplified design achieves: (1) water circulation with weir gravity flow and one return pump, (2) tank cleaning with strategically sloped floors and manual waste siphoning, and (3) breeding control with raised bottom fishnets. Submerged aeration is critical to optimal fish growth, and cannot be eliminated despite surface aeration's low energy appeal.

Baseline water quality parameter values of $DO > 3$ mg/L, $pH > 5.5$, and $TAN > 3$ mg/L (2 mg/L average) were established for the pilot study configuration and hydraulic retention time (HRT). A plant/tilapia ratio of 2.5 ft²/lb was identified for the proposed facility's design.

The simplified design was assessed compatible with concrete block construction local to northern Uganda. Incorporating the following culturally familiar elements will facilitate technology adoption: utilize native fish (tilapia) and vegetable crops identified in community markets, replace commercially produced plant tank raft components with woven matting from locally available natural materials, and identify the unfamiliar proposed tank design with newly adopted raceway culture techniques at a well-known Ugandan national fishery institute.

A proposed facility preliminary design represents local materials, identified plant/tilapia ratio, minimum HRT, and simplified design components for tilapia densities ranging from 12 to 3 gal/lb. With the facility supplied by both rainwater and groundwater, corresponding water balances for 12 to 3 gal/lb densities ranged from a 9,735 gal/yr well supply demand to a 10,984 gal/yr rainwater surplus.

Table of Contents

List of Figures.....	vi
List of Tables	ix
Acknowledgements.....	x
Chapter 1 Introduction.....	1
1.1 Research Statement.....	2
Chapter 2 Literature Review.....	3
2.1 Aquaponics: Fish and Plant Relationship.....	3
2.2 Water Quality.....	4
2.3 Water Treatment Biological Processes.....	5
2.4 Tilapia Culturing.....	10
2.4.1 Species Nomenclature and Differentiation.....	10
2.4.2 Breeding and Growth.....	11
2.4.3 Feed.....	14
2.5 Plant Nutrition and Growth.....	15
2.6 Example Aquaponic Facilities.....	17
Chapter 3 Experimental Materials and Methods.....	24
3.1 Pilot Facility Materials.....	24
3.1.1 Fish Tank.....	26
3.1.2 Bio-Filter Tank.....	28
3.1.3 Plant Tank.....	28
3.1.4 Water Recirculation.....	29
3.1.5 Miscellaneous Components.....	30
3.2 Pilot Study Methodology.....	32
3.2.1 Water Quality.....	32
3.2.2 Facility Design/Configuration.....	33
3.2.3 Tilapia Feeding and Growth.....	34
3.3 Plant Selection and Observation.....	35
3.4 In-Field Site Investigation.....	35

Chapter 4 Results and Discussion.....	36
4.1 Primary Pilot Study.....	36
4.1.1 Water Quality Data Analysis	37
4.1.2 Plant/Tilapia Ratio	50
4.1.3 Proposed Facility Design	53
4.1.4 Proposed Facility Water Balance.....	54
4.1.5 Planting Selections.....	59
4.2 Secondary Pilot Study.....	62
4.2.1 Facility Start-Up: Water Quality Data Analysis	63
4.2.2 Water Treatment Biological Process Indicators	67
4.2.3 Proposed Facility Design	69
4.2.4 Planting Selections.....	72
4.3 In-Field Research.....	75
4.3.1 Introductory Manual and Preliminary Construction Drawings	76
4.3.2 Site Location and Water Supply	76
4.3.3 Locally Available Materials and Construction Methods	79
4.3.4 Energy Supply.....	80
4.3.5 Tilapia Feed	80
4.3.6 Familiar Vegetables and Greens	82
4.3.7 Local Aquaculture Facilities	83
Chapter 5 Conclusions	87
Chapter 6 Future Study	89
REFERENCES	90
Appendix A: Pilot Study Materials and Equipment List	93
Appendix B: Primary Pilot Study Data.....	95
Appendix C: Secondary Pilot Study Data.....	98
Appendix D: IACUC Protocol and Research Compliance Correspondence.....	102
Appendix E: Introductory Manual and Preliminary Construction Drawings	144
Appendix F: Revised Preliminary Construction Drawings	162
Appendix G: BAE Team Supplemental Analysis - Penman Method and Transpiration.....	172

List of Figures

Figure 2.1 Aquaponic Nitrogen Cycle	3
Figure 2.2 Biological Process Comparison: Domestic Wastewater vs. Aquaponic Water Treatment	9
Figure 2.3 Female Tilapia Incubating Fish Eggs	12
Figure 2.4 MSF Facility Layout	18
Figure 2.5 MSF Water Recirculation Components	19
Figure 2.6 MSF Planting Beds.....	20
Figure 2.7 UVI Commercial Raft System	21
Figure 2.8 UVI Commercial Raft System Schematic.....	21
Figure 3.1 Pilot Study Greenhouse	24
Figure 3.2 Pilot Study Existing Conditions	25
Figure 3.3 Pilot Study Start-Up	25
Figure 3.4 Aquaponic System Water Circulation.....	25
Figure 3.5 Pilot Study System Components	26
Figure 3.6 Pilot Study Tilapia Fingerlings Feeding.....	26
Figure 3.7 Fish Tank Bottom Inset.....	27
Figure 3.8 Bio-Filter Media	28
Figure 3.9 Stocking Plant Tanks at Start-Up	28
Figure 3.10 Plants Seeding	29
Figure 3.11 Plant Tank Raft Views	29
Figure 3.12 Pilot Study Water Pumps	29
Figure 3.13 Pilot Study Water Recirculation.....	30
Figure 3.14 Pilot Study HPS Lamps.....	30
Figure 3.15 Pilot Study Aeration Pump and Appurtenances	31
Figure 3.16 LaMotte Drop-Test Kit (pH test underway).....	32
Figure 3.17 YSI Professional Plus Handheld Meter and Probe Sensors	33
Figure 3.18 Pilot Study Scale	34
Figure 4.1 Primary Study Start-Up and Expanded Configurations	37

Figure 4.2 Primary Study Expanded System	38
Figure 4.3 Primary Study pH and TAN Levels	39
Figure 4.4 Primary Study DO Levels	39
Figure 4.5 Growing Tilapia	40
Figure 4.6 Primary Study Transplanted Broccoli, Cauliflower, Cabbage, and Lettuce	41
Figure 4.7 Primary Study Fish Tank Aeration.....	42
Figure 4.8 Primary Study Power Outage Tilapia Mortalities	43
Figure 4.9 Primary Study Bucket Heater and Galvanic Corrosion.....	45
Figure 4.10 Primary Study Expanded Configuration	47
Figure 4.11 Primary Study Temperature, DO, pH, and TAN System Tank Differentials	48
Figure 4.12 Pilot Study Transpiration.....	54
Figure 4.13 Primary Study Pea Pods on the Vine.....	59
Figure 4.14 Primary Study Harvested Plant Crops: Cucumbers, Tomatoes, Peas and Okra.....	60
Figure 4.15 Primary Study Cabbage, Broccoli, Cauliflower and Eggplant.....	61
Figure 4.16 Primary Study Under Nighttime Glow of HPS Lamps	62
Figure 4.17 Pilot Study System 1: Start-Up Nitrogen Cycle	63
Figure 4.18 Pilot Study System 2: Start-Up Nitrogen Cycle	64
Figure 4.19 Pilot Study System 3: Start-Up Nitrogen Cycle	64
Figure 4.20 Pilot Study System 4: Start-Up Nitrogen Cycle	65
Figure 4.21 Pilot Study Microorganisms.....	68
Figure 4.22 Pilot Study Bio-Filter Duckweed Growth.....	69
Figure 4.23 Water Circulation: Pilot Study Siphons vs. Proposed Facility Gravity Weir Flow ..	70
Figure 4.24 Breeding Control: Raised Bottom Fishnets.....	71
Figure 4.25 Newly Transplanted Okra and Cucumber Seedlings	72
Figure 4.26 Plant Seeding: Rockwool and Soil Media.....	73
Figure 4.27 Secondary Study Tomato Plants.....	73
Figure 4.28 Secondary Study Cucumber Plant Growth and Budding	74
Figure 4.29 Secondary Study Pea Pods on the Vine.....	74
Figure 4.30 Secondary Study Zucchini and Buttercup Squash Flower Blooms.....	75
Figure 4.31 Researcher Visiting Schoolchildren in Gulu, Uganda.....	75
Figure 4.32 Topographic Survey of Four Acre Proposed Facility Site	77

Figure 4.33 Proposed Facility Site View	77
Figure 4.34 School Under Construction on Proposed Facility Site	78
Figure 4.35 Typical Drilled Well in Gulu, Uganda	78
Figure 4.36 Proposed Facility Tank Wall and Slab Detail	79
Figure 4.37 Failed Aquaculture Facility No. 1 in Gulu, Uganda.....	83
Figure 4.38 Failed Aquaculture Facility No. 2 in Gulu, Uganda.....	84
Figure 4.39 Struggling Aquaculture Operation near Gulu, Uganda	85
Figure 4.40 Kajjansi Aquaculture Facility Under Construction	86

List of Tables

Table 2.1 Water Quality Parameter Ranges and Lethal Limits	4
Table 2.2 Tilapia Breeding Schedule.....	13
Table 2.3 Tilapia Daily Feed Allowance	14
Table 2.4 Plant Nutrients	16
Table 2.5 Aquaponic System Designs	17
Table 2.6 UVI Commercial Raft System Components.....	22
Table 3.1 Water Quality Parameter Ranges and Lethal Limits	32
Table 4.1 Primary Study Plant Area and Tilapia Stocking.....	41
Table 4.2 Water Treatment HRT: Pilot Study vs. Proposed Facility	49
Table 4.3 Primary Study Plant/Tilapia Ratios	51
Table 4.4 Proposed Facility Sizing for Various Tilapia Densities (3 to 12 gal/lb).....	54
Table 4.5 Proposed Facility: Total Water Usage for Various Tilapia Densities (12 to 3 gal/lb) .	57
Table 4.6 Proposed Facility: Required Well Supply for 12 gal/lb Tilapia Density Facility.....	58
Table 4.7 Proposed Facility: Required Well Supply for 8 gal/lb Tilapia Density Facility.....	58
Table 4.8 Proposed Facility: Required Well Supply for 5 gal/lb Tilapia Density Facility.....	58
Table 4.9 Proposed Facility: Required Well Supply for 3 gal/lb Tilapia Density Facility.....	59
Table 4.10 Proposed Facility: Yearly Water Balance (12 to 3 gal/lb Tilapia Densities).....	59
Table 4.11 Tilapia Fingerling Start-Up Maximum Density Limit.....	67
Table 4.12 Secondary Study: Simplified Design Facility Components	69
Table 4.13 Local Feed Composition for (a) 60%, (b) 40% , and (c) 30% Protein Content.....	81
Table 4.14 Savings Comparison: Purchased Feed vs. Self-Produced	81
Table 4.15 Proposed Facility Market Tilapia Quantities: Purchased Feed vs. Self-Produced	82
Table 5.1 Research Objectives and Results	87

Acknowledgements

Thank you to Dr. Steven Starrett and the Civil Engineering Department for providing the opportunity to pursue this research project.

Chapter 1 Introduction

Aquaponics is a recirculating agricultural system comprising both aquaculture (fish farming) and hydroponics (growing plants in water without soil). A single source of protein (fish) and nutrients/vitamins (vegetables), the recirculating system utilizes substantially less water than conventional single-use methods. With vast potential as a renewable food source, development of a technologically simplified commercial-scale system is a realistic solution for many impoverished societies in developing nations.

This study provides original research and development of an aquaponic facility to be implemented in rural northern Uganda. With current aquaponic technology ranging from backyard hobbyist to technologically advanced commercial production, focus is centered on development of a technologically simplified commercial-scale system.

Research was completed for Two Fish Foundation, Inc., a 501(c)(3) non-profit organization dedicated to developing economically and culturally feasible aquaponic agricultural facilities for the benefit of impoverished nation communities. Two Fish is in partnership with a U.S.-founded/Africa-based organization in Gulu, Uganda that will assume ownership of the first facility. Among their many responsibilities, the partnering organization operates a primary school for approximately 400 schoolchildren. The first phase of the proposed facility is designed to provide one protein meal a month for the 400 schoolchildren, supplemented with more frequent vegetable harvests.

Similar to many world regions, multiple impoverished rural communities exist in northern Uganda today. The vicious cycle of war, insufficient education, and lack of resources holds communities in a permanent state of malnutrition. UNICEF (2011) published malnutrition statistics for Uganda, based on World Health Organization (WHO) data, indicate: 38% of children under five are moderately to severely stunted; twelve percent of children under five are classified as moderately underweight, with 4% severely underweight. These statistics encompass all of Uganda, with rural northern communities experiencing greater malnourishment percentages.

Culturally acceptable aquaponic facilities are a realistic solution for impoverished and malnourished communities. While technology acceptance, identification of ambitious and

energetic local talent, and adequate personnel training are the critical steps to facility longevity, an initial assessment of technical feasibility is needed.

1.1 Research Statement

This study develops a simplified commercial-scale aquaponic facility for implementation in a rural northern Ugandan community. Research objectives were to: (1) identify simplified commercial-scale system design components, (2) establish a water quality baseline, (3) identify plant/tilapia production ratios, (4) identify construction materials available in northern Uganda, (5) integrate culturally familiar elements, (6) complete preliminary facility design, and (7) calculate facility water balance. A pilot study and in-country research lays the groundwork for proposed facility construction and start-up in northern Uganda.

Chapter 2 Literature Review

Water quality is critical to the success of an aquaponic system. Quantitative parameters must fall within healthy ranges to maintain the synergistic relationship between fish and plants. An understanding of tilapia culturing, plant nutrition, and common water treatment biological processes is crucial.

2.1 Aquaponics: Fish and Plant Relationship

In an aquaponic system, the fish provide nutrients (via waste) for plant growth, and in turn the plants uptake constituents toxic to the fish. The result is a cleaned recirculating water flow back to the fish tank.

A more detailed explanation is that fish excrete ammonia from their gills, and decomposition of excess feed and fish waste also results in ammonia production. Bacteria facilitate nitrification, or the conversion of ammonia to nitrite, and of nitrite to nitrate. With ammonia and nitrite toxic to fish, nitrification results in conversion to nitrate, a non-toxic nitrogen form that is favored by plants for nutrient uptake. Figure 2.1 illustrates the aquaponic nitrogen cycle.

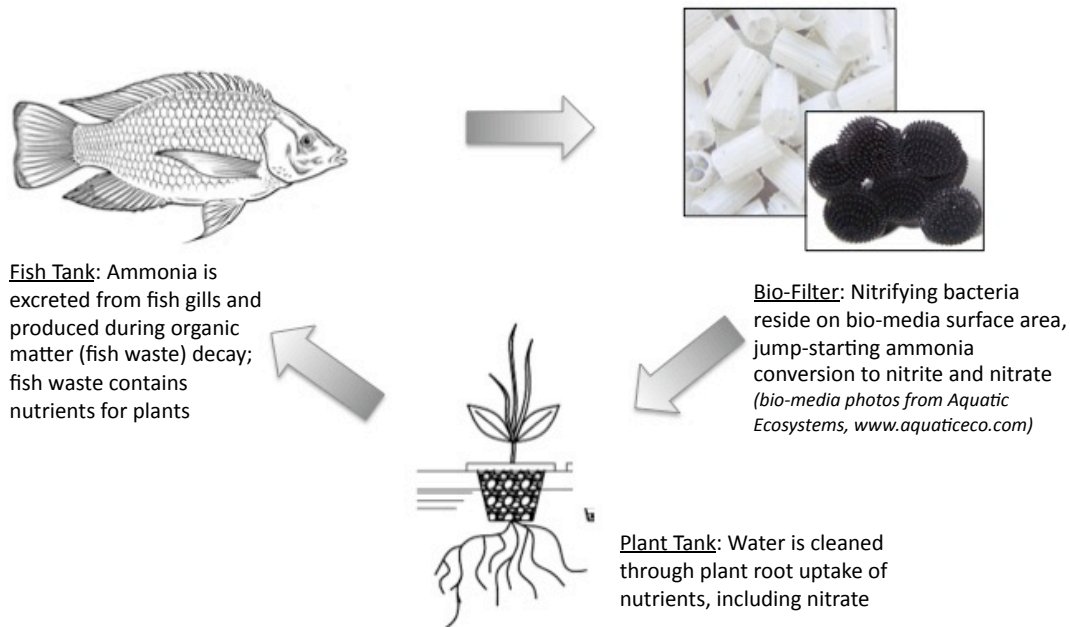

Figure 2.1 Aquaponic Nitrogen Cycle

Although the nitrogen cycle and corresponding concentrations are key to a successful aquaponic system, other water quality parameters also require attention. With differing optimum pH and temperature ranges for plants and fish, a compromise is made when establishing aquaponic system operating parameters.

2.2 Water Quality

Tilapia are known as an extremely hardy fish, capable of surviving in deteriorated water quality conditions. Table 2.1, identifying key water quality parameter healthy growth ranges and lethal conditions, is compiled from multiple sources (Aquatic EcoSystems, 2011; DeLong *et. al.*, 2009; Gorder, 2000; Nelson and Pade, 2008; Popma and Masser, 1999; Timmons and Ebeling, 2007).

**Table 2.1 Water Quality
Parameter Ranges and
Lethal Limits**

PARAMETER	UNITS	HEALTHY RANGE	LETHAL CONDITIONS LIMIT
Temperature, T	°F	75 to 85	45 to 50
pH	----	6 to 8	4.5 to 5.0
Dissolved Oxygen, DO	mg/L	> 3	0.5
TAN (NH ₄ ⁺ + NH ₃)	mg/L	< 3	----
Ammonia, NH ₃	mg/L	< 0.06	2 to 3
Nitrite, NO ₂ ⁻	mg/L	< 1	5.00
Nitrate, NO ₃ ⁻	mg/L	< 500	----

Actual tolerance to poor water quality is largely dependent on rate of water quality deterioration. Tilapia can endure more extreme conditions if acclimation occurs with a gradual transition. It is never advantageous to rear tilapia at or near lethal conditions, as feeding and growth ceases with water quality deterioration. The benefit to high tolerance is simply reduced mortalities in the instance of a system malfunction.

Nitrogen limits warrant further discussion. Total ammonia nitrogen (TAN) encompasses both unionized ammonia (NH₃) and ammonium ions (NH₄⁺). TAN is sometimes referred to as ammonia, while still including both the unionized and ionized forms. NH₃ is sometimes referred to as ‘free ammonia’ to denote the unionized portion. NH₄⁺ is considered non-toxic to fish, while NH₃ is toxic due to its ability to move across gill cell membranes and interfere with fish respiration. The fraction of each form is dependent on water temperature and pH. If environmental factors result in temperature or pH variations, the corresponding

NH_4^+ and NH_3 fractions will shift accordingly. Multiple references provide freshwater NH_3 percentages based on temperature and pH. Free ammonia percentage data published by Timmons and Ebeling (2007) was used for this report and data analysis.

The following example illustrates why it is important to establish TAN limits, even if toxic NH_3 fractions are typically low or non-existent: Assume a system typically operates at 25°C and a pH of 6.0. If the TAN is at the upper limit of 3 mg/L, the NH_3 concentration is 0.1%. This equates to a free ammonia concentration of 0.003 mg/L, which is below the 0.06 mg/L limit. Assume extenuating situations require a large system water exchange with groundwater having a pH of 7.5. The fraction of free ammonia is 1.8% in these conditions. The resulting 0.054 mg/L NH_3 concentration is close to the upper 0.06 mg/L limit. If a water temperature increase to 30°C (86°F) subsequently occurs, the free ammonia concentration is then 2.5%. The resulting 0.075 mg/L NH_3 concentration exceeds the healthy limit.

Nitrifying bacteria establishment is critical to maintenance of healthy nitrogen levels. Bacteria facilitate the conversion of TAN to nitrite (NO_2^-), and of NO_2^- to nitrate (NO_3^-), the preferred plant uptake form. Aquaponic system operators report a wide range of nitrogen cycle durations. References cite anywhere from a couple weeks to three months for bacteria to establish (Friend and Mann, 2009; Nelson and Pade, 2008). Section 2.3 discusses biological processes in detail. It is important to note that both NH_3 and NO_2^- is toxic to fish. During bacteria establishment, a reduced waste load (i.e. reduced fish density) is needed to mitigate fish poisoning and mortality.

2.3 Water Treatment Biological Processes

An aquaponic system accomplishes waste removal in a manner identical to the aerobic component of a typical wastewater treatment plant's activated sludge process. Comparison between the two operations is made because existing biological process documentation is extensive and detailed for wastewater treatment applications. While actual waste loads vary between aquaponic and domestic wastewater, the biological processes do not.

Waste is quantifiable in terms of biochemical oxygen demand (BOD). BOD represents the amount of oxygen bacteria require to oxidize, or breakdown, waste constituents (Masters and Ela, 2008). BOD is further categorized into carbonaceous biochemical oxygen demand (cBOD) and nitrogenous biochemical oxygen demand (nBOD). cBOD corresponds

to the oxidation of waste organic matter, compounds composed of a combination of carbon, oxygen, hydrogen, and sometimes nitrogen and sulfur (Metcalf & Eddy, 2003). nBOD corresponds to the amount of oxygen required for nitrification, or the conversion of inorganic ammonia and nitrite to nitrate. In waste decomposition, cBOD degradation of organic-nitrogen compounds results in the formation of additional nBOD. Protein is a common example of an organic-nitrogen compound. During degradation, ammonium ions are a product of the released and dissociated amino acids (Gerardi, 2002).

Excluding endogenous decay, the following equation represents the bacterial decomposition (oxidation and cell synthesis) of organic matter during waste treatment (Metcalf & Eddy, 2003):

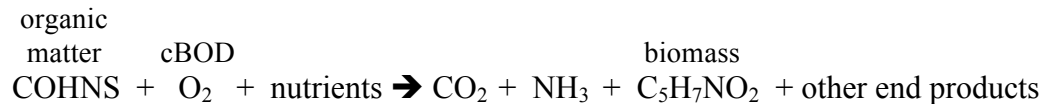

Similarly, the following equation represents the bacterial decomposition (oxidation and cell synthesis) of inorganic nitrogen ions (Metcalf & Eddy, 2003):

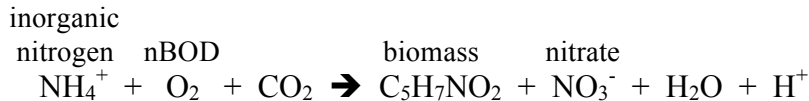

Bacteria classification is based on carbon and energy sources. Chemoheterotrophic bacteria are the microorganisms responsible for cBOD degradation, and chemoautotrophs participate in nBOD degradation. *Chemo-* indicates that energy is obtained from chemical reactions. cBOD bacteria obtains energy as it breaks chemical bonds in organic matter, and nBOD bacteria obtains energy as it breaks chemical bonds during inorganic nitrogen degradation. While a portion of energy obtained is utilized for oxidation, a portion is used for cell synthesis (i.e. cell, or biomass creation). This explains why biomass is a product for both reactions. In both aquaponic and domestic wastewater processes, the biomass product is realized as settled particles, or sludge, on tank bottoms. (Gerardi, 2002; Metcalf & Eddy, 2003)

Heterotrophic indicates that bacteria obtain carbon from organic material, whereas *autotrophic* bacteria obtain carbon from carbon dioxide. During chemoheterotrophic bacteria activity, cBOD quantity is decreased as organic matter is used both as an energy and carbon

source. During chemoautotrophic bacteria activity, nBOD quantity is reduced as energy is obtained, and alkalinity (and subsequently pH) reduces as bicarbonate ions are used as a carbon source (CO₂ forms carbonic acid when dissolved in water, which then dissociates into hydrogen and bicarbonate ions). (Gerardi, 2002; Metcalf & Eddy, 2003)

With two distinct chemoautotrophic bacteria playing key roles in nitrification, it is necessary to identify the two oxidation reactions (not including cell synthesis) that occur. The following two equations indicate the relevant bacteria for ammonia (ammonium ion) conversion to nitrite, and from nitrite to nitrate (Metcalf & Eddy, 2003):

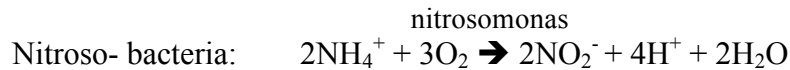

Several bacteria, identifiable with the prefix *nitroso-*, are known to nitrify ammonia to nitrite. *Nitrosomonas* is the most prevalent. Similarly, bacteria that nitrify nitrite to nitrate are identified with the prefix *nitro-*, with *nitrobacter* predominant. Much research has been conducted to determine optimum nitrification temperature, pH, and dissolved oxygen (DO) levels. The optimum pH range is cited as 7.2 to 8.0, with any nitrification occurring in water with pH < 5.0 attributed to microorganisms other than nitrifying bacteria. Optimal temperature range is 28° to 32°C, with nitrification ceasing at temperatures below 5°C or above 45°C. Finally, DO levels of 2 to 3 mg/L are required for uninhibited nitrification. Maximum nitrification occurs around 3 mg/L, with no recognized improvement with additional aeration. Nitrification ceases at DO levels less than 0.5 mg/L. It should be noted that, besides temperature, pH, and low dissolved oxygen, cBOD is inhibitive to nitrification. In domestic wastewater treatment, cBOD degradation occurs first, with nBOD degradation possible once toxic forms of cBOD are degraded. This is reported to occur when total cBOD levels are below approximately 40 to 50 mg/L. (Gerardi, 2002; Metcalf & Eddy, 2003)

Discussed in Section 2.2.4, aquaponic facility start-up is contingent upon establishment of both forms of nitrifying (chemoautotrophic) bacteria, as well as the required chemoheterotrophic bacteria. In domestic wastewater treatment, soil (nitrifying) and water bacteria enter plants through both sewer infrastructure inflow and infiltration and fecal

bacteria (Gerardi, 2002). In an aquaponic system, bacteria will be introduced through fish waste and transplanted seedling roots.

Detailed by Gerardi (2002), biological and chemical indicators of nitrification exist other than ammonium, nitrite, and nitrate ion concentration trends. The following two are selected as directly applicable to the aquaponic pilot study and proposed facility:

1. Duckweed and algal growth in the clarifier (bio-filter in aquaponic system):
Duckweed is known to be the smallest flowering plant. It has a rapid reproduction rate in the presence of desirable nutrients (typically nitrogen or phosphorus) and floats in dense flocks on the top of the water (Iqbal, 1999). Refer to Section 4.1.4 for a photograph of pilot study duckweed growth.
2. Decrease in mixed liquor (all tanks in aquaponic system) alkalinity/pH: Referring to the equation provided for oxidation and cell synthesis during nitrification, note that alkalinity is on the reactant side (CO_2 forms carbonic acid when dissolved in water, which then dissociates into hydrogen and bicarbonate ions), and hydrogen ions (H^+) is a product. System bicarbonate alkalinity will reduce during nitrification if not periodically resupplied. As pH is a logarithmic measure of hydrogen ions, an increase in concentration during nitrification will result in a decrease in pH. Note that nitrification is not the sole possible cause of reduced alkalinity and pH, but also cannot be discarded as the main contributing factor.

Figure 2.2 provides a visual correlation between aquaponic and domestic wastewater treatment, and a summary of the discussed concepts. Part (a) of the figure represents a common activated sludge configuration and part (b) denotes the pilot study and proposed aquaponic facility. Because the activated sludge process requires an additional step to achieve nitrogen removal, only the aeration/clarifier tanks are highlighted as stages similar to aquaponic water treatment.

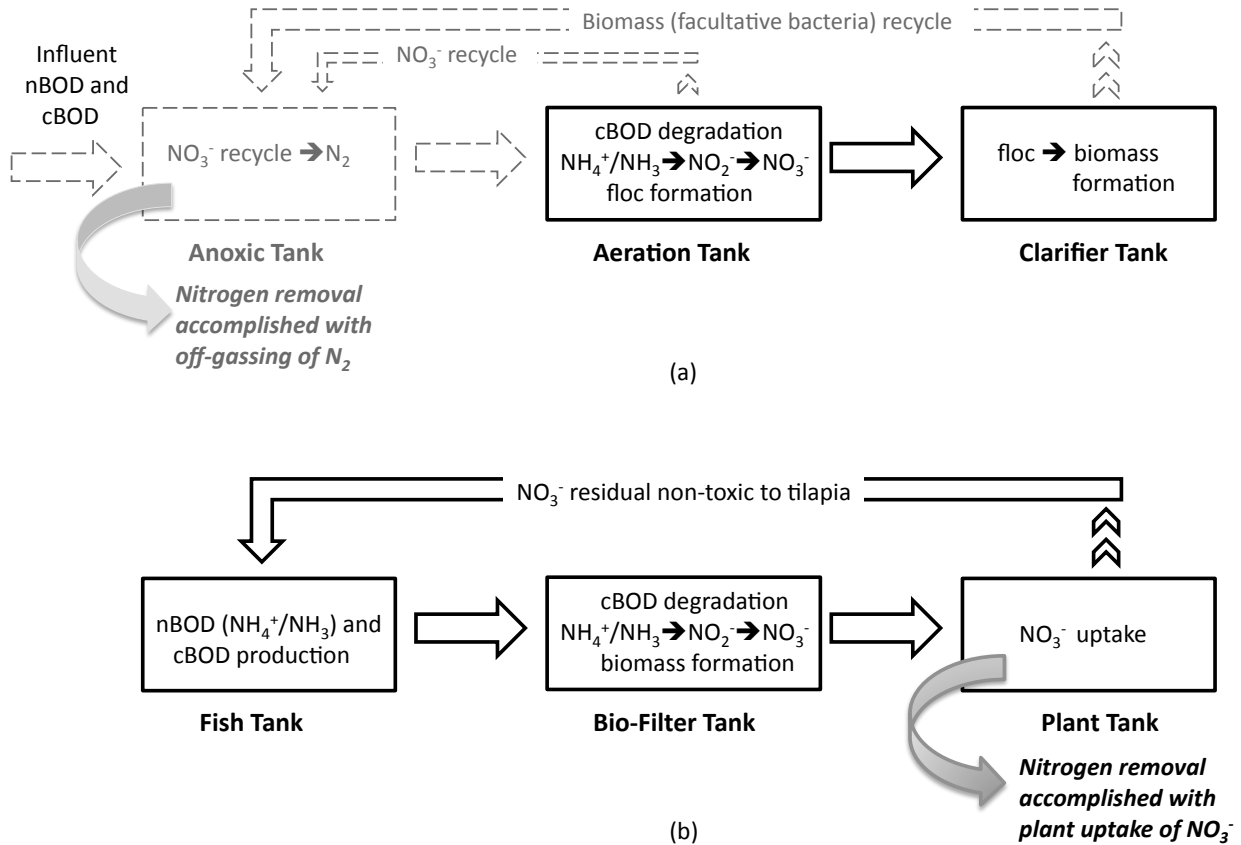

Figure 2.2 Biological Process Comparison: Domestic Wastewater vs. Aquaponic Water Treatment

Sewer system infrastructure provides BOD influent for domestic wastewater treatment, while BOD is produced from tilapia waste directly in the fish tank. The wastewater aeration/clarifier tanks and aquaponic bio-filter tank are comparable stages of cBOD and nBOD oxidation and biomass formation. cBOD and nBOD degradation is accomplished with chemoheterotrophic and chemoautotrophic (nitrifying) bacteria, respectively. Biomass removal is required in both systems once particles settle.

In the aquaponic system, nitrogen removal is accomplished in the subsequent plant tank. Plants uptake nitrogen, in the preferred form of NO_3^- , as a macro-nutrient and essential element for plant growth. Any residual nitrate recirculated to the fish tank is in a nitrogen form non-toxic to tilapia (Timmons and Ebeling, 2007).

Figure 2.2 is theoretical in the sense that cBOD and nBOD degradation is not limited to the specific process unit identified. In an aquaponic system, bacteria populations exist in all tanks. For example, nitrifying bacteria will not only establish themselves in the bio-filter,

but also on the polystyrene foam and plant roots in the plant tank. Nitrification will occur in the bio-filter tank, but will continue to occur in the plant tank.

In domestic wastewater treatment, an additional step of denitrification is required for nitrogen removal. NO_3^- , formed in the aeration tank, is recycled to an anoxic tank. The term anoxic indicates anaerobic conditions where nitrite and nitrate are used in lieu of oxygen for respiration during fresh influent organic matter decomposition (Metcalf & Eddy, 2003). NO_3^- is converted to nitrogen gas, N_2 . N_2 is insoluble and escapes to the atmosphere upon formation (Gerardi, 2002). The following denitrification equation is provided simply for a more complete understanding of both processes (Metcalf & Eddy, 2003):

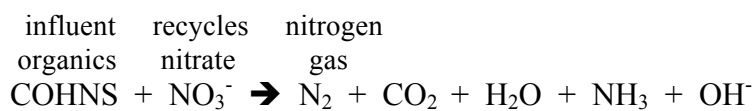

2.4 Tilapia Culturing

Tilapia belong to the cichlid family, originating from Africa and Palestine (George, 2006). Tilapia hardiness and tolerance for less than ideal water quality, breeding ease, relative rapid growth, and meat taste and texture make them a leading cultured fish throughout the world.

2.4.1 Species Nomenclature and Differentiation

The two tilapia species of concern are Nile (*Oreochromis nilotica*) and blue (*Oreochromis aureus*). Although the majority of literature now refers to Nile and blue maternal mouth-brooding tilapia as the *Oreochromis* genera, some texts continue to reference alternate nomenclature dependent on country and officiating agencies. An understanding of the various classifications allows a reader to understand the origin and relationship between nomenclatures, as well as tilapia breeding habits.

The following summary is adapted from George (2006): Originally all classified under the genera *Tilapia*, a division occurred in 1973. Tilapia were divided into two genera, *Tilapia* and *Sarotherodon*, based on breeding habits. The *Tilapia* genera represented the substrate breeders, who incubate their eggs in a nest. The *Sarotherodon* genera represented the mouth brooders, who incubate eggs in their mouths. A nomenclature change subsequently occurred in 1982, when the *Sarotherodon* genera was replaced with *Sarotherodon* and

Oreochromis. The *Sarotherodon* classification was retained for paternal mouth brooders, while the *Oreochromis* classification indicated maternal mouth brooders. Note that Nile and blue tilapia are referenced by their common names for the remainder of this report.

Although both the Nile and blue tilapia are maternal mouth brooders, they differ slightly in appearance, temperature tolerance and growth rate. Appearance-wise, caudal (tail) fin banding is the most visually reliable method of determining species. Nile tilapia typically have strong vertical bands on their tail fins, while broken/interrupted bands characterize the blue tilapia. Note that visual characteristics can be misleading due to both natural and intentional genetic crossbreeding between species. (Popma and Masser, 1999)

Optimal tilapia growth occurs in water temperatures ranging from 29-31°C (85-88°F), with tolerance ranging from approximately 15-32°C (60-90°F). Note that feeding decreases with less than optimal temperatures, and ceases altogether in the lower tolerance ranges. A concern when culturing in colder regions, lethal temperatures are identified as 10-11°C (50-52°F) for Nile tilapia, and 7-9°C (45-48°F) for the slightly more cold-tolerant blue tilapia. (Popma and Masser, 1999; Gorder, 2000; DeLong *et al.*, 2009)

Although quantitative comparisons are not provided, multiple texts provide the generalization that Nile tilapia demonstrate a faster growth rate than blue tilapia (McGinty and Rakocy, 1989; Friend and Mann, 2009; Gorder, 2000). Hybrid species, created for improved characteristics as well as male-dominant numbers, are reported to have increased growth over Nile tilapia (Quiming and Yi, unknown; DeLong *et al.*, 2009).

Based on fingerling availability and slightly increased cold tolerance, blue tilapia was used for the pilot study. The blue tilapia is native to Northern Africa, and is not common to Uganda. Based on geographic location and in-field research, Nile tilapia will be farmed in the proposed facility.

2.4.2 Breeding and Growth

Tilapia are prolific breeders. As such, an understanding of breeding methods is critical to both new stock availability and population control in grow-out tanks. Maternal mouth brooders, Nile and blue tilapia follow the same breeding patterns. In nature, the male fish excavates a nest in the river bottom. Once a female fish is attracted, the actual egg-laying and retrieval for mouth incubation process occurs quickly. The female lays eggs in the nest, with

the male directly in train to release sperm on the egg deposit. Following male fertilization, the female immediately collects the eggs into her mouth to begin the incubation process. The spawning ritual is repeated several times. (Gorder, 2000) Total egg quantity is relatable to fish size. Chapman (2009) cites a total of one to four eggs laid per gram of female body weight. Figure 2.3 depicts a female blue tilapia with eggs in her mouth. During incubation, the female continuously rotates the eggs in her mouth. This allows for continued fertilization of eggs initially (Gorder, 2000), as well as proper formation of the yolk sak during hatchling development.



Figure 2.3 Female Tilapia Incubating Fish Eggs

Depending on the environment, Nile and blue tilapia reach spawning age anywhere from three or four months (Gorder, 2000) up to 10 or 12 months in less ideal water quality and feed conditions (Popma and Masser, 1999). Chapman (2009) indicates that optimal conditions can result in sexual maturation as young as two to three months old. Mature females spawn every four to six weeks (Nelson and Pade, 2008).

Uncontrolled breeding results in high fish densities with stunted populations. The ideal grow-out fish population is all male, considering the slower growth associated with female egg development. There are several known techniques for optimizing fish size and growth rate (Popma and Masser, 1999; DeLong *et. al.*, 2009; Gorder, 2000).

1. Hormone Treatments: Female sex reversal is achieved by exposing all fry to male hormones. The hormones are typically administered in feed.
2. Hybridization: Several known combinations result in near all-male populations, such as cross-breeding a female Nile tilapia with a male blue tilapia
3. Hand Sexing: Fish are periodically inspected and sexed according to the visual appearance of their genitalia. Females are discarded, allowing feed and other resources to be utilized by faster growing males. This method is time consuming and not considered reliable due to visual identification error.
4. Pond cage farming: Eggs fall through the cage mesh, preventing retrieval for mouth incubation

5. Polyculture with a predator fish: Piscivorous fish that prey on tilapia control populations

Hormone treatments, hand sexing, and polyculture are not considered viable options for the proposed facility. Without definitive knowledge on the in-country fingerling market, it cannot be assumed that hybrid males will be available. As such, the pilot study employed a variation on the pond cage farming technique. Nets, supported on tank rims with PVC piping, housed fish. Clearance between net and tank bottom allowed eggs to fall through and remain on the tank floor for removal. Refer to Chapter 3 and 4 for photographs and additional discussion.

A wide range of grow-out periods is advertised in literature. With environmental conditions the key factor, similar growth rates will not be encountered in all rearing systems. A reasonable representation of variability in egg to harvest growth time is provided in Chapman’s (2009) range of six to 12 months. A typical harvest weight of one to one-half pounds is cited. Note that harvest weights vary widely depending on the end consumer.

Although tilapia breeding was not included in the pilot study, an initial breeding schedule (Table 2.2) was developed and discussed with the tilapia supplier, Rex Rains of R&S Ranch, LLC. A 12 month grow-out period was conservatively selected, with fry survival rates, stocking densities, and growth stage durations adapted in part from Chapman (2009) and Matousek (2004). Staggered harvests result in protein availability throughout the year.

12 Mos. Growth Period (assumed 1.25 to 1.5 lb harvest weight), with harvesting completed every 3 months based on 2 month fry and fingerling stages and 8 mo. grow-out)

Grow-Out Tank Size	No. Tanks / Total Gallons	Total No. Fish (8 gal/lb) per grow-out tank (assuming 1.25lb)	Total Number Fry Req'd (assuming 50% survival rate for fry)	Hatchery Tanks Total Volume for Fry (assuming avg size of 5g=.01lbs, and 50 gal/lb)	Fingerling Tanks Total Volume (assuming avg size of 30g=.07lbs, and 15 gal/lb)	Number of Female Broodstock (assuming 200 fry per female)	Female Broodstock Tank (assuming max. weight of 1.5lbs, 15 gal/lb, and vol. doubled for back-up broodstock)	Number of Males (assuming 1:3 ratio)	Male Broodstock Tank (assuming max. weight of 1.5lbs, 15 gal/lb, and vol. doubled for back-up broodstock)	Breeding Tank (assuming max. 1.5lb/fish and 15 gal/lb, double to ensure adequate volume)	No. of Breeding Cycles / Cycle Duration (assuming fish spend 2 mos. in each stage tank)	Market-size Fish per Year	Total Marketable Fish Weight per year (assuming 1.25-1.50lb avg. wt.)
12.67' x 12' x 2.67'	4 / 12,000 gal	300	450	225 gallons	473 gallons	3	135 gallons	1	50 gallons	100 gallons	4 cycles / 3 months ea (note: only 5 wks req'd max)	1200	1500-1800 lbs
5 gal/lb density:		480	720	360 gallons	756 gallons	4	180 gallons	1	50 gallons	115 gallons	"	1920	2400-2880 lbs
3 gal/lb density:		798	1197	600 gallons	840 gallons	6	270 gallons	2	100 gallons	180 gallons	"	3192	3990-4788 lbs

Table 2.2 Tilapia Breeding Schedule

Mr. Rains provided feedback that the preliminary plan, ratios, and factors considered appeared reasonable. Multiple related topics, such as fish start-up densities, feeding, fish transport, tank algal control, filtration systems, and commercial aquaculture densities were also discussed during the meeting. Everything proved very useful in the planning and start-up of the pilot study. The basic ratios in Table 2.2 will be applied to final construction tank sizes and planned harvest weights.

2.4.3 Feed

Typically omnivorous, in nature tilapia feed on algae, bacteria, plankton, larval fish, detritus and decomposing organic matter (Popma and Masser, 1999; Riche and Garling, 2003). In an intensive culture system where energy spent foraging for food is minimized, maximum growth is further achieved by providing a high nutrient diet. Tilapia require a diet with protein (amino acids), carbohydrates, vitamins, minerals, and fats. Protein content is dependent on tilapia age. Some sources cite 32 to 36 percent protein for fish weighing up to 30 to 40 grams (Popma and Masser, 1999; Riche and Garling, 2003). Others recommend 45 to 50 percent protein content for fry and fingerlings (Matousek, 2004; Purina Mills, 2011). The majority of sources recommend a 28 to 32 percent protein content for larger fish. Refer to Section 4.3.5 for a detailed account of the proposed facility’s tilapia feed content.

Daily feed quantity is a function of tilapia size. Recommended daily allowance (as a percentage of fish weight) varies somewhat between sources. Table 2.3 is an adaptation of daily feed allowance ranges from three references (DeLong *et. al.*, 2009; McGinty and Rakocy, 1989; Riche and Garling, 2003). Ideal environmental conditions are assumed.

Table 2.3 Tilapia Daily Feed Allowance

FISH WEIGHT (GRAMS)	DAILY FEED (% OF FISH WEIGHT)
0-5	30 to 10
5-20	10 to 4
20-75	4 to 3
75-100	3 to 2.5
100+	2.5 to 1.5

The following summarizes basic aquaculture feeding methodology (Arthur, 2010; Matousek, 2004; Timmons and Ebeling, 2007): Feeding can be *ad libitum* (feed not weighed, but introduced into system until fish stop feeding), or the daily feed allowance (% of fish weight) can be divided by the number of times per day the grower feeds the fish. Fry and

fingerlings should be fed a minimum of three to five times per day, with larger fish fed no less than two to three times a day. Frequent feedings facilitate efficient feed conversion. An optimum feeding interval is every four to five hours. When feeding, pellets should be distributed over the water surface as much as possible. Point feeding reduces fish population percentage with access to pellets at any point in time. Feed provided should equal the amount consumed within 15 to 20 minutes. Any feed remaining after the allotted time should be removed. It is important to not overfeed. When fed in two to three hour intervals, feed in excess of stomach capacity bypasses into the intestine and is directly wasted (Riche and Garling, 2003). Feeding should be reduced, or eliminated altogether, before transport, during fish stress, high temperatures, low oxygen levels, or otherwise poor water quality.

Fish feed is often one of the highest operating costs in an aquaculture operation, and will be the highest operating cost for the proposed aquaponic facility. When compiling an operating strategy and budget, the feed conversion ratio (FCR) is a critical planning value. The FCR is the ratio of the 'dry weight of feed to wet weight of animal gain' (Timmons and Ebeling, 2007). For tilapia, a variety of FCR values are advertised. Again, environmental conditions and culture system type play a role. The FCR also varies during grow-out stages. Lower FCR's are typically experienced in juvenile fish stages characterized by rapid growth. Timmons and Ebeling (2007) identify an FCR of 0.7 to 0.9 for tilapia less than 100 grams, and 1.2 to 1.3 for larger tilapia. Other sources cite FCRs ranging from 1.3 to 1.8 (DeLong *et. al.*, 2009; McGinty and Rakocy, 1989; Rakocy *et. al.*, 2006). An overall FCR value of 1.5 is selected for proposed facility planning. Adjustments will be made as needed during proposed facility implementation.

2.5 Plant Nutrition and Growth

A large variety of plants and vegetables are successfully grown in aquaponic systems using the same technology employed in the more familiar hydroponic system. A plant grown hydroponically is not grown in soil, but rather has its roots constantly submerged in circulating nutrient enriched water. The grower periodically adds nutrient solutions to the system in order to maintain healthy levels. In an aquaponic system, nutrients are naturally provided from fish waste and the resulting biological processes. The outcome is a system

from which both protein (fish) and vitamin and nutrient rich vegetables can be harvested, without the need to add commercially concocted nutrient solutions.

Outlined by Roberto (2005), Table 2.4 summarizes macro-nutrients (required in large amounts) and micro-nutrients (required in small amounts) required for plant growth. ‘Plant Use’ information is directly cited from the referenced text. Nutrient availability varies with water pH. The optimum growing pH of plants varies, typically falling within 5.5 to 7.5 (Friend and Mann, 2009; Nelson and Pade, 2008; Roberto, 2005).

CATEGORY	NUTRIENT	PLANT USE (DIRECTLY CITED FROM ROBERTO, 2005)
Macro-Nutrients	Nitrogen	Necessary for the formation of amino acids, coenzymes, and chlorophyll
	Phosphorus	Necessary for production of sugars, phosphate and ATP (energy), flower and fruit production, root growth
	Potassium	Required for protein synthesis, plant hardiness, root growth, and the manufacture of sugar and starch
Micro-Nutrients	Calcium	Required for cell wall formation
	Sulfur	Protein synthesis, water uptake, fruiting and seeding, a natural fungicide
	Iron	Chlorophyll formation, helps in respiration of sugars to provide growth energy
	Boron	Necessary for the formation of cell walls in combination with calcium
	Manganese	A catalyst in the growth process, formation of oxygen in photosynthesis
	Zinc	Utilized in chlorophyll production, respiration and nitrogen metabolism
	Molybdenum	Nitrogen metabolism and fixation
	Copper	Activates enzymes, necessary for photosynthesis and respiration

Table 2.4 Plant Nutrients

There are three common types of aquaponic plant component designs, all acquired from the hydroponics industry (Nelson and Pade, 2008): raft, nutrient film technique (NFT), and media-filled bed. Adapted from information provided by both Nelson and Pade (2008) and Roberto (2005), Table 2.5 summarizes critical system characteristics for each design. The raft design is selected for the pilot study and proposed facility based on production level and plant type suitability.

SYSTEM	DESCRIPTION	PRODUCTION LEVEL	PLANT TYPES	DISADVANTAGES	ADVANTAGES
Raft	Plants grow in web pots situated in polystyrene foam sheets floating in water-filled tanks	Commercial	All	Daily/periodic cleaning	Highly productive; large water volume provides buffer
NFT	Plants grow in long narrow channels through which water is circulated (i.e. PVC piping with holes for plants)	Commercial	Herbs and Lettuce	Daily/period cleaning; plant tubing/channels can clog	Highly productive; highest ratio of plants to fish
Media-Filled Bed	Plants grow in media (gravel, perlite, sand, etc.) that is periodically flooded with fish tank water	Small-scale / home hobbyist	All	Lowest production; system disruption for complete media bed cleaning	Least expensive to construct

Table 2.5 Aquaponic System Designs

With the exception of root crops (that would rot submerged in water), a variety of plants are reported successfully grown in aquaponic systems. Greens (lettuce, watercress, cabbage, spinach, kale, chard), herbs (mint, basil, chives, sage), tomatoes, peas, beans, okra, zucchini, cucumber, cauliflower, broccoli, peppers, and strawberries have been cultured successfully (Arthur, 2010; Friend and Mann, 2009; Nelson and Pade, 2008). Although not researched aquaponically, Riotte (1998) identifies soil culture companion planting that may prove beneficial in a hydroponic setting. For example, beans complement cauliflower, cucumbers, and cabbages, but are inhibited by chives.

Raft system plant spacing is dependent on mature dimensions of individual plants. Recommended spacing varies from four inches (i.e. chives) to six and one-half inches (i.e. basil, lettuce) to two feet (i.e. tomatoes). In all cases, adequate sunlight must reach the plants for growth. Improper lighting is evident by ‘stretching’, where young plants grow tall and spindly in an attempt to attain more sunlight exposure (Nelson and Pade, 2008). If seedlings are spaced close together upon transplant, re-spacing is required as plants mature.

2.6 Example Aquaponic Facilities

The starting model for the pilot study’s simplified design was the Morning Star Fishermen (MSF) Training Facility in Dade City, Florida. Rehabilitated from what was once

a tropical fishery, the aquaponic raft system consists of multiple concrete block tanks housing tilapia and a variety of plants. The plant tanks are located at one elevation, with the connected fish tanks located on a lower level. Water circulation is achieved with PVC siphons between equal level tanks, gravity flow between tanks on differing levels, and one centrally located water pump to elevate water and continue the cycle. (Note that separate smaller systems at the training center achieved water elevation with airlifts. This was recommended as more energy efficient.) Figure 2.4 illustrates the layout of plant tanks relative to the fish tanks, and Figure 2.5 shows the various water recirculation components. A large variety of plants are continuously seeded and transplanted into the MSF plant tanks, and Figure 2.6 illustrates a few of the plants growing at the time of the researcher's visit.



Figure 2.4 MSF Facility Layout



Fish tanks to plant tanks: water pump



Between plant tanks: siphon flow

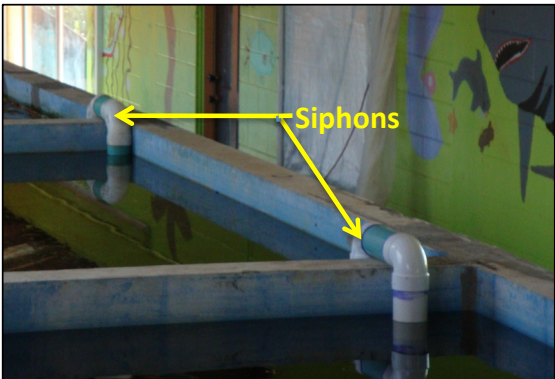

Between fish tanks: siphon flow



Plant tanks to fish tanks: gravity flow down standpipe

Figure 2.5 MSF Water Recirculation Components



Figure 2.6 MSF Planting Beds
Clockwise from upper left: tomatoes and kale, cauliflower, and lettuce

It is important to note that the Morning Star Fishermen facility does not operate at commercial densities. Fish and plants are maintained at lower levels still adequate to teach aquaponic principles. While basic fundamentals and many helpful day-to-day maintenance activities are realized by observing the facility, quantitative commercial operating ratios are not established.

Arguably the most renowned research institute for aquaponics, the University of Virgin Islands' (UVI) Aquaculture Department has constructed recirculating systems for both research and demonstration since 1979 (UVI, 2011). Besides biofloc, pond cage culture, and hatchery facilities, UVI has six research scale systems and one commercial scale system

operational at the time of this report (UVI, 2011). Figure 2.7 shows photographs of the commercial raft UVI system and harvested Nile tilapia.

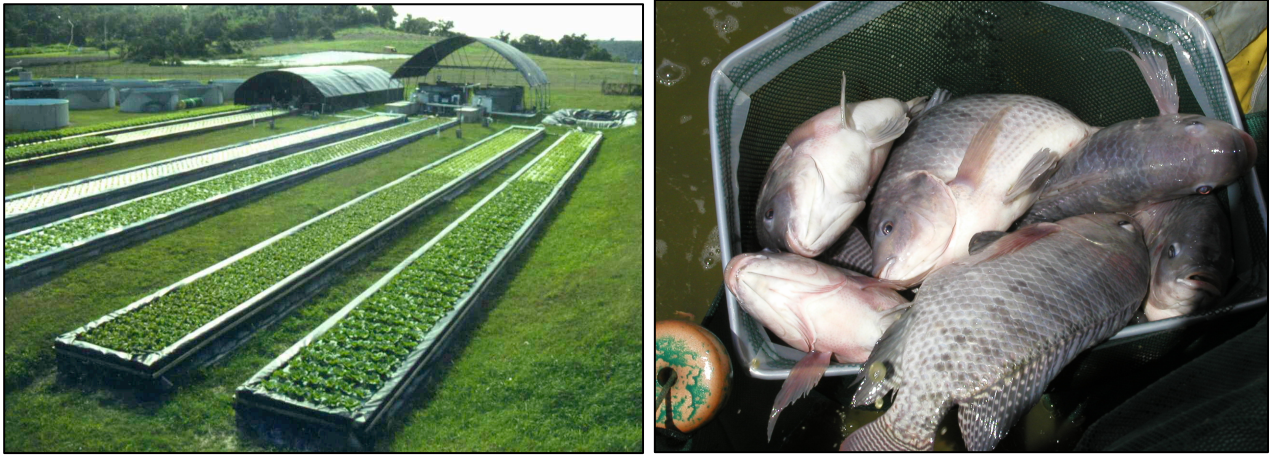

Figure 2.7 UVI Commercial Raft System (from UVI website, www.uvi.edu)

The UVI aquaponic systems are more complex than that of Morning Star Fishermen, and are geared towards densities rivaling U.S. aquaculture commercial densities. Figure 2.8 below is a UVI created schematic of their systems.

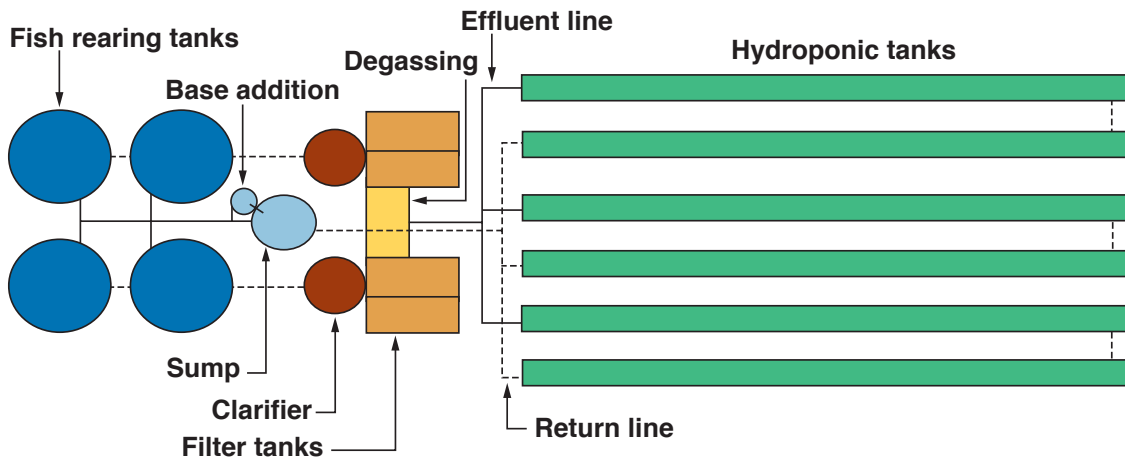

Figure 2.8 UVI Commercial Raft System Schematic (from UVI website, www.uvi.edu)

Table 2.6, adapted from information published by Rakocy *et al.* (2006), identifies what takes place in each system component.

SYSTEM COMPONENT	PURPOSE
Fish Tank	fish housing
Clarifier	settleable and suspended solids (fish waste organic matter) are removed
Filter Tanks	nitrification is facilitated with the aid of high surface area media
De-Gassing Tank	air diffusers remove gases from water exiting filter tank (gases created from accumulated sludge anaerobic conditions in filter bottom)
Hydroponic Tanks	plant growing area
Sump / Base Addition	as lowest system point, pump returns water to fish tanks; base is added periodically to counteract nitrification effects

Table 2.6 UVI Commercial Raft System Components

Regarding base addition, the same referenced Rakocy *et. al.* publication indicates the periodic addition of potassium hydroxide and calcium hydroxide to maintain a pH of 7.0. UVI utilizes rainwater because island groundwater is typically too saline. This is pertinent information because the pilot study utilized rainwater as well, while the proposed facility will be resupplied by both rainwater and groundwater. Groundwater naturally has greater alkalinity than rainwater, and so the ability to maintain acceptable pH levels simply through water resupply will be investigated during facility implementation. In the interest of making the system economically feasible in a developing nation community, the goal was to not add chemicals to the pilot study. Although sometimes affected by factors other than nitrification, pilot study pH was lower on average than UVI systems. Note that ‘acceptable pH level’ is not definitive. Literature-cited ranges vary. A pH of 6.5 to 7.0 is considered acceptable by some (Nelson and Pade, 2008; Friend and Mann, 2009), while others indicate a broader acceptable range of 6.0 to 8.5 (Matousek, 2004).

Attention must be given to differing goals and conditions for a UVI-based facility and the proposed facility. The following two points are identified for consideration:

1. A UVI-based facility is largely intended to be economically profitable relative to the existing aquaculture and vegetable/herb production industry in developed countries like the United States. As indicated by Rakocy *et. al.* (2006), ‘the goal is to culture a vegetable that will generate the highest level of income per unit area per unit time. With this criterion, culinary herbs are the best choice.’ The

proposed facility's goal is to provide protein (fish) and the range of vitamins and nutrients typically lacking in the local diet. As such, a variety of vegetables and greens must be grown. With the group of children to benefit already identified, profitability is a concern only so far as the facility is self-sufficient.

2. A UVI-based facility has fish densities reliant upon a consistent electrical source. Designed to accommodate grow-out densities of two gallons water per pound of tilapia (Rakocy *et. al.*, 2006), a power failure would result in certain widespread mortality. The proposed facility must be designed so that a temporary power failure is not catastrophic. With a decrease in fish density (and corresponding decrease in fish waste), facility complexity can be reduced while still achieving a healthy growing environment.

Despite differences, UVI data is extremely useful in that it provides a baseline comparison for plant to fish ratios. With fish feed quantities dictating the amount of nutrients available for plant uptake (discussed in detail in Chapter 4), the plant/tilapia ratio is dependent on the amount of feed introduced into the system daily. Published UVI loading rates are 60-100 g/m²/day (Rakocy *et. al.*, 2006). With a simplified system's reduced filtering, the expectation is that a lower feed to plant area ratio will result. Refer to Section 4.1.2 for pilot study results.

Chapter 3 Experimental Materials and Methods

The need for a pilot study was identified early on during research. Without physical testing of a simplified system, numerous unknowns would exist in final facility design and operation. At onset, objectives were to:

1. Provide hands-on experience, allowing researcher to consider all aspects of facility design and operation through physical construction and daily maintenance
2. Test maggots and worms as potential non-commercial fish feed producible on-site in any rural developing nation setting

The study evolved in response to discoveries during the study as well as in-field confirmation of a fish feed source in Gulu, Uganda. The primary study identified simplified facility plant/tilapia ratios, and a secondary study identified system design components. The pilot facility constructed was utilized for both the primary and secondary study.

3.1 Pilot Facility Materials

The pilot facility was constructed in a commercial-sized greenhouse (48ft x 20ft) located on private property in Manhattan, Kansas. In exchange for greenhouse clearing, the Owner agreed to allow the back 15 ft by 20 ft area to be used for the project. Figure 3.1 shows an outside view of the structure housing the pilot



Figure 3.1 Pilot Study Greenhouse

study. The greenhouse was already wired for 120V, providing an energy supply for fans, lights, heaters, and water and air pumps. Two water supply sources were available: City water from a spigot inside the greenhouse, or rainwater collected and stored in underground tanks. The rainwater catchment system collected run-off from the greenhouse dome and from the roof of a hardened structure directly adjacent.

Figure 3.2 illustrates the greenhouse interior at project commencement. Note that the project was directly adjacent to the back ventilation door, which allowed for improved airflow during the hot months.

Fortunately, clean-up began in early spring before many of the vines and other plants bloomed. Leaves, debris, and unwanted foliage were dug up and hauled off-site. Pots and bricks salvaged were rearranged elsewhere. The fig tree, located in the center of the project area, was left intact. The ground, hand-tilled to remove remaining roots, was leveled. A heavyweight polypropylene landscape fabric (purchased from Home Depot) was laid over



Figure 3.2 Pilot Study Existing Conditions

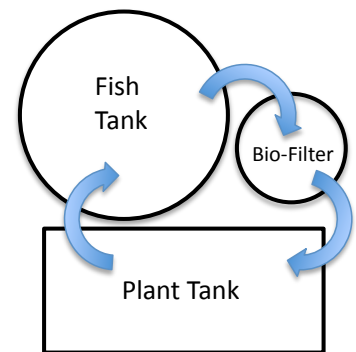

Figure 3.3 Pilot Study Start-Up

the graded soil to prevent future weed growth. Once system components were configured, interlocking rubber mat panels (purchased from Home Depot) were also laid on frequented pathways. With the site prepared, it was time to assemble and construct the pilot study system.

Figure 3.3 illustrates the prepared facility at project start-up. The pilot

**Figure 3.4
Aquaponic
System Water
Circulation**



study's initial configuration consisted of four small-scale systems. The aquaponic design

selected was the raft system. As discussed in Chapter 2, the raft system is more suitable for larger-scale facilities. Each of the four pilot study systems included a fish, bio-filter, and plant tank. Figure 3.4 illustrates the direction of water circulation between system components. Figure 3.5 is a typical system, with each tank labeled. Sections 3.1.1 to 3.1.4 detail tank and water circulation components.

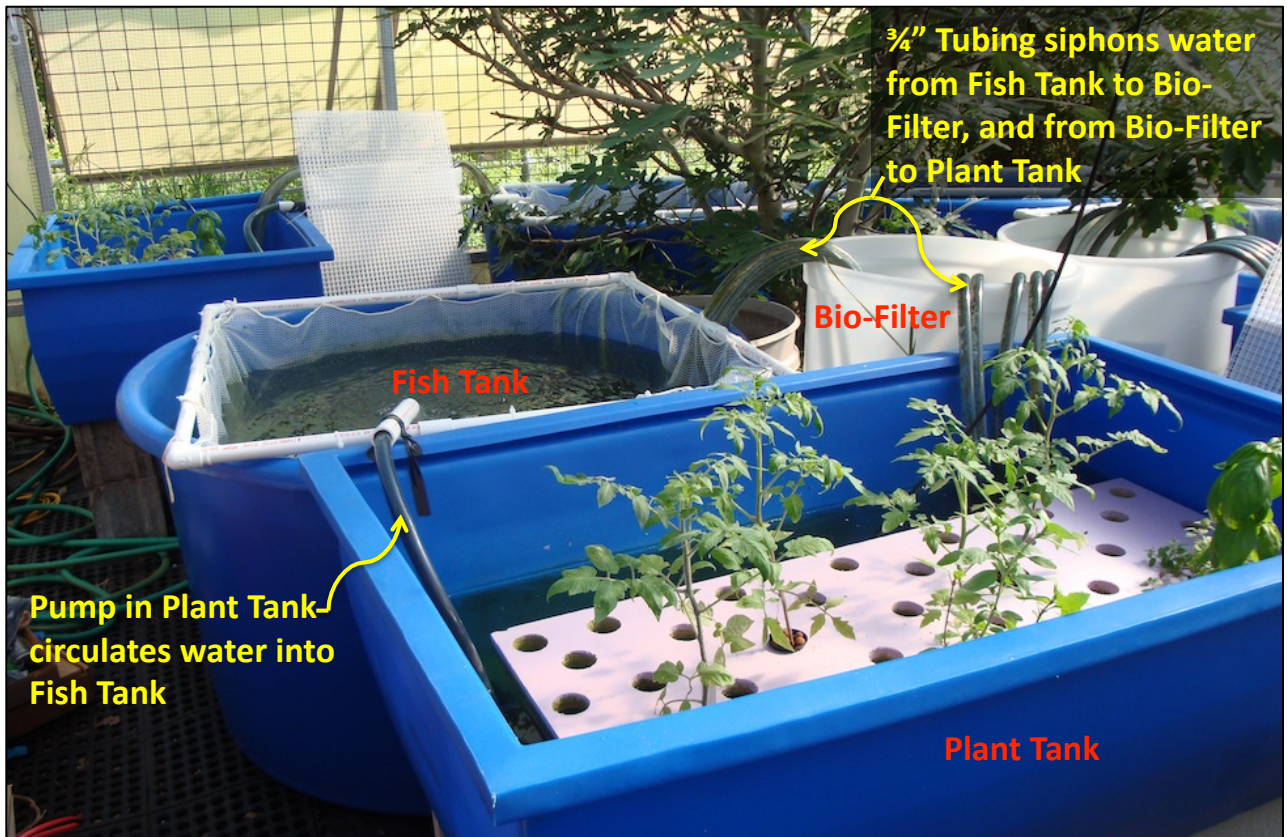

Figure 3.5 Pilot Study System Components

3.1.1 Fish Tank

Tilapia were selected as a fish native to Africa and familiar to Ugandans. Research indicated that Nile tilapia is regularly harvested from Lake Victoria, and Ugandan fisheries specialize in this species. Tilapia is considered a 'hardy' fish capable of



Figure 3.6 Pilot Study Tilapia Fingerlings Feeding

withstanding fluctuating conditions, while also being high in nutrition and protein for human consumption. For the pilot study, both Nile and blue tilapia were approved on the IACUC protocol (see Appendix D). Due to local availability, blue tilapia were utilized for the study's duration. Fish behaviors are similar between the species. Refer to Chapter 2 for discussion on tilapia species, breeding, and growth.

The tilapia supplier utilized was R&S Ranch based in St. Louis, Missouri. Pre-purchase, the researcher visited the supplier (see Section 2.4.2 for details). Upon purchase, the fish were sent FedEx overnight. Fifteen fingerlings, for a total of 60, were placed in each of the four pilot study systems. Figure 3.6 shows tilapia fingerlings feeding.

The fish in each system were housed in a 210-gallon circular polyethylene tank (diameter: 48", height: 30") purchased from Aquatic Eco-Systems. Breeding control bottom clearance was achieved through the use of a net barrier. As shown in the previous section's Figure 3.5, a net attached to PVC piping contained the fish. Although this method was determined to be the most favorable, a bottom plate constructed of landscape edging and plastic mesh screen was originally tested. Figure 3.7 illustrates preliminary breeding control attempts. As discussed in Chapter 4, the initial design was less than ideal. Subsequently, a 1/8" mesh net box (4' L x 4' W x 2' H) was ordered from Aquatic Eco-Systems and attached to 1/2" PVC piping with electric ties. The rectangular PVC form balanced on the fish tank rim, and the electric ties also allowed for maintenance of adequate bottom clearance.



Figure 3.7 Fish Tank Bottom Inset

3.1.2 Bio-Filter Tank

Water from the fish tank flowed into the bio-filter tank. A 55-gallon polyethylene graduated tank (Diameter: 21", Height: 36"), purchased from Aquatic Eco-Systems, was used as the bio-filter tank. The 55-gallon drum also had a 3/4" spigot valve at the bottom, which proved useful for draining accumulated waste.

Bio-media, contained within a mesh bag, provided additional surface area for bacteria. Figure 3.8 illustrates the honeycomb shaped plastic media utilized, as well as a view looking down into the bio-filter tank. The 'lumpy' mass seen is the bio-media bag floating at the water surface. See Section 4.2.2 for a photograph and discussion on bio-filter duckweed growth.

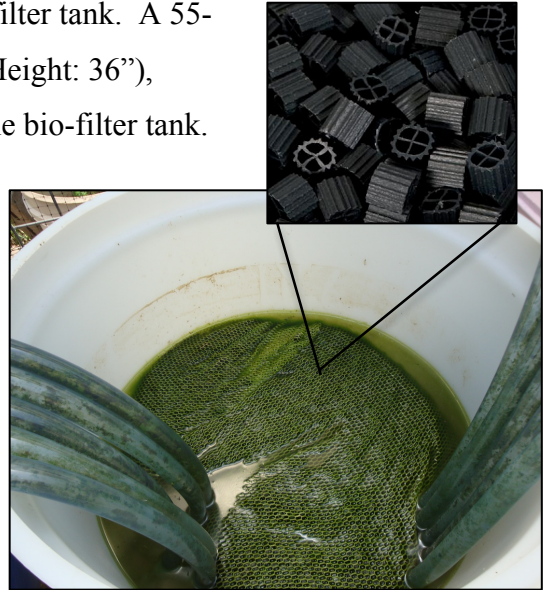

Figure 3.8 Bio-Filter Media

(bio-media photo from www.aquaticeco.com)

3.1.3 Plant Tank

The plant tank in each system consisted of a 110-gallon rectangular polyethylene tank (length: 48", width: 31", height: 18") purchased from Aquatic Eco-Systems.

Within the raft system, plants grew in web pots filled with clay balls. A drill press was used to cut appropriate-sized holes in polystyrene foam panels cut to fit into each tank. At start-up, tomato, basil, cinnamon basil, and oregano plants transplanted into the systems were purchased from a local farmers' market. Figure 3.9 shows the researcher's nephew assisting with transplant during project start-up.



Figure 3.9 Stocking Plant Tanks at Start-Up



Figure 3.10 Plants Seeding

Plants introduced later were seeded until plant height was at least one inch, with some degree of root system development. The following types of plants were seeded: tomato, zucchini, eggplant, cucumber, pea, buttercup squash, and okra. Seeds were planted in either soil or rockwool media. Figure 3.10 shows plants in seed trays prior to transplant.

Figure 3.11 illustrates how the plants grew in the aquaponic raft systems. Plants grew in web pots fitted in the foam panel holes. A portion of the web pot, along with all roots, remained submerged in water below the raft.



Figure 3.11 Plant Tank Raft Views

Other materials utilized include stands and rope for vertical climbing plants, and sticky-paper traps to control a white fly outbreak.

3.1.4 Water Recirculation

As indicated in Figure 3.4, water flowed from the fish tank to the bio-filter, from the bio-filter to the plant tank, and from the plant tank back to the fish tank. Recirculation was achieved through the use of one water pump between the plant and fish tanks, and 3/4" tubing served as siphons for the fish/bio-filter and bio-filter/plant tank connections.

Pondmaster 250 gph Mag-Drive pumps, shown in Figure



Figure 3.12 Pilot Study Water Pumps
(photo from www.pondmaster.com)

3.12, were utilized in all systems. Figure 3.13 shows water, pumped from a plant tank, cascading into a fish tank for both water recirculation and aeration.

Both the method for lifting water at the plant/fish tank connection and the materials for the siphon connections were revised after initial field attempts. Originally, the plan was to circulate water from the plant to fish tank via an airlift. The air pump, shown in Section 3.1.5 below, was originally purchased for this purpose. In turn, the use of siphons to circulate water was modeled after the Morning Star Fishermen Training Facility in Dade City, Florida. Similar to that facility (refer to Chapter 2 for details and photographs),



Figure 3.13 Pilot Study Water Recirculation

PVC piping lengths and elbows were initially used during set-up. In both cases, original plans were revised. Refer to Chapter 4 for further discussion on design changes.

Two water sources supplied the greenhouse: City water and rainwater. At project set-up, City water was utilized to fill two systems, with API Tap Water Conditioner used to neutralize chloramines harmful to fish. Rainwater was used to fill the other two systems, and also served as the resupply source for all systems.

3.1.5 Miscellaneous Components

Three major facility components not yet discussed are lighting, heating, and aeration. The following identifies equipment selection for each component.

Lighting: High pressure sodium (HPS) lights were used during fall and winter months to extend the growing season. Figure 3.14 shows the selected lamp, a Sun System HPS 150 Watt Grow Light Fixture. One lamp



Figure 3.14 Pilot Study HPS Lamps

was placed above each plant tank, with running time adjusted in accordance to waning sunlight hours. Literature indicates that maximum growth is experienced with daily exposure of 16 to 18 hours sunlight (Roberto, 2005).

When selecting artificial lighting, the two high intensity discharge (HID) options considered were metal halide (MH) and HPS. MH lamps, which emit a white/blue spectrum, are considered ideal for vegetative growth and/or when no supplemental natural sunlight is available. HPS lamps emit a yellow/orange spectrum that is ideal for plant fruiting and flowering. When solely using HPS lamps, natural sunlight should also be available (Roberto, 2005).

HPS lamps were selected for the study because natural sunlight remained available, and because plant fruiting was desired. If only one type of lamp is used, literature indicates that HPS systems are favored for greenhouse operations (Roberto, 2005).

Heating: During fall and winter months, supplemental heating was required to maintain 75-80°F water temperatures. Bucket heaters (see Section 4.1.1 for photographs) were initially selected for their high power output and inexpensive cost relative to aquarium heaters. As detailed in Section 4.1.1, galvanic corrosion necessitated their removal. Standard glass-encased aquarium heaters were subsequently purchased and installed.

Aeration: Considering energy requirements, the initial desire was to operate a facility with minimal aeration. Study data and observations indicated that this was not feasible (refer to Section 4.1.1). Aeration was provided with a Medo SL88 piston air pump and standard 6-inch and 12-inch air stones. Air stone air supply was controlled with a simple valve assembly purchased at a local pet store. Figure 3.15 below shows aeration equipment.

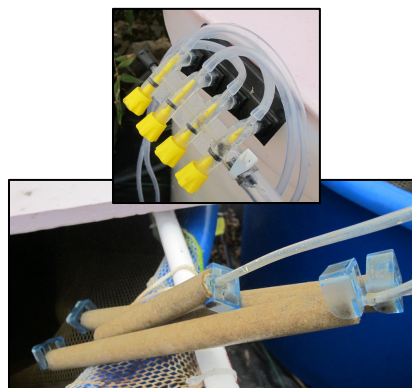

Figure 3.15 Pilot Study Aeration Pump and Appurtenances

3.2 Pilot Study Methodology

All aspects of the pilot study focused on developing an economically and culturally achievable facility for a rural developing nation setting. The pilot facility represented a simplified version of large-scale aquaponic systems currently studied in the West.

Due to the developing partnership with an in-field organization, the economics and culture of northern Uganda were specifically considered.

3.2.1 Water Quality

Water quality measurements corresponded to critical aquaponic parameters, as outlined and discussed in Chapter 2. Focused on nitrogen concentrations, Table 3.1 is a repeat of the water quality table introduced in Chapter 2. Refer to Chapter 4 for discussion of pilot study parameter operating levels.

Table 3.1 Water Quality Parameter Ranges and Lethal Limits

PARAMETER	UNITS	HEALTHY RANGE	LETHAL CONDITIONS LIMIT
Temperature, T	°F	75 to 85	45 to 50
pH	----	6 to 8	4.5 to 5.0
Dissolved Oxygen, DO	mg/L	> 3	0.5
TAN (NH ₄ ⁺ + NH ₃)	mg/L	< 3	----
Ammonia, NH ₃	mg/L	< 0.06	2 to 3
Nitrite, NO ₂ ⁻	mg/L	< 1	5.00
Nitrate, NO ₃ ⁻	mg/L	< 500	----

All secondary study water quality measurements were conducted with the LaMotte Fish Farm 9 Freshwater and individual Nitrate kits (see Figure 3.16). These drop-test kits provided readings for temperature pH, ammonia nitrogen, nitrite, nitrate, alkalinity, carbon



Figure 3.16 LaMotte Drop-Test Kit (pH test underway)

dioxide, chloride, dissolved oxygen, and hardness.

It was quickly realized that drop-test kit measurements, especially for the quantity of water samples under consideration, were extremely time-consuming and inefficient. Although key parameters were routinely monitored as intended, it was impossible to test all parameters on a daily basis.

Prior to commencement of the primary study, the researcher invested in a YSI Professional Plus Multiparameter Instrument. The handheld device greatly reduced testing times. Sensor probes attached to a single cable allowed for rapid multiple parameter readings. Refer to Figure 3.17 for a photograph of the equipment. As shown and used, the meter was configured to simultaneously provide temperature, pH, dissolved oxygen, conductivity, ammonium ion (NH_4^+), and ammonia (NH_3) readings. Calibration solutions were used periodically to calibrate pH, conductivity, and ammonia. DO calibration was achieved using the water saturated air method.



Figure 3.17 YSI Professional Plus Handheld Meter and Probe Sensors

3.2.2 Facility Design/Configuration

To minimize facility cost, operation, and maintenance, design simplifications identified were as follows:

1. Mechanical components: limit to critical air and water pumps
2. Components susceptible to clogging and/or costly repair: eliminate/minimize

3. Construction materials: use materials locally available in northern Uganda

Corresponding to the above list, this translated to the following:

1. Water flow: achieve through passive methods, with a pump used only at the plant/fish tank connection. Manual labor must replace mechanical treatment processes (i.e. fish waste hand siphoning replaces mechanical clarifier and filtration processes).
2. Underground piping and high-tech equipment: eliminate
3. Tank material: use concrete block and local construction practices. (Note: A site visit was conducted in August 2010 to confirm available materials. Refer to Chapter 4 for discussion.)

The pilot facility incorporated all aspects above, with the exception of tank materials used. The physical components remained similar between the secondary and primary studies. However, the planting area and fish density was varied in the primary study in order to identify an acceptable plant/tilapia ratio.

3.2.3 *Tilapia Feeding and Growth*

AquaMax 500 was the feed of choice. AquaMax 500 met the higher protein content required by fingerlings, as discussed in Chapter 2. Feed specifications are detailed below (Purina Mills, 2008):

- Pellet Diameter: 3/16 inches
- Form: Extruded – Floating
- Protein Content: 41%
- Fat Content: 5%
- Fiber Content: 4%

At study commencement, fish were fed three times a day *ad libitum*. As the fish adapted to their new environment, the amount of food consumed was not consistent. Providing incremental feed amounts, until eating ceased, allowed for varied appetites during the adjustment period or in response to varied



Figure 3.18 Pilot Study Scale

environmental inputs (i.e. temperatures, DO levels, etc.). This method of feeding mitigated uneaten food accumulation on the tank bottom. Once systems were established, feed was weighed but still distributed incrementally to eliminate uneaten portions decaying on tank bottoms.

When fish feed or tilapia were weighed, an Ohaus Ranger RD6RS scale was utilized. Pictured in Figure 3.18, the scale measured in grams (6000 g capacity x 0.5 readability), kilograms (6 kg x 0.0005), pounds (12 lb x 0.001), and ounces (120 oz x 0.01).

3.3 Plant Selection and Observation

At facility start-up, tomato, basil, parsley, and oregano plants were spaced six to eight inches. Okra, tomato, zucchini, buttercup squash, cucumber, eggplant, and pea plants were seeded in rockwool or soil, and subsequently transplanted into the systems. While seeding, fish tank water was used to water both soil and rockwool seeding media trays. Refer to Sections 4.1.5 and 4.2.4 for photographs and discussion on plant growth.

3.4 In-Field Site Investigation

A trip to Uganda was completed in July 2010. The trip's purpose was to: 1) coordinate with the partnering in-field organization; 2) verify location and water supply of proposed facility's site; and 3) verify local material availability and cost.

An Introductory Manual and Preliminary Construction Drawings (refer to Appendix E) were prepared in advance of the trip. These documents provided a point of reference for discussions and research completed in Uganda. Section 4.3 details all in-field discoveries related to the proposed facility design and operation.

Chapter 4 Results and Discussion

The pilot study, divided into primary and secondary studies, realized the potential for simplified design commercial operations. Defined previously, simplified design entails: mechanical components limited to water and air pump; underground piping and specialty materials eliminated. The following categorizes key findings:

1. Required operation and maintenance activities
2. Optimal physical design components
3. Efficient water quality testing methods
4. Plant/tilapia ratios
5. Simplified commercial-scale proposed facility design

The primary study provided the majority of the study's quantitative results. Key proposed facility design ratios and sizing were identified as a result of data collected (items 4 and 5 above), and detailed discussion is provided in Section 4.1. Secondary study discussion follows (Section 4.2), with results crucial to the identification of simplified design components (items 1 to 3).

4.1 Primary Pilot Study

The objective of the primary pilot study was to identify minimum plant/tilapia ratios: in a commercial system based on simplified technology, what plant area is required per fish mass in order to maintain acceptable TAN levels?

Besides determining a plant/tilapia ratio, occurrences and observations during the primary study provided additional results. The following list identifies key findings, with supporting narrative provided in sections 4.1.1 through 4.1.5.

1. Design proposed facility with a plant/tilapia ratio of 2.5 ft²/lb.
2. To minimize fish mortality in the event of power outage, anticipate operating densities in the range of 8-12 gal/lb. (Note: Proposed facility sizing is provided for fish densities of 3-12 gal/lb.)

- Aeration is required to maintain healthy DO levels above 5 ppm, as well as to release carbonic acid build-up contributing to lowered pH. Despite its low energy appeal, surface aeration does not provide adequate oxygenation at tank depths.

4.1.1 Water Quality Data Analysis

The primary study began with a configuration similar to the secondary: one fish tank, one bio-filter, and one plant tank. Fish density was increased to a level anticipated to result in an unacceptable plant/tilapia ratio. An unacceptable plant/tilapia ratio was measurable by un-ionized ammonia (NH_3) in excess of 0.06 mg/L, or total ammonia nitrogen (TAN) in excess of 3.0 mg/L. Both values were healthy growing tolerances, not fatal quantities. TAN was obtained by adding NH_3 and ionized ammonium (NH_4^+) together.

Note that, throughout the primary study, NH_3 levels never registered above 0.0 mg/L on the YSI meter. Therefore, the NH_4^+ levels were utilized to determine if TAN levels were within range. While the ionized ammonium was nontoxic to fish, a shift in pH and/or temperatures could have easily resulted in a large fraction of the un-ionized toxic form. As illustrated in Section 2.2, it was critical to keep the ionized form within limits.

Once TAN levels advanced above the identified healthy range, planting area was added to the system via two additional tanks. Based on the existing tank configuration and proximity to the primary study system, one was a standard rectangular plant tank, while the other was a circular tank previously used for fish. The two

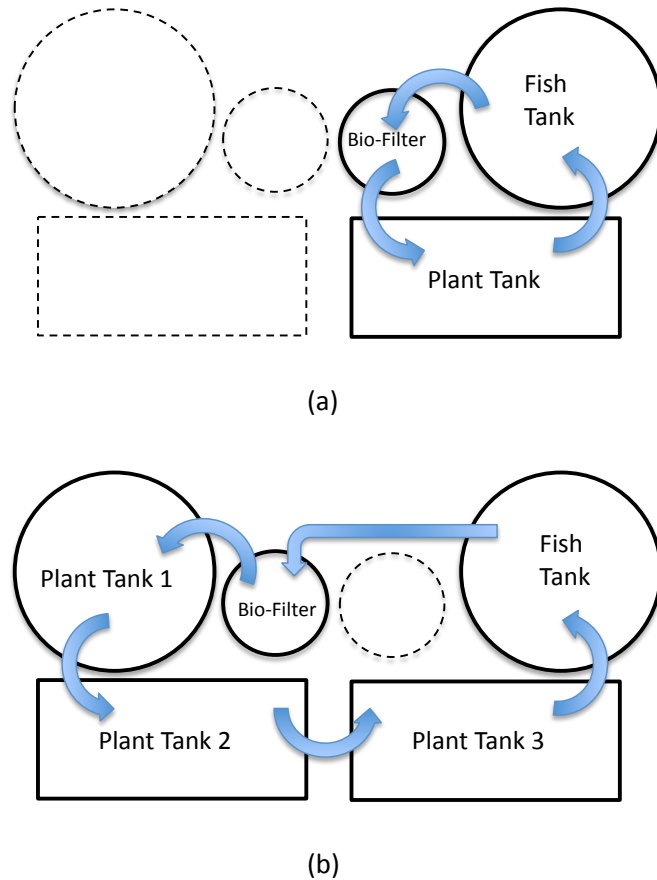

Figure 4.1 Primary Study Start-Up and Expanded Configurations

tanks were connected to the system with 3/4-inch siphon tubing. Figure 4.1a is a schematic of the physical tank components Day 1 through Day 13. Figure 4.1b illustrates the expanded system configuration from Day 14 through study end. Figure 4.2 is a photograph corresponding to the expanded system. The three plant tanks are visible. The system's fish tank, not directly visible, was located adjacent to the furthest rectangular plant tank.



Figure 4.2 Primary Study Expanded System

Besides TAN, temperature, pH, and dissolved oxygen (DO) were measured near daily during the primary study. Refer to Appendix B for complete records. Figure 4.3 plots pH and TAN for the study duration. Plotting both water quality parameters on a similar graph highlights corresponding responses to environmental inputs. Figure 4.4 illustrates DO for the study duration.

In both instances, the acceptable operating limit is color-coded. DO and TAN operating limit ranges correspond to the 3 mg/L limits identified in Section 2.2. The pilot study's lower pH limit of 5.5 is less than the 6 to 8 range identified in Section 2.2. The pilot facility experienced pH levels between 5.5 and 6.0 for the majority of the study. With no fish fatalities attributed to pH levels between 5.5 and 6.0, 5.5 is considered a minimum acceptable value. In addition, it was noted that pH values between 5.5 and 6.0, in conjunction with proper aeration, did not inhibit feeding behavior. Proposed facility operational pH levels will be monitored in detail during proposed facility implementation. If absolutely required and

available locally, potassium hydroxide (KOH) and calcium hydroxide [Ca(OH)₂] are recommended pH adjustment chemicals (Rakocy, *et. al.*, 2006). Sodium bicarbonate (NaHCO₃), although less expensive, is not advisable. Sodium content is harmful to plants (Rakocy, *et. al.*, 2006). It is estimated that aeration and increased alkalinity (pH buffer) provided by groundwater re-supply will allow for continual non-chemical operations.

Narrative following Figures 4.3 and 4.4 details occurrences for four critical event days, and corresponding system responses and lessons learned.

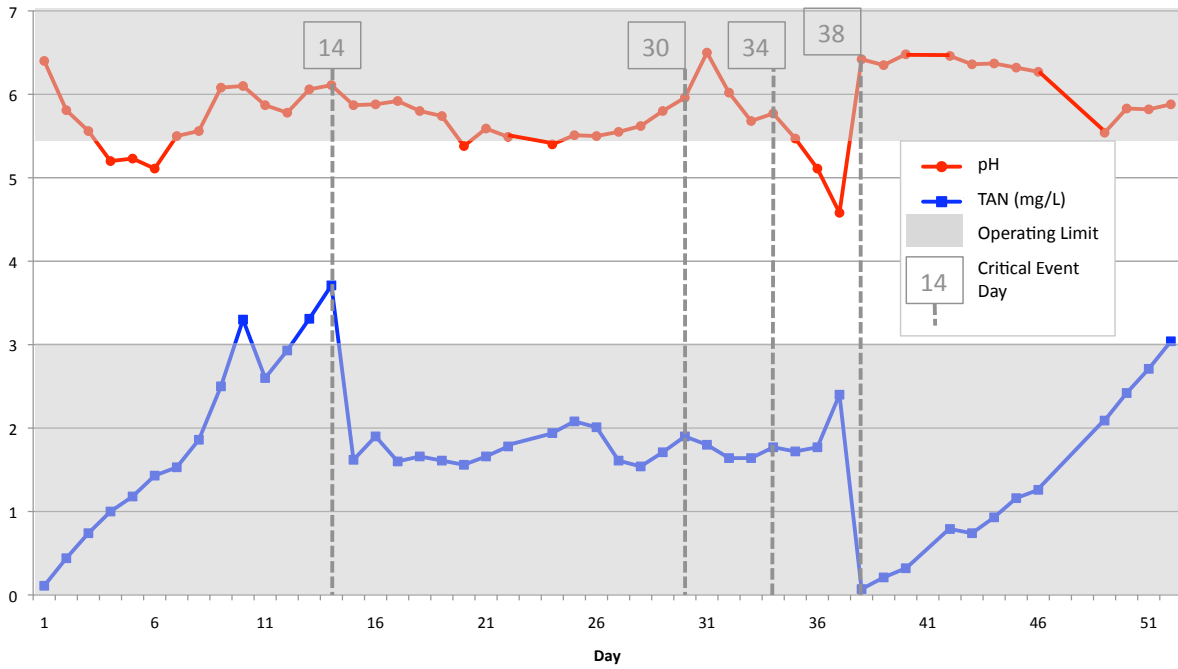

Figure 4.3 Primary Study pH and TAN Levels

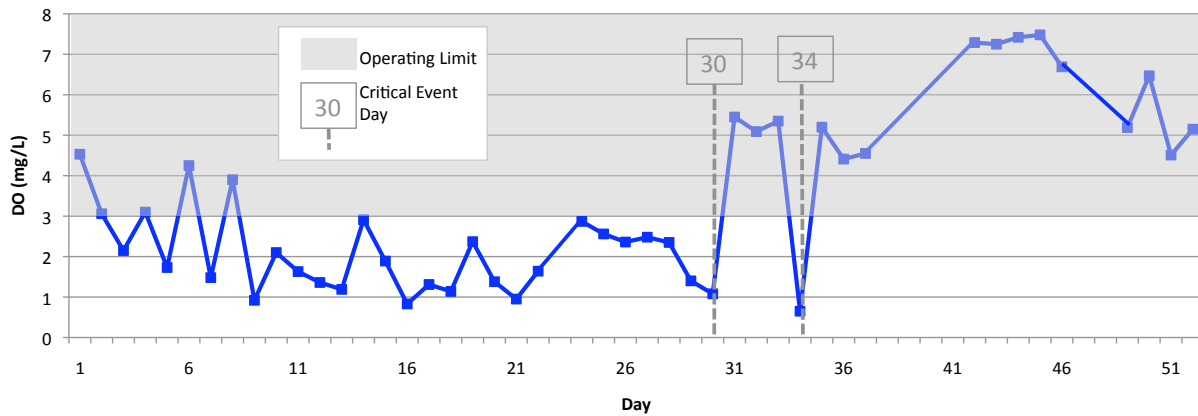

Figure 4.4 Primary Study DO Levels

Day 1: Primary study commenced. Thirty-one fish were stocked in a 210-gallon fish tank, with one plant tank for nitrogen removal. A planting area range of 5.0 to 7.5 square feet was used for all ratio calculations, accounting for the fact that the entire area was not filled with mature plantings for the study's duration. The 5.0 ft² value represented the area of plantings upon study commencement, while 7.5 ft² represented the maximum polystyrene foam area in the rectangular plant tanks. The upper limit was neared as plants matured. Figure 4.5 shows tilapia swimming in the primary study's fish tank.



Figure 4.5 Growing Tilapia

Day 14: An additional 20 ft² planting area capacity was added in the form of one 110-gallon rectangular tank and one 250-gallon circular tank. The fish population remained constant from Day 1.

A 1.5 mg/L TAN drop occurred with system expansion, after which the increased plant/tilapia ratio maintained TAN levels at or below 2 mg/L. An operating TAN concentration lower than the identified 3 mg/L limit provided a factor of safety. Although the addition of plants to the system contributed to reduced TAN levels over time, the immediate rapid change was attributable to the approximate 250-gallons of unpolluted (i.e. clean rainwater) being introduced into the system with the two new plant tanks.

For ratio calculations outlined in the next section, the rectangular tank contributed 5.0 to 7.5 ft² of planting area. Although the circular tank had a maximum area of 12.5 ft², the plants never reached full maturity over the study's duration. Therefore, contributing area

ranged from 50% capacity (6.3 ft²) at introduction to 67% (8.4 ft²) towards study end. Table 4.1 shows plant area and fish quantity / mass at critical study occurrences.

Day	No. Fish / Total Mass, lb	Planting Area, ft ²
1	31 / 10.75	5.0
14	31 / 10.80	16.3 – 23.4
34	25 + 6 new / 10.85	18.4 – 23.4
38	50 / 17.55	18.4 – 23.4

Table 4.1 Primary Study Plant Area and Tilapia Stocking

Total fish mass was measured at commencement (Day 1) and termination (Day 52). Table 4.1 total mass values for Day 14, 34, and 38 represent interpolated growth. Aeration proved critical to feed intake. Therefore, documented growth rates are less than what is achievable when continual submerged aeration is provided from the fry/fingerling stages through grow-out.

Figure 4.6 below illustrates the circular tank on the day it was introduced to the primary study system. The plants, purchased at a local nursery, included broccoli, cauliflower, cabbage, and lettuce. These plants were selected for their cooler weather tolerance. Roots were carefully rinsed of soil before transplanting them into web pots. Note that, because the plants were larger than ideal transplant size, any damaged or ripped roots resulted in stunted development while root re-growth occurred.



Figure 4.6 Primary Study Transplanted Broccoli, Cauliflower, Cabbage, and Lettuce

Day 30: Aeration, in the form of one 12-inch and one six inch air stone, was added to the fish tank in response to dissolved oxygen levels gradually decreasing to sustained levels below 3 ppm. In addition, one fish exhibited stressed behavior (gulping at the surface) the evening prior, and was found dead the morning of Day 30. Although other fish did not behave similarly, the oxygen levels were not improving and required immediate corrective action.

Upon introduction of the air stones (see Figure 4.7), the pH levels increased from below 6.0 to approximately 6.5. A change in pH was noticeable in less than an hour of adding the aerators, reflecting the degassing of CO₂. Because CO₂ levels were not being monitored at this point in time, no comparison between pre- and



Figure 4.7 Primary Study Fish Tank Aeration

post-aerator levels was available. However, once the pH change was observed, information gathered during the literature review provided an explanation. Initially discussed in Section 2.3, the process is further detailed here.

When dissolved in water, carbon dioxide is part of the carbonate system consisting of carbon dioxide (CO_{2(aq)}), carbonic acid (H₂CO₃), bicarbonate (HCO₃⁻), and carbonate (CO₃²⁻). The following equations illustrate the relationships and reactions between species (Masters and Ela, 2008). Water pH governs system equilibrium and the fraction of each species present.

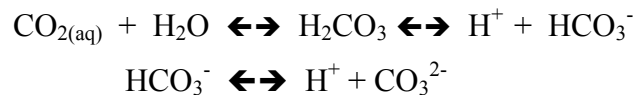

Aeration bubbles absorb CO_{2(aq)} dissolved in the water, subsequently transporting them to the water surface for release into the atmosphere. During the CO_{2(aq)} stripping process, portions of other species convert back to CO_{2(aq)} as equilibrium is re-established among the carbonate system species (Timmons and Ebeling, 2007).

When aeration does not provide carbon dioxide degassing, greater concentrations of hydrogen ions are present. Higher hydrogen ion concentrations equates to a lower pH. When $\text{CO}_{2(\text{aq})}$ stripping occurs with aeration, hydrogen ion concentration reduces as equilibrium is reestablished.

Fish behavior was observed to change with the addition of aeration. Dissolved oxygen levels increased rapidly, and averaged above 5 ppm for the remainder of the study (with exceptions as noted below for Day 34 and 38). Although many texts indicate that a healthy oxygen range for tilapia is above 3 ppm, higher DO levels appeared beneficial. A noticeable increase in activity occurred after introduction of air stones. Most obvious was an increase in feeding. For additional information on the role that feed input played in the determined plant/tilapia ratio, please refer to Section 4.1.2.

Observations led to the conclusion that a simplified system cannot exclude aeration. Dissolved oxygen levels, attainable only with submerged aeration, resulted in healthier fish behavior. Although this aeration requirement necessitates additional energy supply relative to a system with surface aeration only, optimum grow-out periods will not be achieved without it.

Day 34: A power outage occurred the evening prior at approximately 7:30pm. When discovered the morning of Day 34, the system had been without water recirculation and aeration for over 12 hours. The most critical response was a DO oxygen drop from above 5 ppm to 0.65 ppm. The drastic and rapid DO descent resulted in six fish mortalities. Upon discovery, power was immediately restored and the dead fish (see Figure 4.8) were removed (seven fish are shown in the bucket because one fish in the reserve tank died during the power outage as well). Following system restoration, the study system was restocked with six live fish from the reserve tank. This maintained near constant fish quantity and mass.



Figure 4.8 Primary Study Power Outage Tilapia Mortalities

An interesting observation is that the tilapia, known for their hardiness and ability to endure fluctuating and less than ideal water quality, faced mortalities in conditions they have been known to endure. The reason for the mortalities is that a lethal threat is posed when water quality parameters undergo sudden change, versus a slow and steady decline.

A conclusion from the pilot study's power outage incidence is that the first facility must be designed for densities less than originally planned. The approach was to introduce fingerlings at very low densities, eventually attaining densities in the target range of three to eight gallons per pound. With the realization that the energy supply in northern Uganda will be less reliable than a western electrical grid, it is important to identify acceptable risk. If a dense fish population quickly depletes available oxygen during power outage, the highly probable complete system fish kill would be utterly disastrous. Maintaining lower densities that improve the chance of survival in a power loss event poses less risk, while still achieving the goal of providing a renewable food source.

Day 38: With pH below 5 and continuing to drop, a complete system water change occurred. The cause was discovered and removed. The bucket heaters (see Figure 4.9), initially selected for their high power output and inexpensive cost relative to aquarium heaters, were determined to be undergoing galvanic corrosion.

Galvanic corrosion is a transfer of ions between two dissimilar metals, which will always have different charges. Galvanic corrosion occurs when two dissimilar metals are in direct contact or submerged in an electrolyte (i.e. water) acting as a medium for ion transfer. Electrons transfer from the more easily oxidized, or less noble, metal to the metal more resistant to oxidation and considered to have higher nobility. (Corrosionist, 2011; MECC, 2011)

The less noble metal is the anode and the more noble metal is the cathode. During galvanic corrosion, deposition will occur on the anode. The extent of this corrosion is dependent on electrolytic conductivity. If the electrolyte medium has high conductivity, the galvanic corrosion will encompass a large area. If the electrolyte has low conductivity, galvanic corrosion will only occur in areas where the dissimilar metals are adjacent. (Corrosionist, 2011; MECC, 2011)



Figure 4.9 Primary Study Bucket Heater and Galvanic Corrosion

Referring to the right photograph in Figure 4.9, it is evident that deposition/corrosion occurred on the heating elements. Therefore, the heating elements were the anode, and the stainless steel guard was the cathode. Note that corrosion was limited to areas where the two metals were adjacent. The black deposition limits align with the stainless steel shield edge. This coincides with the fact that rainwater is not highly conductive unless contaminated. (Corrosionist, 2011; MECC, 2011)

Regarding bucket heater metal composition, the guard was known to be stainless steel while the heating element was unknown. Per Davis (2000), nickel-chromium alloys are commonly used in household and commercial electric heating resistant applications. With heating element composition unknown, iron is used to illustrate how galvanic corrosion reduces pH and has a higher reaction rate with higher DO levels (MECC, 2011). During oxidation, elemental iron is broken down into ferrous iron and electrons:

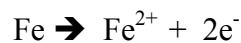

The ferrous iron then reacts with the electrolyte (water) to form ferrous hydroxide and hydrogen ions. The ferrous hydroxide reacts further to form a ferric hydroxide $[\text{Fe}(\text{OH})_3]$ rust coating on the anode. Discussed in Chapter 2, an ever-increasing hydrogen ion quantity registers as an ever-decreasing pH.

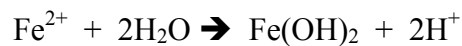

The electrons formed during iron oxidation combine with hydrogen ions to form hydrogen gas. Subsequent hydrogen gas accumulation at the cathode is called polarization.

Polarization interferes with corrosion by forming a barrier between the cathode and the electrolyte.



The hydrogen gas barrier is depolarized with the presence of dissolved oxygen. Oxygen reacts with the hydrogen gas to form water. Therefore, high dissolved oxygen levels increases depolarization reaction rates, which increases rate of corrosion.

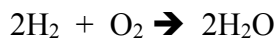

Once the problem was recognized and removed, standard glass-encased aquarium heaters were placed in the system. A similar pH trend was not encountered for the remainder of the study.

Note that, with the large drop in pH, a spike in TAN occurred. As detailed in Chapter 2, the reported optimum pH range for nitrification varies. With lower optimum spectrum pH values of 6 to 7, the system was experiencing levels much lower than advantageous. Retarded nitrification is one very plausible explanation for the spike in TAN with decreasing pH.

After the complete water exchange on Day 38, fish density was increased in the hope of obtaining additional data on maximum system loading capacity. With outside temperatures dropping, it was noticeably more difficult to maintain constant water temperatures. In addition, it was not known how long the greenhouse interior would protect the plants against below freezing outside air temperatures.

Following the water exchange and fish density increase, the pH immediately rose above 6, and the ammonia-nitrogen dropped to near zero. It is logical that the pH should start over near natural rainwater pH levels, and the system should not experience TAN concentrations until fish waste has re-entered the system.

Winter conditions necessitated that the pilot study end on Day 52. It is not known if the increasing TAN trend represented nitrifying bacteria re-population after a complete water change, or fish density overstocking. Peak nitrogen concentration trends were also not obtained prior to study end. The data collected during that period is considered inconclusive.

For plant/tilapia ratio determination, only the data from Day 14 to Day 38 is deemed valid. Although data trends from Day 1 to 14 and Day 38 to Day 52 illustrate water quality

fluctuations in response to environmental factors, they are not adequately stable for ratio determination.

As discussed, the primary study system was enlarged on Day 14 to the configuration illustrated in Figure 4.10. On Day 17, water quality readings were expanded to

include Plant Tank 1 (PT1), Plant Tank 2 (PT2), and Plant Tank 3 (PT3). The additional data provides general insight into changes in temperature, DO, pH, and TAN between tanks.

Figure 4.11 illustrates differential trends in the direction of flow: Fish Tank (FT) to PT1, PT1 to PT2, and PT2 to PT3.

In consideration of meter error, a comprehensive view of the data trends is most appropriate. For example, the ammonia sensor accuracy specification is +/-10% of the reading or 2 mg/L, whichever is greater (Longfield, 2010). When viewing trend lines, any point plotted below 0.0 on the Y-axis indicates a drop in that parameter between tanks. In turn, a data point above the Y-axis zero point indicates an increase. If a trend line has a zero or near-zero slope, tank differentials remained relatively constant for that period. Refer to narrative following Figure 4.11 for additional discussion.

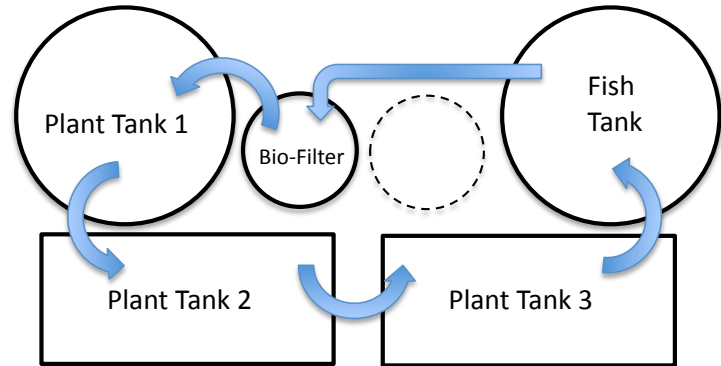

Figure 4.10 Primary Study Expanded Configuration

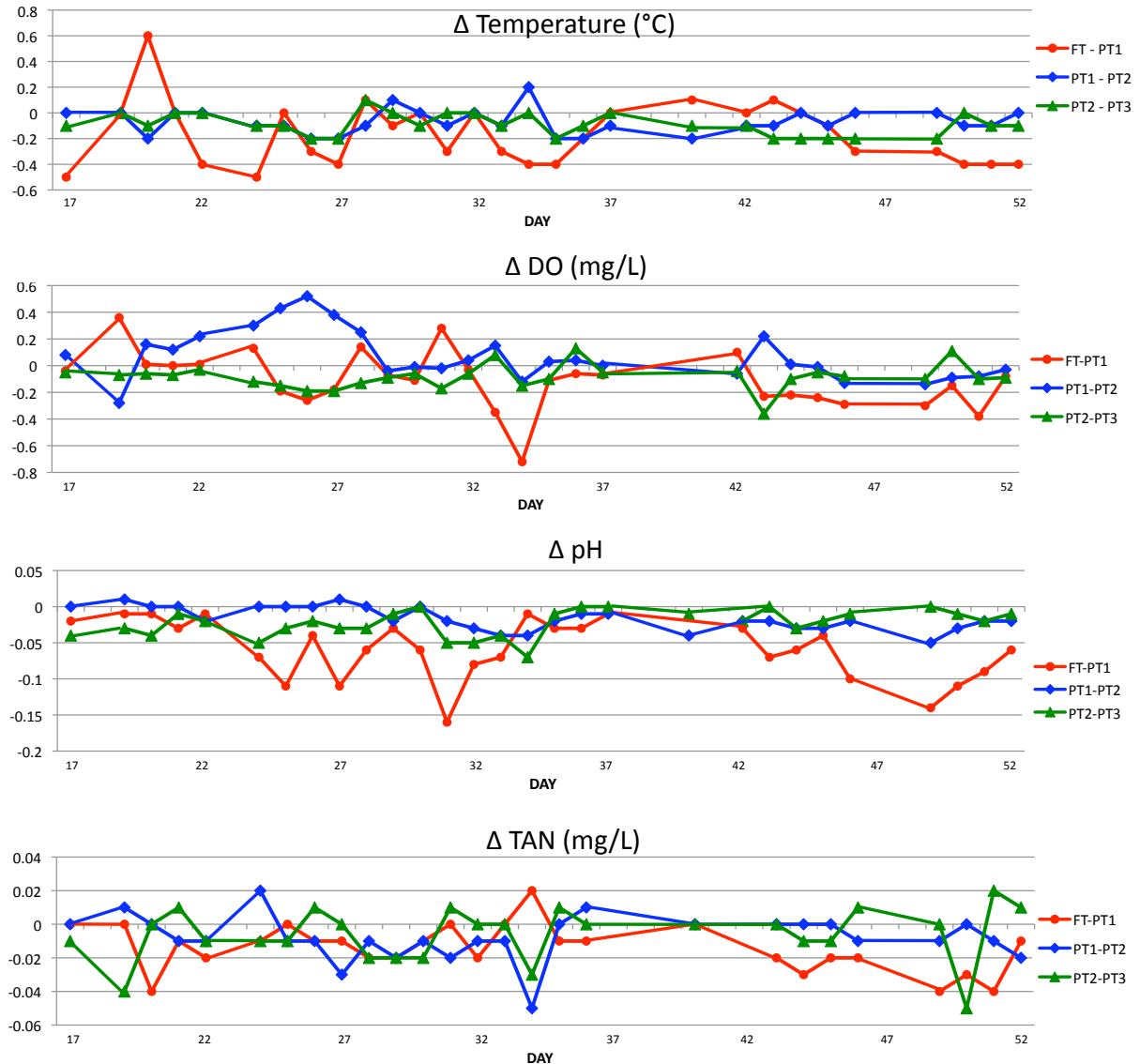

Figure 4.11 Primary Study Temperature, DO, pH, and TAN System Tank Differentials

The following observations are made:

1. **Δ Temperature:** In general, the temperature dropped between subsequent tanks. This coincides with the fact that heaters were present in the fish tank throughout the study. Heaters were added into PT1, and later PT2, as temperatures continued to drop.
2. **Δ DO:** In general, DO dropped between tanks. However, reaeration occurred when water flowed from the deeper PT1 to the shallower PT2 prior to aeration (Day 30). When aeration was introduced, it was only provided in the fish tank.

With plant respiration (during daylight hours) and biological processes consuming oxygen, subsequent differentials were expected between plant tanks.

3. **Δ pH:** In general, the pH dropped between tanks. This coincides with continued nitrification in subsequent units. Nitrifying bacteria, established on plant tank raft surfaces and roots, continue nitrification beyond the bio-filter tank (see Section 2.3).
4. **Δ TAN:** In general, the TAN dropped between tanks. This was expected, as TAN conversion to nitrate, and subsequent plant uptake, is key in an aquaponic system. Refer to the following narrative for additional discussion on TAN differentials observed and treatment hydraulic retention durations.

Although nitrification is occurring, the water exchange rate prevents a large TAN differential between the fish tank and PT3. Water treatment duration is a function of pump selection and corresponding tank hydraulic retention times (HRT). With the pilot study's established baseline water treatment (bio-filter + plant tank) HRT, it is advisable for the proposed facility to maintain an equal or greater HRT. Table 4.2 compares pilot study and proposed facility HRT values. With a pilot study fish tank HRT of 0.8 hours (200 gal / 250 gph pump), the same proposed study fish tank HRT is assumed for comparison. The pilot study bio-filter and plant tank volumes are 40 gallons (40 gal / 250 gph = 0.16 hr) and 290 gallons (290 gal / 250 gph = 1.2 hr), respectively. The proposed facility construction drawings show a 7,000 gallon fish tank. An 8,750 gph pump is required to achieve a 0.8 hr HRT. Assuming an eight gallon per pound density and the corresponding nine required plant tanks (see Table 4.4 in Section 4.1.3), the proposed facility bio-filter and plant tank volumes are 700 gallons (700 gal / 8750 gph = 0.08 hr) and 16,157 gallons (16,157 gal / 8750 gph = 1.9 hr), respectively.

TANK	PILOT STUDY HRT	PROPOSED FACILITY HRT
Fish	0.8 hr	0.8 hr
Bio-Filter	0.16 hr	0.08 hr
Plant	1.2 hr	1.9 hr

Table 4.2 Water Treatment HRT: Pilot Study vs. Proposed Facility

In reviewing design comparables, the proposed facility provides a longer water treatment HRT. A longer HRT achieves increased nitrification prior to fish tank recirculation.

4.1.2 Plant/Tilapia Ratio

Plant/tilapia ratio is dependent on the amount of feed introduced into the system daily. If food is restricted, fish waste quantity will be less than that on a higher intake diet. Waste quantity relates directly to the amount of TAN produced. Therefore, plant/tilapia ratios must be based on feeding rates. With the maximum healthy TAN level identified to be 3 mg/L, the primary pilot study's average TAN level of 2 mg/L provided a factor of safety in proposed facility design.

Referring back to Figure 4.3, data collected indicates the system's capability in maintaining TAN values below 2 mg/L for varied feeding rates encountered with 10.8 lb total tilapia mass (average total fish mass in system from Day 1 to Day 38). Two distinct feeding rates occurred during the primary study. The introduction of aeration was the delineating factor, with increased feeding a direct result of increased dissolved oxygen levels. Pre-aeration, tilapia were fed 0.01-0.03 kg (0.022-0.066 lb) feed, two to three times daily. Post-aeration, tilapia intake was 0.02-0.04 kg (0.044-0.088 lb) feed, two to three times daily. For design calculations, average pre- and post-aeration rates used are 0.110 lb/day (0.044 lb feed x 3 times daily) and 0.165 lb/day (0.066 lb feed x 3 times daily), respectively. For 10.8 lbs tilapia, this equates to daily feed allowances at 1% (0.110 lb feed/10.8 lbs fish) and 1.5% (0.165 lb feed/10.8 lbs fish) of fish weight. In comparing to Table 2.3 Tilapia Daily Feed Allowance, fish larger than 100 grams should intake 1.5-2.5% of their weight. With the pre-aeration percentage below the optimum range, the importance of submerged aeration is re-emphasized as critical to optimum feeding.

Discussed in the preceding section, contributing plant area varied with number of tanks and plant maturity. The assumed linear relationship between plant foliage cover and nutrient uptake, arguably an overly simplistic representation of diverse uptake quantities in a variety of plant species, acknowledged that mature plants uptake greater nutrients and allowed for a base plant/tilapia ratio to be established for the first facility. Note that this approach was consistent with current aquaponic studies and established relationships between nutrient input (i.e. fish feed quantity) and planting area.

Between Day 14 and Day 38, the minimum total contributing plant area was identified to be 6.3 ft² from the circular tank (50% of maximum capacity) and 5.0 ft² from each of the two rectangular tanks (67% of maximum capacity). As the plants matured toward Day 38, the maximum plant area was identified to be 8.4 ft² from the circular tank (67% of maximum capacity) and 7.5 ft² from each of the two rectangular tanks (full capacity). In summary, total plant area ranged between 16.3 and 23.4 ft². These values are used in the following Table 4.3.

With the relationship between plant area and fish feed identified, the analysis is taken a step further for facility design. The required plant area can be equated to fish mass if an average feeding rate is selected. Table 4.3 below assumes that the average body weight fraction of feed per day is 2% for tilapia larger than 100 grams (see Chapter 2, Table 2.3). Columns (a) and (b) indicate the calculated daily feeding mass and planting area range, respectively, for the pilot study. Column (c) is simply the pilot study's feed/ plant area ratio, dependent on plant maturity. Column (d) shows the corresponding range of plant/tilapia ratios in consideration. The following example calculation, using the post-aeration feeding rate and 19.8 ft² planting area, illustrates how the table's plant/tilapia ratios are obtained for a 2% daily feeding allowance:

$$\frac{0.02 \text{ lb feed}}{1 \text{ lb tilapia}} \times \frac{\text{ft}^2 \text{ plants}}{0.0083 \text{ lb feed}} = \frac{2.4 \text{ ft}^2 \text{ plants}}{\text{lb tilapia}}$$

(a)	(b)	(c)	(d)
Pilot Study Daily Feed (lb)	Planting Area(ft ²)	Feed (lb)/Plants (ft ²)	Plants (ft ²)/tilapia (lb)
0.110	23.4	4.7x10 ⁻³	4.3
	19.8	5.6x10 ⁻³	3.6
	16.3	6.7x10 ⁻³	3.0
0.165	23.4	7.1x10 ⁻³	2.8
	19.8	8.3x10 ⁻³	2.4
	16.3	1.0x10 ⁻³	2.0

Table 4.3 Primary Study Plant/Tilapia Ratios

After review and consideration of the data, a plant/tilapia ratio of 2.5 ft²/lb is selected for facility design. The following provides rationale and support for the selected ratio:

1. The maximum planting area pre-aeration ratio is disregarded for the fact that plant maturity was lowest at study start-up. Similarly, the lowest planting area post-aeration ratio is also deemed inaccurate.
2. A system's fish population will be of varying size at any given time in the proposed facility. Grow-out will be staggered, meaning that portions of the fish tank volume will contain fish much smaller than 100 grams. Fry and fingerling stocking will occur based on full-grown weight densities, and not overstocked when smaller and separated later. Therefore, even the lower range plant/tilapia ratios identified in the pilot study can be considered conservative (i.e. more than adequate planting area is provided for nitrogen removal) for the proposed facility.
3. The target 2 mg/L TAN level is conservative in light of a maximum healthy range of 3 mg/L. However, increased feeding associated with submerged aeration will likely reduce, and possibly exceed, the 1 mg/L difference.
4. The pilot study contained limited durations of stable data collection. With the goal of providing the most economical design for maximum tilapia production, the lowest reasonable plant/tilapia ratio is desired for the first facility. The pilot study data supports the preliminary conclusion that 2.50 ft²/lb is a viable simplified aquaponic design ratio.
5. The plant/tilapia ratio can be field adjusted during facility implementation through staged construction and routine water quality monitoring. No risk exists if in-field observed conditions necessitate a modification.

Although not critical to proposed facility implementation, it is a point of interest to compare the simplified pilot study's feeding rates with those published for UVI facilities. As discussed in Chapter 2, UVI facilities advertise a range of 60 to 100 grams feed per square meter of planting area (Rakocy *et. al.*, 2006). Converting the pilot study's 0.00555-0.00832 lb/ft² feeding rate to metric units, a range of 27 to 41 g/m² is obtained. Comparing average values of 80 g/m² (UVI) and 34 g/m² (pilot study), the preliminary conclusion is that the

simplified design requires 2.4 times more planting area than that required by a more complex mechanical design. Although data collected during the first facility's implementation will provide a more conclusive comparison, common sense dictates that a system with more advanced sedimentation and filtering prior to plant tank circulation requires less vegetative area.

4.1.3 Proposed Facility Design

The proposed facility will have multiple identical systems. Similar to the pilot study, each system will contain a fish tank, bio-filter, and plant tanks.

The objective of the proposed facility's phase one implementation is to provide one protein meal a month for 400 children. Although not quantified in this study, the vegetables produced will also provide nutrients and vitamins typically lacking in local diets.

With the ratio of 2.5 square feet of plant area per pound of tilapia, Table 4.4 establishes tilapia count, planting area, and required number of systems for various densities and feed sources. The following list identifies all parameters considered:

1. Each system contains 7,000 gallons (26,500 L) of fish tank
2. Tilapia harvest weight is 2.2 lbs (1 kg)
3. Target tilapia densities range from 12 gal/lb to 8 gal/lb
4. Initial goal is to provide one protein meal a month for 400 children
5. Each tilapia will provide a one-meal protein portion for four children
6. Two and one-half square feet of planting area supports one pound of fish (fed at 2% body weight daily allowance)
7. The food conversion ratio is 1.5
8. A 20% savings is achieved if the facility produces its own fish feed (refer to Section 4.3.5 for details on feed composition and savings determination)
9. With purchased feed, approximately 37% of fish produced must be sold to cover feed costs. With self-made feed, approximately 30% of fish produced must be sold to cover feed production. The required market fish are in addition to the 100 fish/month required to feed the schoolchildren. (Refer to Section 4.3.5)

Tilapia Density gal/lb (L/kg)	Fish per system	Plant area ft ² (m ²) per system	No. 4'x60' (1.22m x 18.3m) planting tanks	Purchased Feed		Self-Produced Feed	
				Non-Market Fish/System (63%)	No. of Systems	Non-Market Fish/System (70%)	No. of Systems
12 (100)	265	1458 (136)	6.1	167	7.2	186	6.5
8 (67)	400	2200 (204)	9.1	252	4.8	280	4.3
5 (42)	635	3493 (325)	14.6	400	3.0	445	2.7
3 (25)	1060	5830 (542)	24.3	668	1.8	742	1.6

Table 4.4 Proposed Facility Sizing for Various Tilapia Densities (3 to 12 gal/lb)

During facility construction and initial start-up, the feed will be purchased. The feed production process will be fully investigated to verify the accuracy of base assumptions and information gathered during the coordination trip. In addition, the facility will be jeopardized if the local feed supplier has machinery failure, or stops production.

At start-up, initial target density will be eight to twelve gallons per pound. Maximum density considered is five gallons per pound. Although originally thought reasonable, the three gallons per pound density presents unacceptable risk in light of the power outage experienced during the pilot study. Since the proposed facility density selections, design assumptions, and associated risks contain subjective elements, final operating densities will be adjusted during in-field implementation.

4.1.4 Proposed Facility Water Balance

A water balance was completed to estimate required well flow. The water balance included evaporation, transpiration, tank wasting (for cleaning), and rainfall. Evaporation

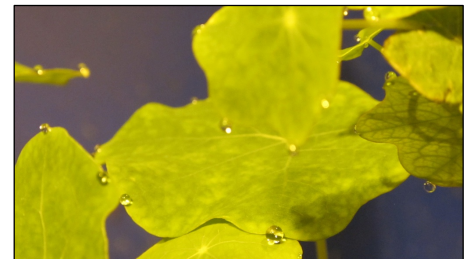

Figure 4.12 Pilot Study Transpiration

loss will occur in the proposed facility’s open surface fish tanks, while transpiration loss is relevant to the plant tanks. Transpiration is the loss of water through plant leaf stomata, a process that occurs to control plant leaf temperatures (Wintgens, 2009). Figure 4.12 illustrates pilot study nighttime transpiration. The photos have a yellowish hue because HPS lamps provided lighting.

A Biological and Agricultural Engineering (BAE) senior project team, consisting of undergraduate students Allie Archer, Emily Tummons, and Alan Winter, greatly contributed to the water balance effort by analyzing and selecting calculation methods, as well as computing initial values relevant to Gulu, Uganda. The BAE team compiled a report discussing their findings in December 2010, and also completed a supplemental analysis during the Spring 2011 school semester. Meyer's formula based on Dalton's Law was selected for evaporation calculation, and Penman's Method was utilized for transpiration. Note that Penman's method is appropriate for evapotranspiration, which includes plant leaf water loss as well as water vapor removal from surrounding surfaces (i.e. soil evaporation). In the case of the proposed facility's soilless plant tanks, the large majority of water loss will only be through plant leaves. Therefore, the term transpiration is used in this report to indicate plant tank water loss.

The BAE team's original and supplemental report results are referenced in this section, with the following supplemental analysis deliverables included in Appendix G:

1. Directions for Penman Excel Calculator (spreadsheet calculator provided for infield adjustments during actual facility implementation)
2. Penman Excel Calculator Spreadsheet Print-Out
3. Penman Calculator Confidence Interval Analysis (model calibrated using KSU Agronomy weather model for Manhattan, KS)
4. Compilation of Evaporation and Transpiration Equations Considered during BAE Team Analysis

Meyer's open surface water evaporation equation considers air saturation vapor pressure, actual vapor pressure, average wind velocity at a height of 25 ft, and a water body coefficient (11 for small lakes and reservoirs and 15 for shallow ponds). For 25 ft high wind speeds of 3 to 5 miles an hour, the BAE team calculated an average open surface water evaporation rate of 2.06 mm/day (Archer *et. al.*, 2010). For Table 4.5 evaporation estimates, a rate of 3.81 mm/day is utilized. The BAE team's recommended calculation method and input values were utilized in this study, with the only difference being that the 25 ft wind speed was increased to 15 mph. For comparison with published data for Uganda, note that Lake Victoria and Lake Albert surface evaporation rates are 4.38 mm/day and 4.36 mm/day, respectively

(Gupta, 2007). The proposed facility fish tanks will be covered with a hardened roof structure to reduce photosynthesis. As such, tank evaporation rates should be less than those experienced on uncovered surfaces. The 3.81 mm/day rate is considered an acceptable initial estimate. The BAE team provided the excellent recommendation of performing a PAN evaporation test infield to verify estimates.

The Penman method considers a number of variables, with major inputs being solar radiation, vapor pressure, wind speed, and mean temperature. The BAE team initially calculated an average transpiration rate of 4.10 mm/day (Archer *et. al.*, 2010). During the supplemental analysis, the Penman Excel Spreadsheet calculator was refined for ease of use and calibrated with Manhattan, KS data. The revised Uganda transpiration rate varied from 4.45 mm/day to 5.61 mm/day, depending on the value selected for the heat flux density variable. In addition, the revised calculations included a 1.15 factor to account for hydroponic increased water uptake relative to traditional soil culture.

Transpiration rates consider plant coverage area. The value used for Table 4.5 transpiration estimates is 4.10 mm/day. The refined spreadsheet will be utilized infield, with the original value considered conservative for preliminary estimates. Plant growth will be staggered to allow for year-round harvest, resulting in varying plant maturity and plant tank raft coverage. In addition, relative water uptake increase for hydroponic systems is unknown.

For comparison with published data, the Ugandan National Environment Agency (unknown) reports monthly evaporation rates ranging from 125 to 200 mm/day. This equates to 4.17 to 6.67 mm/day. Without differentiation of open surface water evaporation and evapotranspiration, it is assumed that this range encompasses both types of evaporation. Using similar terminology, Allan (2004) cites a minimum evaporation rate of 3.84 mm/day at the Sudan/Ugandan border.

Wintgens (2009) cites 4 to 5 mm/day Penman calculated evapotranspiration rates for tropical climates. This range is based on complete ground coverage. Additional discussion is due the fact that 4 to 5 mm/day is considered potential evapotranspiration. Actual evapotranspiration rate is potential evapotranspiration multiplied by a coefficient typically less than one. Different for varying crops and conditions, the coefficient typically represents reduced evapotranspiration resulting from water stress. In traditional soil culture, plant stomata close in response to reduced water availability in the soil or air. Production of the

phytohormone abscisic acid, as well as electrical and hydraulic signals, triggers stomata closure in reduced moisture conditions. The result is reduced transpiration water loss. (Chapin and Thijs, 2008; Pessaraki, 1999; Wintgens, 2009)

In the case of a hydroponic system with unlimited water supply, the crop coefficient is unknown. Water loss reduction potentially may occur due to adjacent plant interactions. An example is if one crop provides a shade canopy, and hence reduced evaporative demand, for adjacent plantings (Pessaraki, 1999). It is theorized that, if a crop coefficient is applicable, it will be greater than that for equivalent soil culture. For this study's estimates, no crop coefficient is applied to potential transpiration values.

Utilizing the identified 3.81 mm/day evaporation (fish tank) and 4.10 mm/day transpiration (plant tank) rates, Table 4.5 estimates total weekly water usage for 12 to 3 gal/lb (100 to 25 L/kg) tilapia densities. The rates are multiplied by the area of the respective tanks. In the case of transpiration, the calculated values assume that 50% of the plants are fully mature (i.e. raft area completely covered) and the remaining plant coverage is 50% of the available raft area. Tank cleaning is calculated at 15 gallons per system fish tank/bio-filter every two days, and five gallons per system plant tank every week.

Tilapia Density gal/lb (L/kg)	Feed Purchased				Feed Self-Produced			
	Transpiration gal/wk (L/wk)	Evaporation gal/wk (L/wk)	Tank Cleaning gal/wk (L/wk)	Total Water Usage gal/wk (L/wk)	Transpiration gal/wk (L/wk)	Evaporation gal/wk (L/wk)	Tank Cleaning gal/wk (L/wk)	Total Water Usage gal/wk (L/wk)
12 (100)	5577 (21,082)	1680 (6350)	598 (2263)	7856 (29,695)	5035 (19,032)	1517 (5733)	540 (2044)	7092 (26,809)
8 (67)	5547 (20,966)	1120 (4233)	471 (1783)	7138 (26,982)	4969 (18,782)	1003 (3793)	422 (1597)	6395 (24,172)
5 (42)	5562 (21,024)	700 (2646)	377 (1427)	6639 (25,097)	5006 (18,922)	630 (2382)	340 (1287)	5976 (22,591)
3 (25)	5554 (20,995)	420 (1588)	414 (1188)	6289 (23,771)	4937 (18,662)	373 (1411)	668 (2528)	5979 (22,601)

Table 4.5 Proposed Facility: Total Water Usage for Various Tilapia Densities (12 to 3 gal/lb)

Considering rainfall, Tables 4.6 through 4.9 provide monthly water balances for 12 to 3 gal/lb tilapia densities. The researcher obtained the rainfall data in 2007 from a small weather station in Gulu, Uganda. Records were hand-written and not published online.

Negative values in Tables 4.6 through 4.9 indicate that rainfall exceeds re-supply demand during that month.

Month	Rain (mm/mo)	Feed Purchased			Feed Self-Produced			
		Total Water Usage L/wk	Rainwater Volume L/wk	Req'd Well Capacity L/wk	Total Water Usage L/wk	Rainwater Volume L/wk	Req'd Well Capacity L/wk	
January	23	29,695	7,010	22,685	26,809	6,328	20,481	
February	18	29,695	5,486	24,209	26,809	4,953	21,856	
March	109	29,695	33,221	-3,526	26,809	29,991	-3,182	
April	117	29,695	35,659	-5,964	26,809	32,192	-5,383	
May	112	29,695	34,135	-4,440	26,809	30,816	-4,007	
June	71	29,695	21,639	8,056	26,809	19,535	7,274	
July	132	29,695	40,230	-10,535	26,809	36,319	-9,510	
August	147	29,695	44,802	-15,107	26,809	40,446	-13,637	
September	150	29,695	45,716	-16,021	26,809	41,272	-14,463	
October	122	29,695	37,183	-7,488	26,809	33,568	-6,759	
November	74	29,695	22,553	7,142	26,809	20,361	6,448	
December	64	29,695	19,506	10,189	26,809	17,609	9,200	
Balance:				9,200	Balance: 8,318			

Table 4.6 Proposed Facility: Required Well Supply for 12 gal/lb Tilapia Density Facility

Month	Rain (mm/mo)	Feed Purchased			Feed Self-Produced			
		Total Water Usage L/wk	Rainwater Volume L/wk	Req'd Well Capacity L/wk	Total Water Usage L/wk	Rainwater Volume L/wk	Req'd Well Capacity L/wk	
January	23	26,982	6,521	20,461	24,172	5,842	18,330	
February	18	26,982	5,104	21,878	24,172	4,572	19,600	
March	109	26,982	30,905	-3,923	24,172	27,686	-3,514	
April	117	26,982	33,174	-6,192	24,172	29,718	-5,546	
May	112	26,982	31,756	-4,774	24,172	28,448	-4,276	
June	71	26,982	20,131	6,851	24,172	18,034	6,138	
July	132	26,982	37,427	-10,445	24,172	33,528	-9,356	
August	147	26,982	41,680	-14,698	24,172	37,338	-13,166	
September	150	26,982	42,530	-15,548	24,172	38,100	-13,928	
October	122	26,982	34,591	-7,609	24,172	30,988	-6,816	
November	74	26,982	20,982	6,000	24,172	18,796	5,376	
December	64	26,982	18,146	8,836	24,172	16,256	7,916	
Balance:				836	Balance: 757			

Table 4.7 Proposed Facility: Required Well Supply for 8 gal/lb Tilapia Density Facility

Month	Rain (mm/mo)	Feed Purchased			Feed Self-Produced			
		Total Water Usage L/wk	Rainwater Volume L/wk	Req'd Well Capacity L/wk	Total Water Usage L/wk	Rainwater Volume L/wk	Req'd Well Capacity L/wk	
January	23	25,097	6,193	18,904	22,591	5,574	17,017	
February	18	25,097	4,847	20,250	22,591	4,362	18,229	
March	109	25,097	29,352	-4,255	22,591	26,417	-3,826	
April	117	25,097	31,506	-6,409	22,591	28,355	-5,764	
May	112	25,097	30,160	-5,063	22,591	27,144	-4,553	
June	71	25,097	19,119	5,978	22,591	17,207	5,384	
July	132	25,097	35,545	-10,448	22,591	31,991	-9,400	
August	147	25,097	39,584	-14,487	22,591	35,626	-13,035	
September	150	25,097	40,392	-15,295	22,591	36,353	-13,762	
October	122	25,097	32,852	-7,755	22,591	29,567	-6,976	
November	74	25,097	19,927	5,170	22,591	17,934	4,657	
December	64	25,097	17,234	7,863	22,591	15,511	7,080	
Balance:				-5,548	Balance: -4,948			

Table 4.8 Proposed Facility: Required Well Supply for 5 gal/lb Tilapia Density Facility

Month	Rain (mm/mo)	Feed Purchased			Feed Self-Produced			
		Total Water Usage L/wk	Rainwater Volume L/wk	Req'd Well Capacity L/wk	Total Water Usage L/wk	Rainwater Volume L/wk	Req'd Well Capacity L/wk	
January	23	23,771	5,957	17,814	22,601	5,295	17,306	
February	18	23,771	4,662	19,109	22,601	4,144	18,457	
March	109	23,771	28,231	-4,460	22,601	25,094	-2,493	
April	117	23,771	30,303	-6,532	22,601	26,936	-4,335	
May	112	23,771	29,008	-5,237	22,601	25,785	-3,184	
June	71	23,771	18,389	5,382	22,601	16,346	6,255	
July	132	23,771	34,188	-10,417	22,601	30,389	-7,788	
August	147	23,771	38,073	-14,302	22,601	33,842	-11,241	
September	150	23,771	38,850	-15,079	22,601	34,533	-11,932	
October	122	23,771	31,598	-7,827	22,601	28,087	-5,486	
November	74	23,771	19,166	4,605	22,601	17,036	5,565	
December	64	23,771	16,576	7,195	22,601	14,734	7,867	
			Balance:	-9,746	Balance:			8,991

Table 4.9 Proposed Facility: Required Well Supply for 3 gal/lb Tilapia Density Facility

Table 4.10 identifies maximum weekly well demand and rainfall surplus for the various tilapia densities and feed sources. In addition, the yearly water balance demonstrates the advantage of installing a water storage system. Storing excess rainwater during wet months will reduce well demand during dry months.

Tilapia Density gal/lb (L/kg)	Purchased Feed			Feed Self-Produced		
	Max. Well Flow Required gal/wk (L/wk)	Max. Rainwater Surplus gal/wk (L/wk)	Balanced Well Flow Requirement gal/yr (L/yr)	Max. Well Flow Required gal/wk (L/wk)	Max. Rainwater Surplus gal/wk (L/wk)	Balanced Well Flow Requirement gal/yr (L/yr)
12 (100)	6405 (24,209)	-4238 (-16,021)	2434 (9200)	5782 (21,856)	-3826 (-14,463)	2200 (8318)
8 (67)	5788 (21,878)	-4113 (-15,548)	221 (836)	5185 (19,600)	-3685 (-13,928)	200 (757)
5 (42)	5357 (20,250)	-4046 (-15,295)	-1468 (-5548)	4822 (18,229)	-3641 (-13,762)	-1309 (-4948)
3 (25)	5055 (19,109)	-3989 (-15,079)	-2578 (-9746)	4883 (18,457)	-3157 (-11,932)	2379 (8991)

Table 4.10 Proposed Facility: Yearly Water Balance (12 to 3 gal/lb Tilapia Densities)

4.1.5 Planting Selections

Plants included in the primary study were cucumber, tomatoes, peas, okra, eggplant, broccoli, cauliflower, cabbage and lettuce. The cucumber, tomatoes, and peas (see Figure 4.13) began to reach maturity before study commencement, and continued to be harvested during the primary study. Okra and eggplant, introduced into an aquaponic system prior to primary study commencement, reached maturity during the study. The broccoli, cauliflower, cabbage and lettuce were transplanted at study



Figure 4.13 Primary Study Pea Pods on the Vine

commencement (see Figure 4.6 in Section 4.1.1), and did not reach maturity until after the study ended.

Counterclockwise from upper left, Figure 4.14 illustrates cucumber, tomato, pea, and okra plants. All of these crops grew well in the aquaponic system. Cooler fall temperatures resulted in lower maximum greenhouse temperatures. While still very warm within the greenhouse, the excessive temperatures (above 90°-100°F) were not present to inhibit budding and fruit development.



Figure 4.14 Primary Study Harvested Plant Crops: Cucumbers, Tomatoes, Peas and Okra

Figure 4.15 illustrates vegetables that reached full maturity after study termination. Clockwise from upper left, cabbage, broccoli, okra, and cauliflower are pictured. When outside temperatures neared freezing, frost covers were placed over the plant tanks at night to

hold water heat within the system and prevent frost burn. Although the cabbage sprouted profusely, the broccoli, okra, and cauliflower still experienced stunted growth during extreme cold. Lettuce is not pictured, as it quickly wilted and displayed brown leaf discoloring despite frost covers. Note that broccoli, okra, and cauliflower, and lettuce are reported to successfully grow aquaponically in more favorable temperatures.



**Figure 4.15
Primary Study
Cabbage,
Broccoli,
Cauliflower
and Eggplant**

As discussed in Section 3.1.5, HPS lighting was used to compensate for reduced natural sunlight. The plants appeared to respond well to the selected lamps. The HPS lamps were run six to 12 hours a day, depending on the wane in natural sunlight. Figure 4.16 illustrates the facility at night under the yellow glow of the HPS lights.



Figure 4.16 Primary Study Under Nighttime Glow of HPS Lamps

4.2 Secondary Pilot Study

The objective of the secondary pilot study was to provide hands-on experience, allowing the researcher to consider all aspects of facility design and operation through physical construction and daily maintenance. Allowing for system operation familiarization, the secondary study also realized the efficiency of recommended system designs. As a result, the proposed facility incorporates optimal simplified design features.

The following list identifies key findings, with supporting narrative provided in Sections 4.2.1 through 4.2.4.

1. Use gravity weir flow and one water pump for efficient water recirculation
2. Use sloped tank slabs and small diameter siphon tubing for water conservation during tank cleaning
3. For tilapia breeding control, maintain bottom clearance with raised fishnets; fishnets also aid in size separation and easy harvesting
4. Use field meter with probes for efficient water quality testing; drop test kits are time-consuming and produce toxic chemical solutions requiring disposal

5. Submerged aeration is an absolute requirement for optimal plant and fish growth, even at reduced densities
6. Consider the replacement of commercially produced plant tank materials (i.e. polystyrene foam, plastic web pots, clay balls) with woven matting from locally available natural materials
7. Provide aeration with perforated flexible tubing, eliminating need for commercially produced air stones

4.2.1 Facility Start-Up: Water Quality Data Analysis

Discussed in Sections 2.2 and 2.3, establishment of nitrifying bacteria is reflected in TAN ($\text{NH}_3 + \text{NH}_4^+$), nitrite (NO_2^-), and nitrate (NO_3^-) concentrations. A peak and fall in TAN concentration represents the establishment of nitrosomonas bacteria that converts $\text{NH}_3/\text{NH}_4^+$ to NO_2^- . Similarly, a peak and fall in NO_2^- concentration represents the establishment of nitrobacter bacteria converting NO_2^- to NO_3^- .

As discussed in Section 3.2.1, the drop test kit methodology proved a definite handicap to gathering complete data records during the secondary study. Despite shortcomings, Figures 4.17 to 4.20 provide an initial look at nitrogen cycle trends in a simplified aquaponic system. Discussion follows.

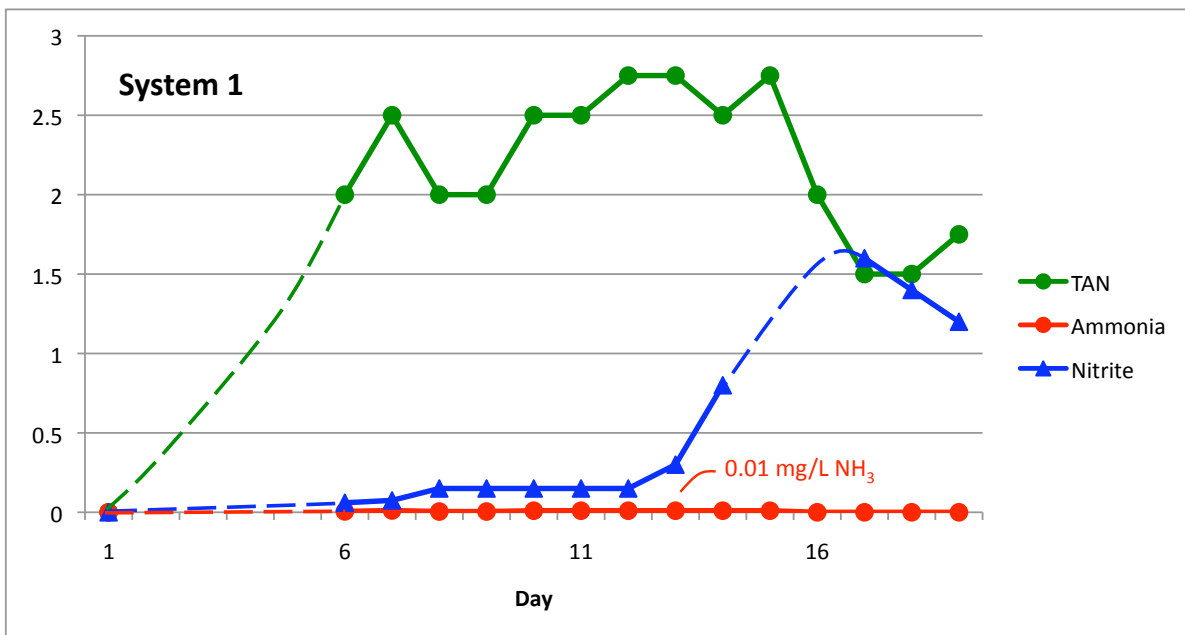

Figure 4.17 Pilot Study System 1: Start-Up Nitrogen Cycle

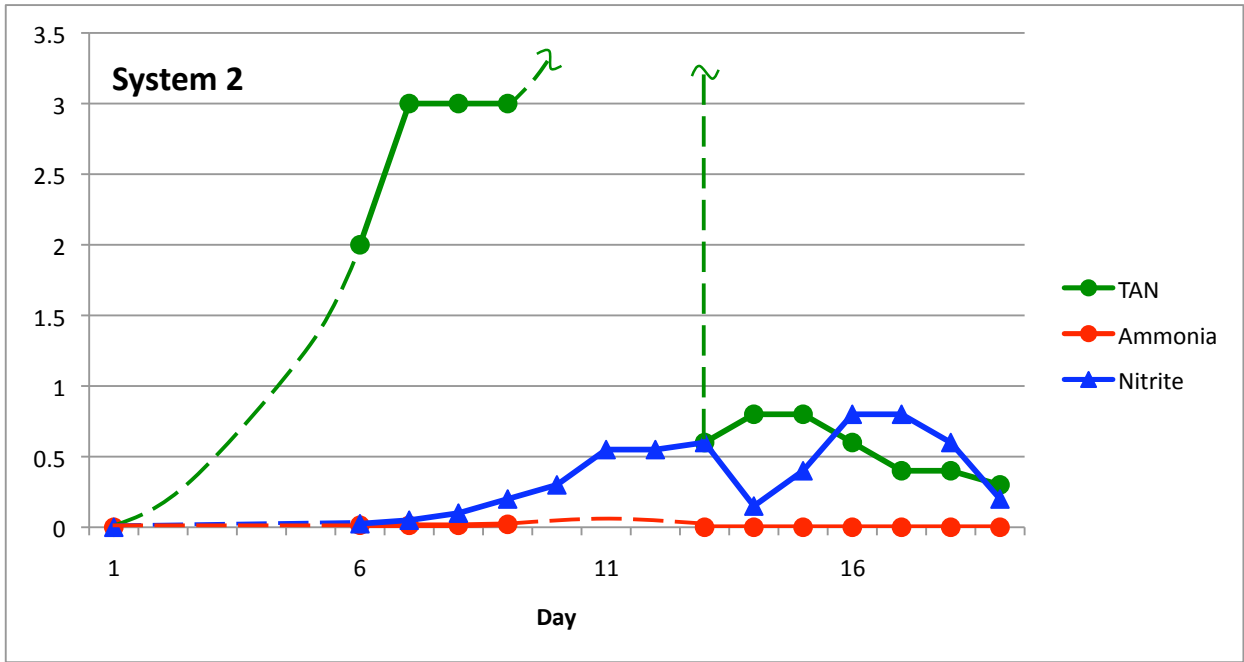

Figure 4.18 Pilot Study System 2: Start-Up Nitrogen Cycle

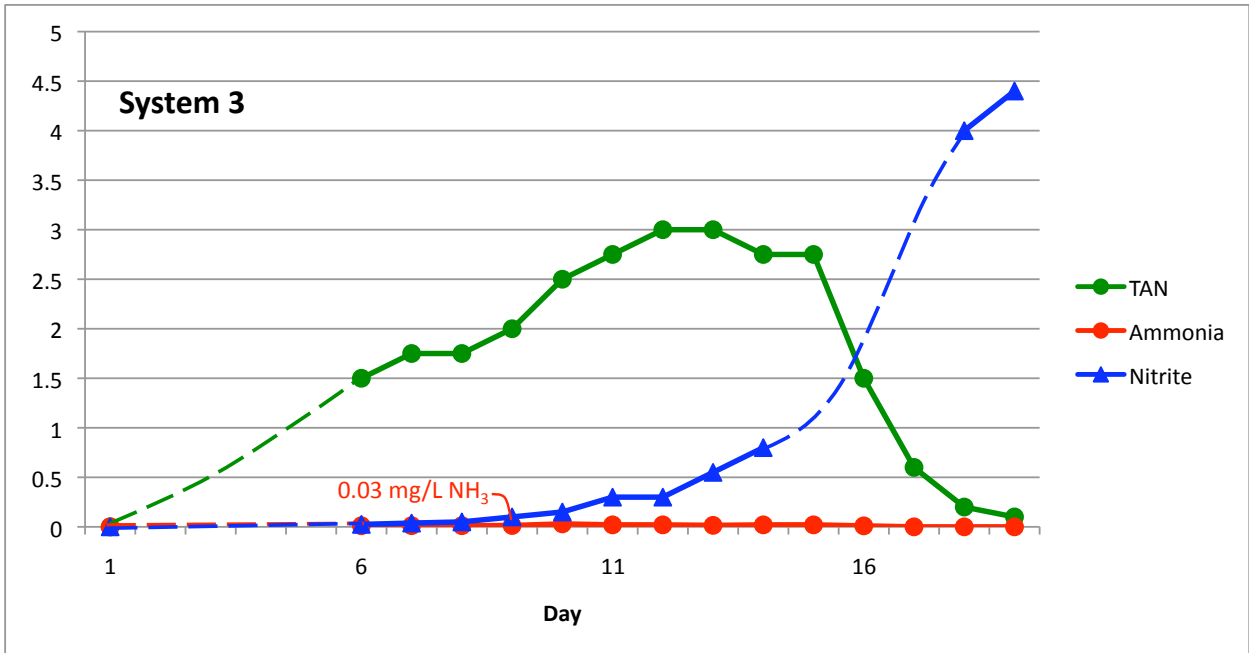

Figure 4.19 Pilot Study System 3: Start-Up Nitrogen Cycle

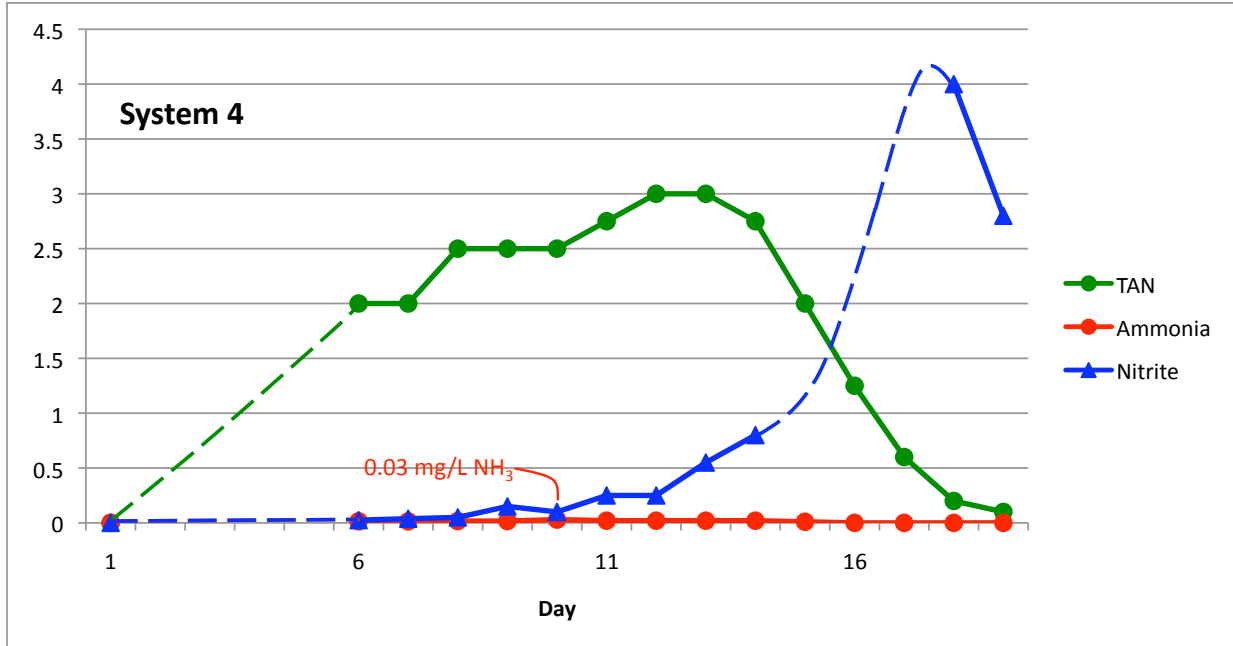

Figure 4.20 Pilot Study System 4: Start-Up Nitrogen Cycle

Regarding trends observed:

1. All three systems neared the established 3.0 mg/L maximum TAN concentration. System 2 exceeded the limit an unknown amount, as the ability to perform a dilution series was not yet realized. The vertical dashed line on day 13 represents a system water change to alleviate heightened TAN levels. Note that nitrite concentration dropped with the water change, but began increasing immediately over the following days. This indicates that nitrosomonas bacteria living within the bio-media, or on polystyrene foam and tank wall surfaces, survived the water change.
2. Peak NH_3 concentrations did not exceed the established 0.06 mg/L limit. Due to graph scales, the peak NH_3 concentrations are labeled. Note that any System 2 NH_3 concentrations corresponding to unknown TAN levels are also unknown.
3. Peak NO_2^- concentrations exceeded the identified 1.0 mg/L limit in Systems 1, 3 and 4. Note that System 1 and 2 NO_2^- concentrations did not exceed TAN. However, System 3 and 4 NO_2^- concentrations spiked above peak TAN levels and the identified 1.0 mg/L limit. The good news is that fish mortalities were not experienced as a result of the various water quality levels. The inconvenient

reality is that a definitive explanation for the various trends is not achievable with the data gathered. To begin to establish the expected nitrogen cycle trend for an aquaponic system, aquarium trends were researched. Various aquarium websites (not cited due to unknown validity) tend to indicate that the nitrite spike will be of greater magnitude and duration than the TAN spike. However, it cannot be assumed that aquarium nitrogen cycle trends equate directly to aquaponic systems, as filtration and maintenance (i.e. routine water changes) vary. A second consideration is pilot study extraneous conditions with potential to effect nitrifying bacteria behavior. All environmental factors were held constant during the study, with exception of direct sunlight exposure. Although immediately adjacent in the greenhouse, a tree in the center of the four systems potentially contributed to varied sunlight. System 2, located in the northeast corner, would have received less sunlight than the others. System 1 in the southeast corner would have received more sunlight than System 2, but less than 3 and 4. In turn, Systems 3 and 4 received the more intense afternoon summer sunlight. Nitrifying bacteria photoinhibition possibly occurred to varying degrees in the systems. Guerrero and Jones (1996) indicated that $\text{NH}_3/\text{NH}_4^+$ oxidizers were capable of a slow recovering after exposure to natural sunlight. In comparison, NO_2^- oxidizers did not recover after receiving the same exposure. Note that a cover was not placed on the bio-filter during initial stages, and the bio-filter tank was constructed of a semi-opaque white plastic. Sunlight exposure likely occurred in all systems. The extent is unknown. The following statement in italicized bold identifies the only valid conclusion at this time.

In order to obtain an accurate and reliable nitrogen cycling graph for a simplified aquaponic system, TAN, NO_2^- , and NO_3^- levels need to be measured daily for the duration of bacteria establishment. The field meter purchased for the primary study will make this physically feasible during proposed facility implementation.

With TAN levels reaching near 3 mg/L for all systems, the pilot study's initial fish density is considered the maximum desirable tilapia density when establishing system bacteria. Assuming an average fingerling weight of 20 grams, an upper stocking limit can be

inferred for any size fish tank in the proposed facility. Table 4.11 identifies the maximum number of fingerlings that can be introduced for a 7,000 gallon fish tank (see Appendix F: Revised Preliminary Construction Plans).

**Table 4.11 Tilapia
Fingerling Start-Up
Maximum Density Limit**

	PILOT STUDY	PROPOSED FACILITY
Tank Volume	200	7000
No. Start-Up Fingerlings	16	560
Density (gal/lb)	284	284

This limit is only applicable to a system in which bacteria is not yet established. When replacing harvested fish in an established system, the fingerling quantity will match the number of fish harvested, plus a percentage to account for grow-out mortalities.

4.2.2 Water Treatment Biological Process Indicators

Staff at the Junction City Wastewater Treatment Plant in Junction City, Kansas, microscopically viewed two pilot study water samples at their facility. Not intended for quantitative analysis, the goal was to identify bacterial activity similar to that found in domestic wastewater treatment.

In line with Section 2.3, a food chain exists within the described biological processes. Gerardi (2002) indicates that bacteria feeding on cBOD and nBOD serve as food for protozoa, a higher life form. Protozoa are further classified as amoebae, flagellates, or ciliates.

Due to microscope magnification limits, only the higher life forms were observed in the water samples. Figure 4.21 illustrates both desirable and undesirable microorganisms observed.

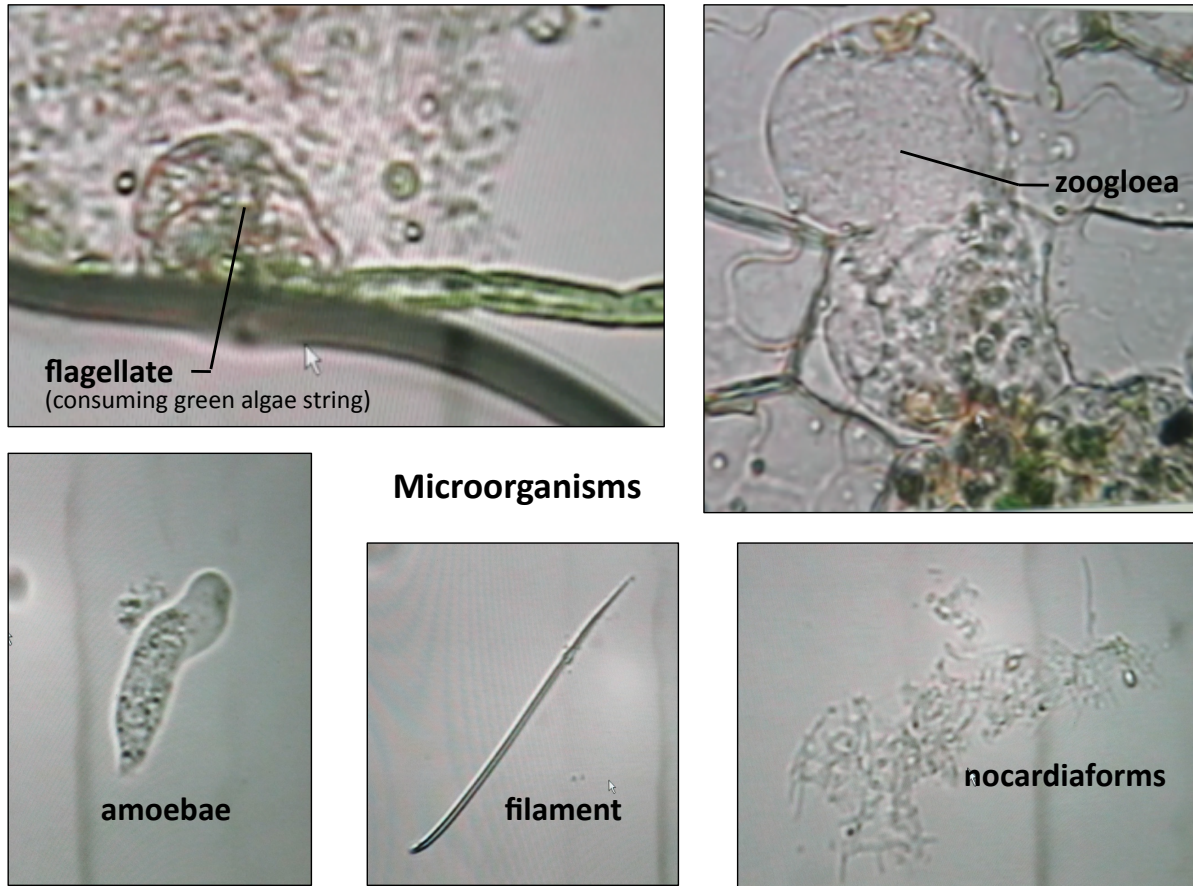

Figure 4.21 Pilot Study Microorganisms

Plant personnel concluded that the majority of microorganisms were favorable, indicative of an established and properly operating system. In Figure 4.21, the flagellate, zoogloea, and amoebae are all desired microorganisms. However, the filament and nocardiaforms are not. Plant personnel indicated that, although a few filamentous organisms are always present when dealing with wastewater, they are undesirable indicators of septicity. Nocardiaforms lead to an extensive foaming condition that prevents particle settling.

On a final note, Figure 4.22 illustrates duckweed growth in the pilot study systems. In the bio-filter shown, the many small green plants floating on the surface above the bio-media are duckweed. Discussed in Section 2.3, duckweed growth is indicative of nitrification.



Figure 4.22 Pilot Study Bio-Filter Duckweed Growth

4.2.3 Proposed Facility Design

The secondary study provided physical proof of design component and operational method efficiencies. Several key components were revised as a result. Table 4.12 identifies noteworthy changes and lessons learned. The narrative following the table details study experiences.

ITEM	FACILITY COMPONENT	PILOT STUDY ORIGINAL DESIGN	PROPOSED FACILITY
1	Water Circulation	Airlift	Water Pump
	Water Circulation	Siphons	Gravity Weir Flow
2	Tank Cleaning	Level Tank Floors	Sloped Tank Floors
	Tank Cleaning	3/4" Siphon Tubing	3/16" (or less) Siphon Tubing
3	Tilapia Breeding Control	Raised Tank Bottom Insets	Fish Nets
4	Water Quality Testing	Drop Test Kits	Field Meter/Probe
5	Plant Tank Materials	Polystyrene, Web Pots, Clay Balls	Woven Matting
6	Aeration	Airstones	Flexible Tubing with Multiple Pin-Sized Perforations

Table 4.12 Secondary Study: Simplified Design Facility Components

Item 1 - Water Circulation: Airlifts were initially utilized to elevate water from the plant tank to the fish tank. The air pump purchased, although a utility model, provided erratic flows that gurgled loudly. (Note: The same air pump, a Medo SL88, proved more than adequate for system aeration during the primary study.) In reviewing energy requirements, it was realized that using four water pumps (PondMaster 250) provided improved recirculation flows without additional energy expense. Water pumps were subsequently used for the secondary and primary studies, and will be used for the proposed facility's water circulation.

Siphons, the other water circulation component, allowed for flow between the fish tank and bio-filter and between the bio-filter and plant tank. Although successfully utilized for the study duration, it was quickly realized that gravity weir flow would reduce system malfunctions as well as routine operating activities. Even when siphon tube flow was properly established, air locks occurred when miniscule air bubbles in the water congregated in tubing over time. This required periodic re-starting of siphons. If not caught, malfunctioning siphons resulted in water back-up within the preceding tank. Another disadvantage to siphons was the growth of algae and filamentous bacteria inside tubing. Tube cleaning or tube addition was required to maintain equilibrium flow. Note that opaque tubing would reduce algal growth by eliminating photosynthesis, but not solve other maintenance issues. Figure 4.23 offers a comparison between the pilot study siphons and proposed facility weir flow through removed block sections.

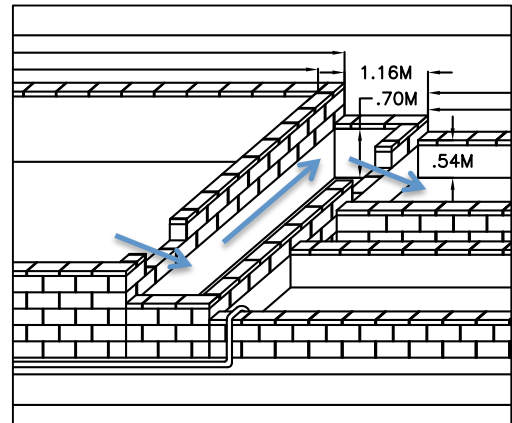

Figure 4.23 Water Circulation: Pilot Study Siphons vs. Proposed Facility Gravity Weir Flow

Item 2 – Tank Cleaning: The pilot study highlighted water circulation patterns and corresponding debris accumulation on tank bottoms. The pilot study fish tanks were level, and particles tended to throughout the bottom. Settled waste was siphoned from the fish tank

floor with flexible tubing. Although not a large issue in the smaller pilot study tanks, a sloped floor in the proposed facility will greatly reduce water use during wasting. Particles will travel down slope and congregate in low points designated for waste siphoning.

Regarding waste siphoning, water use was reduced with smaller diameter tubing. Larger diameter tubing resulted in a larger ratio of water to waste particles removed. A smaller diameter, still adequate for the passing of waste, allowed for a 75% reduction in water removal. This value is based on the fact that, with the 3/4-inch tubing, approximately two five-gallon buckets were filled to clean each fish tank. With the smaller diameter tubing, the same quantity of waste was removed while filling only half of a five-gallon bucket.

Item 3 – Tilapia Breeding Control: First discussed in Section 3.1.1 (Figure 3.7), raised bottom insets proved cumbersome and often ineffective at containing fish. Fishnets were quickly adopted. Fishnets were supported on fish tank rims with PVC piping (refer to Figures 3.5 and 3.13), with clearance provided between net and tank bottom. The method proved successful at containing fish and preventing fish egg incubation. Figure 4.24 depicts fish eggs that fell through the bottom inset mesh, as well as a Construction Drawing illustration (refer to Appendix F for complete plans) of how fishnets will be installed in the proposed facility.

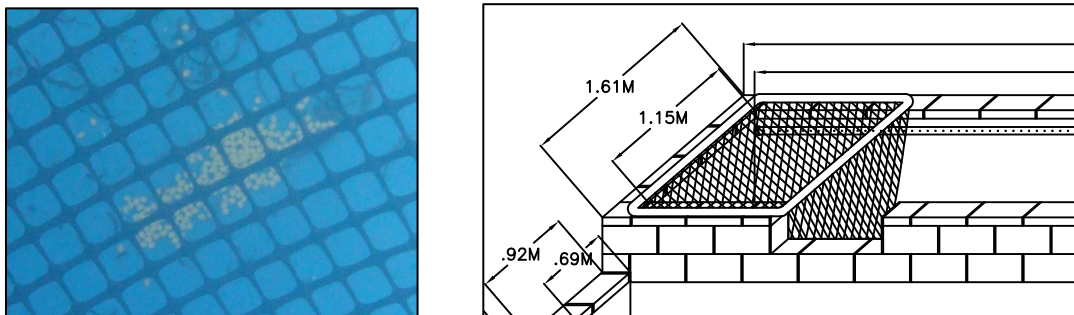

Figure 4.24 Breeding Control: Raised Bottom Fishnets

Item 4 – Water Quality Testing: Drop test kits proved ineffective and a handicap during the secondary study. Although less expensive than field meters with probe sensors, it was concluded that they are not intended for daily or even near-daily applications. Simply too

time prohibitive, the YSI Professional Plus meter was purchased for the primary study. This meter will also be used during proposed facility implementation.

Item 5 – Plant Tank Materials: The pilot study utilized commercially produced web pots, clay balls, and polystyrene foam to secure plants. A polystyrene foam supplier was located in Kampala, but costs are prohibitive for long-term use by rural farmers. Web pots and clay balls were not immediately located in-country, but are equally considered impractical. During proposed facility implementation, the use of woven natural materials (i.e. palm tree leaves, elephant grass, etc.) will be attempted. Woven products are common to the region. Use of these naturally renewable materials, in lieu of commercially produced raft materials, reduces operational costs and provides an element of familiarity.

Item 6 – Aeration: While aeration was addressed more in the primary study, it is included here as a consideration similar to Item 5 above. Air stones, aquarium valves, and aquarium sized diameter tubing will be hard to come by in northern Uganda, or any developing nation. An alternate aeration method is required. Larger diameter flexible tubing, similar to garden hose, will be purchased. It will be perforated with multiple pin-sized holes and secured underwater to serve as an aeration line.

4.2.4 Planting Selections

Discussed and illustrated in Section 3.1.3, tomato, basil, and oregano plants were introduced at system start-up. Zucchini, eggplant, cucumber, pea, buttercup squash, okra, and additional tomato were seeded and transplanted during the secondary study. Figure 4.25 illustrates newly transplanted okra and cucumber seedlings. Seeds were planted in rockwool or soil (see Figure 4.26) and watered with nutrient-packed fish tank water. It was noted that the seedlings appeared to grow faster when seeded in soil.



Figure 4.25 Newly Transplanted Okra and Cucumber Seedlings

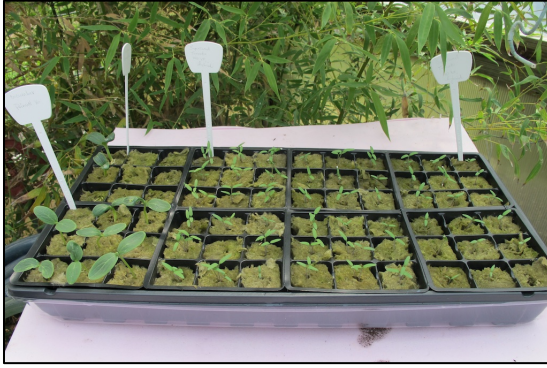

Figure 4.26 Plant Seeding: Rockwool and Soil Media

Some of the original and seeded plants flourished, while a couple did not do as well. Of the initially transplanted basil and oregano, both types of basil grew well. The oregano did not.

The tomatoes flourished and budded, as shown in Figure 4.27. However, in the extreme summer greenhouse temperatures near and above 90°F, the bud's pollen dried up and the flower fell off without producing fruit. Near the end of the secondary study, tomato fruits began to form. Improved tomato fruit budding was experienced during the cooler temperatures of the primary study. As indicated in Chapter 2, tomatoes are a common fruit to grow aquaponically.

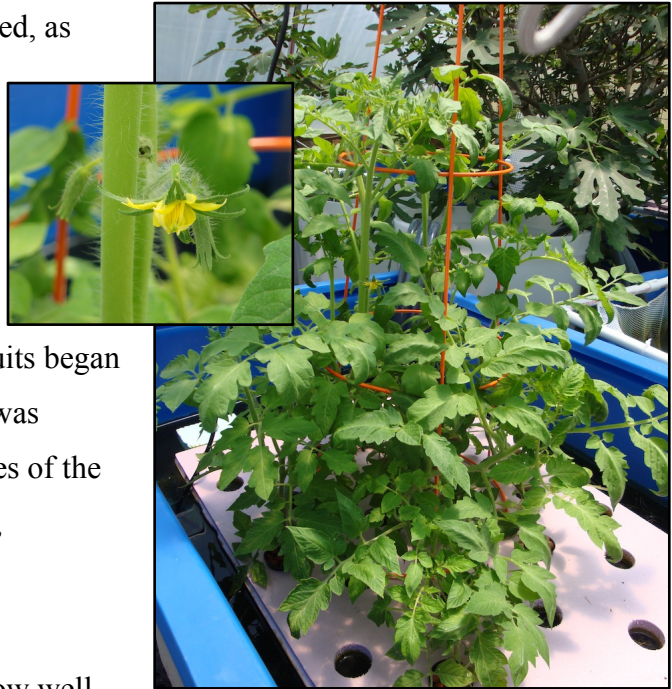

Figure 4.27 Secondary Study Tomato Plants

Cucumbers and peas proved to grow well in the aquaponic systems. The cucumbers grew exceptionally well. Figure 4.28 below shows a cucumber plant tank as the flowers began to bud, as well as junior cucumbers growing on the vine.



Figure 4.28 Secondary Study Cucumber Plant Growth and Budding



Although pea plants languished during warmer temperatures, they flourished with cooler fall temperatures (Figure 4.29). Refer to Section 4.1.5 to see photographs of both harvested cucumbers and peas.

Two plants that did not do well in the system were zucchini and buttercup squash. Both plants produced flowers and young fruits, which simply rotted and fell off the plant. Figure 4.30 illustrates the flowering zucchini and buttercup squash. Exact reasons for poor performance are not entirely known. It was conjectured that excessive greenhouse temperatures and/or humidity (capable of facilitating rot) contributed to plant failure. It is also possible that adjacent plantings inhibited growth.



Figure 4.29 Secondary Study Pea Pods on the Vine



Figure 4.30 Secondary Study Zucchini and Buttercup Squash Flower Blooms

The seeded okra and eggplant grew slower than other plants, fruiting during the primary study. Refer to Section 4.1.5.

4.3 In-Field Research

A trip to Uganda was completed in July 2010. The trip's purpose was to: 1) coordinate with the partnering in-field organization; 2) verify location and water supply of proposed facility's site; and 3) verify local material availability and cost.

The following list identifies key findings, with supporting narrative provided in sections 4.3.1 through 4.3.7.

1. Tank construction methods vary from western techniques
2. Concrete block sizes vary from assumed standard metric western equivalents
3. Tilapia fingerling breeding quality and control is likely not ascertainable pre-purchase. Standard disease prevention practices will be crucial.



Figure 4.31 Researcher Visiting Schoolchildren in Gulu, Uganda

4. Tilapia feed is available from a supplier local to Gulu, Uganda
5. Facility plant tank components commercially available in the U.S. can be replaced with locally available renewable materials
6. Locally familiar vegetables and greens include spinach, cabbage, tomatoes, peppers, eggplant, okra, beans, cucumber, broccoli, and cauliflower
7. Solar energy will power the proposed facility

4.3.1 Introductory Manual and Preliminary Construction Drawings

An Introductory Manual and Preliminary Construction Drawings booklet (see Appendix E) was compiled prior to the coordination visit, providing a point of reference for discussions and research. The following key design criteria were based on simplified design parameters experimented with during the secondary pilot study, as well as familiarity with locally available materials.

1. Water recirculation will be achieved with gravity/weir flow and one return pump
2. Tank construction will consist of concrete block
3. Tilapia breeding control will be achieved with raised fishnets
4. An alternative energy supply to electrical grid must be determined

Joel Wicoff and Bob Klubek, of Deep Creek Engineering in Iola, Kansas, donated time and resources towards compilation of the Preliminary and Revised Construction Drawings. Mr. Wicoff, a registered professional engineer, completed all tank wall and slab reinforcing design. He also participated in the coordination trip to Uganda, and was of immense assistance with on-site planning and research. Mr. Klubek designed plant tank connections, as well as created all AutoCAD plan, elevation, and detail files.

4.3.2 Site Location and Water Supply

Upon arrival in Gulu, Uganda, a first stop was to the proposed facility site. The partnering organization owns two properties. One property is 10 acres, and the other is four acres. The in-field organization envisioned the proposed facility on the 10-acre site, situated on the back-sloping portion. After walking the land, it was determined that a stream cutting across the plot resulted in near-constant saturation of the low-lying area. If the facility were constructed on the wet soil, inevitable foundation cracking and shifting would occur.

After discussions, it was agreed that the facility would be located on the four acre site. The allotted portion provided an upland area that would not become heavily saturated, even during the wet season. Figure 4.32 below is a 2007 survey of the site, completed by Engineering Ministries International. Approximately the back two acres was made available for the aquaponic operation.

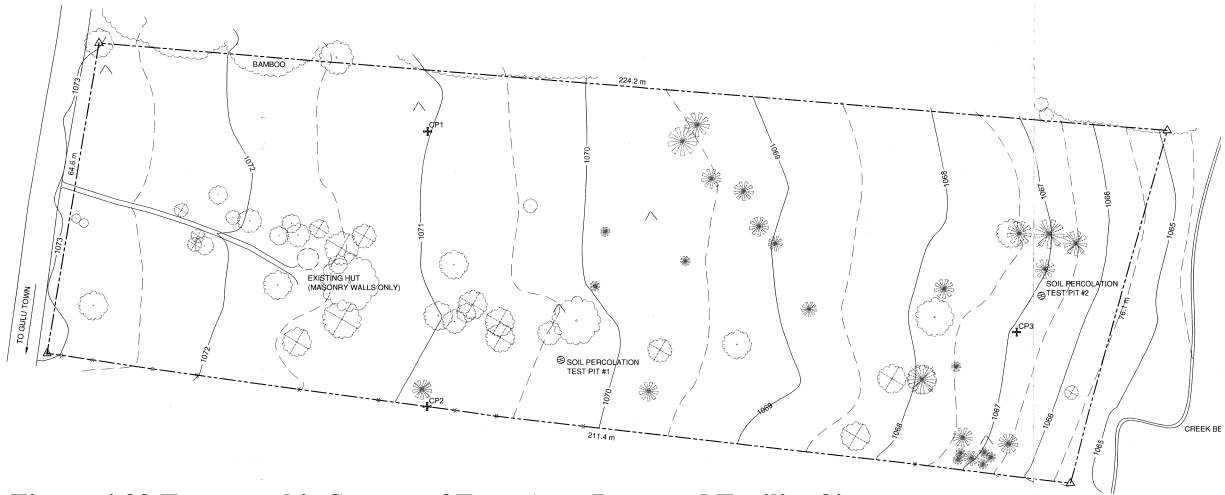

Figure 4.32 Topographic Survey of Four Acre Proposed Facility Site

Figure 4.33 is a photograph of the selected site. Depending on layout, site preparation will consist of tree removal and minimal grading. Figure 4.34 shows a school building under construction on the front two acres.



**Figure 4.33
Proposed Facility
Site View**



Figure 4.34 School Under Construction on Proposed Facility Site

Water supply is critical to facility operation. Furthermore, potential contamination eliminates surface water as a viable option. Groundwater must be used for system filling and resupply. Water Harvest International, a Texas-based non-profit that has been drilling wells in southern Sudan and northern Uganda since 2009, drilled a well on the four acre site in February 2011. Fig. 4.35 below shows a similar well, drilled by Water Harvest International, located on the 10-acre site. The 10-acre site well was in existence at the time of the July 2010 coordination trip.



Figure 4.35 Typical Drilled Well in Gulu, Uganda

4.3.3 Locally Available Materials and Construction Methods

The Preliminary Construction Plans required revision with information gathered in-field. While concrete block construction was deemed feasible, the plan detail was revised to reflect local construction methods. Figures 4.36a and 4.36b illustrate the original and revised wall details, respectively. Additional narrative follows the figures.

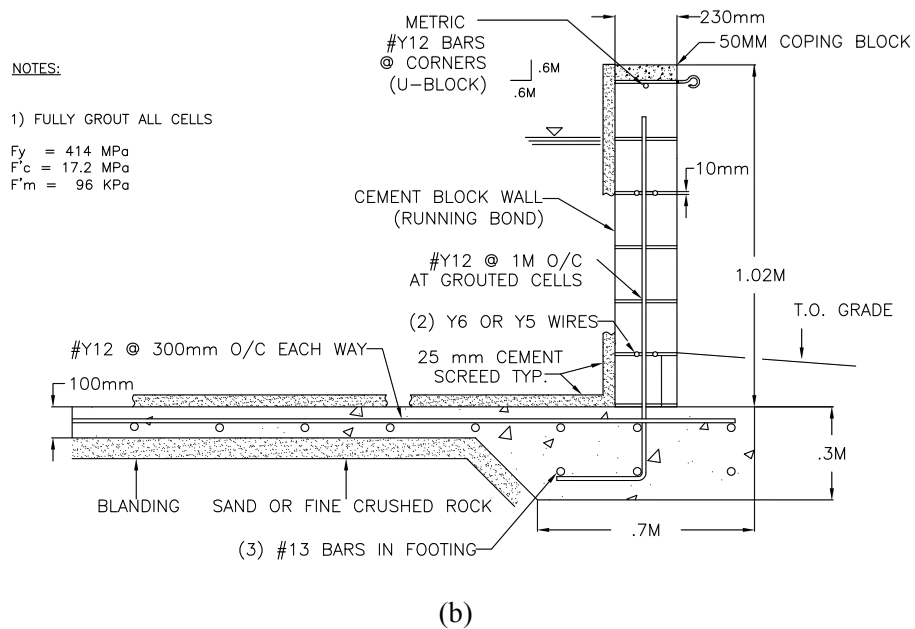
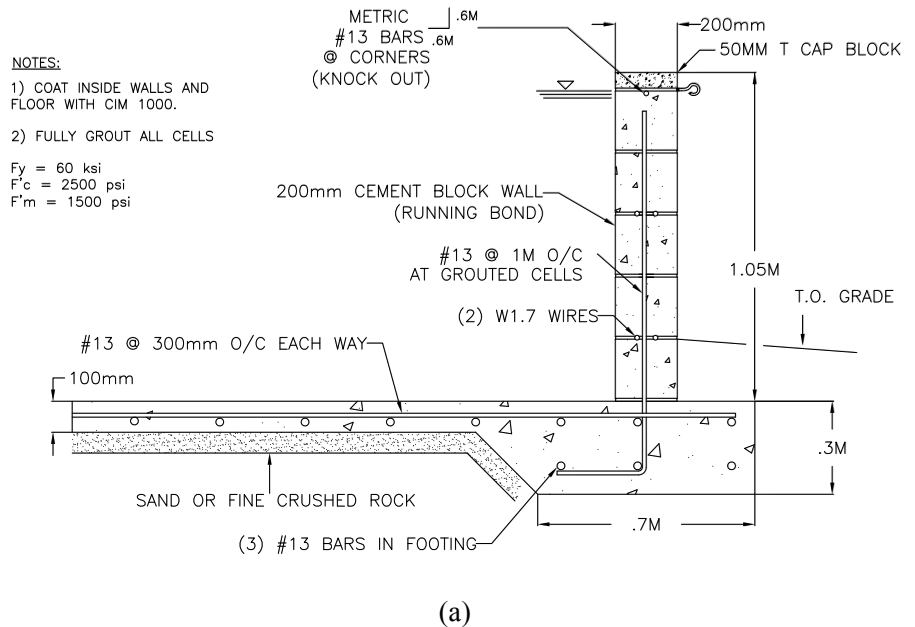

Figure 4.36 Proposed Facility Tank Wall and Slab Detail

The following two changes were made:

1. Local concrete blocks varied in height. All available sizes were smaller than the originally assumed western standard metric equivalent. In addition, the blocks were reported to be 230 mm wide, versus the originally noted 200 mm.
2. A 25 mm plaster layer, locally called a 'cement screed', is used to coat the foundation floor and brick wall interior. This was added in the revised detail. Note that this screed layer will not be considered sufficient waterproofing. A tank lining will be selected prior to facility implementation.

4.3.4 Energy Supply

Solar energy will be used for all power requirements. The preliminary Construction Drawings illustrate a hybrid system comprised of both solar and wind. In-field research concluded that wind power is not a viable option. Therefore, solar energy will be used for water and aeration pumps. Detailed pump and energy supply design calculations are not included in this study.

4.3.5 Tilapia Feed

A critical unknown was availability and composition of fish feed in northern Uganda. While in Gulu, a fish feed supplier was located. As a result of identifying a local feed source, it was determined that the remainder of the pilot study would focus on plant/tilapia ratios, facility design, and operating principles.

As discussed in Chapter 2, fish feed selection is based on fish maturity. Higher protein content is required for fry and fingerlings. The fish feed producer provided typical compositions for feed ranging from 30-60% protein, detailed in Table 4.13. He recommended that 60% protein content (Table 4.13a) be used for the first two and one-half months, 40% protein content (Table 4.13b) the subsequent two and one-half months, followed by 30% protein (Table 4.13c) for the remainder of the grow-out period.

	PRODUCT	COST/KG (UGX)	% CONTENT	MIX COST (UGX)
PROTEIN (60%)	bloodmeal	1200	0.2	240
	soybean cake	1000	0.2	200
	fishmeal	2000	0.2	400
CARBOHYDRATES (35%)	maize bran	300	0.15	45
	rice bran	250	0.15	37.5
	cassava flour	550	0.05	27.5
MINERALS (2%)	bonemeals	500	0.01	5
	snail shells	500	0.01	5
	---OR--- pre-mix	6000	0.02	
VITAMINS (2%)	green leaves	500	0.02	10
	---OR--- pre-mix			
FAT (1%)	pig fat	2000	0.01	
	---OR--- sunflower cakes	500	0.01	240
COST/KG				1210

(a)

	PRODUCT	COST/KG (UGX)	% CONTENT	MIX COST (UGX)
PROTEIN (40%)	bloodmeal	1200	0.13	160.00
	soybean cake	1000	0.13	133.33
	fishmeal	2000	0.13	266.66
CARBOHYDRATES (55%)	maize bran	300	0.25	75.00
	rice bran	250	0.25	62.50
	cassava flour	550	0.05	27.50
MINERALS (2%)	bonemeals	500	0.01	5.00
	snail shells	500	0.01	5.00
	---OR--- pre-mix	6000	0.02	
VITAMINS (2%)	green leaves	500	0.02	10.00
	---OR--- pre-mix			
FAT (1%)	pig fat	2000	0.01	
	---OR--- sunflower cakes	500	0.01	240.00
COST/KG				985

(b)

	PRODUCT	COST/KG (UGX)	% CONTENT	MIX COST (UGX)
PROTEIN (30%)	bloodmeal	1200	0.10	120.00
	soybean cake	1000	0.10	100.00
	fishmeal	2000	0.10	200.00
CARBOHYDRATES (65%)	maize bran	300	0.30	90.00
	rice bran	250	0.30	75.00
	cassava flour	550	0.05	27.50
MINERALS (2%)	bonemeals	500	0.01	5.00
	snail shells	500	0.01	5.00
	---OR--- pre-mix	6000	0.02	
VITAMINS (2%)	green leaves	500	0.02	10.00
	---OR--- pre-mix			
FAT (1%)	pig fat	2000	0.01	
	---OR--- sunflower cakes	500	0.01	240.00
COST/KG				873

(c)

Table 4.13 Local Feed Composition for (a) 60%, (b) 40% , and (c) 30% Protein Content

Feed source will play a role in facility size and profit, as quantitatively compared in Section 4.1.3. The local feed supplier indicated that he would provide required technical knowledge and guidance, enabling the proposed facility to eventually produce its own feed. If the facility produces feed, operational costs and quantity of required systems are reduced. Figure 4.14 below identifies direct savings if the feed is self-made. Table values do not account for fuel and maintenance of the feed pellet machine.

Table 4.14 Savings Comparison: Purchased Feed vs. Self-Produced

PROTEIN CONTENT	PURCHASED FEED (UGX/KG)	SELF-PRODUCED FEED* (UGX/KG)	SELF-PRODUCED DIRECT SAVINGS
60%	1800	1210	33%
40%	1500	985	34%
30%	1200	873	27%

* Does not consider machinery fuel and maintenance costs

Without having laid eyes on or operated the machinery, the average savings is reduced to 20% for design purposes.

Fish food is the proposed facility’s largest operating cost. Since the facility must function as a business, and not a U.S.-funded charity, fish and/or produce must be sold to offset feed costs. With constantly fluctuating market prices for a variety of vegetables, a balanced budget derived from produce sales is extremely undependable. Therefore, initial system sizing is based on tilapia sales.

Information gathered from Gulu citizens provided a price range of 5000-8000 UGX for a 1 kg (2.2 lb) tilapia. Considering the daily fluctuating market, Table 4.15 identifies the average percent of fish in each system that must be sold to offset feed costs. Section 4.1.3 references these percentages in relation to the proposed facility’s required number of systems.

In calculating the percentages shown, the following assumptions govern:

1. The food conversion ratio is 1.5
2. Tilapia harvest weight is 2.2 lb (1 kg)
3. Forty percent protein feed is considered dominant at 1500 UGX/kg (purchased) and 1200 UGX/kg (self-produced)

FEED SOURCE	NO. FEED PER SYSTEM	GROW-OUT COST (UGX)	NO. REQ'D MARKET FISH (SYSTEM %)		AVERAGE SYSTEM %
			Market Price: 5000 UGX	Market Price: 8000 UGX	
Purchased	400	900,000	180 (45%)	113 (28%)	37%
Self-Made	400	720,000	144 (36%)	90 (23%)	30%

Table 4.15 Proposed Facility Market Tilapia Quantities: Purchased Feed vs. Self-Produced

4.3.6 Familiar Vegetables and Greens

The following vegetables and greens were familiar to Ugandans: spinach, cabbage, tomatoes, peppers, eggplant, okra, beans, cucumber, broccoli, and cauliflower. Although broccoli and cauliflower were not seen in the markets during the coordination trip, local word and literature research indicated that Ugandans are familiar with these vegetables.

Although additional favored plants will likely be discovered during implementation, all of the plants listed thus far can be grown in an aquaponic system.

4.3.7 Local Aquaculture Facilities

It was important to determine what technology and materials were familiar to the target communities. One way of mitigating hesitance to a foreign technology is incorporation of known techniques and materials from similar applications. Aquaculture, although comprising only the fish farming component of aquaponics, is a familiar and relatable practice.

Earthen ponds are typically used in Ugandan aquaculture. During efforts to investigate existing aquaculture facilities, it was discovered that success rates are not very high. An individual affiliated with Two Fish's partnering organization, allegedly having previous experience with commercial aquaculture operations, stated that approximately 60-90% of government funded operations fail. Although this statistic was not independently verified, it should be noted that no fully functioning aquaculture facilities were found in or near Gulu. Figure 4.37 provides photographs of one aquacultural attempt in Gulu.



Figure 4.37 Failed Aquaculture Facility No. 1 in Gulu, Uganda

The facility was partially constructed, with funds running out before final completion and start-up. At the time of the coordination trip, the contractor retained ownership of the facility, with no completion and turnover date in sight. Illustrated by the previous photographs, a large number of ponds were excavated for fish culture, with several of the ponds still holding water. The lower right photograph in Figure 4.37 illustrates covered tanks intended to serve as a hatchery. At the time of our visit, a couple of contractor-hired personnel were working around the few ponds with water, where tilapia were purportedly growing.

The second facility visited was also located in Gulu. The configuration included a hatchery area and a series of earthen ponds for grow-out. Similar to the previous, funds ran out before the facility was fully functioning. As ponds were dug and a hatchery area was largely complete, it is not known if funding shortfall effected construction materials, start-up purchases (i.e. fingerlings, fish feed, etc.), personnel salaries, or a combination of all three. Either way, the facility portions completed were not being utilized in any manner.

Figure 4.38 below shows the hatchery area (left photo) and one pond series (right photo).



Figure 4.38 Failed Aquaculture Facility No. 2 in Gulu, Uganda

On the road between Gulu and Kampala, a sign advertising a fish farm was spotted. After following a dirt path back for a couple of miles, the facility was located. Because the farmers spoke Swahili and Acholi (a local dialect), the driver translated their story.

Foreign aid was provided for pond excavation. In this case, both tilapia and catfish were introduced. Following start-up, a couple of the ponds were unable to maintain water and dried up. In addition, the stocked tilapia died in all ponds. However, a small catfish population remained in one pond. Figure 4.39 shows a farmer feeding catfish. It was positively noted that, despite challenges encountered, the group of farmers strived to obtain a catfish harvest yet. At the time of our visit, the farmers looked forward to a first harvest in January 2011.



Figure 4.39 Struggling Aquaculture Operation near Gulu, Uganda

The upper left photograph of Figure 4.39 shows algae growth in the corner of the pond with the remaining catfish population. The algae is congregated around a pipe that appears intended to provide a constant inflow of water. In all of the cases researched, it is speculated that facility failure was attributable to any one or a combination of the following:

(1) improper soil compaction, leading to leakage and pond emptying, (2) inadequate constant supply of fresh water (reliance on a low flow stream or improper stream routing), leading to toxic nitrogen levels and fish mortalities, or (3) inadequate pond maintenance (i.e. clearing and dredging), leading to eutrophication, low DO levels and fish mortalities.

The final facility visited was the well-known Kajjansi Aquaculture Research and Development Centre, a government operated facility located near Kampala and adjacent to Lake Victoria. At the time of the coordination trip, the facility was closed and under construction. A partnership was apparently reached with the Chinese government. A Chinese entity was overseeing construction of concrete lined raceways, and a few of the Ugandan government personnel had recently received training in China to expand their knowledge on aquaculture methods.

Figure 4.40 shows a newly constructed hatchery area. Still under construction was an extensive system of long grow-out raceway channels.



Figure 4.40 Kajjansi Aquaculture Facility Under Construction

Facility personnel indicated that they could supply tilapia fingerlings for the proposed facility start-up. Actual source and quality were not ascertainable during discussions. In general, it was realized that all fingerlings available were going to be of unknown origin and quality. During facility start-up, it will be critical to take disease prevention precautions. Feasible standard practices include a quarantine period outside of the main facility systems, as well as salt water dips to eliminate infectious pathogens (Yanong, 2003).

Chapter 5 Conclusions

This study developed a preliminary design for a simplified commercial-scale aquaponic facility. The simplified design reduces both specialty materials/parts and required O&M costs and technical knowledge. With the specific initial phase goal of providing one protein meal a month for 400 schoolchildren, this study lays the groundwork for facility implementation in Gulu, Uganda.

Research objectives achieved are: (1) identification of simplified commercial-scale system components, (2) establishment of water quality parameter baseline, (3) plant/tilapia production ratio identification, (4) identification of locally available construction materials, (5) integration of culturally familiar elements, (6) preliminary facility design, and (7) facility water balance calculations. Table 5.1 delineates specific results, with narrative following.

Objective	Description	Results	Notes
1	Simplified Design Components	A. Water circulation achieved with gravity flow and one return pump B. Tank cleaning achieved with strategically sloped floors and manual waste siphoning C. Breeding control achieved with raised bottom fishnets	Simplified design eliminates traditional commercial-scale facility mechanical clarifying components and underground piping
2	Baseline Water Quality Parameters	DO > 3.0 mg/L pH > 5.5 TAN < 3.0 mg/L (2 mg/L avg.)	Values are relevant to submerged aeration and a bio-filter/plant tank HRT greater or equal to 1.2 hours
3	Plant/Tilapia Ratio	2.5 ft ² /lb	Ratio revision is achievable in the field through staged construction and routine water quality monitoring
4	Construction Materials Available in Northern Uganda	Simplified design is compatible with concrete block construction local to Gulu, Uganda	Sundry other items, such as fishnets, PVC piping, flexible tubing, rebar, and grout and mortar materials are available locally in quantities
5	Culturally Familiar Elements	A. Facility crops will be familiar: tilapia is a native fish, and selected vegetables identified in local markets B. Commercially produced plant tank raft materials to be replaced with woven matting from locally available natural materials C. Unfamiliar proposed tank design will be identified with newly adopted raceway culture techniques at Kajjansi Aquaculture Centre	Hesitancy towards a foreign agricultural concept is expected; culturally familiar elements will alleviate fears
6	Preliminary Facility Design	Preliminary construction plans are compiled, with facility dimensions/sizing identified for 3 to 12 gal/lb tilapia densities	Required number of plant tanks per fish tank is dependent on facility's operational tilapia density
7	Water Balance / Maximum Well Supply Demand	Range for 12 to 3 lb/gal densities: 9,735 gal/yr well supply demand to 10,984 gal/yr rainwater surplus	Water storage system is required for maximum rainwater use and subsequent reduced well demand during dry months

Table 5.1 Research Objectives and Results

A simplified design achieves water circulation with weir gravity flow and one return pump, tank cleaning with strategically sloped floors and manual waste siphoning, and breeding control with raised bottom fishnets. Submerged aeration proved critical to fish feeding rates, despite surface aeration's low energy appeal.

The baseline water quality parameters identified were DO > 3 mg/L, pH > 5.5, and TAN < 3.0 mg/L. These values are considered minimum desirable operating levels. Values are relevant for submerged aeration and a bio-filter/plant tank water treatment HRT greater or equal to 1.2 hours.

A plant/tilapia ratio of 2.5 ft²/lb was identified and used for proposed facility design. The selected ratio is based on a daily 2% body weight feeding rate.

The simplified design was assessed compatible with concrete block construction local to northern Uganda. Various required materials such as fishnets, PVC piping, flexible tubing, rebar, and grout and mortar materials were verified to be locally available.

To ease hesitancy towards a foreign agricultural method, familiar elements were identified for incorporation. Facility crops will be familiar; tilapia is a native fish, and selected vegetables were identified in local markets. Commercially produced plant tank raft materials will be replaced with woven matting from locally available natural materials. The unfamiliar proposed tank design will be identified with newly adopted raceway culture techniques at Kajjansi Aquaculture Centre, a well-known Ugandan fishery.

A preliminary proposed facility design is completed for tilapia densities ranging from 12 to 3 gal/lb. Required plant area is dependent on fish density, with required number of plant tanks varying for each density considered. Local materials, the identified plant/tilapia ratio, minimum HRT, and simplified design components are considered in the design.

Water balances, considering rainfall resupply and water loss due to evaporation, transpiration, and tank wasting, were completed for densities ranging from 12 to 3 gal/lb. Negative balances indicated the required well supply. Corresponding water balances ranged from a 9,735 gal/yr well supply demand to a 10,984 gal/yr rainwater surplus.

Chapter 6 Future Study

Many opportunities exist for future studies. Development and implementation of an agricultural facility encompasses multiple disciplines. This study is application-oriented and lays the overall groundwork for facility implementation in Gulu, Uganda. Any specific aspect (i.e. system nutrient balance, plant nutrient uptake, tilapia feed conversion ratios and growth rates in response to environmental inputs, etc.) can be isolated and studied further at pilot scale.

At this time, the following specific future studies are anticipated:

1. Proposed facility energy supply design: solar energy will be utilized to power water and air pumps
2. Proposed facility implementation: water quality and fish/plant growth will be quantitatively measured and recorded throughout the first year of facility start-up to verify and adjust system design as required
3. Proposed feed analysis: tilapia feed available in Gulu will be assessed for optimum fish growth; a feed production process needs to be developed for the proposed facility in order to mitigate operational risks associated with local supplier dependency

REFERENCES

- Allan, J.A. (2004). Africa South of the Sahara, 33rd Edition. England: Unwin Brothers Ltd., 1060.
- Alleman, James E., and Kurt Preston. Behavior and Physiology of Nitrifying Bacteria. Aquaculture Network Information Center, http://aquanic.org/systems/recycle/ces-240_biology.htm, Accessed March 2011.
- Aquatic Eco-Systems, Inc. www.aquaticeco.com, last accessed March 2011.
- Archer, Allie, Emily Tummons and Alan Winter (2010). Biological and Agricultural Engineering Senior Design Team: Team Tilapia Final Report, BAE 536. Kansas State University.
- Arthur, Barbara. Morning Star Fishermen Training Facility. Meeting and discussion March 2010.
- Chapin, F. Stuart III and Thijs L. Pons (2008). Plant Physiological Ecology, 2nd Edition. New York, NY: Springer Science + Business Media, LLC, 54.
- Chapman, Frank A. (2009). Culture of Hybrid Tilapia: A Reference Profile. Department of Fisheries and Aquatic Sciences, Florida Cooperative Extension Service, Institute of Food and Agricultural Sciences, University of Florida.
- Corrosionist: The Website of Corrosion Protection and Corrosion Control. Galvanic Corrosion, http://www.corrosionist.com/Galvanic_Corrosion.htm, Accessed March 2011.
- Davis, Joseph R. (2000). Nickel, cobalt, and their alloys. Materials Park, OH: ASM International, 92.
- DeLong, Dennis P., Thomas M. Losordo, James E. Rakocy (2009). Tank Culture of Tilapia. Southern Regional Aquaculture Center Publication No. 282.
- Friend, Susanne and Tim Mann (2009). Micro Aquaponics System. Friendly Aquaponics, Inc.
- George, Thomas T. (2005). The Most Recent Nomenclature of Tilapia Species in Canada and the Sudan. Aquaculture Canada, AAC Spec. Publ. No. 10, 33-37.
- Gerardi, Michael H. (2002). Nitrification and Denitrification in the Activated Sludge Process. New York, NY: John Wiley and Sons, Inc.

- Gorder, Steven D. Van (2000). Small Scale Aquaculture. Breinigsville, PA: Alternative Aquaculture Association, Inc.
- Guerrer, Maria A. and Ronald D. Jones (1996). Photoinhibition of marine nitrifying bacteria, II. Dark Recovery after monochromatic or polychromatic irradiation. Marine Ecology Progress Series, Vol. 141: 193-198.
- Gupta, Avijat (2007). Large Rivers: Geomorphology and Management. England: John Wiley & Sons, Ltd., 275.
- Iqbal, Sascha (1999). Duckweed Aquaculture: Potentials, Possibilities and Limitations for Combined Wastewater Treatment and Animal Feed Production in Developing Countries. SANDEC Report No. 6/99, 1999, 11-13.
- Longfield, Matt. YSI, Inc.. E-mail correspondence October 2010.
- Masters, Gilbert M. and Wendell P. Ela (2008). Introduction to Environmental Engineering and Science, Third Edition. Upper Saddle River, NJ: Pearson Education, Inc.
- Matousek, C.L. (2004). Raising Tilapia for Community Development. Morning Star Fishermen.
- McGinty, Andrew S. and James E. Rakocy (1989). Cage Culture of Tilapia. Southern Regional Aquaculture Center Publication No. 281.
- Metcalf and Eddy (2003). Wastewater Engineering: Treatment and Reuse, Fourth Edition. New York, NY: Mc-Graw Hill.
- Mountain Empire Community College (2011). Lesson 8: Corrosion Control, ENV 110 Introduction to Water and Wastewater Treatment Technology.
- National Environment Management Authority (unknown). Report of the National Capacity Self Assessment for Implementation of the Multilateral Environment Agreements (CBD, UNFCCC, CCD and International Waters) in Uganda. The Republic of Uganda: Ministry of Water, Lands and Environment, 4.
- Nelson, Rebecca L. and John S. Pade (2008). Aquaponic Food Production: Raising fish and plants for food and profit. Nelson and Pade, Inc., Montello, WI, 41-64.
- Pessaraki, Mohammad (1999). Handbook of Planet and Crop Stress. Switzerland: Marcel Dekker, Inc., 912.
- Popma, Thomas and Michael Masser (1999). Tilapia: Life History and Biology. Southern Regional Aquaculture Center Publication No. 283.

- Purina Mills: AquaMax Fish Diets, <http://aquamax.purinamills.com/aquamaxfishdiets.htm>, last Accessed March 2011.
- Quiming, Lai and Yang Yi (unknown). Tilapia Culture in Mainland China. College of Aquaculture, China and Aquaculture and Aquatic Resources Management, Asian Institute of Technology, Thailand, 18-27.
- Rains, Rex. R&S Ranch, LLC (tilapia supplier). Meeting and discussion April 2010.
- Rakocy, James E., Michael P. Messer, and Thomas M. Losordo (2006). Recirculating Aquaculture Tank Production Systems: Aquaponics - Integrating Fish and Plant Culture. Southern Regional Aquaculture Center (SRAC), Publication No. 454.
- Riche, Marty and Donald Garling (2003). Feeding Tilapia in Intensive Recirculating Systems. North Central Regional Aquaculture Center in cooperation with USDA.
- Riotte, Louise (1998). Carrots Love Tomatoes: Secrets of Companion Planting for Successful Gardening. North Adams, MA: Storey Publishing.
- Roberto, Keith (2005). How-To Hydroponics, Fourth Edition. Farmingdale, NY: The Futuregarden Press.
- Timmons, E.B. and J.M. Ebeling (2007). Recirculating Aquaculture. Ithaca, NY: Cayuga Aqua Ventures.
- UNICEF, Uganda Malnutrition Statistics, http://www.unicef.org/infobycountry/uganda_statistics.html, Accessed March 2011.
- University of Virgin Islands, Agricultural Research Station (AES) <http://www.uvi.edu/sites/uvi/Pages/AES-Aquaculture-Home.aspx?s=RE>, last Accessed March 2011.
- Wintgens, Jean Nicolas (2009). Coffee: Growing, Processing, Sustainable Production: A Guidebook for Growers, Processors, Traders, and Researchers. Switzerland: Wiley-VCH, 316-317.
- Yanong, Roy, P.E. (2003). Fish Health Management Considerations in Recirculating Aquaculture Systems – Part 1: Introduction and General Principles. Fisheries and Aquatic Sciences Department, Florida Cooperative Extension Service, Institute of Food and Agricultural Sciences, University of Florida, Circular 120.

Appendix A: Pilot Study Materials and Equipment List

Pilot Study Material List

Item	Description/Product Number	Vendor	Unit	Qty.	Notes
Main System Components					
210 Gal. Fish Tank	48"I.D.x30"Depth - TP210	Aquatic Ecosystems	EA	4	Initial Study: Each of the 4 systems consisted of a fish, bio-filter, and plant tank; Secondary Study: Enlarged configuration consisted of 1 fish tank for fish, and two plant tanks and one fish tank housed plants
55 Gal. Bio-Filter Tank	21"x38" Round - TP55	Aquatic Ecosystems	EA	4	
Plant Tanks (130 Gal)	55"x31"x18" - TP110	Aquatic Ecosystems	EA	4	
2" PVC Schedule 40 Pipe		Home Depot	LF	multiple	Initial siphon attempt
2" PVC Schedule 40 Elbows		Home Depot	EA	multiple	Initial siphon attempt
3/4" aquarium grade clear tubing		local aquarium store	LF	multiple	Revised siphon design
Medo Linear Piston Air Pump	SL88	Aquatic Ecosystems	EA	1	Initial water elevation attempt / later used for submerged aeration
250 gph PondMaster Water Pumps		PondMaster	EA	4	Revised water elevation method
Bio-Filter Items					
Biomedia	BBC599	Aquatic Ecosystems	CF	12	Black media was selected due to nitrifying bacteria's dark environment preference
Mesh media bag	BF167	Aquatic Ecosystems	EA	4	
Fish Tank Items					
60-Tilapia Fingerlings (2"-5")		R&S Ranch - Missouri	EA	1	
4'x4'x2' Net Box - 1/4" Mesh	NB4424	Aquatic Ecosystems	EA	4	
1/2" to 1" PVC		Home Depot	LF	multiple	support for net boxes
Air stones, tubing, and control valves		local aquarium store	EA	multiple	nets and pvc
Plants					
4'x8' Polystyrene Foam Boards		Home Depot	EA	multiple	
Plug Tray		local nursery	EA	5	
Standard Flat w/o Holes		local nursery	EA	5	
Rockwool Propagation Cubes	98 cubes per slab	Aquatic Ecosystems	Slab	2	
Seeding Soil		local nursery	Bag	1	
2" Net Pots		Growers Supply	EA	multiple	
Seed (Multiple Plant Types)		local nursery	Packet	Multiple	
Water Quality Testing					
LaMotte Fish Farm 9 Test Kit	LMAQ2 (chemical refills separate)	Aquatic Ecosystems	EA	1	Extremely time prohibitive
LaMotte Nitrate Test Kit	LM3319 (chemical refills separate)	Aquatic Ecosystems	EA	1	Extremely time prohibitive
YSI Professional Plus Multi-Parameter Meter	(meter and probes individually selected)	Aquatic Ecosystems	EA	1	Allowed for consistent data collection during secondary study
Miscellaneous Items					
Sun System HPS 150W Grow Light		Grow Wurks Hydroponics	EA	4	Provided supplemental sunlight during fall/winter months
1000W Bucket Heaters		Tractor Supply	EA	4	Initial water heating attempt that resulted in galvanic corrosion
Glass Aquarium Heaters		local aquarium store	EA	multiple	Revised water heating method
Ohaus Ranger Scale	RD6RS	Ohaus	EA	1	Used for weighing fish and fish feed
AquaMax 500	50 lb bag	Macon Feed and Seed	Bag	1	Fish Feed
Other Items					
The pilot study required multiple miscellaneous items such as fishnets, buckets, electric ties, CMU blocks, greenhouse fans (to improve air flow and ventilation during hot summer months), electrical wiring items, predator netting (to prevent raccoons from entering when back ventilation door was open), white fly traps, cages/rope for vine plants, work gloves, site clearing tools (shovels, rakes, etc), camera, record keeping materials, etc.					

Appendix B: Primary Pilot Study Data

Study Day	Date	Fish Tank				Plant Tank No. 1				Plant Tank No. 2				Plant Tank No. 3				Notes
		T	DO	pH	TAN	T	DO	pH	TAN	T	DO	pH	TAN	T	DO	pH	TAN	
1	10-Oct	19.0	4.53	6.40	0.11													Start Date
2	11-Oct	25.4	3.06	5.81	0.44													
3	12-Oct	27.4	2.15	5.56	0.74													
4	13-Oct	23.6	3.10	5.20	1.00													
5	14-Oct	26.2	1.73	5.23	1.18													
6	15-Oct	21.8	4.25	5.11	1.43													
7	16-Oct	28.1	1.48	5.50	1.53													
8	17-Oct	22.7	3.90	5.56	1.86													
9	18-Oct	26.9	0.92	6.08	2.50													
10	19-Oct	21.5	2.10	6.10	3.30													
11	20-Oct	25.4	1.63	5.87	2.60													
12	21-Oct	26.7	1.36	5.78	2.93													
13	22-Oct	28.4	1.19	6.06	3.31													
14	23-Oct	24.0	2.91	6.11	3.71													Enlarged System
15	24-Oct	24.1	1.89	5.87	1.62													
16	25-Oct	21.6	0.83	5.88	1.90													
17	26-Oct	23.8	1.31	5.92	1.60	23.3	1.27	5.90	1.60	23.3	1.35	5.90	1.60	23.2	1.30	5.86	1.59	
18	27-Oct	23.9	1.14	5.80	1.66													
19	28-Oct	23.2	2.37	5.74	1.61	23.2	2.73	5.73	1.61	23.2	2.45	5.74	1.62	23.2	2.38	5.71	1.58	
20	29-Oct	28.0	1.38	5.38	1.56	28.6	1.39	5.37	1.52	28.4	1.55	5.37	1.52	28.3	1.49	5.33	1.52	
21	30-Oct	28.6	0.95	5.59	1.66	28.6	0.95	5.56	1.65	28.6	1.07	5.56	1.64	28.6	1.00	5.55	1.65	
22	31-Oct	29.5	1.64	5.49	1.78	29.1	1.65	5.48	1.76	29.1	1.87	5.46	1.75	29.1	1.84	5.44	1.74	
23	1-Nov																	
24	2-Nov	24.8	2.87	5.40	1.94	24.3	3.00	5.33	1.93	24.2	3.30	5.33	1.95	24.1	3.18	5.28	1.94	
25	3-Nov	24.0	2.56	5.51	2.08	24.0	2.37	5.40	2.08	23.9	2.80	5.40	2.07	23.8	2.65	5.37	2.06	
26	4-Nov	26.0	2.36	5.50	2.01	25.7	2.10	5.46	2.00	25.5	2.62	5.46	1.99	25.3	2.43	5.44	2.00	
27	5-Nov	24.1	2.48	5.55	1.61	23.7	2.30	5.44	1.60	23.5	2.68	5.45	1.57	23.3	2.49	5.42	1.57	meter calibrated
28	6-Nov	27.6	2.35	5.62	1.54	27.7	2.49	5.56	1.52	27.6	2.74	5.56	1.51	27.7	2.61	5.53	1.49	
29	7-Nov	25.4	1.40	5.80	1.71	25.3	1.33	5.77	1.69	25.4	1.29	5.75	1.67	25.4	1.20	5.74	1.65	
30	8-Nov	26.6	1.08	5.96	1.90	26.6	0.97	5.90	1.89	26.6	0.96	5.90	1.88	26.5	0.90	5.90	1.86	Added FT Aerators
31	9-Nov	26.2	5.45	6.50	1.80	25.9	5.73	6.34	1.80	25.8	5.71	6.32	1.78	25.8	5.54	6.27	1.79	
32	10-Nov	26.2	5.09	6.02	1.64	26.2	5.06	5.94	1.62	26.2	5.10	5.91	1.61	26.2	5.04	5.86	1.61	
33	11-Nov	23.2	5.35	5.68	1.64	22.9	5.00	5.61	1.64	22.8	5.15	5.57	1.63	22.7	5.23	5.53	1.63	

Study Day	Date	Fish Tank				Plant Tank No. 1				Plant Tank No. 2				Plant Tank No. 3				Notes
		T	DO	pH	TAN	T	DO	pH	TAN	T	DO	pH	TAN	T	DO	pH	TAN	
34	12-Nov	27.1	2.65	5.77	1.77	26.7	1.93	5.76	1.79	26.9	1.81	5.72	1.74	26.9	1.66	5.65	1.71	P.O.(DO 0.65 min)
35	13-Nov	23.0	5.20	5.47	1.72	22.6	5.09	5.44	1.71	22.4	5.12	5.42	1.71	22.2	5.02	5.41	1.72	
36	14-Nov	21.1	4.41	5.11	1.77	20.9	4.35	5.08	1.76	20.7	4.39	5.07	1.77	20.6	4.52	5.07	1.77	
37	15-Nov	21.2	4.55	4.58	2.40	21.2	4.48	4.57	2.29	21.1	4.48	4.56	2.24	21.1	4.43	4.56	2.17	
38	16-Nov	17.5		6.42	0.07	15.5		6.20	0.04	16.0		6.12	0.03	15.2		5.98	0.04	low pH- H ₂ O change
39	17-Nov	19.0		6.35	0.21													
40	18-Nov	20.5		6.48	0.32	20.6		6.44	0.32	20.4		6.40	0.32	20.3		6.39	0.32	DO sensor has bubble
41	19-Nov																	
42	20-Nov	22.1	7.29	6.46	0.79	22.1	7.39	6.43	0.73	22.0	7.33	6.41	0.66	21.9	7.29	6.39	0.56	
43	21-Nov	21.2	7.25	6.36	0.74	21.3	7.02	6.29	0.72	21.2	7.24	6.27	0.72	21.0	6.88	6.27	0.72	
44	22-Nov	20.9	7.42	6.37	0.93	20.9	7.20	6.31	0.90	20.9	7.21	6.28	0.90	20.7	7.11	6.25	0.89	
45	23-Nov	20.8	7.48	6.32	1.16	20.7	7.24	6.28	1.14	20.6	7.23	6.25	1.14	20.4	7.18	6.23	1.13	
46	24-Nov	24.1	6.69	6.27	1.26	23.8	6.40	6.17	1.24	23.8	6.27	6.15	1.23	23.6	6.19	6.14	1.24	
47	25-Nov																	
48	26-Nov																	
49	27-Nov	27.1	5.19	5.54	2.09	26.8	4.89	5.40	2.05	26.8	4.75	5.35	2.04	26.6	4.65	5.35	2.04	
50	28-Nov	25.1	6.47	5.83	2.42	24.7	6.32	5.72	2.39	24.6	6.23	5.69	2.39	24.6	6.34	5.68	2.34	
51	29-Nov	27.6	4.51	5.82	2.71	27.2	4.13	5.73	2.67	27.1	4.05	5.71	2.66	27.0	3.95	5.69	2.68	
52	30-Nov	25.6	5.15	5.88	3.04	25.2	5.07	5.82	3.03	25.2	5.04	5.80	3.01	25.1	4.95	5.79	3.02	

Appendix C: Secondary Pilot Study Data

Introductory Notes:

- Fish were received Friday, 18 June 2010. Two died upon arrival due to stress during mailing (fish were FedEx'ed overnight). Although simple strip tests indicated that water quality was adequate, cheap bottom feeder goldfish were temporarily placed in the plant tanks the Monday prior. The goldfish survived quite well in the water, confirming adequate water quality. The goldfish were subsequently removed and placed in several of the Owner's multiple goldfish/greenery ponds on their property.
- Plants were introduced simultaneously with the fish. Seven plants were installed per system. The majority of the plants are tomato, with two herbs (oregano and basil) included per tank also.
- Ammonia, temperature, and pH levels were recorded on Day 2 (Saturday, 19 June) as follows - Tank 1: 0.7ppm ammonia, 26.25C, pH>10; Tank 2: 0.8ppm, 27C, pH=9.5; Tank 3: <0.2ppm, 26.5C, pH=10. Elevated pH was brought down with two capfuls of a commercial pH downer (contains sulfuric acid) per system fish tank. Resultant pH: 6.5 (Tank 1), 7.0 (Tank 2), and 7.5 (Tanks 3 and 4). pH levels remained constant on Days 3-5, at which point use of the drop test kits commenced.
- On Day 3 (Sunday, 20 June) it was noted that Tank 4 fish were not surfacing to eat at feeding time. It was verified that the fish were eating bamboo leaves blown into the tank. The adjacent bamboo plants were subsequently cut down, and by Day 5 the fish in Tank 4 exhibited normal behavior at feeding times.
- On Day 4 (Sunday, 21 June) a fish jumped out of the tank overnight. Although returned to the tank, the fish was found dead later in the day and removed. Tank covers were subsequently put on every night to prevent further loss from jumping fish.

23 June 2010 (Wednesday) - Day 6

System	Temp (°C)	pH	TAN	% NH ₃	NH ₃	NO ₂	NO ₃	CaCO ₃ (alkalinity)	CO ₂	Cl	CaCO ₃ (hardness)	DO
1	28.75	6.50	2.00	0.28	0.0056	0.05-0.1	0.50	20.00	0.50	<4	20	2.8**
2	28	7.00	2.00	0.72	0.0144	<0.05*	0.25	56.00	1.00	<4	64	3.4**
3	28.5	7.00	1.50	0.74	0.0111	<0.05*	0.25	64.00	1.00	<4	100	5.00
4	28	7.00	2.00	0.72	0.0144	<0.05*	<0.25	68.00	1.00	<4	120	4.60

* Color, although less than 0.05, is visible. This indicates small presence of nitrite bacteria.

** An error in the testing procedure was detected (after sulfuric acid addition, solution was not continuously mixed until all precipitate dissolved), indicating that these test results are low. This data will be thrown out. Fish behavior indicates that there is no lack in oxygen.

- General Notes:
1. Water added today to each system to account for evaporation and debris/waste siphoning
 2. Fish behavior healthy ('normal' eating and swimming). Fish in Tank 4 are maintaining an appetite at feeding times.
 3. a) Are fish gulping at surface? NO; b) Are fish jumping excessively and/or side swimming? NO; c) Do fish have cotton-like spots, or skin sores? NO

24 June 2010 (Thursday) - Day 7

System	Temp (°C)	pH	TAN	% NH ₃	NH ₃	NO ₂	NO ₃	CaCO ₃ (alkalinity)	CO ₂	Cl	CaCO ₃ (hardness)	DO
1	26.75	6.50	2.50	0.45	0.0113	0.05-0.1	1.0-2.0	28.00	1.00	<4	20	4.60
2	27.00	6.5-7.0	3.00	0.46	0.0138	0.05	0.25-0.5	56.00	1.00	<4	80	5.20
3	27.00	7.00	1.5-2.0	0.68	0.0119	<0.05*	<0.25	72.00	1.00	<4	124	4.40
4	26.50	7.00	2.00	0.66	0.0132	<0.05*	<0.25	68.00	1.00	<4	124	4.60

- General Notes:
1. Plants in Tanks 1 and 2 appear to be slightly wilting. This may be due to afternoon sunlight being received primarily by tanks 3 and 4. Plant condition will be watched to determine pattern and cause.
 2. Tank 3: Increased algae growth is noted in this tank, except for where shaded by fig tree. This is likely due to this tank receiving the majority of full afternoon sunlight.
 3. a) Are fish gulping at surface? NO; b) Are fish jumping excessively and/or side swimming? NO; c) Do fish have cotton-like spots, or skin sores? NO

25 June 2010 (Friday) - Day 8

System	Temp (°C)	pH	TAN	% NH ₃	NH ₃	NO ₂	NO ₃
1	26.75	6.50	1.0-3.0	0.24	0.0048	0.1-0.2	1.0-2.0
2	27.00	6.5-7.0	3.00	0.46	0.0138	0.10	0.25
3	27.00	7.00	1.5-2.0	0.68	0.0119	0.05	<0.25
4	26.50	7.00	2.0-3.0	0.66	0.0165	0.05	<0.25

- General Notes:
1. A replacement net was installed in Tank 3.
 2. a) Are fish gulping at surface? NO; b) Are fish jumping excessively and/or side swimming? NO; c) Do fish have cotton-like spots, or skin sores? NO

26 June 2010 (Saturday) - Day 9

System	Temp (°C)	pH	TAN	% NH ₃	NH ₃	NO ₂	NO ₃
1	26.75*	6.50	2.00	0.24	0.0048	0.1-0.2	2.00
2	27.25*	7.00	3.00	0.69	0.0207	0.20	0.50
3	27.00*	7.00	2.00	0.68	0.0136	0.10	0.25
4	26.50*	7.00	2.0-3.0	0.66	0.0165	0.1-0.2	0.25

- General Note:
1. A fish was found dead in Tank 2. When determining the best way to net fish yesterday, Tank 2 was initially used. Three fish jumped out of the tank and were immediately returned. It is likely that one of these three scraped off too much of its slime layer when landing, and subsequently died.
 2. a) Are fish gulping at surface? NO; b) Are fish jumping excessively and/or side swimming? NO; c) Do fish have cotton-like spots, or skin sores? NO

27 June 2010 (Sunday) - Day 10

System	Temp (°C)	pH	TAN	% NH ₃	NH ₃	NO ₂	NO ₃
1	26.75	6.50	2.0-3.0	0.24	0.01	0.1-0.2	2.0-4.0
2	27.50	7.00	>3.0	0.70	----	0.30	1.00
3	27.00	7.0-7.5	2.0-3.0	1.38	0.03	0.1-0.2	0.25-0.5
4	26.50	7.0-7.5	2.0-3.0	1.34	0.03	0.10	0.25

General Notes: 1. a) Are fish gulping at surface? NO; b) Are fish jumping excessively and/or side swimming? NO; c) Do fish have cotton-like spots, or skin sores? NO

28 June 2010 (Monday) - Day 11

System	Temp (°C)	pH	TAN	% NH ₃	NH ₃	NO ₂	NO ₃
1	25.50*	6.50	2.0-3.0	0.21	0.01	0.1-0.2	3.00
2	26.00*	7.00	>3.0	0.64	---	0.5-0.6	1.50
3	25.50*	7.00	2.75	0.62	0.02	0.30	1.00
4	25.50*	7.00	2.75	0.62	0.02	0.2-0.3	0.75

General Notes:

1. Replacement nets were installed in Tanks 1, 2, and 4. The two loose fish in Tank 3 were caught and added to system net.
2. a) Are fish gulping at surface? NO; b) Are fish jumping excessively and/or side swimming? NO; c) Do fish have cotton-like spots, or skin sores? NO

29 June 2010 (Tuesday) - Day 12

System	Temp (°C)	pH	TAN (total)	% NH ₃	NH ₃	NO ₂	NO ₃
1	24	6.5-7.0	2.75	0.37	0.01	0.1-0.2	4.00
2	24.50	7.00	>3.0	0.58	----	0.5-0.6	1.0-2.0
3	23.75	7.00	3.00	0.53	0.02	0.30	1.00
4	24.25	7.00	3.00	0.57	0.02	0.2-0.3	0.5-1.0

General Notes: 1. It has been noted that tank system water goes through 'green' cycles. This has been correlated with siphon tubing algae growth occasionally sloughing off.
2. Water added today to each system to account for evaporation and debris/waste siphoning
3. a) Are fish gulping at surface? NO; b) Are fish jumping excessively and/or side swimming? NO; c) Do fish have cotton-like spots, or skin sores? NO

30 June 2010 (Wednesday) - Day 13

System	Temp (°C)	pH	TAN	% NH ₃	NH ₃	NO ₂	NO ₃
1	22.5	6.5-7.0	2.75	0.33	0.01	0.30	2.00
2	23.50	7.00	>3.0	0.54	----	0.60	2.00
2*	20.50	6.50	0.60	0.11	0.00	0.05	0.25
3	23.50	7.00	3.00	0.54	0.02	0.5-0.6	1.0-2.0
4	23.50	7.00	3.00	0.54	0.02	0.5-0.6	1.0-2.0

* The first 'Tank 2' measurements were taken prior to replacing the system's water. 'Tank 2*' represents water quality measurements directly following water replacement. Refer to Note 1 below.

General Notes:

1. Tank 2 system water was completely changed due to high total ammonia levels. Although the fish behavior indicates that they are healthy, they likely can withstand high ammonia levels through gradual water quality deterioration. Although acclimated, good water quality is desired because it results in better fish growth and higher allowable fish densities. While cleaning the biofilter, a large amount of fish waste 'sludge' was encountered. It is quite possible that only changing the biofilter water would have solved water quality problems. The biofilters for systems 1, 3, and 4 will be cleaned out, with water replaced only in that system tank. Biofilter cleaning will be made a weekly routine maintenance item. The desirable nitrifying bacteria will not be lost, as it primarily resides on the biomedica surfaces.
2. DO of biofilters will be taken prior to cleaning. It may be interesting to know whether or not conditions are close to being anaerobic. If so, the result is nitrate conversion back to ammonia, counteracting the intended aquaponic system process. Although it is not anticipated that anaerobic conditions exist in these shallow systems, routine biofilter cleaning and lengthening of siphon piping will likely correct the situation.
3. a) Are fish gulping at surface? NO; b) Are fish jumping excessively and/or side swimming? NO; c) Do fish have cotton-like spots, or skin sores? NO

01 July 2010 (Thursday) - Day 14

System	Temp (°C)	pH	TAN	% NH ₃	NH ₃	NO ₂	NO ₃	CaCO ₃ (alkalinity)	CO ₂	Cl	CaCO ₃ (hardness)	DO
1	25.00	6.50	2.50	0.20	0.01	0.80	2.00	20.00	<1	<4	20.00	4.40
2	25.00	6.5-7.0	0.80	0.40	0.00	0.15	2.00	20.00	<1	<4	24.00	6.00
3	25.00	7.00	2.75	0.60	0.02	0.80	0.25	56.00	1.00	<4	112.00	4.80
4	25.00	7.00	2.75	0.60	0.02	0.80	1.0-2.0	64.00	1.00	<4	120.00	5.00

General Notes: 1. Complete weekly water quality parameters were measured today.
2. Nitrite limits are nearing or exceeding drop kit limits. Tank 2 can be used to determine if diluted samples that fall within testing limits can be multiplied by the appropriate dilution factor to obtain the true value.
3. All fish exhibit 'normal' feeding and swimming behavior.
4. a) Are fish gulping at surface? NO; b) Are fish jumping excessively and/or side swimming? NO; c) Do fish have cotton-like spots, or skin sores? NO

02 July 2010 (Friday) - Day 15

System	Temp (°C)	pH	TAN (total)	% NH ₃	NH ₃	NO ₂	NO ₃
1	26.50	6.50	2.75	0.23	0.01	>0.80	6.00
2	26.00	6.5-7.0	0.80	0.43	0.00	0.40	2.00
3	26.50	7.00	2.75	0.66	0.02	>0.80	6.00
4	26.50	7.00	2.00	0.66	0.01	>0.80	6.00

- General Notes:
- Tomato plants looking light in color: Dr. Larry Davis visited greenhouse and indicated it might be result from low light (shade cloth is left on greenhouse 100% of time to reduce greenhouse temps)
 - Dr. Davis indicated that a water balance would be useful, evaporation/evapotranspiration rates are always higher than anticipated
 - All fish exhibit 'normal' feeding and swimming behavior.
 - a) Are fish gulping at surface? NO; b) Are fish jumping excessively and/or side swimming? NO; c) Do fish have cotton-like spots, or skin sores? NO

03 July 2010 (Saturday) - Day 16

System	Temp (°C)	pH	TAN	% NH ₃	NH ₃	NO ₂	NO ₂ -N API drop test*
1	25.00	6.0-6.5	2.00	0.15	0.00	>0.80	1.0-2.0
2	25.50	6.50	0.60	0.21	0.00	0.80	1.00
3	24.50	6.5-7.0	1.50	0.39	0.01	>0.80	1.0-2.0
4	24.75	6.5-7.0	1.0-1.5	0.39	0.00	>0.80	1.00

- General Notes:
- System 1, 3, and 4 bio-filters drained and re-filled (tests taken prior)
 - *API drop test kit used to determine nitrite levels exceeding LaMotte test kit limits. API strip tests also used. Results deemed inconsistent. Strip test result range too wide to be considered accurate.
 - All fish exhibit 'normal' feeding and swimming behavior.
 - a) Are fish gulping at surface? NO; b) Are fish jumping excessively and/or side swimming? NO; c) Do fish have cotton-like spots, or skin sores? NO

04 July 2010 (Sunday) - Day 17

System	Temp (°C)	pH	TAN	% NH ₃	NH ₃	NO ₂
1	23.75	6.0-6.5	1.50	0.13	0.00	1.60
2	24.00	6.00	0.40	0.08	0.00	0.80
3	23.75	6.5-7.0	0.60	0.36	0.00	----
4	23.50	6.5-7.0	0.60	0.36	0.00	----

Tank 1 NO ₂ dilutions	
2x	0.80
4x	0.40
8x	0.20
16x	0.10

Tank 2 NO ₂ dilutions	
2x	0.40
4x	0.20
8x	0.10
16x	0.05

- General Notes:
- Fish weighed
 - Dilution samples tested for determination of nitrite levels exceeding LaMotte test kit value of 0.80 mg/L
 - Ammonia measured twice for Tank 1: 1.50 mg/L measured both times, nitrifying bacteria washed out with emptying of bio-filter??
 - All fish exhibit 'normal' feeding and swimming behavior.
 - a) Are fish gulping at surface? NO; b) Are fish jumping excessively and/or side swimming? NO; c) Do fish have cotton-like spots, or skin sores? NO

05 July 2010 (Monday) - Day 18

System	Temp (°C)	pH	TAN	% NH ₃	NH ₃	NO ₂
1	24.50	6.00	1.50	0.09	0.00	1.40
2	25.00	6.0-6.5	0.40	0.15	0.00	0.60
3	24.75	6.5-7.0	0.20	0.39	0.00	4.00
4	24.75	6.5-7.0	0.20	0.39	0.00	4.00

Tank 1 NO ₂ dilutions	
2x	0.6-0.8
4x	0.3-0.4
8x	0.1-0.2
16x	0.05-0.1

Tank 2 NO ₂ dilutions	
2x	0.30
4x	0.1-0.2
8x	0.05-0.1
16x	<0.05

- General Notes:
- Due to plant color, greenhouse shade removed. Temperatures higher. Need to add covers to prevent excess algal growth.
 - Tank 2 siphoned
 - All fish exhibit 'normal' feeding and swimming behavior.
 - a) fish gulping at surface? NO; b) fish jumping excessively and/or

Tank 3 NO ₂ dilutions	
2x	>0.8
4x	>0.8
8x	0.50
16x	0.2-0.3

Tank 4 NO ₂ dilutions	
2x	>0.8
4x	>0.8
8x	0.50
16x	0.2-0.3

06 July 2010 (Tuesday) - Day 19

System	Temp (°C)	pH	TAN	% NH ₃	NH ₃	NO ₂
1	25.00	5.0-6.0	1.5-2.0	0.05	0.00	1.20
2	26.00	6.0-6.5	0.2-0.4	0.16	0.00	0.20
3	25.50	6.50	0.20*	0.21	0.00	4.40
4	25.00	6.5-7.0	0.20*	0.40	0.00	2.80

Tank 1 NO ₂ dilutions	
2x	0.6-0.8
4x	0.3-0.4
8x	0.1-0.2
16x	0.05-0.1

Tank 2 NO ₂ dilutions	
2x	0.30
4x	0.1-0.2
8x	0.05-0.1
16x	<0.05

- General Notes:
- Temps higher due to shade cloth removal. Waiting to see if plant color improves (i.e. becomes greener)
 - *lower ammonia detection level LaMotte drop test kit used
 - All fish exhibit 'normal' feeding and swimming behavior.
 - a) fish gulping at surface? NO; b) fish jumping excessively and/or

Tank 3 NO ₂ dilutions	
2x	>0.8
4x	>0.8
8x	0.50
16x	0.2-0.3

Tank 4 NO ₂ dilutions	
2x	>0.8
4x	>0.8
8x	0.50
16x	0.2-0.3

**Slowly decreasing pH a concern. Literature indicates that chemicals added occasionally in commercial operations to offset pH decrease due to nitrification process.

**Appendix D: IACUC Protocol and Research Compliance
Correspondence**

K-State Webmail

ewicoff@k-state.edu

± Font Size -

Protocol #2897 - Notification of study completion

From : Emily Wicoff <ewicoff@k-state.edu>

Thu, Dec 09, 2010 06:02 PM

Subject : Protocol #2897 - Notification of study completion 1 attachment**To :** Heath Ritter <hrr@k-state.edu>**Cc :** Steven Starrett <steveks@k-state.edu>, Steve Starrett <stevestarrett@gmail.com>

Hello Heath,

Per protocol directives, please find attached official notification that the secondary study is complete for the above referenced protocol. In addition, the facility is turned over to the property owner and no longer part of Kansas State University research.

After reviewing the attached letter, please do not hesitate to contact us with any questions.

I hope the semester is ending well for you, and have a good Christmas holiday!

Thank you very much,
Emily Wicoff

 **2897 - Notification 1.pdf**
223 KB



Department of Civil Engineering
2118 Fiedler Hall
Manhattan, KS 66506 -5000
785-532-5862
Fax: 785-532-7717

December 5, 2010

Mr. Heath Ritter
Research Compliance Monitor
University Research Compliance Office
203 Fairchild Hall
Manhattan, KS 66502

RE: IACUC PROTOCOL #2897

Dear Mr. Ritter,

In accordance with protocol #2897 approval directives, this memo provides notification that the secondary study (see minor modification approval memo dated 22, 2010) is complete. As outlined in the protocol, all Tilapia are officially turned over to the property owner and are no longer part of a Kansas State University research program.

Please note that, at this time, there are no studies underway for the above referenced protocol. However, additional related research is being considered as a minor modification to the existing protocol. Any subsequent study proposals will be submitted to the Research Compliance Office for approval prior to commencement.

Do not hesitate to contact me with any questions or comments. Thank you.

Sincerely,

A handwritten signature in black ink, appearing to read "S. Starrett", with a long horizontal line extending to the right.

Steven Starrett, Ph.D., P.E., D.WRE
Principal Investigator



**University Research
Compliance Office**
203 Fairchild Hall
Lower Mezzanine
Manhattan, KS 66506-1103
785-532-3224
Fax: 785-532-3278
www.k-state.edu/research/comply

TO: Steven Starrett
Civil Engineering
2132 Fiedler

FROM: Sally Olson, Chair 
Institutional Animal Care and Use Committee

Protocol Number: 2897.2

DATE: October 22, 2010

RE: Approval of Your Modification of Protocol Entitled, "Comparison of Tilapia Fingerling Growth Performance in an Aquaponics System when Fed Commercial Fishmeal, Maggot (common housefly larvae), or Worm (red worm or earthworm); and Water Quality and Nitrification Process Monitoring to Determine Biofilter Proportion Trends for Commercially Produced versus Natural Supplemental Feeds."

A MINOR MODIFICATION OF PREVIOUSLY APPROVED PROTOCOL #2897.1, ENTITLED "Comparison of Tilapia Fingerling Growth Performance in an Aquaponics System when Fed Commercial Fishmeal, Maggot (common housefly larvae), or Worm (red worm or earthworm); and Water Quality and Nitrification Process Monitoring to Determine Biofilter Proportion Trends for Commercially Produced versus Natural Supplemental Feeds."

APPROVED UNTIL: May 27, 2013

The Institutional Animal Care and Use Committee (IACUC) for Kansas State University has approved the protocol identified above as a minor modification of a previously approved protocol. This is an administrative approval by extension from the earlier approval and shares the same expiration date.

All IACUC approvals are followed by annual monitoring, which may include the examination of project records. Announced in-progress reviews will be performed during the course of this approval period by a member of the University Research Compliance Office staff. Any change in the protocol affecting the care or use of live vertebrates must be reviewed by the IACUC prior to implementation. Unanticipated problems related to the humane care or use of animals must be reported to the IACUC immediately.

It is important that your animal care and use project is consistent with submissions to funding/contract entities. It is your responsibility to initiate notification procedures to any funding/contract entity of any changes in your project that affects the use of animals.

K-State Webmail**ewicoff@k-state.edu**

± Font Size ▾

IACUC Protocol #2897 - Minor Modification

From : Emily Wicoff <ewicoff@k-state.edu>
Subject : IACUC Protocol #2897 - Minor Modification
To : Heath Ritter <hlr@k-state.edu>
Cc : Steven Starrett <steveks@k-state.edu>

Fri, Oct 15, 2010 01:02 PM

 1 attachment

Good afternoon Heath,

Please find attached a minor modification to IACUC Protocol #2897. This modification identifies the secondary study parameters.

Please do not hesitate to contact me with any questions or comments. Thank you!

Have a great day,
Emily Wicoff
(913) 626-9337



Protocol 2897 - Minor Mod 2.pdf
91 KB

Mr. Heath Ritter
Research Compliance Monitor
University Research Compliance Office
203 Fairchild Hall
Manhattan, KS 66502



Department of Civil Engineering
2118 Fiedler Hall
Manhattan, KS 66506 -5000
785-532-5862
Fax: 785-532-7717

RE: IACUC PROTOCOL #2897

Dear Mr. Ritter,

This memo serves as notification of a minor revision to the above referenced protocol. The original approved protocol references a secondary study, with the scope to be defined as needed after the initial study.

The secondary study shall be a fish/plant ratio study. The objective is to determine the minimum amount of plant filter area required for commercial fish densities. This information will serve to validate the northern Uganda facility's final tank design. If the allocated plant growth area is inadequate, water re-circulated to the fish tank will be ineffectively cleaned. Elevated nitrogen levels adversely affect fish growth, with excessive build-up eventually resulting in fish mortality.

The following identifies additional details of the secondary study:

1. Fish density will be gradually increased to a maximum commercial level of three to five gallons of water per pound of fish. This will be achieved over a one to two week period, with daily monitoring of the following water quality parameters (similar to initial study): temperature, dissolved oxygen, pH, ammonia, nitrite and nitrate.
2. Once the end fish density is attained and monitored for a minimum period of five days, plant growth area will be gradually reduced. A minimum period of three days will lapse between plant reductions to allow for water quality stabilization and continued monitoring.
3. The minimum fish/plant ratio is considered to correspond to the healthy growing tolerances (not fatal limits) of 0.06 mg/L un-ionized ammonia and 1.0 mg/L nitrite. Nitrate, although relatively non-toxic to fish, will also be monitored. A steady or declining level below 500 mg/L indicates adequate plant area.
4. **Note: The target nitrogen levels are in fact less than the maximum nitrogen levels normally experienced during system start-up and establishment of nitrifying bacteria. If levels in excess of healthy tolerances are detected during the secondary study, one or more of the following actions will be taken: bio-filter and/or fish tank water change, decreased fish density, increased plant filter area. Please note that these actions are identical to those proven successful with higher nitrogen levels experienced during system start-up.**
3. The initial study included four separate systems comprised of three tanks each. For the secondary study, two of the systems will be combined. One of the existing fish tanks will continue to house the tilapia; the remaining three tanks (not including bio-filters) will contain plants.
4. The protocol allocates an additional 60 fish for the secondary study. **Please note that the initial study's fish will be used for the secondary study.** The initial fish are thriving, with only four mortalities experienced over the past months. No additional fish will be introduced at this stage.
5. In accordance with the protocol, the maximum duration of the secondary study is eight weeks.

Please note that all other protocol requirements remain unchanged. Do not hesitate to contact me with any questions or comments. Thank you.

Sincerely,

A handwritten signature in black ink, appearing to read 'S. Starrett', written over a horizontal line.

Steven Starrett, Ph.D., P.E., D.WRE
Principal Investigator



University Research
Compliance Office
203 Fairchild Hall
Lower Mezzanine
Manhattan, KS 66506-1103
785-532-3224
Fax: 785-532-3278
www.k-state.edu/research/comply

TO: All Investigators Using Live Vertebrates
FROM: Sally Olson, Chair
Institutional Animal Care and Use Committee
DATE: September 23, 2010
SUBJ: Annual USDA/KSU Report

Federal regulations require that Kansas State University file an annual report of animal use with the United States Department of Agriculture. **Failure to do so is a violation of the Animal Welfare Act.**

To assist the Institutional Animal Care and Use Committee (IACUC) and the University Research Compliance Office (URCO) in meeting this obligation please fill out the enclosed forms and **return it by October 30, 2010, to:**

Institutional Animal Care and Use Committee
ATTN: Heath Ritter
203 Fairchild Hall

The reporting period is from October 1, 2009, through September 30, 2010. Each protocol is approved by K-State's IACUC using a categorization of pain and/or distress that corresponds with the USDA Pain Categories. Please refer to your protocol as a guide when completing the attached forms.

The first column asks for the number of animals, *as of September 30, 2010*, being bred, conditioned, or held for use in teaching, testing, experiments, research, or surgery but not yet used for such purposes. The other columns are concerned with the numbers of animals used during the reporting period. If you used vertebrate animals in your *experiments, research, teaching, surgery, or tests*, please list them in the appropriate blank. Animals are to be counted only once, regardless of the number of protocols they are used in during the reporting period. If animals seem to qualify for more than one column, they should be counted in the column representing the more painful use. Animals involved in terminal major operative procedures under general anesthesia (i.e., not allowed to recover from anesthesia) should be counted in "Column D." Individual animals used in multi-year studies must be counted each year. For animals subjected to pain or distress for which the appropriate anesthetic, analgesic, or tranquilizing drugs cannot be used, a detailed justification must be attached explaining the procedure that causes the pain or distress and the reasons such drugs were not used.

If you have more than one active protocol you will receive more than one form. Please report the number of animals you used for each protocol on separate forms.

If you and another investigator used the same animals, *you may return a joint report on a single form*. Please enter the other investigator's name as co-respondent at the bottom.

If you used no animals during the reporting period and are holding no animals for future use, simply check the box at the bottom, sign and date the form, and return it to 203 Fairchild Hall. You need not enter 0's or None's in the blanks.

If you never use animals in your research, experiments, teaching, or testing and feel you should be removed from the mailing list for this report, please call the University Research Compliance Office (URCO) at 532-3224.

USDA EXEMPT SPECIES FORM

Protocol# 2897.0

Protocol Title Comparison of Tilapia Fingerling Growth Performance in an Aquaponics System when Fed Commercial Fishmeal, Maggot (common housefly larvae), or Worm (red worm or earthworm); and Water Quality and Nitrification Process Monitoring to

**Institutional Animal Care and Use Committee
KSU/USDA Annual Report
October 1, 2009 through September 30, 2010**

Please use this form to report farm animals used to improve animal nutrition, breeding, management, teaching, or production efficiency, or to improve the quality of food or fiber. Rats of the genus *Rattus* and mice of the genus *Mus* bred for use in research are also to be recorded on this form.

<u>SPECIES</u>	<u>USDA Pain Category B</u> Number being bred, conditioned, or held for use but not yet used.	<u>USDA Pain Category C</u> Number used but not subjected to pain, distress, or pain-relieving drugs.	<u>USDA Pain Category D</u> Number used & subjected to pain or distress, for which anesthetic, analgesic, or tranquilizing drugs were administered	<u>USDA Pain Category E</u> Number subjected to pain or distress, for which the use of anesthetic, analgesic, or tranquilizing drugs would have affected procedures, results, or interpretations.*
Cattle	_____	_____	_____	_____
Horses	_____	_____	_____	_____
Pigs	_____	_____	_____	_____
Sheep	_____	_____	_____	_____
Goats	_____	_____	_____	_____
Domestic Fowl	_____	_____	_____	_____
Rats (genus <i>Rattus</i> only)	_____	_____	_____	_____
Mice (genus <i>Mus</i> only)	_____	_____	_____	_____
Other ^{exempt} Exempt Species:				
<u>Tilapia</u>	_____	<u>60</u>	_____	_____

*Entries in Column E must be fully explained on continuation sheets. At minimum, statements must include (1) a complete description of procedure(s) causing pain or distress and (2) a complete explanation why pain- or distress-relieving drugs were not used (e.g., how drugs would adversely affect the results). Cite any regulations or Federal agency policies that prohibit the use of such drugs.

Yes No Is this protocol a clinical activity using client-owned animals?

I/we used no animals in experiments, research, teaching, or surgery during the reporting period and am/are not holding any animals for such use.

Please print, sign, and date this form, whether you used animals or not, and return it to 203 Fairchild Hall by October 30, 2010.

Steven Starrett

CE DEPT.

Print Name

Department

Co-Respondent

[Signature]

9/29/10

Signature

Date

K-State Webmail**ewicoff@k-state.edu**

± Font Size ▾

IACUC Protocol #2897 - Minor Modification

From : Emily Wicoff <ewicoff@k-state.edu>

Tue, Jul 20, 2010 12:44 PM

Subject : IACUC Protocol #2897 - Minor Modification 1 attachment**To :** Heath Ritter <hhr@k-state.edu>, comply <comply@k-state.edu>**Cc :** Steven Starrett <steveks@k-state.edu>, Steve Starrett <stevestarrett@gmail.com>

Good afternoon Heath,

Please find attached a minor modification to IACUC Protocol #2897. This modification consists of the addition of one individual to the research team.

Please do not hesitate to contact me with any questions or comments. Thank you!

Have a great day,
Emily Wicoff
(913) 626-9337

**Protocol 2897 - Minor Mod.pdf**

376 KB

July 19, 2010



Department of Civil Engineering
2118 Fiedler Hall
Manhattan, KS 66506 -5000
785-532-5862
Fax: 785-532-7717

Mr. Heath Ritter
Research Compliance Monitor
Kansas State University
University Research Compliance Office
203 Fairchild Hall
Manhattan, KS 66502

RE: IACUC PROTOCOL #2897

Dear Mr. Ritter,

This memo serves as notification of a minor revision to the above referenced protocol.

The following individual is added to Section VII. Investigator & Technician Qualifications/Training:

Name: Rebecca Boylan
Training and experience: Hands-on training and online training modules

Ms. Boylan has completed the required on-line training modules.

Please note that all other protocol requirements remain unchanged. Do not hesitate to contact me with any questions or comments. Thank you.

Sincerely,

A handwritten signature in cursive script that reads "Steve Starrett" with a small "ed" at the end.

Steven Starrett, PhD
Principal Investigator

K-State Webmail

ewicoff@k-state.edu

± Font Size ▾

IACUC Compliance - Site Visit and Follow-up Comments**From :** Emily Wicoff <ewicoff@k-state.edu>

Fri, Jul 02, 2010 07:11 AM

Subject : IACUC Compliance - Site Visit and Follow-up Comments

📎 5 attachments

To : hlr <hhr@ksu.edu>**Cc :** Steven Starrett <steveks@k-state.edu>, Steve Starrett <stevestarrett@gmail.com>

Good morning Heath,

Per your visit on Wednesday, please find attached my records document ('Records-Wicoff.xlsx'). As we discussed, I have gone back and added a general note to each day that specifically addresses three behavioral/appearance questions included in the protocol Animal Monitoring Plan.

In addition, please note the following actions that will occur in accordance with our discussions:

1. I have printed off a copy of the protocol, as well as created a master contact sheet. Both items will be left at the greenhouse.
2. A memo will be provided indicating the when/if a second study will occur. An exact animal count will be included, along with narrative on the endpoint and planned housing for the fish in Study 1.
3. At the completion of all KSU studies, a memo will be provided indicating that the facility is being turned over in entirety to the property Owner.

On a last note, I have attached a few photos taken over the last few days. Things look a little different from your first visit, and so I thought these might facilitate any discussion you have with Dr. Jaax.

Thank you again for coming out to the greenhouse. Please do not hesitate to contact me at any time if you have any questions or comments.

Have a great day,
Emily Wicoff

? **Records-Wicoff.xlsx**
72 KB



DSC00515.jpg
142 KB



DSC00536.jpg
229 KB



DSC00465.jpg
418 KB

K-State Webmail

ewicoff@k-state.edu

± Font Size -

IACUC Protocol #2897

From : hlr <hhr@ksu.edu>
Subject : IACUC Protocol #2897
To : ewicoff@ksu.edu

Mon, Jun 28, 2010 09:26 AM

 1 attachment

Hello Emily,

Wanted to confirm that we are still going to meet Wednesday June 30 at 8:30am to observe the animals and activities associated with protocol #2897. Typically on these follow up visits there is a checklist we complete to ensure everything is being completed as indicated by the protocol. I have attached a copy of the check list I will be completing Wednesday for you to review and to help you ensure you have everything in order. Some of the sections may not apply to your project, so do not feel like you have to have something for every box when you see the sheet. But I will have a copy of your protocol and that sheet when we meet Wednesday, and will need to put a check in the boxes that apply. If you have any questions, just let me know. Thanks, and have a good day.

Heath

--

Heath Ritter, MPH
Research Compliance Monitor
University Research Compliance Office
203 Fairchild Hall
Phone: 785-532-3234
Email: hhr@ksu.edu

**URCO Lab and protocol checklists[1][1].doc**48 KB

K-State Webmail

ewicoff@k-state.edu

± Font Size ▾

Research Compliance Committee Site Visit

From : Emily Wicoff <ewicoff@k-state.edu>

Tue, May 25, 2010 02:31 PM

Subject : Research Compliance Committee Site Visit 1 attachment**To :** Steven Starrett <steveks@k-state.edu>, Steve Starrett <stevestarrett@gmail.com>

Hello Dr. Starrett,

I just received a phone call from Heath Ritter (I don't know if he is a Dr. or not) with the Compliance Research Office. He and one other individual will be visiting the site Friday morning at 9:30am. If you can make it too, that would be great.

I was thinking it might also be good for you to have a quick look at it before they head out (even if you aren't able to make the Friday visit), so that you have a chance to see things and make any comments that I can address before their Friday visit.

I was planning on coming to your office tomorrow at our regular 10:30 time. If you prefer, we can just meet out at the greenhouse instead. Attached is a map that starts at the intersection of Denison and Anderson. I can wait at the dirt road entrance so that you don't miss the turn-off. I'll be driving a red Jeep Liberty. By the way, you may note that the address is listed on Google as County Road 412, but know that it is still just Anderson.

Let me know what works for you! If I don't hear back, I will just plan on meeting at your office and you can let me know what you want to do from there. Know that my schedule is very flexible now, and so meeting at the greenhouse at any time will work for me. Thank you!

Have a great day,
Emily

**Aquaponics Facility Directions.pdf**

284 KB

K-State Webmail

ewicoff@k-state.edu

± Font Size ±

Re: IACUC Stipulations- #2897

From : Emily Wicoff <ewicoff@k-state.edu>
Subject : Re: IACUC Stipulations- #2897
To : comply@k-state.edu
Cc : Steven Starrett <steveks@k-state.edu>

Thu, May 20, 2010 02:16 PM

 1 attachment

Good afternoon Adrian,

Please find attached the revised application as requested. A note is provided in italicized red next to each comment listed below, identifying how it is addressed.

A couple quick notes:

1. Regarding the site visit, please know that anytime that is convenient for the committee will work on this end. If the individuals performing the site visit are in agreement, how about setting up a time for this coming Monday (May 24th)? If that day is not suitable, how about Tuesday? Please advise. My cell phone is 913-626-9337, and I can provide a location map to the committee members planning to attend the site visit.
2. Regarding additional project personnel, please note that Wilson Smith has been added. I have provided him the link to the required training module. He will complete that prior to the scheduled site visit, and so approval should be able to be issued with him officially on-board. If it is deemed necessary to add additional personnel, a modification will be submitted prior to their participation.

Please do not hesitate to contact us with any questions or comments, and we look forward to hearing back from you regarding application approval status.

Thank you very much,
Emily Wicoff

----- Original Message -----

From: "comply" <comply@k-state.edu>
To: steveks@k-state.edu
Cc: ewicoff@ksu.edu
Sent: Tuesday, May 18, 2010 5:14:19 PM
Subject: IACUC Stipulations- #2897

Dr Starrett-

The Institutional Animal Care and Use Committee (IACUC) for Kansas State University has reviewed your protocol, "Comparison of Tilapia Fingerling Growth Performance in an Aquaponics System when Fed Commercial Fishmeal, Maggot (common housefly larvae), or Worm (red worm or earthworm); and Water Quality and Nitrification Process Monitoring to Determine Biofilter Proportion Trends for Commercially Produced versus Natural Supplemental Feeds," and requests that you address the stipulation(s) below:

1. Section V.D. (Animals Requested) – Please change the number of animals requested from “1000” to “120”. ***The number is revised as requested.***
2. Section VI.A. (USDA Pain and/or Distress Category) – For “SPECIES #1”, please change to read “Tilapia”. For “SPECIES #2”, please delete information listed. ***The Species #1 title is revised as requested, and all Species #2 information is deleted.***
3. Section VII.8. (Euthanasia) – Though euthanasia is not required for the purposes of this study, please provide a plan for euthanasia should an animal experience an adverse event where treatment may not be appropriate. This plan should reflect the 2007 AVMA Guidelines for Euthanasia. If you should need further assistance please contact the IACUC Chair, Dr. Sally Olson. ***An euthanasia plan in accordance with the 2007 AVMA Guidelines is now included in the application.***

4. Section VI.I.9. (Animal Disposition) – Please clarify the ownership of the animals at the end of the study. ***The application narrative is revised to specifically indicate that the greenhouse owner will assume ownership of the fish and aquaponic systems following project completion.***

5. The committee requires that a site visit be conducted by the URCO and/or a committee member to inspect the facility before the study can commence. ***Please advise on a time convenient for the visiting committee member(s). If possible, does Monday or Tuesday of the upcoming week work?***

6. Comment: Please remember, you must add any persons providing husbandry care to the animals to the protocol. This can be done by submitting a minor modification adding their names to the protocol. All persons listed on the protocol are required to complete any required training. ***Wilson Smith, also a graduate student in Civil Engineering, has now been added to the list. The required training module information has been forwarded to him, which he will be completing over the next couple of days.***

Please address the stipulation(s), revise the protocol application as appropriate, and return it to the University Research Compliance Office, 203 Fairchild or through email at comply@ksu.edu . The IACUC will review your changes and respond accordingly.

Conducting this research without final approval from the committee is a violation of University policy as well as federal regulations.

Thank you,

~Adrian

Adrian Self

Senior Administrative Compliance Specialist

University Research Compliance Office

National Agricultural Biosecurity Center

203 Fairchild Hall, Lower Mezzanine

Kansas State University

Manhattan, KS 66506-1103

Office: 785-532-3224 Fax: 785-532-3278

Email: amsself@k-state.edu



IACUC Application-Tilapia Feeding Study.doc
336 KB

FOR OFFICE USE ONLY: IACUC Protocol # _____ Application Received: _____ Routed: _____
Deadline to Request Full Committee Review: _____
Covered Species? _____ Exempt Species? _____ Both? _____ IBC # _____
Training Complete: _____

A sample protocol is available on our website to assist with completion of this application

Institutional Animal Care and Use Committee (IACUC)

Application for Approval Form

Last revised February 2010

ADMINISTRATIVE INFORMATION:

Title of Project/Course: Comparison of Tilapia Fingerling Growth Performance in an Aquaponics System when Fed Commercial Fishmeal, Maggot (common housefly larvae), or Worm (red worm or earthworm); and Water Quality and Nitrification Process Monitoring to Determine Biofilter Proportion Trends for Commercially Produced versus Natural Supplemental Feeds

Species/ Strain to be Used: Oreochromis niloticus (White Nile Tilapia) and/or Oreochromis aureus (Blue Tilapia)

Type of Application: (check one box on both lines)

- New, Addendum/Modification (please complete modification block on page 2)
 Teaching, Biomedical Research, Research, Other (if other, describe)

Funding Source: PHS/NIH, Other Federal Agency, State, Other

• Principal Investigator: Dr. Steven Starrett Degree/Title: Associate Professor
Department: Civil Engineering Campus Phone: (785) 532-1583

Campus Address: 2132 Fiedler Hall

E-mail: steveks@ksu.edu

Fax #:

Co-Principal Investigators:

Name: Emily Dept: Civil Engineering Degree/Title: MS Student
Wicoff

Name: Dept: Degree/Title:

For IACUC Members Only: (Reference section VI. A.). Proposals that have animals listed only in Pain Category B or C – “no or momentary pain and/or distress,” may be reviewed by a member designated by the IACUC chair. (Pain Category D and E proposals will be reviewed in full committee). Please review this IACUC proposal carefully. If this is a Pain Category B or C proposal, you may request a full committee review if you feel that it is warranted for any reason. If you need clarification or additional information, please call the University Research Compliance Office (2-3224) or the IACUC chair.

- I recommend “Designated” IACUC review of this USDA Pain Category B or C proposal.
- I recommend “Full IACUC” review of this USDA Pain Category B or C proposal.
- This is a USDA Pain Category D or E proposal and should be reviewed in committee.
- Please inform me of the PI’s response(s) to my question(s).

IACUC Member Signature _____ **Date** _____

ANIMAL USE PROPOSAL: Please answer all questions carefully and completely so that the committee can minimize unnecessary delay, and review and approve proposals quickly. The IACUC is required by law to ensure that all animal care and use proposals are reviewed for specific information, and are approved prior to inception of any proposed animal use activity. If you need help or have questions about how to complete this application, please contact the University Research Compliance Office (532-3224, or email: comply@ksu.edu).

A sample protocol is available on our website to assist with completion of this application.

Please provide the requested information in the shaded text boxes. The shaded text boxes are designed to accommodate responses within the body of the application. As you type your answers, the text boxes will expand as needed. After completion, print the form and send the original to Room 203, Fairchild Hall.

FAILURE TO PROVIDE ALL INFORMATION REQUESTED WILL LEAD TO A DELAY IN PROCESSING YOUR REQUEST!!!

Name: Dr. Steven Starrett
Project Title: Comparison of Tilapia Fingerling Growth Performance in an Aquaponics System when Fed Commercial Fishmeal, Maggot (common housefly larvae), or Worm (red worm or earthworm); and Water Quality and Nitrification Process Monitoring to Determine Biofilter Proportion Trends for Commercially Produced versus Natural Supplemental Feeds

MODIFICATION

Is this a modification of an approved protocol? Yes No If yes, please comply with the following:

If you are requesting a modification or a change to an IACUC approved protocol, please provide a concise description of all of the changes that you are proposing in the following block. Additionally, please highlight or bold the proposed changes in the body of the protocol where appropriate, so that it is clearly discernable to the IACUC reviewers what and where the proposed changes are. This will greatly help the committee and facilitate the review.

I. NON-TECHNICAL SYNOPSIS (Please provide a brief narrative description of proposal. This should typically be less than 75 words and be easily understood by nonscientists, e.g. 'We propose to test the effectiveness of a new class of anti-inflammatory drugs against arthritis that develops in the hips of dogs affected by congenital hip dysplasia'):

The proposed study compares the growth performance of Tilapia fingerlings fed commercial fishmeal pellets, maggots, worms, or a ratio of two feeds (i.e. 50% fishmeal and 50% maggots). In addition, several water quality parameters will be monitored in each aquaponics tank. It is anticipated that greater waste levels will be found in the fish tanks designated for a natural feed (i.e. maggots or worms). Higher waste content equates to an increased biofilter requirement.

II. BACKGROUND (concise narrative review of the literature and basis for the study):

BASIS FOR THE STUDY:

This study is performed prior to introducing the concept of aquaponics (a cultivation system that combines aquaculture (fish farming) with hydroponics (growing plants in water, without soil)) to an in-field mission in Gulu Town, Uganda. Gulu Town is located in northern Uganda, and is central to the numerous Internally Displaced Persons (IDP) camps and outlying villages impoverished from 20+ years of civil war.

The use of fish is central to an aquaponics system. Tilapia is specifically selected because it is an African fish with which the target communities of northern Uganda are familiar, is available in that region, is considered a 'hardy' fish capable of withstanding fluctuating conditions, and is high in nutrition and protein as a human food source.

A goal of this study is to identify a non-commercial feed for the tilapia. Fishmeal pellet purchase is not

practical for the remote target communities, and reliance on a commercially produced product limits system applicability.

In addition, the non-commercial feed must require limited technical knowledge or methodology to produce, and be reproducible en masse without expensive equipment or facilities.

LITERATURE NARRATIVE REVIEW:

In summary, no articles were found indicating that a duplicate or near-duplicate study has been performed. With that said, many articles were interesting and informative, providing additional insight into various studies and standard research practices and techniques. In addition, the research provided an additional confidence level in this study's proposed initial fish quantities, selected test feeds, and test duration.

The following articles were found to be the most directly relevant to the proposed study as well as future application in Uganda:

1. Four (4) articles were found related to the feeding of maggots to tilapia. All abstracts indicated that maggots provided equivalent benefits to the fish in comparison to the selected control. The performed studies differ from the proposed in that, in addition to not being part of an aquaponics system, the studies focused on very exact protein content (maggots were utilized to create 'magmeal') or effects to specific organs (i.e. liver). Although results were favorable for the selected criteria, a baseline comparison for maggots (dried, but fed in natural form), needs to be established for comparison in an aquaponics system.
2. One (1) article was found related to the feeding of Spinach Tree leaves to tilapia. Both articles indicated favorable results. This particular tree is said to be found in Yucatan, other parts of Mexico, Central and South America, Africa, Asia and Oceania. Although Spinach Tree leaves will not be tested in this study due to local availability, this potential feed source will be researched for availability and application in northern Uganda. Please note that the Spinach Tree is not related to the locally available spinach leaves that may be incorporated into either the initial or later phase of this study.

III. LITERATURE SEARCH FOR UNNECESSARY DUPLICATION

(If your proposed activity is part of the formal veterinary teaching curriculum and is not research or testing, you may not have to perform a literature search for unnecessary duplication. If it is teaching, please go to <http://awic.nal.usda.gov/> for guidance on how to address Section III. A literature search for unnecessary duplication is required for all proposed research activities using animals.)

A. Date of lit. search (should be within the last month): March 15-19, 2010

B. Search at least two appropriate databases and provide the years of coverage (i.e., PubMed (1966/current), CAB (1972/present). A list of databases is available online at
<http://www.lib.ksu.edu/db/subject/vetmed.html>:

1) CAB (1910/present)

2) Biological Abstracts (1969/present)

3) Wildlife and Ecology Studies Worldwide (1935/present)

C. Keywords/Search Strategy:

The databases were first searched using general terms (i.e. 'fish' and 'feeding study', or 'fish' and 'supplemental feed'). Depending on the number of records returned or the typical subjects of the records returned, a third keyword (i.e. tilapia, maggot, worm, protein, spinach) was used to narrow the search. In a couple instances, a fourth keyword (similar to those used for the third keyword) was used just to verify that no pertinent records were missed during review.

- D. Please provide a concise narrative of the results of the searches relative to unnecessary duplication. You do not need to provide a copy of the actual search with your proposal, but it should be maintained for your records or available to the IACUC if requested. Gayle Willard, Dir, Vet Med Library is the IACUC consultant. Please contact her if you need assistance. Phone 2-6006; email: gwillard@vet.ksu.edu

Concise Narrative:

All databases (CAB, Biological Abstracts, and Wildlife and Ecology Studies Worldwide) were searched as outlined in the Keywords/Search Strategy above. All databases were searched with two general searches: 'fish' and 'feeding study', and 'fish' and 'supplemental feed'. From that point (and depending on number of returned records), the following third keywords were tried in turn: tilapia, maggot, worm, protein, spinach, growth. In some cases, a search with one of the third keywords was further refined with a fourth keyword (taken from the same list as the third keywords).

As discussed in the Literature Narrative Review above (Sec II Background), no articles were found indicating that a duplicate or near-duplicate study has been performed.

Four (4) articles were found related to the feeding of maggots to tilapia. The performed studies with maggots differ from the proposed in that, in addition to not being part of an aquaponics system, the studies focused on very exact protein content (i.e. maggots were utilized to create 'magmeal') or effects to specific organs (i.e. liver). Although results were favorable for the selected criteria, a baseline comparison for maggots (dried, but fed in natural form), needs to be established for comparison in an aquaponics system.

IV. OBJECTIVE/HYPOTHESIS (briefly state the objective of the study – and, if applicable, the hypothesis to be accepted or rejected):

- To determine if maggots or worms can effectively serve as fishmeal supplement wholly or in portion. In addition, the nitrification process and identified water quality parameters will be monitored in all four meal plan systems to determine if additional biofilter is required when feeding with non-commercially produced fish food.

V. MATERIALS AND METHODS:

A. Experimental Design and General Procedures (succinctly outline formal scientific plan for study):

1. Four identical small-scale aquaponic systems will be assembled. Each system consists of the following: 210 gallon fish tank, 55 gallon biofilter tank (with bio-balls), 130 gallon raft plant tank (plants sit on floating styrofoam rafts with roots dangling in water). The water continuously circulates through the system from fish tank to biofilter tank to plant tank, and back into the fish tank. During circulation, ammonia excreted by fish is transformed through the process of nitrification to nitrite (undesirable, harmful form), and then into nitrate (desirable form usable by plants).
2. Each identical small-scale aquaponic system will be dedicated to one of the following food plans: a) 100% commercial fishmeal pellets; b) 100% dried maggot; c) 100% dried worm; d) 50% commercial fishmeal pellet and 50% dried maggot (Note: Each meal plan may be supplemented with dried spinach leaves. If so, the spinach will be incorporated into each meal plan in equal proportions for uniformity.)
3. Each of the four (4) initial systems will contain the following: 15 large (2"-5") tilapia fingerlings, and 1/4 to 1/3 of the plant raft filled (Note: Identical plant numbers, types, and sizes will be placed in each system for uniformity). Additional plants will be added as fish mass increases, which will provide additional waste product for sustainment of increased numbers of plants. Although there is no exact science established, an approximate ratio of one square foot of plantings will be used for every 0.3lb of fish.

4. Daily Food Quantity Provided: The tilapia will be fed three times daily, with the total daily amount of food provided being measured and noted in each tank. A pre-measured quantity of food will be dispersed in phased proportions into the tank. Only if the fish continue to feed will subsequent food portions be placed in the tank. In general, the fish will be done feeding after 10 to 15 minutes. Any uneaten portion will be net skimmed from the tank surface. This eliminates uneaten food from falling to the bottom of the tank and contributing to water fouling. (NOTE: Farmed fish are typically fed 1.5% to 2% of their body weight per day.)

5. Fish Growth Performance Quantified: The tilapia in each system will be weighed en masse (netted and placed in water-filled bucket of known weight) once a week, with disturbance time minimal (should take less than 5 minutes per system). There is no other routine handling of the fish for the project's duration.

6. Water Quality Parameters Quantified: The following parameters will be measured daily (at a minimum): Dissolved oxygen, temperature, pH, and nitrogen levels (ammonia, nitrite, and nitrate in every system component)

Additional Notes:

- 1. The initial study will last for 8 weeks. If the results are favorable as anticipated, the initial study will be extended (with fish growth and water quality parameter monitoring continued) an additional 4 to 8 weeks. Should any of the selected feeds result in unfavorable growth, those fish will be transferred to a standard accepted feed (i.e. commercial fishmeal) after the initial study period. (If drastic growth deterioration is noted early on in the study, feed transfer will occur earlier.)**
- 2. A secondary study will be performed, with an anticipated study term of 8 weeks. The goal of the secondary study will be to a) replicate the initial study results; or b) repeat the study with parameters or feed revised based on initial study results. Similar to the initial study, an extension of 4 to 8 weeks is plausible when fish are thriving and it is beneficial to the overall study.**
- 3. In all cases, fish will continue to be reared post-study to full-size (1 to 1.5 lbs), at which point they will be harvested.**
- 4. Breeding will be eliminated by placing a slightly raised permeable barrier on the bottom of the tank. The barrier will allow for eggs to pass through but exclude fish, prevent egg fertilization by the male and collection by the female for mouth brooding. No hormones will be utilized to prevent breeding.**
- 5. Fish density within each tank will be maintained at a low level. At a grown weight of 1 lb, the density will be 14 gallons per pound of fish. Common aquaculture densities range to less than 5 gallons per pound of fish. This low density eliminates crowding as a potential harmful factor to fish growth, while also mitigating other potential harmful side affects associated with high densities (i.e. low D.O., high ammonia/nitrate concentrations, high CO₂).**
- 6. No pesticides will be utilized on the plants.**

B. Non-animal Alternatives Considered (were non-animal alternatives considered - why are they not used?):

Please refer to section II Background above, where explanation is provided for why the study is being performed. The use of fish is central to an aquaponics system, and a non-animal alternative is not applicable to the study's end-goal.

C. Animal Model and Species/Strain Justification (Explain why animals are needed for your study. Give your rationale and justification for selecting this animal model or species):

Please refer to section II Background above, where explanation is provided for why the study is being performed.

As discussed, Tilapia is specifically selected because it is an African fish with which the

target communities of northern Uganda are familiar, is readily available in that region, is considered a 'hardy' fish capable of withstanding fluctuating conditions, and is high in nutrition and protein as a human food source.

The *Oreochromis niloticus* (White Nile) strain will be utilized so long as the local source has the larger fingerlings (2"-5") at the time of study commencement. If not, then a local supplier of the *Oreochromis aureus* (Blue) strain will be utilized. The White Nile strain is only favored in that the supplier is closer to KSU.

D. Animals Requested –used in research testing or teaching (list genus and species/strain of animal model proposed):

Genus and Species:

***Oreochromis niloticus* (White Nile Tilapia) and/or *Oreochromis aureus* (Blue Tilapia)**

Total number (by species) requested: (this should correspond to the sum of the animals listed in Section VI.A. below. The IACUC approves protocols for a period of 3 years, so the number(s) listed here should represent the TOTAL number of animals requested for a project up to a three-year period- and not simply reflect annual usage projections.)

120 (Note: it is anticipated that only the White Nile strain will be utilized for the study's duration. However, an identical number of Blue Tilapia will be used in the instance that larger White Nile fingerlings are not available at the time of study commencement.)

Source of animals (by species):

White Nile Tilapia: White Brooke Tilapia Farm (KC, MO); Blue Tilapia: R&S Ranch LLC (St. Louis, MO)

E. Justification of Animal Numbers / Data: Analysis: (Research, testing, and teaching activities should be designed to provide a statistically significant result with a minimum number of animals. The specific method by which the number of animals was determined must be clearly stated. Statistical techniques and/or power analysis are appropriate in most cases to maximize the usefulness of the data generated from each animal. However, the IACUC acknowledges that the basis for an appropriate justification of animal numbers depends largely on the nature of the study itself. Prior experience and expertise with the model in question may be taken into account as well, but must be carefully documented in the protocol. The cost of the animal should not be considered as the primary justification for the use of a particular species or model. Consultation with a biostatistician or use of statistical software during the design phase of the experiment may be useful. Websites that may be helpful in performing a power analysis include the following: <http://statpages.org>, <http://www.nal.usda.gov/awic/newsletters/v7n1/7n1chamo.htm>.

Five basic types of studies are listed below, along with brief general guidelines for the justification of animal numbers appropriate for each type of study. These guidelines are intended to provide direction – any given study may not fall neatly into one of these five categories. **Select the appropriate box(s)** below and supply a narrative explanation that will clearly explain your rationale and justification for the number of animals proposed for your activity:

1. **Teaching Protocols:** (Animal numbers are determined by a specified student-to-animal ratio, which must be explained in the justification narrative. Animal numbers should be minimized to the fullest extent possible without sacrificing the quality of the hands-on teaching experience for students).

2. **Tissue Harvest Required for *In-vitro* Work and / or Antibody Production:** (Animal numbers are determined by the amount of tissue required and the number of individual animals needed to provide the appropriate amount of tissue, antibodies, etc. A detailed explanation of how the required number of animals was determined must be included in the justification narrative).

3. **Exploratory Study Requiring No Statistical Analysis – Qualitative:** (use of live animals to demonstrate success or failure of a desired goal, such as the production of transgenic mice): Animal numbers are justified based on the probability of success of the experimental procedure; a detailed explanation of how that probability was determined must be included in the narrative).

4. **Pilot Studies:** (Animal numbers are determined by the investigator's experience and personal judgment, and are typically small. Data collected in pilot studies are generally used to determine statistically relevant sample size calculations for future experiments).

The initial value of 15 tilapia fingerlings per food plan is based both on other short-term fish studies found, as well as a conservative starting platform for follow-up testing or replication.

The total number of animals listed in Sec VI, Humane Considerations, is 120. This number represents:

- 1. Sixty (60) fish for the initial study (four tanks with 15 fish in each tank)**
- 2. Sixty (60) fish for the follow-up secondary study (four tanks with 15 fish in each tank). As indicated above in Sec V.A., Experimental Design and General Procedures, the goal of the secondary study is to a) replicate the initial study results; or b) repeat the study with parameters or feed revised based on the initial study results.**

5. **Studies Requiring Inferential Statistical Analysis:** (If possible, animal numbers are determined by statistical power analysis; the justification statement must include the specific test, i.e., ANOVA, student t-test, chi square, etc., used to determine sample size. Alternatively, minimum numbers of animals may be determined based on pertinent literature for comparable studies in which the desired effect sizes were shown to be statistically significant).

a. **Statistical Test:**

b. **Literature Reference:**

1. Reference- (provide specific reference(s) for numbers justification)

2. Narrative Justification- (provide a succinct justification / rationale for using the reference(s) to determine the numbers proposed in the activity)

6. **Other:** (If your activity does not fit into one of the other categories. If you check this option, you must provide a detailed and defensible description of the rationale for the number of animals proposed for your activity).

VI. HUMANE CONSIDERATIONS:

- A. Pain Category** (for your proposal, please estimate the number of animals in each applicable pain category below to the best of your knowledge – it may be appropriate to list animals in more than one pain category, i.e. controls in Cat. C, infected animals in Cat. D or E. If more than one species is requested, provide pain category estimates on all species requested. We are required to report this animal use and pain category information annually to the USDA).

USDA Pain and/or Distress Category	
<p>Please estimate the number of animals in your proposed activity that would fall into one or more of the following three pain and/or distress categories. It is common to have some animals listed in more than one category – for example an uninfected control versus a challenge group. The cumulative total number for the three Pain Categories should equal the total number of animals requested in Section V.D.</p>	
SPECIES #1 (common name): <u>Tilapia</u>	
Pain Category B (bred, conditioned, or held for use)	# of animals _____
Pain Category C (*no or momentary pain and/or distress)	# of animals <u>120</u>
Pain Category D (**Alleviated Pain and/or Distress)	# of animals _____
Pain Category E (***)Unalleviated Pain and/or Distress)	# of animals _____
(If you are using more than one species in this activity, also complete the following section)	
SPECIES #2 (common name): _____	
Pain Category B (bred, conditioned, or held for use)	# of animals _____
Pain Category C (*no or momentary pain and/or distress)	# of animals _____
Pain Category D (**Alleviated Pain and/or Distress)	# of animals _____
Pain Category E (***)Unalleviated Pain and/or Distress)	# of animals _____
SPECIES #3 (common name): _____	
Pain Category B (bred, conditioned, or held for use)	# of animals _____
Pain Category C (*no or momentary pain and/or distress)	# of animals _____
Pain Category D (**Alleviated Pain and/or Distress)	# of animals _____
Pain Category E (***)Unalleviated Pain and/or Distress)	# of animals _____

If more species are used, please list them on an attached sheet.

* List animals in USDA Pain Category B that are being bred, conditioned or held for use.

* List animals in USDA Pain Category C that will undergo no activity that will produce pain and/or distress, or procedures similar to those that might routinely be performed on humans by a physician without provision of anesthesia or analgesia, i.e. injections, phlebotomy, ear tagging, etc. If you only listed animals in category B or C, you may skip Sections VI.B-F below and resume with Section VI.G.

** List animals in USDA Pain Category D that will undergo procedures where pain-alleviating methods are used, such as anesthesia, analgesia. Surgical patients would fall into this category, even if the procedure were terminal. If you placed animals in Category D or E, you must carefully complete Section VI.B-D below

*** List animals in USDA Pain Category E that will experience unalleviated pain and/or distress. This should be considered only when the use of a pain alleviating strategy would seriously compromise the validity of the study, and/or no other option is available or possible. If you place animals in Category D or E, you must carefully complete Section VI.B-D below.

- The IACUC approves protocols for a period of 3 years, so the number(s) listed here should represent the **TOTAL** number of animals requested for a project up to a three-year period- and not simply reflect annual usage projections.

B. Alternatives to Painful Procedures (if you have animals listed in Pain Category D or E above, you must provide the following information. The Animal Welfare Act requires that you provide a narrative description of methods used and sources searched to ensure that you have verified that alternatives are not available to prevent unnecessary pain and distress. The Animal Welfare Information Center {AWIC} has a site that gives tips for performing this search <http://www.nal.usda.gov/awic/alternatives/tips.htm>. Gayle Willard, Dir, Vet Med Library is the IACUC consultant. Please contact her if you need assistance. Phone 2-6006; email: gwillard@vet.ksu.edu)

1. Date of lit. search (should be within the last month):

2. Search at least two appropriate databases and provide the years of coverage (i.e., PubMed (1966/current), CAB (1972/present). A list of databases is available online at <http://catnet.ksu.edu/db/index.html>:

- 1)
- 2)
- 3)

3. Keywords/Search Strategy:

4. Concise Narrative:

C. Painful Procedure Justification (How do you plan to minimize unnecessary pain and/or distress? You must provide strong justification for having animals in Category D or E above):

D. Attending Veterinarian Consultation: Yes No

Name:

Date Contacted:

(The AWA requires that you must consult the "attending veterinarian" on pain management - if you have animals listed in Pain Category D or E in paragraph VI.A. above. Dr. Kerry Taylor is the "attending veterinarian" for regulatory purposes for the KSU animal care and use program. If animals are listed in Pain Category D or E above, Dr. Taylor must be consulted, 532-5648).

E. **Prolonged Restraint:** Yes No (Describe and justify any plans for prolonged restraint >15 min. Reference IACUC Guideline #2)

F. **Pain or Distress Alleviation** – Will you be administering drugs or compounds for sedation, anesthesia or analgesia as a premedication or for anesthetic induction or maintenance?

Yes No

1. List all drugs or compounds being used for sedation, anesthetic or analgesia during the course of your procedure. Included drug/compound name, dosage, route and frequency.

Drug/Compound	Dosage	Route	Frequency

2. How will you monitor the animal to ensure the animal is properly anesthetized?

G. **Surgery:** Yes No
(Reference IACUC guidelines #4, #10)

1. **Procedure** (Describe surgical procedures planned)

2. **Location** (Where is the surgical procedure to be performed?)

3. **Surgeon/Qualifications** (Who will perform procedures? List their training and qualifications.)

4. **Multiple Survival Surgery Procedures:** Yes No (if yes, please provide justification)
(Reference IACUC guideline #7)

5. **Non-Survival Surgery Procedures:** Yes No

H. **Animal Monitoring** – For protocol purposes, a procedure is defined as an action performed on an animal for research or teaching purposes that has the potential to cause pain or distress to that animal. In order to evaluate pain and/or distress, the KSU IACUC requires an approved plan of how pain or distress will be minimized and documentation of how observations of animals will be recorded.

All procedures performed upon an animal should be listed on an **Animal Monitoring Plan (AMP)** form which is submitted with your IACUC protocol. The AMP form along with the **Animal Observation Record (AOR)** detail how you will observe your animals and what actions you will take in order to minimize pain or distress associated with your research project. Examples of when these forms would be required include animals that undergo a surgical procedure, animals that undergo anesthesia, animals experimentally infected with an infectious disease, or animals inoculated with potential tumor forming cells. Exceptions to the use of the AMP and AOR would be simple procedures with minimal physiological effect upon the animal, examples of which include vaccination, blood collection, or injection of experimental compounds.

Please complete and submit the AMP with the Protocol application. A link to these forms along with further directions can be found at the KSU IACUC homepage. Since the IACUC may follow up on compliance with this requirement, you should maintain these records with your study records after the end of the research project.

1. Does this protocol require the use of the AMP and AOR? Yes No

2. Is an AMP completed? Yes No

3. Indicate where the AMP will be kept (i.e. animal room posted on wall, lab or barn office).
Posted in greenhouse

Animal Monitoring Plan

Protocol #:	PI: Dr. Steven Starrett Tilapia (White Nile or Blue)	PI contact#: (785) 532-1583 1500 Anderson, Manhattan, KS
Animal/Group ID:	Species: Blue)	Animal Location: Manhattan, KS
n/a - NO 'PROCEDURES' PROPOSED - AMP FOR GENERAL FACILITY OPERATION AND INFORMATIONAL PURPOSES ONLY		Date of Procedure: n/a

I. Post-Procedure Care (if applicable)

A. List all drugs/medications to be given following the procedure (include name, dose, route, and frequency)

Drug/Medications	Dose	Route	Frequency
n/a			

B. List all other care to be provided following the procedure and note frequency.

Post-Procedure Care	Frequency
n/a	

II. Observations

- A. Observation Frequency: **2 - 3 times daily (during feeding periods) for pH, Temp, D.O., and fish behavior; 1+ times daily for other water parameters (Note: Fish not handled or relocated!)**
- B. When will the animal be returned to its cage/pen: Fish will be observed within their tanks, and will only be removed for weighing once a week (handling duration less than 5 minutes)
- C. List the parameters to be monitored, criteria to monitor for and directions for recording, and the appropriate action to be taken if necessary.

Parameter	Monitoring Criteria	Intervention
Water pH	7-8	If low: add calcium carbonate or potassium carbonate
Water Temperature	64-90 degrees F (can survive in temps as low as 50 degrees F)	If too cold - place insulating material around tank exteriors, remove shade cloth from greenhouse, last resort: utilize in-line heater or space heater; If too warm - increase greenhouse ventilation/cooling, last resort: utilize in-line chiller
Dissolved Oxygen	3 - 10 mg/L	If too low, verify proper air lift pump operation. If airstones are used, verify they are not plugged or have slipped too deep into water. If all is working correctly, determine if algae in tank is brown and dying off. If so, change water. If low DO levels persist, add air stones to fish tanks.
Nitrogen Levels	Ammonia: 0.25 to 1.0 ppm; Nitrites: 0.25 to 1.0 ppm; Nitrates: 10-20 ppm	If levels are high, stop feeding fish for one day, change the water, and clean all filters. If high levels persist, increasing water recirculating rate and increase biofilter area (i.e. add additional 55 gal. biofilter); (NOTE: during system start-up, spikes often occur and will lower as system balances)

<p>Fish Behavior/ Appearance (Note: These are general items to be aware of for overall fish health. This list is not considered comprehensive.)</p>	<p>1. Are fish gulping at surface? (indicates low oxygen or high CO2 levels) 2. Are fish jumping excessively and/or side swimming (indicates water quality problem - possibly low D.O. or high ammonia or nitrate) 3. Do fish have cotton-like spots, or skin sores? (indicates infection)</p>	<p>1. Verify proper air lift pump operation. If airstones are used, verify they are not plugged or have slipped too deep into water. If all is working correctly, determine if algae in tank is brown and dying off. If so, change water. 2. Do not feed fish for one day and check proper operation of the bio-filter 3. Remove infected fish and place in a separate tank. Handle with separate net to prevent microbe transfer. Change water in main tank. Put 1% salt into tank with diseased fish. Diseased fish can be returned to main tank once salt kills off microbes (typically within a few days).</p>

III. Contact Information:

	Name	Number
PI	Dr. Steven Starrett	(785) 532-1583 (office)
Co-Investigator	Emily Wicoff	(913) 626-9337 (cell phone)
Co-Investigator		
Veterinarian		

In the event that the investigators or the responsible veterinarian cannot be reached or if you have concerns about an animal's care, please contact the KSU Attending Veterinarian (785-532-5648).

I. Animal Manipulations:

1. List all other drugs and compounds that you will be administering other than those listed above in Pain or Distress Alleviation (Section F), on the Animal Monitoring Plan (Section H) or in Euthanasia (Sections J.7). Include drug, dosage, route and frequency.

Drug/Compound	Dosage	Route	Frequency
n/a			

2. **Biosamples** : Yes No (list type & amount, i.e., phlebotomy, minor biopsies, ascitic fluids, etc.)

3. **Tissue Sharing**: Yes No (detail any tissue sharing you plan with other investigators)

4. **Other Procedures**: (list any other procedures you might perform on animals in this project)
n/a

5. **Adjuvants**: Yes No (explain any adjuvant use. Reference IACUC guideline #12)

6. **Chemical Grade Drugs**: Yes No (If you plan to use a chemical grade please list and provide a scientific explanation for its use)

7. **Study Endpoint** (Experimental studies may involve procedures that cause clinical symptoms or morbidity in animals. The IACUC must consider the selection of the most appropriate endpoint(s). This requires careful consideration of the scientific requirements of the study, expected and possible adverse effects research animals may experience (pain, distress, illness, etc.), the most likely time course and progression of those adverse effects, and the earliest most predictive indicators of present or impending adverse effects. Optimally, studies are terminated when animals begin to exhibit clinical signs of disease if this endpoint is compatible with meeting the research objectives. Such endpoints are preferable to death or moribundity as endpoints since they minimize pain and distress. The use of death of the animal as an endpoint is strongly discouraged and must be justified to the IACUC - Reference IACUC guideline # 13). Please describe the endpoint of your study):

8 The aquaponic facility will continue post-study as a home-based small-scale operation once the research project is complete. The greenhouse Owner will assume responsibility and ownership of the fish and aquaponic systems at project end. Permits are not required in Kansas for Tilapia, and so the system will be legal under State law.

Both the initial and secondary studies are slated to last for periods of 8 weeks each. Should fish be thriving, each study will be extended an additional 4 to 8 weeks.

Please note that, in all cases, fish will continue to be reared post-study to full-size (1 to 1.5 lbs), at which point they will be harvested.

a

nasia (Reference the 2007 AVMA Guidelines on Euthanasia, link available on the KSU IACUC or the AVMA website, http://www.avma.org/issues/animal_welfare/euthanasia.pdf)

Will animals be euthanized as a part of your protocol? Yes No

- i. **Method** (include drug, dosage, and route)

Per the 2007 AVMA Euthanasia Guidelines, the section for 'Amphibians, Fish, and Reptiles' indicates acceptable chemical or physical techniques. The proposed method of cranial concussion (stunning) followed by decapitation will be employed should euthanasia be required.

iii. Name of person(s) responsible for performing the euthanasia.

Emily Wicoff, Wilson Smith

9. **Animal Disposition** (what is your plan for the animals after the study is over?)

- Euthanasia
- Adoption
- Long-term holding
- Transfer to another investigator with approved or pending protocol.

Name

Other:

The aquaponic system will continue as a home-based small scale facility once the research project is complete. The greenhouse Owner will assume responsibility and ownership of the fish and aquaponic systems at project end. Permits are not required in Kansas for Tilapia, and so the system will be legal under State law.

J. **Veterinary Care:**

1. **Animal Housing:** (Provide specific information on where the animals will be housed for your activity.)

PLEASE INCLUDE ROOM NUMBER IF KNOWN

- CVM/CMG
- LACS (Biology)
- Bluemont Hall
- Justin Hall
- Other (specify room or area) 1514 Anderson, Manhattan KS (The

location is a commercial-sized greenhouse located on private property within Manhattan. The agreement with the Owner is that the student investigator cleans greenhouse overgrowth in exchange for an approximate 20'x15' space to conduct the study. The greenhouse project space is cleared, with system tanks, pump, etc. due for delivery by April 26th. The system should be assembled and mechanically tested (no fish included) no later than mid-May.)

2. **Special Husbandry Considerations** (Animals will be housed in designated animal rooms/areas, unless approved by the IACUC. Detail special husbandry requirements, i.e. special diets, micro-isolators, etc.):

n/a - Housing will be in aquaponic tanks located in an off-campus greenhouse. Density will be very low, eliminating crowding as a potential harmful factor to fish growth.

3. **Animal Surveillance** (who observes the animals daily for health problems):

Emily Wicoff, cell phone: 913-626-9337

4. **Medical Attention** (who will you contact if there is a health problem requiring veterinary care):

For observed health issues with the fish, any of the following will be contacted: KSU Vet School, Tilapia Supplier, and/or Tilapia Aquaponic Facility Operator contacts.

5. **Wire Bottom Rodent Caging** If you are using rodents, do you propose to house them in wire-bottom cages?

- No Yes (If yes, you must explain the rationale for the use of wire bottom cages scientifically. See IACUC Guideline #14)

N/A

VII. **Investigator & Technician Qualifications/Training** (The Animal Welfare Act and the PHS Policy requires that personnel are appropriately trained in animal care and use matters, and that the professional training is documented. The PI is responsible for ensuring that all

study personnel have completed appropriate professional training. Prior to final approval of an animal care and use protocol, the IACUC requires completion of the required activity specific online training modules and videos for all personnel listed as participating in the animal care and use activity. The URCO will maintain documentation of completion of the online training in a database. All other training documentation is the responsibility of the PI. List all persons involved in your activity below – excluding CMG and LACS personnel – and their professional training. Contact the University Research Compliance Office, 532-3224 for information or guidance on animal care and use training)

<u>Name</u>	<u>Training and experience with animals</u>
1. <u>Dr. Steven Starrett</u>	<u>Online training modules and videos</u>
2. <u>Emily Wicoff</u>	<u>Online training modules and videos; class-room and hands-on experience working in an aquaponics facility (MorningStar Fishermen, Dade City, Florida): training included fish care and recognizing fish behavior</u>
3. _____	_____
4. <u>Wilson Smith</u>	<u>Online training modules</u>
5. _____	_____

**The IACUC is required to review and approve changes in personnel for research or teaching involving animals. Consequently, you must inform the IACUC (in writing) of any changes in animal care research personnel that may occur in your activity. Additionally, you must ensure that new personnel involved in your activity are qualified, have completed the mandatory animal care and use training, and are enrolled in the occupational health and safety program.

- Yes No Are personnel trained in humane handling of this species?
- Yes No Are all personnel enrolled in the KSU Animal Worker Occupational Health and Safety Program? (If no, contact the University Research Compliance Office (2-3224) for information.)
- Yes No Will you need animals for protocol-related training purposes, i.e., experimental or surgical technique development or refinement, etc.? If yes, please specify the technique or procedure to be performed during training (you may reference detailed description in another section of the proposal if appropriate):

Number of animals required to accomplish the proposed training (be sure to include the number of animals requested for training purposes in the total number of animals listed in Section V.D., and Section VI.A.):

- Please indicate how training is/will be accomplished:
- Yes No Training and/or orientation with P.I., CMG or LACS personnel
- Yes No Instruction by supervising animal caretaker
- Yes No Viewing of instructional tapes
- Yes No Other (please specify) Training at MorningStar Fishermen Aquaponics Facility in Dade City, Florida

(NOTE: A comprehensive collection of instructional animal care and use video tapes are “on reserve” in the College of Veterinary Medicine Medical Library. Please contact the service desk in the library on the 4th floor of Trotter Hall at 785-532-6006 if you want to check out any of the IACUC training tapes.)

- Yes No **Individual Technical Procedure Training Form.**
- if you marked no, explain below how you are going to document training or technical competence for personnel to perform the procedure(s) proposed.
- If you are proposing to use a technical, manipulative, or invasive procedure on animals as part of your activity, it is a requirement that you document the competence of your staff to perform the proposed procedure. Documentation of training is necessary for all personnel for specific animal use procedures such as handling, stomach tubing, euthanasia, injections, biopsy, phlebotomy, restraint, etc. This formal training documentation should be maintained in the laboratory or close by and be readily available for IACUC USDA, AAALAC, OLAW and research compliance review as appropriate. It is the PI’s responsibility to ensure that adequate training is performed, and documented. If you need assistance with training for technical procedures, contact the attending veterinarian (532-5648) or the university veterinarian (532-3224) for advice or assistance.

VIII. Hazardous Material Use: (explain if are you using hazardous materials in your study)

1. ****Biological, Infectious or Parasitic agents** No Yes (list)
2. ****Recombinant DNA** No Yes (list)
3. **Hazardous chemicals** No Yes (list)
4. **Radioisotopes** No Yes (list)
5. **Other** No Yes (list)
6. **Select Agent Transfer Program** No Yes (42 CFR 72.6 pertains to a federal program to regulate shipment receipt, and storage of biological or toxic agents believed to have potential use as terrorist weapons. There are about 40 agents currently on the list. IF you are using or planning to use one of the viruses, bacteria, fungi, rickettsial agents, fungi, or toxins on the list, please contact the KSU Environmental Health and Safety Office (785-532-5856) in Edwards Hall, or the URCO (785-532-3224) for information.

(**if "yes" to biological agents or recombinant DNA, you must have a Registration Document from the Institutional Biosafety Committee)

IBC Registration Document #

Approval Date:

IX. **Extramural Funding:** (It is critical that animal care and use procedures detailed in the IACUC protocol are consistent with external funding proposals/documents. Discrepancies between the two documents in animal care and use procedures could jeopardize individual and/or institutional funding and compliance. If you make changes, or they are required by the IACUC, it is your responsibility to ensure that grant or funding agencies are informed.)

- Yes No All animal care and use procedures described in this proposal are consistent with those described in external funding applications/documents. If no is checked, please contact the URCO (532-3224).
- N/A

X. **Clinical Research:** (Does this activity involved client owned animals with naturally occurring, or pre-existing conditions?)

Yes No

XI. **USDA Regulated Activities:** (Is your activity regulated by provisions of the Animal Welfare Act?) Contact the URCO or the attending veterinarian if you need clarification.

Regulated animals would include: - Any live or dead dog, cat, monkey, guinea pig, hamster, rabbit, or warm-blooded animal used for research, teaching, testing, experimentation, or exhibition purposes. Exemptions to this definition are listed below.

Exempt or non-USDA regulated animals would include: (1) lab rats and mice (*Mus / Rattus*) bred for use in research, (2) birds, (3) horses not used for research purposes, and (4) other farm animals such as, livestock or poultry, used or intended for use as food or fiber, or improving animal nutrition, breeding, management, production efficiency, or for improving food or fiber quality.

- Yes** - My activity involves species **COVERED** by the definition of animal in the Animal Welfare Act.
- No** - My activity involves animals that are **EXEMPT** from coverage by the USDA.
- Both** - My activity involves both covered and exempt species.
- Also** - My activity involves NIH Regulated Activities.

Export Controls Training: Kansas State University is required to provide targeted training for faculty and staff engaged in a broad range of university activities that may be covered by federal export controls laws and regulations. These laws apply directly to many activities at K-State. The Provost has mandated that all KSU faculty/staff with a full-time appointment participate in the Export Control Program.

Accordingly, if you not completed the Export Controls power point module, or answered the questions at the end of the short introductory video at the link below, you must do so prior to committee approval of this proposal.

<https://online.ksu.edu/templating/courseHomePage/index.jsp?courseId=101464>

****If you have problems accessing the Export Control Training Program, please call the URCO at 785-532-3224 or by emailing at comply@ksu.edu***

Post Approval Monitoring: The URCO has a Post-Approval Monitoring (PAM) program to help assure that animal care and use activities are performed in accordance with provisions or procedures approved by the IACUC. Accordingly, the URCO staff will arrange a PAM visit as appropriate; to assess compliance with approved activities.

****Questions should be addressed to the University Research Compliance Office (URCO), 203 Fairchild Hall, 785-532-3224, email: comply@ksu.edu**

URCO On-Line Training

The IACUC has mandatory training requirements. This training takes two forms: power point modules and streaming video. Both formats are designed so the URCO can verify if the training has been completed. Completion of required training for all personnel listed on your application is required prior to final approval of an animal care and use protocol.

***Online power point modules: The Introduction/Oversight module is mandatory while the others are based on use of a specific species or procedures.**

***Online video training vignettes (VTV): The following videos are mandatory: Introduction to Compliance, Needle Safety and Sharps, Hand Washing**

The training modules and videos are stored on a secure site and you must have a valid K-State EID and Password to access the modules/videos.

Please check the boxes of the applicable training materials that will be incorporated into the training plan for this protocol.

Training Modules

- #1 Introduction and Overview of Research Testing and Teaching involving Animals (required)
- #2 The Dog in Research, Testing, or Teaching (required if using dogs)
- #3 The Rat and Mouse in Research, Testing, or Teaching (required if using rats or mice)
- #4 The Hamster in Research, Testing, or Teaching (required if using hamsters)
- #5 The Guinea Pig in Research, Testing, or Teaching (required if using guinea pigs)
- #6 The Cat in Research, Testing, or Teaching (required if using cats)
- #7 Rodent Aseptic Surgery (required if performing rodent surgery)
- #8 Cattle in Research, Testing, or Teaching (required if using cattle)
- #9 The Guide for the Care and Use of Agricultural Animals in Agricultural Research and Teaching (required if performing food and fiber research)
- #10 Rabies Awareness (required if using Livestock, Wild Mammals, Random Source Dogs and Cats)

Video Training Vignettes (VTV)

- Introduction to Compliance (required)
- Hand Washing (required)
- Needle Safety and Sharps (required)
- Biosafety Cabinet (Required for work at BL-2 or higher)

Questions should be addressed to the University Research Compliance Office (URCO), 203 Fairchild Hall, 785-532-3224, email: comply@ksu.edu

**INVESTIGATOR ASSURANCE FOR THE HUMANE CARE AND USE OF ANIMALS
FOR TEACHING AND RESEARCH**

(Print this page separately because it requires a signature by the PI.)

P.I. Name: Dr. Steven Starrett

Title of Project: Comparison of Tilapia Fingerling Growth Performance in an Aquaponics System when Fed Commercial Fishmeal, Maggot (common housefly larvae), or Worm (red worm or earthworm); and Water Quality and Nitrification Process Monitoring to Determine Biofilter Proportion Trends for Commercially Produced versus Natural Supplemental Feeds

X. ASSURANCES: As the Principal Investigator on this protocol, I provide assurances for the following:

- A. **Animal Use:** The animals authorized for use in this protocol will be used only in the activities and in the manner described herein, and in accordance with applicable laws, regulations, and guidelines. Any deviation or modification from the procedures detailed herein, must receive prior approval from the Institutional Animal Care and Use Committee (IACUC).
- B. **Duplication of Effort:** I have made a reasonable, good faith effort to ensure that this protocol is not an unnecessary duplication of previous experiments.
- C. **Statistical Assurance:** I assure that there has been an adequate evaluation of the experimental design or strategy of this proposal, and that the minimum number of animals needed for scientific validity are used.
- D. **Oversight:** All experiments, surgeries, or manipulations involving live animals will be performed under my supervision or that of another qualified individual. In procedures involving USDA Pain Category D or USDA Pain Category E, I have consulted with the attending veterinarian on minimizing pain and/or distress.
- E. **Biohazard\Safety:** I assure that in planning this proposal, I have made the proper consideration regarding all applicable rules and regulations concerning radiation protection, biosafety, recombinant DNA issues, etc. Additionally, personnel on my study with contact with animals are enrolled in the Animal Worker Occupational Health and Safety Program.
- F. **Training:** I assure that personnel performing animal procedures\manipulations described in this protocol are technically competent and have been properly trained to ensure that no unnecessary pain or distress will be caused to the animals as a result of the procedures\manipulations. Inexperienced personnel will be properly trained and/or supervised. Additionally, I understand that I must maintain documentation of appropriate animal care and use training for personnel involved in my study.
- G. **Extramural Funding:** If funded by an extramural source, I assure that this application accurately reflects all procedures involving laboratory animal subjects as described in the proposal to the funding agency. (standards are the same, regardless of funding sources).
- H. **Study Duration:** I understand that proposals are approved for 3 years. I also understand that as subsequent annual reviews are conducted, it is my responsibility to provide timely and accurate annual review information when requested, to include notification of the IACUC and the University Research Compliance Office (URCO) when my study is completed.

(Principal Investigator Signature)

(Date)

K-State Webmail

ewicoff@k-state.edu

± Font Size ±

IACUC Stipulations- #2897

Tue, May 18, 2010 05:14 PM

From : comply <comply@k-state.edu>**Subject :** IACUC Stipulations- #2897**To :** steveks@k-state.edu**Cc :** ewicoff@ksu.edu

Dr Starrett-

The Institutional Animal Care and Use Committee (IACUC) for Kansas State University has reviewed your protocol, "Comparison of Tilapia Fingerling Growth Performance in an Aquaponics System when Fed Commercial Fishmeal, Maggot (common housefly larvae), or Worm (red worm or earthworm); and Water Quality and Nitrification Process Monitoring to Determine Biofilter Proportion Trends for Commercially Produced versus Natural Supplemental Feeds," and requests that you address the stipulation(s) below:

1. **Section V.D.** (Animals Requested) – Please change the number of animals requested from "1000" to "120".
2. **Section VI.A.** (USDA Pain and/or Distress Category) – For "SPECIES #1", please change to read "Tilapia". For "SPECIES #2", please delete information listed.
3. **Section VI.I.8.** (Euthanasia) – Though euthanasia is not required for the purposes of this study, please provide a plan for euthanasia should an animal experience an adverse event where treatment may not be appropriate. This plan should reflect the 2007 AVMA Guidelines for Euthanasia. If you should need further assistance please contact the IACUC Chair, Dr. Sally Olson.
4. **Section VI.I.9.** (Animal Disposition) – Please clarify the ownership of the animals at the end of the study.
5. The committee requires that a site visit be conducted by the URCO and/or a committee member to inspect the facility before the study can commence.
6. **Comment:** Please remember, you must add any persons providing husbandry care to the animals to the protocol. This can be done by submitting a minor modification adding their names to the protocol. All persons listed on the protocol are required to complete any required training.

Please address the stipulation(s), revise the protocol application as appropriate, and return it to the University Research Compliance Office, 203 Fairchild or through email at comply@ksu.edu. The IACUC will review your changes and respond accordingly.

Conducting this research without final approval from the committee is a violation of University policy as well as federal regulations.

Thank you,
~Adrian

Adrian Self
Senior Administrative Compliance Specialist
University Research Compliance Office
National Agricultural Biosecurity Center
203 Fairchild Hall, Lower Mezzanine
Kansas State University
Manhattan, KS 66506-1103
Office: 785-532-3224 Fax: 785-532-3278
Email: amsself@k-state.edu

K-State Webmail

ewicoff@k-state.edu

± Font Size ▾

IACUC #2897 Committee Meeting

From : comply <comply@k-state.edu>

Thu, May 06, 2010 11:12 AM

Subject : IACUC #2897 Committee Meeting**To :** steveks@k-state.edu**Cc :** ewicoff@ksu.edu

Dr Starrett-

The Institutional Animal Care & Use Committee will be meeting on Thursday May 6th in Room 137 Waters Hall to review your animal use proposal entitled, "Comparison of Tilapia Fingerling Growth Performance in an Aquaponics System when Fed Commercial Fishmeal, Maggot (common housefly larvae), or Worm (red worm or earthworm); and Water Quality and Nitrification Process Monitoring to Determine Biofilter Proportion Trends for Commercially Produced versus Natural Supplemental Feeds." You are invited to attend the meeting to discuss your proposal. Although it is not necessary that you personally attend the meeting, the committee feels that it is very beneficial when the PI can clarify or address aspects of proposals that IACUC committee members may have questions about. A positive result of this direct interaction is that written requests from the IACUC for information can often be significantly reduced, potentially lessening the written response burden for PI's. It is almost certain that the committee will ask for more written explanations when the PI is not able to discuss the proposal directly. The efficiency of this direct interaction can have the effect of greatly facilitating protocol review and approval time.

Your proposal is scheduled for review at approximately 3:15 pm. Although it is best if you or a qualified representative can attend the meeting, the committee will still be able to review your proposal in your absence.

Please let us know if you would be available to attend or if this will not work with your schedule.

Thank you,
~Adrian

Adrian Self
Senior Administrative Compliance Specialist
University Research Compliance Office
National Agricultural Biosecurity Center
203 Fairchild Hall, Lower Mezzanine
Kansas State University
Manhattan, KS 66506-1103
Office: 785-532-3224 Fax: 785-532-3278
Email: amself@k-state.edu

K-State Webmail

ewicoff@k-state.edu

± Font Size ±

IACUC Application #2897 Received

From : Comply <comply@ksu.edu>

Tue, Apr 27, 2010 03:52 PM

Subject : IACUC Application #2897 Received**To :** steveks@k-state.edu**Cc :** ewicoff@ksu.edu

Dr Starrett-

The status of your IACUC application, "Comparison of Tilapia Fingerling Growth Performance in an Aquaponics System when Fed Commercial Fishmeal, Maggot (common housefly larvae), or Worm (red worm or earthworm); and Water Quality and Nitrification Process Monitoring to Determine Biofilter Proportion Trends for Commercially Produced versus Natural Supplemental Feeds," can be tracked by using our web site at: (<http://www.grad.ksu.edu/comply/status.php>). Your IACUC tracking number is 2897.

According to our database, the people listed below have not done or it has been three years since completing the required Training Modules and Videos.

Steven Starrett module(s) 1

Steven Starrett VTV(s) 1, 2 & 3

Emily Wicoff module(s) 1

Anyone listed on the application will be required to complete the modules and videos before final approval can be granted.

The Training Modules and Videos can be found on our web site at:

<http://www.k-state.edu/research/comply/iacuc/training/index.htm>

If you have any questions, please contact our office.

Thanks,

~Adrian

Adrian Self

Senior Administrative Compliance Specialist

University Research Compliance Office

National Agricultural Biosecurity Center

203 Fairchild Hall, Lower Mezzanine

Kansas State University

Manhattan, KS 66506-1103

Office: 785-532-3224 Fax: 785-532-3278

Email: amsself@ksu.edu



Emily Wicoff <emily.wicoff@gmail.com>

IACUC Application - Tilapia Feeding Study

Emily Wicoff <emily.wicoff@gmail.com>

Fri, Apr 23, 2010 at 4:40 PM

To: comply@k-state.edu

Cc: solson@vet.ksu.edu, Steve Starrett <stevestarrett@gmail.com>, steveks@ksu.edu

To Whom it May Concern,

Please find attached a completed IACUC application for review at the May 6th Full Committee. In addition to the MS-Word document, attached is a .pdf of the signed end signature page. If necessary, I can provide the original hard-copy.

I will contact the Compliance Office on Monday to verify receipt of this correspondence.

Thank you,
Emily Wicoff
cell phone: 913-626-9337
KSU e-mail: ewicoff@ksu.edu

2 attachments

 **IACUC Signature Page - Tilapia Feeding Study.pdf**
201K

 **IACUC Application-Tilapia Feeding Study.doc**
334K



Emily Wicoff <emily.wicoff@gmail.com>

IACUC Application Review - Tilapia Feeding Study

Emily Wicoff <emily.wicoff@gmail.com>

Fri, Apr 23, 2010 at 4:47 PM

To: Sally Olson <solson@vet.k-state.edu>

Cc: Steve Starrett <stevestarr@gmail.com>, steveks@ksu.edu

Good afternoon Dr. Olson,

Thank you very much for your review comments. I really appreciate you taking the time to perform a preliminary review. All of your comments have been addressed with revisions in the submitted application (attached here).

I have submitted my IACUC application to comply@k-state.edu. I copied you on that e-mail for your record as well.

Thank you again!

Have a great weekend,
Emily Wicoff

On Fri, Apr 23, 2010 at 3:03 PM, Sally Olson <solson@vet.k-state.edu> wrote:

Emily, I have read through your protocol

I tried to insert comments, but for some reason was unsuccessful so I am going to just make some comments to you in this email

1. Sec III Lit Search D. : concise narrative: You need to fill this section in.:
2. Sec V Materials and Methods A. I don't think I see where you have said how long the study will be.:
3. Sec V D. Number of animals requested. I am not sure where you have come up with 1000 animals. You have 4 treatment groups and 15/group.

A good place to expand on the "math" of how you figured your numbers is in Sec V. E. where you are justifying your numbers as a pilot study.

4. VI A Pain Category This is a Pain Category C not a B...Category B are only breeding protocols or holding protocols, where no research is done.

5. Sec VI. I 7. Study endpoint. In this section you want to include how long the study is and what you would do if you needed to cut the project short because the fish became ill etc... Narrative now provided as re

Sec VII Training Last questions that asks about Individual Technical Training Form. This should still be yes, b/c those working with the fish still need to be trained in how to recognize illness in the fish, malfunction in the fish tanks etc...

URCO online training.

Everyone will also need to watch the required VTV...

Hopefully this makes sense...sorry I am cutting the time short for you.

Question let me know.

Sally

>>> Emily Wicoff <emily.wicoff@gmail.com> 4/20/2010 1:05 PM >>>

Good afternoon Dr. Olson,

My name is Emily Wicoff, and we spoke last week regarding an IACUC approval process for the use of tilapia. First of all, thank you very much for all of your assistance and advice regarding the application process.

Please find attached the completed IACUC application for your review. Dr. Steven Starrett, my advisor and PI for the proposed study, is also currently reviewing the application. To make the May 6th Full Committee Review Board, I will submit the final document (with any recommended revisions/additions) no later than this Friday, April 23rd.

In filling out the application, I have marked the required module training that appears to be relevant to the study. However, I would like to verify with you that this is correct.

Unfortunately, access to the KSU webmail server has been down since early this morning. I am now attempting to send this from my G-mail account in the hope that you have access or can possibly receive messages through forwarding to another account. I will follow-up with a phone call this afternoon, as well as hand deliver a copy if necessary.

Thank you again.

Have a great afternoon,
Emily Wicoff
cell: [913-626-9337](tel:913-626-9337)
KSU e-mail: ewicoff@ksu.edu



IACUC Application-Tilapia Feeding Study.doc

334K

Appendix E: Introductory Manual and Preliminary Construction Drawings

INTRODUCTORY MANUAL

AQUAPONICS FACILITY FOR FAVOR OF GOD MINISTRIES

GULU TOWN, UGANDA





I. INTRODUCTION

The goal of this material is to provide an introduction to aquaponics and the proposed facility for your ministry. As you read this, please keep in mind that facility geometric and design revisions are anticipated once we meet, discuss your needs in detail, select a site, verify locally available materials and technology, and complete an economic analysis identifying the 'break-even' production rate. *(Note: Cover photo is of adult-sized tilapia at Morningstar Fishermen Training Facility in Dade City, Florida)*

What is aquaponics?

Aquaponics is a cultivation method that combines aquaculture (fish farming) with hydroponics (growing plants in water, without soil) in one system. When managed properly, the result is greater yields of both protein (fish) and vitamin-rich (vegetable) foods without the quantity of water required by conventional single-use systems.

An aquaponic system commonly consists of at least three tanks: fish, bio-filter, and plant.



Our Kansas facility consists of four small-scale systems, as well as breeding and hatchery aquarium tanks. Each small-scale system includes a fish, bio-filter, and plant tank.

How does an aquaponic system work?

The fish provide nutrients for plant growth, and in turn the plants clean the water for the fish. The nitrogen cycle and nitrification, conversion of ammonia to nitrite to nitrate, plays a major role.

Tilapia excrete ammonia through their gills, and ammonia is also produced from fish solid waste. Left in a tank of water without any purification, fish will pollute the water with ammonia to the point that they can no longer survive. A system start-up goal is to establish the bacteria that convert ammonia to nitrite (also toxic to fish) and nitrite to nitrate. System plants are capable of uptaking all three forms of nitrogen, and excess nitrogen recycled to the fish tank in the form of nitrate will not harm the fish.

The desired nitrifying bacteria do not float in the water, but rather reside on surfaces. It is important to provide enough surface area for adequate amounts of nitrifying bacteria to establish themselves in the system. A common way to accomplish this is provision of a bio-filter tank. A bio-filter tank is filled with some form of media, often nontoxic plastic honeycombed shapes, which simply provide a large amount of surface area.



Please refer to the illustration below to further understand the role of fish, bio-filter media, and plants in the never-ending cycling of system water.

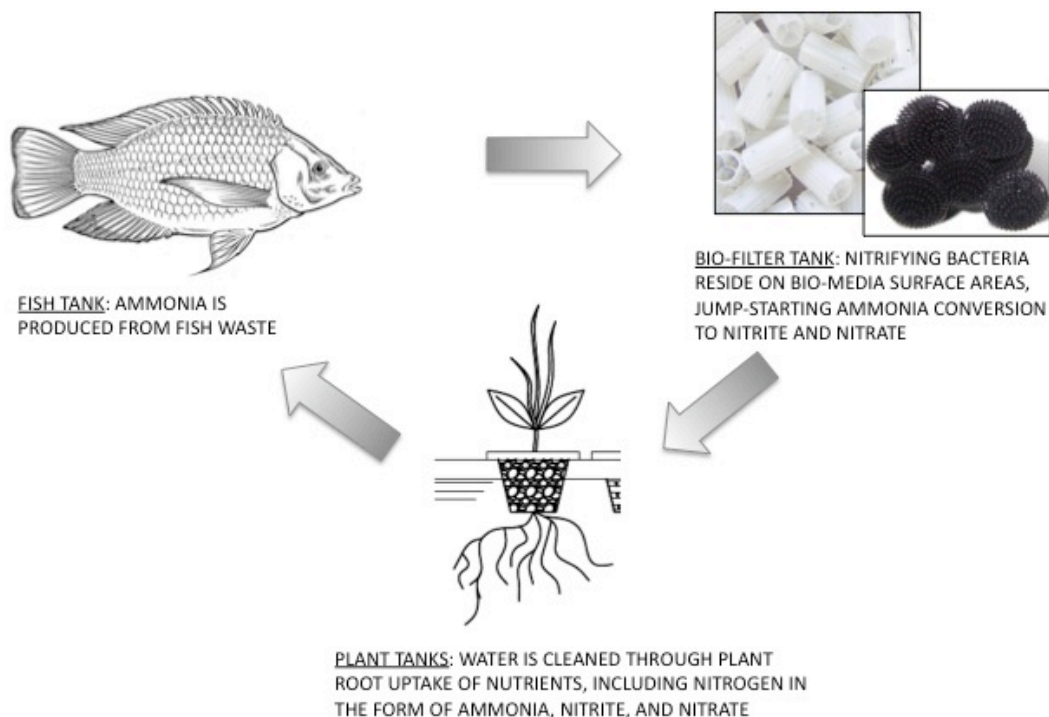

Why are tilapia recommended?

Tilapia is a fish native to Africa and purportedly familiar to Ugandans. Research indicates that White Nile tilapia is regularly harvested from Lake Victoria, and local fisheries also specialize in this species.

Tilapia is a tasty fish low in mercury. Tilapia are prolific breeders and very hardy. This cichlid tolerates wide variances in water quality, which means that they are difficult to accidentally kill! Our personal experience has proven that this fish is relatively easy to culture and does not require years of experience to successfully grow-out.



Tilapia fingerlings feeding in our Kansas facility

What plants/vegetables can be grown in an aquaponic system?

In general, any type of vegetable or plant can be grown in the system, so long as it is not a root crop (i.e. potato or carrot) that will rot when constantly submerged in water. Some crops, such



as tomatoes, flourish more than others in an aquaponic system. A variety of vegetable plants will be selected, based on both our knowledge and your preferences, for the first system start-up. The expectation is that this 'experimental' phase will assist in determining what crops will become your system staples.



Variety of plants/vegetables (including cauliflower, cherry tomatoes, and kale) growing in Morningstar Fishermen tanks

Why aquaponics versus aquaculture?

Aquaponics is self-sustaining in the sense that it is a high-density cultivation method intended to imitate processes found in nature. Expensive filter systems required for tank aquaculture are eliminated through the use of plants, which also provide much-needed vegetables and fruits for human consumption.

II. PROPOSED FACILITY OVERVIEW

The design goal is to provide a fully functioning facility that is easy to operate, economical, composed of enduring materials, requires only basic construction techniques to build, and contains minimal components susceptible to breakage or potentially requiring costly maintenance/replacement.



The resulting preliminary design is basic concrete masonry block and slab foundation construction, with water cycling accomplished through gravity flow and one return water pump per system.

Fish tanks allow for separation of breedstock, fry (baby fish), fingerlings (juvenile fish), and adult fish. One 12,500 liter tank is designed to house the breedstock, fry, and fingerlings through the use of multiple holding nets. Four 12,000 liter grow-out tanks are specified for adult fish. Bio-filter and plant tanks are provided for each fish tank to complete the cultivation cycle and form separate systems. For simplification and economics, a system's individual tanks are placed adjacent to each other and utilize common walls.

Assuming a marketable fish weight of 0.57 kg (1.25 lb), the complete facility allows for fish harvests four times a year. Plant harvests are more frequent and simply occur as selected vegetables grow and ripen.

The following provides narration of specific sheets in the Preliminary Construction Plans. Please refer to that document as needed for complete visualization of the proposed facility.

Sheet F-3, Preliminary Tank Layout

This sheet illustrates one possible configuration of the facility. You will note the five systems described above: four grow-out systems for adult fish, and one system housing the breedstock, fry, and fingerlings.

Potential construction phasing is included. For facility start-up, it is recommended that the breeding system and a minimum of two grow-out tank systems be constructed.

Sheet F-4, Preliminary Breeding Tank:

This sheet illustrates a preliminary design for the breeding, fry, and fingerling tank. Note that multiple holding nets are placed in one large tank for separation. The holding nets are mesh netting attached to a rigid square frame of PVC piping that rests on the top of the masonry block walls.

The system's individual tanks are stair-stepped in height to allow for gravity flow. Water from the fish tank gravity flows into the bio-filter tank. This is accomplished through creation of a two-block wide weir in the common wall. The water then flows the width of the bio-filter before gravity flowing into the plant tank through a similarly constructed weir. Water cycling is completed when a water pump transports plant tank water back to the fish tank.

Use of gravity flow eliminates the potential for any one tank to overflow or accidentally drain. The amount of weir flow automatically corresponds to the amount of return water pumped to the fish tank, minimizing required daily system checks and potential malfunctions.

Sheet F-5, Preliminary Grow-Out Tank:

This sheet illustrates a preliminary design for the grow-out tanks. Similar to the breeding tank design, tanks are stair-stepped to allow for gravity flow through weirs in the common walls.

Due to increased fish density, the grow-out tank systems can support a larger number of plants than the breeding tank. Phase I of the preliminary design provides four elongated plant tanks



per fish grow-out tank. The goal is to have water cycle through each plant bed before being returned to the fish tank. PVC piping and valves allow for water cycling through equilibrium flow. Providing PVC piping and valves between all tanks allows for system operation in multiple configurations.

Sheets F-6 and F-7, Preliminary Details

These sheets further illustrate system construction. Sheet F-6 specifically shows how plants sit in webbed pots situated in floating styrofoam boards. The roots grow down into the water below, clarifying system water through nutrient uptake.

Sheet F-8, Structural Design

This sheet illustrates the concrete block and slab foundation dimensions and reinforcing requirements. The design is universally applicable to fish, bio-filter, and plant tanks walls.

Sheet F-9, Preliminary Hybrid Power System

This sheet illustrates the components of a hybrid system. The concept is to use wind and solar power to run the water and air (for fish tank aeration/oxygenation) pumps, with a back-up generator for extended periods of overcast. During our coordination trip, we will be investigating wind power viability, as well as in-country availability of all energy system components.

III. SYSTEM OPERATION AND MAINTENANCE

The following narrative is provided to give a general idea of the steps required to operate a facility on a day-to-day basis. It should also begin to indicate the manpower required to successfully maintain the systems.

1. Feed the fish 3-5 times a day.
2. Observe fish behavior and appearance: *While feeding the fish, verify 'normal' behavior and appearance. The best way to know if your fish are healthy is visual inspection. A few examples of unhealthy behavior and appearance are:*
 - a. *Floating sideways: likely indicative of poor water quality (i.e. high ammonia, nitrite, carbon dioxide, etc. levels)*
 - b. *Not feeding as usual: indicator common to several problems (poor water quality, infection, etc.)*
 - c. *Gulping at surface: indicates low levels of dissolved oxygen in the water*
 - d. *White spots: indicates infection*
3. Check water quality (with water quality test strips or drop kits). *Although this will initially be completed daily, reduced testing is appropriate when the system is up and running. Once you are used to observing fish*



Drop test kit utilized to monitor water quality in our Kansas facility



behavior, you will often be able to identify when something is wrong without relying solely on tests.

4. Check water levels (visual), refill with well or rainwater as necessary. *Water is lost from evaporation, transpiration, and siphoning waste from tank bottoms.*
5. Inspect fish nets to verify good condition. *The nets utilized in the proposed facility serve four main purposes:*
 - a. *Allow fish separation and multiple use of one tank (breeding, fry, and fingerling tank)*
 - b. *Control breeding (fingerling and grow-out tanks)*
 - c. *Provide for easy tank cleaning*
 - d. *Provide for easy fish harvesting and transfer*
6. Siphon waste from tank bottoms. *Once a system is established, fish tanks will require cleaning one to two times a week. Plant tanks do not require regular cleaning, except for the case of blown debris or if a large amount of algae is noted.*
7. Inspect plants and remove any bugs (i.e. grasshoppers) that are eating leaves excessively.
8. Water plant seed trays. *Use fish tank water, as it is full of nutrients!*
9. Transplant seeded plants to systems as necessary. *Additional plants will be added to a system as the fish grow. As fish density increases, nutrient supply for plants increases.*
10. Ensure fish tanks are covered with a breathable covering when not feeding. *Tilapia jump quite a bit, even right out of the tank! Tank covers serve several purposes: prevent fish loss through jumping, mitigate predatory dangers, and reduce algae growth through restricting sunlight.*
11. Inspect water pumps (visual) to ensure proper operation and flow. *Remove any algae or debris that may have gathered on pump. This will extend pump life.*
12. Inspect energy system for the obvious: dirty solar panels, battery corrosion, generator fuel levels, loose or damaged wiring, etc.
13. Complete equipment routine maintenance. *Although not a daily checklist item, frequency will correspond to individual equipment manufacturer recommendations.*

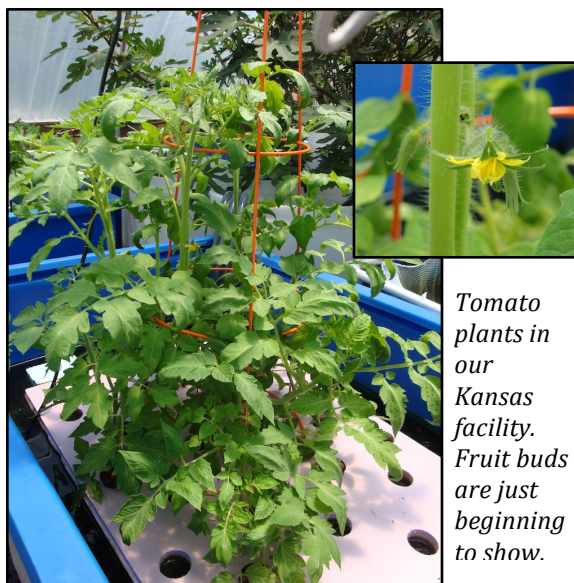

Tomato plants in our Kansas facility. Fruit buds are just beginning to show.



IV. SUMMARY

This information provides a general introduction and overview. It is anticipated to also raise many questions! We look forward to discussing all aspects with you during our upcoming coordination trip.

As you review the introductory material and plans, please begin to think about the following big-picture items:

- As the end user, does this type of facility serve your identified needs? Please do not hesitate to provide any feedback and thoughts.
- What types of vegetables/fruits are preferred locally? What crops would you like to try and cultivate in the system?
- What are potential site locations? Please keep in mind that facility geometry is very flexible, and tanks can be rearranged as necessary.
- What is the status of water supply/well drilling on Ministry property? Do you know any proposed well specifications: depth, anticipated water quantity/pumping rate, water quality? An important aspect of the design is to make sure that the available water supply is adequate to refill the systems as needed. We anticipate completing research on local wells during our trip, and so together we can conservatively determine water availability. From that information, we can identify any additional water supply requirements.
- Would your ministry be able to identify two to three individuals to initially learn the technology, serve as facility operators, and take ownership of the facility for FOG? Although it remains only a future vision for the time being, it is desired that these individuals be willing to assist in continuing our partnership. Knowledge of local culture and dialects enables them to serve as teachers for additional facilities in the region's IDP camps and remote impoverished villages.

AQUAPONICS FACILITY FOR FAVOR OF GOD MINISTRIES

GULU TOWN, UGANDA



Two Fish
FOUNDATION INC.



TWO FISH
FOUNDATION INC.

P.O. BOX 717 Iola, Kansas 66749
Ph: 913-626-9337

Deep Creek
Engineering



DEEP CREEK
ENGINEERING, LLC
10 N. Sycamore St.
Iola, Kansas 66749
Ph: 620-365-8004

REV #	DATE	DESCRIPTION	BY	DATE	DATE

REVISIONS

DATE: NA
SCALE: NTS
BY: RK
DATE: 7/02/10
CHECKED: JW
DATE: 7/02/10
APPROVED: JW
DATE: 7/02/10

CUSTOMER:	PROJECT NAME & LOCATION	DESCRIPTION
FAVOR OF GOD MINISTRIES	GULU TOWN, UGANDA AFRICA	PRELIMINARY FISH TANK DESIGN COVER
		DEEP CREEK ORDER # DC1-2FF

DRAWING#	SHEET
2FF	F-1

PRELIMINARY DESIGN
NOT APPROVED FOR CONSTRUCTION

REV #	DATE	DESCRIPTION

DATE: NA	SCALE: NTS	BY: DR	DATE: 7/02/10

Deep Creek Engineering
 PROJECT NAME & LOCATION
 GULU TOWN, UGANDA AFRICA
 CUSTOMER:
 FAVOR OF GOD MINISTRIES
 PRELIMINARY BREEDING TANK
 DEEP CREEK ORDER # DC1-2FF



Deep Creek Engineering, LLC
 10 N. Sycamore St.
 Iola, Kansas 66749
 Ph: 620-365-8004



Two Fish Foundation Inc.
 P.O. BOX 717 Iola, Kansas 66749
 Ph: 913-626-9337

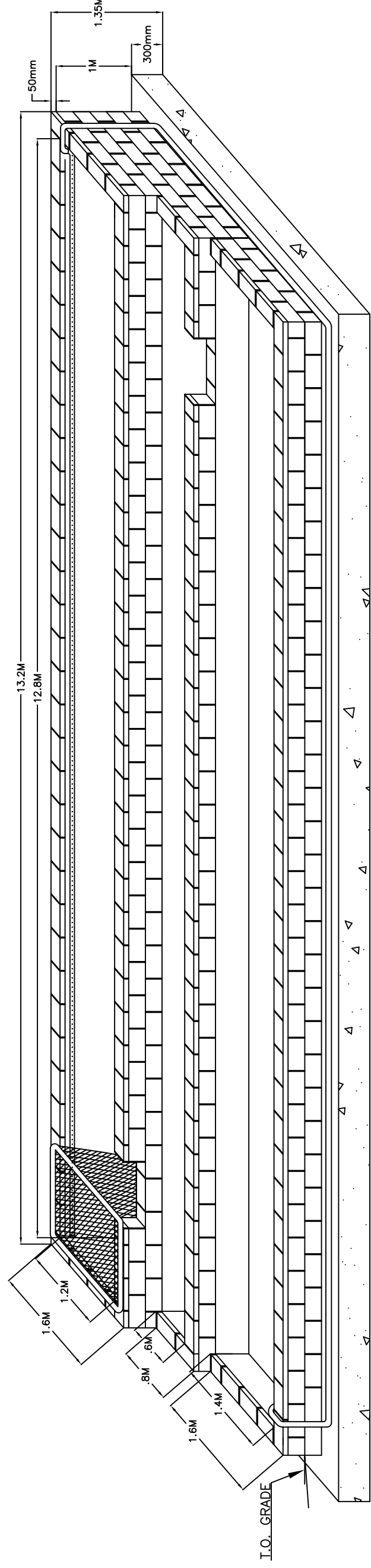
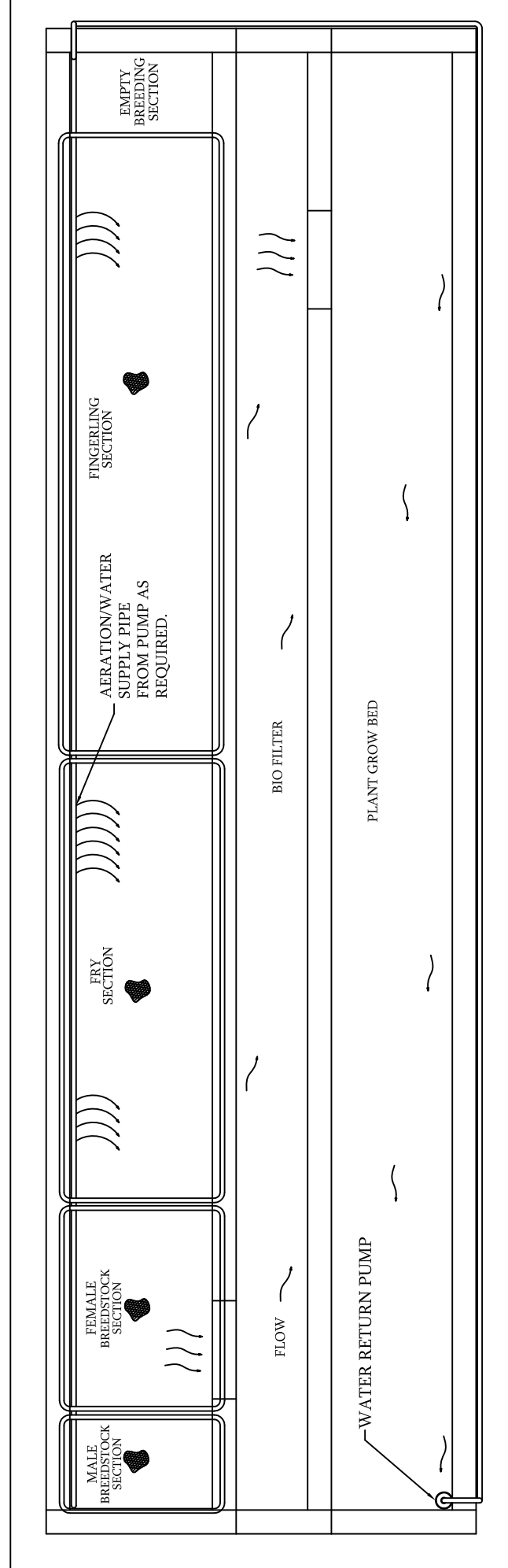

DEEP CREEK ENGINEERING, LLC
 10 N. Sycamore St.
 Iola, Kansas 66749
 Ph: 620-365-8004



Deep Creek Engineering

FAVOR OF GOD MINISTRIES		PROJECT NAME & LOCATION
PRELIMINARY GROW OUT TANK		GULU TOWN, UGANDA AFRICA
DEEP CREEK ORDER # DC1-2FF		

DATE: NA	SCALE: NTS
DATE: 7/02/10	BY: RK
DATE: 7/02/10	CHECKED: JW
DATE: 7/02/10	APPROVED: JW
DATE: 7/02/10	DATE: 7/02/10

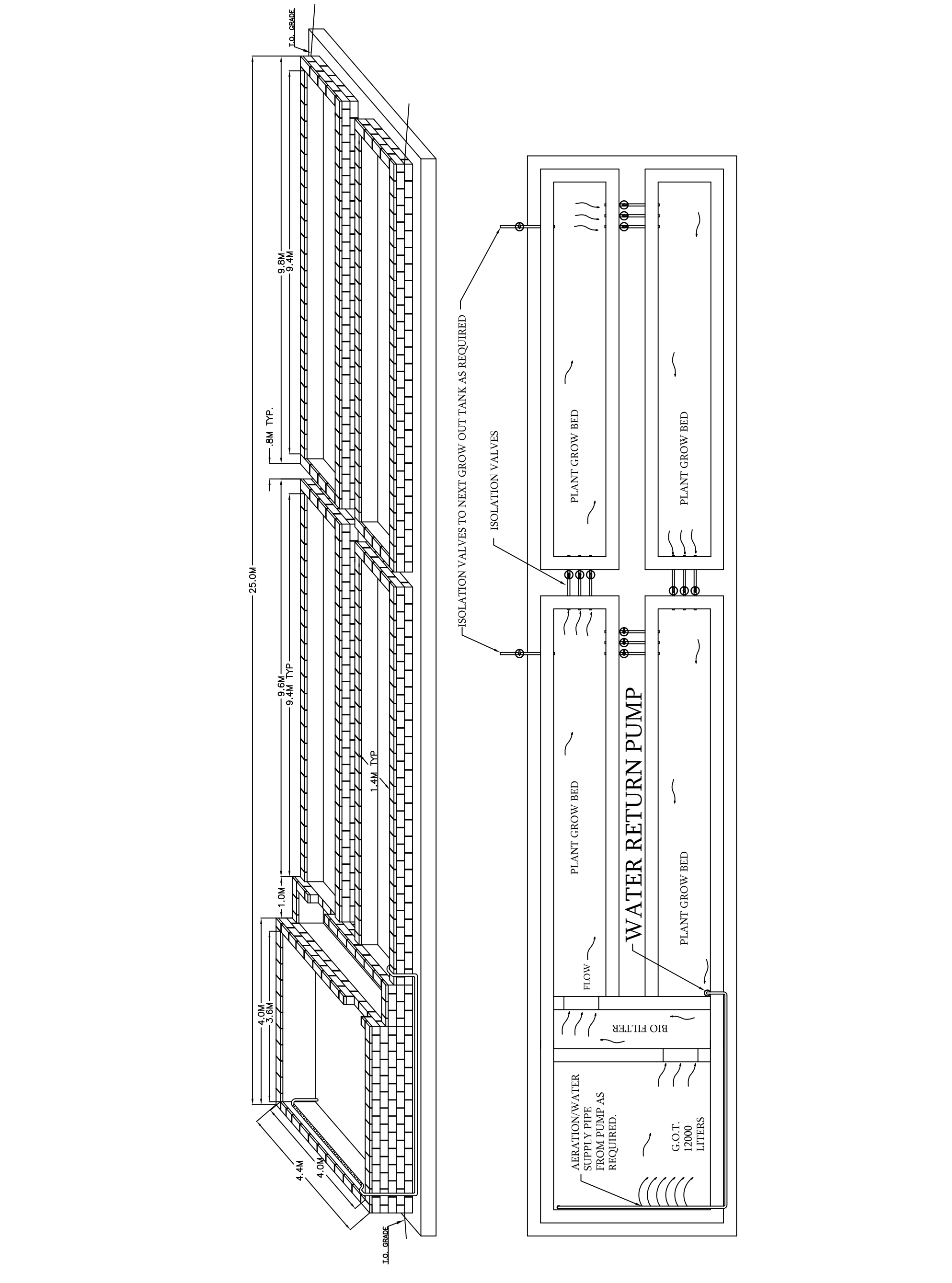

TWO FISH FOUNDATION INC.
 P.O. BOX 717 Iola, Kansas 66749
 Ph: 913-626-9337



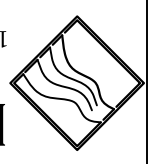

DEEP CREEK ENGINEERING, LLC
 10 N. Sycamore St.
 Iola, Kansas 66749
 Ph: 620-365-8004



TWO FISH FOUNDATION INC.
 P.O. BOX 717 Iola, Kansas 66749
 Ph: 913-626-9337

Deep Creek Engineering

DEEP CREEK ORDER # DC1-2FF

PRELIMINARY DETAILS

CUSTOMER:	FAVOR OF GOD MINISTRIES
PROJECT NAME & LOCATION	GULU TOWN, UGANDA AFRICA

REVISIONS

REV #	DATE	DESCRIPTION

DATE:	NA
SCALE:	NTS
BY:	RK
DATE:	7/02/10
CHECKED:	JW
DATE:	7/02/10
APPROVED:	JW
DATE:	7/02/10

SHEET	F-6
DRAWING#	2FF

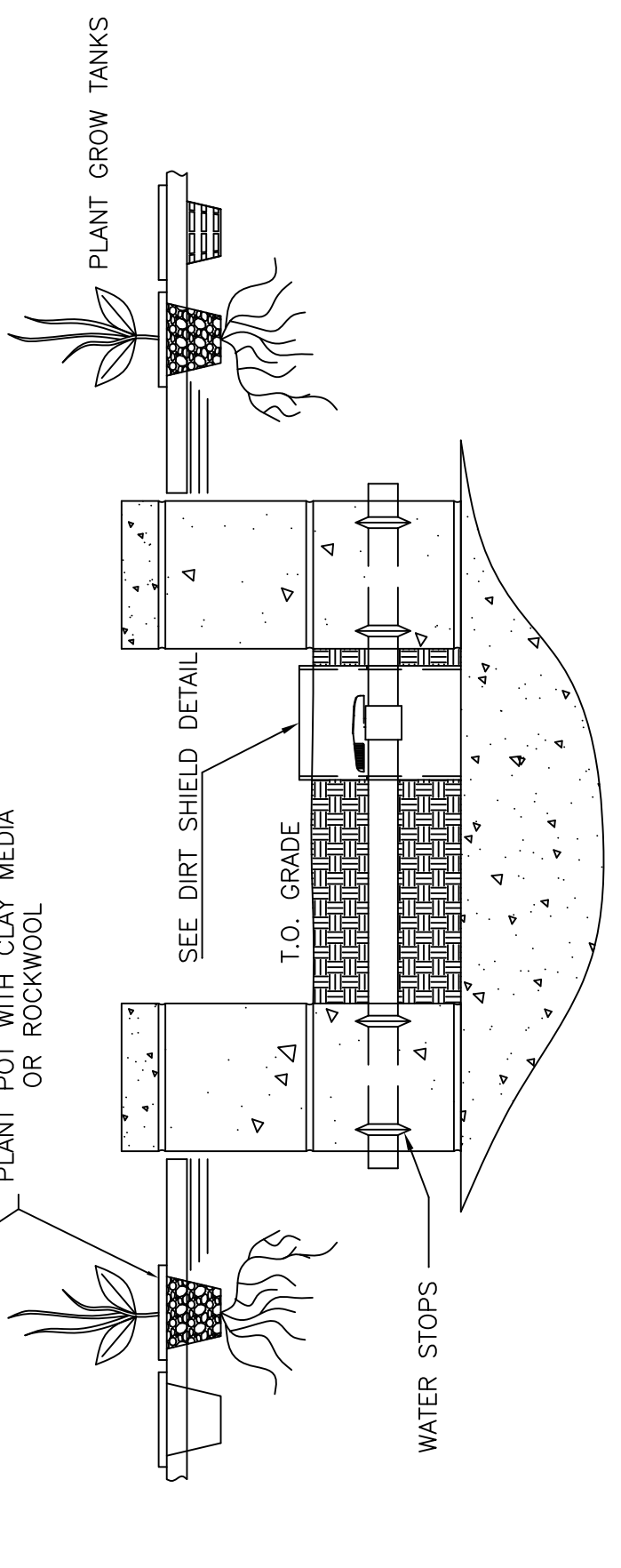
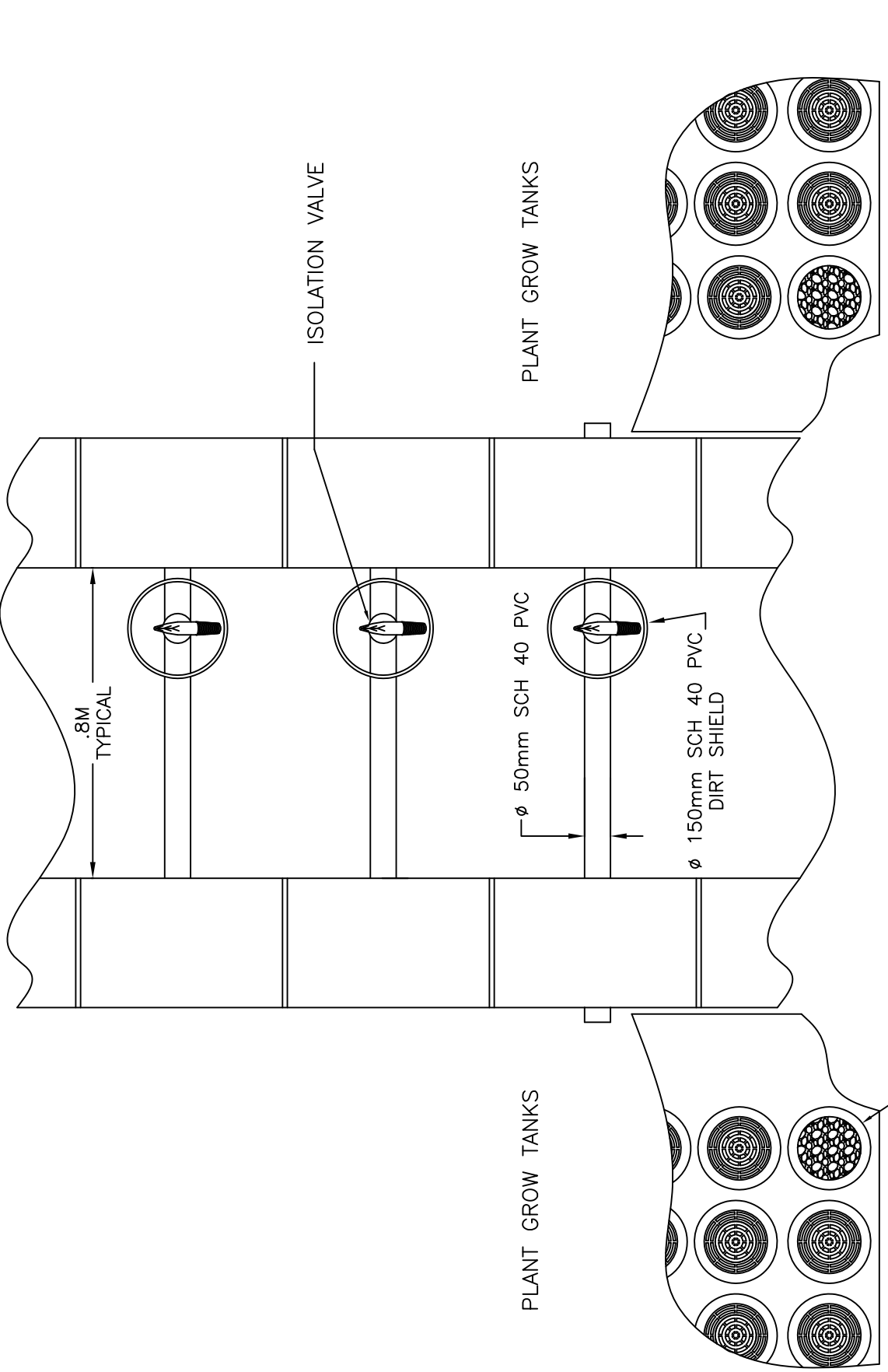

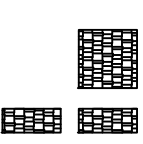
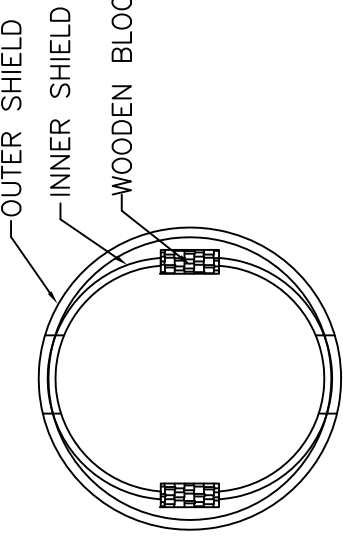

WOODEN BLOCK AS REQUIRED

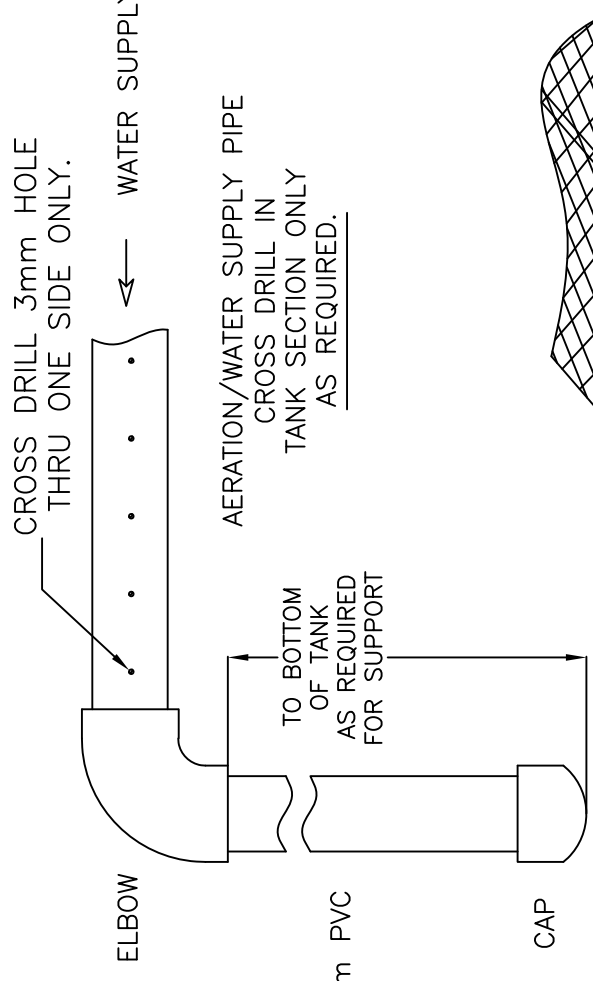
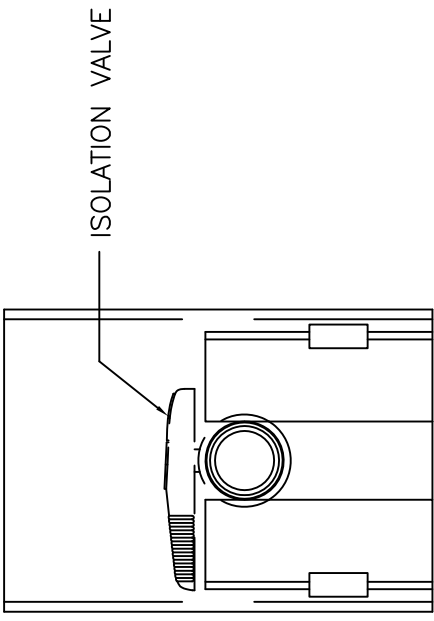

10mm BIO FILTER MEDIA

DIRT SHIELD ASSEMBLY

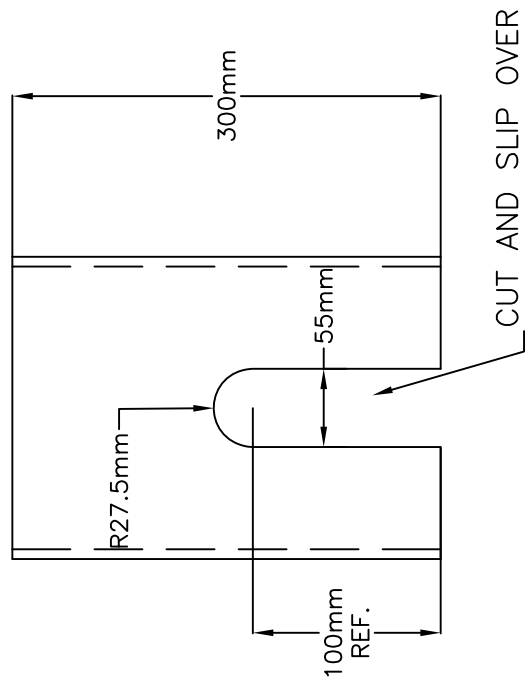
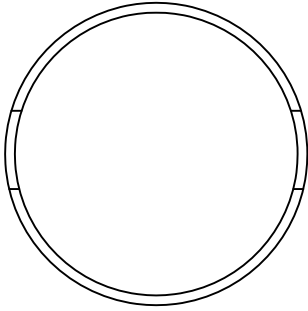

OUTER SHIELD

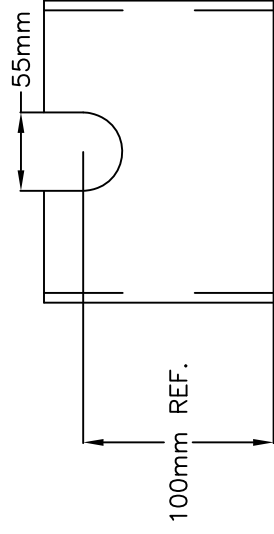
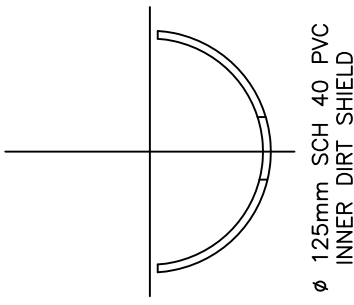

INNER SHIELD

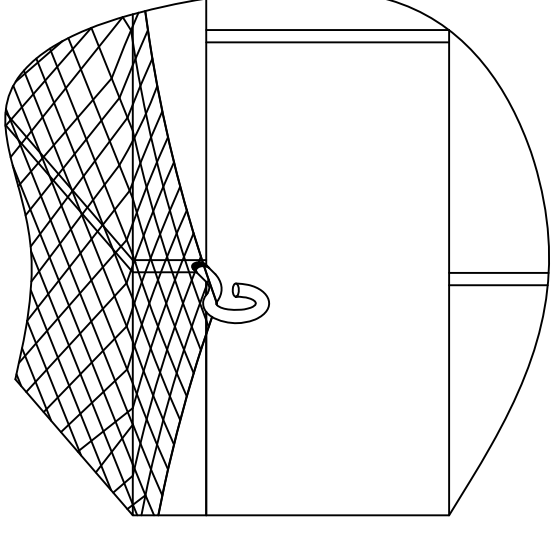

TYPICAL COVER NET AND GROW OUT TANK HOLDING NET DESIGN. INSTALL EYE HOOKS AROUND PERIMETER OF FISH TANKS FOR PROTECTIVE NETS

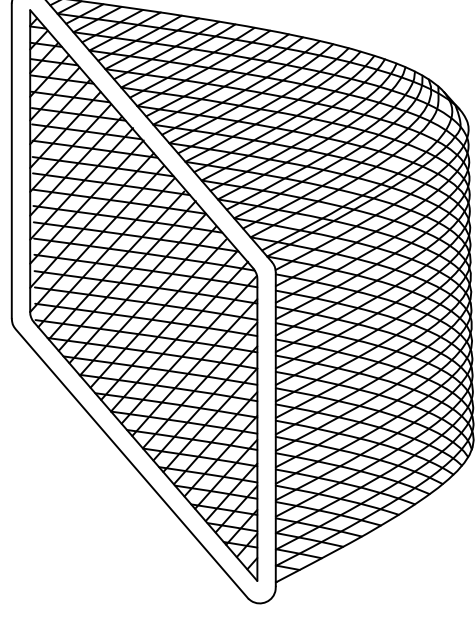

TYPICAL BREEDING TANK HOLDING NET DESIGN. PVC FRAME WITH PURCHASED MESH NET

REVISIONS

REV #	DATE	DESCRIPTION	BY	DATE
NA	DATE:			
NTS	SCALE:			
RK	DATE	DRAWN	DATE	CHECKED
				DATE
				APPROVED
				DATE
				DATE

CUSTOMER:	FAVOR OF GOD MINISTRIES
PROJECT NAME & LOCATION	GULU TOWN, UGANDA AFRICA
PRELIMINARY DETAILS 2	
DEEP CREEK ORDER # DC1-2FF	

TWO Fish FOUNDATION INC.
P.O. BOX 717 Iola, Kansas 66749
Ph: 913-626-9337

DEEP CREEK ENGINEERING, LLC
10 N. Sycamore St. Iola, Kansas 66749
Ph: 620-365-8004

Deep Creek Engineering

NOTES:

1) COAT INSIDE WALLS AND FLOOR WITH CIM 1000.

2) FULLY GROUT ALL CELLS

$F_y = 60 \text{ ksi}$

$F'_c = 2500 \text{ psi}$

$F'_m = 1500 \text{ psi}$

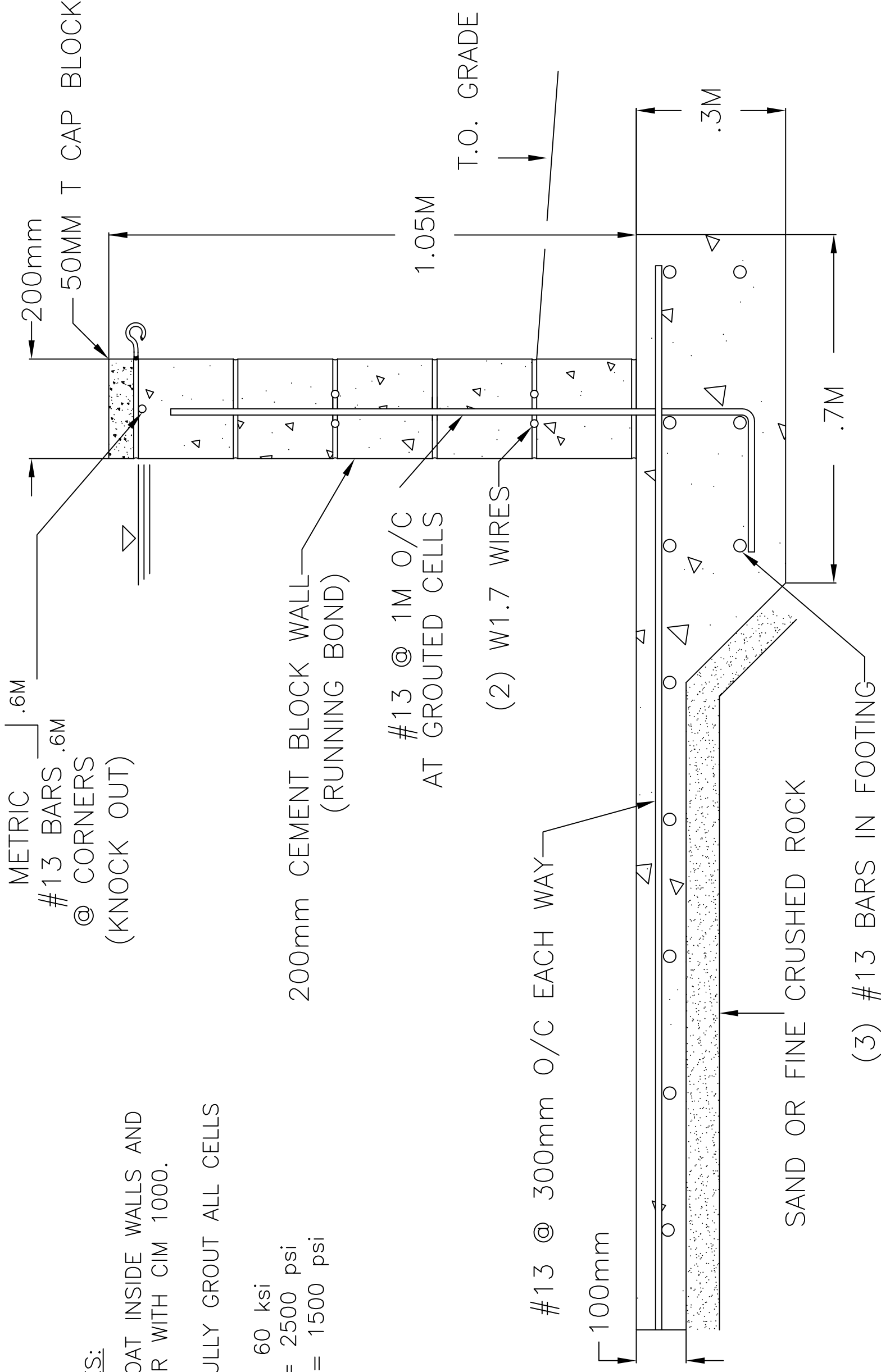

REVISIONS

REV #	DATE	DESCRIPTION	BY	DATE

DATE	SCALE	NTS	DATE

CUSTOMER: FAVOR OF GOD MINISTRIES	PROJECT NAME & LOCATION: GULU TOWN, UGANDA AFRICA	PRELIMINARY FOUNDATION DETAILS	DEEP CREEK ORDER # DC1-2FF
-----------------------------------	---	--------------------------------	----------------------------

TWO Fish FOUNDATION INC.
 P.O. BOX 717 Iola, Kansas 66749
 Ph: 913-626-9337



DEEP CREEK ENGINEERING, LLC
 10 N. Sycamore St. Iola, Kansas 66749
 Ph: 620-365-8004

DRAWING#	SHEET
2FF	F-8

10 N. Sycamore St.
Iola, Kansas 66749
Ph: 620-365-8004

DEEP CREEK
ENGINEERING, LLC

FAVOR OF GOD MINISTRIES		PROJECT NAME & LOCATION
PRELIMINARY BASIC HYBRID POWER SYSTEM		GULU TOWN, UGANDA AFRICA
DEEP CREEK ORDER # DC1-2FF		CUSTOMER:

REVISIONS		REV #	DATE	DESCRIPTION	BY	DRAWN	CHK	DATE
DATE:	SCALE:							
NA	NTS							
DATE:		7/02/10						
DATE:		7/02/10						
DATE:		7/02/10						
DATE:		7/02/10						

DRAWING#		2FF	
SHEET		F-9	

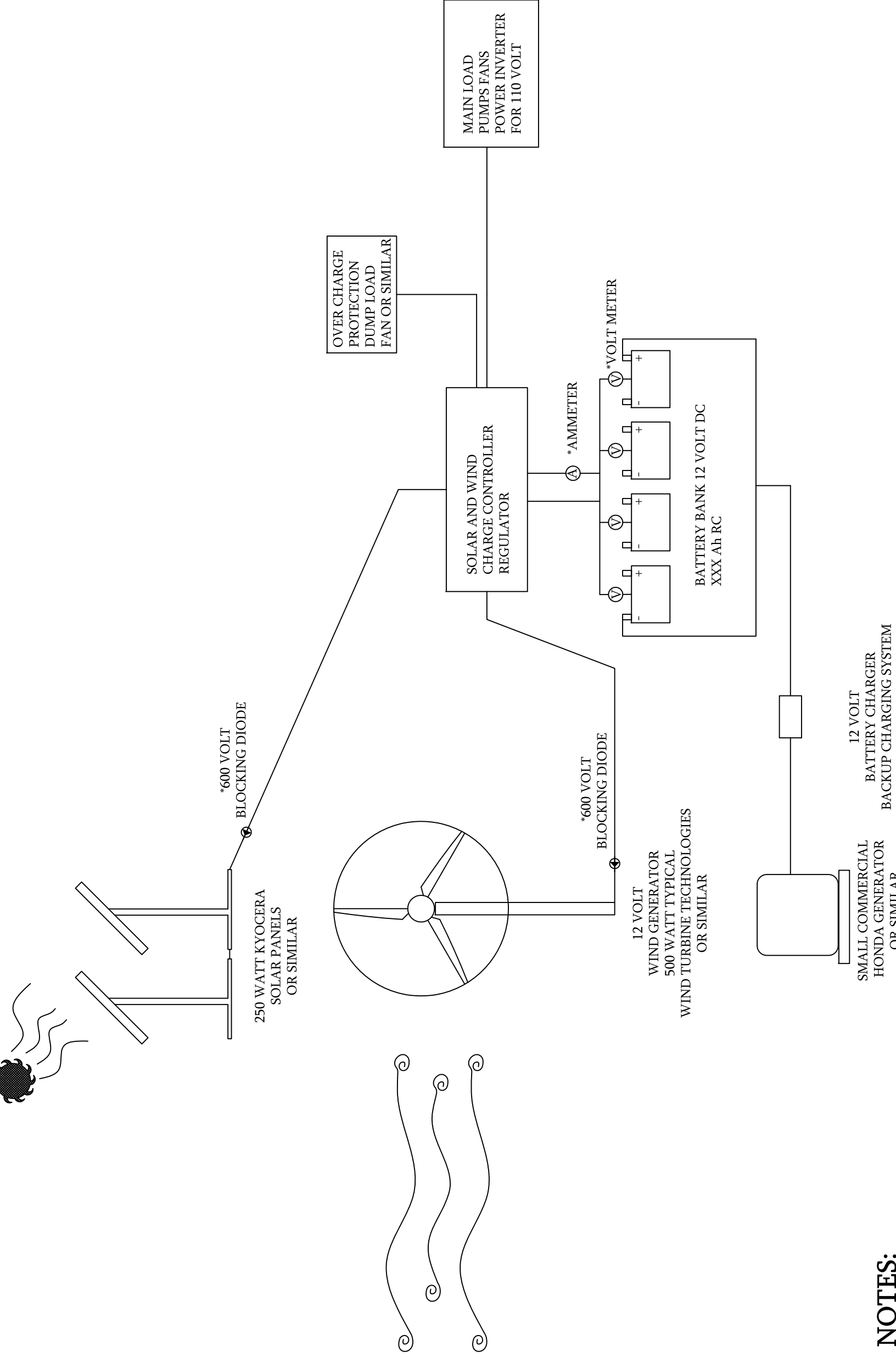

NOTES:

*600 VOLT BLOCKING DIODE AMMETERS AND VOLT METERS MAY NOT BE REQUIRED IF CHARGE CONTROLLER IS EQUIPPED.

*COMPLETE SYSTEMS FOR SALE IN THIS CONFIGURATION LESS THE BATTERY BANK AND BACK UP CHARGING EQUIPMENT.

Appendix F: Revised Preliminary Construction Drawings

AQUAPONICS FACILITY FOR FAVOR OF GOD MINISTRIES

GULU TOWN, UGANDA



PRELIMINARY DESIGN
NOT APPROVED FOR CONSTRUCTION

DEEP CREEK ORDER # DC1-2FF PRELIMINARY FISH TANK DESIGN COVER		PROJECT NAME & LOCATION GULU TOWN, UGANDA AFRICA	CUSTOMER:	
			FAVOR OF GOD MINISTRIES	
DATE: NA SCALE: NTS BY: DRAWN RK	REVISIONS			REV # DATE DESCRIPTION
	DATE: 7/02/10 APPROVED: JW	DATE: 7/02/10 CHECKED: JW	DATE: 7/02/10	

 TWO FISH
 FOUNDATION INC.
 P.O. BOX 717 Iola, Kansas 66749
 Ph: 913-626-9337

 DEEP CREEK
 ENGINEERING, LLC
 10 N. Sycamore St.
 Iola, Kansas 66749
 Ph: 620-365-8004

DRAWING#	SHEET
2FF	F-1

NOTES

- 1) FOUNDATION DESIGNED IN COMPLIANCE WITH ACI 318.
- 2) COAT ALL INTERNAL SURFACES WITH CIM 1000 OR EQUIVALENT.
- 3) ALL APPLICABLE SECTIONS OF ACI-318 SHALL BE FOLLOWED DURING CONSTRUCTION OF THIS FOUNDATION.
- 4) ALL CONCRETE SHALL BE 17.2 MPa MINIMUM YIELD STRENGTH.
- 5) FOUNDATION OUTSIDE TO BE LEVEL WITHIN ±3mm IN ANY 10M. CIRCUMFERENCE. THE LEVELNESS ON THE FOUNDATION SHALL NOT VARY ±6mm FROM AN ESTABLISHED PLANE.
- 6) ALL REINFORCING STEEL TO BE 414 MPa MINIMUM YIELD STRENGTH.
- 7) ALL REBAR SPLICES, HOOKS, AND TAILS TO COMPLY WITH ACI 318.

UNCOATED REBAR:

- #Y12 BAR MIN SPLICE = .6M. STAGGER #13mm BARS 1.2M MIN. O.C.
- #Y12 180° HOOK DIA. = 95mm
- #Y12 180° HOOK MIN. TAIL = 65mm

- 8) MINIMUM ALLOWABLE SOIL BEARING PRESSURE IS 96 KPa.
- 9) IF THE ALLOWABLE SOIL BEARING CAPACITY IS LESS THAN REQUIRED, OR THE SITE SOILS ARE INADEQUATE FOR SUPPORT OF THIS FOUNDATION AND TANK, THEN THIS FOUNDATION DESIGN IS VOID.
- 10) WATER PUMPS TO BE REGULATED TO 5500 LITERS PER HOUR.
- 11) ALL PVC TO BE BELOW GRADE WHERE POSSIBLE.
- 12) NETS IN BREEDING TANK TO BE 50mm PVC FRAME WITH 3mm HANGING MESH NET.
- 13) ALL FISH TANKS TO BE COVERED WITH TOP NET TO HELP CONTROL PREDATION.
- 14) ALL FISH TANKS TO BE COVERED WITH SHADE NET TO HELP CONTROL TEMPERATURE.
- 15) ALL CONCRETE MASONRY WORK SHALL CONFORM TO THE REQUIREMENTS OF BUILDING CODE REQUIREMENTS FOR MASONRY STRUCTURES AND SPECIFICATIONS FOR MASONRY STRUCTURES.
- 16) CONCRETE BLOCK SHALL BE NORMAL WEIGHT HOLLOW LOAD BEARING MASONRY UNITS CONFORMING TO ASTM C-90, GRADE N-1.
- 17) CEMENT USED IN THE MORTAR AND GROUT SHALL CONFORM TO ASTM C-150.
- 18) MORTAR SHALL BE TYPE S AND CONFORM TO ASTM C-270.
- 19) COARSE GROUT USED IN WALLS SHALL CONFORM TO ASTM C-476.
- 20) STEEL REINFORCING BARS SHALL CONFORM TO ASTM A-615, GRADE 60.
- 21) HOT WEATHER CONSTRUCTION TECHNIQUES, ACI 530.1, SECTION 1.8.D., SHALL BE IMPLEMENTED WHEN THE AMBIENT AIR TEMPERATURE EXCEEDS 38 DEGREES CELSIUS OR IF THE WIND SPEED EXCEEDS 3.3 MPS.
- 22) ALL VERTICAL CELLS SHALL BE GROUTED SOLID.
- 23) ALL MASONRY SHALL BE RUNNING BOND. ALL INTERSECTIONS TO BE RUNNING BOND LAP.
- 24) ALL BLOCK CELLS AND CAVITIES BELOW GRADE SHALL BE FILLED WITH GROUT.
- 25) WHEN REINFORCING IS SPECIFIED, PROVIDE AT EACH SIDE OF CONTROL JOINTS, OPENINGS, AND WALL ENDS.
- 26) ALL TANK FLOORS SHALL BE SLOPED TO PROVIDE MULTIPLE LOW POINTS FOR SEDIMENT SETTLING. ROUTINE TANK CLEANING SHALL BE ACCOMPLISHED VIA SIPHONING OF ACCUMULATED WASTE.
- 27) A LENGTH-WISE INTERIOR DIVIDING WALL SHALL BE INSTALLED IN THE FISH TANK TO PROVIDE BOTH RACEWAY FLOW CHARACTERISTICS AND SUPPORT PVC RIMS OF MANAGEABLE SIZED NETS.

REVISIONS

REV #	DATE	DESCRIPTION	BY	RK

DATE:	SCALE:	NTS

DATE	CHECKED	DATE	APPROVED	DATE
7/02/10		7/02/10		7/02/10

CUSTOMER:	PROJECT NAME & LOCATION
FAVOR OF GOD MINISTRIES	GULU TOWN, UGANDA AFRICA

PRELIMINARY NOTES
DEEP CREEK ORDER # DC1-2FF



FOUNDATION INC.
TWO Fish
P.O.BOX 717 Iola, Kansas 66749
Ph: 913-626-9337



ENGINEERING, LLC
DEEP CREEK
10 N. Sycamore St.
Iola, Kansas 66749
Ph: 620-365-8004

DRAWING#	SHEET
2FF	F-2



TWO FISH
FOUNDATION INC.
P.O. BOX 717 Iola, Kansas 66749
Ph: 913-626-9337



DEEP CREEK
ENGINEERING, LLC
10 N. Sycamore St.
Iola, Kansas 66749
Ph: 620-365-8004

Deep Creek Engineering

REVISIONS	
DATE	DESCRIPTION
NA	
SCALE: NTS	
BY: DRAWN	
RK	
DATE	
7/02/10	
CHECKED	
JW	
DATE	
7/02/10	
APPROVED	
JW	
DATE	
7/02/10	

PROJECT NAME & LOCATION	GULU TOWN, UGANDA AFRICA
CUSTOMER:	FAVOR OF GOD MINISTRIES
DEEP CREEK ORDER #	DC1-2FF
PRELIMINARY TANK LAYOUT	

DRAWING#	2FF
SHEET	F-3

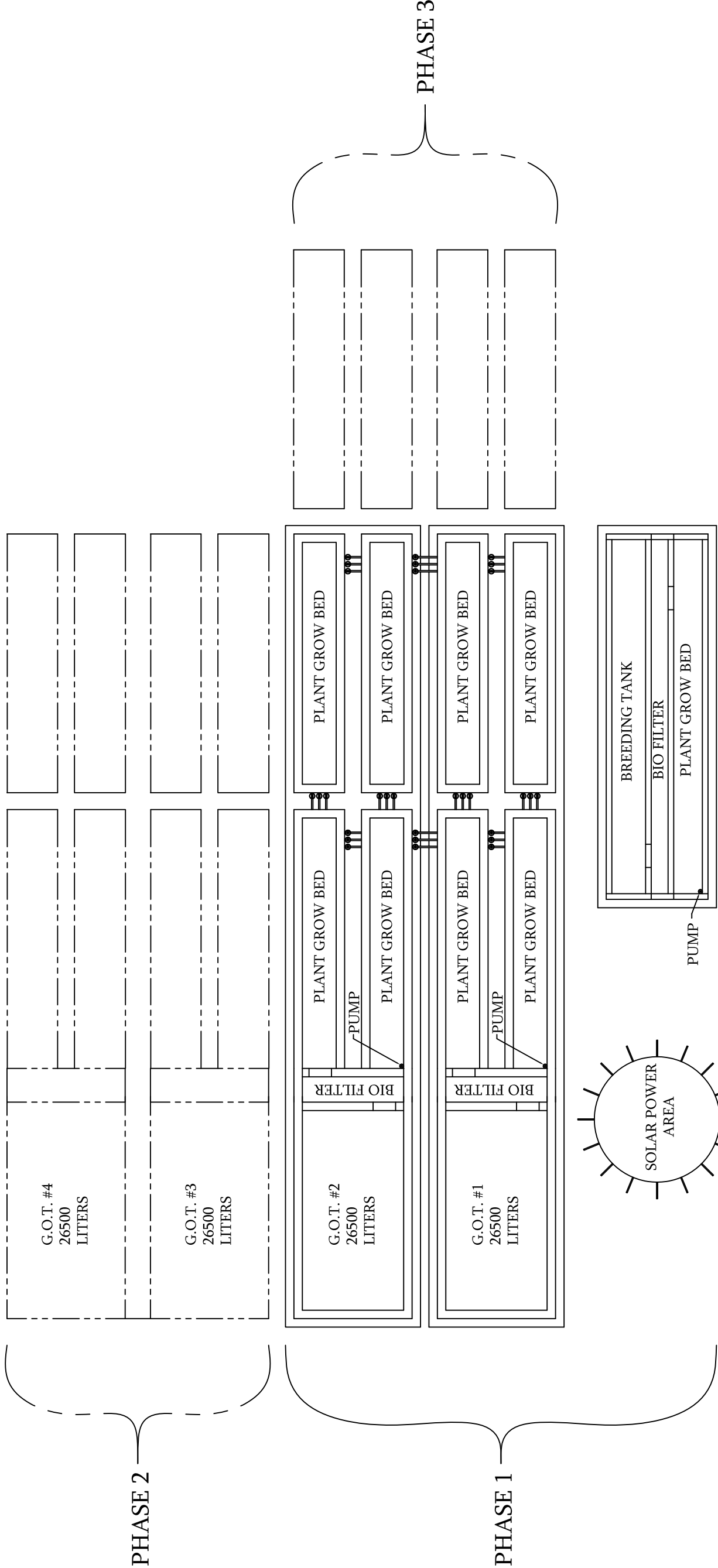

NOTE:
G.O.T. = GROW OUT TANK



Deep Creek Engineering

DEEP CREEK ORDER # DC1-2FF	
PRELIMINARY BREEDING TANK	
PROJECT NAME & LOCATION	GULU TOWN, UGANDA AFRICA
CUSTOMER:	FAVOR OF GOD MINISTRIES
REV #	DATE
DESCRIPTION	BY
SCALE	DATE
NTS	NA
DATE	7/02/10
CHECKED	JW
DATE	7/02/10
APPROVED	JW
DATE	7/02/10

DRAWING#	SHEET
2FF	F-4

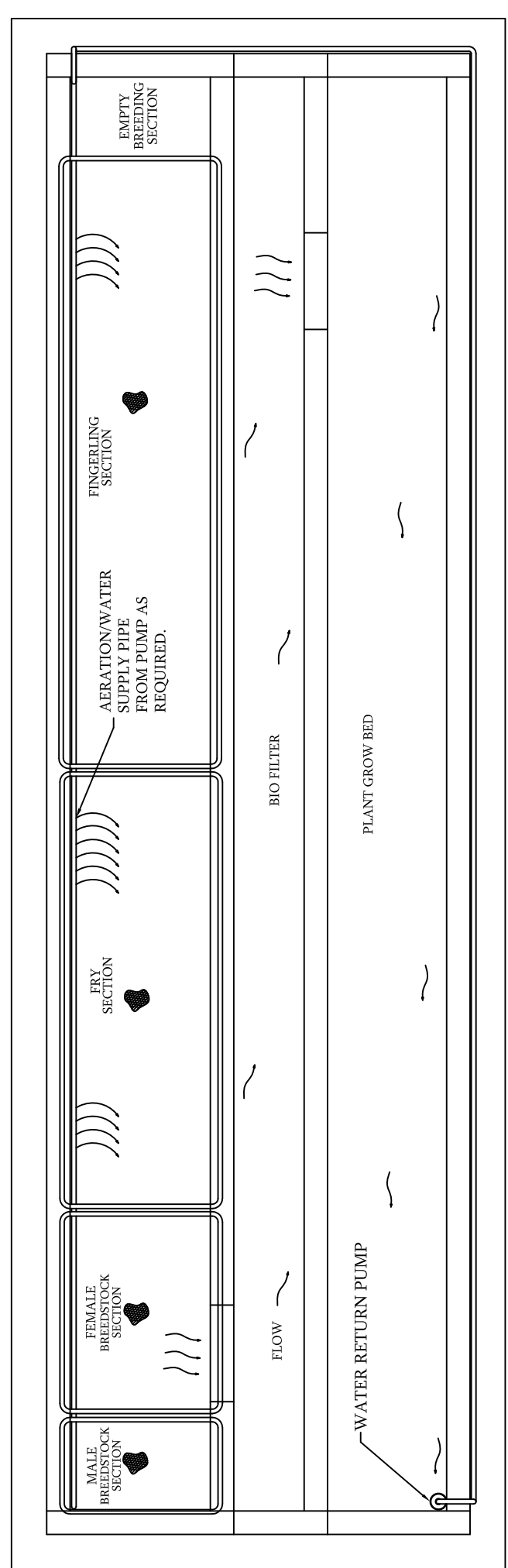
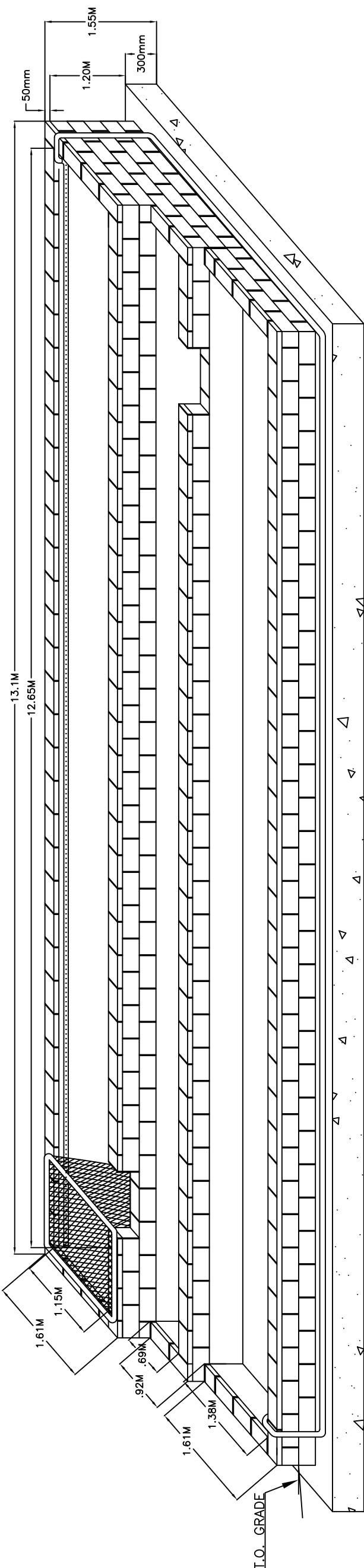

TWO FISH
FOUNDATION INC.

P.O. BOX 717 Iola, Kansas 66749
Ph: 913-626-9337



DEEP CREEK
ENGINEERING, LLC

10 N. Sycamore St.
Iola, Kansas 66749
Ph: 620-365-8004



Deep Creek
Engineering

REVISIONS	
DATE	DESCRIPTION
NA	SCALE: NTS
	BY: DRAWN/RK
7/02/10	DATE
	CHECKED: JW
7/02/10	DATE
	APPROVED: JW
7/02/10	DATE

DATE: NA	SCALE: NTS
BY: DRAWN/RK	DESCRIPTION:
7/02/10	DATE
	CHECKED: JW
7/02/10	DATE
	APPROVED: JW
7/02/10	DATE

CUSTOMER: FAVOR OF GOD MINISTRIES	PROJECT NAME & LOCATION: GULU TOWN, UGANDA AFRICA
PRELIMINARY GROW OUT TANK	
DEEP CREEK ORDER # DC1-2FF	

DRAWING#	SHEET
2FF	F-5

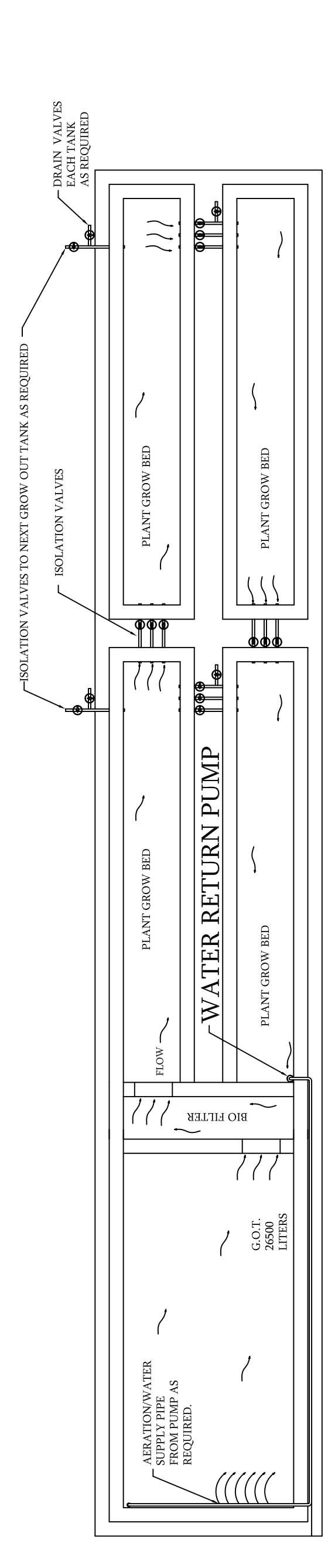
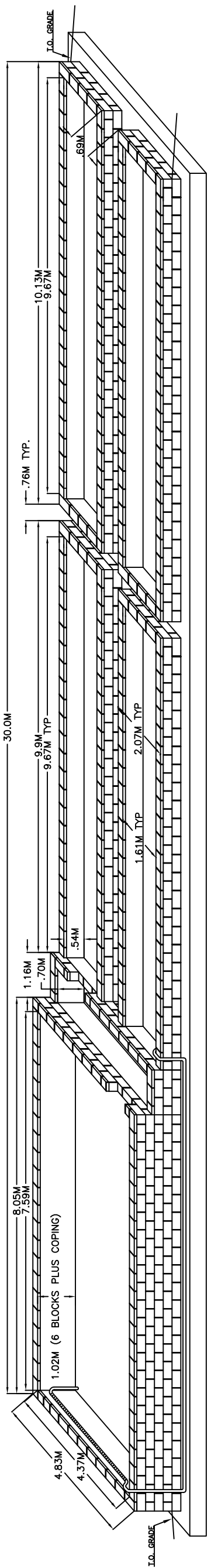

DEEP CREEK ENGINEERING, LLC
 10 N. Sycamore St.
 Iola, Kansas 66749
 Ph: 620-365-8004



Deep Creek Engineering

DEEP CREEK ORDER # DC1-2FF

PRELIMINARY DETAILS

PROJECT NAME & LOCATION: GULU TOWN, UGANDA AFRICA

CUSTOMER: FAVOR OF GOD MINISTRIES

REV #	DATE	DESCRIPTION

DATE: NA
 SCALE: NTS
 BY: RSK
 DRAWN: RSK
 DATE: 7/02/10
 CHECKED: JW
 DATE: 7/02/10
 APPROVED: JW
 DATE: 7/02/10

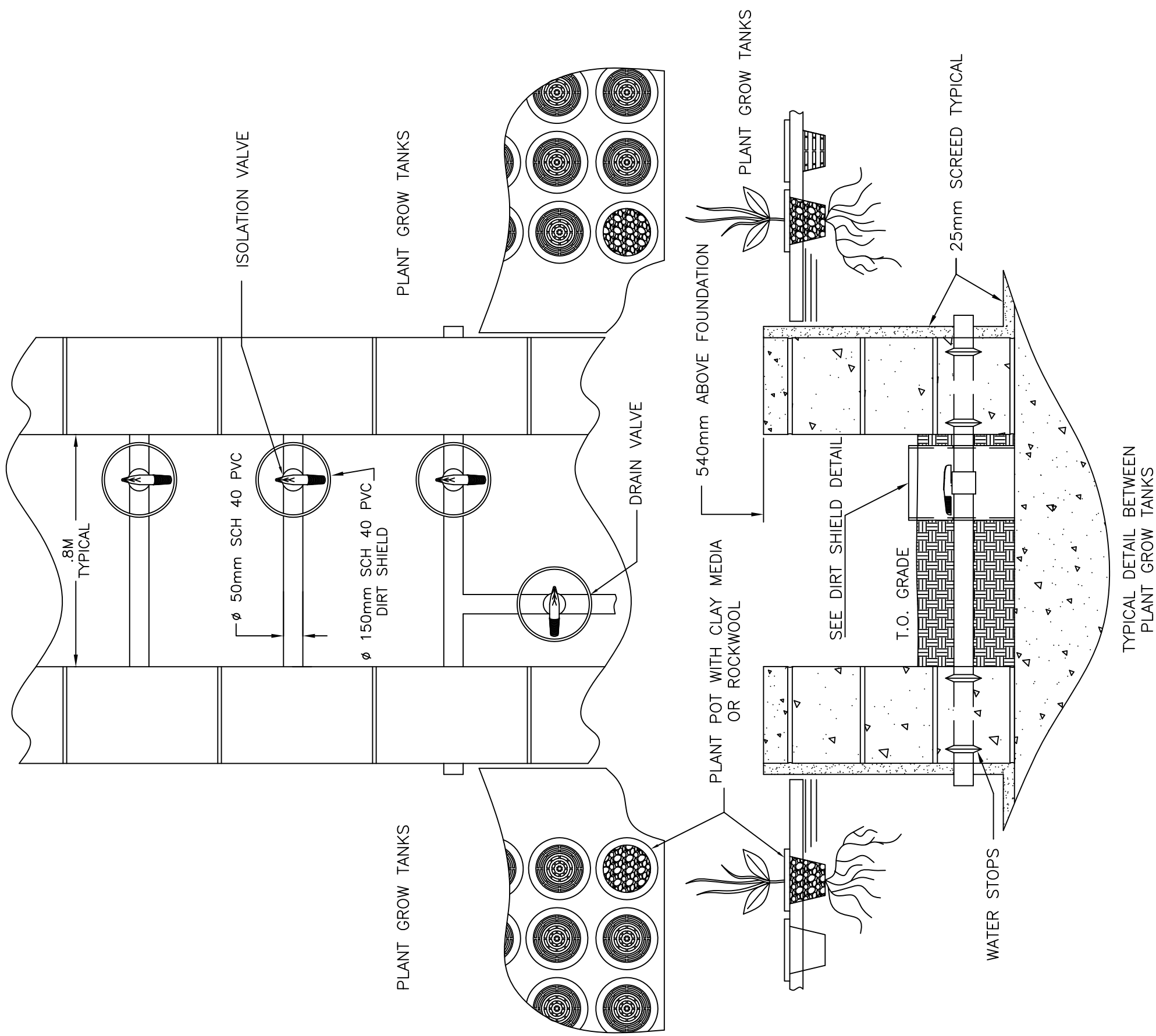

DRAWING#	2FF
SHEET	F-6

TWO FISH FOUNDATION INC.
 P.O. BOX 717 Iola, Kansas 66749
 Ph: 913-626-9337





TWO FISH
FOUNDATION INC.
P.O. BOX 717 Iola, Kansas 66749
Ph: 913-626-9337

Deep Creek Engineering

DATE:	NA
SCALE:	NTS
BY:	RK
DATE:	7/02/10
CHECKED:	JW
DATE:	7/02/10
APPROVED:	JW
DATE:	7/02/10

REVISIONS

REV #	DATE	DESCRIPTION

CUSTOMER: FAVOR OF GOD MINISTRIES
PROJECT NAME & LOCATION: GULU TOWN, UGANDA AFRICA
PRELIMINARY DETAILS 2
DEEP CREEK ORDER # DC1-2FF

DRAWING#	2FF	SHEET	F-7
----------	-----	-------	-----

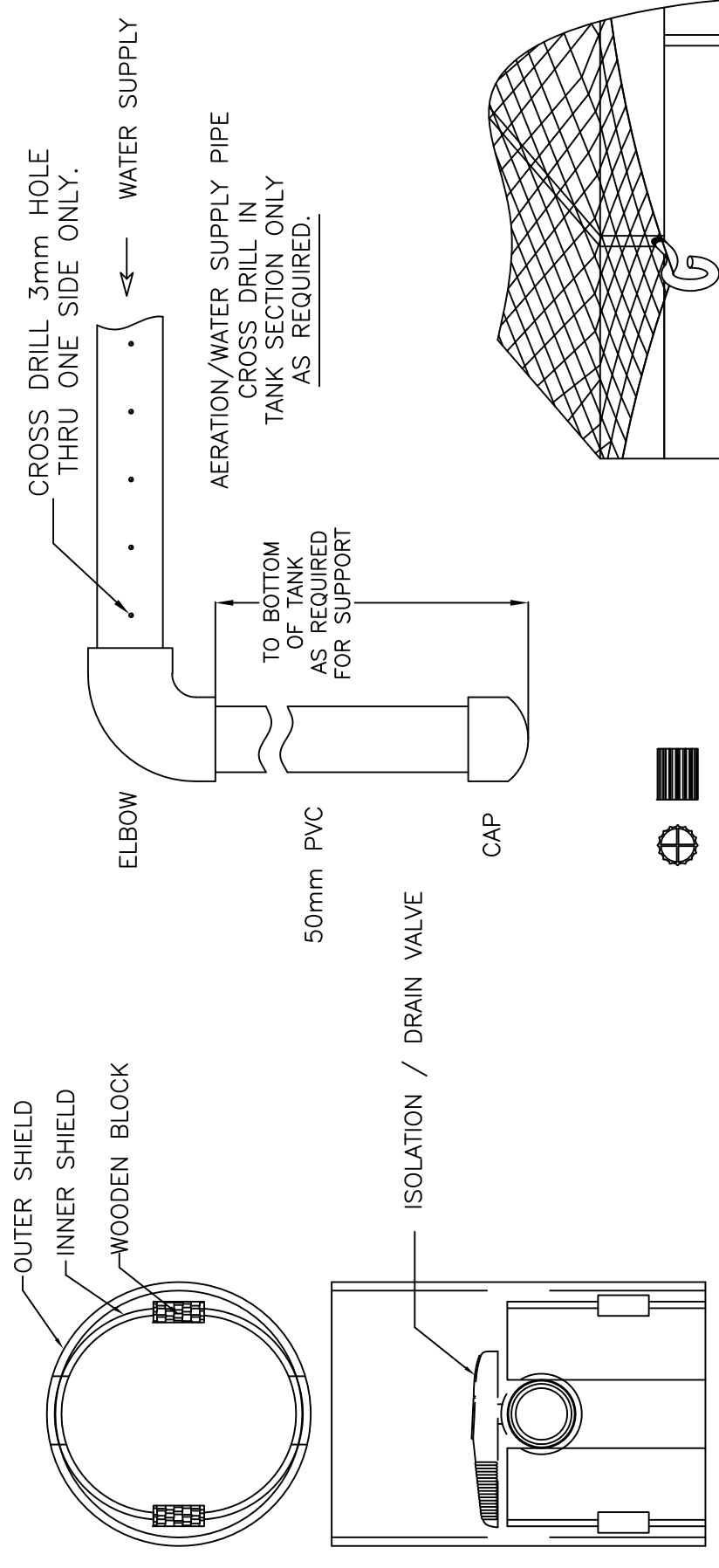

10mm BIO FILTER MEDIA

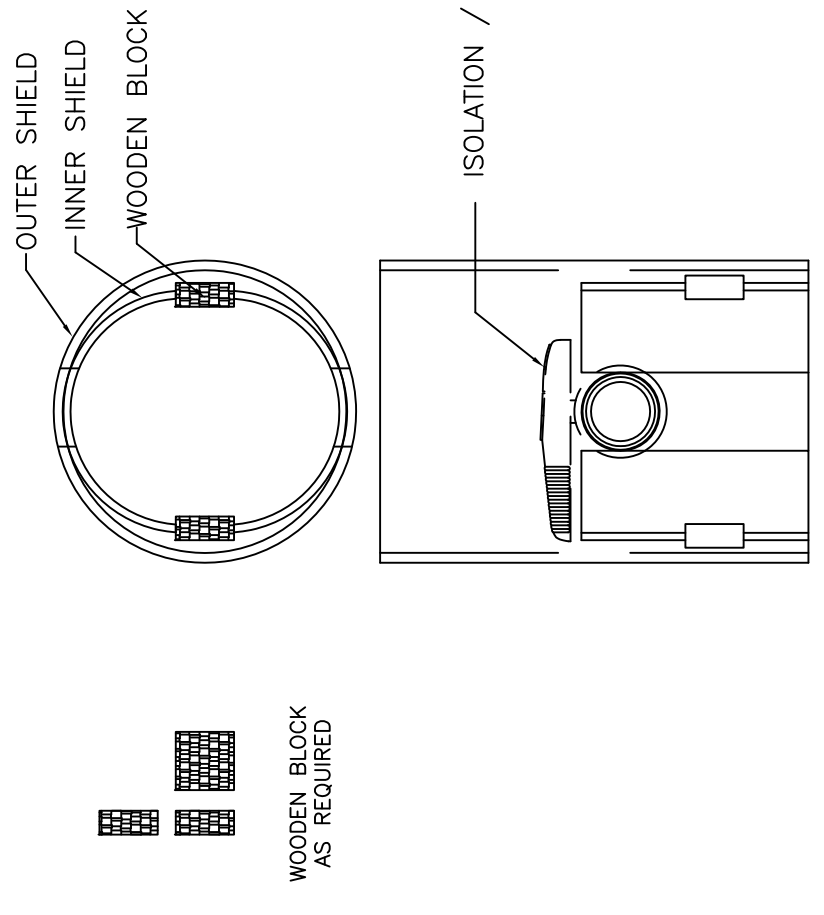

DIRT SHIELD ASSEMBLY

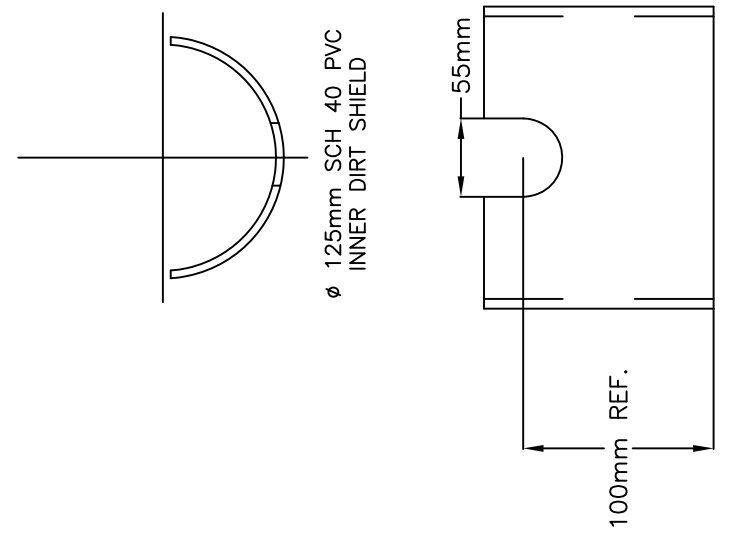
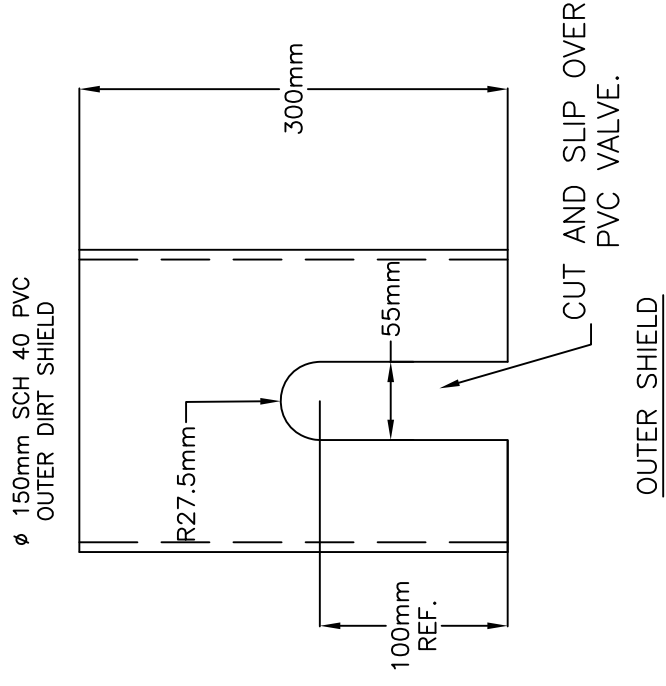
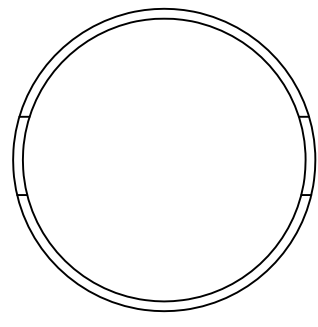

TYPICAL COVER NET AND GROW OUT TANK HOLDING NET DESIGN. INSTALL EYE HOOKS AROUND PERIMETER OF FISH TANKS FOR PROTECTIVE NETS

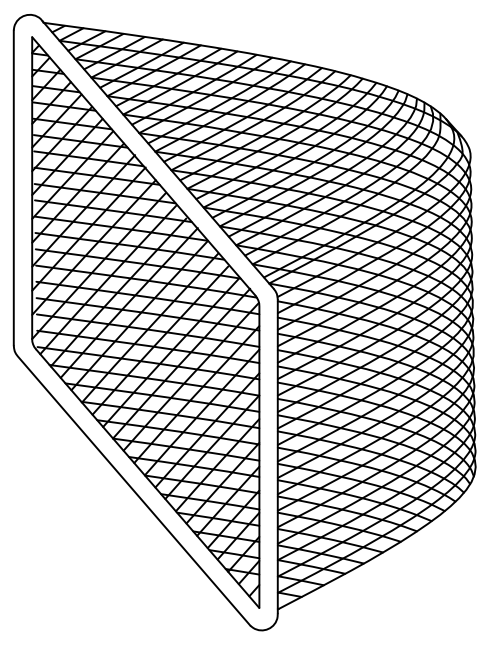

NOTES:

1) FULLY GROUT ALL CELLS

$F_y = 414 \text{ MPa}$

$F'_c = 17.2 \text{ MPa}$

$F'_m = 96 \text{ KPa}$

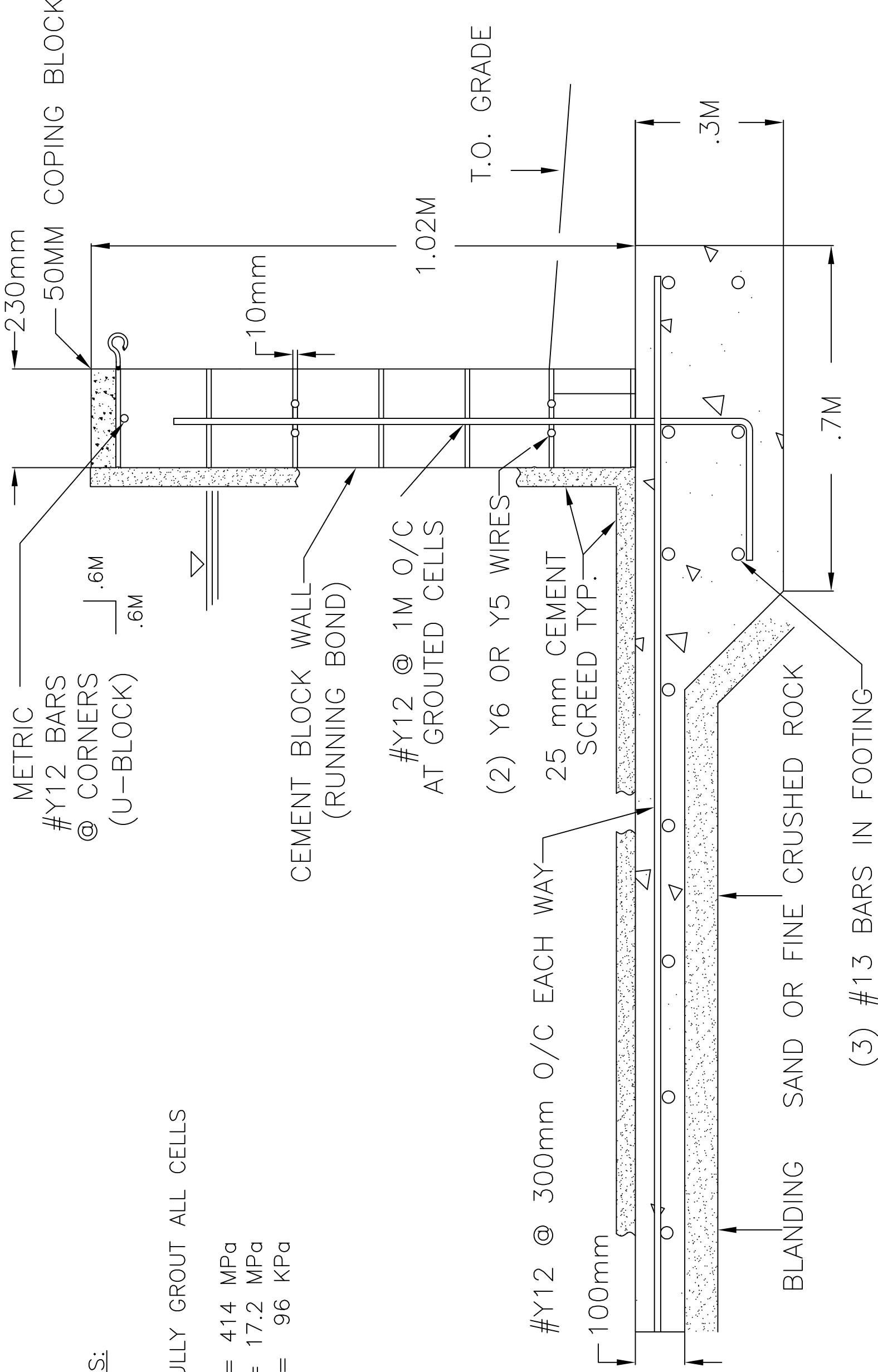

P.O. BOX 717 Iola, Kansas 66749
Ph: 913-626-9337

DEEP CREEK ENGINEERING, LLC
10 N. Sycamore St. Iola, Kansas 66749
Ph: 620-365-8004

Deep Creek Engineering

REV #	DATE	DESCRIPTION	BY	DATE	CHKD	DATE
NA						
SCALE:						
DATE:						
DATE:						
APPROVED:						
DATE:						
CHECKED:						
DATE:						
DATE:						
DATE:						

CUSTOMER:	FAVOR OF GOD MINISTRIES
PROJECT NAME & LOCATION	GULU TOWN, UGANDA AFRICA
PRELIMINARY FOUNDATION DETAILS	
DEEP CREEK ORDER # DC1-2FF	

DRAWING# 2FF

SHEET F-8

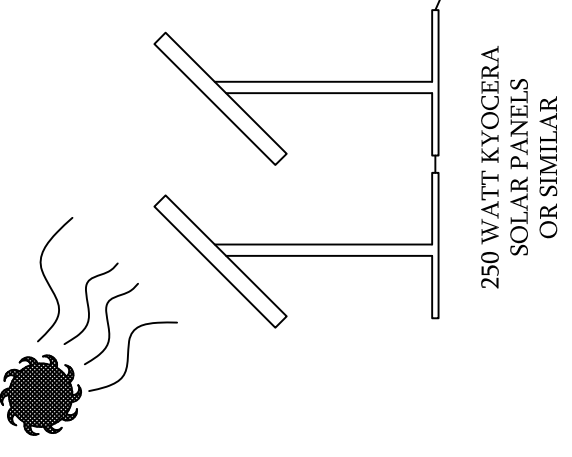

*600 VOLT BLOCKING DIODE

OVER CHARGE PROTECTION DUMP LOAD FAN OR SIMILAR

SOLAR CHARGE CONTROLLER REGULATOR

MAIN LOAD PUMPS FANS POWER INVERTER FOR 110 VOLT

*AMMETER

*VOLT METER

BATTERY BANK 12 VOLT DC XXX Ah RC

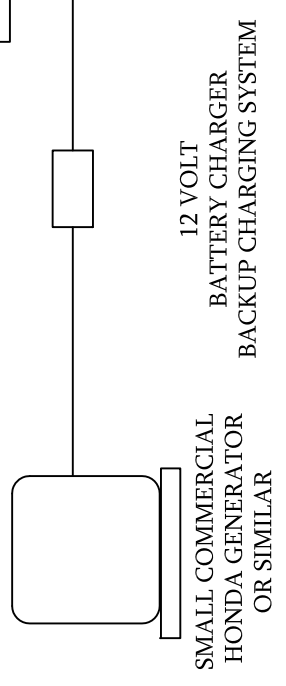

NOTES:

*600 VOLT BLOCKING DIODE AMMETERS AND VOLT METERS MAY NOT BE REQUIRED IF CHARGE CONTROLLER IS EQUIPPED.

TWO FISH
FOUNDATION INC.

P.O. BOX 717 Iola, Kansas 66749
Ph: 913-626-9337

DEEP CREEK
ENGINEERING, LLC

10 N. Sycamore St. Iola, Kansas 66749
Ph: 620-365-8004

REVISIONS	
DATE:	DESCRIPTION
NA	SCALE: NTS
	BY: DRAWN
	CHKD: RK
	DATE: 7/02/10
	CHECKED: JW
	DATE: 7/02/10
	APPROVED: JW
	DATE: 7/02/10

DATE:		DESCRIPTION:	
SCALE:		BY:	
NTS		DRAWN:	
		CHKD:	
		DATE:	

CUSTOMER:	FAVOR OF GOD MINISTRIES
PROJECT NAME & LOCATION	GULU TOWN, UGANDA AFRICA
PRELIMINARY BASIC SOLAR POWER SYSTEM	
DEEP CREEK ORDER # DC1-2FF	

DRAWING#	2FF
SHEET	F-9

**Appendix G: BAE Team Supplemental Analysis - Penman
Method and Transpiration**

Directions for operation of Penman Excel Calculator

Step 1: Compile and input necessary climatic information and calculate e_s (saturation vapor pressure) and e_d (actual vapor pressure). This is the raw input information the model will rely upon to develop an ET estimate. Information here includes mean temperature, average wind speed, relative humidity, and total solar radiation.

Step 2: Account for solar reflection at surface to generate net solar radiation value R_n . A portion of incoming solar radiation as measured by a weather station (or in our case a weather satellite) is reflected at the surface as outgoing radiation. This is described by equation 4.12.

Step 3: Use weather data from step 1 and R_n from step 2 to calculate slope of the saturation vapor pressure-temperature curve (Δ), atmospheric pressure (p), latent heat of vaporization (λ), psychrometric constant (γ), and heat flux density to the ground (G). See equations 4.26 and 4.31-4.34 for details.

Step 4: Use Penman equation 4.30 and variables calculated in (3) to generate a potential ET estimate. This is POTENTIAL ET, and must be adjusted by an appropriate crop coefficient to obtain an ACTUAL ET estimate. From Hydrology text, crops similar to Ms. Wicoff's (peas, beans, and tomatoes) have coefficients between 0.65 and 1.0. Because Ms. Wicoff's crops will be hydroponically grown, we expect them to lose more water to ET. Thus, we selected a higher crop use coefficient of 1.155 to account for this water loss.

Step 5: Compare model prediction to actual value and calculate a percent error. For the two trial days in Manhattan, KS, the model was predicted the value to within 2% and 20% of the official value on the KSU Weather Data website. These two Kansas days are similar to a typical Uganda day in that the May 2010 Manhattan day experienced net solar radiation of 23.97 MJ/m²/day and 80.2% relative humidity and the July 2010 Manhattan day experienced a 26.61 degrees Celsius mean temperature. The standard Ugandan day experiences 23.6 MJ/m²/day of solar radiation and a mean temperature of 25 degrees Celsius.

PENMAN CALCULATOR

Gulu Town, Uganda in May

Step 1: Compile and input necessary climatic information from KSU weather data website and pressure) calculate e_s (saturation vapor pressure) and e_d (actual vapor

Weather Conditions	Input	Unit	Function of	Reference
Mean Monthly Temperature	28	C		
Avg. Wind Speed	2.24	m/s		
Relative Humidity	0.8		*Assumption	
Elevation	1105	m		
e_s	1.330343008	kPa	Mean Temp	4.6
e_d	1.064274406	kPa	RH and e_s	4.7
Solar Radiation R_s	NA	langley		
	23.6	MJ/m ² /day		
Cp of Water	0.001013	kJ/kg/C		

Step 2: Account for solar reflection at surface to generate net solar radiation R_n

Net Solar Radiation Calculations	Input	Unit	Function of	Reference
a	1.1			Page 99
b	-0.1			Page 99
R_{so}	27.47	MJ/m ² /d	Latitude	Table 4.5
R_{bo}	4.907358273	MJ/m ² /d/K ⁴	Net Emissivity, Temp	4.14
R_b	4.146869589	MJ/m ² /d		4.13
Net Emissivity	0.121932616		Mean Temp	4.15
R_n	14.02513041	MJ/m ² /d		4.12

Step 3: Use data from Tables (1) and (2) to calculate remaining variables in Penman equation

Variable	Value	Units	Function of	Reference
Delta	0.220083307	kPa/C	Mean Temp	4.31
Pressure from atm P	89.64225	kPa	Elevation	4.32
Lambda (L.heat of vap)	2.434892	MJ/kg	Mean Temp	4.26
Gamma (psych const)	0.059958686	kPa/C	Cp, P Lambda	4.33
G	3.108	MJ/m/d	april and june Temp	4.34

Step 4: Plug variables from table (3) into Penman equation and obtain potential evaporation E_{tp} .

Multiply by appropriate crop coefficient to obtain actual evaporation E_t

Variable	Value	Units	Function of	Reference
Term One	3.523649798	mm/day	Table 3	4.3
Term Two	0.329035185	mm/day	Table 3	4.3
E_{tp}	3.852684983	mm/day		4.3
	0.151680511	in/day		
Hydroponic Crop Coef	1.155	Table 4.2		assumption
Prediction	0.17519099	in/day		
	4.449851155	mm/day		

Confidence Interval Explanation:

To further investigate the accuracy of our Penman model, we input weather data from 12 different Manhattan, KS days (2005-2010) and compared our result with official KSU agronomy website results. From this data, we used a probability model to determine a 95% confidence interval around our model's predicted results. As per data below, it was determined with 95% confidence that our model's prediction matches the KSU agronomy prediction +/- 8.5 percent error. Thus, it is shown that if Ms. Wicoff overestimates the model's ET prediction by 8.5% and builds tanks accordingly, the tanks would be adequate on 95% of the days we investigated if actual ET follows a model described by the KSU agronomy method.

Table 1:

Date	Percent Error from KSU Agronomy Prediction
5.29.2005	45.98
5.19.2005	14.1
5.24.2006	14.3
5.18.2006	0.19
5.10.2007	2.94
5.11.2007	5.8
5.18.2008	20.7
5.31.2009	15.4
5.24.2009	1.13
5.24.2010	0.64
7.27.2010	0.38
5.11.2010	21.1
Average	11.89
Standard Deviation	13.40
Standard Error	3.87
Alpha	0.05
Critical Probability	0.975
Degrees of Freedom	11
T Score	2.201
Margin of Error	8.52

The probability model was constructed with the aid of <http://stattrek.com/AP-Statistics-4/Confidence-Interval.aspx>. We wanted to give Ms. Wicoff an accurate prediction, so we decided to determine the 95% confidence interval, that is, the interval around the model's prediction in which the KSU model's prediction would fall 95% of the time.

The model yielded a margin of error of 8.52. Thus, on 95% of days sampled, our ET model will predict a value within 8.52% of the KSU model.

Note: After further meeting with Dr. Hutchinson in March 2011, it was determined that the G factor in the Penman equation is often set to 0. Thus, and updated ET estimate of 0.21 in/day (5.27 mm/day) was obtained for a typical Uganda May day. It is this model we base the probability discussion upon, and Ms. Wicoff will need to update her water balance data in section V to account for this.

Reference in APA format:

Ap statistics tutorial: confidence intervals. (2011). Retrieved from <http://stattrek.com/AP-Statistics-4/Confidence-Interval.aspx>

Environmental Hydrology Chapter 4 Equations:

Evaporation Process, Measuring Evaporation or Evapotranspiration, Weather Data Sources and Preparation, Estimating Evaporation or Evapotranspiration, Crop Actual Evapotranspiration

Evaporation Process

Fick's First Law of Diffusion

Fick was one of the first people to quantify the movement of molecules from a region of higher concentration to a region of lower concentration (Nobel, 1983), such as water molecules moving from a water surface into air. He developed Fick's first law of diffusion:

$$J_j = -D_j \frac{\partial c_j}{\partial x} \quad (4.1)$$

where J_j (the flux density) is the amount of species j crossing a certain area per unit time and is typically expressed in units such as moles of particles per m^2 per second. D_j is the diffusion coefficient of species j (analogous to resistance in electrical circuits). The term $\partial c_j / \partial x$ represents the concentration gradient of species j and is the driving force that leads to molecular movement (Nobel, 1983). The negative sign indicates that the direction of flow is from high to low concentration.

Measuring Evaporation or Evapotranspiration

Pan Evaporation

Pan evaporation data can be used to estimate actual evapotranspiration of a reference crop using the following equation (Jensen et al., 1990):

$$E_{tr} = k_p E_{pan} \quad (4.2)$$

where k_p is a crop or pan coefficient. Many k_p values have been determined in previous studies but it is important that the study have a similar climate (humid vs. arid) and use the same pan (i.e., class A pan) with similar nearby surfaces and placement in relation to wind barriers at our site of interest.

Soil Water Depletion

AET from a crop can be estimated by observing the change in soil water over a period of time. The average rate of ET in mm/d between sampling dates (denoted Δt) can be calculated using the following equation (Jensen et al., 1990):

$$E_t = \frac{\Delta SM}{\Delta t} = \frac{\sum_{i=1}^{n_{rz}} (\theta_1 - \theta_2)_i \Delta S_i + I - D}{\Delta t} \quad (4.3)$$

where

- E_t = actual evapotranspiration in mm/d
- ΔSM = change in soil water content
- Δt = time between sampling dates
- n_{rz} = number of soil layers in the effective root zone
- ΔS_i = the thickness of each soil layer in mm
- θ_1 = volumetric water content of soil layer i on the first sampling date (m^3/m^3)
- θ_2 = volumetric water content of soil layer i on the second sampling date (m^3/m^3)
- I = infiltration (rainfall - runoff) during Δt (mm)
- D = drainage below the root zone during Δt (mm)

Water Balance

The water balance approach is generally used on large areas such as watersheds. The inflows and outflows are determined from streamflow and precipitation measurements and the difference between inflow and outflow over a relatively long period of time, such as a season, is a measure of evapotranspiration. The equation is:

$$AET = P - Q \pm \Delta G \pm \Delta \theta \quad (4.4)$$

where P is the precipitation depth, AET is actual ET, Q is runoff depth, ΔG is ground-water inflow or outflow, and $\Delta \theta$ is soil water change. For the short term, ΔG and $\Delta \theta$ should be measured, but over a period of years they become insignificant and can be dropped, so the equation becomes:

$$AET = P - Q \quad (4.5)$$

Alternatively, Equation 4.6 can be used to compute saturation vapor pressure, e_s in kPa if temperature, T , is in degrees Celsius:

$$e_s = \exp \left[\frac{16.78 T - 116.9}{T + 237.3} \right] \quad (4.6)$$

This equation is useful if we would like to write a computer program to compute some of these values. The equation is valid for temperatures ranging from 0 to 50°C.

Weather Data Sources and Preparation

Actual Vapor Pressure

Actual vapor pressure, e_d , is the vapor pressure of the air. Unlike saturation vapor pressure, actual vapor pressure cannot be determined simply by knowing the temperature of the air. To determine e_d we need to know the air temperature and either the relative humidity or the dewpoint temperature of the air. The following equation can be used to find actual vapor pressure:

$$e_d = e_s \times \frac{\text{RH}}{100} \quad (4.7)$$

where: e_d = actual vapor pressure
 e_s = saturation vapor pressure
RH = relative humidity in percent

Vapor Pressure Deficit

Many methods exist for calculating the vapor pressure deficit ($e_s - e_d$) (see Jensen et al., 1990). Three methods for calculating vapor pressure deficit are shown here.

Method 1. Saturation vapor pressure at mean temperature minus saturation vapor pressure at dewpoint temperature, this can be written as:

$$(e_s - e_d) = e_{s(T_{\text{avg}})} - e_{s(T_d)} \quad (4.8)$$

where e_d = actual vapor pressure
 e_s = saturation vapor pressure
 T_{avg} = mean temperature for time period of interest
 T_d = mean dewpoint temperature for time period of interest

Method 2. The vapor pressure deficit can be estimated from the saturation vapor pressure at the mean temperature times the quantity one, minus the relative humidity expressed as a proportion or:

$$(e_s - e_d) = e_{s(T_{\text{avg}})} \left(1 - \frac{\text{RH}}{100}\right) \quad (4.9)$$

This equation is obtained by writing equation 4.7 as:

$$e_{s(T_s)} = e_{s(T_{\text{avg}})} \frac{\text{RH}}{100} \quad (4.10)$$

and then substituting equation 4.10 into equation 4.8.

Method 3. The mean of saturation vapor pressure at the maximum and minimum temperatures minus the saturation vapor pressure at the dewpoint temperature determined early in the day, typically at 8 a.m.

$$(e_s - e_d) = \frac{e_{s(T_{\max})} + e_{s(T_{\min})}}{2} - e_{s(T_{d8am})} \quad (4.11)$$

The most likely scenario is that R_s has been measured and we need R_n to use Penman's method or a similar method. It is possible to estimate R_n from R_s since R_n is the net short-wave minus the long-wave components of the radiation.

$$R_n = (1 - \alpha)R_s \downarrow - R_b \uparrow \quad (4.12)$$

where R_b is the net outgoing thermal radiation in MJ/m²/d and α is the albedo or short-wave reflectance, which is dimensionless. The arrows in Equation 4.12 serve as reminders that R_s is incoming and R_b is outgoing. The short-wave reflectance or albedo, α is typically set equal to 0.23 for most green field crops with a full cover (Jensen et al., 1990). Since we know R_s and α , R_b is all that is needed. Equation 4.13 can be used to calculate this value, in units of MJ/m²/d

$$R_b = \left[a \frac{R_s}{R_{so}} + b \right] R_{bo} \quad (4.13)$$

The coefficients a and b are determined for the climate of the area of interest. For humid areas, $a = 1.0$ and $b = 0$; for arid areas, $a = 1.2$ and $b = -0.2$; and for semi-humid areas $a = 1.1$ and $b = -0.1$. R_{so} is the solar radiation on a cloudless day (in units of MJ/m²/d) based on the site's latitude. R_{bo} can be computed from Equation 4.14.

$$R_{bo} = \epsilon \sigma T^4 \quad (4.14)$$

where the Stefan-Boltzmann constant, σ , is 4.903×10^{-9} MJ/m²/d/K⁴, and T is the mean temperature for the period of interest in Kelvin ($273 + T$ in °C). The term ϵ is the net emissivity and is calculated using the Idso-Jackson equation (Equation 4.15) with T in Kelvin.

$$\epsilon = -0.02 + 0.261 \exp[-7.77 \times 10^{-4} (273 - T)^2] \quad (4.15)$$

Extrapolating Wind Speed

Wind is typically slower at the ground surface and the speed increases with height. Most methods for estimating ET that require wind speed specify at what height the wind speed should be recorded. However, in practice the data have sometimes been recorded at other heights. To estimate the wind speed, u_2 , at height z_2 , knowing the wind speed u_1 at height z_1 , Equation 4.16 can be used (Allen et al., 1989).

$$\frac{u_1}{u_2} = \frac{\ln[z_1 - 0.67h_c] - \ln[0.123h_c]}{\ln[z_2 - 0.67h_c] - \ln[0.123h_c]} \quad (4.16)$$

where h_c is the height of the vegetation, $0.67h_c$ is the height where the wind velocity approaches zero (known as the roughness height), and $0.123h_c$ is the surface roughness. The variables h_c , z_1 , and z_2 are expected to have the same units, then u_2 will have identical units to u_1 .

Estimating Evaporation or Evapotranspiration

Evaporation from Open Water

Monthly evaporation from lakes or reservoirs can be computed using the empirical formula developed by Meyer (1915) but based on Dalton's Law (1802)(Harrold et al., 1986).

$$E = C(e_s - e_d) \left(1 + \frac{u_{25}}{10} \right) \quad (4.17)$$

where

E	=	evaporation in inches/month
e_s	=	saturation vapor pressure (inches of Hg) of air at the water temperature 1 foot deep
e_d	=	actual vapor pressure (inches of Hg) of air = $e_s (\text{air T}) \times \text{RH}$
u_{25}	=	average wind velocity (mi/hr) at a height of 25 feet above the lake or surrounding land areas
C	=	coefficient that equals 11 for small lakes and reservoirs and 15 for shallow ponds

SCS Blaney-Criddle Method

Blaney and Criddle assumed that mean monthly air temperature and monthly percentage of annual daytime hours could be used instead of solar radiation to provide an estimate of the energy received by the crop. They defined a monthly consumptive use factor, f , as:

$$f = \frac{tp}{100} \quad (4.18)$$

where t is the mean monthly air temperature in °F (avg. of daily maximum and minimum) and p is the mean monthly percentage of annual daytime hours. The 100 in the divisor converts p from a percentage to a fraction. Once f is computed for each month, then the actual ET for the season is computed by Equation 4.19:

$$U = K \sum_{i=1}^n f_i \quad (4.19)$$

where K is the seasonal consumptive use coefficient for a crop with a normal growing season, n is the number of months in the season, and U is the seasonal consumptive use in inches/season.

If we have monthly consumptive use coefficients available for the specific crop and location, then monthly consumptive use (u) can be computed as follows:

$$u = k \frac{tp}{100} \quad (4.20)$$

where k is an empirical coefficient and u is the monthly consumptive use in inches/month.

Jensen-Haise Alfalfa-Reference Radiation Method

The Jensen-Haise method is termed a radiation method because solar radiation is needed in the equation to incorporate the recognized link between a source of energy and evapotranspiration. Jensen and Haise used over 3000 observations of actual evapotranspiration determined by soil sampling and statistically related R_s to E_{tr} as shown in Equation 4.21 (Jensen and Haise, 1963).

$$E_{tr} = \frac{C_T(T - T_x)R_s}{\lambda} \quad (4.21)$$

where E_{tr} = reference evapotranspiration in mm/d
 C_T = temperature coefficient (Equation 4.22)
 λ = latent heat of vaporization in MJ/kg (Equation 4.26)
 R_s = solar radiation received at the earth's surface on a horizontal surface, MJ/m²/d
 T = mean temperature for a 5-day period, °C
 T_x = intercept of the temperature axis (Equation 4.25), °C

The temperature coefficient can be calculated as follows:

$$C_T = \frac{1}{C_1 + 7.3 C_H} \quad (4.22)$$

and C_1 , which is needed to calculate C_T , can be calculated from:

$$C_1 = 38 - \frac{2(H)}{305} \quad (4.23)$$

where H is the elevation above sea level in meters.

C_H , which is also needed for Equation 4.22, is calculated as follows:

$$C_H = \frac{5.0 \text{ kPa}}{(e_2 - e_1)} \quad (4.24)$$

where e_2 and e_1 are the saturation vapor pressures in kPa at the mean maximum and mean minimum temperatures, respectively, for the warmest month of the year in an area.

$$T_x = -2.5 - 1.4(e_2 - e_1) - \frac{H}{550} \quad (4.25)$$

$$\lambda = 2.501 - 2.361 \times 10^{-3} T \quad (4.26)$$

where λ is the latent heat of vaporization (MJ/kg) and T is temperature in °C (Harrison, 1963).

Thornthwaite Method

Thornthwaite found that evapotranspiration could be predicted from an equation of the form:

$$E_{tp} = 16 \left[\frac{10T}{I} \right]^a \quad (4.27)$$

where

- E_{tp} = monthly ET in mm
- T = mean monthly temperature in °C
- a = location dependent coefficient described by Equation 4.29
- I = heat index described by Equation 4.28

In order to determine a and monthly ET , a heat index I must first be computed.

$$I = \sum_{j=1}^{12} \left[\frac{T_j}{5} \right]^{1.514} \quad (4.28)$$

where T_j is the mean monthly temperature during month j (°C) for the location of interest.

Then, the coefficient a can be computed as follows:

$$a = 6.75 \times 10^{-7} I^3 - 7.71 \times 10^{-5} I^2 + 1.792 \times 10^{-2} I + 0.49239 \quad (4.29)$$

Penman's Method

Penman (1948) first combined factors to account for a supply of energy and a mechanism to remove the water vapor from the immediate vicinity of the evaporating surface. We should recognize these two factors as the essential ingredients for evaporation. Penman derived an equation for a well watered grass reference crop:

$$E_{tp} = \frac{\frac{\Delta}{\Delta + \gamma} (R_n - G) + \frac{\gamma}{\Delta + \gamma} 6.43 (1.0 + 0.53 u_2) (e_s - e_d)}{\lambda} \quad (4.30)$$

where

- E_{tp} = potential evapotranspiration in mm/day
- R_n = net radiation in MJ/m/d
- G = heat flux density to the ground in MJ/m/d

λ = latent heat of vaporization computed by Equation 4.26 in MJ/kg
 u_2 = wind speed measured 2 m above the ground in m/s
 Δ = slope of the saturation vapor pressure-temperature curve, kPa /°C
 γ = psychrometric constant, kPa/°C
 $e_s - e_d$ = vapor pressure deficit determined by Method 3; kPa

The slope of the saturation vapor pressure-temperature curve, Δ , can be computed knowing the mean temperature as follows:

$$\Delta = 0.200 [0.00738T + 0.8072]^7 - 0.000116 \quad (4.31)$$

where Δ is in kPa/°C, and T is the mean temperature in °C. To calculate the psychrometric constant, we must first calculate P , the atmospheric pressure that Doorenbos and Pruitt (1977) suggested could be calculated by Equation 4.32:

$$P = 101.3 - 0.01055H \quad (4.32)$$

where P is in kPa and H is the elevation above sea level in meters. Using P , λ calculated from Equation 4.25, and c_p , the specific heat of water at constant pressure [0.001013 kJ/kg/°C], the psychrometric constant (in kPa/°C) can be calculated from Equation 4.33:

$$\gamma = \frac{c_p P}{0.622 \lambda} \quad (4.33)$$

The remaining value to calculate is G , the heat flux density to the ground in MJ/m/d, and this can be determined from Equation 4.34, knowing the mean air temperature for the time period before and after the period of interest:

$$G = 4.2 \frac{(T_{i+1} - T_{i-1})}{\Delta t} \quad (4.34)$$

where T is the mean air temperature in °C for time period $i + 1$ and $i - 1$, and Δt is the time in days between the midpoints of time periods $i + 1$ and $i - 1$.

Crop Actual Evapotranspiration

To estimate crop actual ET (E_t):

$$E_t = k_c E_{tr} \text{ or } E_t = k_c E_{tp} \quad (4.35)$$

where E_{tr} is reference crop ET , E_{tp} is potential ET , E_t is actual evapotranspiration and k_c is the experimentally derived crop coefficient. Typical reference crops used to develop the coefficients are alfalfa or grass.