

Parametric Analysis of Economical Bay Dimensions for Steel Floor Framing

by

Aaron Wolf

B.S., Kansas State University, 2016

A THESIS

submitted in partial fulfillment of the requirements for the degree

MASTER OF SCIENCE

Department of Architectural Engineering and Construction Science
College of Engineering

KANSAS STATE UNIVERSITY
Manhattan, Kansas

2016

Approved by:

Major Professor
Kimberly Waggle Kramer, P.E., S.E.

Copyright

© Aaron Wolf 2016.

Abstract

This thesis intends to act as a resource for structural engineers or architects to make informed decisions for selecting economical bay dimensions for a steel-framed building. This thesis utilizes a parametric study to investigate how different design variables affect economical bay sizes for a typical steel-framed building. While there are many ways to define an “economical bay”, this analysis defines an economical bay size as the bay size that uses the least steel, measured in pounds per square foot of floor area. Although other factors contribute to the overall economy of a steel bay, this analysis only considers the weight of steel.

Investigated parameters include beam spacing, beam span, girder span, floor live load intensity, and composite versus non-composite construction. Beam center-to-center spacing varies from four feet to 12 feet in two-foot increments. Beam spacing varies independently from beam span. Beam spans range from 20 feet to 52 feet in four foot increments. Girder spans also range from 20 feet to 52 feet in four foot increments. Beam and girder spans vary independently of one another. Floor live loads include 50 lb/ft², 75 lb/ft², and 100 lb/ft². The effect of member construction type is also evaluated in this analysis by considering both composite and non-composite beams and girders.

This analysis finds that 20-foot by 20-foot bays use the least steel per square foot, while 52-foot by 52-foot bays use the most. Identical bays framed with girders spanning the long direction use less steel than with beams spanning the long direction. Beams contribute the majority of the steel weight in the structure, while columns contribute the least. Live load intensity produces minimal effect on the steel weight, while the use of composite construction saves 30-40% of steel weight versus non-composite construction.

Table of Contents

| | |
|--|-----|
| List of Figures | vii |
| List of Tables | ix |
| Acknowledgements | x |
| Dedication | xi |
| Chapter 1 - Introduction..... | 1 |
| Chapter 2 - Literature Review..... | 3 |
| “Economics of Low-Rise Steel-Framed Structures”: John Ruddy, 1983..... | 3 |
| Parameters - Ruddy 1983..... | 3 |
| Results - Ruddy 1983..... | 5 |
| Conclusion - Ruddy 1983 | 12 |
| “Rules of Thumb for Steel Design”: Ioannides, Ruddy, 2004..... | 14 |
| Structural Depths – Ioannides & Ruddy 2004 | 14 |
| Beam Section Properties – Ioannides & Ruddy 2004..... | 14 |
| Section Modulus – Ioannides & Ruddy 2004..... | 20 |
| Column Section Properties – Ruddy 2004..... | 21 |
| Steel Weights - Ruddy 2004 | 23 |
| Total Weight - Ruddy 2004 | 24 |
| Conclusion - Ruddy 2004 | 25 |
| “Design Guide 5: Low- and Medium-Rise Steel Buildings”: AISC, 2003 | 26 |
| Basic Design Rules for Economy | 26 |
| Live Load and Bay Size Selection | 27 |
| Composite Design..... | 28 |
| Shored Construction..... | 29 |
| Conclusion | 31 |
| “Value Engineering for Steel Construction”: David Ricker, 2000..... | 32 |
| Stay Informed about Material Costs | 32 |
| Use of Composite Beams..... | 32 |
| Selection of Optimal Bay Sizes | 33 |
| Consider More than Minimum Steel Designs..... | 33 |

| | |
|---|----|
| Design for Un-Shored Composite Construction | 33 |
| Duplication of Member Sizes | 34 |
| Duplication of Member Connections..... | 34 |
| Conclusion | 34 |
| Chapter 3 - Analysis Method | 35 |
| Scope..... | 35 |
| Analysis Criteria | 36 |
| Excluded from Analysis..... | 38 |
| Building Parameters..... | 39 |
| Load Conditions..... | 40 |
| Member Design..... | 42 |
| Beams..... | 42 |
| Non-Composite | 43 |
| Composite | 43 |
| Girders..... | 47 |
| Columns | 50 |
| Chapter 4 - Analysis Procedure | 55 |
| Beams..... | 55 |
| Girders..... | 58 |
| Columns | 61 |
| Chapter 5 - Analysis Results..... | 65 |
| Beams..... | 66 |
| Girders..... | 70 |
| Columns | 74 |
| Total | 76 |
| Live Load | 80 |
| Composite | 83 |
| Chapter 6 - Conclusion | 87 |
| Beams..... | 87 |
| Girders..... | 87 |
| Columns | 88 |

| | |
|--|-----|
| Total | 88 |
| Live Load | 89 |
| Construction Type..... | 89 |
| Summary | 90 |
| Chapter 7 - Further Research | 92 |
| Structural systems | 92 |
| Building Parameters..... | 92 |
| Economics..... | 93 |
| References..... | 94 |
| Appendix A - Approximate Moment Method | 95 |
| Distributed Load Approximation:..... | 96 |
| One Point Load: | 97 |
| Two Point Loads:..... | 98 |
| Three Point Loads:..... | 99 |
| Four Point Loads:..... | 100 |
| Results:..... | 101 |
| Conclusion: | 101 |
| Appendix B - Beam and Girder Weight Derivations..... | 104 |
| Derivation | 104 |
| Results..... | 119 |
| Conclusions..... | 120 |
| Appendix C - Column Weight Derivation | 123 |
| Region 1 | 126 |
| Region 2 | 131 |
| Results..... | 132 |
| Conclusion | 132 |
| Appendix D - Steel Weight Graphs | 136 |

List of Figures

| | |
|--|----|
| Figure 2-1: Ruddy’s Structural Framing Isometric (1983)..... | 4 |
| Figure 2-2: Spread Footing Cost Variation (Ruddy, 1983) | 5 |
| Figure 2-3: Joist Weight Variation (Ruddy, 1983)..... | 7 |
| Figure 2-4: Joist Cost Variation (Ruddy, 1983)..... | 8 |
| Figure 2-5: Girder Weight Variation (Ruddy, 1983)..... | 9 |
| Figure 2-6: Column Weight Variation (Ruddy, 1983)..... | 10 |
| Figure 2-7: Least Cost of Steel Elements | 12 |
| Figure 2-8: Typical Wide Flange Section..... | 15 |
| Figure 2-9: Steel Weight Versus Building Stories (Ruddy, 2004) | 24 |
| Figure 3-1: Framing plan of a typical bay. | 36 |
| Figure 3-2: Section of Composite Metal Deck | 39 |
| Figure 3-3: Composite Beam Section | 44 |
| Figure 3-4: Beam- and Girder-to-Column Detail | 52 |
| Figure 4-1: Typical Girder-to-Column Connection..... | 62 |
| Figure 5-1: Beam Weight vs. Beam Spacing..... | 66 |
| Figure 5-2: Beam Weight vs. Beam Span..... | 67 |
| Figure 5-3: Beam Weight vs. Beam Proportions | 69 |
| Figure 5-4: Girder Weight vs. Girder Span | 71 |
| Figure 5-5: Girder Weight vs. Beam Span..... | 72 |
| Figure 5-6: Girder Weight vs. Bay Size..... | 73 |
| Figure 5-7: Column Weight vs. Girder Span..... | 75 |
| Figure 5-8: Total Steel Weight vs. Beam Span..... | 76 |
| Figure 5-9: Total Steel Weight vs. Girder Span | 78 |
| Figure 5-10: Total Steel Weight vs. Bay Size..... | 79 |
| Figure 5-11: Total Steel Weight vs. Bay Size..... | 80 |
| Figure 5-12: Total Steel Weight vs. Bay Size..... | 81 |
| Figure 5-13: Composite Beam Weight vs Beam Spacing | 83 |
| Figure 5-14: Composite Girder Weight vs. Bay Size | 85 |
| Figure 5-15: Total Composite Steel Weight vs. Bay Size | 86 |

| | |
|---|-----|
| Figure 7-1: Distributed Load Diagram | 96 |
| Figure 7-2: One Point Load Diagram | 97 |
| Figure 7-3: Two Point Load Diagram..... | 98 |
| Figure 7-4: Three Point Load Diagram..... | 99 |
| Figure 7-5: Four Point Load Diagram | 100 |
| Figure 7-6: Section Modulus Coefficient for Economy Sections..... | 106 |
| Figure 7-7: Moment of Inertia Coefficient for Economy Sections..... | 116 |
| Figure 7-8: Column Stresses..... | 124 |

List of Tables

| | |
|--|-----|
| Table 2-1: Comparison of Actual Versus Approximate Moments of Inertia | 19 |
| Table 2-2: Percentage Comparison of Per-Square-Foot Costs (AISC, 2003) | 28 |
| Table 3-1: 2015 IBC Allowable Deflections | 45 |
| Table 4-1: Load Information..... | 55 |
| Table 4-2: Beam Loads and Members Sized for Strength Only..... | 56 |
| Table 4-3: Members Sized for Deflection | 58 |
| Table 4-4: Beam Spacing Interpolation Method..... | 61 |
| Table 4-5: Column Axial Loads and Members Sized for Pure Axial Load..... | 62 |
| Table 4-6: Design of Columns for Eccentric Loads | 64 |
| Table 4-7: Steel Weight Results | 64 |
| Table 5-1: Steel Weight Versus Live Load Intensity..... | 82 |
| Table 7-1: Maximum Bending Moment Results for Approximate Moment Method..... | 101 |
| Table 7-2: Maximum Shear Results for Approximate Moment Method..... | 103 |

Acknowledgements

To Kimberly Kramer, who has been an excellent professor and mentor to me over the years.

To Jim Goddard and Bill Zhang, who agreed to be members of my committee.

Dedication

To my mother, Cindy, who taught me the importance of doing my best.

To my father, Mike, who instilled in me my interest in engineering.

Chapter 1 - Introduction

Selection of a bay size is one of the first and most fundamental steps in the development of a building's structural system. A framing bay is the basic unit of a steel framing layout. Determining the proportions and framing scheme for a single bay in turn determines the framing layout for the entire building. The framing layout defines the load path of the building and serves as a basis for load calculations, structural analysis, and member design.

“Before any members are selected, before any connections are designed, even before any loads are calculated, the efficient structural engineer will conceive and lay out a steel framing system; this is one of the true arts of structural engineering.” (Carter, 2004) Although developing a framing layout requires very few calculations compared to the rest of the design process, choices in the layout of the steel framing can be a strong indicator of the efficiency and economy of the framing system as a whole. Choosing a poor framing layout can negatively impact the cost and performance of the structure. (Carter, 2004)

When selecting a bay's size and dimensions for a project, a structural engineer should have a strong sense for the way project design conditions will affect the economics of a building's structural design. Does a building's design live load have a large effect on the cost of the structure? Is it more cost efficient to span beams in the long or short direction? Is it more cost efficient to space small beams closely together, or use larger beams spaced farther apart?

This thesis utilizes a parametric study to investigate how different design variables affect economical bay sizes for a typical steel-framed building. An “economical bay” may be defined in several ways; however, the most simple way to define an economical bay is in

terms of steel weight which correlates to steel cost. Specifically, a bay that is economical in terms of steel weight would be a configuration which uses the least structural steel to support a given floor area. Likewise, an economical bay in terms of monetary cost would be a configuration which costs the least per square foot to fabricate and construct. As shown by Ruddy (1983), the definitions of the least-weight solution and the least-cost solution are not necessarily equivalent. While this study will focus on the least-weight solution, both definitions have value for design applications.

Beam spacing, beam span, girder span, floor live load intensity, and composite versus non-composite construction are all parameters investigated in the analysis. Beam center-to-center spacing varies from four feet up to 12 feet in two foot increments. Beam spacing varies independently from beam span. Beam spans range from 20 feet to 52 feet in four foot increments. Girder spans also range from 20 feet to 52 feet in four foot increments. Beam and girder spans vary independently of one another. Floor live loads include 50 lb/ft², 75 lb/ft², and 100 lb/ft². The effect of member construction type is also evaluated in this analysis by considering both composite and non-composite beams and girders. The analysis requires the design of 999 unique beam, girder, and column members and results in 486 unique framing solutions.

Chapter 2 - Literature Review

“Economics of Low-Rise Steel-Framed Structures”: John Ruddy, 1983

In 1983, John Ruddy, P.E., member of ASCE, conducted a study on the topic of economic bay sizes which is often cited. He distinguishes the difference between a solution of least weight and a solution of least cost in this study by providing cost and weight information in the results.

The study analyzes a single story structure constructed with evenly-spaced open-web steel roof joists that are spaced evenly between column centerlines. These joists are supported by continuous wide flange steel girders, which span to wide flange steel columns. These columns are evenly spaced in each direction such that the structure forms rectangular-sized bays.

Although this study only analyzes a single-story structure with steel joist framing subjected primarily to roof live loads, this study is often referenced to justify bay sizes for multi-story buildings where the members are resisting floor live and dead loads, which tend to be much larger in magnitude than roof loads. Likewise, floor framing commonly utilizes wide flange members rather than steel joists.

Parameters - Ruddy 1983

With this layout, Ruddy’s study varies many parameters to assess how each affects the overall cost of the structure. These parameters include foundation type, joist span, girder span, and roof load. The foundation types considered were spread footings, timber piles, and augured caissons. Only the results from Ruddy’s study regarding spread footings are considered, since spread footings are the foundation chosen for the building in this

analysis. Spread footings were sized to be square with side dimensions with increments of 6 inches, and thicknesses greater than 12 inches in increments of 2 inches.

Joist and girder spans were determined by selecting a bay area and multiplying it by a length-to-width ratio. Bay areas analyzed in Ruddy's study range from 50 square feet to 2500 square feet in 50 square foot increments. Length-to-width ratios range from 0.5 to 2.75 in 0.25 increments, where joist spans are considered the bay lengths and girder spans are the bay widths. Joist spacing is not directly considered in Ruddy's study, as joist spacing only changes to satisfy the constraints of being evenly spaced and not exceeding the maximum span of the roof deck, which was 6'-6". Total roof load intensity ranges from 30 lb/ft² to 80 lb/ft² in 10 lb/ft² increments.

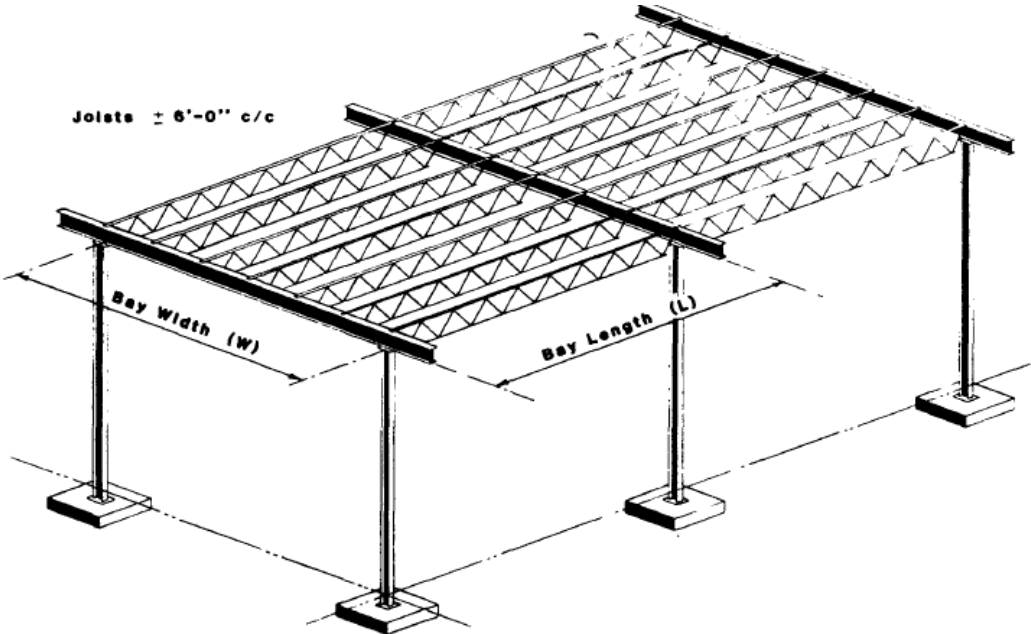

Figure 2-1: Ruddy's Structural Framing Isometric (1983)

Results - Ruddy 1983

As these parameters were varied, information on the cost (\$/ft²) and steel weight (lb/ft²) were provided for the foundation, joists, girders, and columns, as well as a combined total cost and weight per unit area. Ruddy's study differentiates between the least-cost solution and least-weight solution since the two are often not the same. As Ruddy notes in his study, structures that seek only to minimize weight often become more expensive due to increased labor costs.

As shown in Figure 2-2, Ruddy found that spread footing costs increase dramatically as the bay area decreases below 500 ft², which represents a roughly 22-foot by 22-foot bay. Footing cost per square foot for a 500 ft² bay was \$0.25/ ft², while the cost for a 200 ft² bay was about \$0.75/ ft², in 1983 dollars.

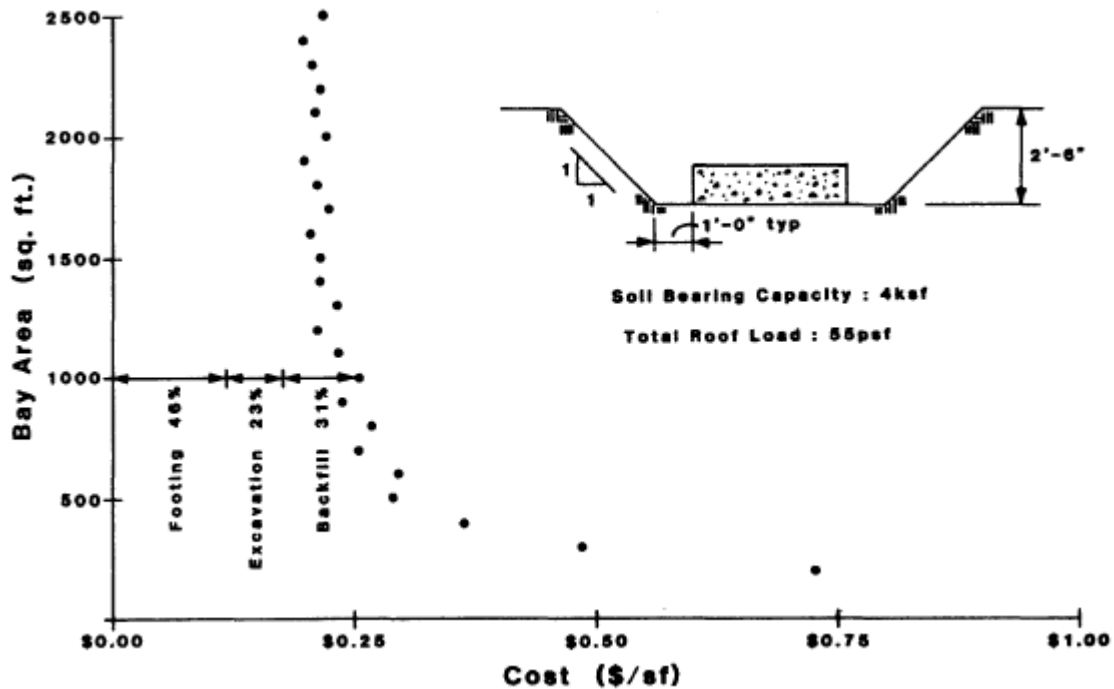

Figure 2-2: Spread Footing Cost Variation (Ruddy, 1983)

By contrast, footing costs per square foot were almost constant for bay areas greater than 500 ft². The footing cost for a 2500 ft² bay was about \$0.20/ ft² in 1983 dollars, which is only slightly less than the cost of the 500 ft² bay, which is only one-fifth the area.

With steel joists, steel weight was minimized at a bay size of roughly 200 ft² and a length-to-width ratio of 1:1 as indicated in Figure 2-3. The grey area demonstrates the general trend of the figure. The cost of steel per pound varies slightly as a function of bay area such that the steel cost for bay areas greater than 500 ft² was nearly constant around \$0.50/lb, while the cost rapidly increased past \$1.00/lb for bay areas less than 500 ft² as indicated in Figure 2-4. When these costs are applied to the weight results, it reveals that a bay area of roughly 300 ft² (about 17-foot by 17-foot) minimizes steel costs.

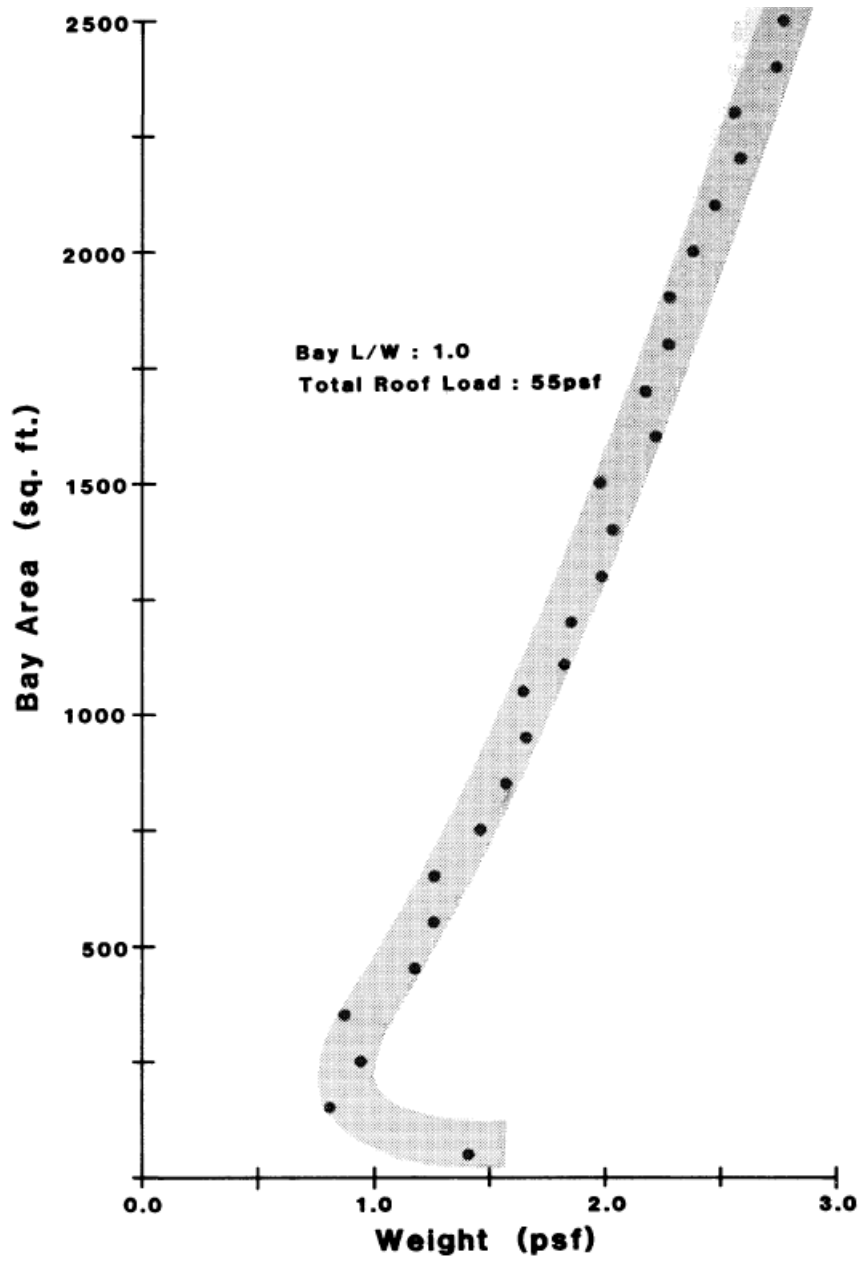

Figure 2-3: Joist Weight Variation (Ruddy, 1983)

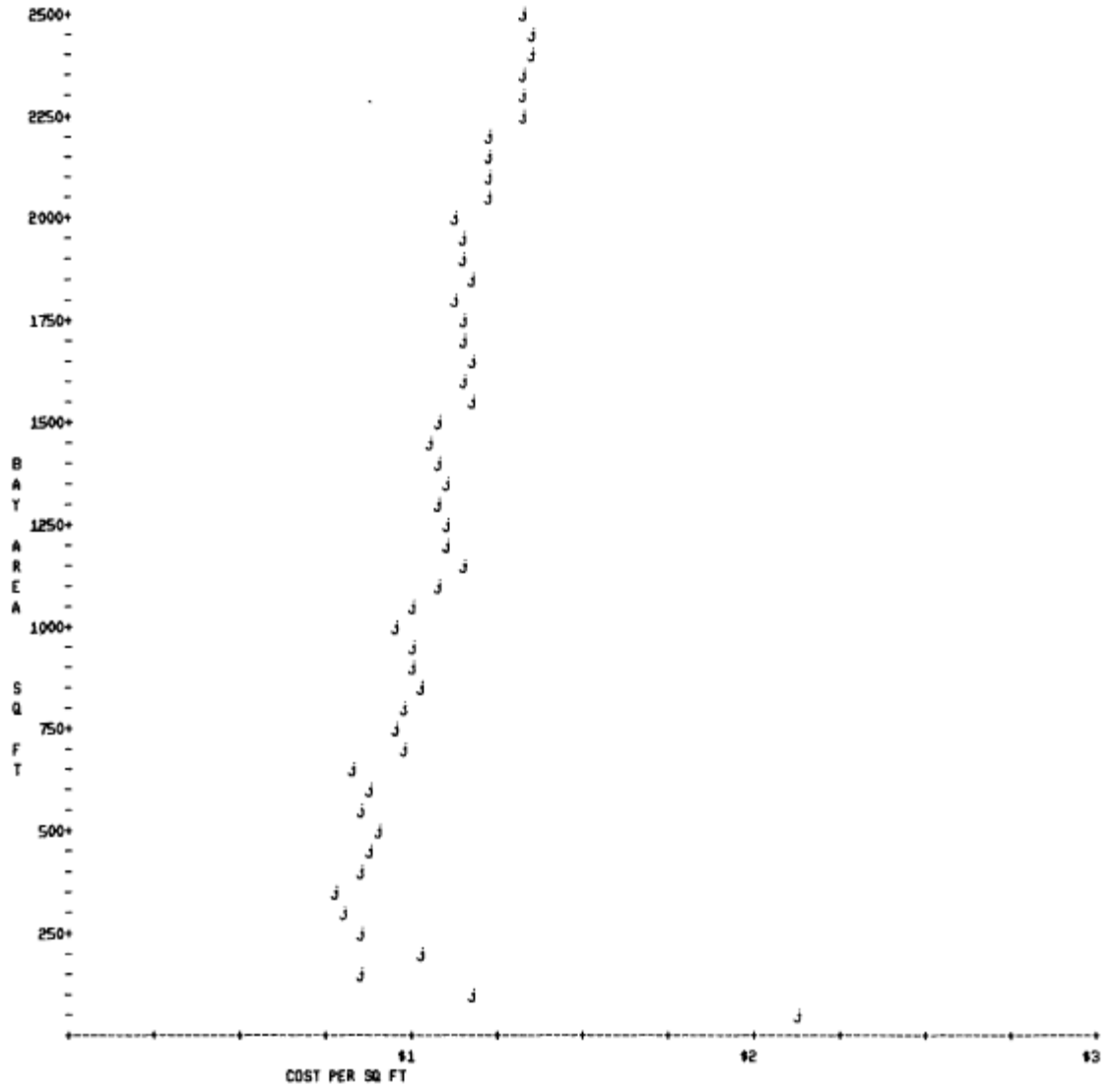

Figure 2-4: Joist Cost Variation (Ruddy, 1983)

Girder weight is minimized for a bay area of roughly 350 ft², but increases considerably as the bay area decreases as indicated in Figure 2-6. In regard to steel costs, girder costs are least for bay areas near 500 ft². Bays larger than 500 ft² become only slightly more expensive per square foot. Again, steel costs increase severely as the bay area drops below 250 ft².

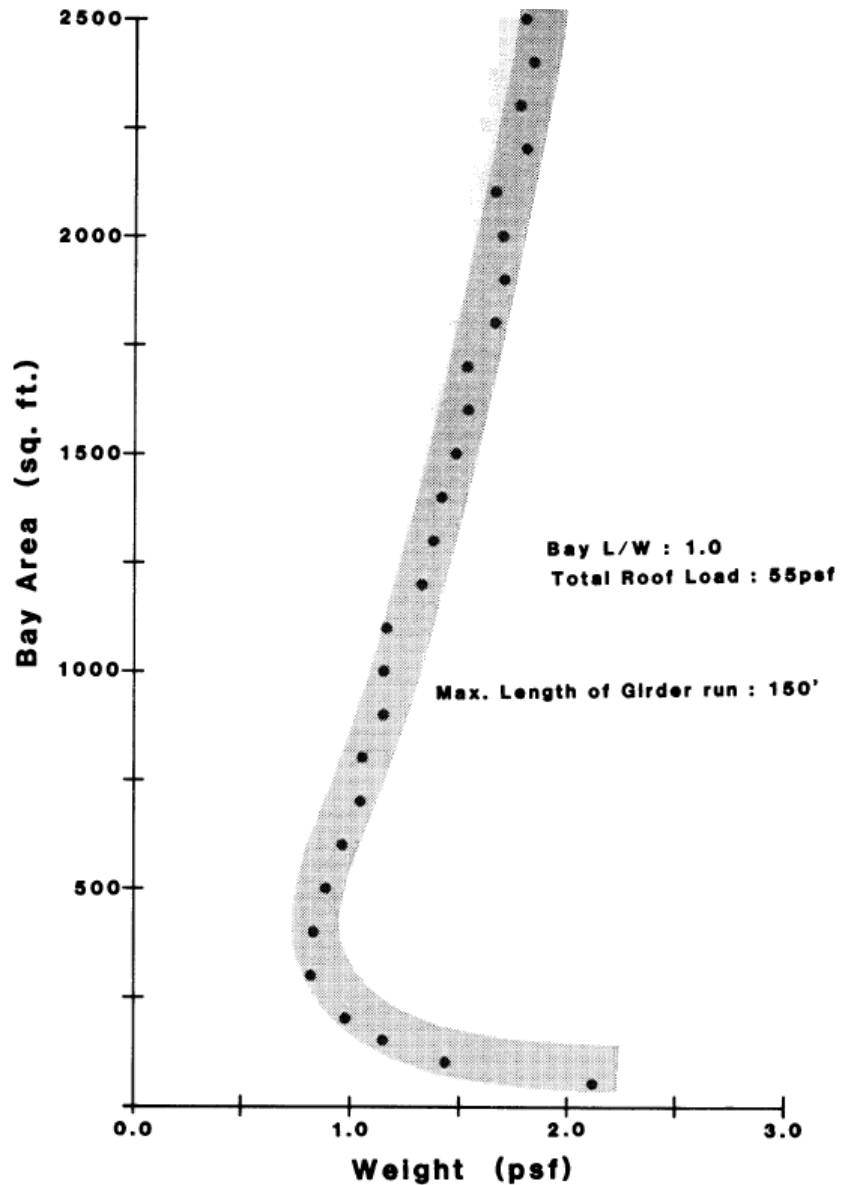

Figure 2-5: Girder Weight Variation (Ruddy, 1983)

As shown in Figure 2-6, columns have a unique cost and weight profile compared to all of the other examined parameters. Column weight starts at almost 3 lb/ft² for a bay area of 150 ft² and continually decreases as the bay area increases. Column weight drops below 1 lb/ft² for 500 ft² bays and reaches a mere 0.25 lb/ft² for a bay area of 2500 ft². Column steel costs reflect the same type of behavior. For 250 ft² bays, columns cost

\$2.50/ft²; at 500 ft², they cost \$1.00/ft²; for bay areas of 2500 ft², columns cost only \$0.50/ft².

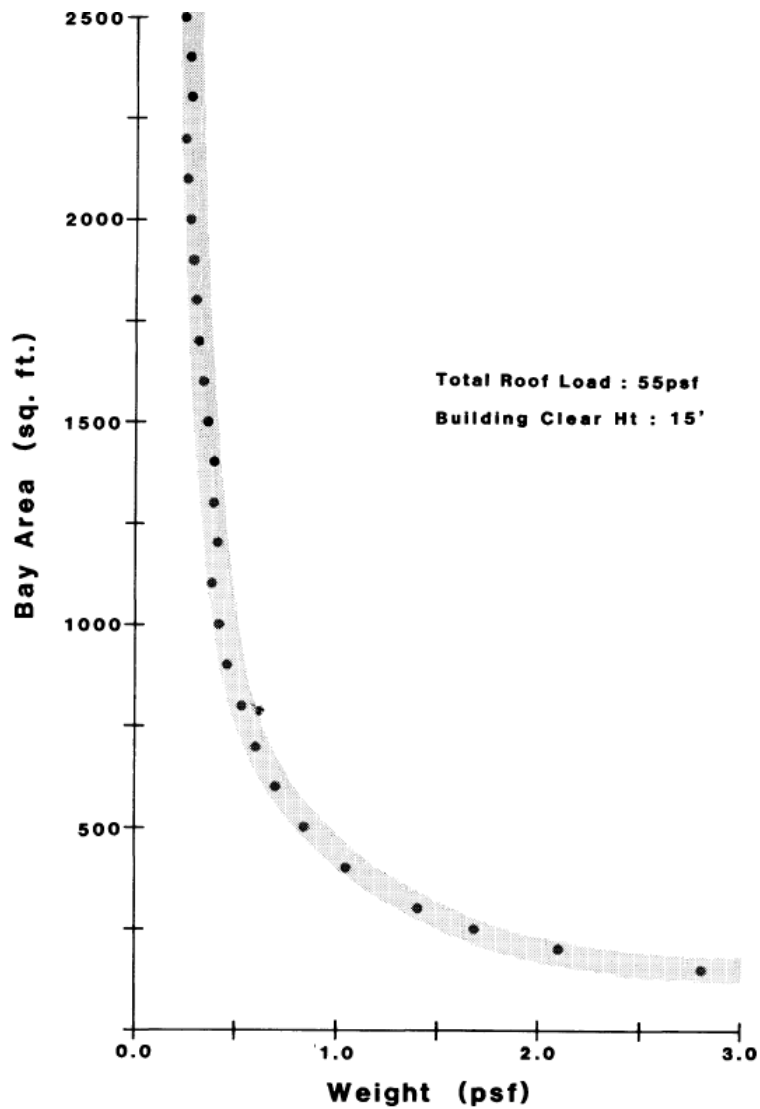

Figure 2-6: Column Weight Variation (Ruddy, 1983)

The magnitude of the roof load produces considerable effects on both the structure costs and the bay sizes that produce the minimal cost. As the roof load increases from 30 lb/ft² to 80 lb/ft², the optimal bay size decreases while the structure cost increases significantly. At a 30 lb/ft² roof load, the optimal bay size is around 1000-1250 ft² and the

cost was roughly \$1.70/ ft². In comparison, at a roof load of 80 lb/ft² the optimal bay size shrinks to about 750 ft² while the structure cost increases to greater than \$2.50/ ft². This represents a 50% increase in structure costs with a simultaneous 40% decrease in bay area.

When combining all of the study's parameters as shown in Figure 2-7, the final result shows that a bay area ranging from 750-1250 ft² with a length-to-width ratio of 1.25-1.75 will produce a design that minimizes structure costs. As seen earlier, the roof load, along with each of the other building parameters, has a significant effect on the exact proportions of the economical bay size.

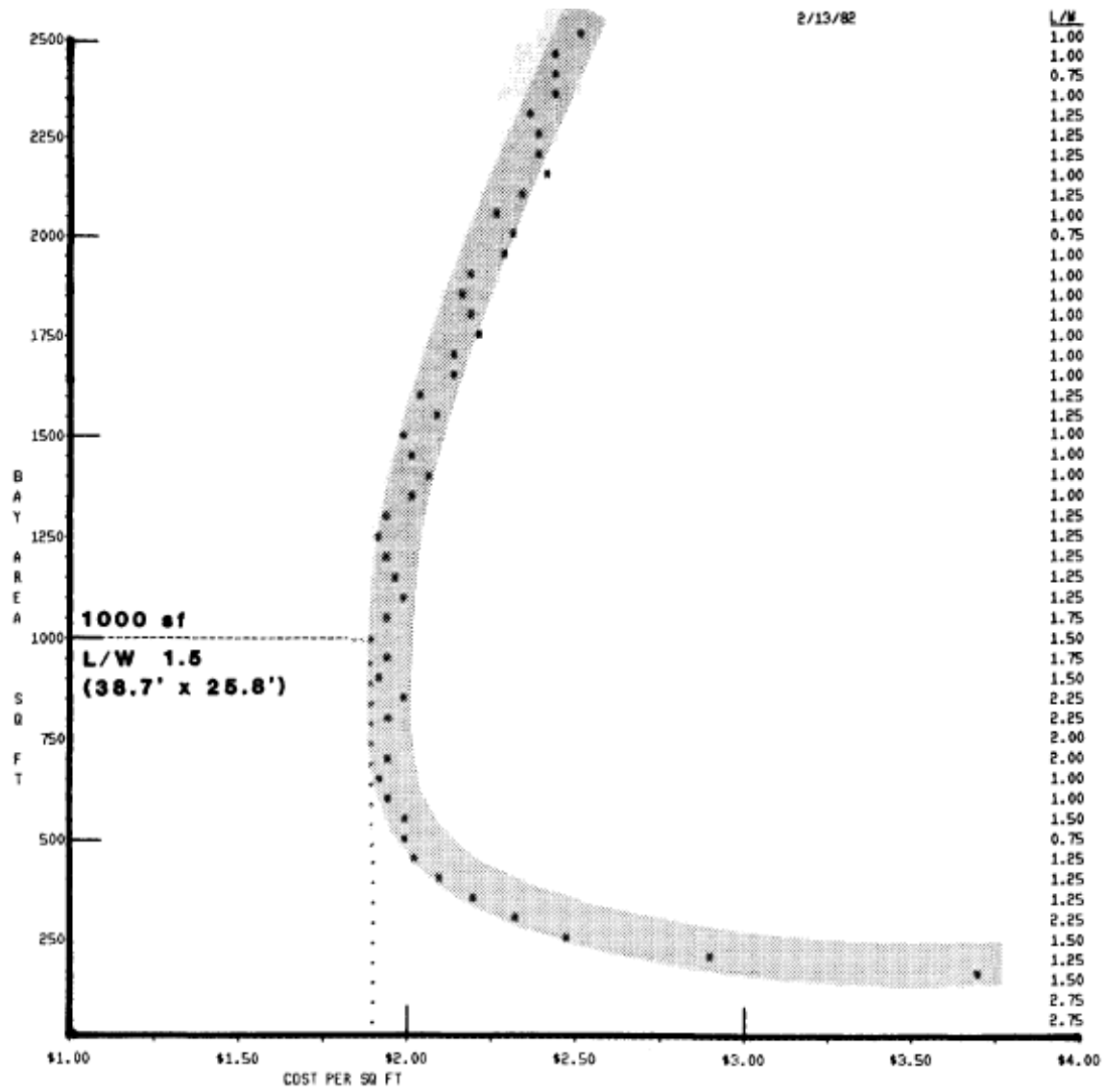

Figure 2-7: Least Cost of Steel Elements (Ruddy, 1983)

Conclusion - Ruddy 1983

From the bay areas and length-to-width ratios produced from Ruddy's study, the resulting optimal bay dimensions range from 32-foot by 24-foot to 47-foot by 27-foot with joists spanning the long direction. Ruddy notes that the dominating factor affecting the economical bay size of a structure is the roof load intensity. The highest roof load tested in

this study is 80 lb/ft². While this is a heavy load for roof structures, floor loads have the potential to be significantly higher.

Given that higher roof loads tend to reduce the optimal bay size, it is likely that floor bays have optimal sizes that are even smaller than the 750-1250 ft² proposed in this study. Furthermore, it is possible that the theoretical optimal bay size for some floor conditions may be smaller than practical limits of design and construction. As an example, if the optimal bay size for a floor was 100 ft² (10-foot by 10-foot) the bay size would be too small to be a useful space to the occupants, and it would be difficult to construct due to the close spacing of members. At this point, determining an appropriate bay size would be a semi-arbitrary balance between a more flexible use of space afforded by larger bays, which would be countered by the increased costs associated with increasing the bay size. In order for the space to be more flexible for different uses and occupancies, a minimum bay area should be utilized when determining optimal bay dimensions.

As shown in Ruddy's study, foundation costs associated with spread footings are nearly constant across all bay areas larger than about 500 ft². Cost factors that remain constant regardless of bay area do not affect the size of economical bays; rather, they only help determine the cost of a bay. With this in mind, foundation parameters can be neglected in analysis of economical floor bay sizes when the foundation system consists of spread footings. This is not the case for other types of foundation systems, which requires their inclusion in the analysis to achieve meaningful results.

“Rules of Thumb for Steel Design”: Ioannides, Ruddy, 2004

Although a variety of sophisticated analysis software tools exist to aid engineering design, a place still exists for design rules of thumb. Rules of thumb often provide a starting point for designs that require multiple iterations, as well as allowing engineers to make quick estimations about the solution to a design problem. Rules of thumb are not a substitute for proper engineering analysis, but do act as a complement to analysis by providing a quick approximation to compare results. In “Rules of Thumb for Steel Design”, Socrates Ioannides and John Ruddy discuss a wide range of rules of thumb and approximations, including their derivations, origins, and accuracy.

Structural Depths – Ioannides & Ruddy 2004

Non-composite steel beam designs typically result in members having a span-to-depth ratio, L/D , in the range of 20 to 28. For example, a member that spans 30 feet will likely have a depth between 12 inches and 18 inches depending on the exact load conditions. When this ratio is converted so that the span is expressed with feet while the depth is expressed with inches, it becomes approximately $D=0.6L$.

Composite beams have a slightly higher L/D ratio due to the strength benefits of composite action. Ioannides and Ruddy place this ratio at roughly 21, so $D = 0.55L$.

Beam Section Properties – Ioannides & Ruddy 2004

Ioannides and Ruddy also discuss approximations for the moment of inertia and section modulus of beam members. These approximations result from apply basic, yet accurate, assumptions about the proportions of cross-section of a typical wide-flange beam.

Consider a generic, doubly-symmetric wide flange member. The exact moment of inertia of the section depends on the flange thickness, flange width, section depth, and web thickness. All of these dimensions are unique to each section and cannot be generalized easily; however, the proportions of these dimensions are fairly consistent across sections. Specifically, if the section is divided horizontally about its neutral axis, the resulting top and bottom T-shape sections have their individual neutral axes located at roughly $0.4d$ from the neutral axis of the whole section, where “ d ” is the depth of the whole section as shown in Figure 2-8.

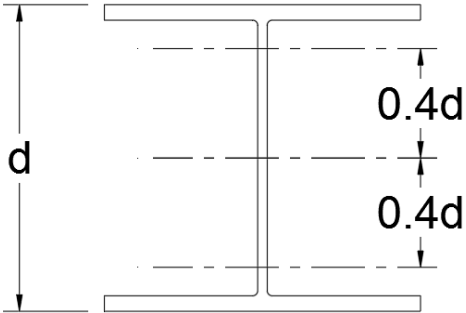

Figure 2-8: Typical Wide Flange Section

Using this, the Parallel Axis Theorem can be applied to the two T-shapes to find the moment of inertia. The Parallel Axis Theorem states:

$$I = \sum (I_0 + Ay^2) \tag{Equation 2-1}$$

where:

I = moment of inertia of entire section (in⁴)

I_0 = moment of inertia of component section about its own neutral axis (in⁴)

A = area of component section (in²)

y = distance from component neutral axis to total section neutral axis (in)

As stated above, the T-shape members have neutral axes located a distance of $0.4d$ from the total section neutral axis, therefore:

$$y = 0.4d \quad \text{Equation 2-2}$$

Additionally, the moment of inertia of each T-shape about its own axis is much smaller than the total moment of inertia, so it can be neglected. Therefore:

$$I_0 \approx 0 \quad \text{Equation 2-3}$$

Plugging these assumptions into the Parallel Axis Theorem equation and simplifying produces the following:

$$I = \sum (I_0 + Ay^2) \quad \text{Equation 2-1}$$

Neglect the inertia about individual axes.

$$I = \sum (Ay^2) \quad \text{Equation 2-4}$$

Substitute assumptions described above.

$$I \approx \sum (A(0.4d)^2) \quad \text{Equation 2-5}$$

Since two T-shape sections exist, summing the components produces two times the inertia of one T-shape.

$$I \approx 2 * A * (0.4d)^2 \quad \text{Equation 2-6}$$

Adding together the areas of both T-shapes results in the area of the original section, A_s .

$$I \approx A_s * (0.4d)^2 \quad \text{Equation 2-7}$$

$$I \approx 0.16A_s d^2 \quad \text{Equation 2-8}$$

Equation 2-8 shows the moment of inertia as a function of only section area and section depth. While the section depth may be rather simple to measure, the section area of a wide flange member is not; however, the section area can be used to find the section weight per foot for the member. This leaves the section depth and section weight as variables for the moment of inertia, both of which are identifying properties of a wide flange (i.e. a W14x90 has a nominal depth of 14 inches and weighs 90 lb/ft). To find the section weight, multiply the volume of a 1-foot-long section of the member by the specific weight of steel.

$$Wt = \gamma_s V \quad \text{Equation 2-9}$$

where:

Wt = section weight (lb/ft)

γ_s = specific weight of steel (490 lb/ft³)

V = volume of 1-foot-long section (ft³)

Furthermore, the volume can be written as the section area multiplied the length. Since the section area is typically expressed in square inches, divide the area by 144 to convert from in² to ft².

$$Wt = 490 * \frac{A_s}{144} * 1$$

$$Wt = 3.4A_s$$

$$A_s = \frac{Wt}{3.4} \quad \text{Equation 2-10}$$

Substituting into the original moment of inertia equation yields:

$$I \approx 0.16A_s d^2 \quad \text{Equation 2-8}$$

$$I \approx 0.16 * \frac{Wt}{3.4} * d^2 \quad \text{Equation 2-11}$$

$$I \approx \frac{Wt \cdot d^2}{20} \quad \text{Equation 2-12}$$

Considering that this equation utilizes no section properties aside from the section weight and height, the approximation produces values typically within 10% of the exact value.

Table 2-1 shows commonly used beam sizes varying in size from W8x10 to W24x76.

Table 2-1: Comparison of Actual Versus Approximate Moments of Inertia

| I_x (in ⁴) | | | | |
|--------------------------|---------|--------|--------------|--|
| Section | Approx. | Actual | % Difference | |
| W 8 x 10 | 32 | 30.8 | 3.9% | |
| W 10 x 12 | 60 | 53.8 | 11.5% | |
| W 12 x 19 | 137 | 130 | 5.2% | |
| W 14 x 22 | 216 | 199 | 8.3% | |
| W 16 x 31 | 397 | 375 | 5.8% | |
| W 18 x 40 | 648 | 612 | 5.9% | |
| W 21 x 55 | 1213 | 1140 | 6.4% | |
| W 24 x 76 | 2189 | 2100 | 4.2% | |

The potential weakness of this approximation lies in the assumption made about the distribution of material in the cross section. The center of mass of each T-shape is assumed to be $0.4d$ from the total section neutral axis; however, this varies depending on the proportions of the flange compared to the web. For instance, lighter W-shape sections in a series have smaller flanges compared to the size of the web, producing a parallel-axis distance less than the assumed $0.4d$. Conversely, heavier sections of a series have larger flanges in comparison to their webs, resulting in a parallel-axis distance more than $0.4d$.

This variation becomes apparent when comparing different beams from the same series, a W24x55 and W24x84 for instance. A W24x55 has an approximate moment of inertia of 1584 in⁴, which is 17% greater than the actual moment of inertia of 1350 in⁴. By contrast, a W24x84 has an approximate moment of inertia of 2419 in⁴, which is only 2% greater than the actual value of 2370 in⁴.

Additionally, several iterations of rounding take place during the formulation of this equation. The most critical instance occurs at the beginning of the derivation when the parallel axis distance of $0.4d$ is selected. Although a value such as 0.44 may be more

appropriate, the number is rounded to 0.4 for simplicity. Although this approximation possesses flaws, it is certainly more than adequate for quick calculations.

Section Modulus – Ioannides & Ruddy 2004

A similar approximation for the elastic section modulus results from combining the definition of the section modulus with the moment of inertia approximation from above.

Consider Equation 2-13 for the elastic section modulus:

$$S = \frac{I}{c} \quad \text{Equation 2-13}$$

where:

S = elastic section modulus (in³)

I = moment of inertia (in⁴)

c = distance from neutral axis to extreme beam fiber (in)

The moment of inertia approximation is substituted into the term for the moment of inertia. Additionally, the distance from the neutral axis to the extreme fiber for doubly-symmetric section is simply half of the section depth.

$$I \approx \frac{Wt \cdot d^2}{20} \quad \text{Equation 2-12}$$

$$c = \frac{d}{2} \quad \text{Equation 2-14}$$

Substituting these items into the original section modulus equation yields the following:

$$S \approx \frac{Wt \cdot d}{10} \quad \text{Equation 2-15}$$

Because this equation depends on the moment of inertia approximation, this approximation possesses similar strengths and weaknesses as a design tool. Another important point to note is that a similar approximation cannot be made for the plastic section modulus using the same method, due to the plastic stress distribution on the section.

Column Section Properties – Ruddy 2004

Ruddy and Ioannides also discuss several rule-of-thumb approximations for column section properties and critical stresses. The most important among these is that for the weak-axis radius of gyration, which directly affects compressive strength of a member. Recall that the basic definition of the weak-axis radius of gyration is as follows:

$$r_y = \sqrt{\frac{I_y}{A}} \quad \text{Equation 2-16}$$

For W-shape members, the flanges contribute the vast majority of the weak-axis moment of inertia, while the moment of inertia of the web is negligible. As such, approximating the weak-axis moment of inertia as the moment of inertia of the flanges produces:

$$I_y = 2 \left(\frac{1}{12} t_f b^3 \right) \quad \text{Equation 2-17}$$

where:

t_f = flange thickness (in)

b = flange width (in)

Similarly, the area of the section can be approximated as the area of only the flanges for the purposes of simplifying the analysis.

$$A \approx 2bt_f \quad \text{Equation 2-18}$$

Substituting these equations into the original definition of the radius of gyration produces:

$$r_y = \sqrt{\frac{2\left(\frac{1}{12}t_f b^3\right)}{2bt_f}} \quad \text{Equation 2-19}$$

$$r_y = \sqrt{\frac{b^2}{12}} \quad \text{Equation 2-20}$$

$$r_y = 0.289b \approx 0.25b \quad \text{Equation 2-21}$$

The resulting radius of gyration is roughly equal to 29% of the flange width of the section. Rounding down to 25% of the flange width is more conservative, easier to remember, and compensates for excluding the area of the web.

Steel Weights - Ruddy 2004

Ruddy and Ioannides introduce a method for estimating the section weight of a beam for a given section depth and required moment capacity. Equations for both 36 ksi and 50 ksi steel grades are provided. Equations 2-22a and 2-22b are formulated using ASD and utilize elastic stress distribution.

$$F_y = 36 \text{ ksi:} \qquad Wt \approx \frac{5M}{D} \qquad \text{Equation 2-22a}$$

$$F_y = 50 \text{ ksi:} \qquad Wt \approx \frac{3.5M}{D} \qquad \text{Equation 2-22b}$$

where:

Wt = section weight (lb/ft)

M = required moment strength (k-ft)

D = nominal section depth (in)

These equations represent more than strictly empirical rules of thumb; they are derived directly from section properties of wide flange members. Although the equations presented in the article use Allowable Stress Design, they can be re-formulated to utilize Load Resistance Factor Design methods. A detailed analysis and derivation of this equation into terms of LRFD is included in the Appendix section of this thesis.

Total Weight - Ruddy 2004

Finally, Ruddy and Ioannides provide weight approximations of the total structural steel per square foot in a building. The approximation comes in the form of a graph of steel weights per square foot of several major projects that utilize steel construction. These steel weights are plotted versus the number of stories that the project possesses, resulting in the figure below.

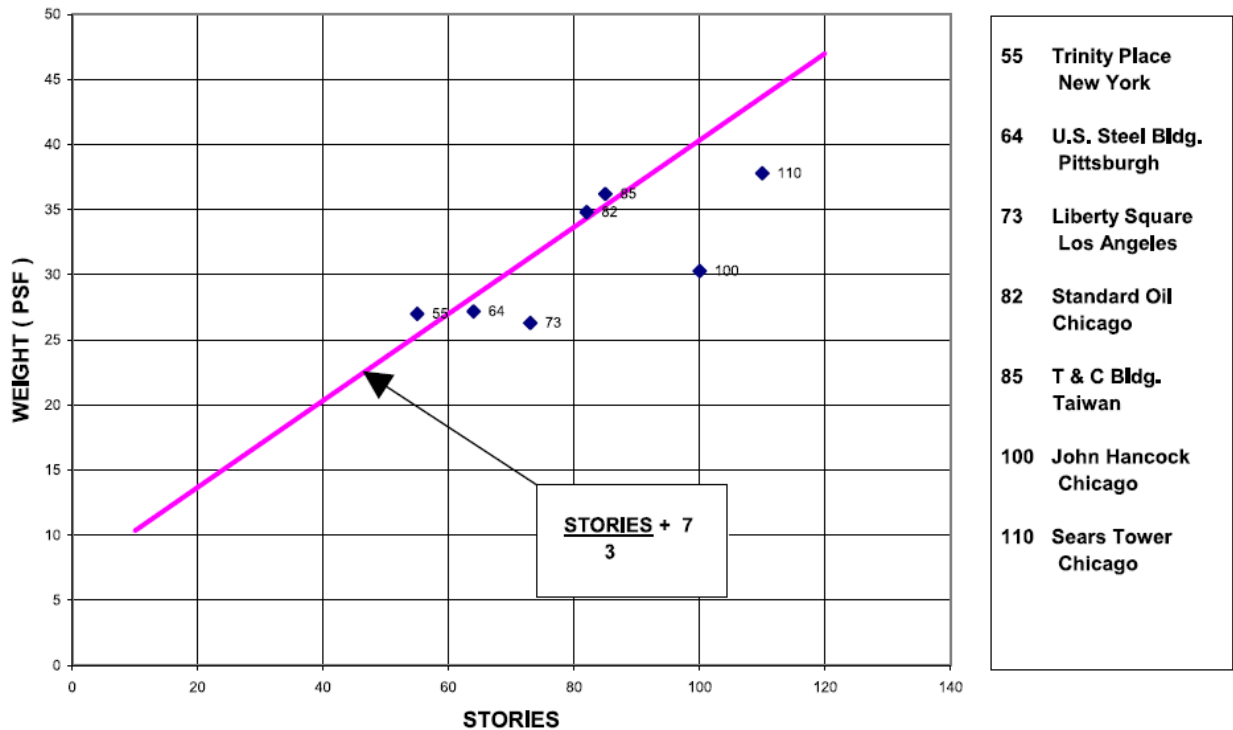

Figure 2-9: Steel Weight Versus Building Stories (Ruddy, 2004)

The graph shows a tendency for the steel weight per square foot to increase as the number of stories increases. The resultant best-fit straight line corresponds to Equation 2-23.

$$Wt = \frac{N}{3} + 7 \quad \text{Equation 2-23}$$

Wt = structural steel weight (lb/ft²)

N = number of stories

Considering that the range of stories for projects plotted on the graph range from 55 to 110 stories, this approximation likely applies only to buildings with a large number of stories. Buildings with only a small number of stories likely behave differently.

Conclusion - Ruddy 2004

Many of these rules of thumb provide simplifications of complex relationships that are used in several derivations found in the Appendix of this thesis. The beam span-to-depth ratios and moment of inertia equations, as well as the beam section weight equations assist with the derivation of equations for beam and girder weights per square foot. Although many parameters affect the steel weight of beams in a framing system, these rules of thumb simplify the situation by relating parameters to one another.

“Design Guide 5: Low- and Medium-Rise Steel Buildings”: AISC, 2003

Design Guide 5 published by the American Institute of Steel Construction discusses a wide variety of topics concerning the design and construction of low-rise and medium-rise steel buildings. The specific topics included in the design guide concerning the topic of this analysis include basic rules for economical design, live load and bay size selection, and factors concerning composite member design and construction.

Basic Design Rules for Economy

Designing an economical framing system for a building requires effective planning and forethought on the part of the engineer. Two basic design rules hold the potential to dramatically reduce the cost of the structural system of a building.

First, create a framing layout that maximizes the use of repetitive member sizes arranged in a regular, repeating pattern. This produces two benefits that reduce project costs. Duplicating members enables fabrication and construction discounts due to economies of scale. Additionally, a simple, regularly-spaced framing pattern further simplifies fabrication and construction processes while also producing a clean, well-defined load path that reduces the size requirements of the structural members.

Second, utilizing the maximum allowable live load reduction code provisions produces additional steel savings by reducing the strength demand of framing members. This savings is especially pronounced in the design of column members, where it is possible to eliminate a majority of the gravity live load demand using live load reduction. Even reducing a member by one size potentially saves a considerable amount of steel weight and cost over the entirety of the project.

Live Load and Bay Size Selection

An important first decision for a project, and a major topic of the design guide, is the determination of the design live load for the building's floor structure. Initially, it appears intuitive that selecting a heavier live load results in a proportionally heavier and more expensive structure; however, the design guide indicates that this is not necessarily the case. In fact, it states that the live load for a space such as an office can be increased "from the minimum permitted design live load of 50 lb/ft² plus 20 lb/ft² partition load to a 100 lb/ft² live load capacity (with no additional partition load allowance) at virtually no increase in cost."

To demonstrate this, the Design Guide includes an example building with 30-foot square bays and 10 stories to compare the steel costs for the different live load intensities. The bay with 50 lb/ft² live load plus 20 lb/ft² partition load costs \$1.41/ ft², while the 100 lb/ft² live load bay cost \$1.50/ ft². Although the bay with the heavier live load costs more, the difference is a mere \$0.09/ ft², a 6% increase in cost. Considering that this increase results from a live load increase greater than 40%, the corresponding increase in steel costs is essentially negligible.

According to the design guide, framing bay dimensions play less of a role in the cost of the structural system than anticipated. Selecting smaller bay dimensions does not appreciable decrease the structural costs. Reducing the number of framing pieces typically produces a more significant reduction in costs.

To demonstrate, the design guide provides a comparison between bay sizes of 25-foot by 25-foot, 30-foot by 30-foot, and 30-foot by 40-foot. In addition, another 30-foot by 30-foot bay with closer beam spacing is added to demonstrate the cost of additional

framing pieces. The results are shown in Table 2-2 below, with the 25-foot by 25-foot bay used as reference.

Table 2-2: Percentage Comparison of Per-Square-Foot Costs (AISC, 2003)

| Bay Size | Mill Material | Fabrication & Delivery | Erection & Studs | Composite Deck | Total |
|---------------------|---------------|------------------------|------------------|----------------|-------|
| 25' x 25' | 21% | 14% | 34% | 31% | 100% |
| 30' x 30' | 25% | 14% | 32% | 32% | 103% |
| 30' x 30' (Alt.) | 31% | 16% | 35% | 31% | 113% |
| 30' x 40' | 31% | 13% | 33% | 32% | 109% |

Based on the results of the design guide example, increasing the bay size only produces minor increases in the cost per square foot of the structure. Doubling the bay area from 25 feet by 25 feet (625 ft²) up to 30 feet by 40 feet (1200 ft²) increases the structure costs per square foot by less than 10 percent. By contrast, changing the framing layout to include an extra filler beam in the 30 foot by 30-foot bay increases the steel cost per square foot by 10% without any associated benefit to the structure. The design guide concludes that “the smallest bay size and lowest live load probably will not produce the most economic design” when considering the project as a whole.

Composite Design

The inclusion of composite members into the design of the floor system introduces the potential for significant weight and costs savings in the structure. Mechanically attaching the concrete slab to the steel beams below allows for the slab material to be utilized in resisting bending moment of the beam. Despite the added costs of purchasing and installing shear studs, composite construction typically reconciles these costs with a

substantial reduction in steel member sizes. As such, composite construction has become a commonplace construction technique.

Shored Construction

With composite construction, an important choice presents itself with regard to the method of supporting the metal deck and wet concrete during the placing stage. Both options, shored construction and un-shored construction, each possess unique advantages and disadvantages which present themselves in both the design and construction phases.

With shored construction, the metal deck alone cannot provide sufficient strength and stiffness to support the construction loads, including the wet concrete before it cures. To supplement the strength of the metal deck, shoring is placed to support the deck and concrete until the concrete can accept its portion of the structural demand. The primary advantages of this method exist in the design phase. First, the member deflection only needs to be calculated for the composite section, since the non-composite stage of the member supports relatively small loads due to the shoring equipment. Second, the bare steel section does not need to be checked for strength requirements. Again, this is due to the support received from the shoring.

Several disadvantages accompany the use of shored construction. In contrast to the advantages, which occur during the design of the member, the disadvantages occur typically during and after construction has taken place. The most obvious disadvantage is that assembling and placing shoring takes considerable amounts of time. Once the shoring is in place, it must remain until the concrete gains sufficient strength. This adds further

time to the construction process. The additional required time this process takes slows the rate of construction of projects, especially those with multiple floors.

By contrast, the advantages and disadvantages of un-shored construction are essentially the inverse of those for shored construction. While the advantages of shored construction primarily facilitate simplified design procedures, un-shored construction benefits the construction procedures at the expense of increasing the design requirements.

The main advantage of un-shored construction lies in its ease of construction. Unlike shored construction, the metal deck possesses the necessary strength to support the construction loads and wet concrete without the assistance of shoring. This permits the concrete to be placed immediately after the deck and studs have been installed on the structure, which shortens and simplifies the construction process.

Several additional design checks accompany un-shored construction that engineers must consider during the design phase. First, the bare steel section must be designed to support the construction loads and wet concrete, since shoring is not present. This requires a heavier beam section than would be needed for shored construction. Second, the floor structure becomes more vulnerable to high deflections due to ponding of the wet concrete. This results in concrete thicknesses greater than necessary near the centers of bays, while inadequate concrete thicknesses are more likely near the edges of a bay. One method to remedy this problem involves cambering the beams to balance the dead load deflection; however, specifying camber greater than necessary to counter-act the deflection from the wet concrete may result in the opposite problem, where wet concrete ponds near the edges of a bay. This decreases the concrete thickness near the middle of the bay, decreasing the

final strength of the composite section. In addition, the increased cost of cambering members can be more than the steel savings from using a shallower section.

Conclusion

Design Guide 5 highlights several tips that improve the costs of a framing design. A repetitive framing layout decreases costs through economies of scale by allowing fabricated members to be duplicated as much as possible. As shown by examples in the Design Guide, the selection of floor live loads has only a minor effect on the cost of a framing system.

Composite construction significantly reduces the amount of steel used in a framing system. Both methods of composite construction, shored and un-shored, have their advantages and disadvantages in construction and design. Un-shored construction requires less time and manpower due to the lack of shoring.

“Value Engineering for Steel Construction”: David Ricker, 2000

An engineer must be well-rounded in their knowledge of building construction in order to make educated design choices during any stage of the planning, design, and construction of a building. David Ricker discusses several items that should be considered during the design of a building that require knowledge outside of a single construction discipline.

Stay Informed about Material Costs

Knowledge of the economic factors associated with different steel designs allows an engineer to make educated decisions regarding design costs. Local steel fabricators serve as a source of information such as steel costs and mill extras. According to Ricker, “approximately 30% on material, 30% on shop costs, 30% on erection, and 10% of other items such as shop drawings, painting and shipping. *Labor is more than 60%!*”

Use of Composite Beams

Although fully-composite members possess strength superior to partially-composite members, the costs required to achieve full composite action usually exceed the structural benefits. According to Ricker, the cost of one shear stud roughly equates to the cost of 10 pounds of steel. Because of this cost, the optimal member design utilizes somewhere between 50-75% of full composite action. This compromise enables the strength benefits of composite design without requiring an excessive quantity of shear studs.

Selection of Optimal Bay Sizes

Ricker quotes the parametric study performed by John Ruddy in 1983 that deals with economical bay sizes and dimensions. As discussed, the study concludes that rectangular bays with an aspect ratio between 1.25 and 1.5, with beams spanning the long direction, produce the most economical designs. For more information on the results of the study, refer to the previous discussion.

Consider More than Minimum Steel Designs

Similar to the advice of Ruddy, Ricker advises that engineers do not simply select a design that minimizes steel weight, as other factors contribute to final structure cost that may result in a more expensive structure in the long term. The engineer should consider number of connections and members utilized in the design in order to keep fabrication and erection costs in check.

Design for Un-Shored Composite Construction

Shored construction of composite floor systems requires the installation of temporary shoring, which adds substantial costs to the project. Using un-shored construction, although more complicated to design, typically results in a less expensive design. Increasing the gauge of the deck or decreasing the span of the framing member saves money over the use of shoring.

Duplication of Member Sizes

While design a structure for the duplication of members may result in inefficiencies at small scales, it permits the fabricator to produce identical members on a larger scale, which results in lower fabrication costs. In general, a design that utilizes a smaller number of section sets costs less than a design of minimal weight with a large number of section sets.

Duplication of Member Connections

Just as designing for duplicated member sizes results in cost savings, designing for the duplication of connections reduces costs to an even greater extent. For connections, the cost of steel and hardware is essentially negligible compared to the cost of fabricating the connection. Designing a connection with four bolts instead of only three adds very little to the final cost of the connect; however, the four-bolt connection possesses a higher strength, allowing it to be used in a larger number of load conditions.

Conclusion

Ricker echoes the recommendations of many other sources discussed. Utilizing composite construction significantly decreases the amount of steel used in a project. When utilizing composite construction, adopting un-shored construction techniques for the floor system reduces the time and labor required to construct the composite floor slab, which further reduces costs. Framing layouts should allow for duplication of member sizes and connections, which reduces fabrication costs.

Chapter 3 - Analysis Method

Scope

This analysis intends to determine economical bay sizes for a typical steel-framed building supporting floor loads. Beam spacing, beam span, girder span, floor live load intensity, and composite versus non-composite construction are all parameters investigated in the analysis.

Beam center-to-center spacing varies from four feet up to 12 feet in two foot increments. Beam spacing varies independently from beam span. Beam spans range from 20 feet to 52 feet in four foot increments. Girder spans also range from 20 feet to 52 feet in four foot increments. Beam and girder spans vary independently of one another. Floor live loads include 50 lb/ft², 75 lb/ft², and 100 lb/ft². The effect of member construction type is also evaluated in this analysis by considering both composite and non-composite beams and girders. Columns remain as non-composite members throughout the analysis.

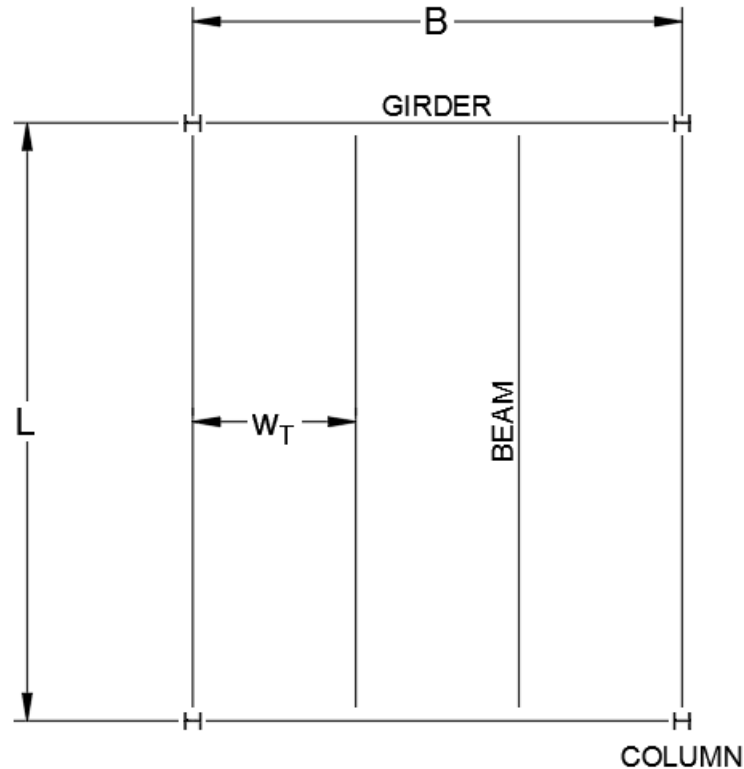

Figure 3-1: Framing plan of a typical bay.

Analysis Criteria

An “economical bay” may be defined in several ways; however, the most direct way to define an economical bay is in terms of steel weight or steel cost. Specifically, a bay that is economical in terms of steel weight would be a configuration which uses the least structural steel per square foot of bay area. Likewise, an economical bay in terms of steel cost would be a configuration which costs the least per square foot to fabricate and construct. As shown by Ruddy (1983), the definitions of the least-weight solution and the least-cost solution are not equivalent. Both definitions have value for design applications; however, this study will primarily focus on the least-weight solution due to variability of costs associated with fabrication and construction. Costs associated with fabrication and construction will only be discussed qualitatively.

The structural steel weight of a typical bay results from the summation of the weight of its structural members: beams, girders, and columns. These member weights depend on the size of the section selected during the design of the members. The weights of structural members can be represented in terms of lb/ft² by taking the weight of each member and dividing it by the supported tributary area. For beams and girders, this simplifies to dividing the member's section weight (pounds per foot) by the tributary width of the member, as shown by Equation 3-1 below.

$$H = \frac{Wt}{w_T} \quad \text{Equation 3-1}$$

where:

H = steel weight (lb/ft²)

Wt = member section weight (lb/ft)

w_T = member tributary width (ft)

For columns, the method is slightly different due to the fact that the tributary area is perpendicular to the span of a column member. Column weight per square foot can be determined by taking the weight of a one story tall section of the column and dividing it by the bay area of one floor, as shown in Equation 3-2.

$$H = \frac{Wt * h}{A} \quad \text{Equation 3-2}$$

where:

H = steel weight (lb/ft²)

Wt = member section weight (lb/ft)

h = floor-to-floor height (ft)

A = bay area (ft²)

Excluded from Analysis

In order to qualify the results, several factors are not considered as part of this analysis: foundation design, variations in story height, and variations in the number of stories.

In his 1983 study “Economics of Low-Rise Steel-Framed Structures”, John Ruddy found that costs associated with spread footing foundations were essentially constant across most bay sizes. Although the building analyzed in his study is slightly different than the one chosen for this study, it is reasonable to assume that foundation costs will likewise be constant across bay sizes for this building as well. This allows foundation parameters to be neglected, while maintaining the integrity of the analysis. Since foundation costs remain nearly constant in terms of dollars per square foot over differing bay areas, foundation design will not affect the results for determining economical bay dimensions.

The effect of story height and the number of stories is not investigated as part of this analysis. Unlike foundation parameters, story height and the number of stories will likely affect the size of an economical bay. As shown in Equation 3-2, the story height is represented as a term, meaning that story height does affect the structure weight. Taller stories require larger columns due to the longer un-braced column lengths. The increased

axial load from the larger number of stories will also tend to increase the column size, which will be required to resist the larger load. These variables will be eliminated from this analysis by keeping the story height and number of stories constant.

A quantitative analysis of the monetary costs of framing layouts is not provided as part of this study. Costs are considered qualitatively for fabrications and construction costs, such as shear stud installation and connection fabrication.

Building Parameters

The building used in this analysis is a steel-framed building with rectangular bays that are uniform in size. It is five stories, including the ground floor slab-on-grade, with each story having a floor-to-floor height of fifteen feet. The floor consists of 18-gauge 3-inch Vulcraft model 3VLI18 composite steel deck with 5-1/2-inch deep lightweight concrete (110 lb/ft³). Although the deck can be selected for each specific framing condition, it is kept constant in this study for simplicity. The profile of the deck is shown in Figure 3-2.

Figure 3-2: Section of Composite Metal Deck

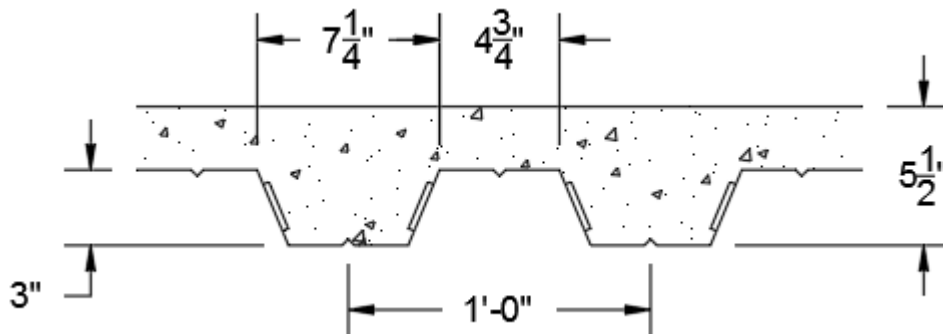

The metal deck is selected based on the maximum span and floor live load that is tested in the study, as well as fire rating considerations. The worst load case experienced by the deck is 100 lb/ft² live load while spanning 12 feet between beams. This eliminates 1.5-inch metal deck due to insufficient strength at such spans. While 2-inch metal deck is capable of spanning the required distance, it requires more concrete than 3-inch deck, which results in a higher dead load. Both strength and fire protection requirements determine the depth of the concrete. Considering strength alone, 18-gauge 3-inch composite deck with only lightweight concrete of 4-inch total thickness is sufficient; however, increasing the concrete thickness to 5-1/2 inches total provides a one-hour fire rating from the Underwriters' Laboratory without the need to apply any additional fire protection to the deck.

All beams, girders, and columns are designed with A992 Grade 50 steel wide flange sections. Members comprised of different section types or steel grades are not considered. All framing members are simply-supported. Columns are assumed to be a constant section for the entire height of the building without reducing section size at splices. This prevents column weight per square foot from varying from story to story.

Load Conditions

Structure loads include gravity dead loads and live loads. Dead loads include those from the structure self-weight and imposed loads from other building components. Live loads have been selected to reflect a range of common building occupancies, as well as account for construction loads in the composite steel design.

Dead load from floor deck and concrete is 40 lb/ft², while the imposed floor dead load is 15 lb/ft². Floor live loads are either 50 lb/ft², 75 lb/ft², or 100 lb/ft². A 50 lb/ft² live

load would be representative of an office without partitions, while 75 lb/ft² is more appropriate for an office space with partitions. A live load of 100 lb/ft² represents heavier occupancies such as assembly spaces. These three live load intensities cover a wide variety of possible building occupancies, which allow the results of this analysis to be applicable to many types of building occupancies. In addition to occupancy live loads, composite members are designed with a construction live load of 20 lb/ft² which acts on the member before composite action is achieved between the beam and slab (ASCE, 2010).

The roof is an ordinary flat roof that does not support any rooftop mechanical units or other large equipment that would act as a concentrated load. Roof dead loads consist of a 10 lb/ft² imposed dead load from building components such as insulation, waterproofing, etc., and a 20 lb/ft² dead load for the assumed steel framing and deck that supports the roof. A 20 lb/ft² live load acts on the roof in accordance with ASCE 7-10 live load provisions under Table 4-1 for ordinary flat roofs.

For the purposes of simplifying analysis, several load categories are not considered: seismic, wind, and snow loads, which are both highly dependent on the geographic location of the building, the exact geometric configuration of the building, and the lateral system of the building. Including these loads in even a limited extent would greatly complicate the analysis of the structure, possibly without adding any benefit to the results. In fact, adding loads that are dependent on location and geography would decrease the value of this analysis, as the results would become specific only areas similar to the location used in the analysis.

Member Design

All framing members are designed using the Load Resistance Factor Design method.

The governing ASCE 7-10 load combination for all members is Combination 2:

$$U = 1.2D + 1.6L + 0.5L_r$$

In addition to being designed for strength limit states, beams and girders are also designed for serviceability limit states for member deflection.

Beams

Beam center-to-center spacing varies from 4 feet up to 12 feet in two-foot increments. These spacing boundaries result from limits in construction techniques. Beams spaced closer than 4 feet on center become difficult to install due to lack of maneuvering space. The maximum beam spacing is limited by the maximum allowable span of the floor deck. This maximum span varies depending on the deck type and amount of concrete; however, spans greater than 12 feet become difficult to achieve with metal deck.

Beam span ranges from 20 feet to 52 feet in 4-foot increments. These span ranges result from practical limits of steel fabrication and construction. Steel members shorter than 20 feet are not commonly produced by steel mills as a standard size, so specifying shorter members result in mill extras. (Nucor-Yamato, 2016) According to AISC Design Guide 5 (2003), when bay dimensions begin to exceed 45 feet, other framing methods become more economical.

Non-Composite

Beam members are designed to resist flexural and shear forces imposed by the external loads. For non-composite beams, the concrete-filled metal deck is considered adequately stiff to laterally brace the compression flange against lateral-torsional buckling limit states. (Yura, 2001) This allows the beams to be governed by the limit state of flexural yielding, so beams develop their full plastic moment. Based on the total member forces, a wide flange member of least weight is first selected based on flexural strength alone using from the AISC Equation F2-1, shown below in Equation 3-3.

$$\phi M_n = \phi M_p = \phi F_y Z_x \quad \text{Equation 3-3}$$

where:

ϕ = strength reduction factor (0.9 for flexure)

M_p = plastic moment strength (k-in)

F_y = material yield stress (ksi)

Z_x = plastic section modulus about strong axis (in³)

Composite

Composite beams receive adequate lateral bracing from the deck and slab since the concrete slab is mechanically attached to the steel beam with shear studs. Figure 3-3 shows a typical section through a composite beam used in this analysis.

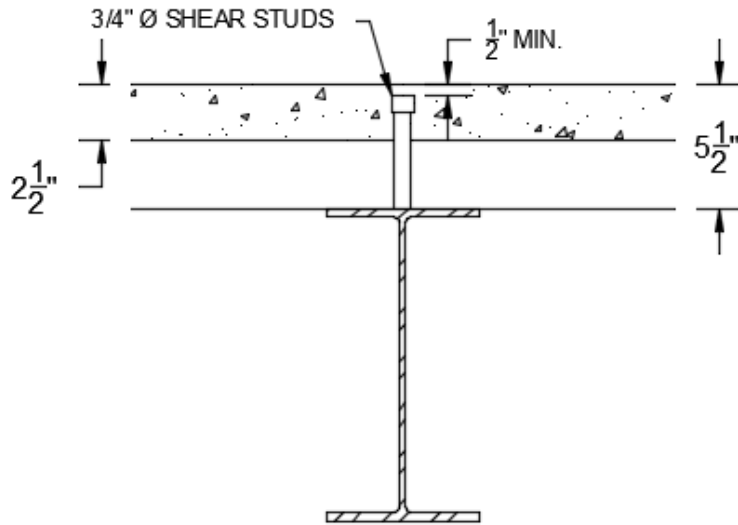

Figure 3-3: Composite Beam Section

Composite beams are designed to withstand loads experienced before and after composite action is achieved. Partial composite action is used in this study. Composite beams are designed to achieve 50% composite action, which Ricker suggests is more economical than full composite action (2000). The composite section resists all post-construction live and dead loads, while the non-composite section supports construction loads and the slab dead load. Live load reduction code provisions are not utilized in the analysis for beams. The three live load cases cover the variation of live loads for the purposes of this study.

After sizing a member for flexure only, the members must satisfy shear strength requirements. Shear strength is determined using AISC Equation G2-1, which is shown below as Equation 3-4.

$$\phi V_n = \phi 0.6 F_y A_w C_v \quad \text{Equation 3-4}$$

where:

ϕ = strength reduction factor (1.0 for compact wide-flange members)

F_y = material yield stress (ksi)

A_w = section web area (in²)

C_v = web shear coefficient (1.0 for compact wide flange shapes)

In addition to strength requirements, beams are designed to satisfy deflection limits for floor members as specified in the 2015 International Building Code (IBC). Table 3-1 summarizes the deflection limits described in the 2015 IBC.

Table 3-1: 2015 IBC Allowable Deflections

| Construction | L | S or W | D + L |
|--------------------------------------|-------|--------|-------|
| Roof members: | | | |
| Supporting plaster or stucco ceiling | L/360 | L/360 | L/240 |
| Supporting non-plaster ceiling | L/240 | L/240 | L/180 |
| Not supporting ceiling | L/180 | L/180 | L/120 |
| Floor members | L/360 | - | L/240 |
| Exterior walls: | | | |
| With plaster or stucco finishes | - | L/360 | - |
| With other brittle finishes | - | L/240 | - |
| With flexible finishes | - | L/180 | - |
| Interior partitions: | | | |
| With plaster or stucco finishes | L/360 | - | - |
| With other brittle finishes | L/240 | - | - |
| With flexible finishes | L/180 | - | - |
| Farm buildings | - | - | L/180 |
| Greenhouses | - | - | L/120 |

For this research, maximum member deflections due to live loads shall not exceed L/360, and maximum deflections due to combined dead and live loads shall not exceed L/240. Composite beams are designed to have a maximum pre-composite deflection not exceeding L/360 due to construction and pre-composite loads. Beam cambering is not

considered as a method to reduce deflection for the purposes of simplifying this analysis. The full dead load is included in calculating the member deflection under the total load. This results in a conservative design and helps minimize concrete ponding due to excessive member deflection during concrete placement. Member deflection are determined using Equation 3-5.

$$\Delta = \frac{5wL^4}{384EI} \quad \text{Equation 3-5}$$

where:

Δ = member mid-span deflection (in)

w = uniformly-distributed service-level load intensity (k/in)

L = member span (in)

E = elastic modulus (ksi) (29,000 ksi for steel)

I = moment of inertia about bending axis (in⁴)

Deflection is checked using the deflection equation for a beam as shown in Equation 3-5. This equation is reworked to produce an L/Δ value based on the input moment of inertia of the selected member, as shown in Equation 3-7.

$$\Delta = \frac{5wL^4}{384EI} \quad \text{Equation 3-5}$$

$$\frac{384EI\Delta}{5w} = L^4 \quad \text{Equation 3-6}$$

$$\frac{L}{\Delta} = \frac{384EI}{5wL^3}$$

Equation 3-7

The minimum allowable L/Δ value for a beam is simply the inverse of the deflection criteria. As an example, the minimum L/Δ value a valid member can have for a deflection ratio of $L/360$ is 360. A value less than 360 corresponds to a deflection that exceeds the $L/360$ serviceability limit.

Based on the required moment capacity, shear capacity, and moment of inertia determined from the analysis, beams are selected with properties meeting or exceeding the design minimums.

Girders

Girder center-to-center spacing depends on the span of the beams that frame into it, since beams frame into a girder on each of their ends. Beam spans vary from 20 feet to 52 feet in 4-foot increments, which corresponds to the range in girder on-center spacing. Girder spans range from 20 feet to 52 feet in 4-foot increments. These limits exist for the same reason as the limits for beams, which are explained above.

Girder members is designed to resist flexural and shear forces imposed on them by the building loads. For non-composite girders, the metal deck is assumed to provide no lateral bracing to the top flange of the girder because it spans parallel to the span of the girder and has very little stiffness; however, beams that frame perpendicularly into the girders do possess sufficient stiffness to act as lateral brace locations for the compression flange. This corresponds to the compression flange un-braced length L_b equaling the center-to-center beam spacing. Having an un-braced length greater than zero allows the

girder to experience several possible flexural limit states, namely flexural yielding, inelastic lateral-torsional buckling, and elastic torsional buckling.

Similar to the procedure for beam members, a wide flange member of least weight is selected based on the total member forces; the members must satisfy strength and deflection limits as specified. Unlike beams, the un-braced length for non-composite girders is not zero, which may cause lateral torsional buckling to be the governing limit state for the member. In such cases, the moment strength of the member is determined by AISC Equations F2-2 and F2-3, shown in Equations 3-8 and 3-9 below.

$$L_p < L_b \leq L_r: \quad M_n = C_b \left[M_p - (M_p - 0.7F_y S_x) \left(\frac{L_b - L_p}{L_r - L_p} \right) \right] \leq M_p \quad \text{Equation 3-8}$$

where:

C_b = lateral torsional buckling modification factor (taken to be 1.0)

S_x = elastic section modulus about strong axis (in³)

L_p = maximum unbraced length to achieve plastic moment strength (ft)

L_b = lateral brace length (ft)

L_r = minimum unbraced length for elastic lateral torsional buckling to occur (ft)

$$L_b > L_r: \quad M_n = F_{cr} S_x \leq M_p \quad \text{Equation 3-9}$$

F_{cr} can be calculated conservatively using AISC Equation F5-4, shown in Equation 3-10.

$$F_{cr} = \frac{C_b \pi^2 E}{\left(\frac{L_b}{r_{ts}}\right)^2} \quad \text{Equation 3-10}$$

$$r_{ts} = \frac{I_y h_0}{2S_x} \quad \text{Equation 3-11}$$

I_y = weak axis moment of inertia (in⁴)

h_0 = distance between flange centroids (in)

The un-braced length of the girder is considered to be the greatest length that divides the girder into equal spans yet remains less than the maximum allowable span of the metal deck. Once the unbraced length is determined, a section can be selected for the girder. The member must satisfy strength and deflection limits as specified above. These requirements are checked separately by designing the member for moment strength only, checking the shear strength, then checking and resizing the member for deflection. Girder deflection criteria is checked using the same method as for beams.

Although girders primarily experience point loads in the form of tributary beam reaction forces, shear and moment forces are approximated as those of a uniformly distributed load. This method provides an adequate approximation of the exact member forces in the girders, while greatly simplifying the load analysis. It is important to note that any discrepancy in the approximate method is due to the approximate method being conservative. A detailed analysis and justification of this method can be found in Appendix A.

Like beam members, girder members shall satisfy deflection limits for floor members as specified in the 2015 IBC. Composite girders are designed to have a maximum

pre-composite deflection not exceeding $L/360$ due to construction and pre-composite loads. Girder cambering is not considered as a method to reduce deflection.

Columns

Column members support beam and girder members by transmitting their end reactions as axial forces to the foundation. The tributary areas of columns span across multiple stories, where the tributary on each floor is equal to the area of one bay. This occurs for every story that the column supports, so the total tributary area of the column is the area of one bay multiplied by the number of supported stories. This can be expressed as shown in Equation 3-13.

$$A_T = NA_F \quad \text{Equation 3-12}$$

A_T = total column tributary area (ft²)

N = number of supported stories

A_F = area of a typical bay (ft²)

The number of stories that the building possesses remains constant at 5 stories in this analysis, but the bay area varies with the spans of the beams and girders. Both beams and girders range in span from 20 feet to 52 feet, which allows the bay area to range from 400 ft² up to 2,704 ft². Over the 5 supported levels, the tributary area of a single column ranges from 2,000 ft² to 13,520 ft². The uniformly distributed building loads that act on this tributary area produce the axial load that the column must carry.

Building floor-to-floor height remains constant at 15 feet throughout the analysis, which corresponds to the column un-braced length. For determining the effective length of the column, an effective length factor, K , is assumed to be equal to 1, despite the columns being continuous members with a K factor potentially different than 1. This assumption serves to simplify the analysis while also remaining conservative. (AISC, 2010)

ASCE 7-10 provisions for live load reduction are utilized for column design, since significant steel savings can be realized from the reduction in load. Initially, columns are sized with the load acting concentrically on the member. W8, W10, W12, and W14 column members are selected using AISC Equation E3-1, shown in Equation 3-13. The column self-weight is accounted for in the axial force.

$$P_n = F_{cr}A_g \quad \text{Equation 3-13}$$

where:

$$\frac{KL}{r} \leq 4.71 \sqrt{\frac{E}{F_y}} \quad F_{cr} = F_y \left[0.658 \frac{F_y}{F_e} \right] \quad \text{Equation 3-14a}$$

$$\frac{KL}{r} > 4.71 \sqrt{\frac{E}{F_y}} \quad F_{cr} = 0.877 F_e \quad \text{Equation 3-14b}$$

KL/r = column slenderness ratio about weak axis

F_e = Euler buckling stress (ksi)

To facilitate ease of construction and fabrication, girders, which typically have wider flanges, frame into the flanges of the column, while beams frame into the column web. This provides the most optimum use of space for connections, as well as eliminates the need to

cope beam or girder flanges to fit into the column connection. Figure 3-3 illustrates the framing configuration.

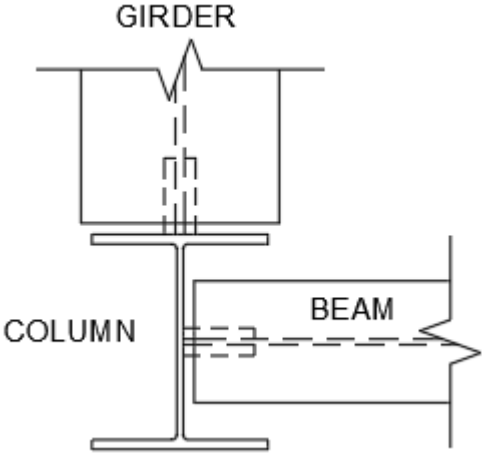

Figure 3-4: Beam- and Girder-to-Column Detail

Because the girders connect to the face of the column flange, the girder reaction force acts at a distance from the longitudinal axis of the column, which induces an eccentric moment. These eccentricities reduce the design axial capacity of the column. After being sized for pure axial load, the columns are re-checked to consider the eccentricities of the beam-to-column connections. The eccentricity of the connection produces a moment in the column according to Equation 3-15. The resulting moment is used in the interaction equation shown in Equation 3-17 to determine the adequacy of the member for concurrent axial and bending forces.

$$M_u = P_{ue}e \tag{Equation 3-15}$$

where:

M_u = factored moment induced by eccentricities (kip-feet)

P_{ue} = factored axial load acting non-concentrically (kips)

e = offset between force and member axis (feet)

Consequently, column members are designed with consideration given to both axial load and bending moment acting concurrently due to the eccentric connections. Column members satisfy AISC Specification Equation H1-1a, shown in Equation 3-16, since axial load is greater than 20% of the column's axial capacity.

$$\frac{P_r}{P_c} + \frac{8}{9} \left(\frac{M_{rx}}{M_{cx}} + \frac{M_{ry}}{M_{cy}} \right) \leq 1 \quad \text{Equation 3-16}$$

where:

P_r = required axial strength (kips)

P_c = available axial strength (kips)

M_{rx} = strong axis required flexural strength (kip-feet)

M_{cx} = strong axis available flexural strength (kip-feet)

M_{ry} = weak axis required flexural strength (kip-feet)

M_{cy} = weak axis available flexural strength (kip-feet)

Since beam members frame directly into the column webs, their eccentricity is approximated as 0, so the weak-axis bending term drops out of the equation as shown in Equation 3-17.

$$\frac{P_r}{P_c} + \frac{8}{9} \left(\frac{M_{rx}}{M_{cx}} \right) \leq 1$$

Equation 3-17

Column members experience the limit states of elastic buckling and inelastic buckling, depending on their slenderness ratios, KL/r . Column members are selected based on their design axial strengths using Equation 3-13. Column design flexural strengths are determined using Equation 3-3.

Chapter 4 - Analysis Procedure

With five beam spacing distances, nine beam spans, nine girder spans, three live load intensities, and two methods of construction, the analysis requires the design of 999 beam, girder, and column members and results in 486 unique framing solutions. The sheer number of repetitive calculations lends itself extremely well to the use of spreadsheet software, such as Microsoft Excel. The spreadsheet allows for the quick calculation of member forces, deflections and steel weights. All members are selected and input manually into the spreadsheet. While non-composite member design utilizes only the spreadsheet, composite members also utilize Enercalc, a software program to assist in the design the composite section.

Beams

Values for the slab self-weight dead load, imposed dead load, floor live load, and member tributary width are used to calculate the factored distributed load on the beam according to the governing load combination. Table 4-1 shows information on the service-level dead and live loads, as well as the factored distributed load acting on the beam.

Table 4-1: Load Information

| 4 FT SPACING | | |
|--------------|------|------|
| Slab | 40 | psf |
| DL | 15 | psf |
| LL | 50 | psf |
| wt | 4 | ft |
| Wu | 0.58 | k/ft |

Moment and shear forces are calculated using the distributed load value and the member span. Member self-weight is included in the design forces once a preliminary member is selected. Determining the self-weight forces is an iterative process, as the self-weight cannot be determined until a member has been selected; however, an appropriate member cannot be selected until the total forces, including the self-weight, are known. An initial member is selected solely based on flexural strength, and then the member is re-checked considering its self-weight loads. If the member is inadequate, a new member is selected based on the current self-weight forces. Table 4-2 indicates a sample of beam spans and members sized for strength only.

Table 4-2: Beam Loads and Members Sized for Strength Only

| | | Applied Forces | | Self Weight Forces | | Total Forces | | Strength Design | | | | | |
|----------------|----|-----------------------|--------------------|------------------------|---------------------|-----------------------|--------------------|-----------------|------------------------|---------------------|--------|----------------------|------|
| | | M _u (k-ft) | V _u (k) | M _{sw} (k-ft) | V _{sw} (k) | M _u (k-ft) | V _u (k) | Shape | ϕM _n (k-ft) | ϕV _n (k) | w (lb) | Steel Weight (lb/SF) | |
| Beam Span (ft) | 20 | 29.2 | 5.8 | 0.7 | 0.1 | 29.9 | 6.0 | W8x | 10 | 32.9 | 40.2 | 200 | 2.50 |
| | 24 | 42.0 | 7.0 | 1.4 | 0.2 | 43.4 | 7.2 | W10x | 12 | 46.9 | 56.3 | 288 | 3.00 |
| | 28 | 57.2 | 8.2 | 2.6 | 0.3 | 59.8 | 8.5 | W12x | 14 | 65.3 | 64.3 | 392 | 3.50 |
| | 32 | 74.8 | 9.3 | 4.0 | 0.4 | 78.7 | 9.8 | W10x | 19 | 81 | 76.5 | 608 | 4.75 |
| | 36 | 94.6 | 10.5 | 6.0 | 0.6 | 100.6 | 11.1 | W12x | 22 | 110 | 95.9 | 792 | 5.50 |
| | 40 | 116.8 | 11.7 | 8.4 | 0.7 | 125.2 | 12.4 | W12x | 26 | 140 | 84.2 | 1040 | 6.50 |
| | 44 | 141.3 | 12.8 | 11.6 | 0.9 | 152.9 | 13.7 | W16x | 26 | 166 | 106 | 1144 | 6.50 |
| | 48 | 168.2 | 14.0 | 15.2 | 1.1 | 183.4 | 15.1 | W16x | 31 | 203 | 131 | 1488 | 7.75 |
| | 52 | 197.4 | 15.2 | 19.5 | 1.2 | 216.9 | 16.4 | W18x | 35 | 249 | 159 | 1820 | 8.75 |

For composite members, the same load parameters, member span, and tributary width are used to calculate the required strength. Analysis software, Enercalc, calculates the strength and deflection of the partially composite section. The moment strength of the section is calculated based on a plastic stress distribution. The deflection of the member is calculated using the lower bound moment of inertia of the partially composite section. The lower bound moment of inertia for a partially composite section is calculated according to AISC Equation C-I3-1, shown in Equation 4-1.

$$I_{LB} = I_s + A_s(Y_{ENA} - d_3)^2 + \left(\frac{\Sigma Q_n}{F_y}\right)(2d_3 + d_1 - Y_{ENA})^2$$

where:

I_{LB} = lower bound moment of inertia (in⁴)

I_s = moment of inertia of steel section (in⁴)

A_s = area of steel section (in²)

Y_{ENA} = elastic neutral axis distance measured from bottom of steel (in)

d_1 = distance from compression force in concrete to top of steel section (in)

d_3 = distance from resultant tension force to top of steel section (in)

ΣQ_n = sum of nominal strengths of steel anchors on half the member length
(kips)

F_y = yield strength of steel (ksi)

The geometry of the metal deck, concrete properties, and the effective concrete flange width are input to calculate these properties. A wide flange member of least-weight is then selected to satisfy the strength and deflection requirements. Table 4-3 indicates a sample of beams sized when considering deflection criteria.

Table 4-3: Members Sized for Deflection

| Deflection | | | | | | | | | Governs: |
|------------|-------------------|----------------|--------|--------------------------|--------------|------------------|----------------------|-------|------------|
| Shape | ϕM_n (k-ft) | ϕV_n (k) | w (lb) | I_x (in ⁴) | L/Δ_L | L/Δ_{D+L} | Steel Weight (lb/SF) | | |
| W10x | 12 | 46.9 | 56.3 | 240 | 53.8 | 520 | 248 | 3.00 | Deflection |
| W12x | 16 | 75.4 | 79.2 | 384 | 103 | 576 | 274 | 4.00 | Deflection |
| W12x | 22 | 110 | 95.9 | 616 | 156 | 550 | 262 | 5.50 | Deflection |
| W14x | 26 | 151 | 106 | 832 | 245 | 578 | 275 | 6.50 | Deflection |
| W16x | 31 | 203 | 131 | 1116 | 375 | 622 | 296 | 7.75 | Deflection |
| W18x | 35 | 249 | 159 | 1400 | 510 | 616 | 293 | 8.75 | Deflection |
| W18x | 40 | 294 | 169 | 1760 | 612 | 556 | 265 | 10.00 | Deflection |
| W21x | 44 | 358 | 217 | 2112 | 843 | 589 | 281 | 11.00 | Deflection |
| W21x | 48 | 398 | 216 | 2496 | 959 | 527 | 251 | 12.00 | Deflection |

After the selected member is checked for moment strength, shear strength, and deflection, the self-weight of the beam is converted to steel weight per square foot, which is achieved by dividing the section weight (pounds per foot) by the tributary width of the member. This is done for both members designed only for strength and for members designed with deflection as a consideration. Lastly, the steel weights between the strength-only member and deflection member are compared. If the strength and deflection weights are equal, then it indicates that strength governs. If the deflection weight is larger, it indicates that deflection governs the design of the member, as shown in the last column of Table 4-3.

Girders

The girder self-weight dead load, imposed dead load, live load, and member tributary width are used in the same way as for beams. Likewise, member forces are calculated in a similar manner; however, the self-weight of the beams must be accounted for in the member forces. To account for this, the beam steel weight per square foot is applied to the girder as a uniformly distributed dead load. Although the beams framing into

a girder act as point loads, their self-weight and the loads that they carry can accurately be treated as uniformly distributed loads for the purpose of approximating design loads on the girder.

Girder steel weight per square foot is calculated in the same way as beam steel weight per square foot. Dividing the section weight of the girder by the tributary width yields the girder weight per square foot. In this case, the tributary width coincides with the span of the beams that the girder supports. The girder steel weight is reported, as well as the combined weight of beams and girders together.

Deciding which beam weight to add to the girder weight requires some additional consideration. As defined previously, the un-braced length for non-composite girders is defined by the beam on-center spacing, which varies by increments of two feet. For girder design, the maximum allowable beam spacing is selected that will fit on the girder span. Girder spans range from 20 feet to 52 feet by increments of four feet. Therefore, combinations of beam spacings and girder spans do not match. For instance, a 32-foot girder with beams at 12 feet on-center does not line up. The beams cannot be evenly spaced while maintaining constant 12-foot or 10-foot on-center spacing; only four-foot or eight-foot spacing works in this case.

A solution to this is interpolating between beam spacing increments. Take the same 32-foot girder as an example; a beam spacing of 12 feet does not work because it divides the girder into 2.67 spans, which is not a whole number. To achieve an even number of spans, the beam spacing must be either increased or decreased. Due to the limits of the metal deck, the beam spacing cannot exceed 12 feet, so the spacing must be decreased. Dividing the 32-foot girder into three even spans yields a required beam spacing of 10.67

feet, which is between the 10-foot and 12-foot standard beam spacing modes. The average between the 10-foot and 12-foot beam steel weights will yield approximately the result of 10.67-foot beam spacing. Therefore, the beam weight to add to the 32-foot girder's weight is the average weight of the 10-foot and 12-foot on-center beams. This same approach is applied to other instances where the girder span and the beam spacing are not compatible. Table 4-4 summarizes these instances.

Table 4-4: Beam Spacing Interpolation Method

| Girder Span (ft) | # of Equal Divisions | Beam Spacing (ft) | | | % Difference |
|------------------|----------------------|-------------------|--------------------|--------|--------------|
| | | Exact | Span Interpolation | Result | |
| 20 | 2 | 10.00 | 10 | 10 | 0.00% |
| 24 | 2 | 12.00 | 12 | 12 | 0.00% |
| 28 | 3 | 9.33 | 10 | 10 | -7.14% |
| 32 | 3 | 10.67 | Average of 10 & 12 | 11 | -3.13% |
| 36 | 3 | 12.00 | 12 | 12 | 0.00% |
| 40 | 4 | 10.00 | 10 | 10 | 0.00% |
| 44 | 4 | 11.00 | Average of 10 & 12 | 11 | 0.00% |
| 48 | 4 | 12.00 | 12 | 12 | 0.00% |
| 52 | 5 | 10.40 | 10 | 10 | -5.77% |

In spite of the extreme simplicity of this interpolation method, it produces relatively small percent error. Of the nine possible girder spans, only four require the use of the interpolation method: 28 feet, 32 feet, 44 feet, and 52 feet. One of those four spans, the 44-foot span, produces an exact solution from the approximation. For the other three spans, it produces single-digit percent errors between exact and approximate girder un-braced lengths. Furthermore, the interpolation method only requires the use of the weights of two beam spacing increments: 10-foot and 12-foot on-center.

Columns

The required strength of the column P_u is the sum of all the dead loads and reduced live loads acting on the column from the governing load combination. The floor live loads and roof live loads are then reduced in accordance with ASCE 7-10 provisions for live load reduction. Table 4-5 shows loads and member sizes for columns design for pure axial load.

Table 4-5: Column Axial Loads and Members Sized for Pure Axial Load

| | | Pure Axial Loading | | | | | | | | | | | |
|-------------------|----|--------------------|--------------|------------------|------------------|-----------|--------------|-----------|-------|-----|--------|----------------|----------------------|
| Girder Span (ft.) | | P_c (k) | P_{cr} (k) | $P_{cr,red}$ (k) | $P_{cr,red}$ (k) | P_o (k) | P_{uw} (k) | P_u (k) | Shape | | w (lb) | ϕP_n (k) | Steel Weight (lb/SF) |
| | 20 | | 128.0 | 16.0 | 56.0 | 12.8 | 120.0 | 9.7 | 188.8 | W8x | 31 | 465 | 230 |
| 24 | | 153.6 | 19.2 | 64.7 | 13.8 | 144.0 | 12.6 | 222.5 | W8x | 35 | 525 | 261 | 1.09 |
| 28 | | 179.2 | 22.4 | 73.2 | 14.3 | 168.0 | 15.2 | 255.5 | W10x | 39 | 585 | 283 | 1.04 |
| 32 | | 204.8 | 25.6 | 81.9 | 15.4 | 192.0 | 18.4 | 289.3 | W10x | 45 | 675 | 333 | 1.05 |
| 36 | | 230.4 | 28.8 | 92.2 | 17.3 | 216.0 | 21.5 | 325.4 | W8x | 48 | 720 | 367 | 1.00 |
| 40 | | 256.0 | 32.0 | 102.4 | 19.2 | 240.0 | 26.6 | 361.6 | W10x | 49 | 735 | 449 | 0.92 |
| 44 | | 281.6 | 35.2 | 112.6 | 21.1 | 264.0 | 29.0 | 397.8 | W10x | 49 | 735 | 449 | 0.84 |
| 48 | | 307.2 | 38.4 | 122.9 | 23.0 | 288.0 | 33.0 | 433.9 | W12x | 53 | 795 | 478 | 0.83 |
| 52 | | 332.8 | 41.6 | 133.1 | 25.0 | 312.0 | 44.1 | 470.1 | W12x | 58 | 870 | 525 | 0.84 |

Because the girders connect to the face of the column flange, the girder reaction force acts at a distance from the longitudinal axis of the column, which induces an eccentric moment. Figure 4-1 depicts the connection between the girder and the column that produces this eccentric moment.

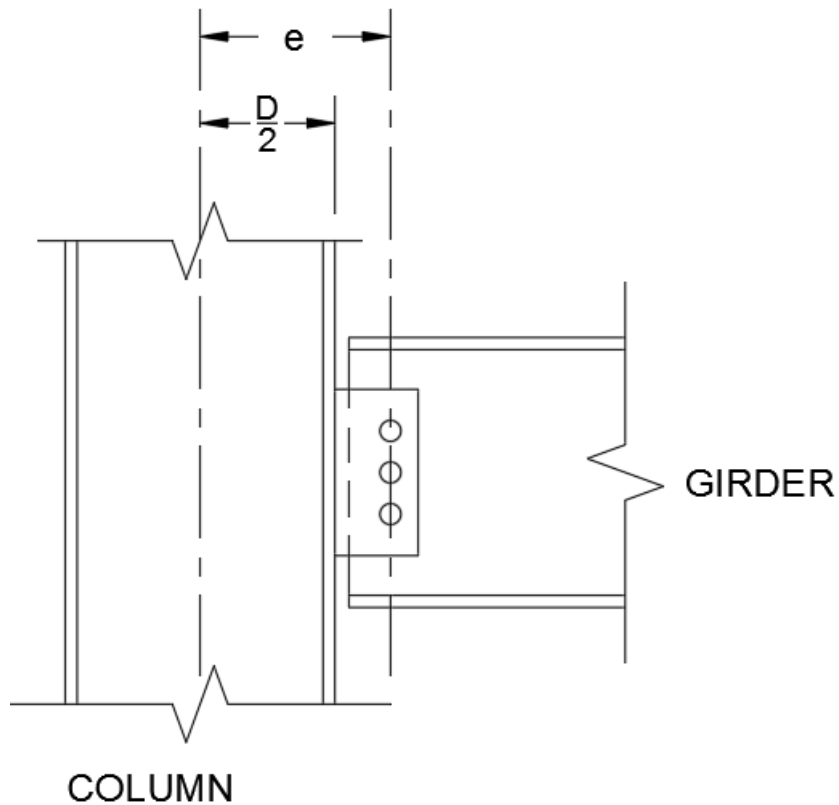

Figure 4-1: Typical Girder-to-Column Connection

This eccentricity is half the depth of the section, plus 3 inches to estimate the distance between the face of the column and the bolts connecting the beam. To simplify the calculation of the eccentricity, the nominal section depth shall be used instead of the actual depth. For instance, the nominal section depth of a W14x176 column is 14 inches although the actual depth is 15.2 inches. This allows the section depth to only vary by member series, rather than being unique to each individual member that is selected. Furthermore, the eccentricity for the same W14x176 is:

$$e = \frac{14 \text{ in}}{2} + 3 \text{ in} = 10 \text{ in}$$

Although this eccentricity may be un-conservative for heavier sections, it is balanced by the fact that larger column sections tend to support larger floor areas, which are less likely to be unevenly loaded. The unbalanced force P_e producing the moment results from unbalanced distribution of live loads. As a worst-case scenario, the live load is distributed so the full design live load acting on one half of a bay, but no live load acting on the other half. The corresponding P_{ue} equals half of the unreduced floor live load supported by the column on one story. Large bays are less likely to have this binary live load distribution due to the probability that a large area will be completely empty and another area will be fully loaded.

After calculating the eccentric moment acting on the column, the column is designed by calculating the nominal design axial and flexural strengths, then checking them against the required strengths using the interaction equation as shown in Table 4-6.

Table 4-6: Design of Columns for Eccentric Loads

| Eccentric Loading | | | | | | | | |
|-------------------|----------|--------------|-------|----|----------|----------------|-------------------|----------|
| P_e (k) | e (in) | M_e (k-ft) | Shape | | w (lb) | ϕP_n (k) | ϕM_n (k-ft) | ≤ 1 |
| 16.0 | 7 | 9.3 | W8x | 31 | 465 | 230 | 114 | 0.894 |
| 19.2 | 8 | 12.8 | W10x | 39 | 585 | 283 | 176 | 0.851 |
| 22.4 | 8 | 14.9 | W10x | 39 | 585 | 283 | 176 | 0.978 |
| 25.6 | 8 | 17.1 | W10x | 45 | 675 | 333 | 206 | 0.942 |
| 28.8 | 7 | 16.8 | W8x | 48 | 720 | 367 | 184 | 0.968 |
| 32.0 | 8 | 21.3 | W10x | 49 | 735 | 449 | 227 | 0.889 |
| 35.2 | 8 | 23.5 | W10x | 49 | 735 | 449 | 227 | 0.978 |
| 38.4 | 9 | 28.8 | W12x | 53 | 795 | 478 | 292 | 0.995 |
| 41.6 | 9 | 31.2 | W12x | 58 | 870 | 525 | 324 | 0.981 |

Once a member has been selected to resist the combined axial and bending forces due to eccentric connections, the column steel weight per square foot is calculated. This value, the beam weight, and the girder weight are all combined to produce a total steel weight per square foot, as shown in Table 4-7.

Table 4-7: Steel Weight Results

| Steel Weights | | | |
|---------------|--------|------|-------|
| Column | Girder | Beam | Total |
| 1.16 | 1.70 | 2.20 | 5.06 |
| 1.22 | 2.40 | 1.83 | 5.45 |
| 1.04 | 2.40 | 2.20 | 5.64 |
| 1.05 | 2.75 | 2.20 | 6.00 |
| 1.00 | 3.40 | 1.83 | 6.23 |
| 0.92 | 3.80 | 2.20 | 6.92 |
| 0.84 | 4.20 | 1.83 | 6.87 |
| 0.83 | 4.50 | 1.83 | 7.16 |
| 0.84 | 5.80 | 2.20 | 8.84 |

Chapter 5 - Analysis Results

Steel weights per square foot for the individual components (i.e. beams, girder, and columns) are presented in the form of, two-axis graphs, and three-axis graphs. The two-axis graphs present the data as a series of lines, with multiple graphs presenting the steel weight versus different parameters. For instance, beam steel weight is shown in a graph versus beam on-center spacing and a graph versus beam span. Three-axis graphs allow for these two graphs to be combined into one graph. These present the values as a surface, rather than a series of lines. These surfaces are marked with a series of colored bands merely to assist the reader with visualizing the data, and do not hold any physical significance. This method allows for the study of two parameters in a single graph. The previously mentioned two-axis graphs of steel weight versus beam spacing and steel weight versus beam span can be combined into a single three-axis graph with beam spacing on one horizontal axis, beam span on the other horizontal axis, and steel weight per square foot on the vertical axis.

In addition to individual component results, results are reported for combined steel weight of beams and girders as well as total steel weight, the sum of the beam, girder, and column steel weights. These results utilized the same presentation methods: two-axis graphs, and three-axis graphs. For brevity, only select graphs are included in the main body of this thesis. All graphs can be found in the Appendix D.

Beams

Figure 5-1 displays results for beam weight per square foot versus the on-center spacing of the beams for non-composite beams. These results are for 50 lb/ft² live loading, but are representative of the results of non-composite beams of all live load conditions in general. A detailed discussion of the effects of live load intensity is included later in this thesis. As can be seen from Figure 5-1, the steel weight of beams has a clear tendency to decrease as the on-center spacing increases. This tendency becomes more pronounced as the beam span increases.

Figure 5-1: Beam Weight vs. Beam Spacing

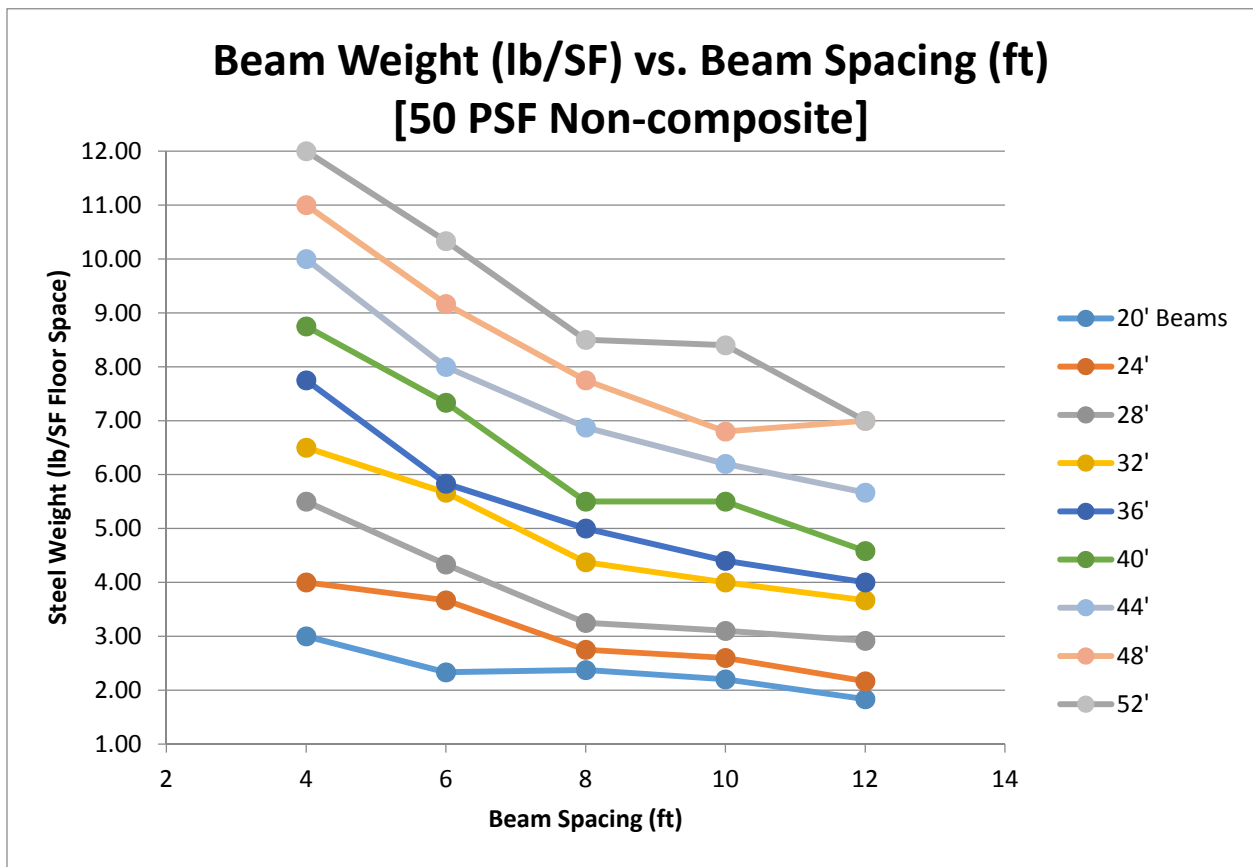

For 20-foot beams, the steel weight only varies from 3.00 lb/ft² at 4 feet on-center to 1.83 lb/ft² at 12 feet on-center, a decrease of 1.17 lb/ft². By contrast, steel weight for 52

feet beams varies from 12.00 lb/ft² at 4 feet on-center to 7.00 lb/ft² at 12 feet on-center. Interestingly, the percent reduction in steel weight per square foot from 4 feet to 12 feet on-center is roughly 40% for all beam spans.

Figure 5-2 shows beam weight per square foot versus beam span for non-composite beams. Like the preceding graph, this shows results for 50 lb/ft² live loading, but is representative of the results for non-composite beams in general. The graph depicts a relationship directly proportional between beam span and beam weight per square foot. Steel weight as a function of span increases the most rapidly for small on-center spacing distances, while the weight increases less dramatically for more widely spaced beams.

Figure 5-2: Beam Weight vs. Beam Span

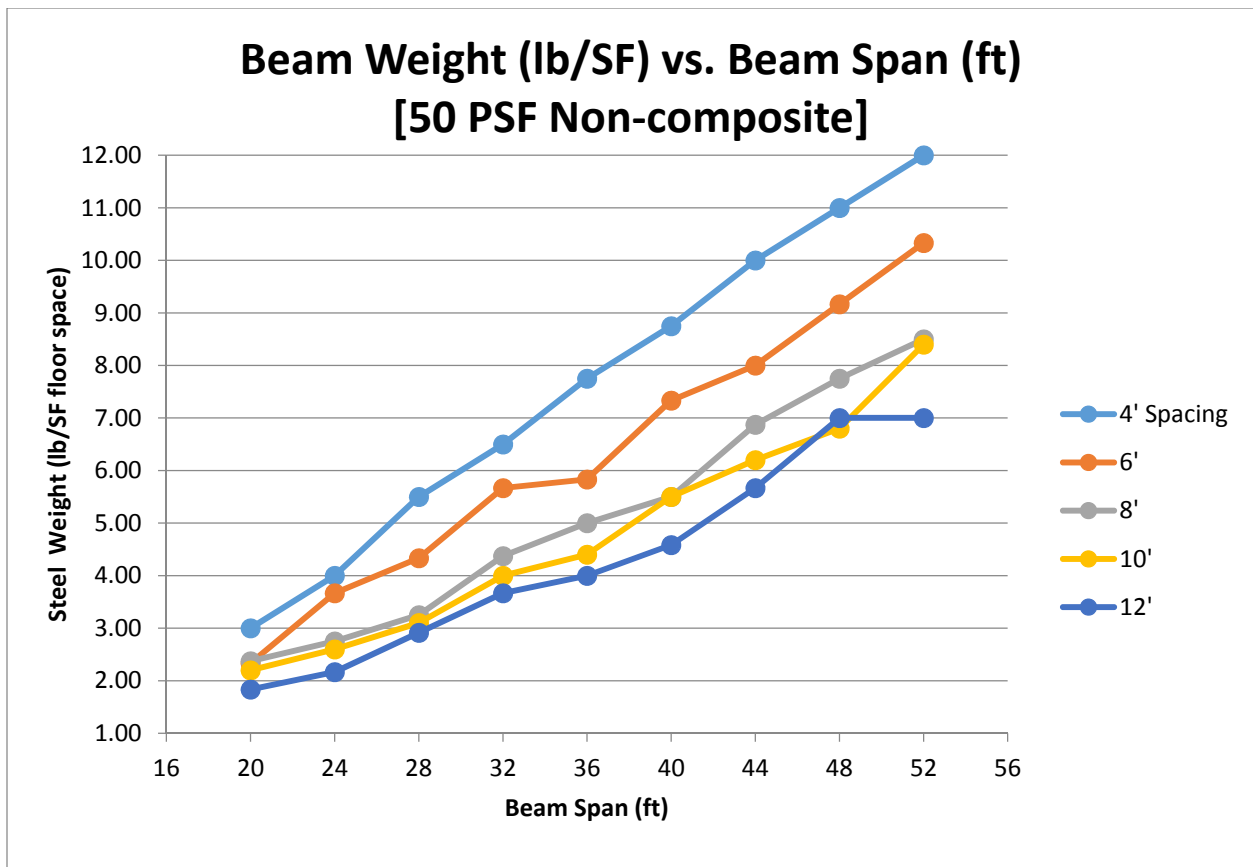

For beams spaced at 4 feet on center, steel weight for 20 feet beams is 3.00 lb/ft² and increases to 12.00 lb/ft² at 52 feet. Beams spaced at 12 feet on center weigh 1.83 lb/ft² for 20 feet beams and increase to only 7.00 lb/ft² for 52 feet beams. For all beam spacing distances, the steel weight increases by about a factor of four when the span increases from 20 feet to 52 feet. For all beams spacing increments, beam steel weight increases by roughly 250-300% from 20 feet to 52 feet spans.

Combining the two preceding two-axis graphs produces the surface presented below in Figure 5-3, which shows beam steel weight plotted versus beam spacing and beam span. The surface shows how beam spacing and span affect the steel weight of the beam members. The absolute minimum steel weight results from situations of maximum beam spacing and minimum beam span. This corresponds to a 12 feet on-center spacing and 20 feet span, which results in 1.83 lb/ft² of steel. Conversely, the maximum steel weight occurs at a configuration of minimized beam spacing and maximized beam span. This corresponds to beam spacing of 4 feet and beam span of 52 feet, which results in 12.00 lb/ft² of steel. The absolute maximum beam weight is approximately 550% greater than the absolute minimum weight.

Figure 5-3: Beam Weight vs. Beam Proportions

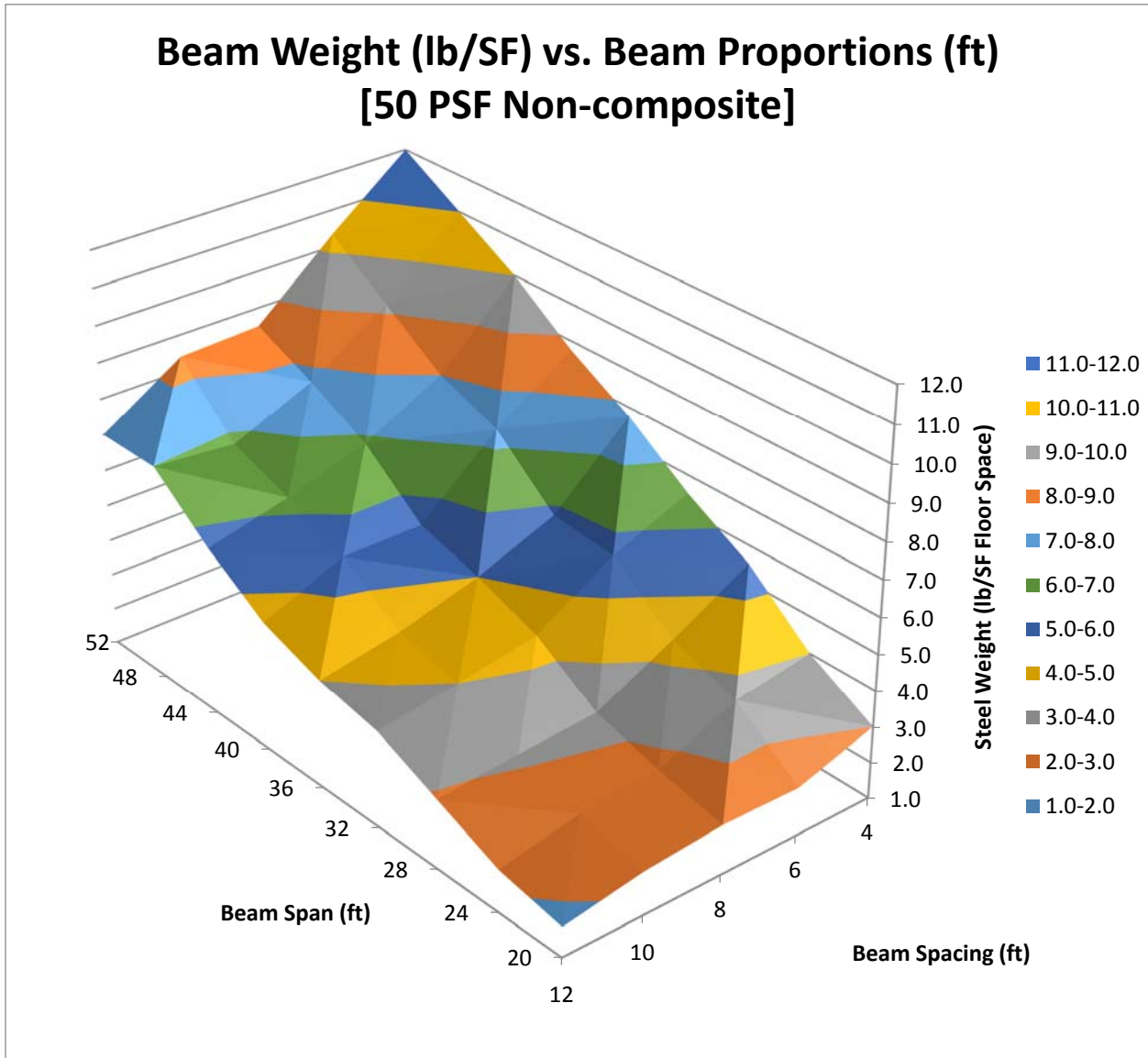

Girders

Figure 5-4 below shows the results of non-composite girder steel weight per square foot versus girder span for 50 lb/ft² floor loads. The trends in this graph are similar for other live load intensities. Similar to the results for beam weights versus beam span, girder weight increases in direct proportion to the girder span, regardless of the span of the beams that the girders support. Girders supporting the shortest tributary beams yield the greatest girder weights per square foot, while girders that support the longest tributary beams possess the least steel weight per square foot. At 20 feet spans, girders supporting 20 feet beams weigh 1.70 lb/ft² and increase to 5.80 lb/ft² when those girders span 52 feet. Girders with 48 feet beams and 52 feet beams were the lightest per square foot and the steel weights occasionally cross each other on the graph. Girders with 48 feet beams happen to be lighter than girders with 52 feet beams when the girder spans are 20 feet and 52 feet. For 20 feet girders, the lowest girder weight was 1.19 lb/ft², and for 52 feet girders it was 3.83 lb/ft². These weights differ from those for girders with 52 feet beams by merely hundredths of a pound per square foot. For all tributary beam lengths, the girder weight per square foot increases roughly 200-250% between 20 feet and 52 feet girder spans.

Figure 5-4: Girder Weight vs. Girder Span

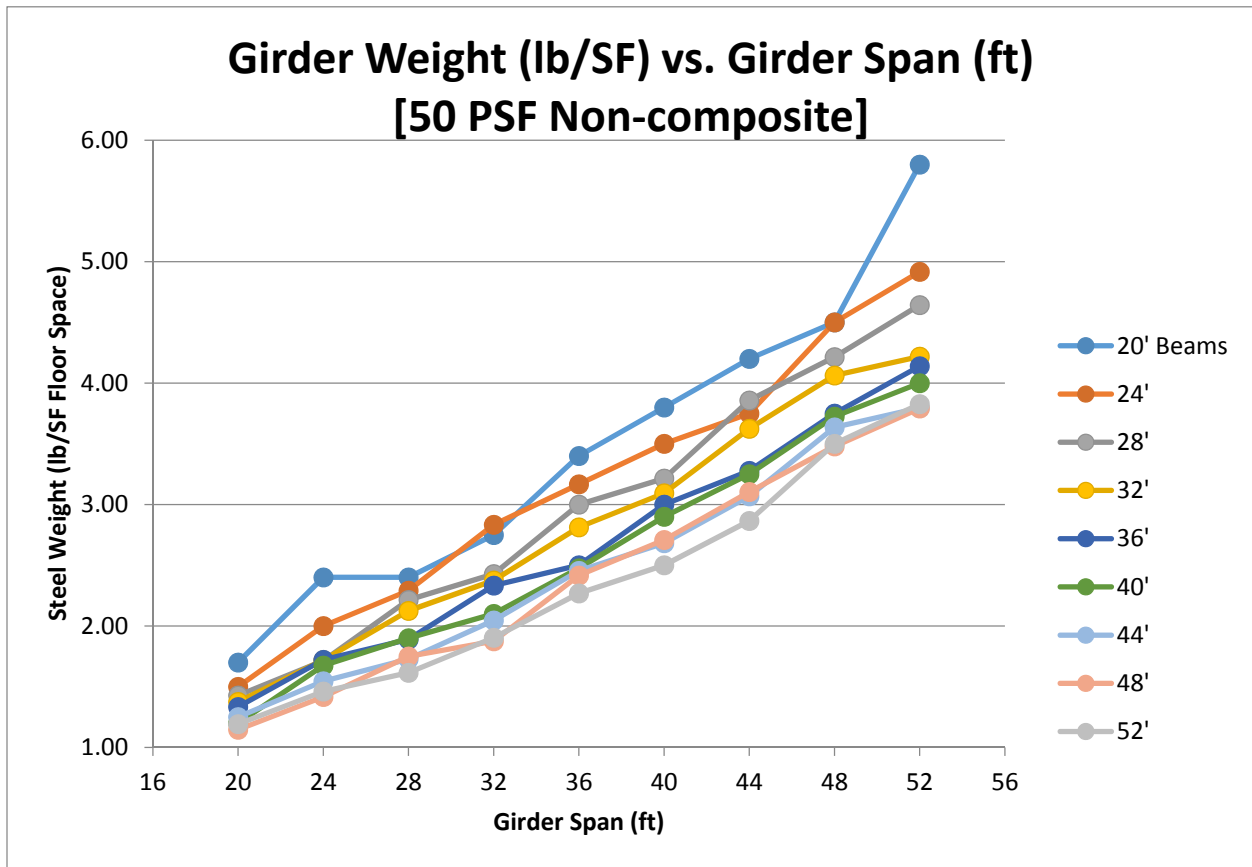

Results for non-composite girder weight per square foot versus tributary beam span are shown in Figure 5-5. Like other graphs, this shows results for 50 lb/ft² live loading, but is representative of the results for other live load intensities. As seen from the graph, a clear tendency exists for the girder steel weight to decrease as the tributary beam span increases. This tendency becomes progressively more pronounced as the girder span increases. For 20 feet girders, girder weight per square foot decreases gradually from 1.70 lb/ft² with 20 feet beams to 1.19 lb/ft² for 52 feet beams; by contrast for 52 feet girders, girder weight per square foot decreases from 5.80 lb/ft² with 20 feet beams to 3.83 lb/ft² for 52 feet beams. Across all girder spans, girder steel weight consistently decreases approximately 30% when beam span increases from 20 feet to 52 feet.

Figure 5-5: Girder Weight vs. Beam Span

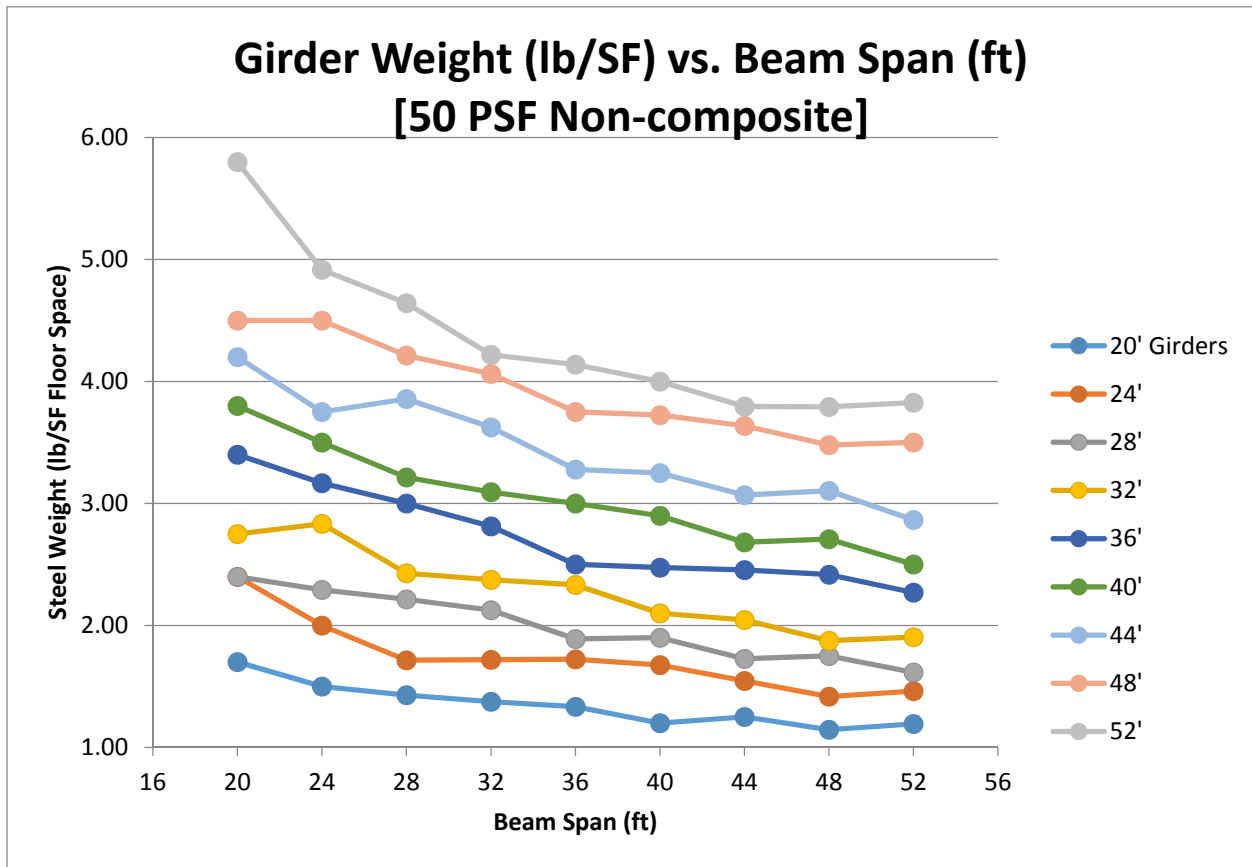

The surface in Figure 5-6 combines the two previous graphs to produce a graph of girder weight per square foot versus beam span and girder span. The surface illustrates the relationships of beam span and girder span to the girder steel weight. The absolute minimum steel weight tends toward configurations of maximum beam span and minimum girder span. This corresponds to a 52 feet tributary beam span and 20 feet girder span, which results in 1.19 lb/ft² of steel. Due to slight scatter in the data points, 48 feet tributary beams and 20 feet girders produces steel weight of 1.15 lb/ft², which is only slightly less. Conversely, the absolute maximum steel weight occurs at a configuration of minimized beam span and maximized girder span. This corresponds to beam span of 20 feet and girder span of 52 feet, which results in 5.80 lb/ft² of steel. The absolute maximum girder weight is approximately 400% greater than the absolute minimum weight.

Figure 5-6: Girder Weight vs. Bay Size

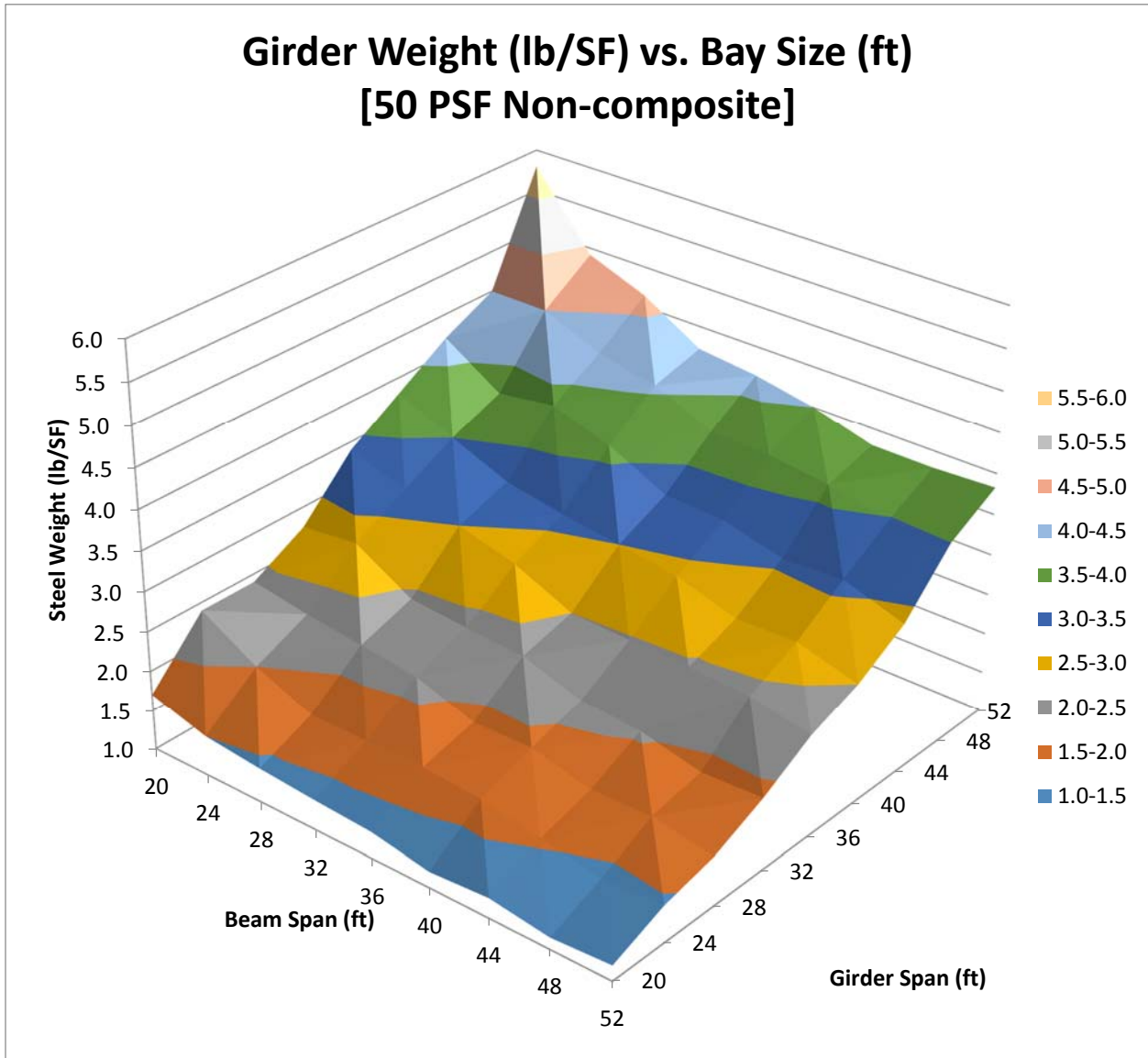

Columns

Figure 5-7 displays column weight per square foot versus girder span. Like the preceding graph, this shows results for 50 lb/ft² live loading; however, the tendencies of the results are representative of all live load intensities in general. Since column design only depends on the supported axial load, the direction that the beam and girder members span is not significant, allowing them to be neglected; therefore, column weight is only plotted versus girder span. The results for column weight versus girder span are essentially identical to those versus beam span. Likewise, the type of construction has little effect on the column weight. Although the self-weight of composite construction may be reduced compared to non-composite construction, the resulting decrease in column load is insignificant next to the magnitude of the imposed live and dead loads acting on the column. Accordingly, the effects of composite design can be neglected.

Figure 5-7: Column Weight vs. Girder Span

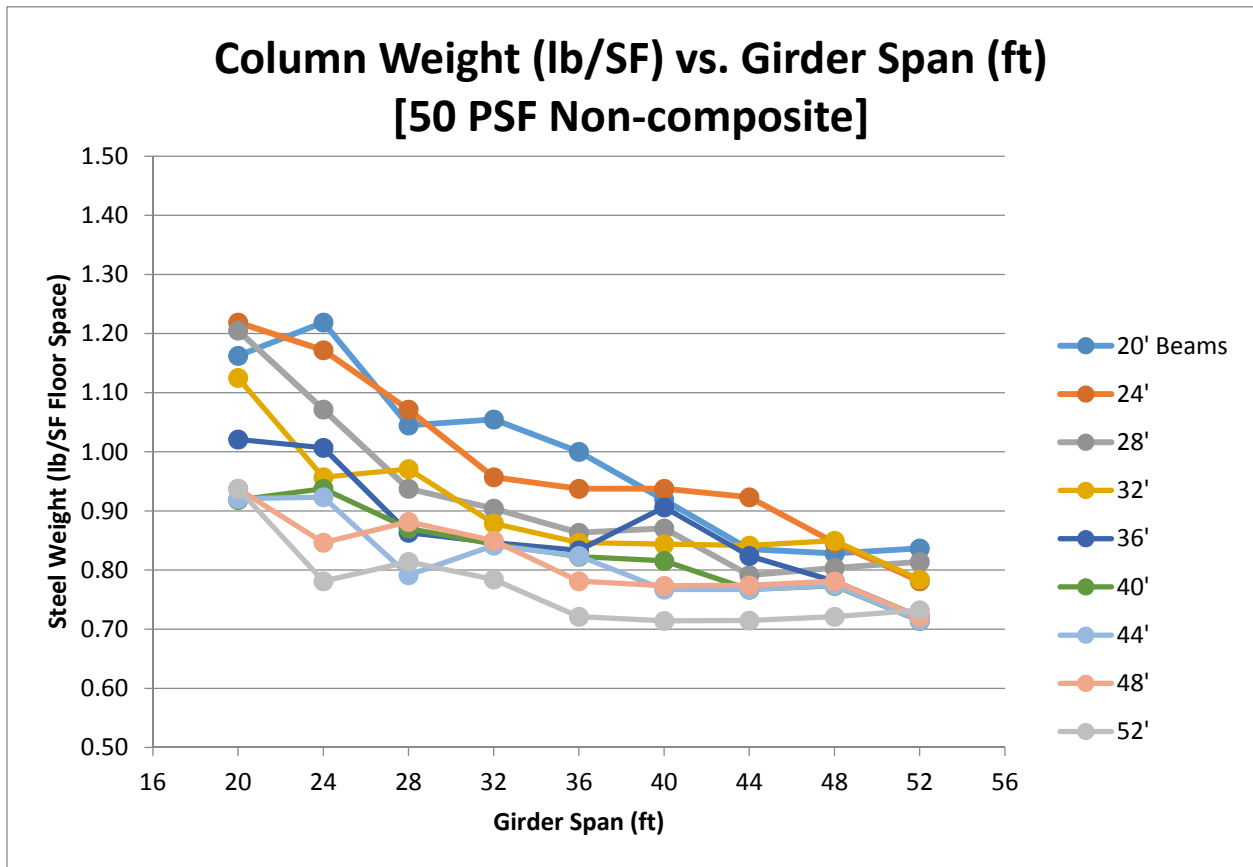

Column weight varies inversely in proportion to the girder span, yet seemingly approaches a non-zero asymptote. A significant property of this graph is how little the column steel weights compared to the beam and girder weights. The heaviest result achieved on this graph is 1.22 lb/ft²; compared to the maximum beam weight of 12.00 lb/ft² and a maximum girder weight of 5.80 lb/ft², the column weight contributes considerably less to the total steel weight, especially for large bay dimensions.

The absolute maximum column weight of 1.22 lb/ft² occurs when bay dimensions are 20 feet by 24 feet. The absolute minimum weight of 0.71 lb/ft² occurs at bay dimensions of 48 feet by 52 feet, although many points are close to the same value. The absolute maximum column weight is approximately 70% greater than the absolute

minimum weight, a considerably smaller change in weight compared to that of beams and columns.

Total

Superimposing the steel weights from the individual structural components produces the total steel weight for the structure. Figure 5-8 shows total steel weight versus beam span by combining the data from beam, girder and column weights versus beam span for 50 lb/ft² floor live loads.

Figure 5-8: Total Steel Weight vs. Beam Span

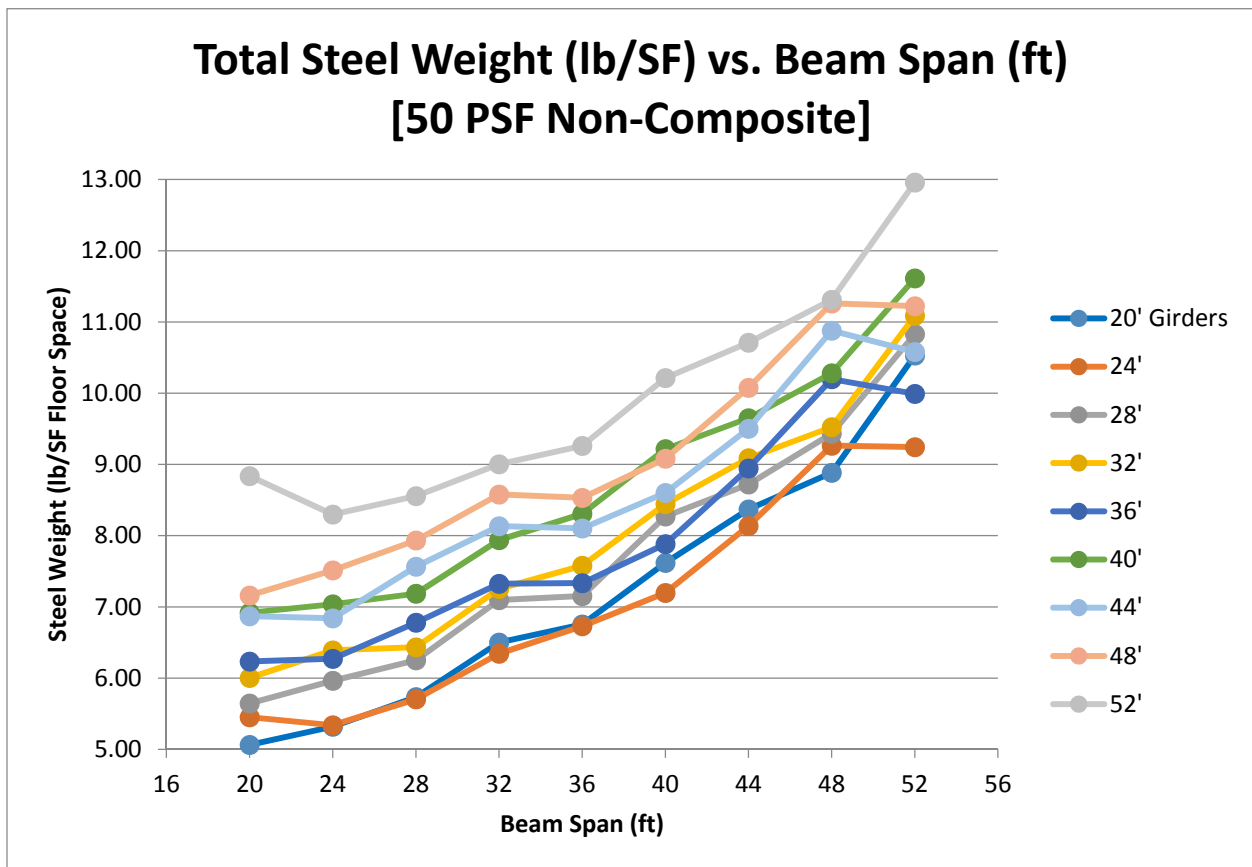

Total steel weight generally increases as beam span increases; however, several noteworthy exceptions to that trend exist. First, the lines for 24 feet, 44 feet, and 52 feet girders decrease in weight when the beam span increases from 20 feet to 24 feet. Second,

the majority steel weights do not increase significantly between 32 feet beams and 36 feet beams.

Bays supporting the longest beams yield the greatest steel weights per square foot, while bays that support the shortest beams possess the least steel weight per square foot. Similarly, bays supporting the longest girders yield the greatest steel weights per square foot, while bays that support the shortest girders possess the least steel weight per square foot.

For 20 feet girders, bays supporting 20 feet beams weigh 5.06 lb/ft² and increase to 10.53 lb/ft² when beams span 52 feet. For bays with 52 feet girders, total structural steel weighs 8.84 lb/ft² for 20 feet beams but increases to 12.96 lb/ft² for 52 feet beams. Unlike the results for component weights, percent changes in steel weight are not uniform. Bays with 20 feet girders undergo a weight increase of roughly 110% between 20 feet and 52 feet beams, while 52 feet girders only increase by 50%.

Total steel weight generally increases as girder span increases; however, the lines have a tendency to “zig-zag” to a greater extent than for other data. This is a by-product of the beam spacing interpolation method described in the Analysis Procedure section, and is discussed in more detail in the Conclusion. Figure 5-9 displays total steel weight versus girder span.

Figure 5-9: Total Steel Weight vs. Girder Span

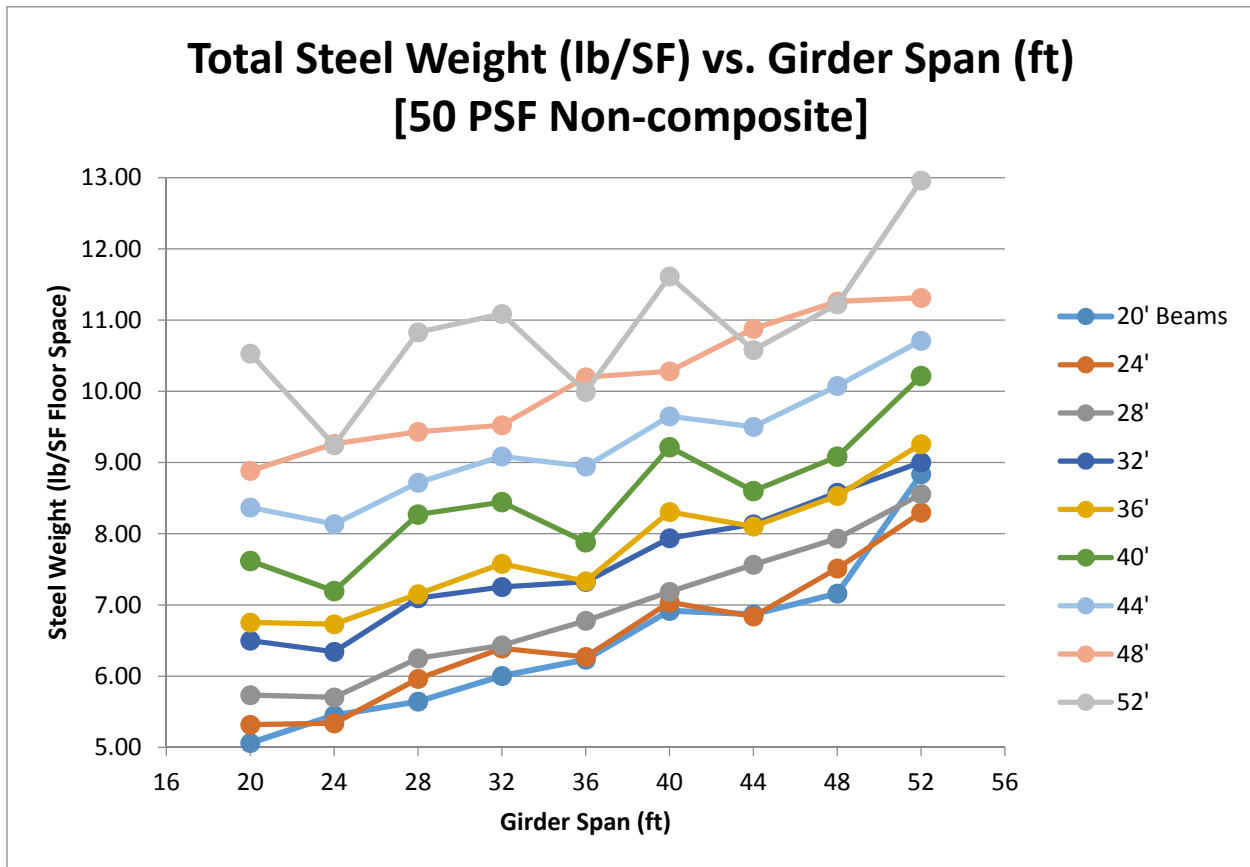

For 20 foot beams, bays supporting 20 feet girders weigh 5.06 lb/ft² and increase to 8.84 lb/ft² when girders span 52 feet. For bays with 52 foot beams, total structural steel weighs 10.53 lb/ft² for 20 foot beams but increases to 12.96 lb/ft² for 52 foot beams. Bays with 20 foot beams undergo a weight increase of roughly 75% between 20 feet and 52 feet girders, while 52 feet girders only increase by 25%. These percent changes in steel weight as a function of girder span are significantly less than those as a function of beam span.

Combining the two previous graphs produces the surface plotted in Figure 5-10 below which depicts total steel weight versus bay dimensions. The absolute minimum steel weight tends toward configurations of minimum beam span and minimum girder span. This corresponds to 20 foot beam spans and 20 feet girder spans, which results in 5.09

lb/ft² of steel. The absolute maximum steel weight occurs at maximum beam and girder spans. This corresponds to beam span of 52 feet and girder span of 52 feet, which weighs 12.96 lb/ft². The absolute maximum girder weight is approximately 150% greater than the absolute minimum weight.

Figure 5-10: Total Steel Weight vs. Bay Size

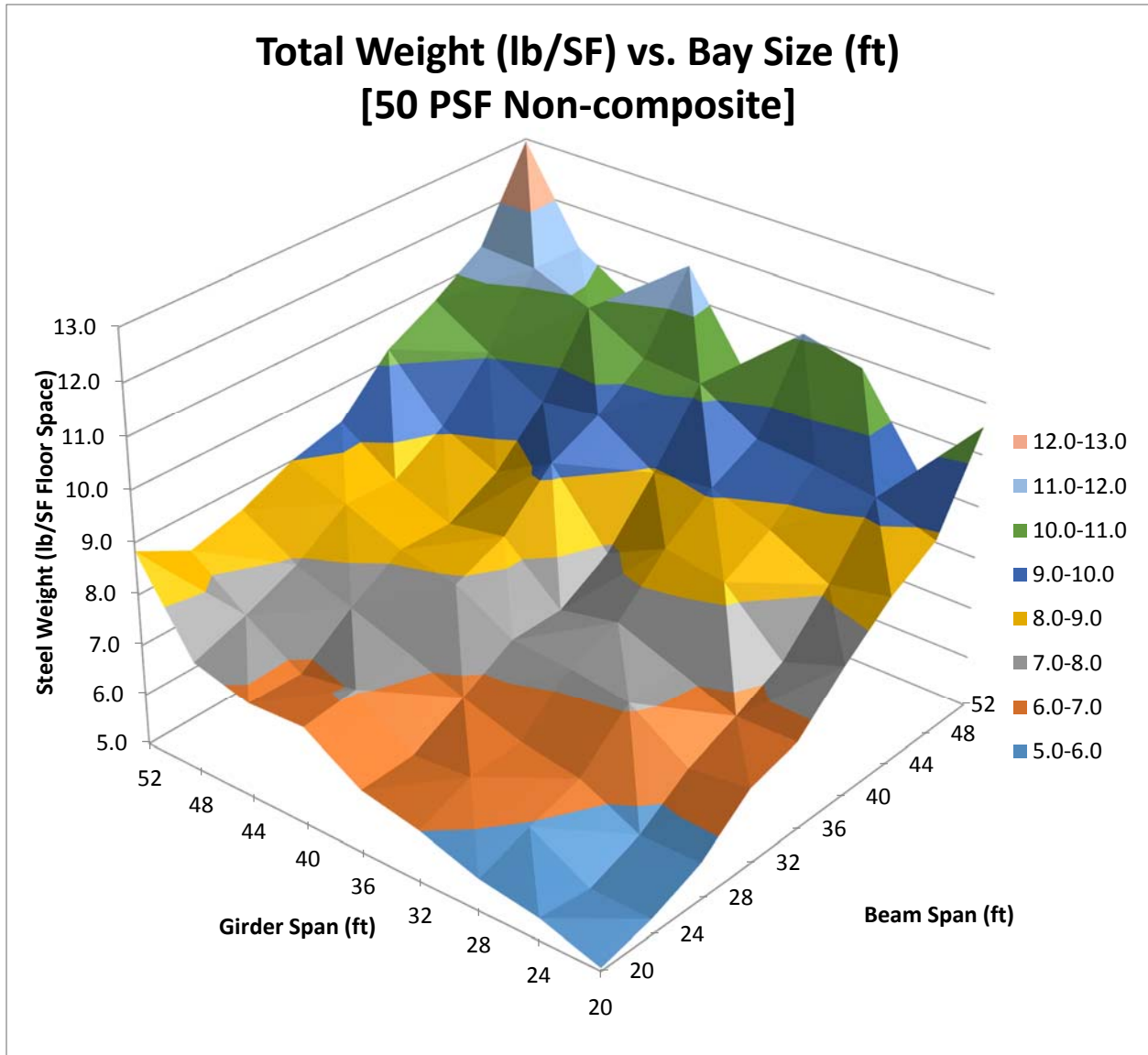

Live Load

In Figures 5-11 and 5-12 below, graphs for total steel weight versus bay dimensions show results for both 75 lb/ft² and 100 lb/ft² live load intensities. The contours of each of the surfaces are similar between live load intensities; however, the steel weight tends to increase as the live load intensity increases.

Figure 5-11: Total Steel Weight vs. Bay Size

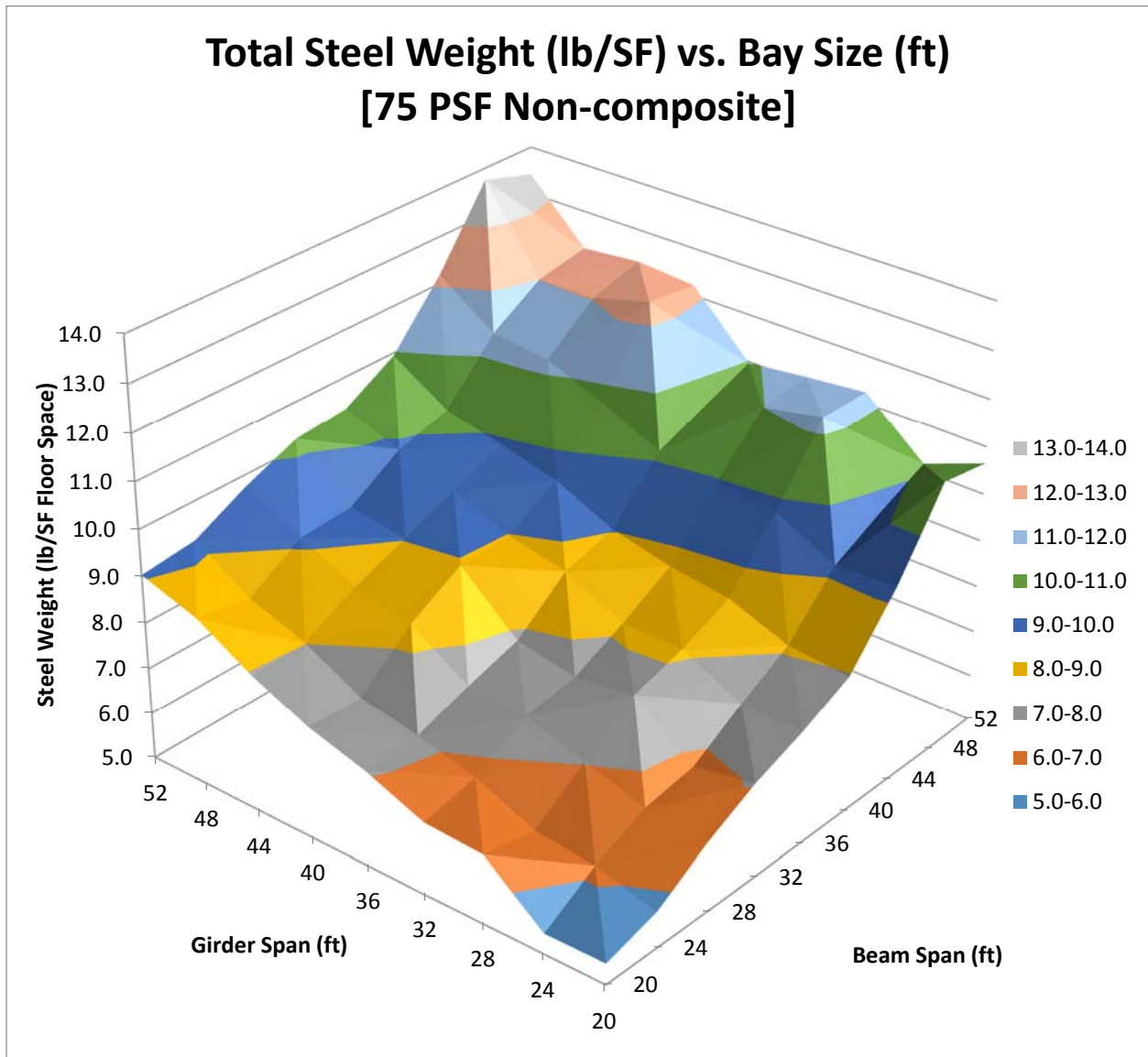
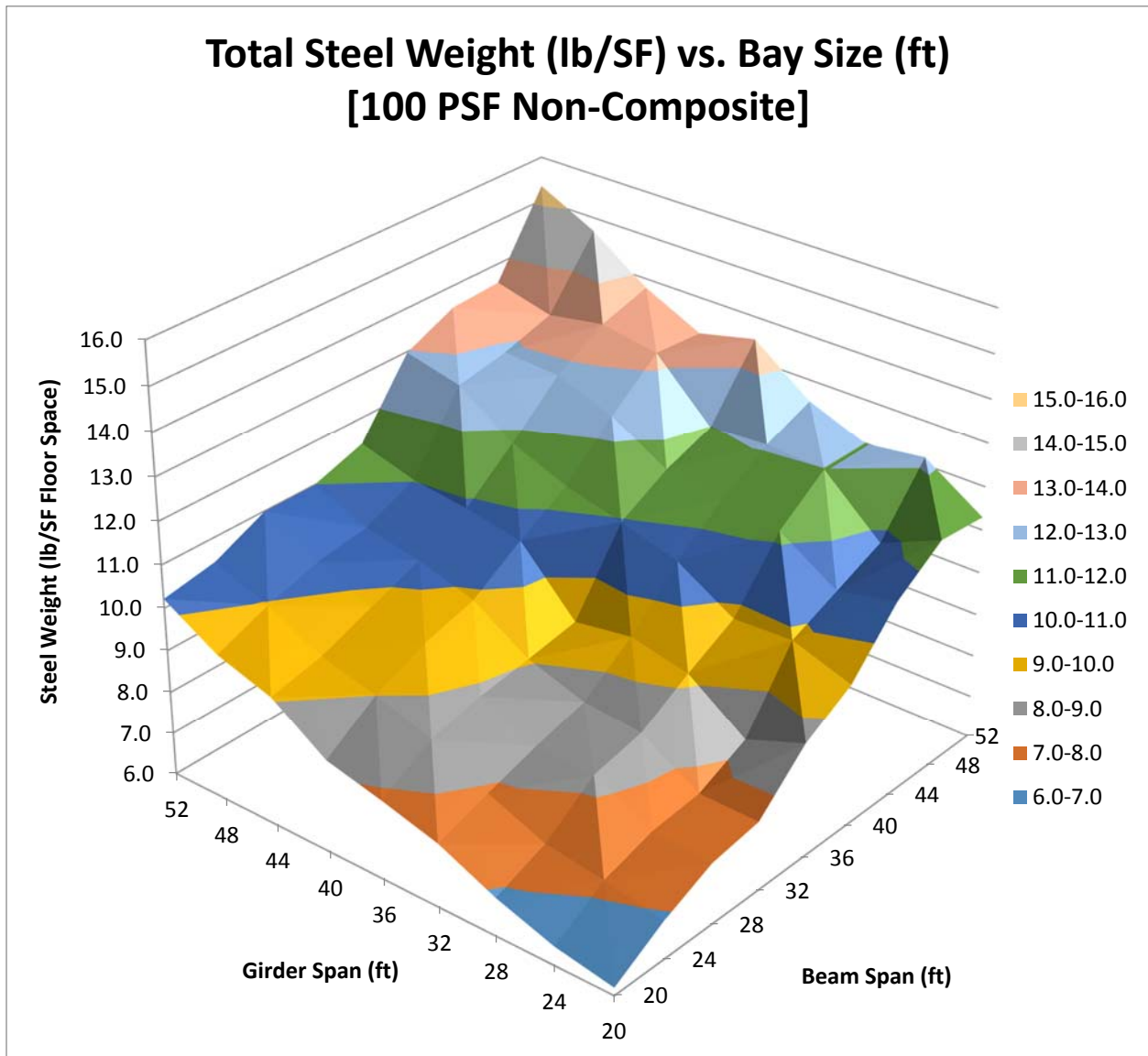

Figure 5-12: Total Steel Weight vs. Bay Size



For 75 lb/ft² live load, the minimum steel weight coincides with bay dimensions of 20 feet x 24 feet and a steel weight of 5.45 lb/ft². The maximum steel weight coincides with bay dimensions of 52 feet x 52 feet and a steel weight of 13.75 lb/ft². For 100 lb/ft² live load, the minimum steel weight coincides with bay dimensions of 20 feet x 20 feet and a steel weight of 6.19 lb/ft². The maximum steel weight coincides with bay dimensions of 52 feet x 52 feet and a steel weight of 15.33 lb/ft². Table 5-1 summarizes these results.

Table 5-1: Steel Weight Versus Live Load Intensity

| Steel Weight vs. Live Load | | | | |
|---|------------------------------------|-------------------|------------------------------------|-------------------|
| | Min. Steel | | Max. Steel | |
| Live Load Intensity (lb/ft ²) | Steel Weight (lb/ft ²) | lb Load/ lb Steel | Steel Weight (lb/ft ²) | lb Load/ lb Steel |
| 50 | 5.06 | 9.88 | 12.96 | 3.86 |
| 75 | 5.45 | 13.76 | 13.75 | 5.45 |
| 100 | 6.19 | 16.16 | 15.33 | 6.52 |

Structural steel weights increase approximately 6-8% when the live load increases from 50 lb/ft² to 75 lb/ft², independently of bay dimensions. When the live load increases from 75 lb/ft² to 100 lb/ft², the steel weight increases further by an additional 10-13%. Overall, doubling the live load from 50 lb/ft² to 100 lb/ft² produces a 20% increase in structural steel weight.

In addition to the steel weights from the graph, the table displays a ratio of the load weight to the structural steel weight. This ratio acts as a simplistic parameter to visualize the efficiency of the structure. As the ratio increases, the amount of load that a structure can carry for a given self-weight also increases, indicating a more efficient structure.

As seen from Table 5-1, despite the steel weight increasing as the live load intensity increases, the structural efficiency also increases as the live load intensity increases. While the structural efficiency of a bay ranges from 3.86 to 9.88 at 50 lb/ft², the efficiency increases to 6.52 to 16.16 when the live load reaches 100 lb/ft². This constitutes an increase in structural efficiency of 30-70%, depending on the particular dimensions of the bay.

Composite

Figure 5-13 shows results for composite beam weights per square foot versus bay spacing and span dimensions for 50 lb/ft² live loading. This graph can be compared to the results for non-composite beams presented earlier in this section. When compared to the graph for non-composite beams, this graph shows a sharper increase in steel weight for narrow spacing distances and long beam spans.

Figure 5-13: Composite Beam Weight vs Beam Spacing

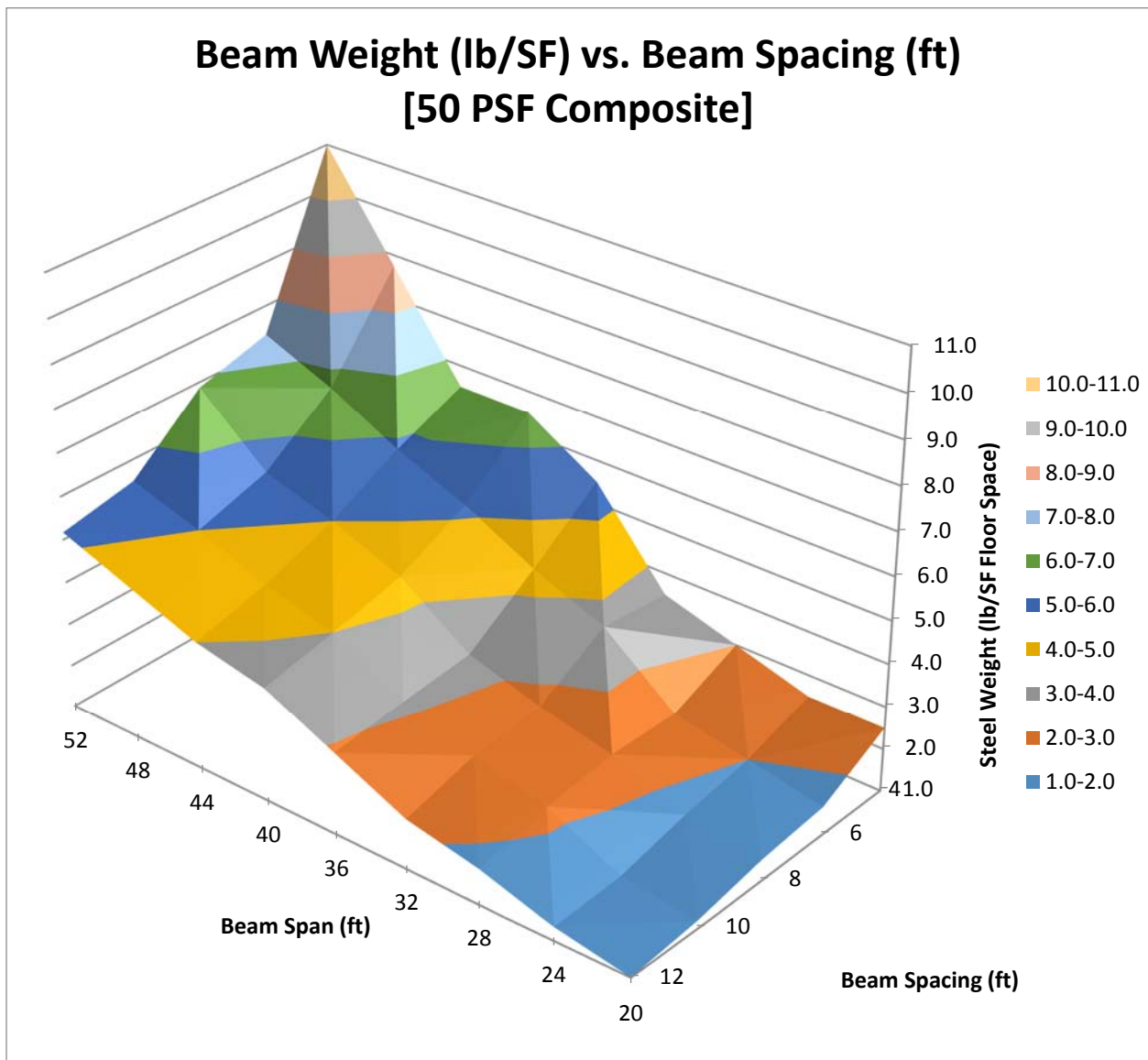

The minimum steel weight of 1.00 lb/ft² occurs for beams with 12 feet on-center spacing and 20 feet spans. Beams spaced at 4 feet on-center with 52 feet spans produce the maximum steel weight of 11.00 lb/ft². By comparison, the minimum and maximum steel weights for non-composite beams are 1.83 lb/ft² and 12.00 lb/ft², respectively. Although the absolute maximum and minimum steel weights remain mostly unchanged, intermediate framing conditions used significantly less steel when utilizing composite action. For instance, 52 feet long beams at 12 feet on-center weigh 7.00 lb/ft² for non-composite members, while the same framing configuration weighs only 5.17 lb/ft² for composite members. This constitutes a 25% reduction in steel weight.

Like composite beams, the weight of composite girder members behaves very similarly to the weight of non-composite members as a function of bay dimensions. The composite construction primarily creates an overall reduction in steel weight. The absolute minimum steel weight is 0.67 lb/ft² for 52 feet by 20 feet bays (short girders), and the maximum steel weight is 4.20 lb/ft² for 20 feet by 52 feet bays (long girders). By comparison, the minimum and maximum steel weights for non-composite girders are 1.19 lb/ft² and 5.80 lb/ft², respectively. Converting from non-composite to composite construction produces weight reductions around 30-40%. Figure 5-14 shows girder weight plotted against bay dimensions.

Figure 5-14: Composite Girder Weight vs. Bay Size

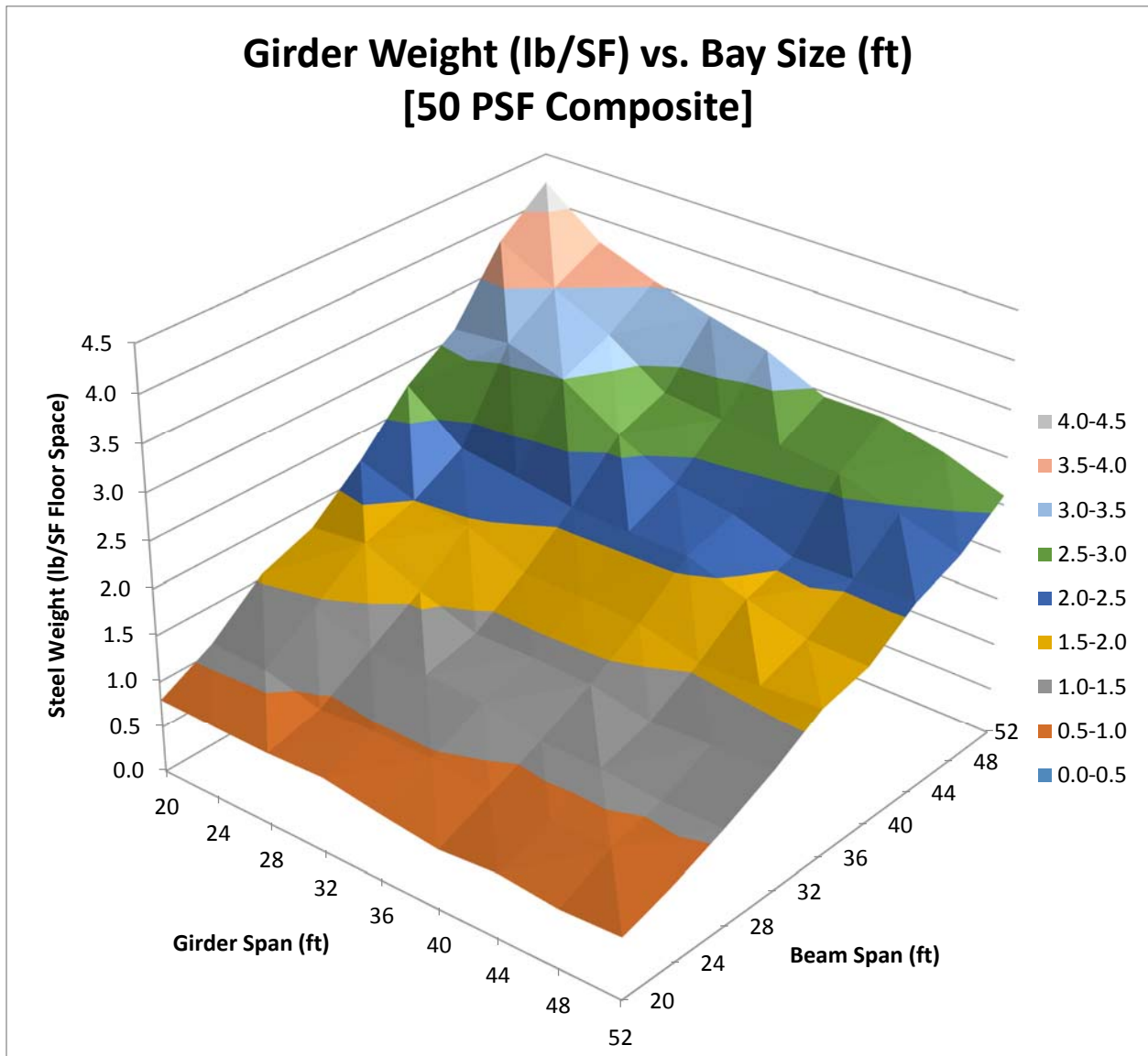

Combining beam, girder and column weight produces the surface plotted below in Figure 5-15 showing total steel weight versus bay dimensions. The absolute minimum steel weight tends toward configurations of minimum beam span and minimum girder span. This corresponds to 20 feet beam spans and 20 feet girder spans, which results in 3.16 lb/ft² of steel. The absolute maximum steel weight occurs at maximum beam and girder spans. This corresponds to beam span of 52 feet and girder span of 52 feet, which weighs

8.83 lb/ft². The absolute maximum girder weight is approximately 180% greater than the absolute minimum weight. Compared to the results for non-composite construction, composite construction yields significant weight savings. Recall that the minimum and maximum steel weights for 50 lb/ft² non-composite members are 5.06 lb/ft² and 12.96 lb/ft², respectively. Consequently, composite construction reduces the minimum steel weight by roughly 40% and the maximum steel weight by over 30%.

Figure 5-15: Total Composite Steel Weight vs. Bay Size

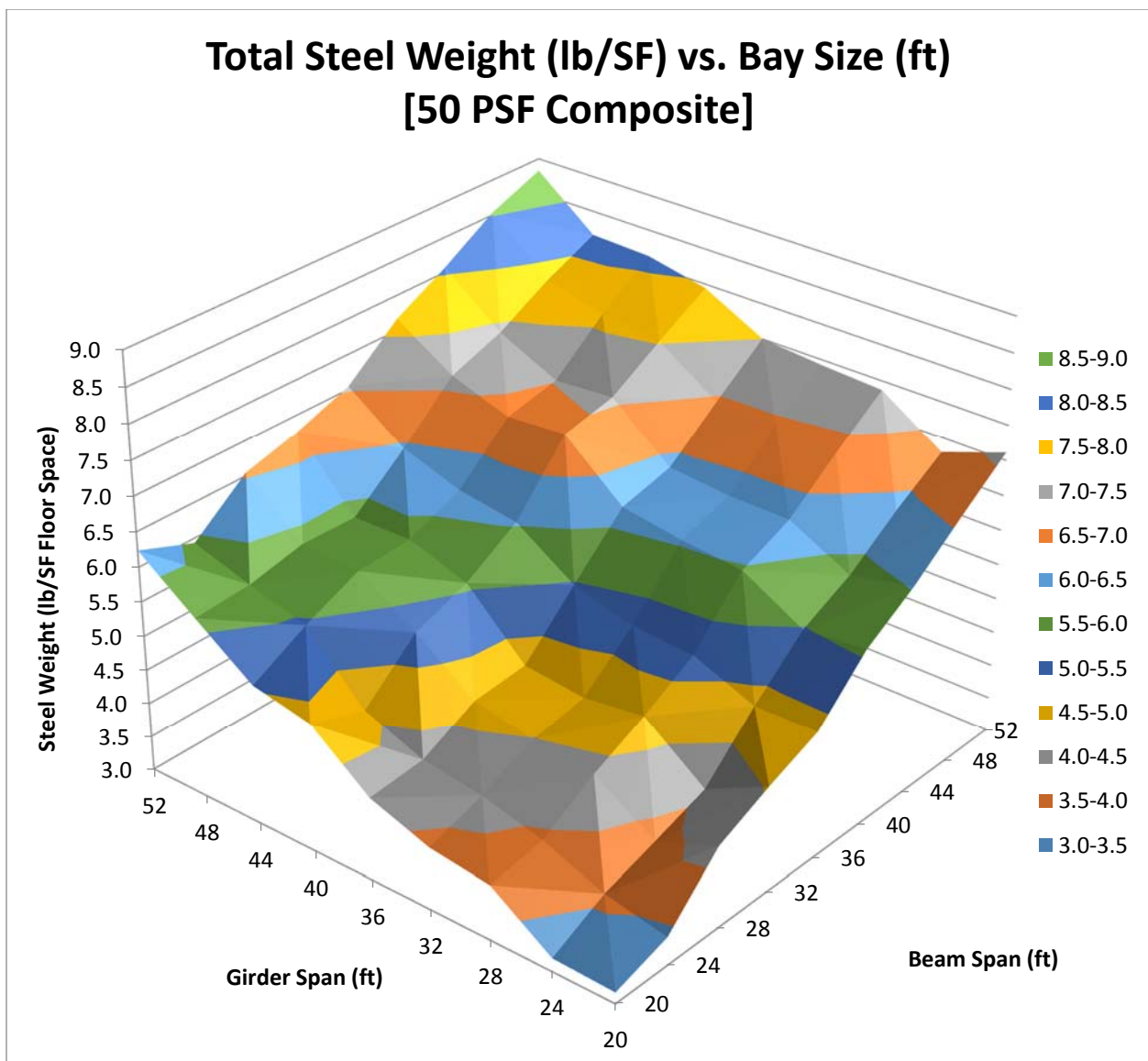

Chapter 6 - Conclusion

Beams

Beams typically constitute the majority of the steel weight of a gravity framing system. On average, beams account for roughly 50-55% of the framing steel, although the exact amount varies greatly depending on the proportions of the frame. For instance, bays with very long beams and short girders receive closer to 80% of their weight from beams alone. On the other hand, beam weight only accounts for 25% of the steel weight for bays with very short beams and long girders.

Beam weight may be decreased in two ways: decreasing the beam span and increasing the beam spacing. Beam weight increases linearly as the span increases, so keeping the beam span minimized prevents excessive beam weight. Likewise, every time the spacing of beams is doubled, the beam weight per square foot decreases by roughly 1/3. To minimize beam steel weight, beams should be spaced as far apart as possible. This spacing dimensions will likely be limited by the maximum allowable span of the metal deck.

Girders

Girders also contribute significantly to the weight of the steel bay than beams on average, but to a lesser extent than for beams. On average, girders account for roughly 35% of the framing steel, although this depends on the proportions of the frame. Bays with very long beams and short girders receive roughly to 10% of their weight from girders. Conversely, girders account for 66% of the steel weight of bays with long girders and short beams.

Girder weight may be decreased in the same two ways as for beams: decreasing the span and increasing the spacing. Girder weight increases linearly as the span increases, so minimized spans reduce steel weight. Additionally, every time the spacing of the girders is doubled, the girder weight per square foot decreases by roughly 1/4.

Columns

Out of all the structural elements of a framing system, columns contribute the least to the total structural weight by a wide margin. On average, columns contribute about 10-15% of the total steel weight to the framing system. Small bays receive about 25% of their weight from columns, while large bays receive only 6% of their steel weight from columns. Column weight per square foot tends to decrease such that the column steel weight is reduced by 25% every time the bay area quadruples.

Since columns are the only members in a typical framing arrangement that carry loads from multiple stories, their share of the total structural weight will vary depending on how many stories they support. Buildings consisting of a large number of stories possess columns that contribute a larger portion of the total steel weight. Conversely, low-rise buildings with a few stories require only small columns, which will contribute very little to the total steel weight in comparison to the beams and girders of the system.

Total

A significant caveat to these rules is that changing one parameter of the framing pattern may affect other parameters. For instance, doubling the girder spacing decreases the girder weight by roughly 25%; however, it necessitates doubling the span of the beams

that span between those girders. As discussed, beam weight increases linearly with the beam span, so doubling the beam span will result in roughly twice the steel weight. Since beams typically contribute more to the total steel weight than girders, any savings produced by increasing the girder spacing will be negated or even reversed by the increased weight of the longer beams. Similarly, large bay areas provide the benefit of decreasing the column steel weight per square foot; however, the increases of beam and girder steel weights overshadow any weight savings from the columns.

Live Load

Since live loads imposed on the structure directly contributed to the design forces of structural members, it would be expected that live load intensity would greatly affect the steel weight of a structure. In fact, this is not the case; live load intensity has relatively little effect on the structure weight compared to other factors considered in this parametric study. Increasing the live load imposed on a bay by 50% from 50 lb/ft² to 75 lb/ft² only increases the steel weight per square foot by 11%. Doubling the live load from 50 lb/ft² to 100 lb/ft² only produces a weight increase of 26%.

Construction Type

Composite construction of beams and girders produces significant savings in steel weight compared to non-composite construction. Bays framed with composite members typically use between 70% and 80% of the steel used for non-composite bays. This relationship is consistent across all bay dimensions. The cost of installing shear studs for

beams and girders partially negates the benefits of the steel weight reduction afforded by composite construction.

Summary

From a “steel-weight-only” perspective, the results show that minimized steel weight results from minimized bay dimensions. Few parameters analyzed in this study benefit from increased bay dimensions. Beam weight and girder weight, which contribute the vast majority of the steel weight of a bay, strongly favor minimized bay dimensions to achieve the least-weight solution. Beam spacing, live load intensity, and construction type, although they do have an effect on the steel weight, do not affect the dimensions of the least-weight bay configuration. These parameters tend to act uniformly as a percentage increase or decrease in steel weight across all bay dimensions. Only two parameters, girder spacing and columns, demonstrate any steel weight reductions as bay dimensions increase. As mentioned, any weight savings due to increasing the girder spacing are wiped out due to the corresponding increase in beam span. Columns show a reliable tendency to decrease in weight per square foot as the bay dimensions increase, with diminishing returns as the bay dimensions become progressively large. Due to the comparatively small weight of column steel compared to beams and girders, any weight savings from increasing the bay dimensions again pale in comparison to the steel weight increases in the beams and girders.

Since no result produced a least-weight framing solution, optimal bay dimensions likely do not exceed practical minimum dimensions for construction and architectural purposes. This means that bay dimensions will always be determined solely by the limits in

construction methods and the architectural requirements of the space. Bay dimensions smaller than these limits will be more difficult to construct due to space constraints.

Additionally, small bays constrict the use of a space by forcing the floor plan to conform to the closer column spacing, greatly reducing the flexibility and robustness of the space. In this case, bay dimensions should be selected such that the bay is as small as possible, yet still allows the space to function adequately for the use of the occupants.

Chapter 7 - Further Research

The analysis performed provides a basis to conduct additional research on the topic of economical framing. Many opportunities exist to expand this research, as well as explore related topics in the economics of building structural design.

Structural systems

Studies similar to this could be conducted for many other common structural systems, including timber, reinforced concrete, and steel joist systems. Timber systems could include glue-laminated beams, timber trusses, or I-joist framing. Reinforced concrete systems could include flat plates, flat slabs, pan joists, and beam and girder systems.

Building Parameters

Many of the building characteristics chosen for this study, including the number of stories and the story height, were selected semi-arbitrarily with the intention of creating a building that emulated a typical low-rise structure. These parameters that were treated as constants in the study may in fact greatly affect the final results. Certainly, as discussed earlier, the number of stories would have a significant effect on the column weight per square foot within the structure.

Likewise, the metal deck and concrete depth were kept constant throughout the analysis; however, situations with lighter floor loads and shorter deck spans would benefit from the use of thinner deck and less concrete. This change could provide significant cost savings which could change the economics of the situation.

Economics

Although this study attempts to discuss costs in a general sense, it does not provide enough detail for fabrication and construction to compare framing solutions between structural systems. This study largely measures the economy of a framing system by the weight of its structural components. Providing more information and detail on the monetary cost of materials and labor required to construct the structural framing would increase the value of the results of this analysis.

References

- American Institute of Steel Construction (AISC). 2003. Design Guide 5: Low- and Medium-Rise Steel Buildings.
- American Institute of Steel Construction (AISC). 2010. Steel Construction Manual 14th Edition. AISC 360-10.
- American Society of Civil Engineers (ASCE). 2010. Minimum Design Loads for Buildings and Other Structures. ASCE/SEI Standard 7-10.
- Carter, C. J., & Ashton, S. M. 2004. Look Before You Leap: Practical Advice for Laying Out Steel Framing. Structural Engineer Magazine.
- Nucor-Yamato Steel Company. 2016. May 4, 2016 Price List.
- Ricker, D. T. 2000. Value Engineering for Steel Construction. Modern Steel Construction.
- Ruddy, J. L. 1983. Economics of Low-Rise Steel-Framed Structures. AISC Engineering Journal, (Third Quarter), 107-118.
- Ruddy, J. L., & Ioannides, S. A. 2004. Rules of Thumb for Steel Design. Structures Magazine.
- Yura, J. A. 2001. Fundamentals of Beam Bracing. AISC Engineering Journal, (Third Quarter), 11-18.

Appendix A - Approximate Moment Method

Calculating the required moment capacity of a beam or girder is a crucial part of the design of the structural system of a building. Miscalculating the moment carried by a beam or girder results in an over-designed system, which wastes money and material, or an under-designed system which becomes a safety hazard to the occupants.

For any beam located in a floor system subjected to uniformly-distributed floor loads, the load in the beam can be treated as a uniformly-distributed load acting along the length of the member, which represents the floor deck or slab bearing uniformly along the member. In this situation, the equation for the moment in a simply supported beam with a uniformly distributed load accurately represents the actual moment in the beam.

$$M = \frac{wL^2}{8} \qquad \text{Equation A-1}$$

This equation provides a quick and simple way to calculate the moment in a beam.

For girders, determining the exact moment requires more calculation than for beams. Beam reaction forces carried by the girder resemble point loads, which produce a more complicated moment diagram than the uniformly distributed load carried by beam members. Solving for the exact moment requires solving for the girder's end reactions and plotting shear and moment diagrams. This process is more time-consuming and tedious.

If the moment produced in a girder could be approximated as being produced by a uniformly distributed load, the same equation used above for beams could also be used for girders. An approximation like this saves time, which saves money. The question at hand is this: Is this approximation accurate?

To investigate the value of this approximation, an example girder is used to compare the maximum moment due to a uniformly distributed load, one point load, two point loads, three point loads, and four point loads. In order to simplify the investigation, several conditions are set. First, point loads acting on a girder represent beam reactions, which will be evenly spaced along the girder's span. Second, beam reaction forces are the result of the uniformly-distributed loads carried by the beams. This means that all point loads will be equal in magnitude. Third, beam reactions forces are proportional to their tributary width, so their magnitude will be proportional to the beam spacing. 4th, the end supports of the girder are treated as columns. These columns will also have beams framing into them perpendicular to the girder. This affects the load taken by the girder, because these end beams will take part of the floor load that would normally be taken by the girder if the load was uniformly distributed along its span.

The example girder has a span of 10 feet and is simply supported. It carries a uniformly distributed floor load of 1 k/ft. This distributed load will be divided into each beam's tributary area to determine point load magnitudes.

Distributed Load Approximation:

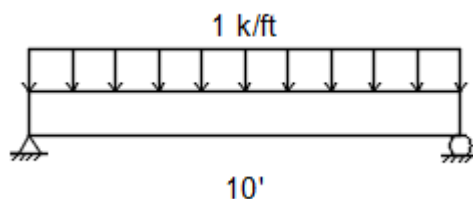

Figure 7-1: Distributed Load Diagram

$$M = \frac{wL^2}{8}$$

$$M = \frac{(1)(10)^2}{8}$$

$$M = 12.5 \text{ k} - \text{ft}$$

For the moment approximation, the equation for a uniformly distributed load yields a maximum moment of 12.5 k-ft. This value will be compared to the values obtained from the one-, two-, three-, and four-point-load situations. This approximation ignores any beams transferring reaction forces as point loads and treats the girder as if the uniformly distributed floor load were acting directly on it.

One Point Load:

For one point load, a single beam frames into the girder at mid-span. Because the beams are evenly spaced along the girder, the tributary width of the beam is 5 feet. This means that the beam reaction force will be 5 kips. For one point load, the maximum moment can be calculated as shown below.

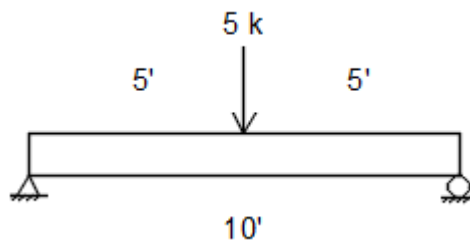

Figure 7-2: One Point Load Diagram

$$M = \frac{PL}{4}$$

$$M = \frac{(5)(10)}{4}$$

$$M = 12.5 \text{ k-ft}$$

Calculating the exact moment due to a single point load at mid-span results in a maximum moment in the girder of 12.5 k-ft, which is exactly equal to the uniformly distributed load approximation.

Two Point Loads:

For two point loads, two beams frame into the girder at third-span points on the girder. The beams are spaced 3.333 feet on center, and each produces a point load on the girder of 3.333 kips. For two point loads, the maximum moment can be calculated as shown below.

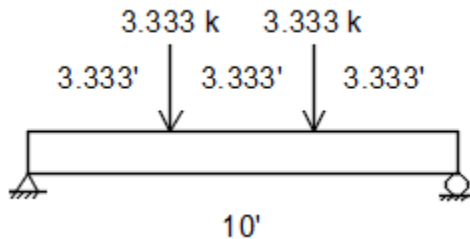

Figure 7-3: Two Point Load Diagram

$$M = Pa$$

$$M = (3.333)(3.333)$$

$$M = 11.1 \text{ k-ft}$$

The maximum moment on the girder produced by two point loads is 11.1 k-ft, which does not match the moment from a uniformly distributed load. However, the exact value is about 13% less than the approximate value, meaning that the approximation is conservative in this case.

Three Point Loads:

For three point loads, three beams frame into the girder at quarter points of the girder. The beams are spaced 2.5 feet on center, and each point load is 2.5 kips. Calculating the moment now becomes more complicated, which demonstrates the possible value of this approximation.

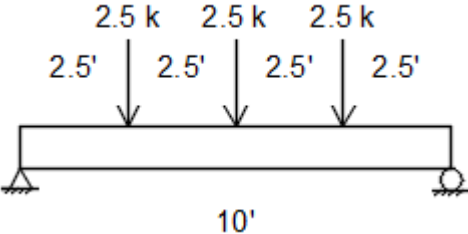

Figure 7-4: Three Point Load Diagram

Reaction force at end supports: **3.75 k**

Taking a cut at the mid-span and summing the moments produces:

$$\Sigma M = 0$$

$$\Sigma M = M - (3.75)(5) + (2.5)(2.5) = 0$$

$$M = (3.75)(5) - (2.5)(2.5)$$

$$M = 12.5 \text{ k} - \text{ft}$$

Calculating the exact moment due to three point loads results in a maximum moment in the girder of 12.5 k-ft, which is exactly equal to the uniformly distributed load approximation.

Four Point Loads:

With four point loads, four beams frame into the girder at fifth points on the girder. The beams are spaced 2 feet on center, and each point load is 2 kips.

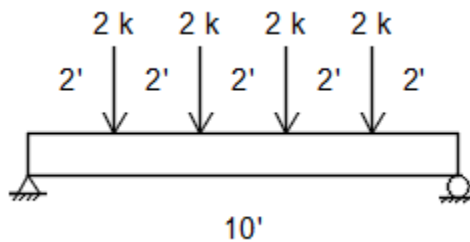

Figure 7-5: Four Point Load Diagram

Reaction force at end supports: **4 k**

Taking a cut at the mid-span and summing the moments produces:

$$\Sigma M = 0$$

$$\Sigma M = M - (4)(5) + (2)(3) + (2)(1) = 0$$

$$M = (4)(5) - (2)(3) - (2)(1)$$

$$M = 12 \text{ k} - \text{ft}$$

Calculating the exact moment due to four point loads results in a maximum moment in the girder of 12 k-ft, which is nearly equal to the uniformly distributed load approximation. This constitutes a difference of only 4% between the approximate and exact moments, with the approximate moment being slightly conservative.

Results:

The tabulated comparison in Table 7-1 between the approximate and exact moments presented below demonstrates the accuracy of the approximate method. The table includes data for five and six point loads to illustrate the results further.

The results show that the maximum deviation from the exact moment is only 13% for two point loads, with the deviation between the two values rapidly converging toward 0% as the number of point loads increases. Furthermore, the moment in girders with an odd number of point loads matches perfectly between approximate and exact methods.

Table 7-1: Maximum Bending Moment Results for Approximate Moment Method

| Load Distribution | Maximum Girder Moment (k-ft) | | |
|-------------------|------------------------------|-------|---------------|
| | Approximate | Exact | % Above Exact |
| 1 Point Load | 12.50 | 12.50 | 0.0% |
| 2 Point Loads | 12.50 | 11.11 | 12.5% |
| 3 Point Loads | 12.50 | 12.50 | 0.0% |
| 4 Point Loads | 12.50 | 12.00 | 4.2% |
| 5 Point Loads | 12.50 | 12.50 | 0.0% |
| 6 Point Loads | 12.50 | 12.24 | 2.1% |
| ... | - | - | - |
| Uniform | 12.50 | 12.50 | 0.0% |

Conclusion:

The results from the investigation clearly show that the approximate moment method closely models the exact maximum moment in a girder subjected to any number of evenly spaced point loads. Several interesting conclusions can be drawn from these results, including a determination of the validity of this approximate method.

As stated previously for an odd number of point loads, the moment from the approximate method will always be equal to the moment from exact methods. Although an unexpected result of the approximate method, it is a direct product of the initial conditions. Consider the difference between a single mid-span point load and a distributed load. If $P = wL$, the point load produces twice the moment as the distributed load. However, due to the way the load is distributed in the approximate moment method, $P = wL/2$. This produces equal moments for the point load and distributed load cases.

For an even number of point loads, the percent difference begins at acceptable levels, but quickly converges towards 0%. This result makes sense, considering that a uniformly distributed load can be treated as an infinite number of small, evenly spaced point loads. As the load on the beam is divided into increasingly many point loads, the moment diagram resembles that of a uniformly distributed load with increasing accuracy. At a limit, when the number of point loads approaches infinity, the load condition essentially becomes a uniformly distributed load.

An important limitation of this method is that it cannot approximate shear forces with the same accuracy. Approximating shear forces with this method will always produce values that are greater than the exact values, but by a much larger margin than for moment approximations. For the case of a single point load, the shear force calculated with the approximate method will be twice the magnitude of the exact value. This discrepancy decreases as the number of point loads increases, converging to a 0% difference when the number of point loads approaches infinity. The table below summarizes these results.

Table 7-2: Maximum Shear Results for Approximate Moment Method

| Load Distribution | Maximum Girder Shear (k) | | |
|-------------------|--------------------------|-------|---------------|
| | Approximate | Exact | % Above Exact |
| 1 Point Load | 5.0 | 2.5 | 100% |
| 2 Point Loads | 5.0 | 3.333 | 50% |
| 3 Point Loads | 5.0 | 3.75 | 33% |
| 4 Point Loads | 5.0 | 4 | 25% |
| 5 Point Loads | 5.0 | 4.167 | 20% |
| 6 Point Loads | 5.0 | 4.286 | 17% |
| ... | - | - | - |
| Uniform | 5.0 | 5.0 | 0.0% |

Although this method is not as accurate for shear, the margin of error can be accepted for a few reasons. First, the value is always conservative, which allows the engineer to accept the value without having to check if it falls short of the real value. Second, shear strength of beams and girders rarely governs the selection of a member under normal load conditions for a floor system.

The approximate method is a powerful design tool to assist engineers with estimating loads and developing preliminary member sizes. Engineers should acknowledge the limits of this method as an approximation, and not use it as a substitute for good engineering practice. This method was analyzed with point loads of uniform spacing and magnitude. In more unique or more complicated load cases, a more rigorous analysis method should be used to assess the forces acting on a member.

Appendix B - Beam and Girder Weight Derivations

In “Rules of Thumb for Steel Design”, by Socrates Ioannides and John Ruddy, the following equation was presented as a method of approximating the required section weight of a steel beam for a given moment and nominal section depth (e.g. a W24x55 has a nominal section depth of 24 inches):

$$Wt = \frac{3.5M}{D} \quad \text{Equation 2-22b}$$

where:

Wt = estimated section weight (lb/ft)

M = required moment capacity of the beam (k-ft)

D = nominal section depth (in)

Derivation

This equation is formulated using the Allowable Stress Design method; however, the equation can be re-formulated using Load Resistance Factor Design. Start with the same equation form, with the coefficient of 3.5 being replaced by a new constant:

$$Wt = \frac{kM_u}{D} \quad \text{Equation B-1}$$

where:

k = constant

M_u = required moment capacity of the beam (k-ft)

The value of the new coefficient, k , can be found that reflects the change in design method from ASD to LRFD. To simplify the derivation of this equation, the beam's compression flange is assumed to be continually braced so that the governing limit state is flexural yielding. When the governing limit state of a beam is flexural yielding, the nominal strength of the beam is its plastic moment capacity, therefore:

$$M_u = \phi M_n = \phi M_{px} \quad \text{Equation B-2}$$

The plastic moment strength as defined by AISC Specification Equation F2-1:

$$\phi M_{px} = \frac{\phi F_y Z_x}{12} \quad \text{Equation B-3}$$

where:

ϕ = strength reduction factor ($\phi=0.9$ for flexure)

F_y = yield stress of steel ($F_y = 50$ ksi for ASTM A992 steel)

Z_x = plastic section modulus (in^3)

Z_x is a section property, but can be approximated as being proportional to the cross-sectional area of the section multiplied by the nominal depth of the section, as shown in Equation B-4.

$$Z_x = \beta A_s D \quad \text{Equation B-4}$$

where:

β = constant

A_s = cross-sectional area (in²)

Values for Z_x , A_s , and D were compared for 17 “economy” beam sections. The “economy” beam sections are the shapes which possess the highest moment strength for their weight and are bolded in Table 3-2 in the AISC Steel Manual. The 17 analyzed shapes are W18x35, W18x40, W21x44, W21x48, W21x 50, W21x55, W24x55, W24x62, W24x68, W24x76, W24x84, W27x84, W30x90, W30x99, W30x108, W30x116, W33x118. These shapes were chosen because they are the most common member sizes resulting from the analysis. The average value for β from this set of shapes is about 0.36. A plot of these values is shown in Figure 7-8.

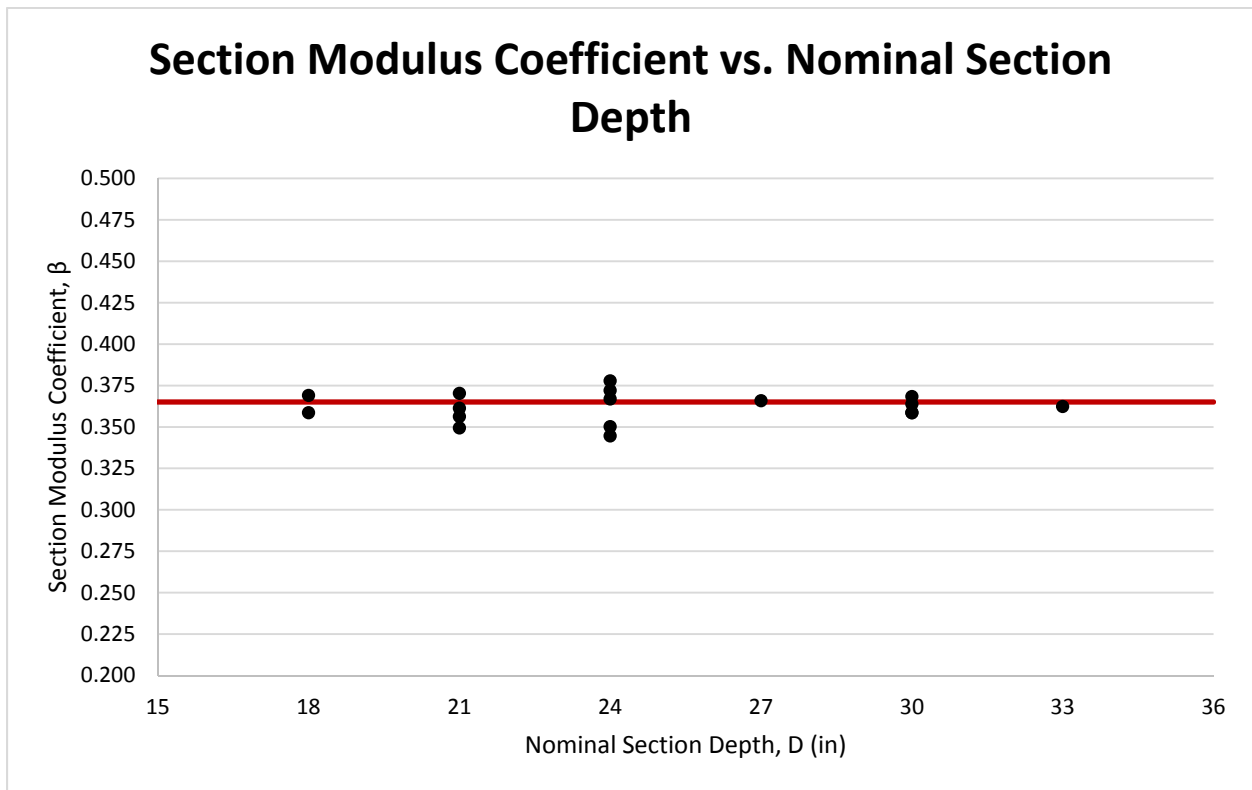

Figure 7-6: Section Modulus Coefficient for Economy Sections

Now, Equations B-1, B-2, B-3, and B-4 can be combined.

$$Wt = \frac{kM_u}{D} \quad \text{Equation B-1}$$

Substitute Equation B-2 for M_u :

$$Wt = \frac{k(\phi M_{px})}{D} \quad \text{Equation B-5}$$

Substitute Equation B-3 for ϕM_{px} :

$$Wt = \frac{k\left(\frac{\phi F_y Z_x}{12}\right)}{D} \quad \text{Equation B-6}$$

Substitute Equation B-4 for Z_x :

$$Wt = \frac{k(\phi F_y \beta A_s D)}{12D} \quad \text{Equation B-7}$$

$$Wt = \frac{k\phi F_y \beta A_s}{12} \quad \text{Equation B-8}$$

Wt , the section weight in pounds per foot can be written as the section area multiplied by the specific weight of steel, shown in Equation B-9.

$$Wt = \frac{A_s \gamma_s}{144} \quad \text{Equation B-9}$$

where:

γ_s = specific weight of steel (490 lb/ft³)

Substitute Equation B-9 into Equation B-8 for Wt and solve for k :

$$Wt = \frac{k\phi F_y \beta A_s}{12} \quad \text{Equation B-8}$$

$$\frac{A_s \gamma_s}{144} = \frac{k\phi F_y \beta A_s}{12} \quad \text{Equation B-10}$$

$$\frac{\gamma_s}{12} = k\phi F_y \beta \quad \text{Equation B-11}$$

$$k = \frac{\gamma_s}{12\phi F_y \beta} \quad \text{Equation B-12}$$

$$k = \frac{490}{12(0.9)(50)(0.36)}$$

$$k = 2.5$$

Solving the equation results in a value for k of about 2.5, which is smaller than the value of 3.5 from the equation presented in the article. This smaller value reflects the difference between the ASD and LRFD methods of calculating loads and member capacities.

Substituting the value for k into the original equation produces:

$$Wt = \frac{2.5 M_u}{D} \quad \text{Equation B-1}$$

This equation can be generalized to produce a steel weight per area as a function of floor loads and member span. This provides the powerful capability of estimating the total structural weight of a building before even selecting member sizes or spacing. As demonstrated in the Approximate Moment Method Appendix, the required moment

capacity of the beam can be accurately approximated as being produced by a uniformly distributed load, so:

$$M_u = \frac{w_u L^2}{8} \quad \text{Equation A-1}$$

where:

w_u = factored uniform distributed load intensity (k/ft)

L = member span (ft)

Since the primary loads acting on the floor system are gravity dead and live loads, the governing ASCE 7 load combination is $U=1.2D+1.6L$.

The nominal section depth can be approximated to be proportional to the span of the member. “Rules of Thumb for Steel Design” suggests an L/D ratio between 20 and 28 for beams, which is supported by the results of this research. For beams, an L/D ratio of 24 will be used to relate the section depth to the member span, and for girders an L/D ratio of 16 will be used. These L/D ratios are consistent with the results of the analysis in this thesis. In summary:

| | | |
|---------------------|--|---|
| For beams: | $\frac{L \text{ (in)}}{D \text{ (in)}} = 24$ | $\frac{L \text{ (ft)}}{D \text{ (in)}} = 2$ |
| For girders: | $\frac{L \text{ (in)}}{D \text{ (in)}} = 16$ | $\frac{L \text{ (ft)}}{D \text{ (in)}} = 1.333$ |

These ratios mean that the member depth roughly increases linearly with the member’s span. For example, a beam that spans 32 feet will have a depth of roughly 16 inches. Of course, the span to depth ratio of the member is dependent on a wide variety of factors, such as the intensity of loading and the tributary width that it serves. This is

reflected in the analysis results. The depths of non-composite 32-foot beams range from 10 inches for lightly-loaded beams to 21 inches for heavily-loaded, widely-spaced beams.

Although these simple ratios fail to capture the variations due to these conditions, they do provide a very simple relationship that captures the average of these different situations.

These ratios are substituted into Equation B-1 for D and Equation A-1 can be substituted for M_u .

For beams:

$$Wt = \frac{2.5M_u}{D} \quad \text{Equation B-1}$$

Substitute Equation A-1 for M_u :

$$Wt = \frac{2.5\left(\frac{w_u L^2}{8}\right)}{D} \quad \text{Equation B-10}$$

Substituting the L/D ratio to eliminate D :

$$Wt = \frac{2.5\left(\frac{w_u L^2}{8}\right)}{(0.5L)} \quad \text{Equation B-11}$$

$$Wt = \frac{5}{8}w_u L \quad \text{Equation B-12a}$$

For girders:

$$Wt = \frac{2.5M_u}{D} \quad \text{Equation B-1}$$

Substitute Equation A-1 for M_u :

$$Wt = \frac{2.5\left(\frac{w_u L^2}{8}\right)}{D} \quad \text{Equation B-10}$$

Substitute the L/D ratio to eliminate D:

$$Wt = \frac{2.5\left(\frac{w_u L^2}{8}\right)}{(0.75L)} \quad \text{Equation B-13}$$

$$Wt = \frac{5}{12} w_u L \quad \text{Equation B-12b}$$

The weight per square foot of a member can be found by taking the weight per foot of the member and dividing it by the tributary width of that member. Also, the uniformly distributed load on a member in kips per foot is equal to the floor loading multiplied by the tributary width.

$$H = \frac{Wt}{w_T} \quad \text{Equation 3-1}$$

where:

H = steel weight (lb/ft²)

Wt = section weight (lb/ft)

w_T = tributary width of member (ft)

$$w_u = q_u w_T \quad \text{Equation B-14}$$

where:

q_u = factored floor load (kips/ft²)

Equation 3-1 can be expanded using Equations B-12a), B-12b, and B-14.

For beams:

Substitute Equation B-12a for Wt :

$$H = \frac{Wt}{w_T} \quad \text{Equation 3-1}$$

$$H = \frac{\left(\frac{5}{8}w_uL\right)}{w_T} \quad \text{Equation B-15}$$

Substitute Equation B-14 for w_u :

$$H = \frac{\left(\frac{5}{8}w_uL\right)}{w_T} \quad \text{Equation B-15}$$

$$H = \frac{5}{8}q_uL \quad \text{Equation B-16a}$$

For girders:

$$H = \frac{Wt}{w_T} \quad \text{Equation 3-1}$$

Substitute Equation B-12b for Wt :

$$H = \frac{\left(\frac{5}{12}w_uL\right)}{w_T} \quad \text{Equation B-17}$$

Substitute Equation B-14 for w_u :

$$H = \frac{\left(\frac{5}{12}(q_uw_T)L\right)}{w_T} \quad \text{Equation B-18}$$

$$H = \frac{5}{12}q_uL \quad \text{Equation B-16b}$$

These equations are formulated with the assumption that the members are limited by the strength of the material and therefore represent a theoretical minimum steel weight.

The only way to decrease the steel weight would be either to increase the yield stress of the material or to increase the section depth while decreasing the section area, which would change the β factor used in this derivation.

Strength is not the only limit state that governs member selection. In many cases, serviceability limit states such as deflection are the limiting factor in beam design. Since design limits for deflection result in members not reaching to their full design moment capacity, the previous equations will not provide accurate estimates of steel weights. Members designed based on deflection will be heavier than those designed purely for strength because the members are not loaded to their full capacity before reaching their deflection limit if deflection governs. Nevertheless, equations similar to Equations B-16a and B-16b can be formulated to find steel weights per square foot when members are sized for deflection. These weights can be considered as a theoretical upper limit to steel weights because members will not have to be larger than demanded by the deflection criteria if deflection governs the design.

Start with the deflection equation for a simply supported member subjected to a uniformly distributed load:

$$\Delta = \frac{5wL^4}{384EI} \quad \text{Equation 3-5}$$

where:

Δ = maximum member deflection (in)

w = intensity of un-factored uniformly distributed load (k/in)

L = member span (in)

E = Young's Modulus of the material (29,000 ksi for steel)

$I =$ moment of inertia of member (in⁴)

The deflection criteria selected for beam design will determine how heavy the beams must be. Instances where deflection must be tightly controlled will require members with a larger moment of inertia to resist deformation under loads, which in turn usually means heavier sections. The analysis in this thesis uses deflection criteria of $L/360$ for live load deflection and $L/240$ for total load deflection, which are presented in the International Building Code as serviceability limits for deflection of floor members. Deflection due to combined dead plus live load is the governing deflection case, which can be written as,

$$\frac{\Delta}{L} = \frac{1}{240} \quad \text{Equation B-19}$$

This can be substituted into Equation 3-5 to yield the following:

$$\Delta = \frac{5wL^4}{384EI} \quad \text{Equation 3.5}$$

$$\frac{\Delta}{L} = \frac{5wL^3}{384EI} \quad \text{Equation B-20}$$

$$\frac{1}{240} = \frac{5wL^3}{384EI} \quad \text{Equation B-21}$$

The equation is rewritten to express the member length, L , in feet and the uniform unfactored load intensity, w , in kips per foot.

$$\frac{1}{240} = \frac{5w\left(\frac{1}{12}\right)(12 * L)^3}{384EI} \quad \text{Equation B-22}$$

$$\frac{1}{240} = \frac{5wL^3(144)}{384EI} \quad \text{Equation B-23}$$

Simplify constants and solve for I:

$$I = \frac{9wL^3}{580} \quad \text{Equation B-24}$$

In a similar method to the plastic section modulus, the moment of inertia can be approximated as being proportional to the section area multiplied by the nominal section depth squared. This equation originates from the approximation proposed in Equation 2-8 by Ruddy and Ioannides in “Rules of Thumb for Steel Design” (2000); however, the constant C is empirically obtained specifically for the “economy” sections to produce a more accurate approximation and to independently verify its validity.

$$I = CA_sD^2 \quad \text{Equation B-25}$$

I = moment of inertia of member (in⁴)

C = constant

Values for I, A_s, and D were compared for the same 17 economy beam sections, and an average value for C was about 0.155, as shown in Figure 7-9 below. This value not only confirms Ruddy and Ioannides’ findings, but also demonstrates how closely the sections approach the average when plotted.

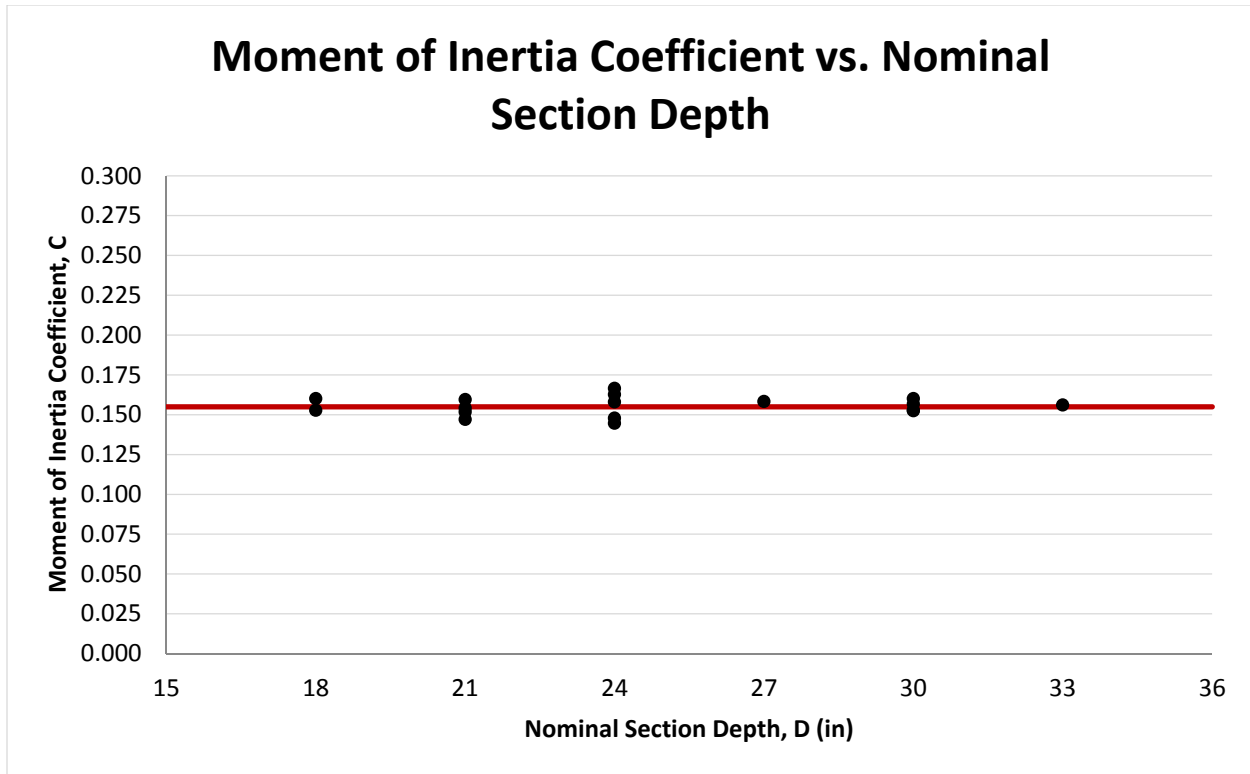

Figure 7-7: Moment of Inertia Coefficient for Economy Sections

Equation B-25 can be substituted into equation B-24 for I:

$$I = \frac{9wL^3}{580} \quad \text{Equation B-24}$$

$$CA_s D^2 = \frac{9wL^3}{580} \quad \text{Equation B-26}$$

$$0.155A_s D^2 = \frac{9wL^3}{580} \quad \text{Equation B-27}$$

Empirical L/D ratios for beams and girders can be substituted in for D. The L/D ratios for members governed by deflection are slightly higher than for those governed by strength.

For beams:

$$L \text{ (in)} / D \text{ (in)} = 30 \qquad L \text{ (ft)} / D \text{ (in)} = 2.5$$

For girders:

$$L \text{ (in)} / D \text{ (in)} = 19.2 \qquad L \text{ (ft)} / D \text{ (in)} = 1.6$$

Additionally, the un-factored uniformly distributed load intensity, w , can be written as the product of the un-factored floor load and the tributary width of the supporting member, as shown in Equation B-28. This is similar to Equation B-14; however, Equation B-28 uses un-factored loads while Equation B-14 uses factored loads.

$$w = qw_T \qquad \text{Equation B-28}$$

For beams:

$$0.155A_s D^2 = \frac{9wL^3}{580} \qquad \text{Equation B-29}$$

Substitute the L/D ratio to eliminate D:

$$0.155A_s(0.4L)^2 = \frac{9wL^3}{580} \qquad \text{Equation B-30}$$

Substitute Equation B-28 for w :

$$0.155A_s(0.4L)^2 = \frac{9(qw_T)L^3}{580} \qquad \text{Equation B-31}$$

Solve for A_s and simplify:

$$A_s = \frac{9qw_T L}{(0.155)(0.4^2)(580)} \qquad \text{Equation B-32}$$

$$A_s = \frac{5}{8}qw_T L \qquad \text{Equation B-33a}$$

Equation B-33a can be combined with Equations 3-1 and B-9:

$$H = \frac{Wt}{w_T} \quad \text{Equation 3-1}$$

Substitute Equation B-9 for Wt:

$$H = \frac{(A_s \gamma_s)}{w_T} \quad \text{Equation B-34}$$

Substitute Equation B-33a for A_s:

$$H = \frac{\left(\frac{5}{8} q w_T L\right)(490)}{(144) w_T} \quad \text{Equation B-35}$$

$$H = \frac{17}{8} q L \quad \text{Equation B-36a}$$

For girders:

$$0.155 A_s D^2 = \frac{9 w L^3}{580} \quad \text{Equation B-29}$$

Substitute the L/D ratio to eliminate D:

$$0.155 A_s \left(\frac{5}{8} L\right)^2 = \frac{9 w L^3}{580} \quad \text{Equation B-37}$$

Substitute Equation B-28 for w:

$$0.155 A_s \left(\frac{5}{8} L\right)^2 = \frac{9 (q w_T) L^3}{580} \quad \text{Equation B-38}$$

Solve for A_s and simplify:

$$A_s = \frac{9 q w_T L}{(0.155) \left(\frac{5}{8}\right)^2 (580)} \quad \text{Equation B-39}$$

$$A_s = 0.256 q w_T L \quad \text{Equation B-33b}$$

Equation B-33b can be combined with Equations 3-1 and B-9:

Substitute Equation B-9 for W_t :

$$H = \frac{(A_s \gamma_s)}{W_t} \quad \text{Equation B-34}$$
$$H = \frac{W_t}{w_T} \quad \text{Equation 3-1}$$

Substitute Equation B-33b for A_s :

$$H = \frac{(0.256 q w_T L)(490)}{(144) w_T} \quad \text{Equation B-40}$$

$$H = \frac{7}{8} q L \quad \text{Equation B-36b}$$

Results

Estimated steel weights per square foot when governed by strength limit states can be described by the following equations for beams and girders.

Beams $H = \frac{5}{8} q_u L$ Equation B-16a

Girders $H = \frac{5}{12} q_u L$ Equation B-16b

Similarly, estimated steel weights per square foot when governed by deflection limit states can be described by the following equations.

Beams $H = \frac{17}{8} q L$ Equation B-36a

Girders $H = \frac{7}{8} q L$ Equation B-36b

Conclusions

Equations B-36a and B-36b that result from this are very similar to Equations B-16a and B-16b. Two differences are worth noting. Equations B-36a and B-36b use the factored floor loads, while Equations B-16a and B-16b use un-factored floor loads. This is due to the fact that Equations B-16a and B-16b are based on the member strength, resulting in the equations having the factored loads and strength reduction factors built into them.

Conversely, deflection criteria are based on service-level loads, which leaves Equations B-36a and B-36b in terms of un-factored loads. The second difference is a difference in the coefficients. Equations B-36a and B-36b have higher coefficients, meaning that designs governed by deflection criteria will result in a heavier structure weight per square foot than a design governed by member strength.

These equations show that the structure weight increases proportionally to both the imposed floor load and the member spans. Since steel weight increases proportionally to the member spans, it seems that short spans would result in lighter structural weights. This may cause an increase in the steel weight of columns, as more columns are needed to support the short-span members. Because of these opposing influences, a minimum usage of steel may not necessarily a structure with the shortest beam and girder spans, but one that balances the beam and girder weight with the column weight. As an example, consider a building with 5 feet beams and 5 feet girders with columns 5 feet on-center in each direction to support the beams and girders. Aside from obvious space constraints imposed by this arrangement, the structure is not an efficient use of material. While the beam and girder weight may be very low due to their short spans, the column weights would be very

high simply due to needing so many so close together. This conceptually shows that a practical limit exists to these equations.

These equations also yield several non-intuitive results. The first of these is no term for the tributary width of the member is used, which means that the estimated steel weights are independent of the tributary width of the members, and consequently, the spacing of the members. The spacing of the members may determine where the steel weights fall between these two limits, but it does not affect the boundaries of the limits themselves. For instance, a long member with a narrow tributary width would be governed by deflection, placing it near the deflection limits of the equations, while a shorter member with a wide tributary width would be governed by member strength, placing it near the strength limits of the equations.

Another interesting and possibly unintuitive result of these equations is that steel weight increases only linearly with member span. Since moments due to a distributed load are proportional to the square of the member span, and member deflection is proportional to the member length to the 4th power, it is reasonable to assume that the strength and deflection limits would follow in a similar manner.

An important consideration when using these equations is that they were developed using the properties of A992 W-shape non-composite beam sections. These equations would not accurately represent situations using members with different steel grades or section types. Also, these equations were derived based on a deflection limit of $L/240$ deflection under combined dead and live load. For different deflection criteria, the coefficients for these equations will be different. These equations were also developed with

the assumption of regularly-shaped, rectangular bays; therefore, they would not accurately represent situations with irregular framing plans.

Appendix C - Column Weight Derivation

Formulas for the steel weight of columns per square foot can be derived with a method similar to that for beams and girders. For the LRFD design method, the following equation is used for the design of a column:

$$\phi P_n = P_u \quad \text{Equation C-1}$$

The design strength of a column is, according to the AISC Steel Manual Equation E3-1:

where:

$$\phi P_n = \phi F_{cr} A_g \quad \text{Equation C-2}$$

where:

ϕP_n = column design axial capacity (kips)

ϕ = strength reduction factor ($\phi=0.9$ for buckling)

F_{cr} = critical stress (ksi)

A_g = Column cross-sectional area (in²)

The critical stress of a column depends on a wide variety of factors relating to the section's properties and the member un-braced length. To reduce the number of variables to consider, the critical stress can be approximated as a function of only the gross section area.

In order to evaluate this relationship between the critical stress and gross section area, critical stresses and section areas from the 243 columns designed in the original analysis are plotted in the figure. The critical stress is calculated by dividing the required

axial strength by the column section area and the strength reduction factor. Using the required axial strength P_u , rather than the design axial strength ϕP_n , allows for the effects of eccentric loading to be accounted for when calculating the critical stress. This results in a lower critical stress than for purely axial loading.

$$F_{cr} = \frac{P_u}{\phi A_g} \tag{Equation C-3}$$

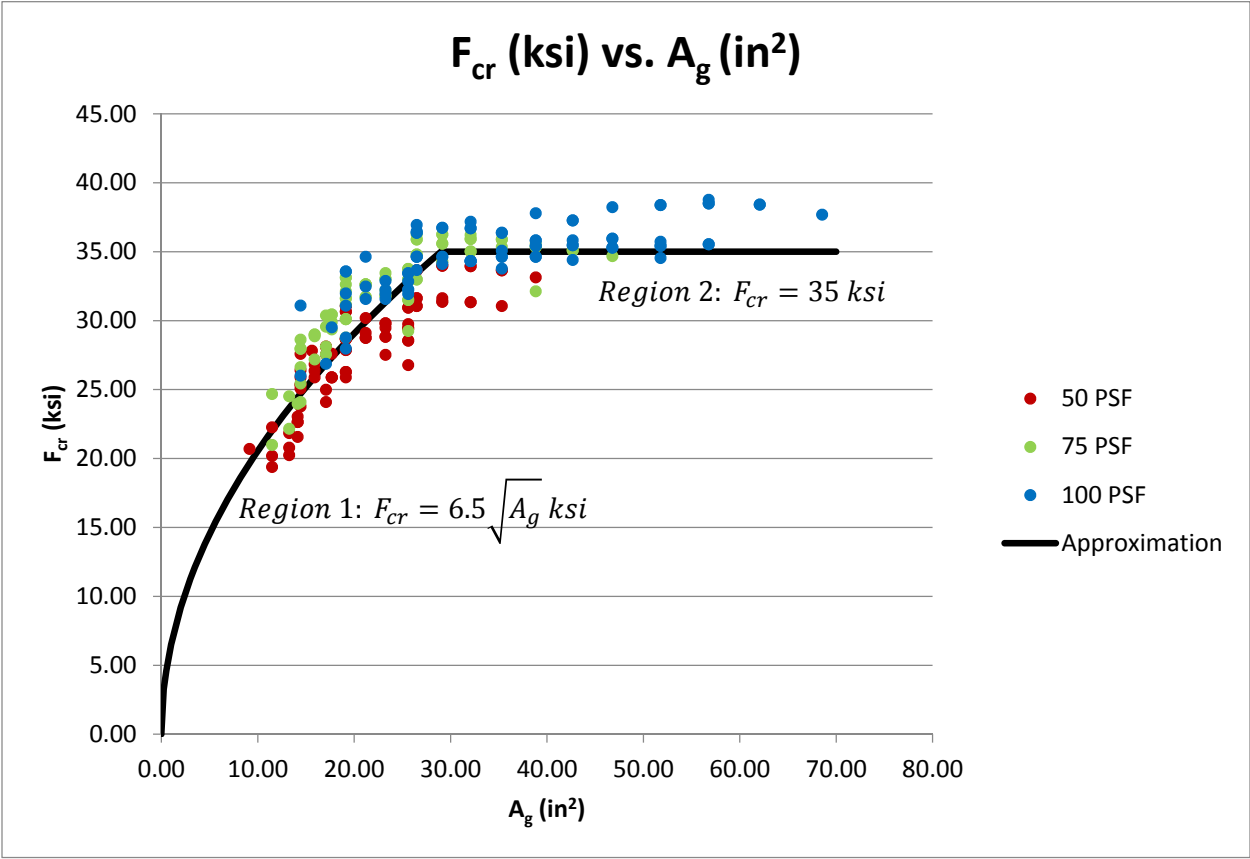

Figure 7-8: Column Stresses

The graph reveals two distinct behaviors in the relationship between critical stress and section area. For smaller column areas, a slight increase in column area produces an increase in critical stress, which suggests a positive correlation between the two. In

contrast, large columns have a relatively constant critical stress after the column area exceeds about 30 in².

The smaller columns have a higher slenderness ratio, KL/r , resulting in a lower critical stress. As the slenderness decreases for larger columns, the critical stress increases and approaches the yield stress, F_y . The yield stress is the absolute limit of the critical stress, only being reached when KL/r equals zero. Obviously, a KL/r ratio of zero cannot be reached in real columns; rather, a practical limit is encountered where the critical stress can no longer be significantly increased by increasing the column area. This practical limit in critical stress is reduced by material imperfections and the presence of eccentric loading, as a portion of the column capacity must be utilized to resist the induced bending moment rather than pure axial force.

These two regions in the critical stress graph can be approximated with the following relationship:

$$F_{cr} = 6.5 \sqrt{A_g} \leq 35 \text{ ksi} \quad \text{Equation C-4}$$

This approximation reflects the two different behaviors shown in the graph. In Region 1, the critical stress increases in proportion to the square root of the column area. This continues until the stress reaches Region 2, where the critical stress stabilizes around 35 ksi.

The critical stress of a column directly affects the required quantity of structural steel for columns. Achieving a higher critical stress decreases the required section area,

which in turn reduces the weight of the column. The relationship established above allows an estimate of required structural steel to be made.

Region 1

Substitute Equation C-5 into Equation C-2:

$$\phi P_n = \phi F_{cr} A_g \quad \text{Equation C-2}$$

$$\phi P_n = \phi \left(6.5 \sqrt{A_g} \right) A_g \quad \text{Equation C-5}$$

$$\phi P_n = 6.5 * 0.9 * A_g^{3/2} \quad \text{Equation C-6}$$

Substitute Equation C-1 for ϕP_n :

$$P_u = 5.85 A_g^{3/2} \quad \text{Equation C-7}$$

The required axial strength of the column can be expressed as the tributary area of the column multiplied by the factored floor load. The columns in region 1 are small columns that support smaller tributary areas. Because the tributary areas for these columns are small, live load reduction will be neglected; therefore:

$$P_u = q_u A_T \quad \text{Equation C-8}$$

where:

q_u = factored floor load, unreduced live load (kips/ft²)

A_T = column tributary area (ft²)

For multi-story columns with regularly-shaped bays, the tributary area of the column can be expressed as the tributary area per floor multiplied by the number of floors. For the purposes of simplifying this analysis, roofs will be treated as half of a floor to account for the lighter loads on the roof.

$$A_T = NA_f \quad \text{Equation 3-12}$$

where:

N = number of floors supported by the column (roof = 1/2 floor)

A_f = column tributary area per floor (ft²)

For rectangular bays, the floor area supported by one column is defined as the beam span multiplied by the girder span:

$$A_f = L_b L_g \quad \text{Equation C-10}$$

where:

L_b = beam span (ft)

L_g = girder span (ft)

Substitute Equation 3-12 into Equation C-8:

$$P_u = q_u A_T \quad \text{Equation C-8}$$

$$P_u = q_u (NA_f) \quad \text{Equation C-11}$$

Substitute Equation C-10 for A_f :

$$P_u = q_u N L_b L_g \quad \text{Equation C-12a}$$

$$P_u = 5.85 A_g^{3/2} \quad \text{Equation C-7}$$

$$q_u N L_b L_g = 5.85 A_g^{3/2} \quad \text{Equation C-13}$$

$$A_g^{3/2} = \frac{q_u N L_b L_g}{5.85} \quad \text{Equation C-14}$$

$$A_g = \left(\frac{q_u N L_b L_g}{5.85} \right)^{2/3} \quad \text{Equation C-15}$$

Substitute Equation C-12a for P_u in Equation C-7 and solve for A_g :

Column weight per square foot can be determined by taking the weight of a one story tall section of the column and dividing it by the bay area of one floor. This is expressed by the following equation:

$$H = \frac{Wt * h}{A_f} \quad \text{Equation 3-2}$$

where:

H = steel weight (lb/ft²)

Wt = column section weight (lb/ft)

h = floor-to-floor height (ft)

Substitute Equations C-10 into Equation 3-2:

$$H = \frac{Wt * h}{L_b L_g} \quad \text{Equation C-16}$$

Additionally, the section weight of a member equals the cross-sectional area multiplied by the specific weight of steel. This yields the following equation:

$$Wt = \frac{\gamma * A_g}{144} \quad \text{Equation C-17}$$

where:

γ = specific weight of steel (490 lb/ft³)

Substitute Equation C-17 into Equation C-12a for Wt:

$$H = \frac{Wt * h}{L_b L_g} \quad \text{Equation C-16}$$

$$H = \frac{\left(\frac{\gamma * A_g}{144}\right) * h}{L_b L_g} \quad \text{Equation C-17}$$

$$H = \frac{\left(\frac{490 * A_g}{144}\right) * h}{L_b L_g} \quad \text{Equation C-18}$$

$$H = \frac{3.4 A_g * h}{L_b L_g} \quad \text{Equation C-19}$$

Substitute the formula for A_g in Equation C-15 into Equation C-19 and simplify:

$$H = \frac{3.4 A_g * h}{L_b L_g} \quad \text{Equation C-19}$$

$$H = \frac{3.4 * \left(\frac{q_u N L_b L_g}{5.85}\right)^{2/3} * h}{L_b L_g} \quad \text{Equation C-20}$$

$$H = \frac{3.4 * \left(\frac{q_u N L_b L_g}{5.85}\right)^{2/3} * h}{(L_b L_g)^{3/3}} \quad \text{Equation C-21}$$

$$H = \frac{3.4 * \left(\frac{q_u N}{5.85}\right)^{2/3} * h}{(L_b L_g)^{1/3}} \quad \text{Equation C-22}$$

$$H = \frac{3.4 * 0.308 * (q_u N)^{2/3} * h}{(L_b L_g)^{1/3}} \quad \text{Equation C-23}$$

$$H = 1.05 * h * \sqrt[3]{\frac{q_u^2 N^2}{L_b L_g}} \approx h * \sqrt[3]{\frac{q_u^2 N^2}{L_b L_g}} \quad \text{Equation C-24}$$

$$H = h * \sqrt[3]{\frac{q_u^2 N^2}{L_b L_g}} \quad \text{Equation C-25a}$$

Although this equation is somewhat complicated, it manages to create a method of determine the column steel weight without directly designing the column. Column design typically requires information about the following parameters: column height (L), weak-axis radius of gyration (r_y), end fixity factor (k), column gross area (A_g). Both r_y and A_g are section properties, and both of these values affect the critical stress of the column. This results in an iterative design process.

This equation is a function of the following parameters: story height (h), factored floor load (q_u), the number of stories (N), and the dimensions of a typical bay (L_b and L_g). None of these parameters are section properties of the column, which allows the steel weight to be estimated before the structure is designed.

Region 2

$$\phi P_n = \phi F_{cr} A_g \quad \text{Equation C-2}$$

$$\phi P_n = 0.9 * 35 * A_g \quad \text{Equation C-26}$$

Substitute Equation C-1 for ϕP_n :

$$P_u = 31.5 A_g \quad \text{Equation C-27}$$

The required axial capacity P_u can be expressed with an equation similar Equation C-12a. In contrast to the columns in the previous case, columns in this case typically have large tributary areas where live loads can be reduced by the code maximums. This corresponds to the following equation:

$$P_u = q_{ur} N L_b L_g \quad \text{Equation C-12b}$$

q_{ur} = factored floor load, fully-reduced live load (kips/ft²)

Substitute Equation C-12b for P_u into Equation C-27:

$$P_u = 31.5 A_g \quad \text{Equation C-27}$$

$$q_{ur} N L_b L_g = 31.5 A_g \quad \text{Equation C-28}$$

Solve for A_g :

$$A_g = \frac{q_{ur} N L_b L_g}{31.5} \quad \text{Equation C-29}$$

Substitute Equation C-29 for A_g into Equation C-30:

$$H = \frac{3.4A_g * h}{L_bL_g} \quad \text{Equation C-30}$$

$$H = \frac{3.4 * \left(\frac{q_{ur}NL_bL_g}{31.5}\right) * h}{L_bL_g} \quad \text{Equation C-31}$$

$$H = \frac{Nq_{ur}h}{9} \quad \text{Equation C-25b}$$

Like the previous equation, this is not a function of any column section properties. The equation is a function of the story height (h), factored floor load (q_u), and the number of stories (N). None of these parameters are section properties of the column, which allows the steel weight to be estimated without the design and selection of a column member.

Results

The following two equations produce estimated column steel weights per square foot that correspond to the two states of behavior observed from the graph above.

$$H = h * \sqrt[3]{\frac{q_u^2 N^2}{L_bL_g}} \quad \text{Equation C-25a}$$

$$H = \frac{Nq_{ur}h}{9} \quad \text{Equation C-25b}$$

Conclusion

For Region 2, column steel weight per square foot is directly proportional to the number of supported floors, imposed floor load, and story height. Column weight is

independent of bay size in this equation, indicating that for very large bays no significant weight savings occurs from further increasing the bay size.

The results of this equation are fairly intuitive. It would be expected that the column steel weight would increase directly in proportion to the number of supported floors. Each floor increases the required axial capacity of the column, which means that a heavier section must be used. This reasoning extends to the relationship between column steel weight and the factored floor load. The fact that column steel weight is directly proportional to the building's story height is also reasonable. For a higher story height, a longer column is required to span that height, which requires more steel.

For Region 1, column weights per square foot is a more complicated function of story height, number of stories, imposed floor loads, and bay area. Similar to the other equation, steel weight is directly proportional to the story height. This results from the definition of the column weight per square foot used in Equation C-25a.

Column weights are also directly proportional to the square root of the number of supported floors. This relationship is likely valid only for a small number of stories. For a large number of supported floors, the columns would likely be governed by inelastic buckling, at which point the steel weight would be directly proportional to the number of supported stories in accordance with Equation C-25b.

One interesting result of this equation is that column steel weight is directly proportional to the cube root of the square of the imposed floor load. This means that an increase in floor loads of 50% will result in a steel weight increase of only 30% for columns with small tributary areas. A related result is that the column steel weight is inversely

proportional to the cube root of the bay size. By this relationship, doubling the bay area would actually reduce the column steel weight per square foot by roughly 30%.

The cube root in this equation is significant, and originates from the fact that the critical stress was approximated as being proportional to the square root of the section area. Because of this, the section area contributes in two ways to the strength of the column. Not only does an increase in area contribute to the column strength by increasing the amount of material to carry load, but also by increasing the critical stress of the section. As the required axial strength of the column increases, the column requires a section with a larger area; however, due to the double effect that the section area provides to the column strength, the section area (and by extension the section weight) does not increase linearly with the required axial load.

While these equations constitute power design aides for engineers, they are formulated using a series of assumptions and approximations, and as such, have limitations to their use. It is important to note that these equations consider eccentrically applied loads. Eccentrically applied loads have the potential to considerably decrease the axial capacity of columns, resulting in an increase in column steel weights. Although the eccentricities used in the analysis are within the typical range for simple beam-to-column connections, they may not be appropriate for all cases or connection types.

Perhaps the most important consideration regarding these formulas is that the final results treat the story height as a variable despite it being kept constant at 15 feet during the original analysis. The story height constitutes the un-braced length of the column, which has a substantial impact on the strength of a column by means of the KL/r ratio. Consequently, these equations are most accurate when used with buildings that have story

heights around 15 feet, which is not uncommon for many types of buildings. Nevertheless, these equations likely require some modification in order to accommodate very short or very tall story heights.

The final consideration is that these equations were formulated around the properties of A992 W-shape column sections. These equations cannot be used for columns of different steel grades, such as A36, or different section types, such as circular or rectangular hollow structural sections; however, it is possible to reformulate these equations based on different section properties, likely resulting in similar relationships. Additionally, these equations were formulated for regularly-shaped, rectangular bays and floor loads and framing layouts that are common to all supported floors. Situations with irregular bays or loads that vary between floors will not be accurately represented by these equations.

Appendix D - Steel Weight Graphs

Beams

Non-Composite

50 PSF

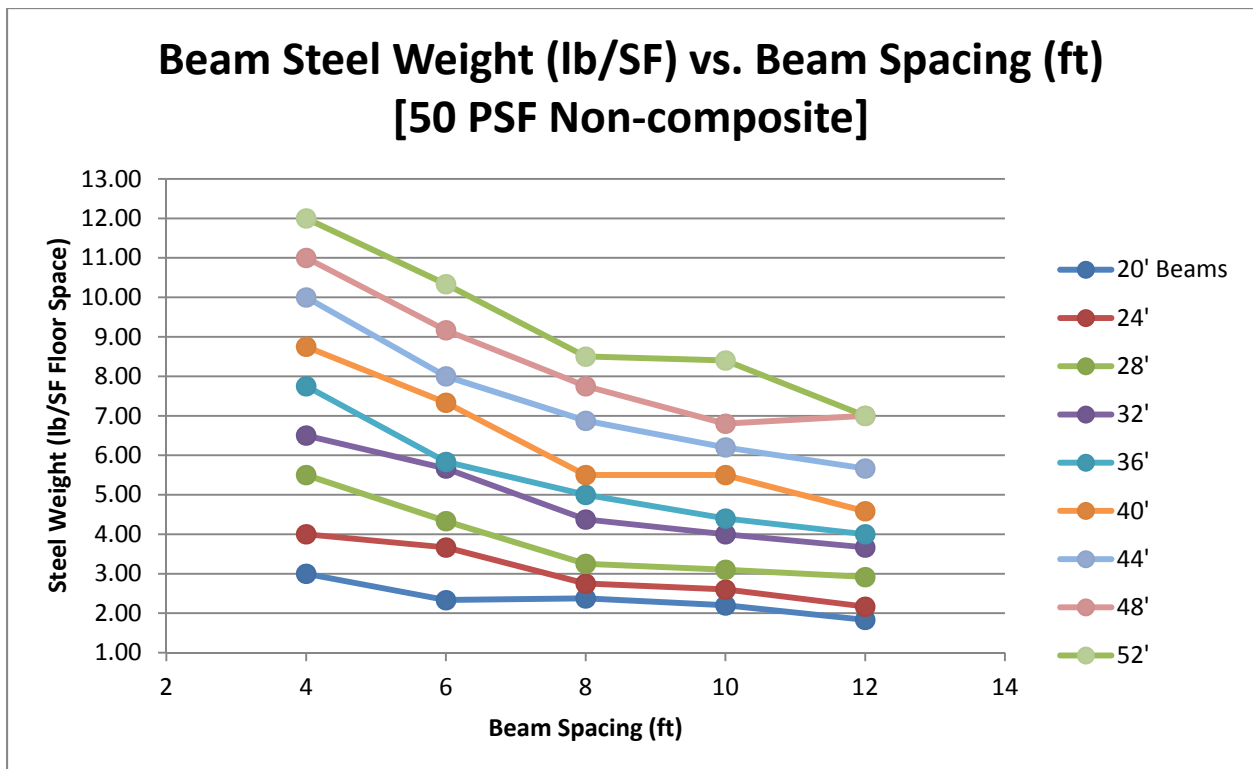
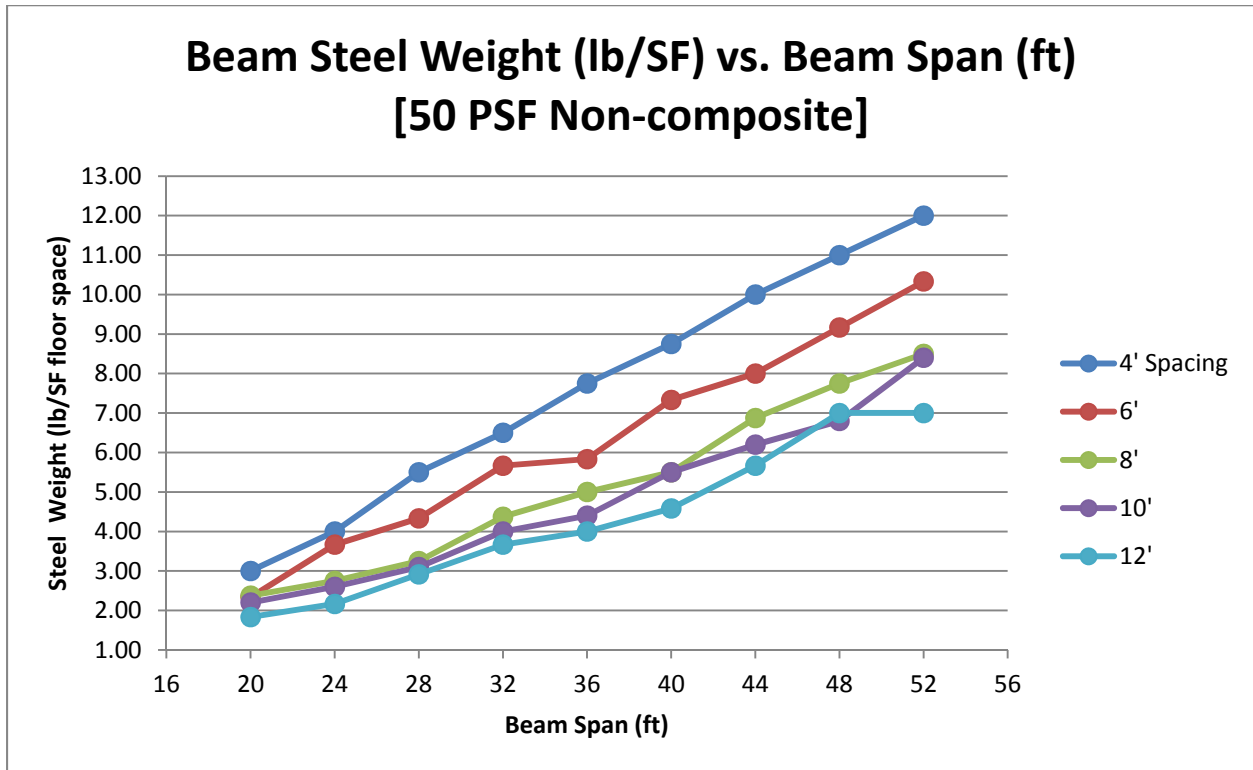

Beam Weight (lb/SF) vs. Beam Spacing (ft) [50 PSF Non-composite]

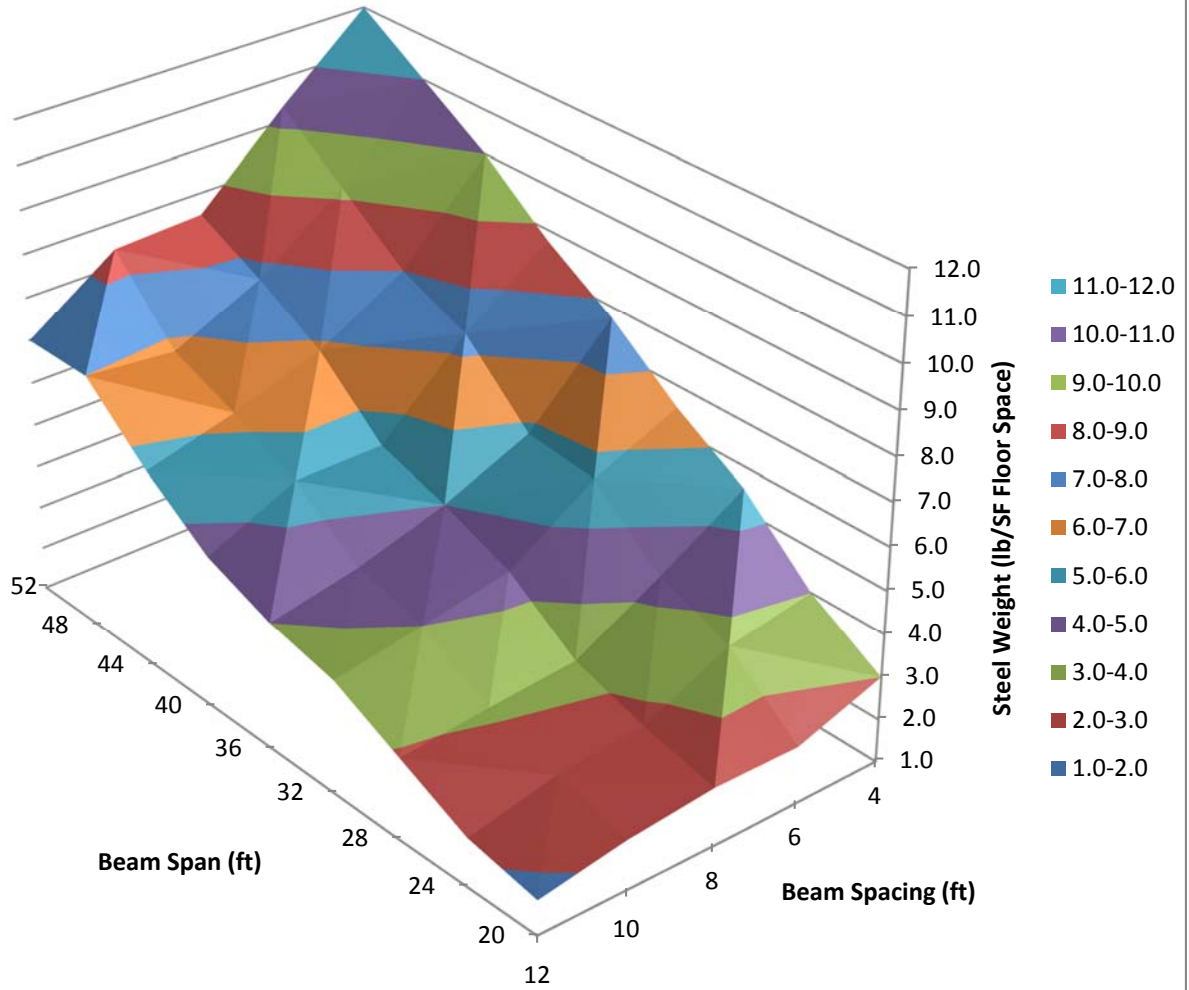

Girders

Non-Composite

50 PSF

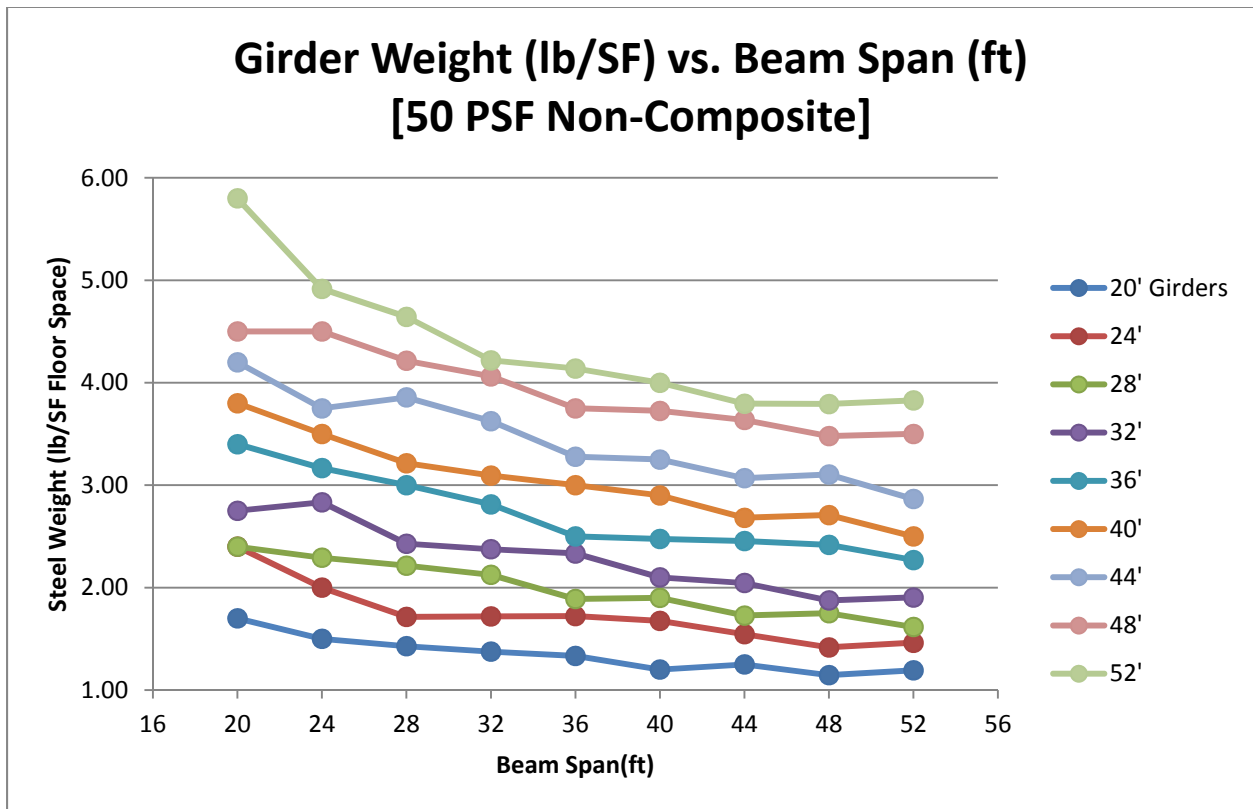
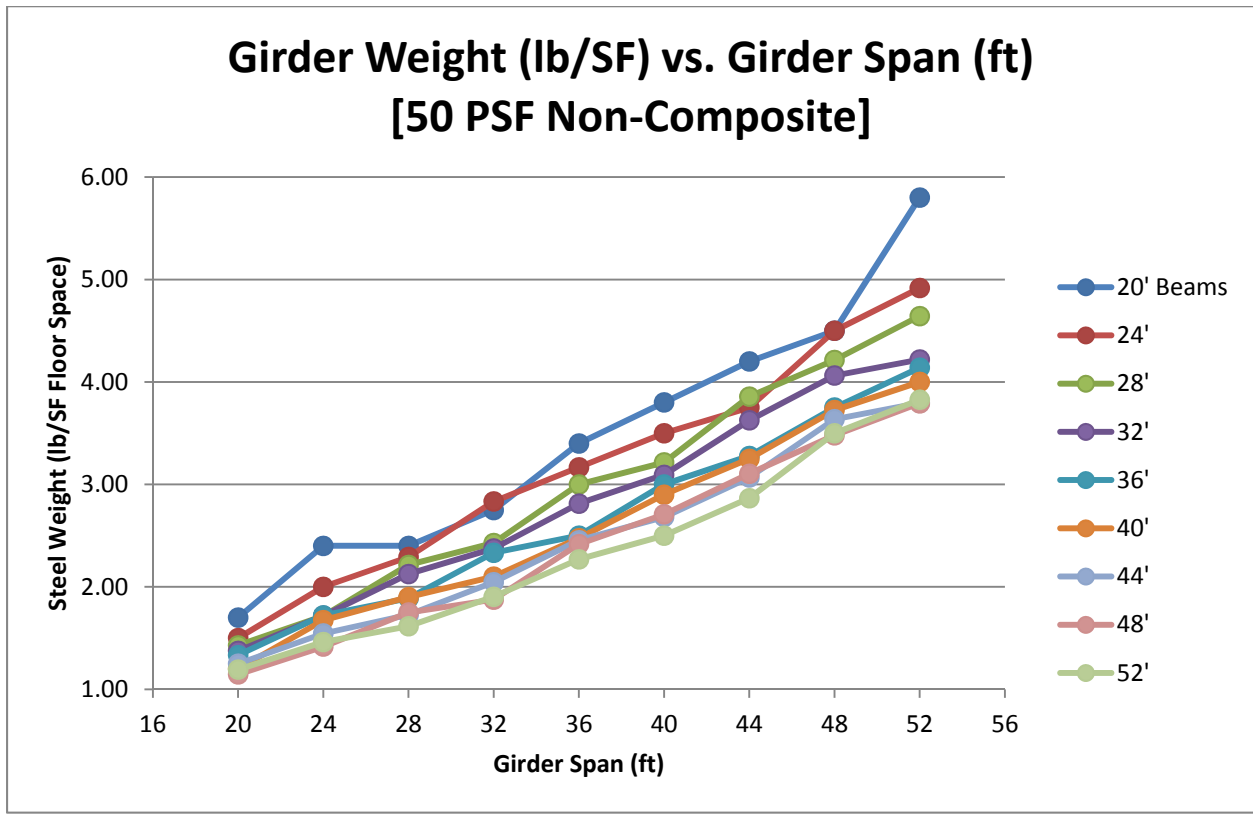

Girder Weight (lb/SF) vs. Bay Size (ft) [50 PSF Non-composite]

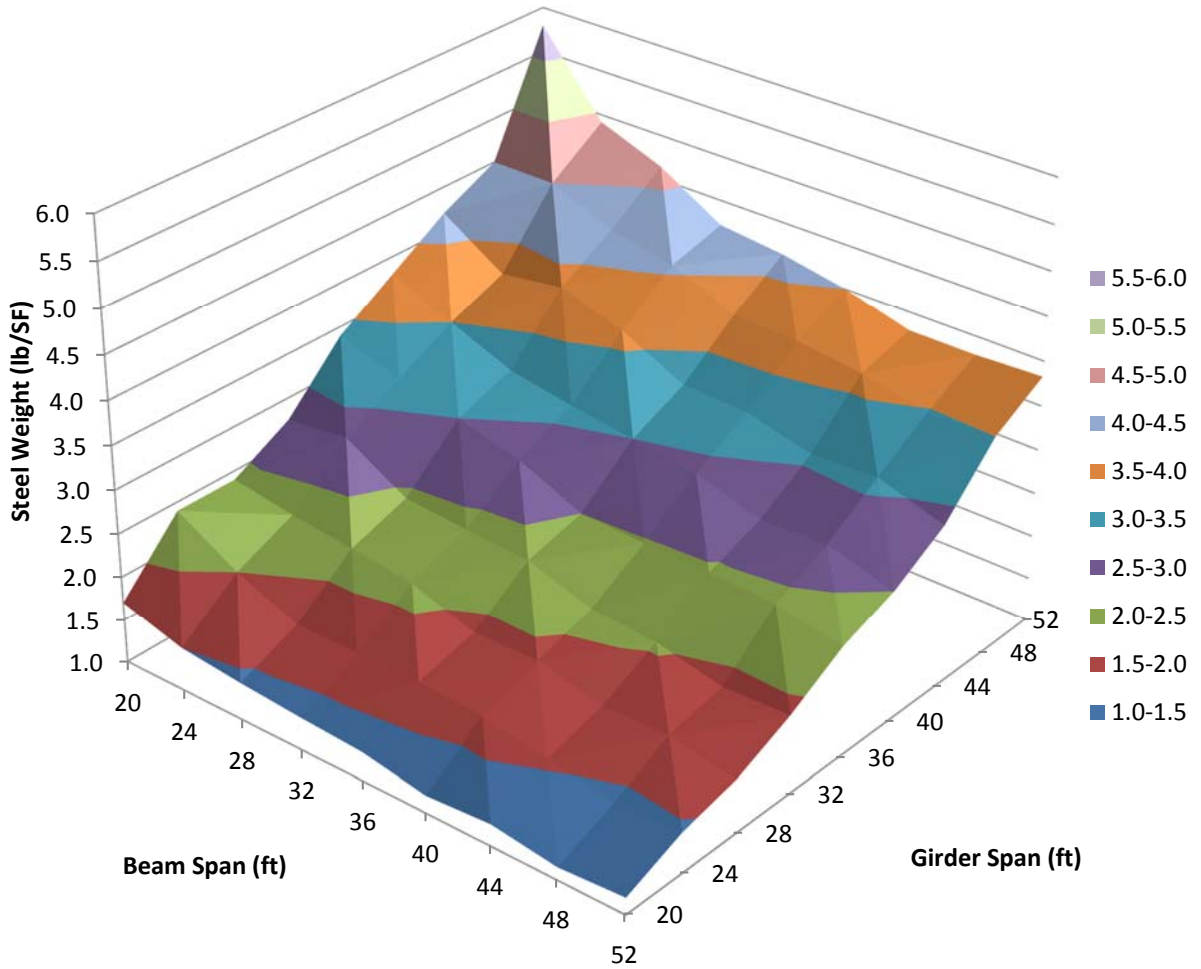

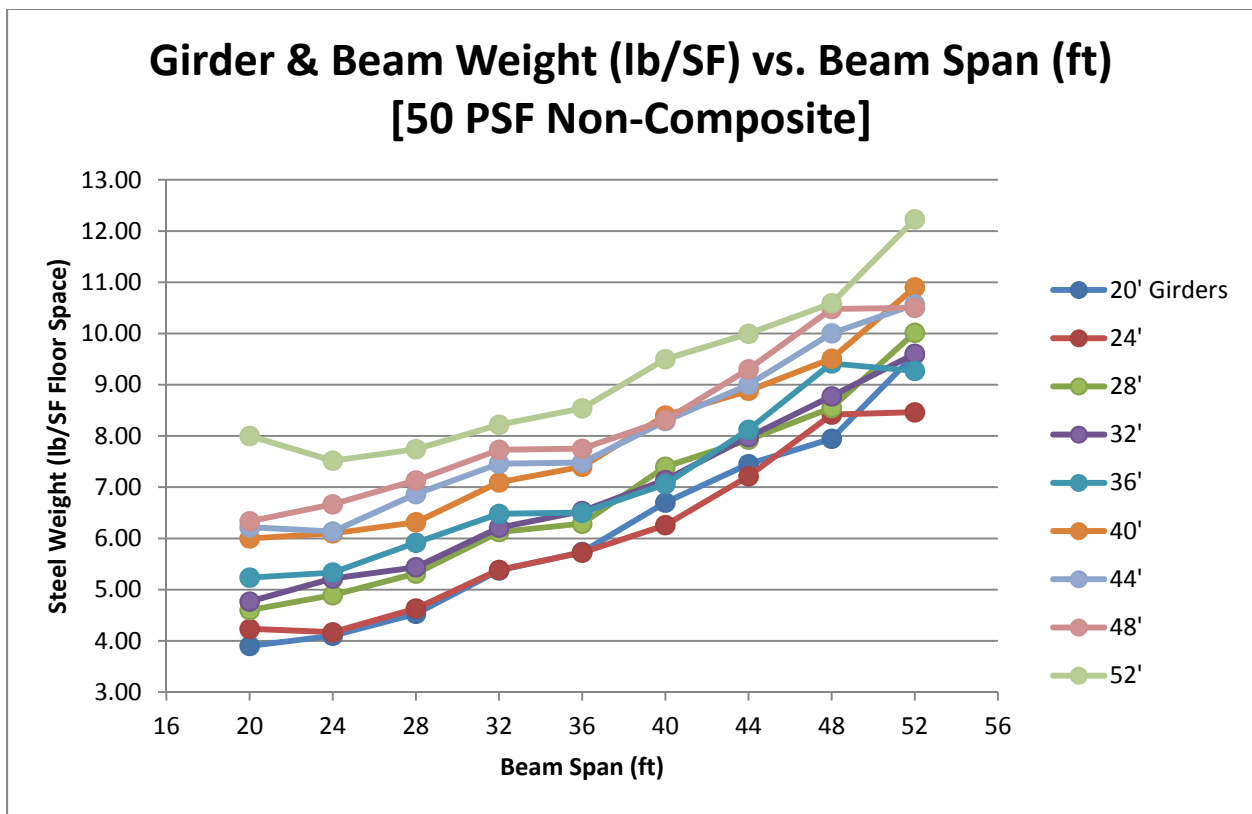
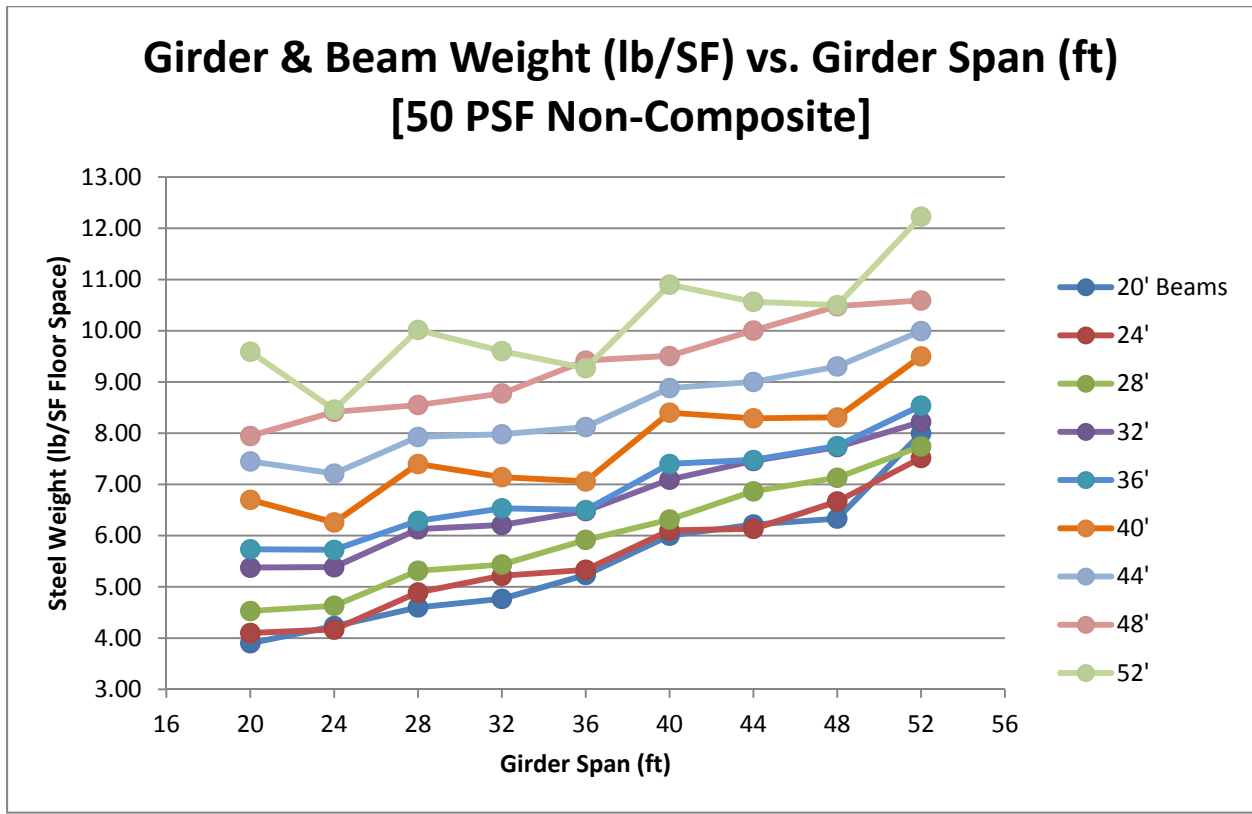

Beam & Girder Weight (lb/SF) vs. Bay Size (ft) [50 PSF Non-Composite]

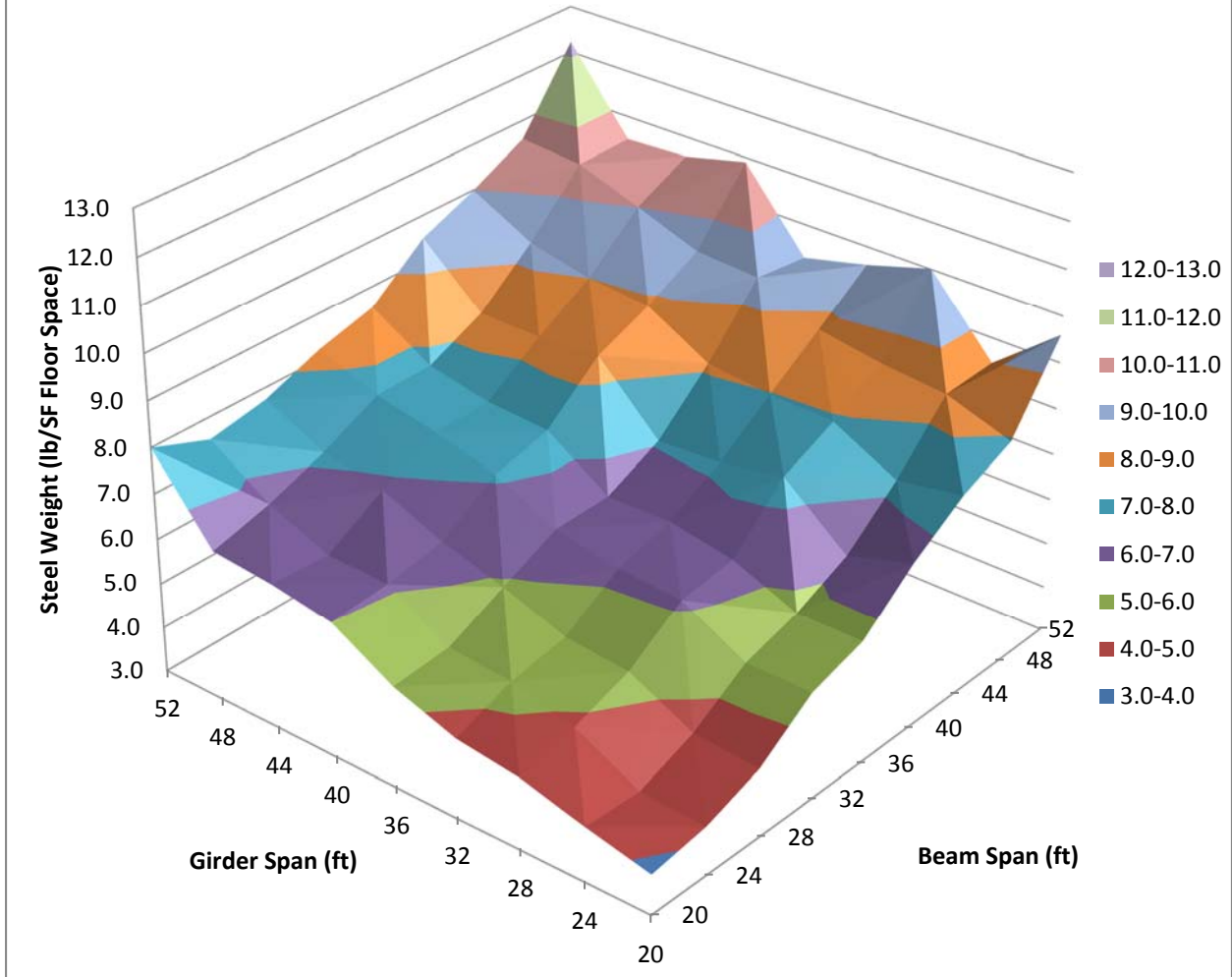

Columns

Non-Composite

50 PSF

Column Weight (lb/SF) vs. Girder Span (ft) [50 PSF Non-Composite]

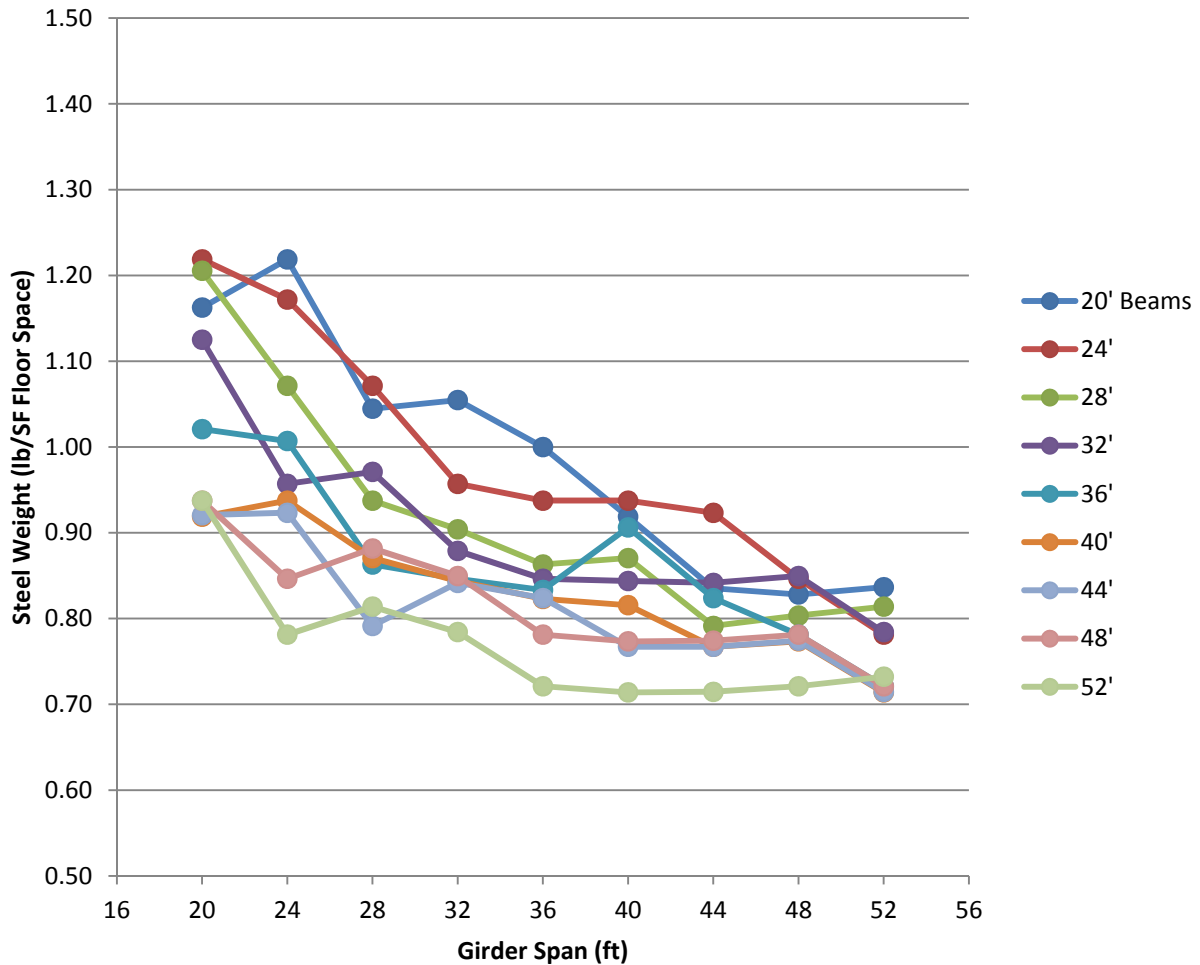

Total

Non-Composite

50 PSF

Total Steel Weight (lb/SF) vs. Beam Span (ft) [50 PSF Non-Composite]

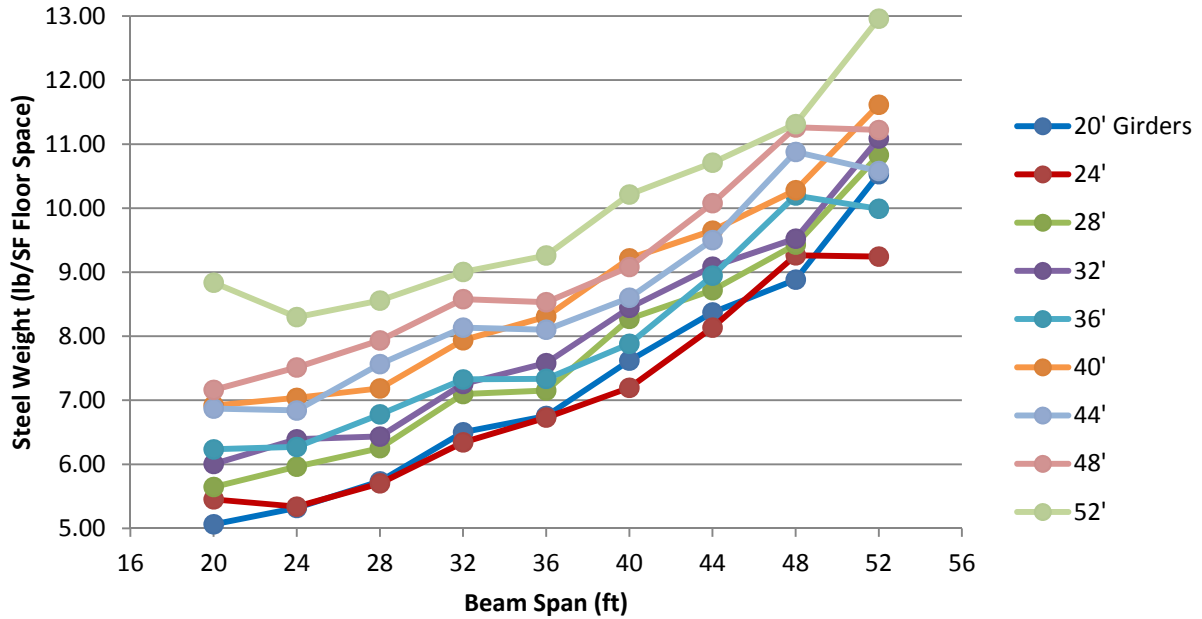

Total Steel Weight (lb/SF) vs. Girder Span (ft) [50 PSF Non-Composite]

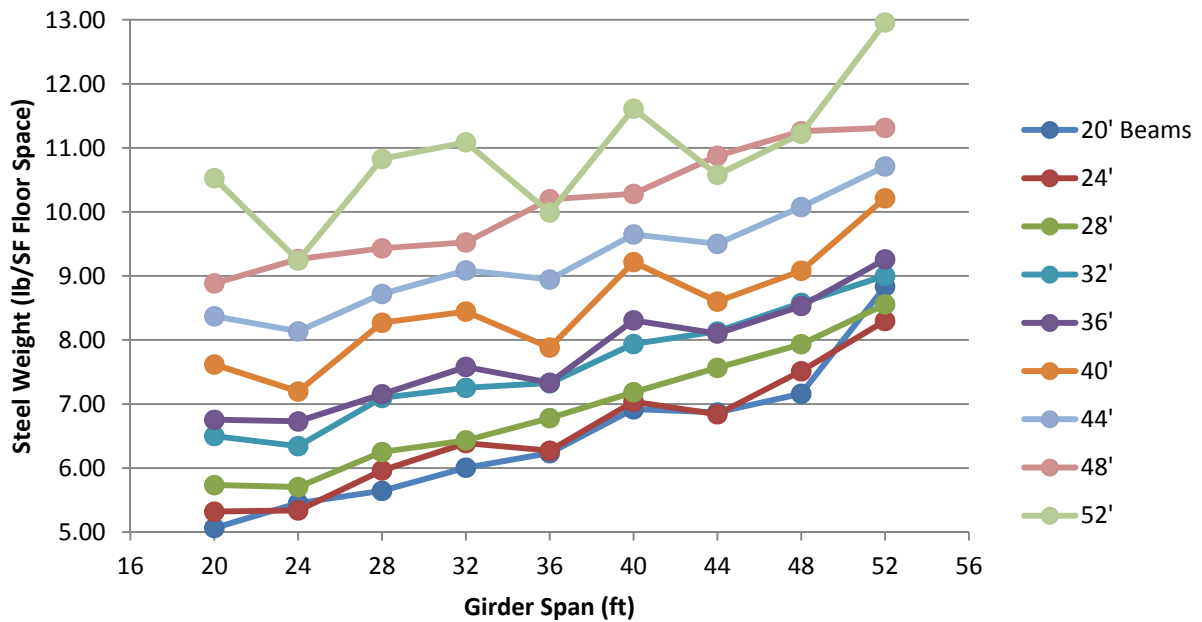

Total Weight (lb/SF) vs. Bay Size (ft) [50 PSF Non-composite]

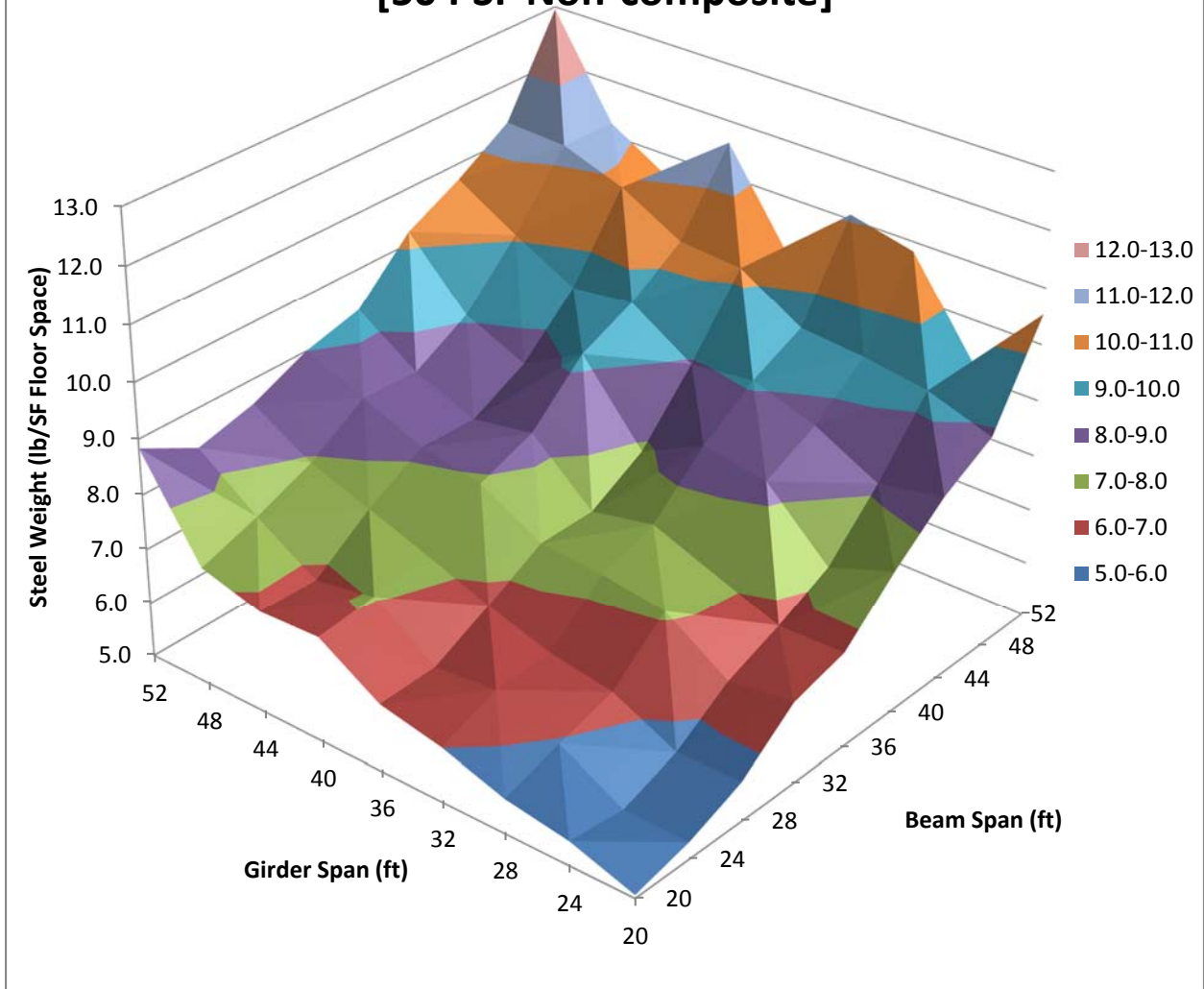

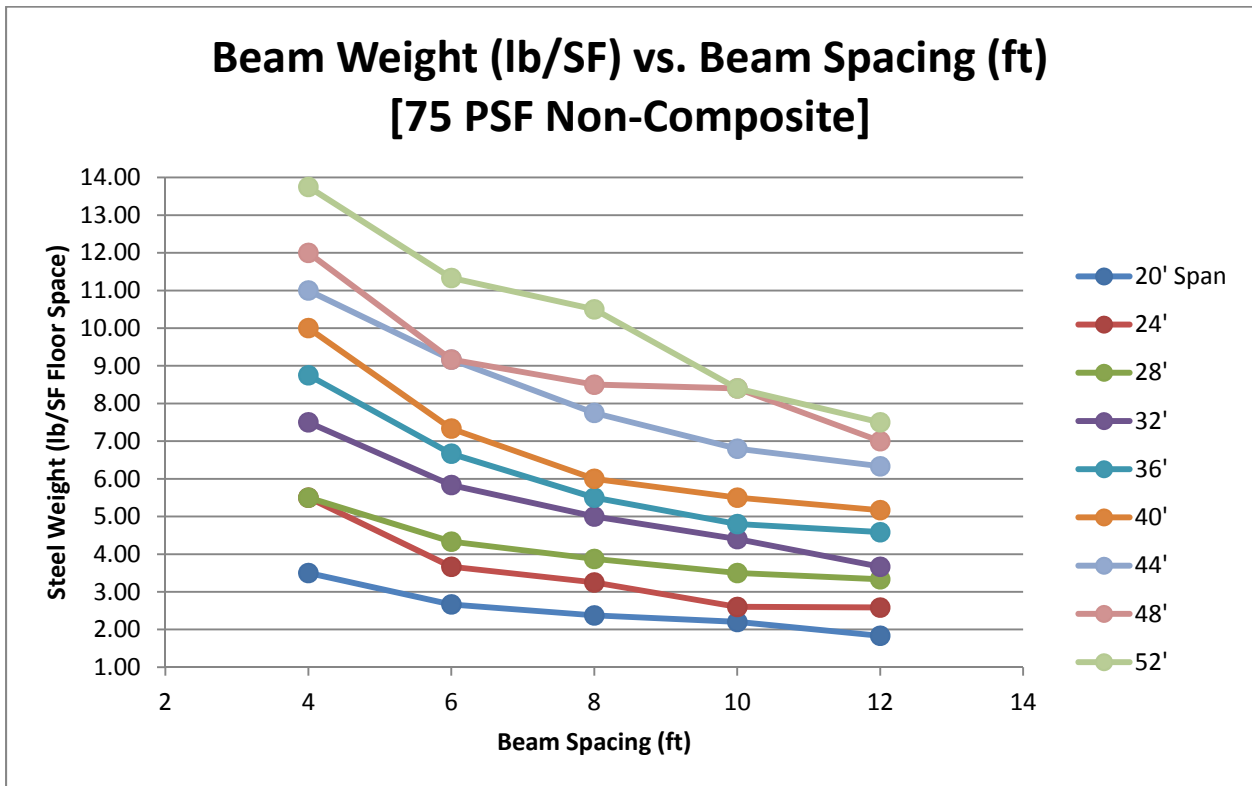
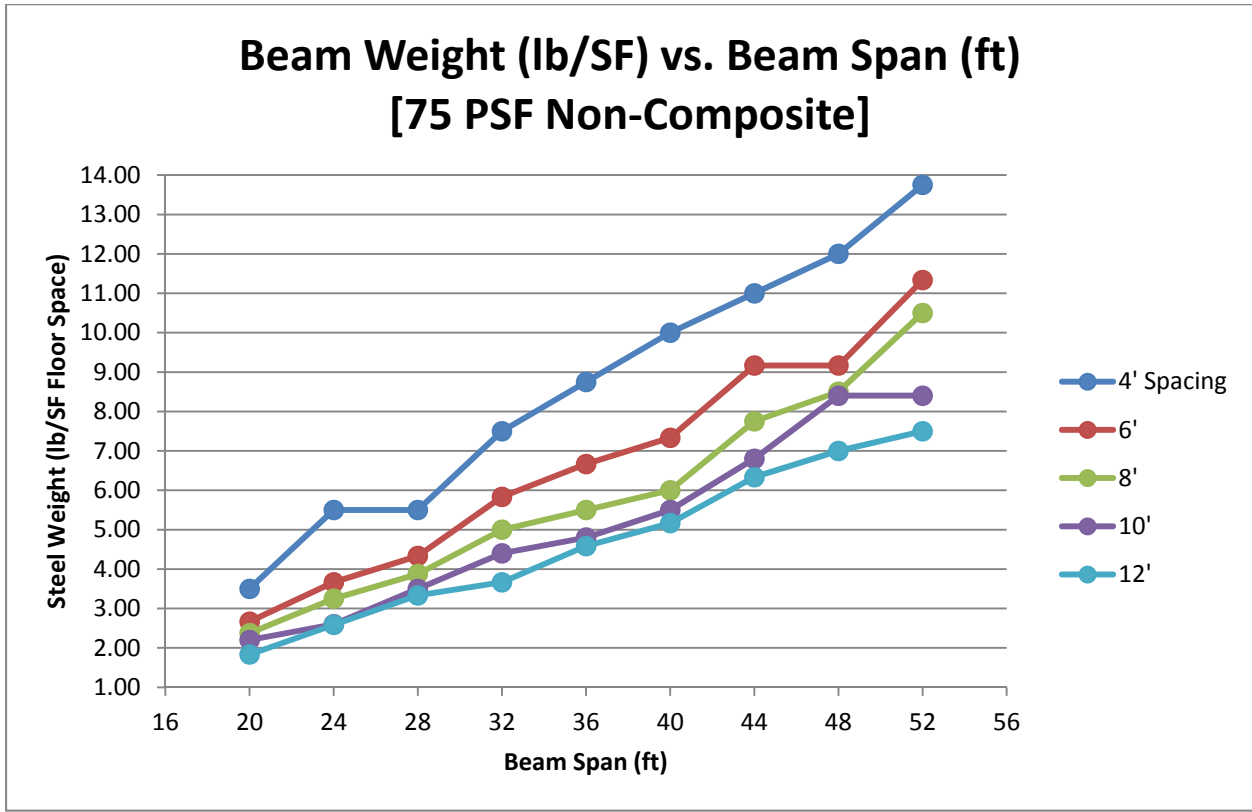

Beam Weight (lb/SF) vs. Beam Spacing (ft) [75 PSF Non-composite]

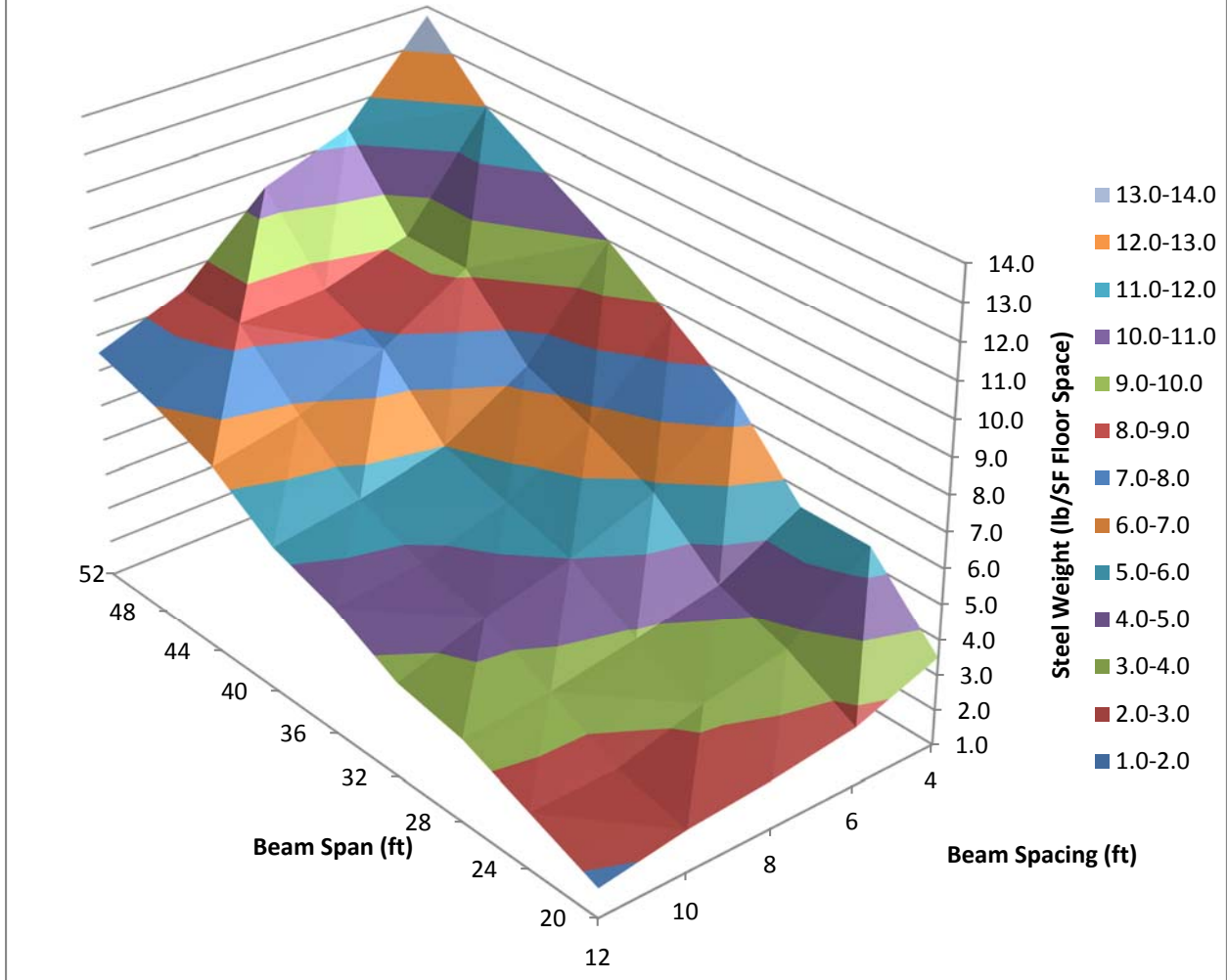

Girders

Non-Composite

75 PSF

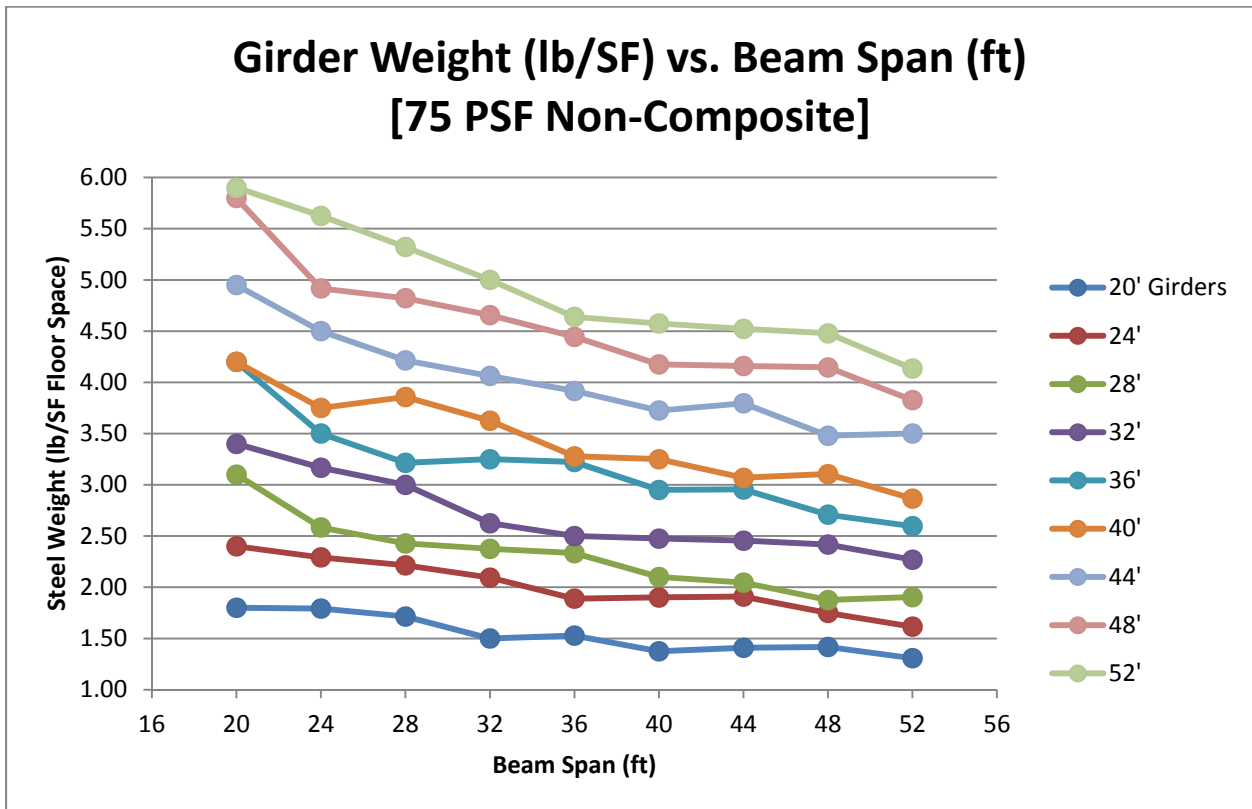
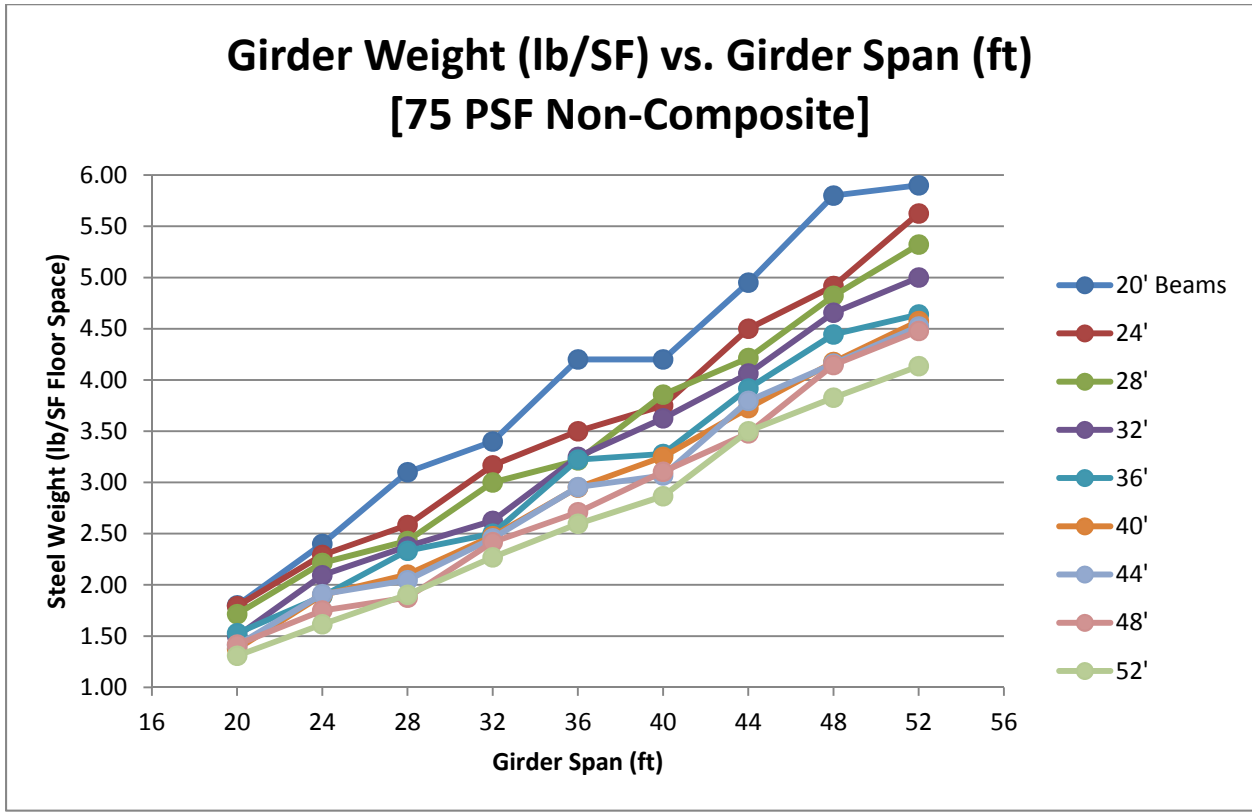

Girder Weight (lb/SF) vs. Bay Size (ft) [75 PSF Non-Composite]

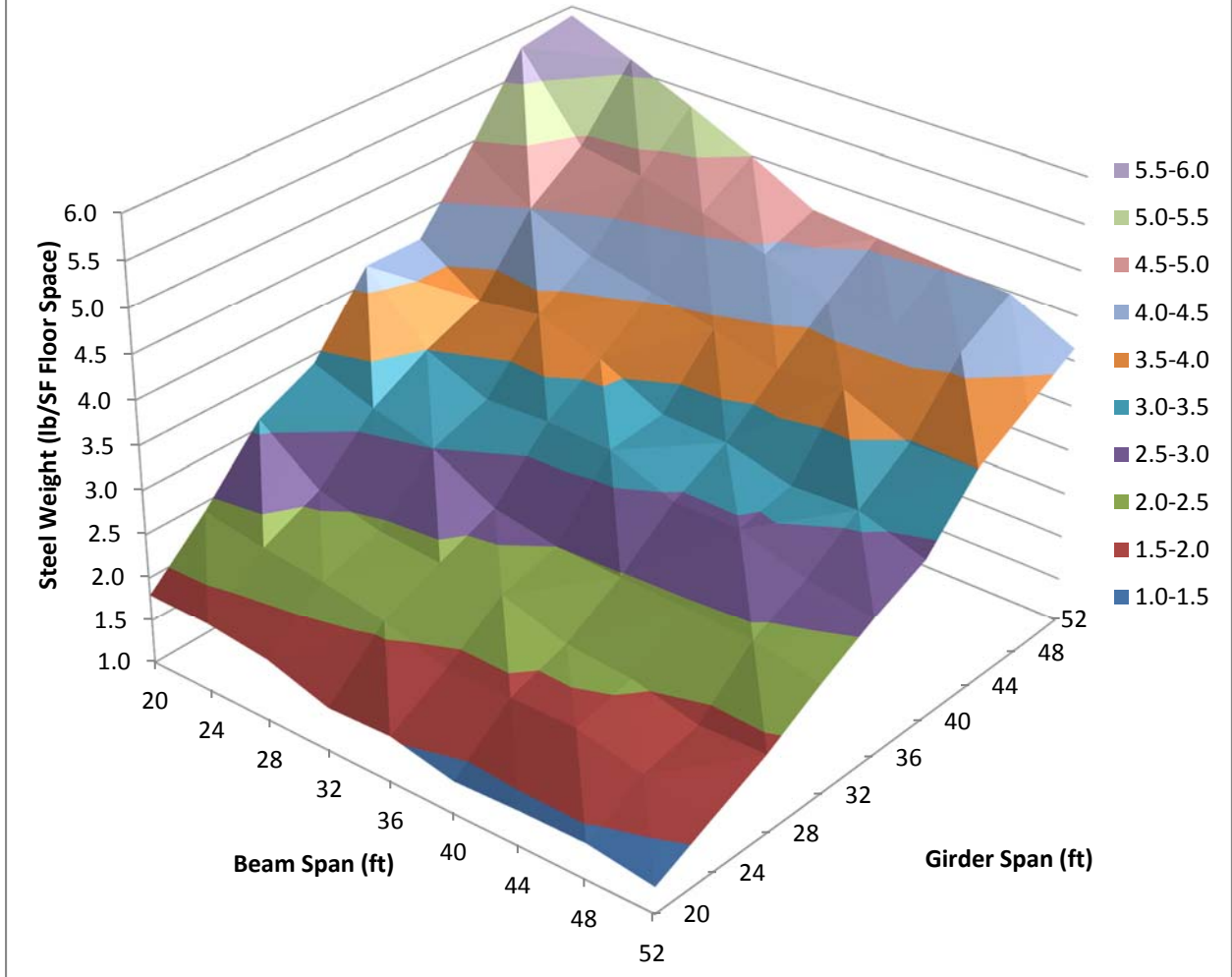

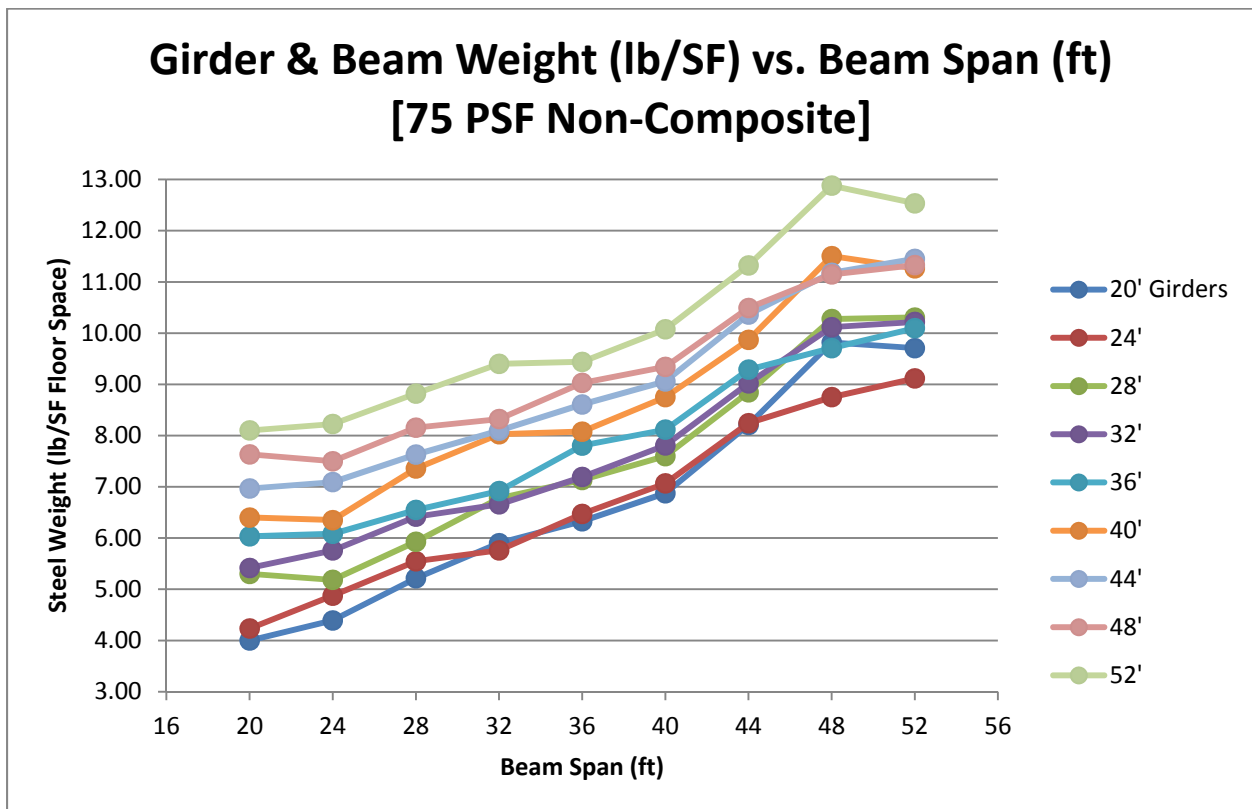
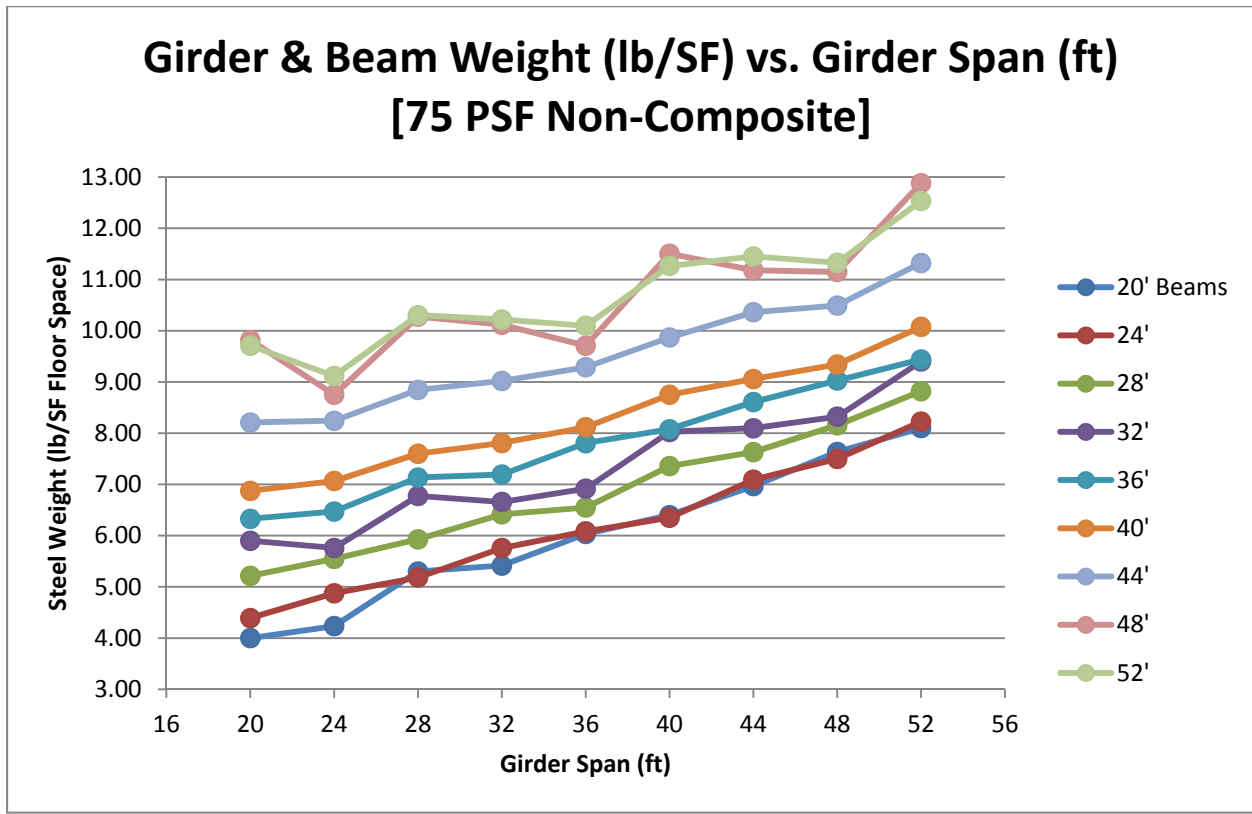

Girder & Beam Weight (lb/SF) vs. Bay Size (ft) [75 PSF Non-Composite]

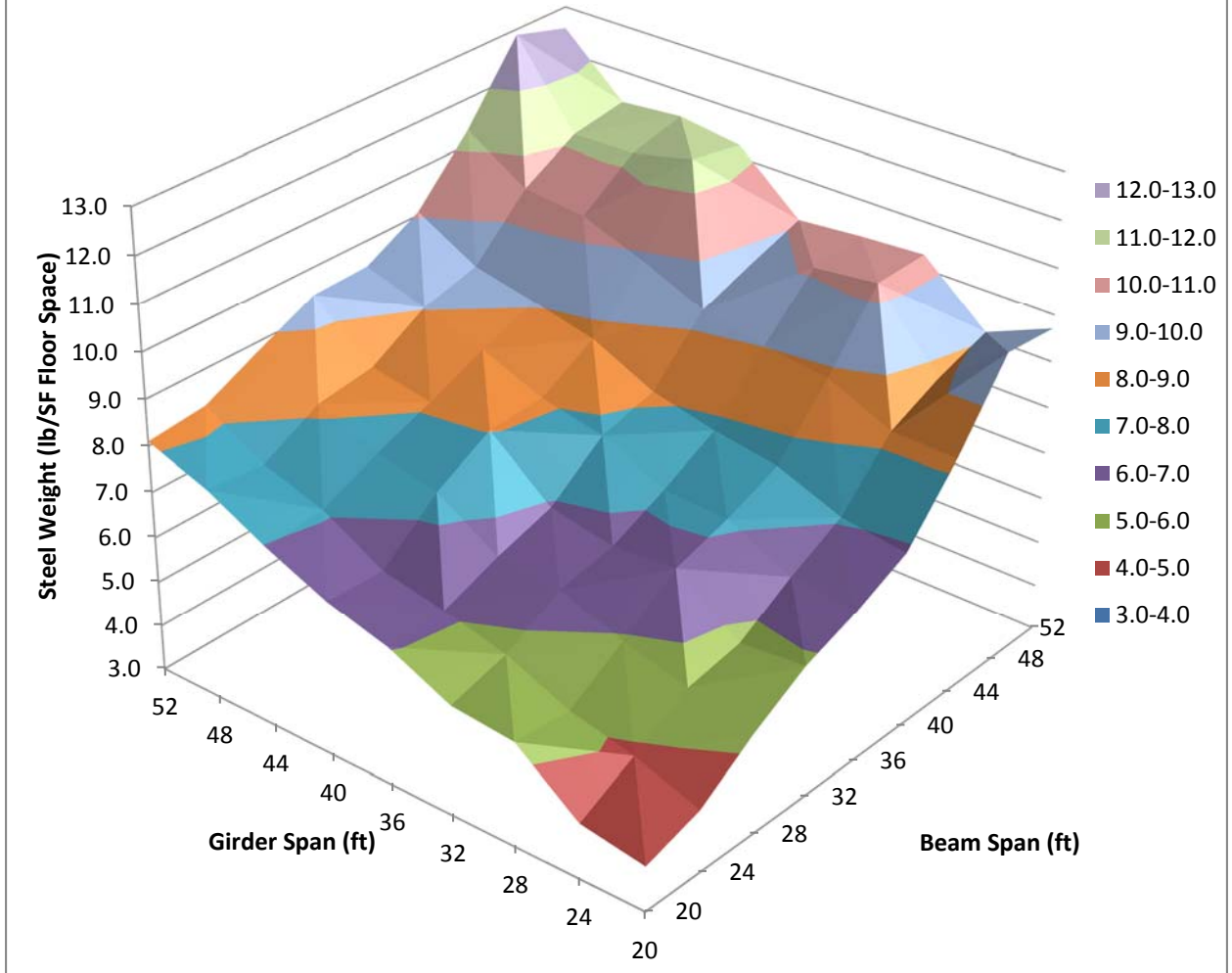

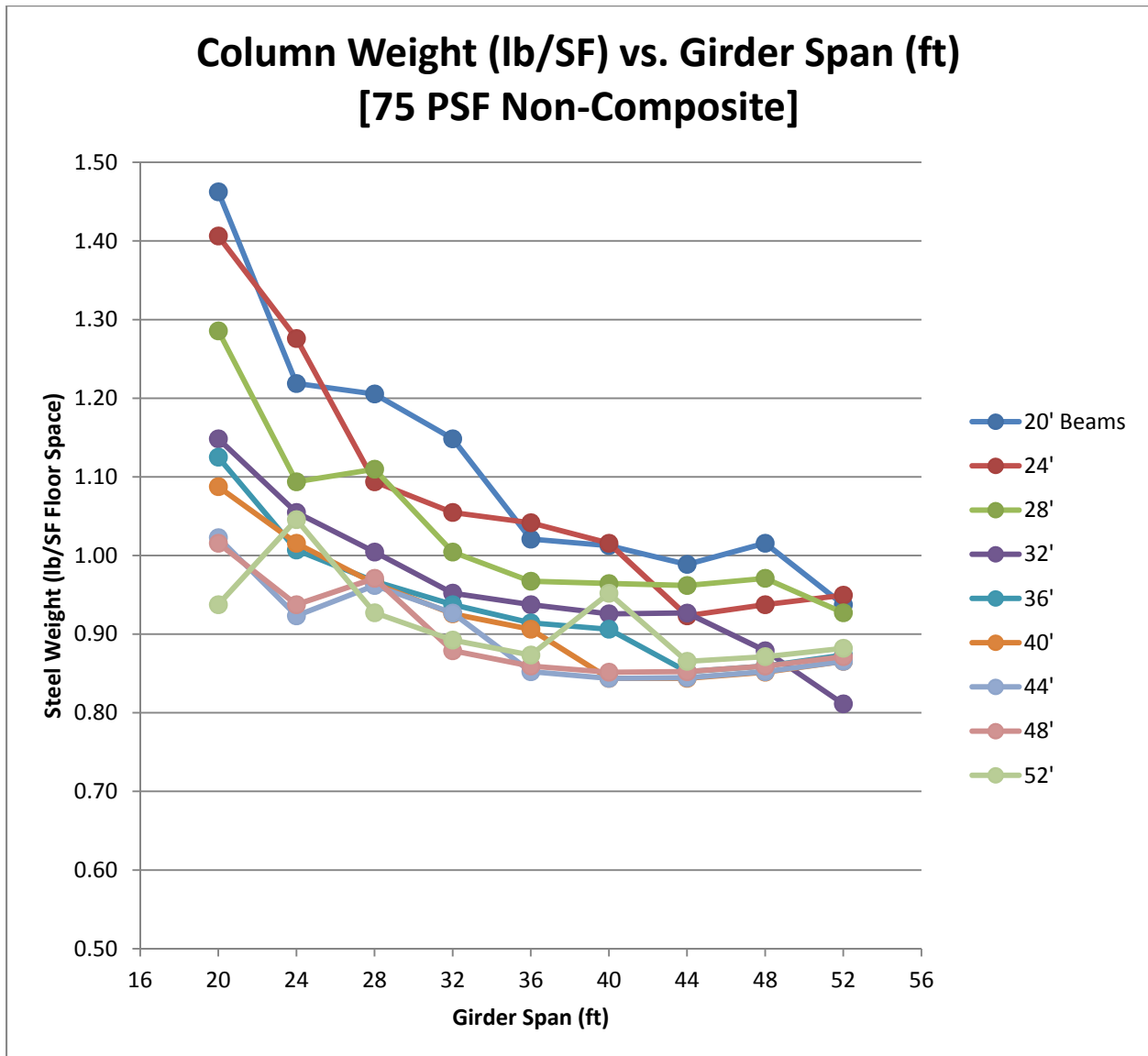

Total

Non-Composite

75 PSF

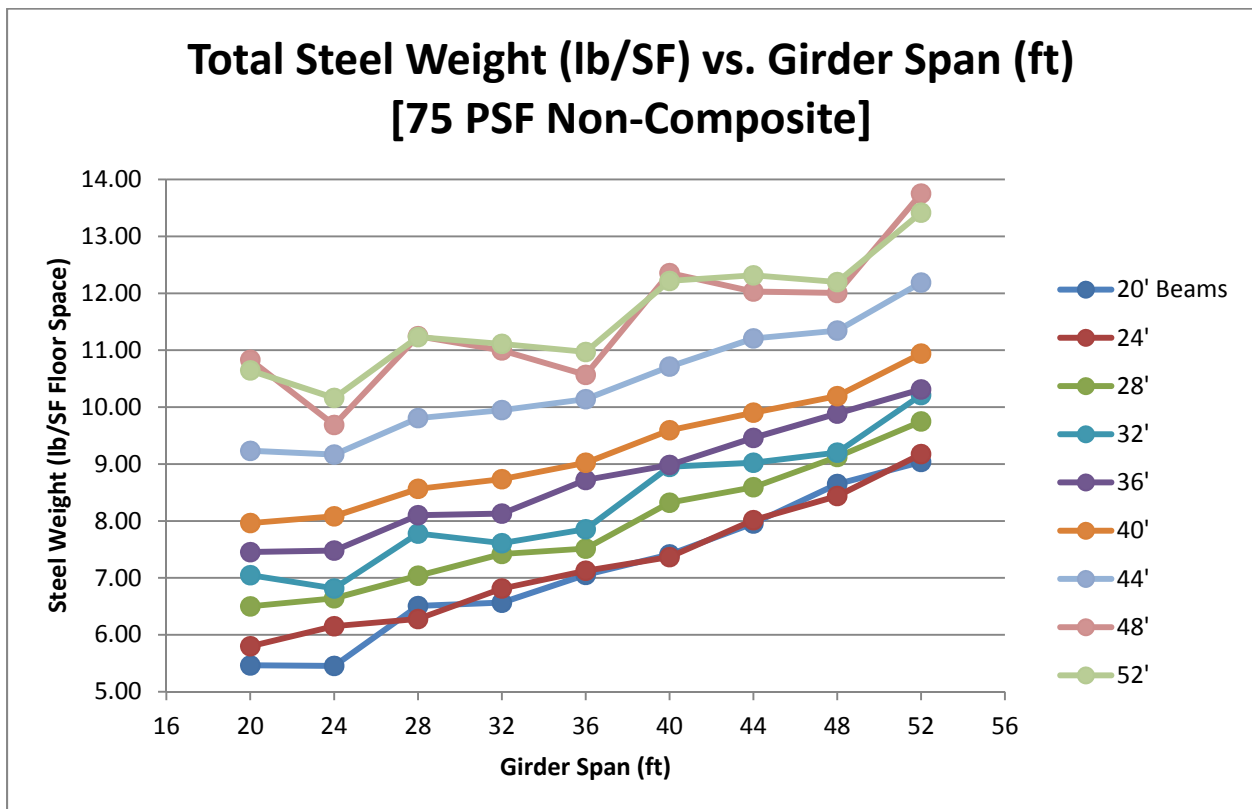
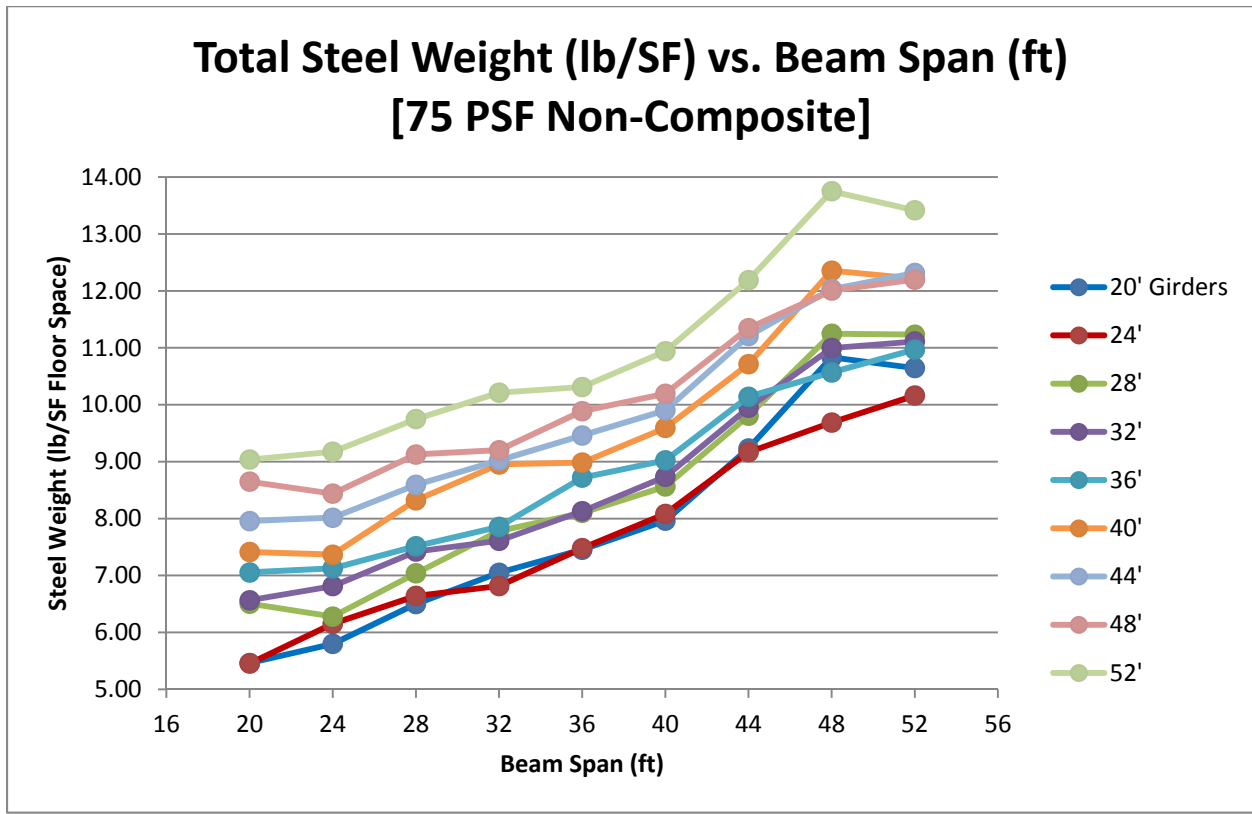

Total Steel Weight (lb/SF) vs. Bay Size (ft) [75 PSF Non-composite]

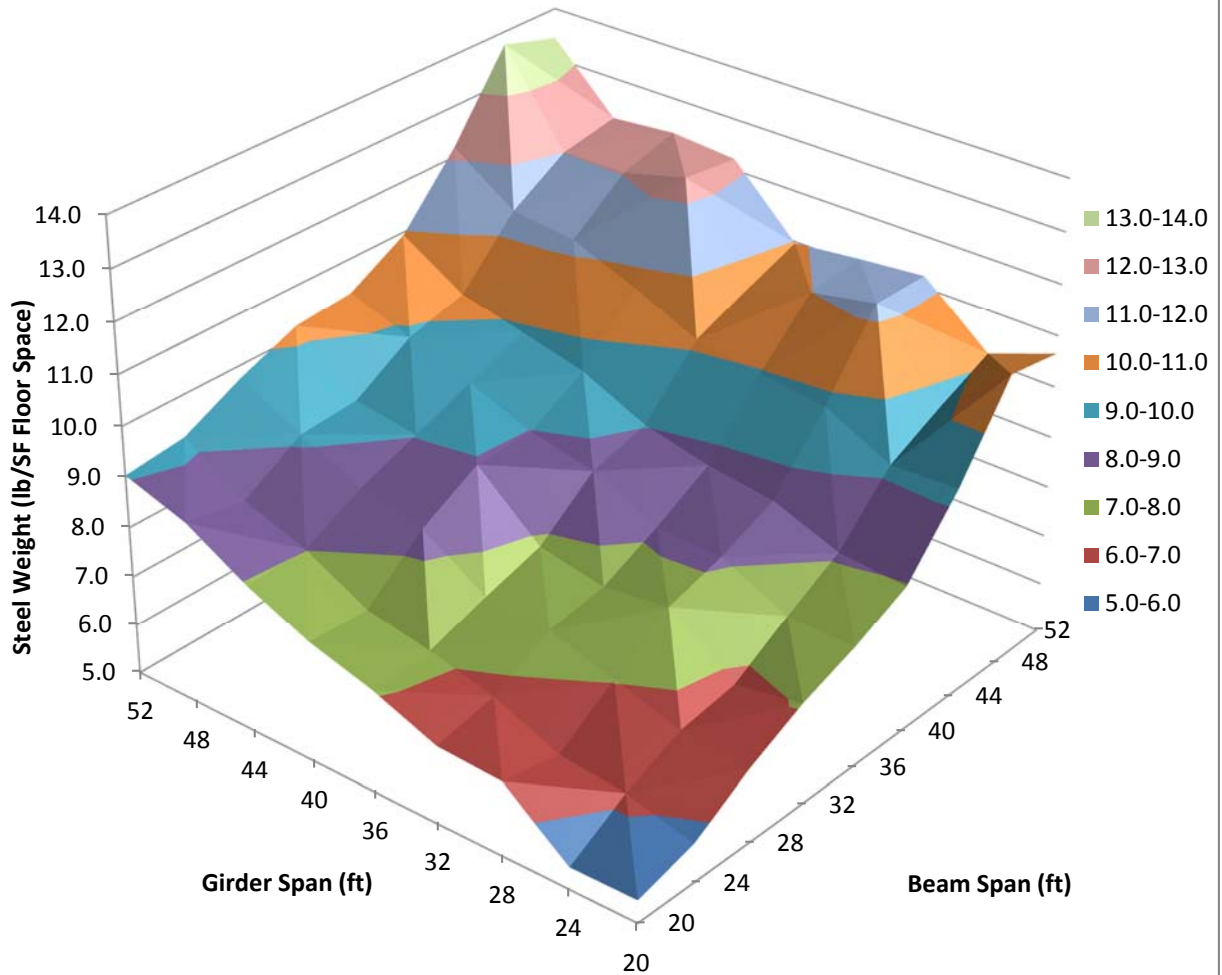

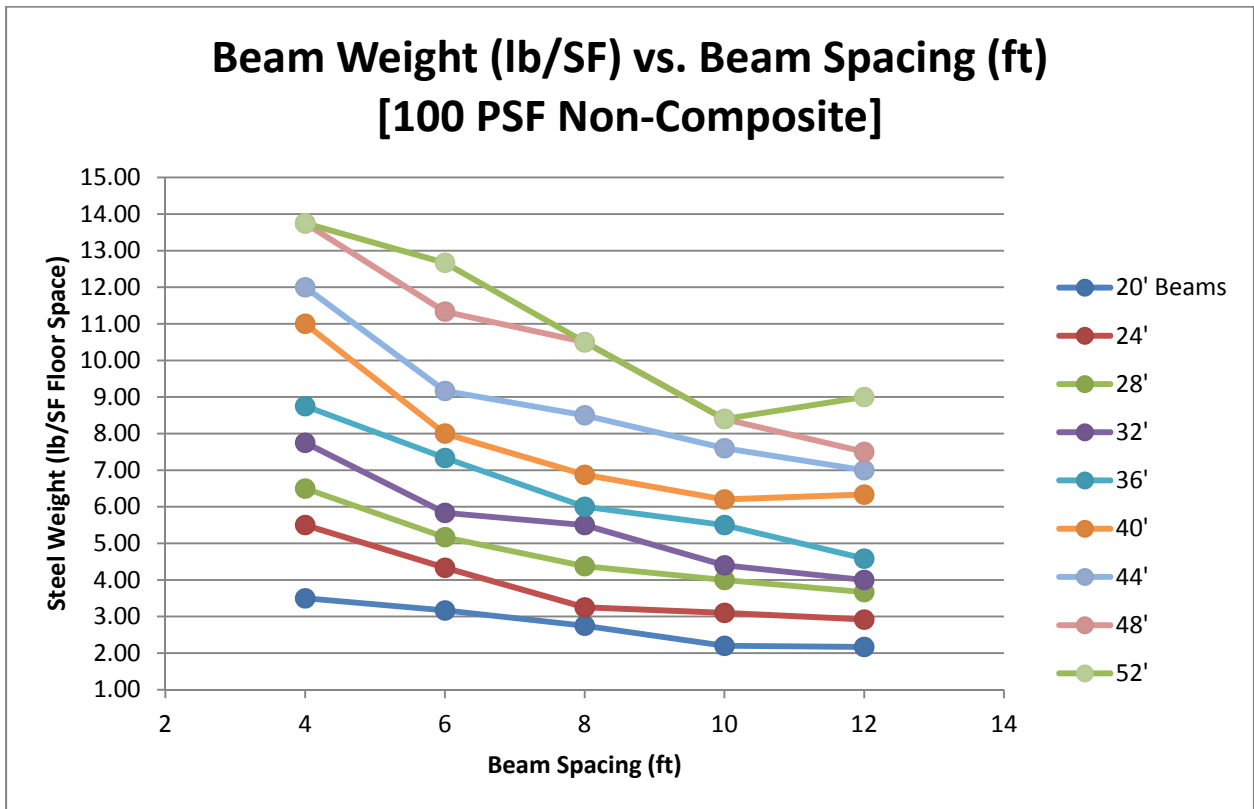
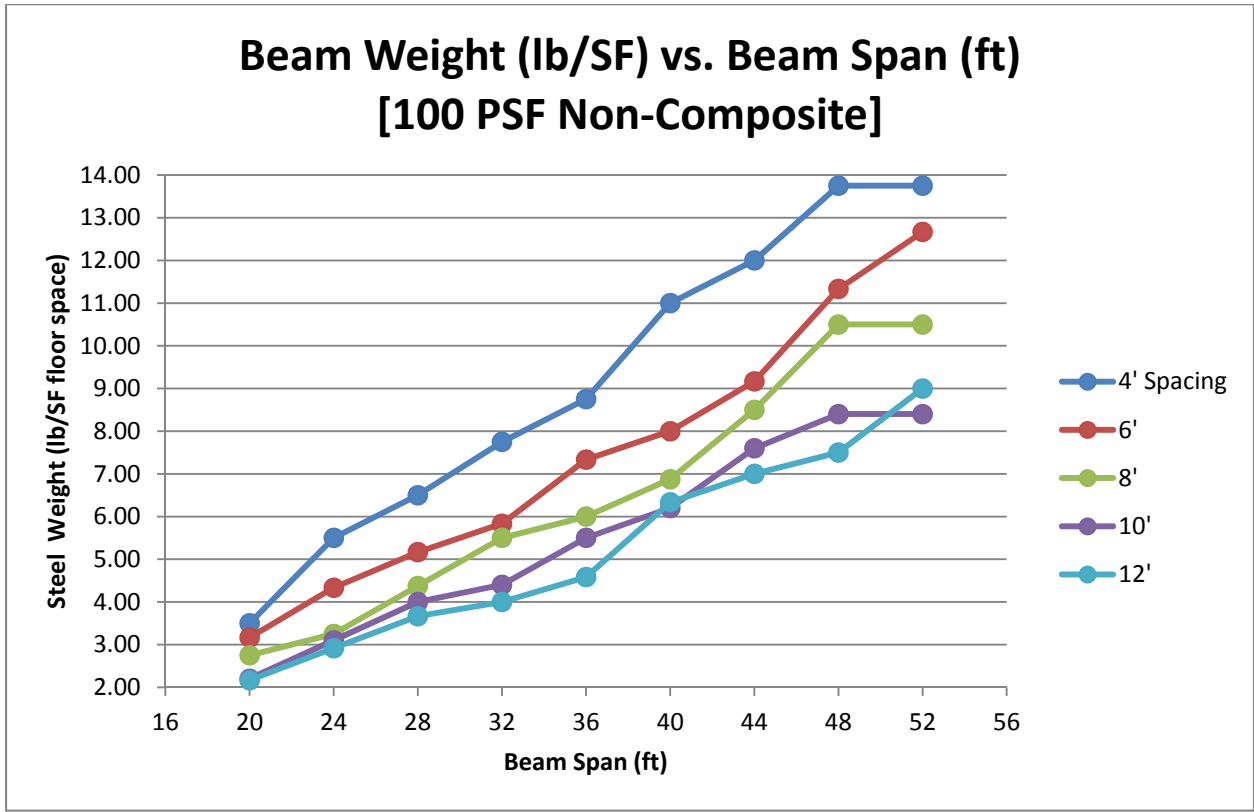

Beam Weight (lb/SF) vs. Beam Spacing (ft) [100 PSF Non-Composite]

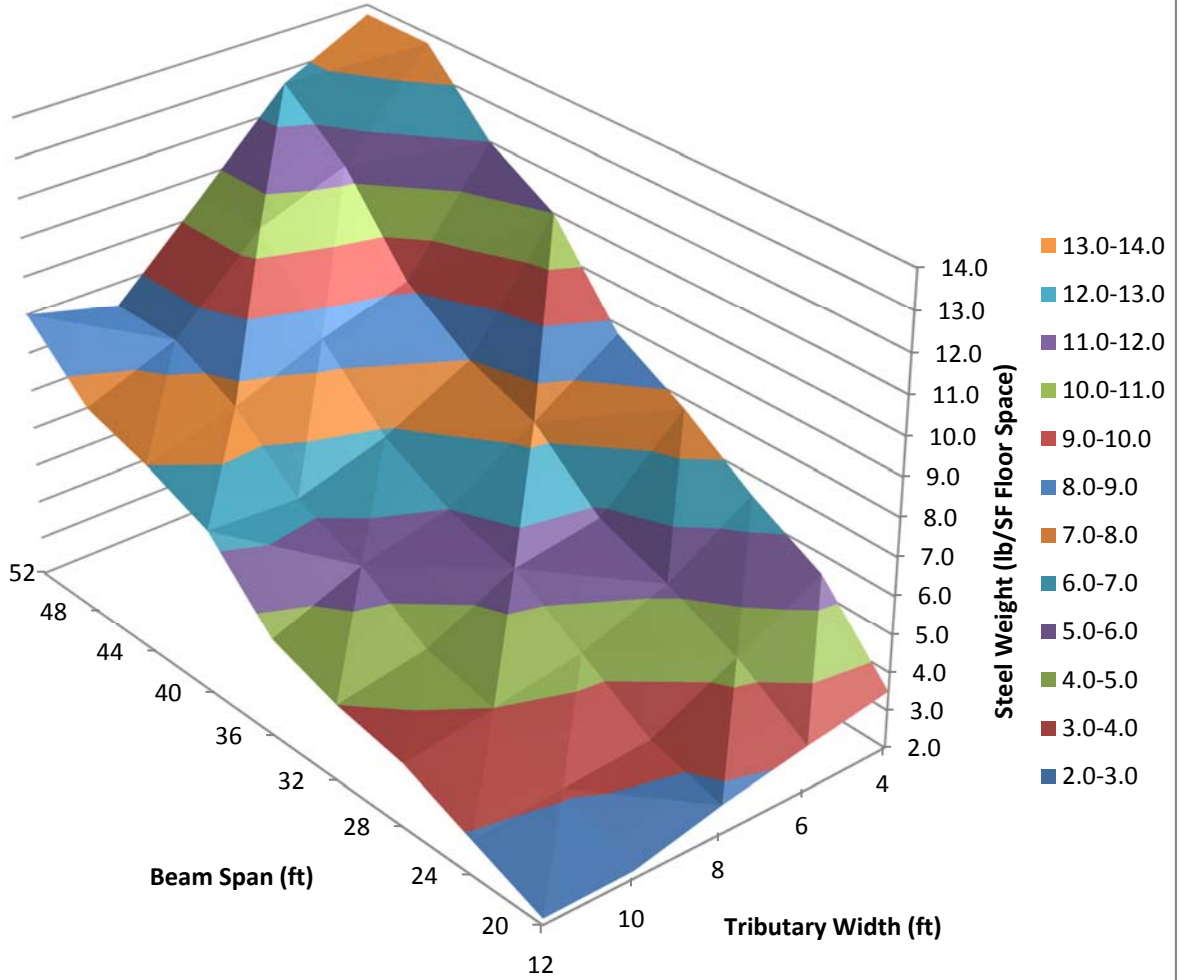

Girder Weight (lb/SF) vs. Girder Span (ft) [100 PSF Non-Composite]

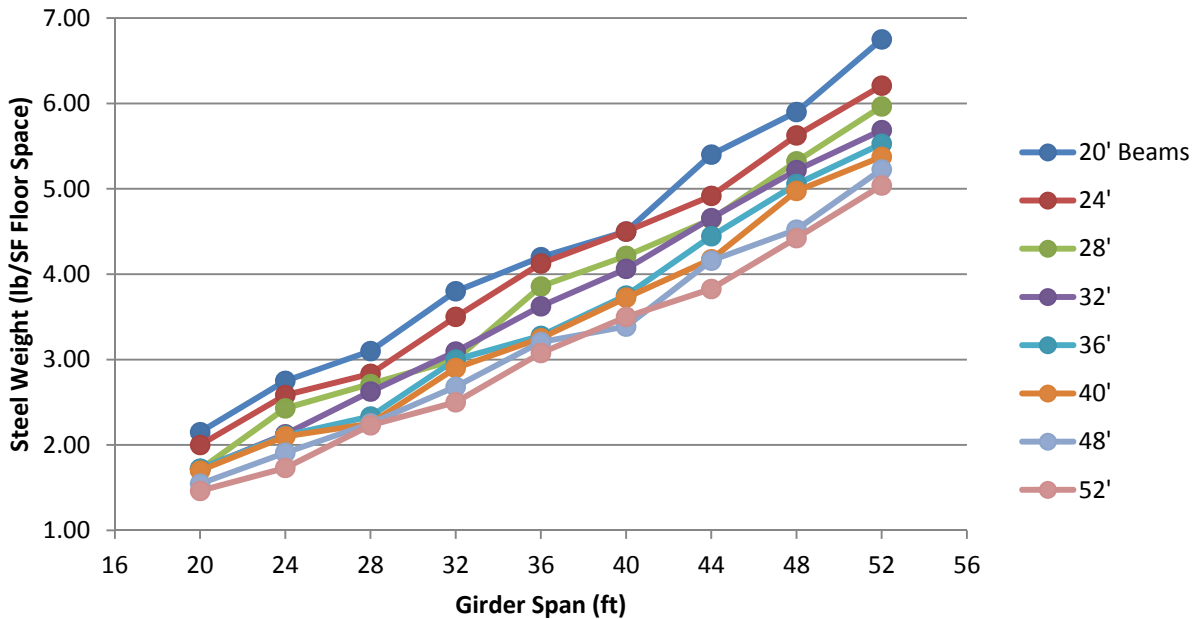

Girder Weight (lb/SF) vs. Beam Span (ft) [100 PSF Non-Composite]

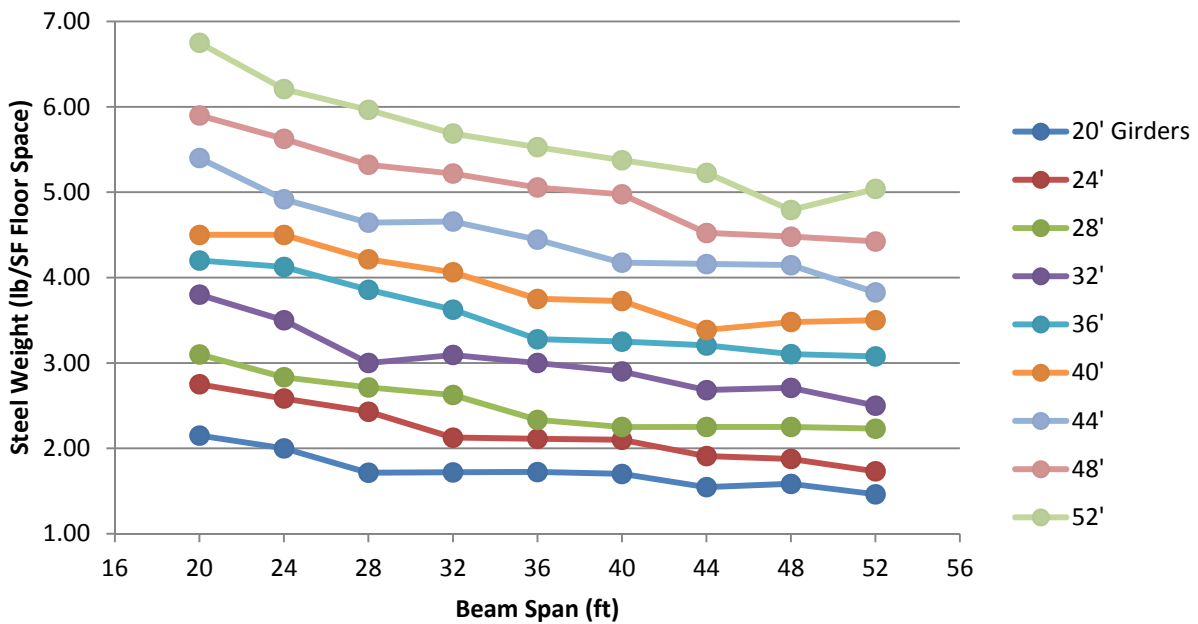

Girder Weight (lb/SF) vs. Bay Size (ft) [100 PSF Non-Composite]

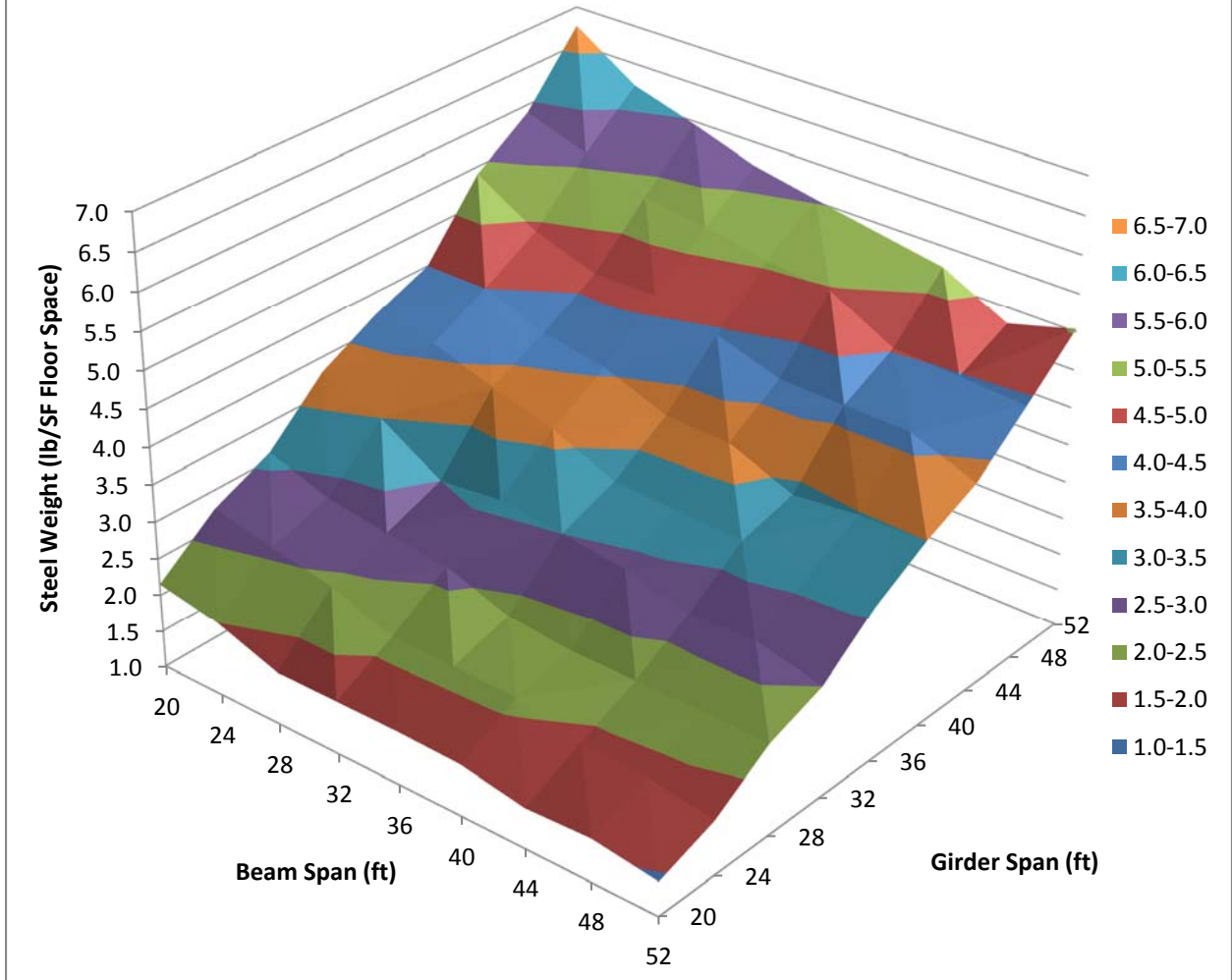

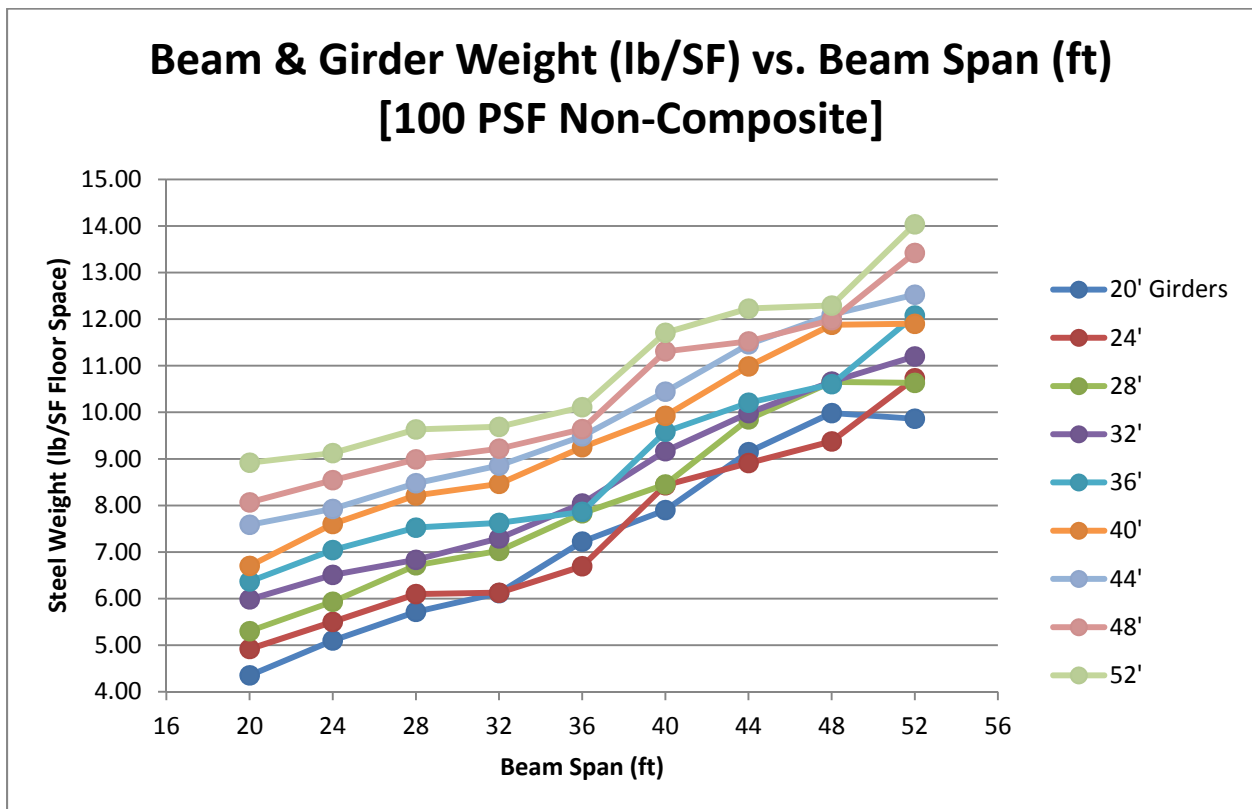
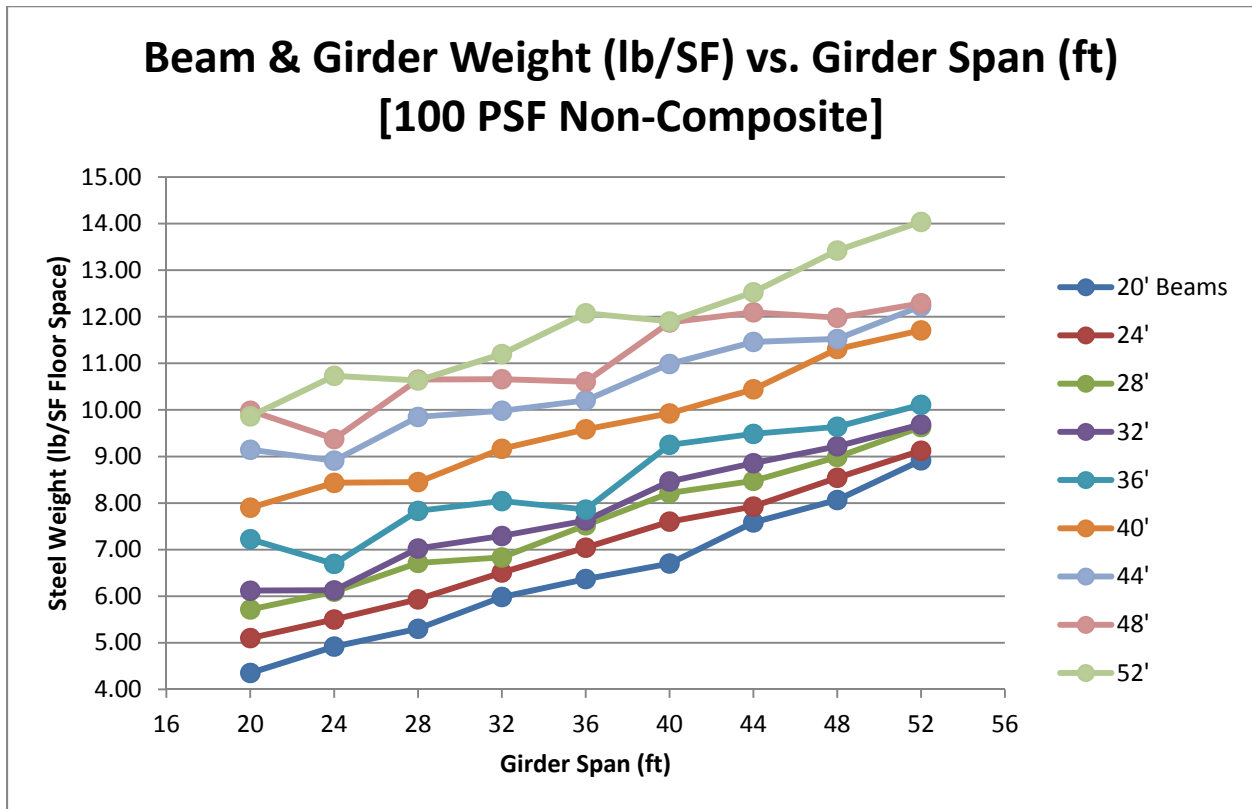

Beam & Girder Weight (lb/SF) vs. Bay Size (ft) [100 PSF Non-Composite]

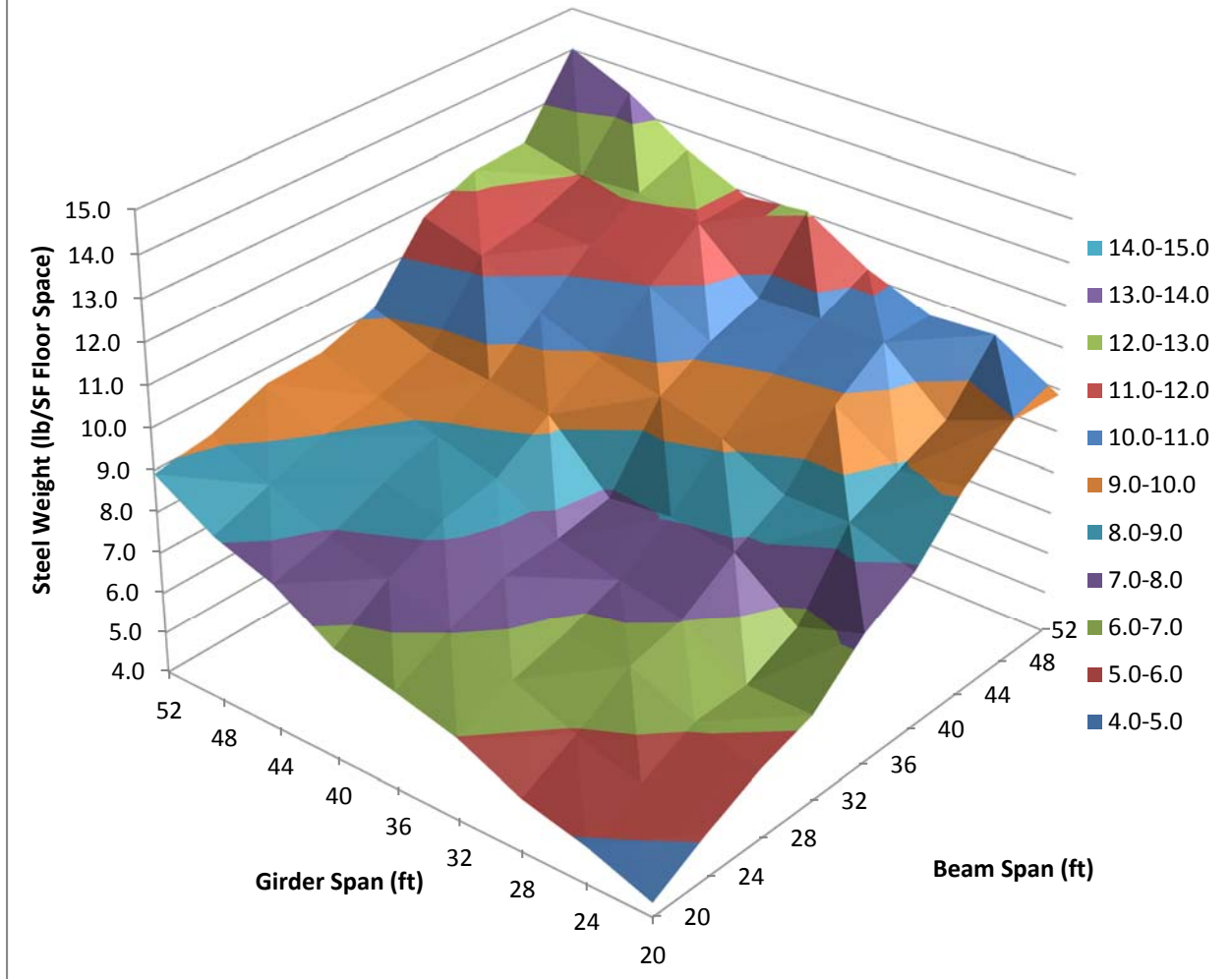

Column Weight (lb/SF) vs. Girder Span (ft) [100 PSF Non-Composite]

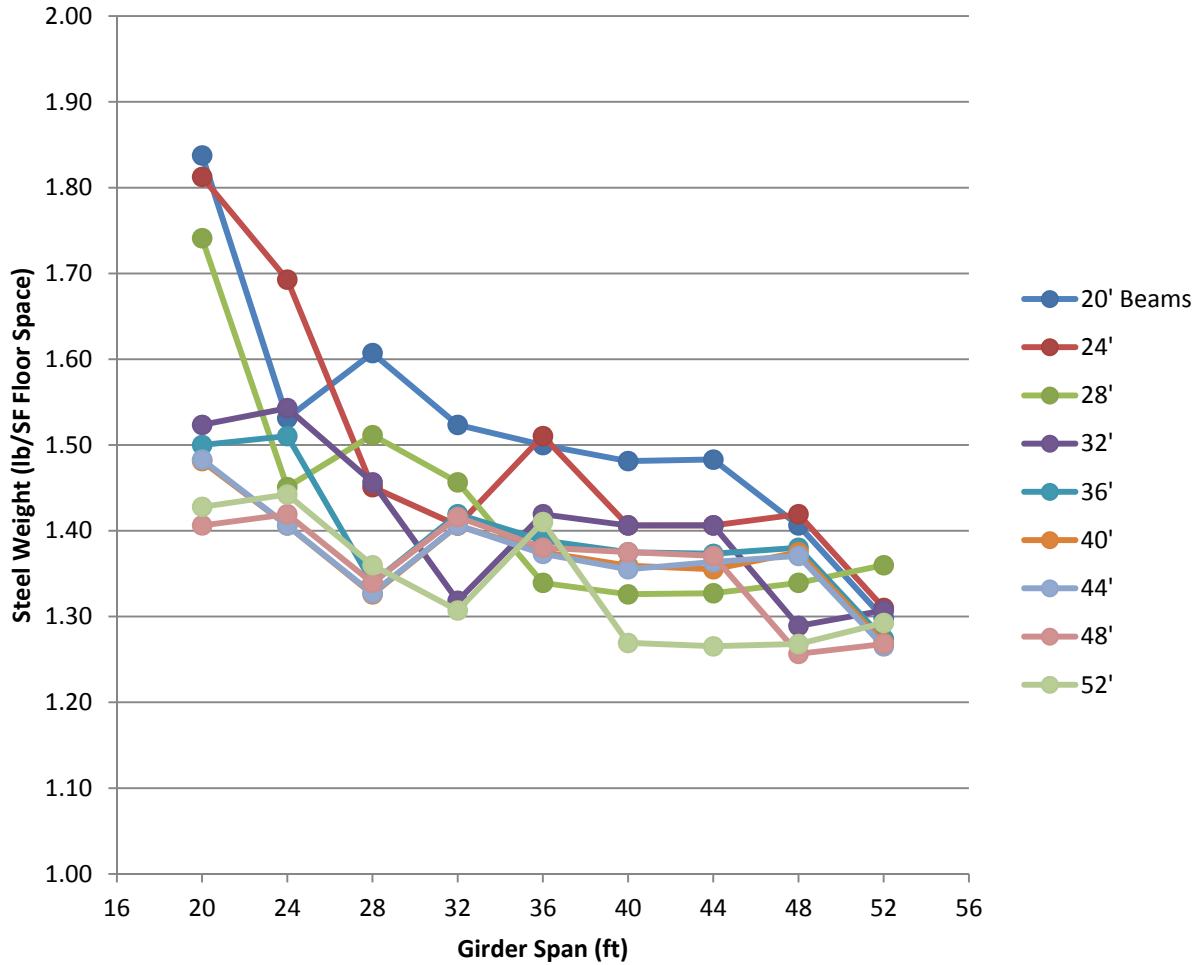

Total

Non-Composite

100 PSF

Total Steel Weight (lb/SF) vs. Beam Span (ft) [100 PSF Non-Composite]

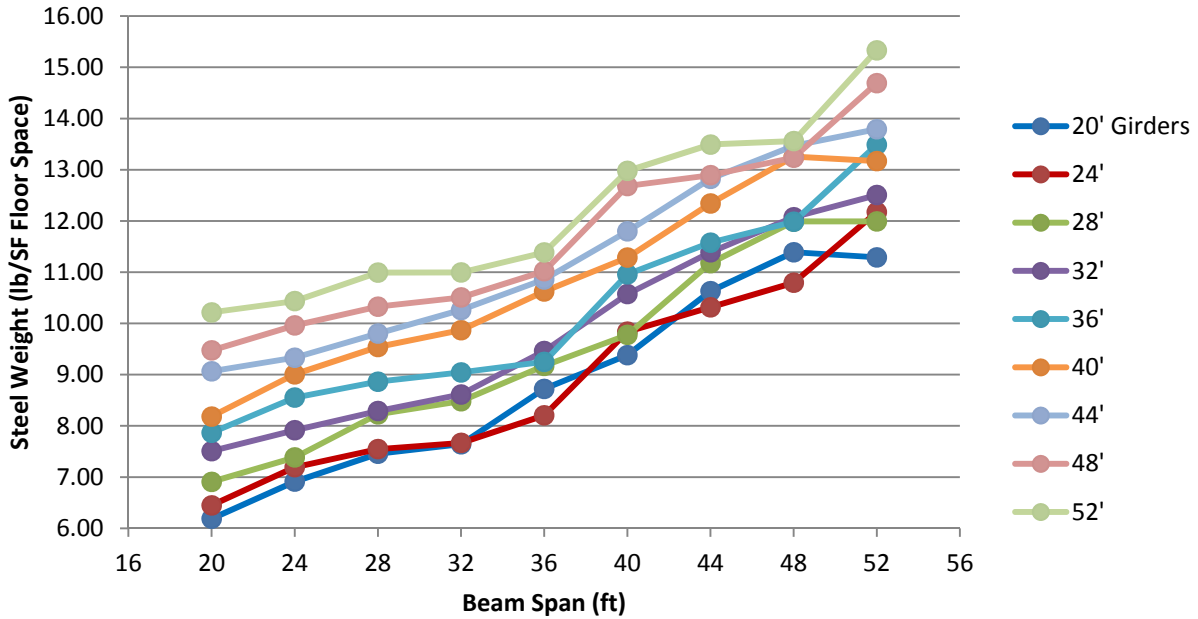

Total Steel Weight (lb/SF) vs. Girder Span (ft) [100 PSF Non-Composite]

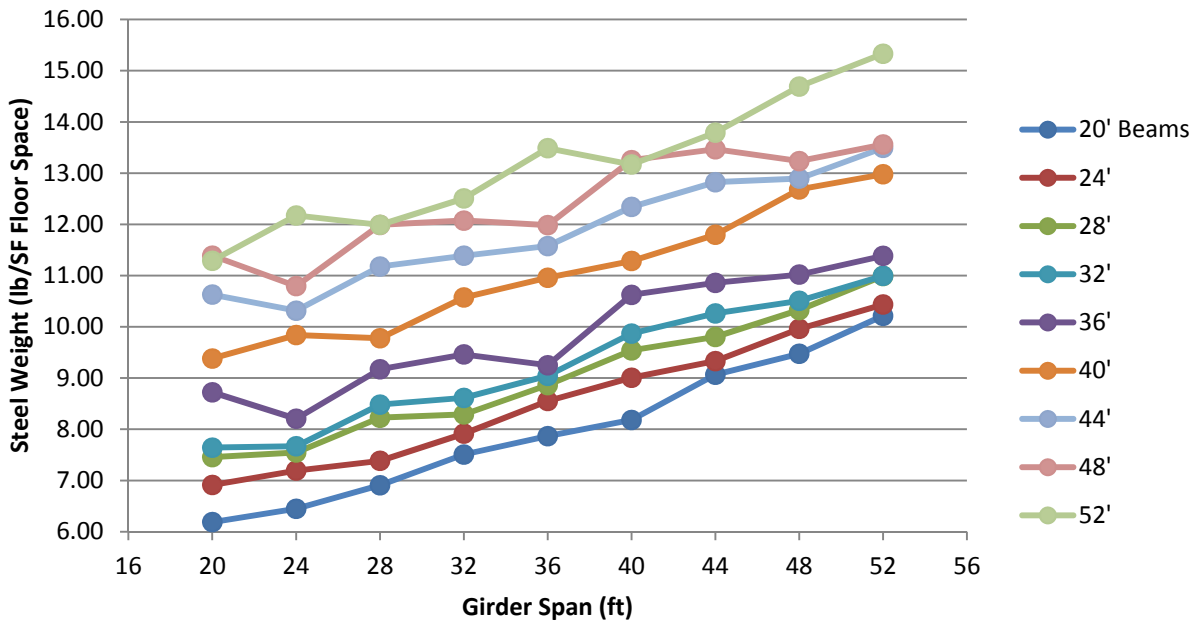

Total Steel Weight (lb/SF) vs. Bay Size (ft) [100 PSF Non-Composite]

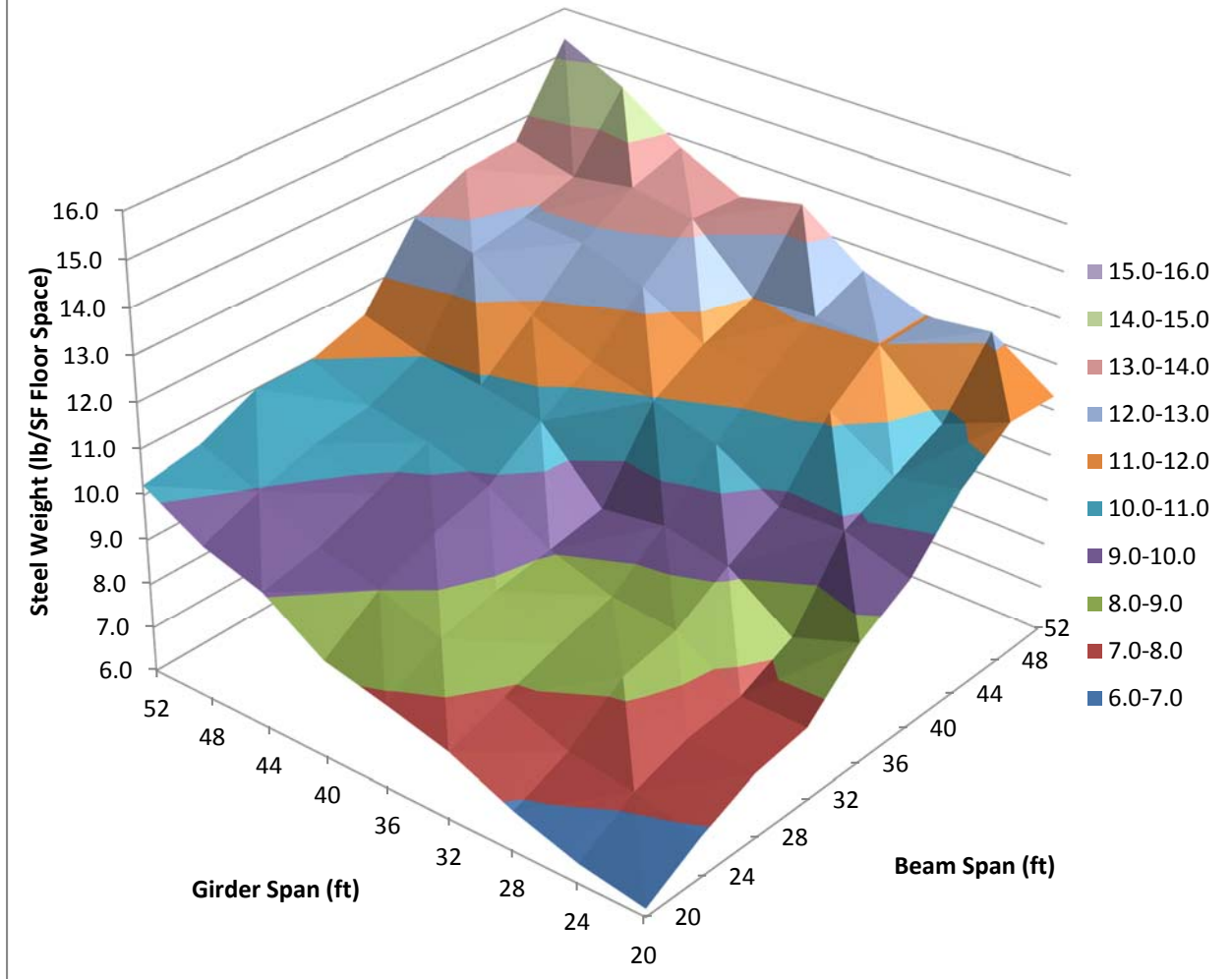

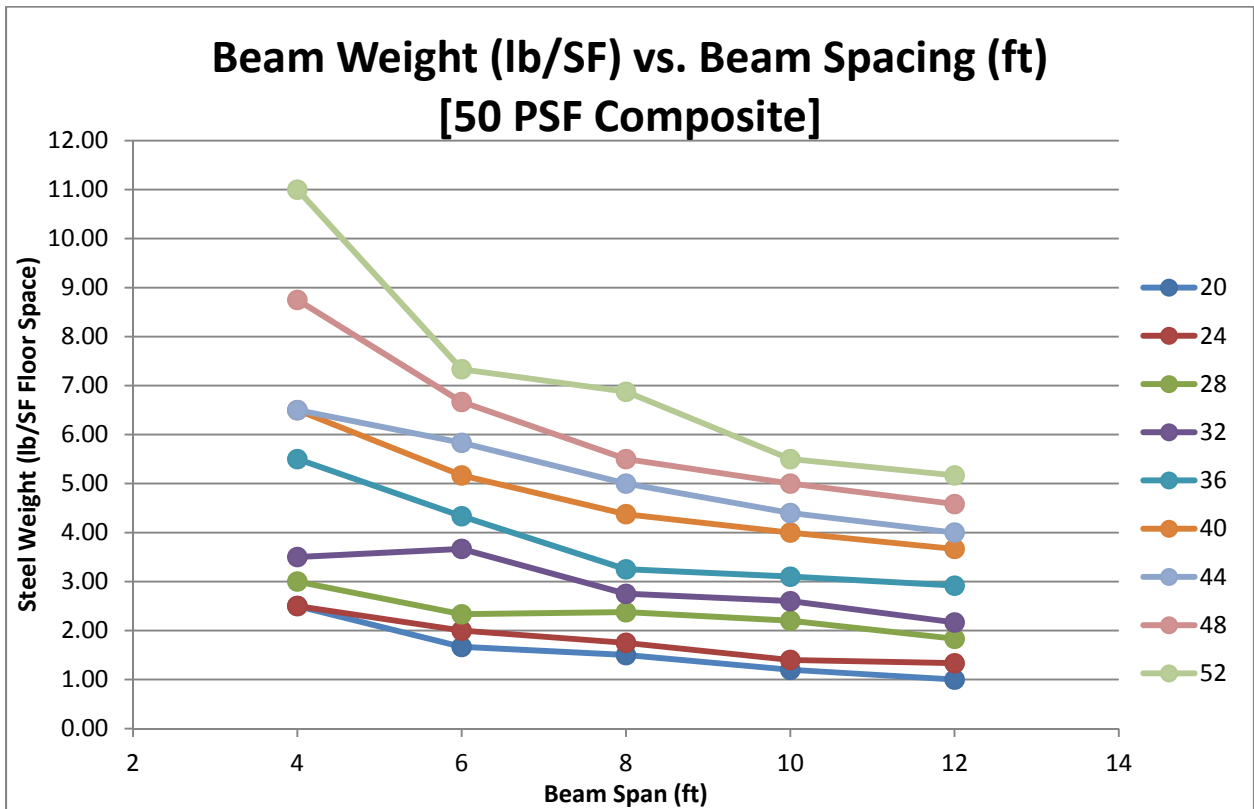
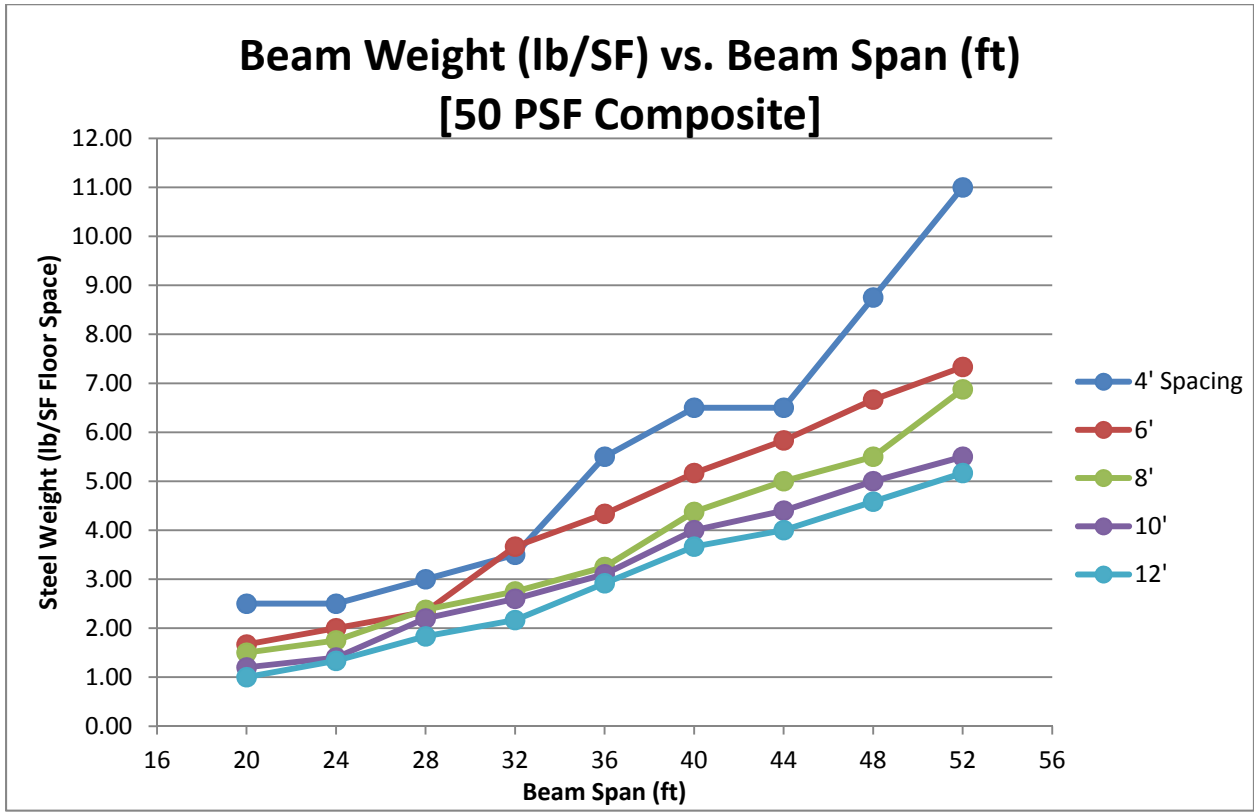

Beam Weight (lb/SF) vs. Beam Spacing (ft) [50 PSF Composite]

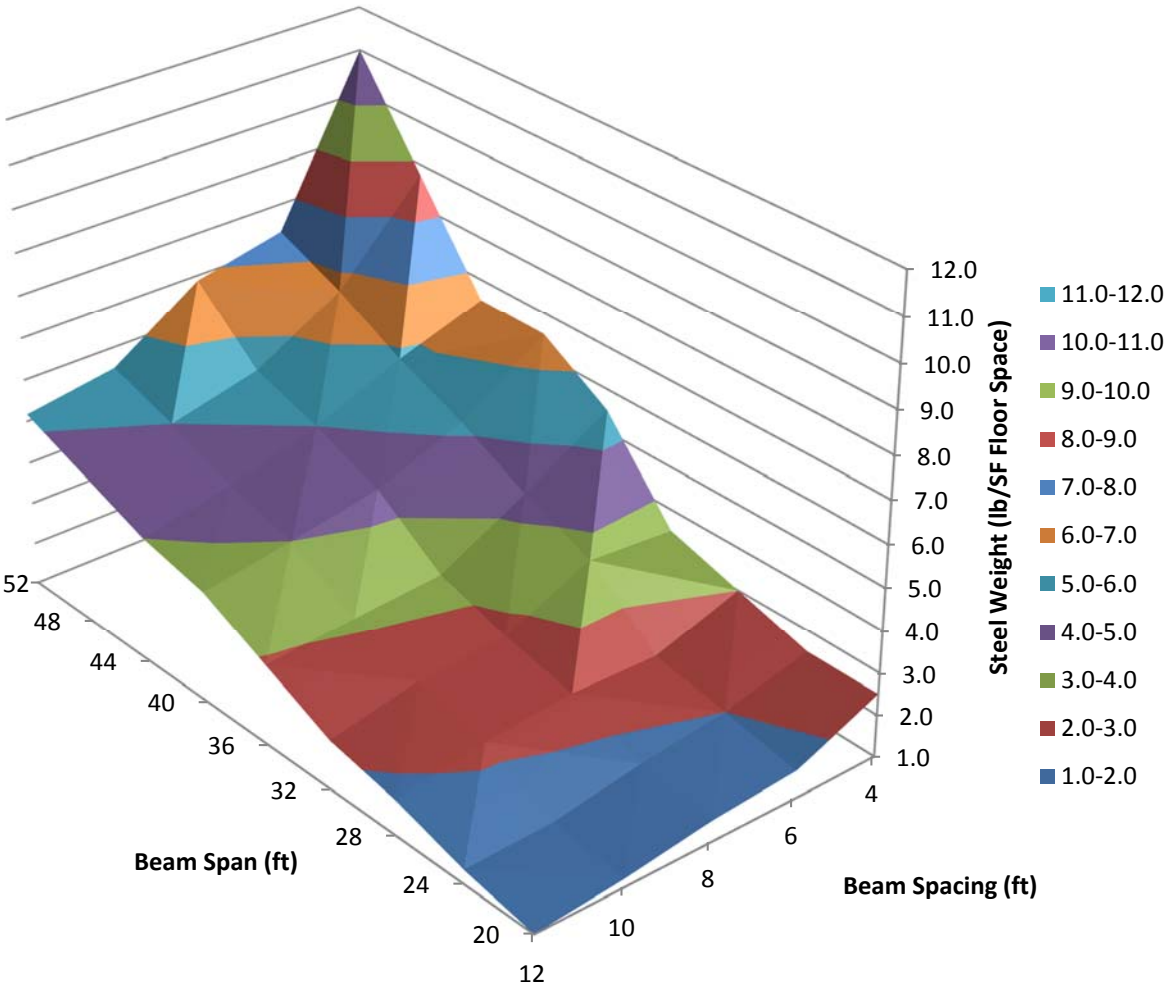

Girders

Composite

50 PSF

Girder Weight (lb/SF) vs. Girder Span (ft) [50 PSF Composite]

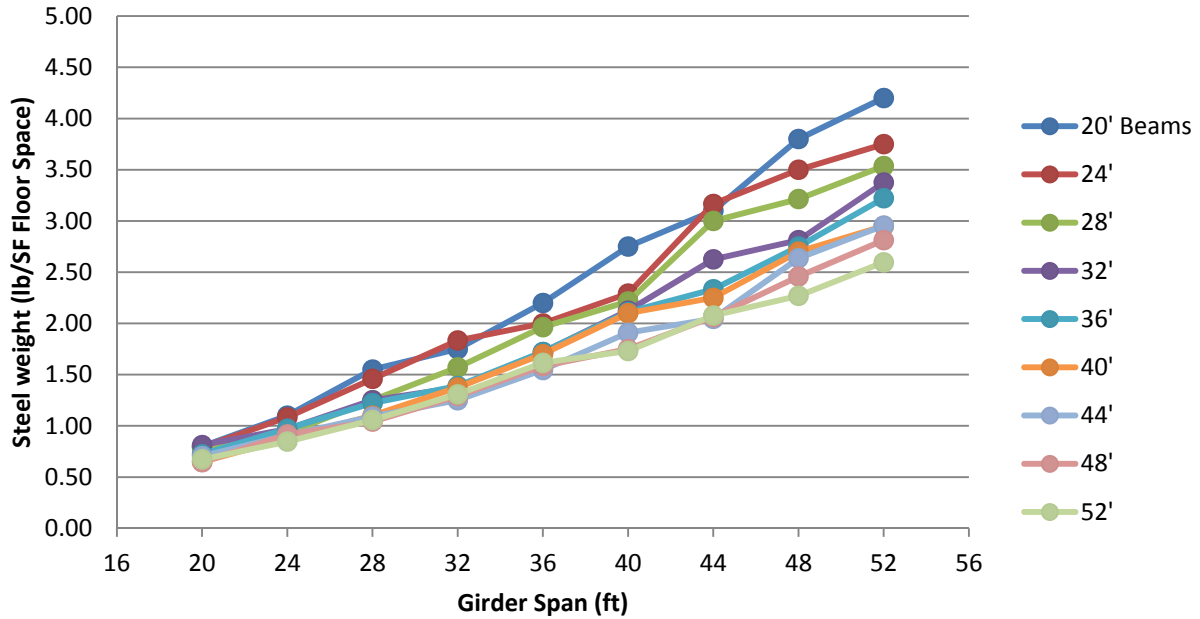

Girder Weight (lb/SF) vs. Beam Span (ft) [50 PSF Composite]

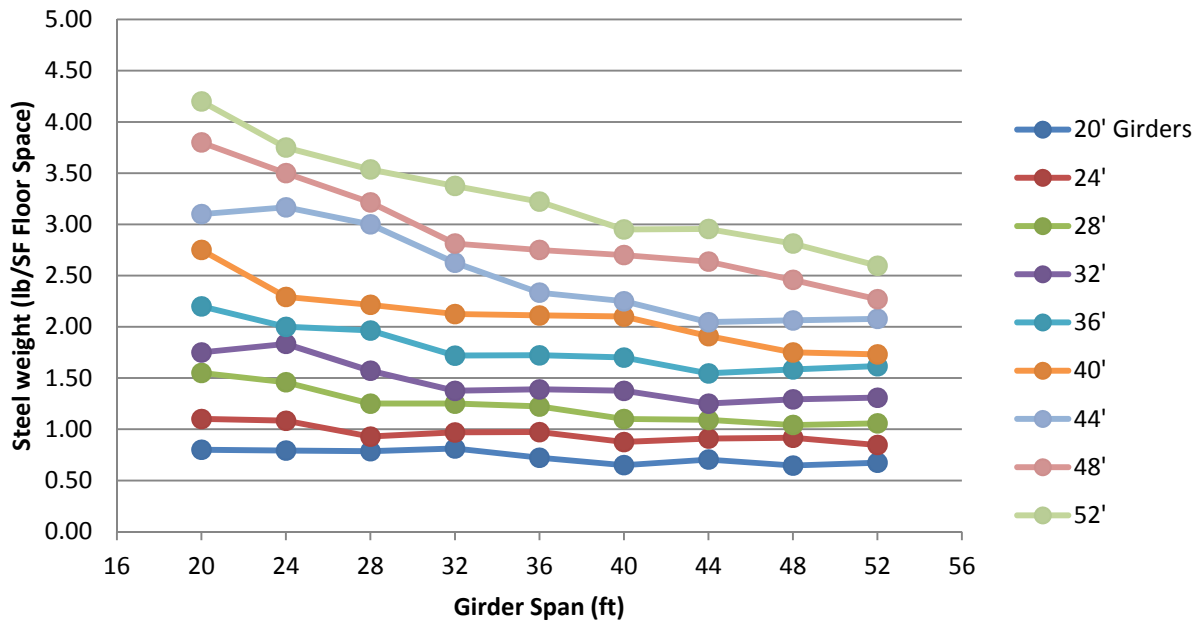

Girder Weight (lb/SF) vs. Bay Size (ft) [50 PSF Composite]

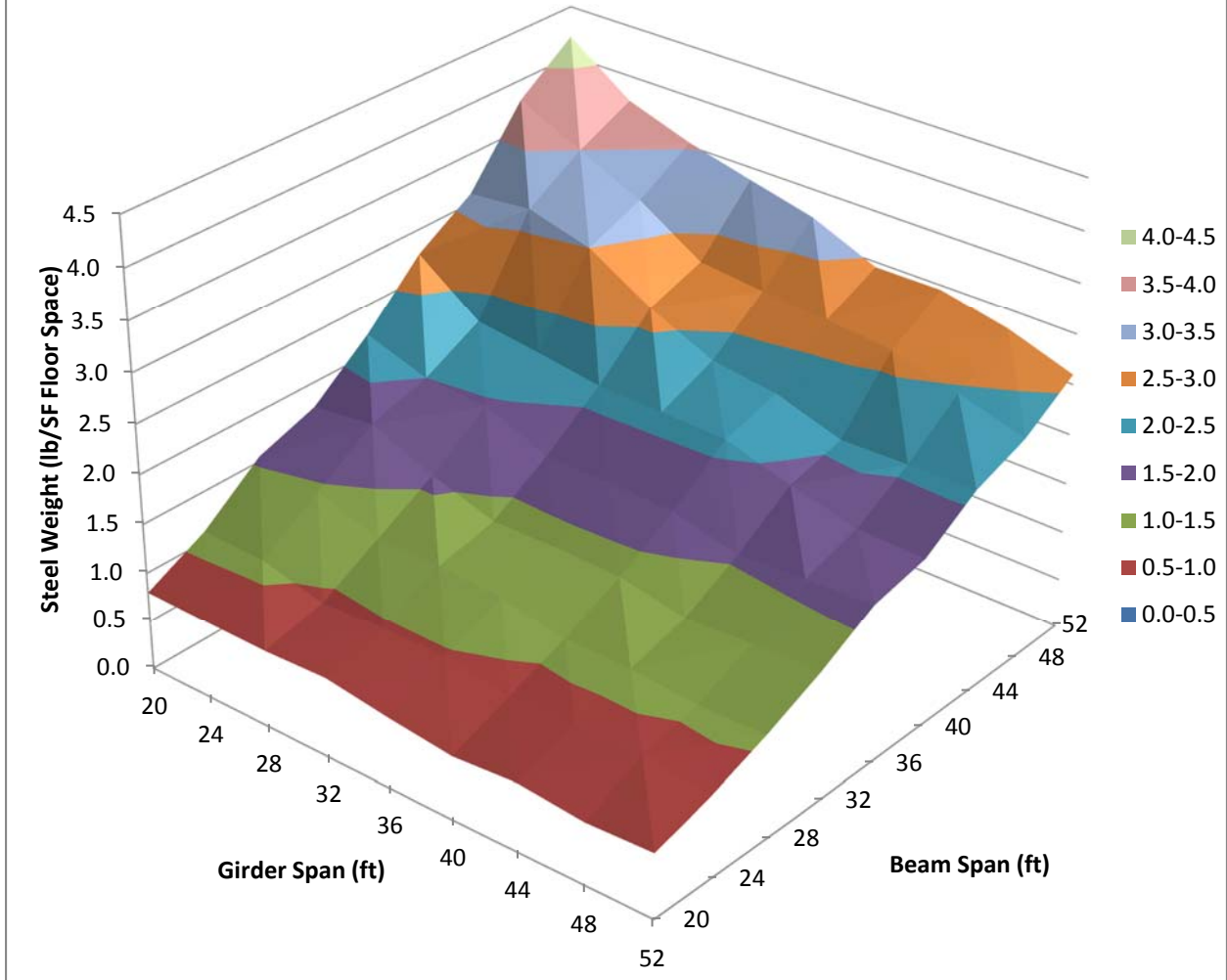

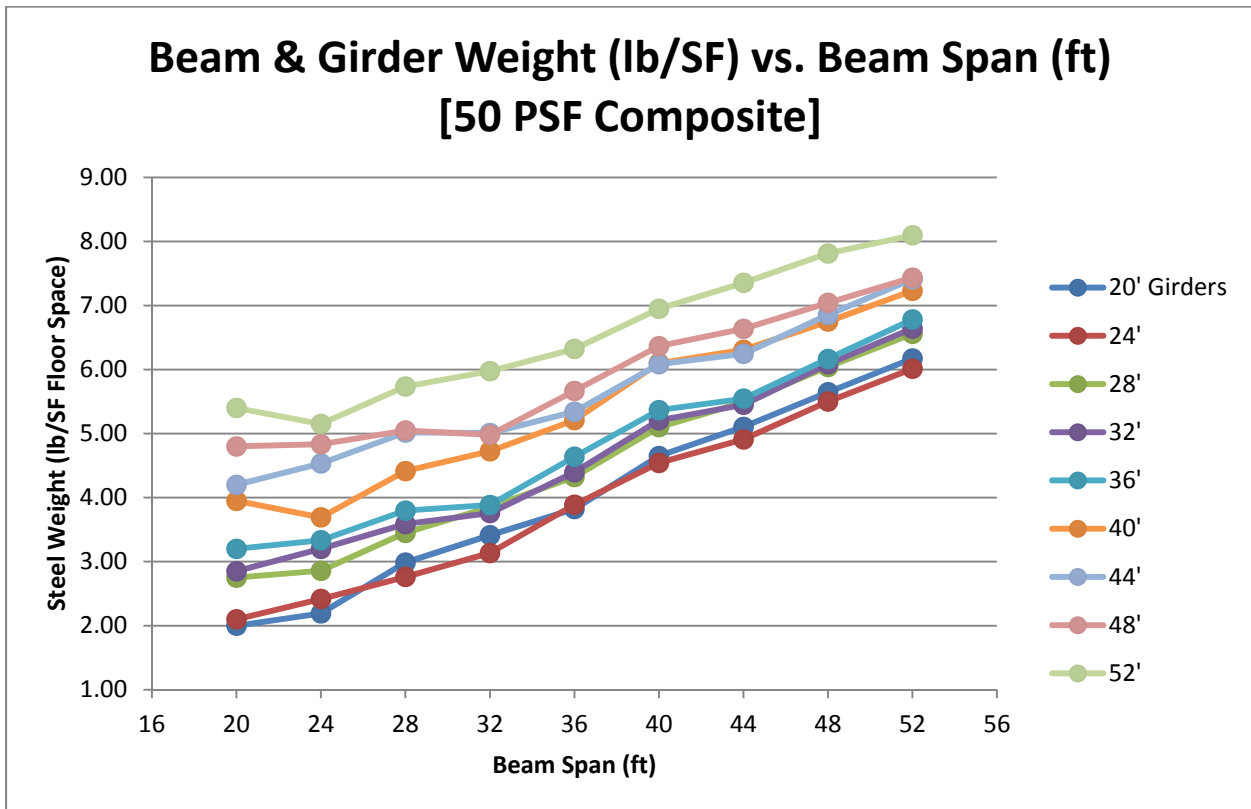
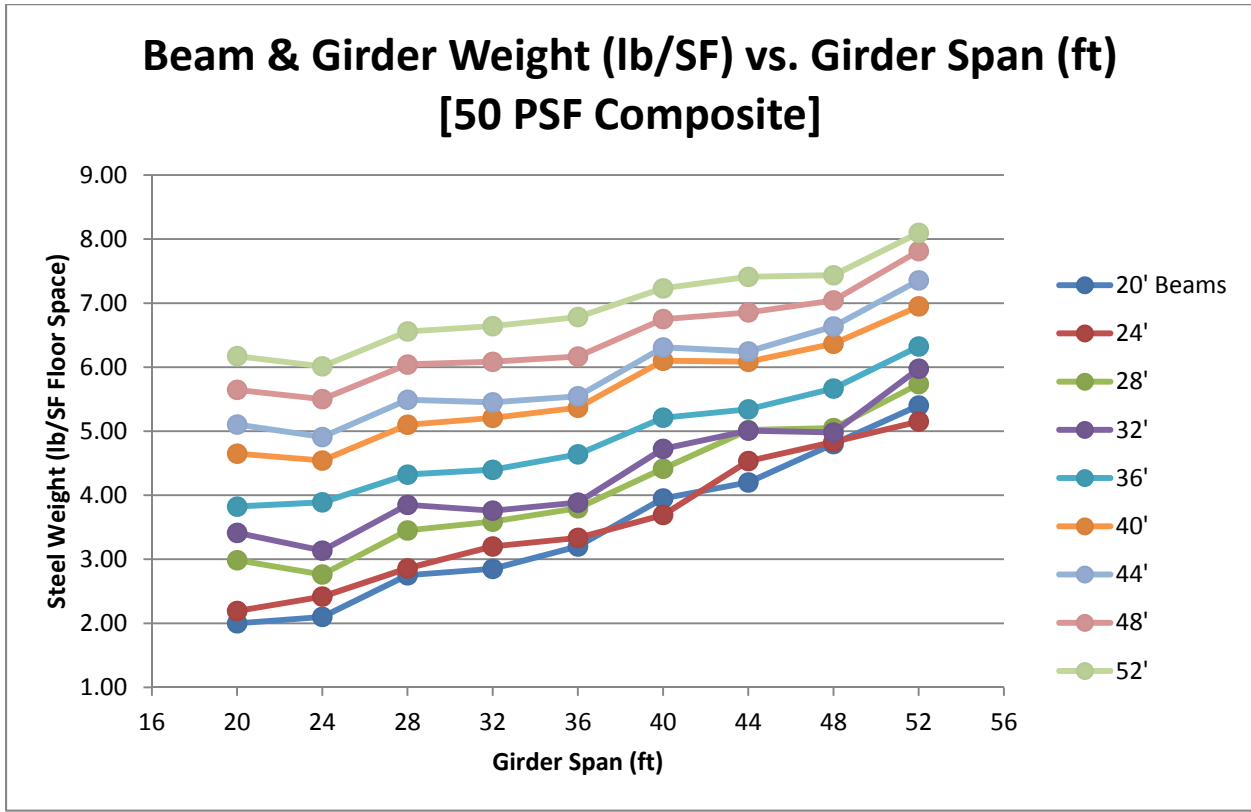

Beam & Girder Weight (lb/SF) vs. Bay Size (ft) [50 PSF Composite]

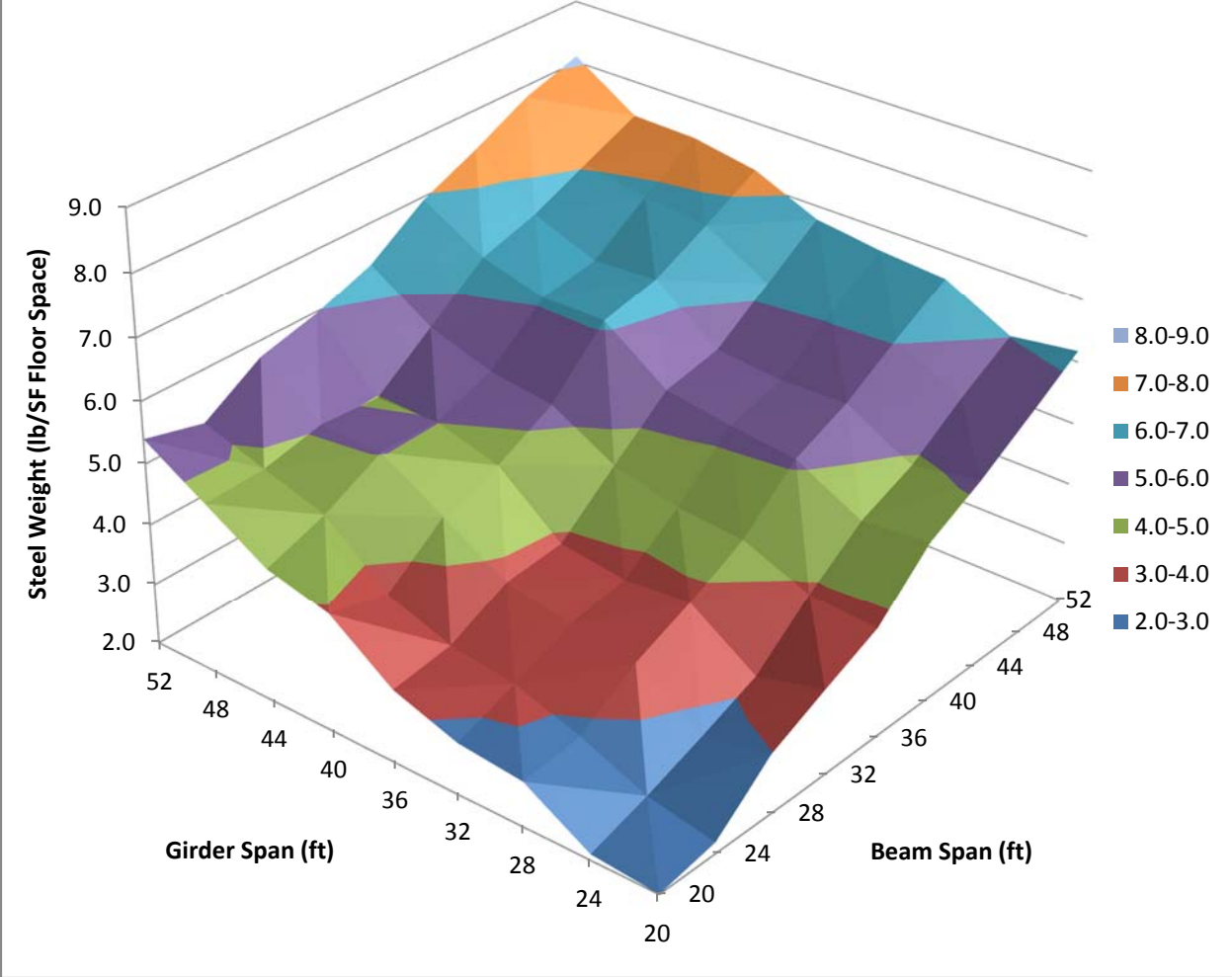

Column Weight (lb/SF) vs. Girder Span (ft) [50 PSF Composite]

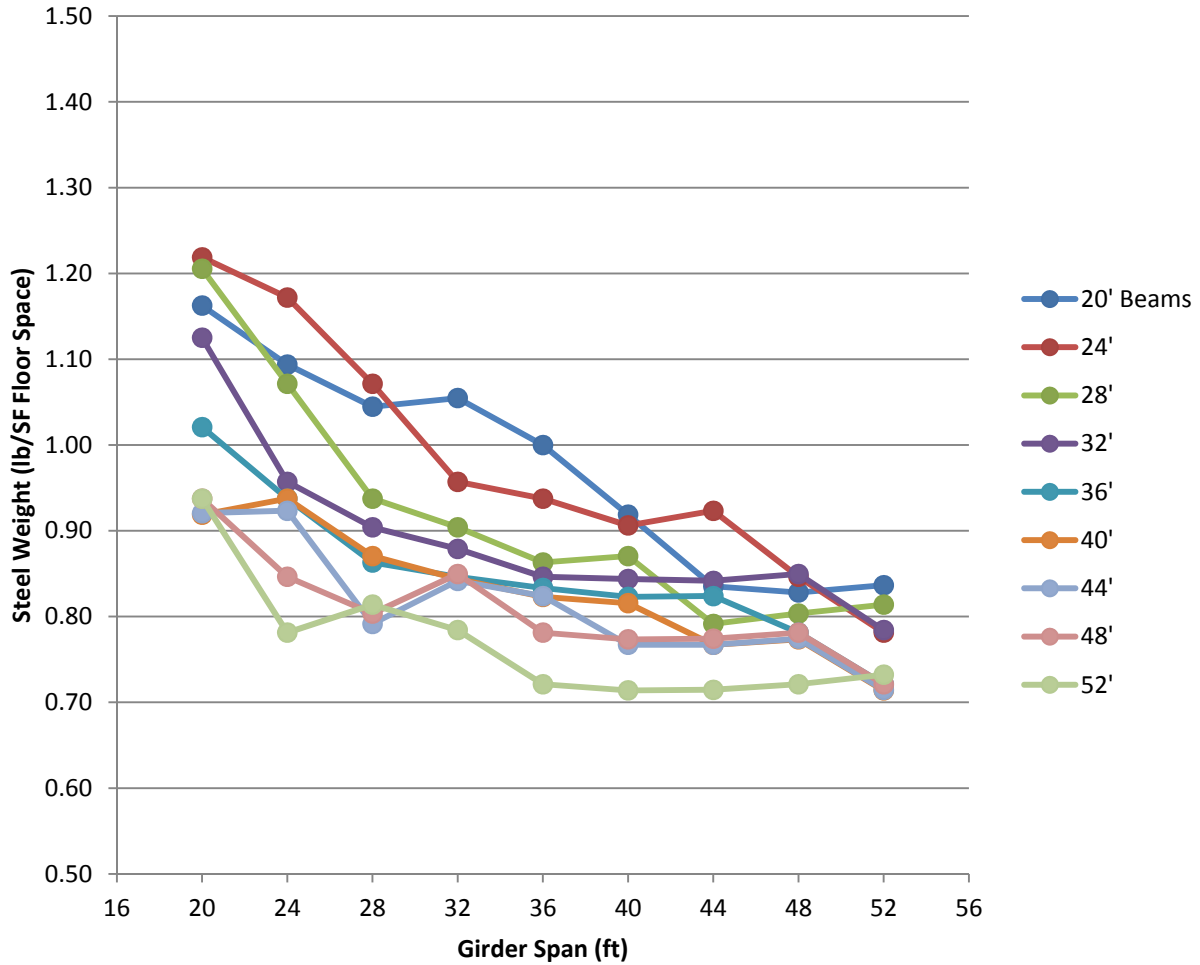

Total Composite 50 PSF

Total Steel Weight (lb/SF) vs. Beam Span (ft) [50 PSF Composite]

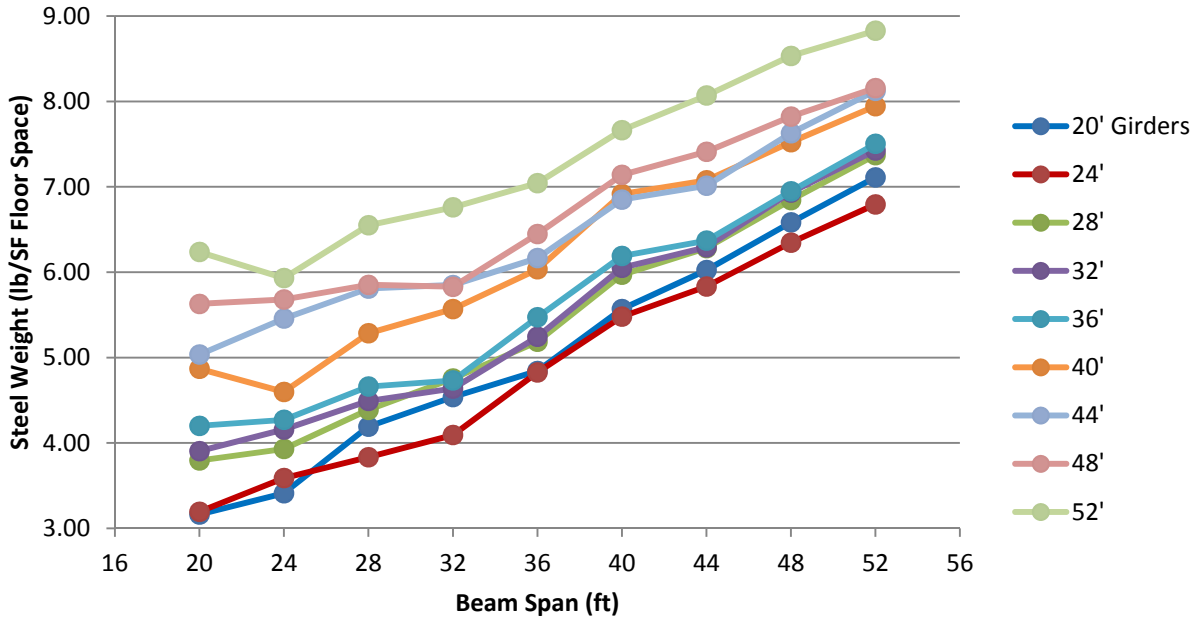

Total Steel Weight (lb/SF) vs. Girder Span (ft) [50 PSF Composite]

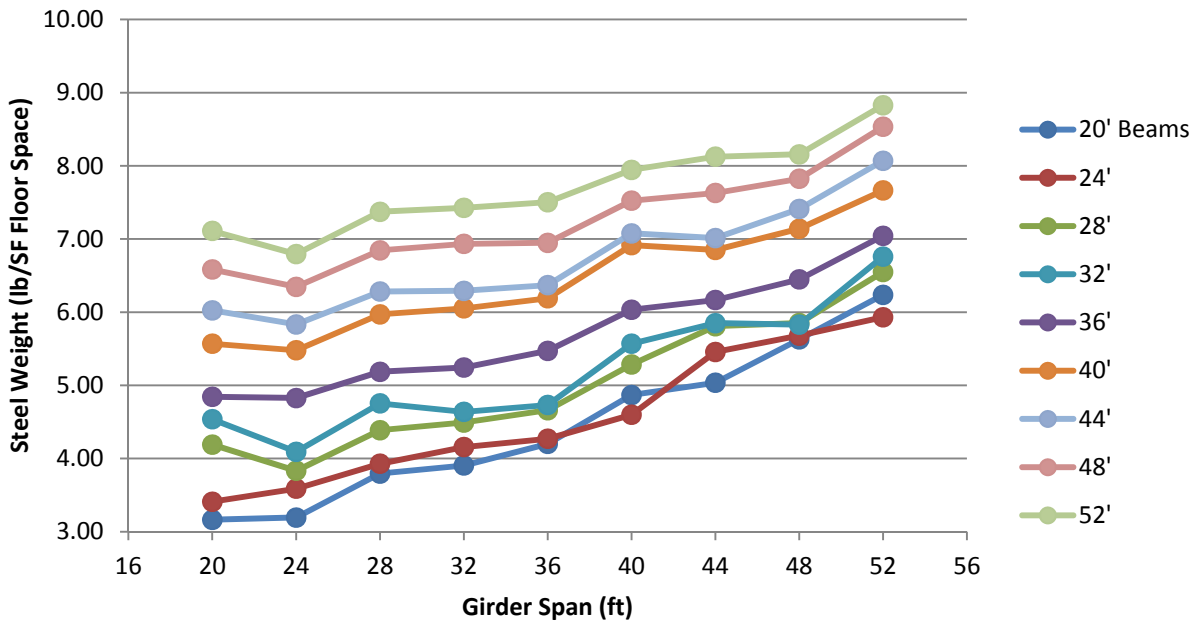

Total Steel Weight (lb/SF) vs. Bay Size (ft) [50 PSF Composite]

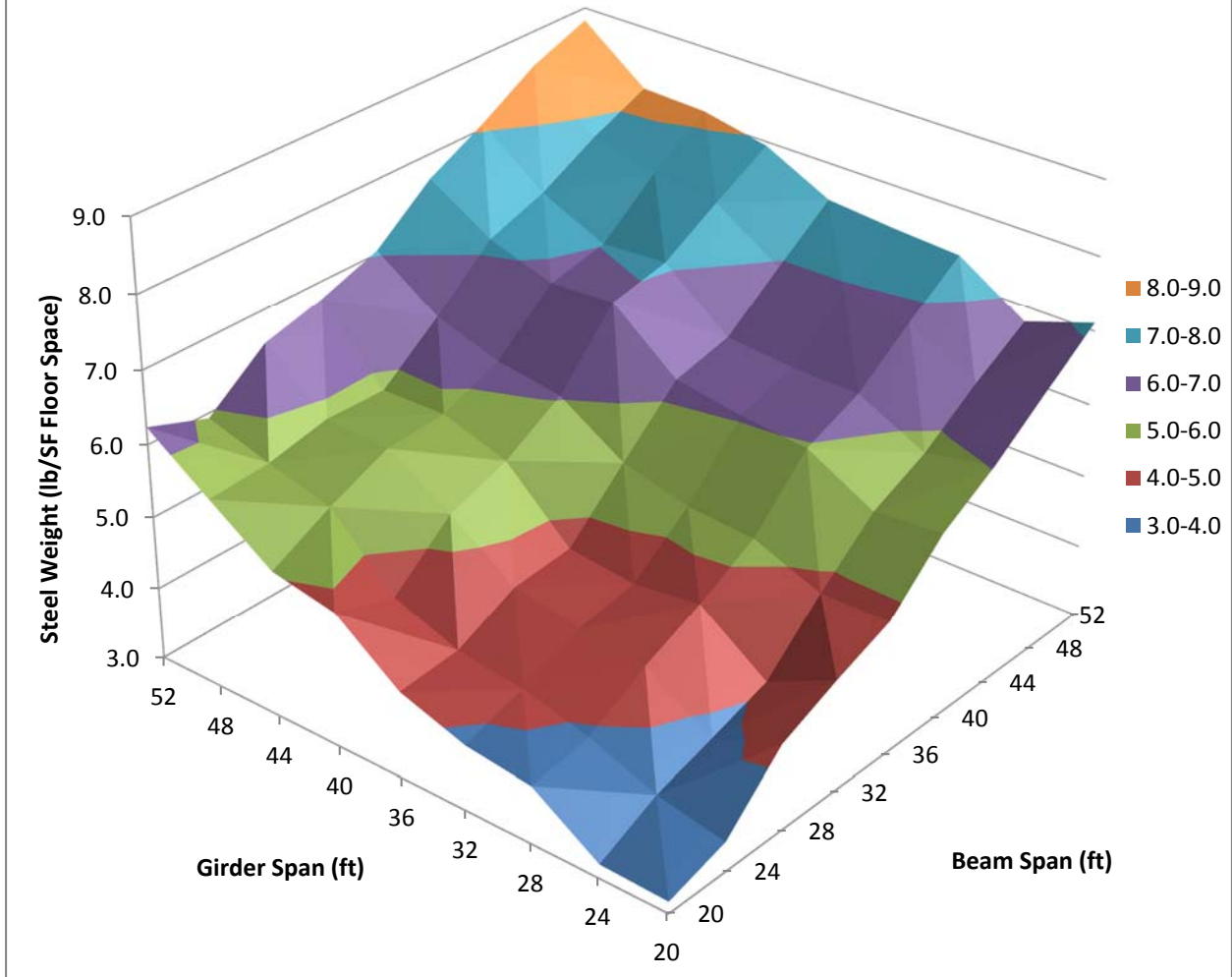

Beams

Composite

75 PSF

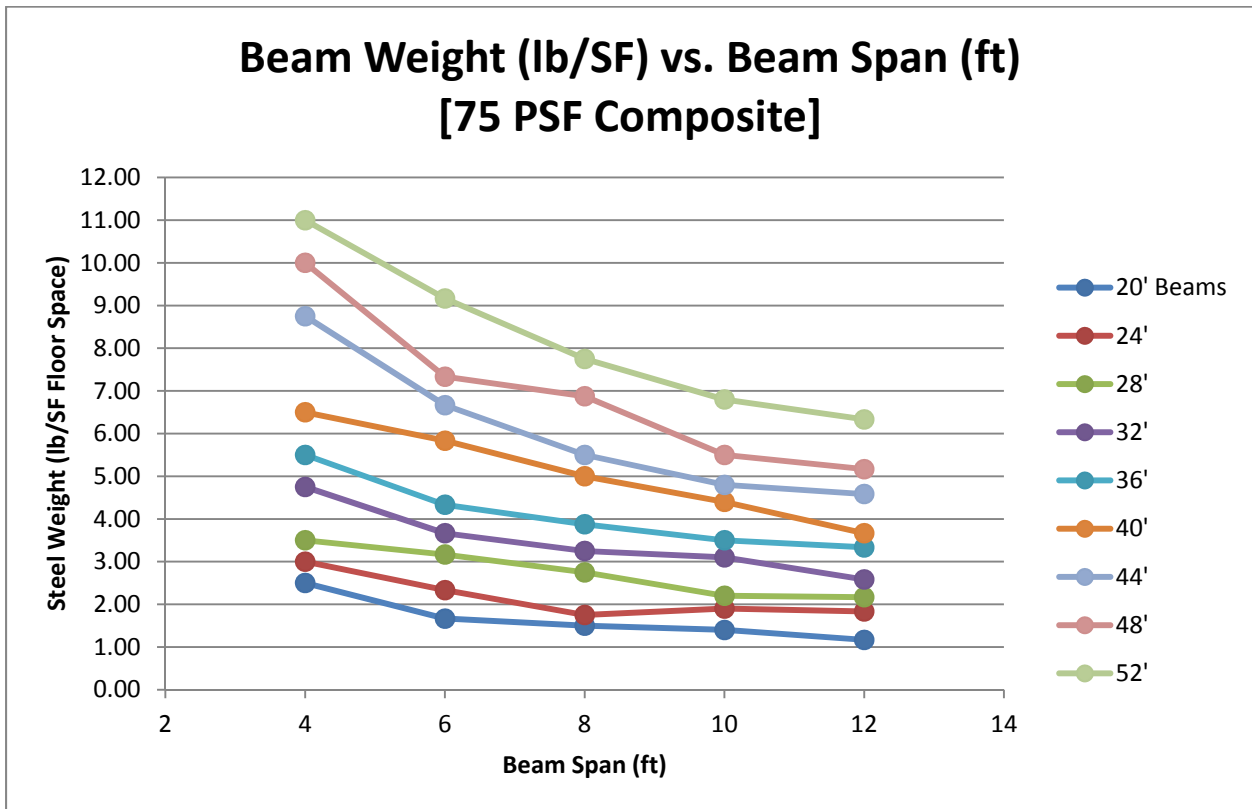
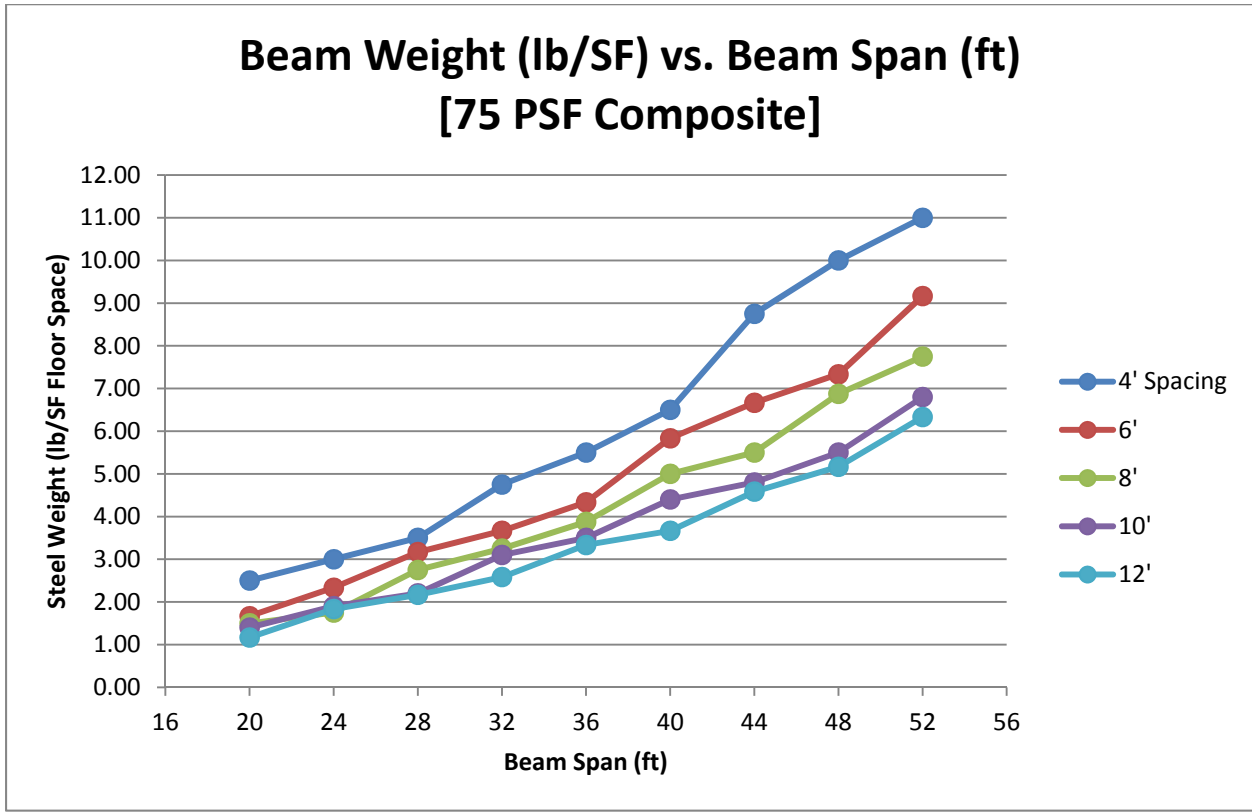

Beam Weight (lb/SF) vs. Beam Spacing (ft) [75 PSF Composite]

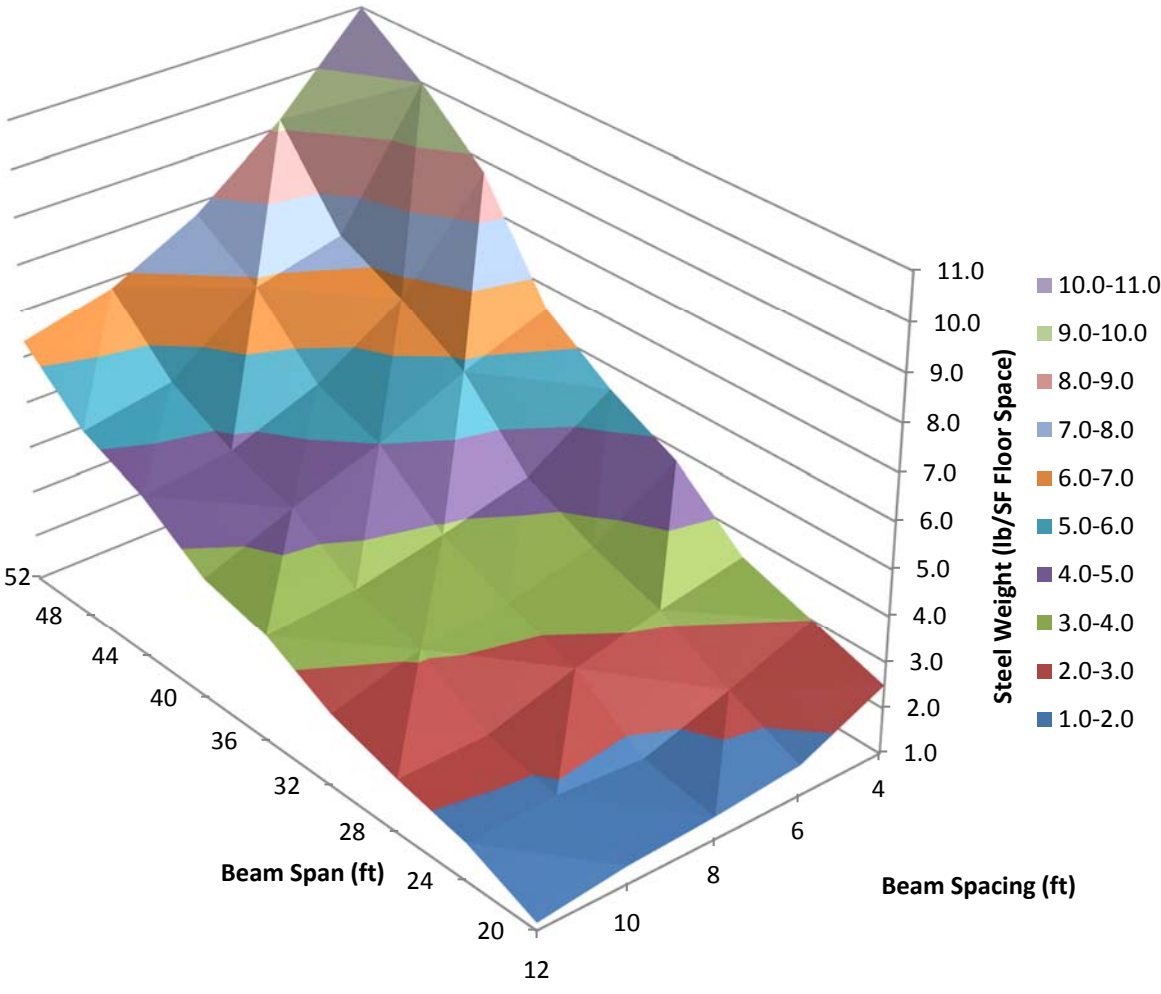

Girders

Composite

75 PSF

Girder Weight (lb/SF) vs. Girder Span (ft) [75 PSF Composite]

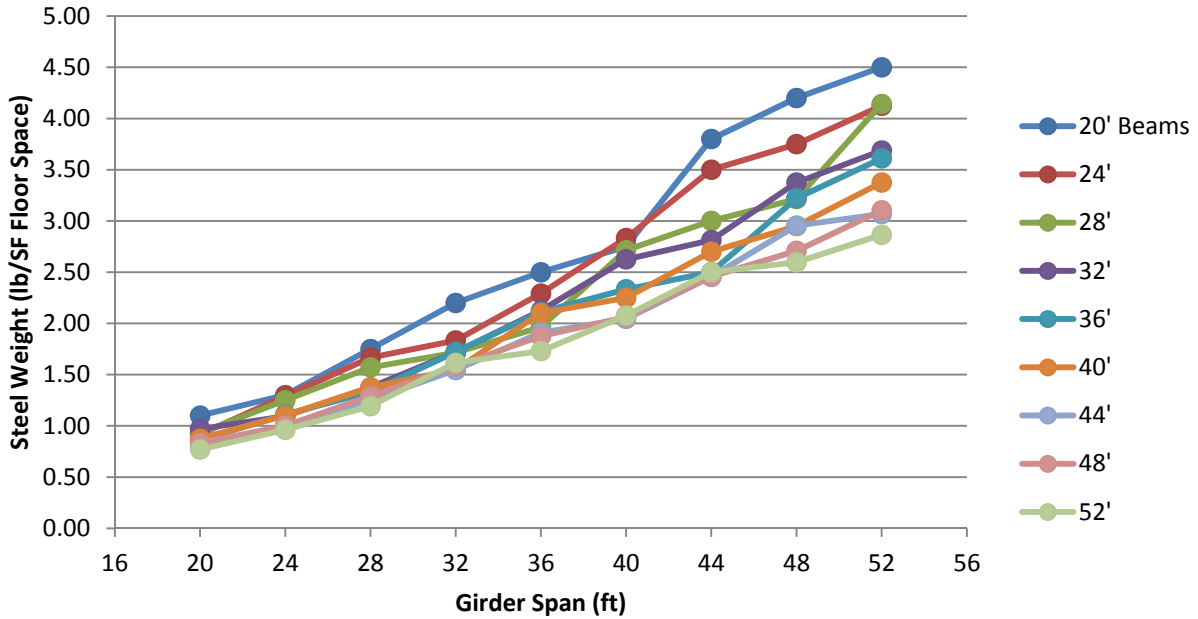

Girder Weight (lb/SF) vs. Beam Span (ft) [75 PSF Composite]

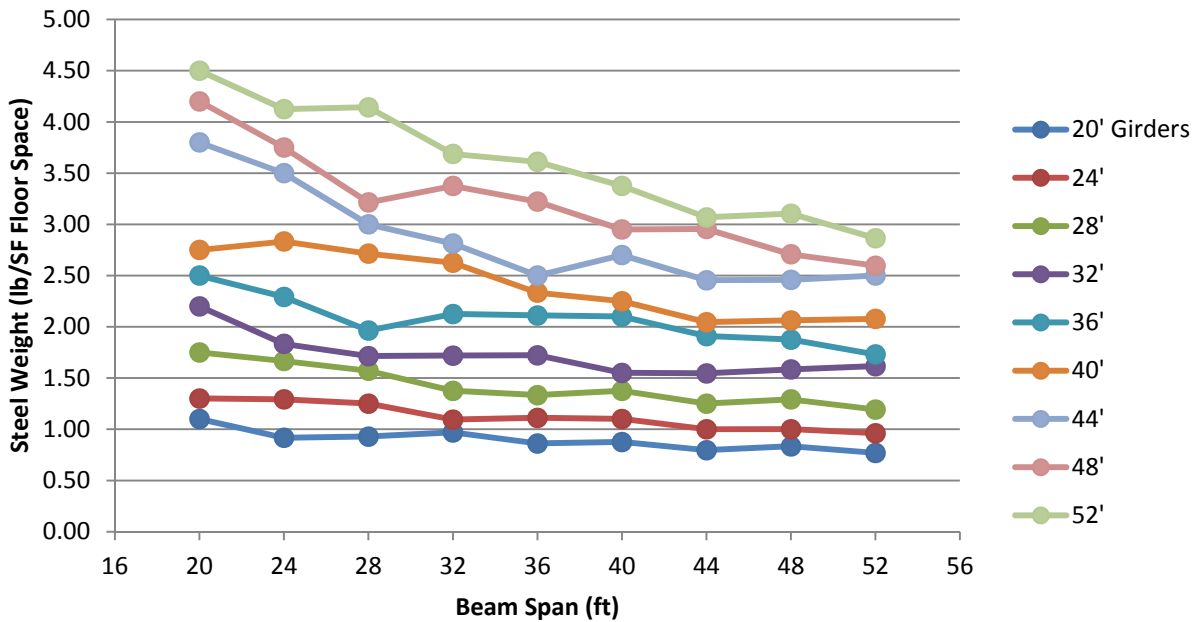

Girder Weight (lb/SF) vs. Bay Size (ft) [75 PSF Composite]

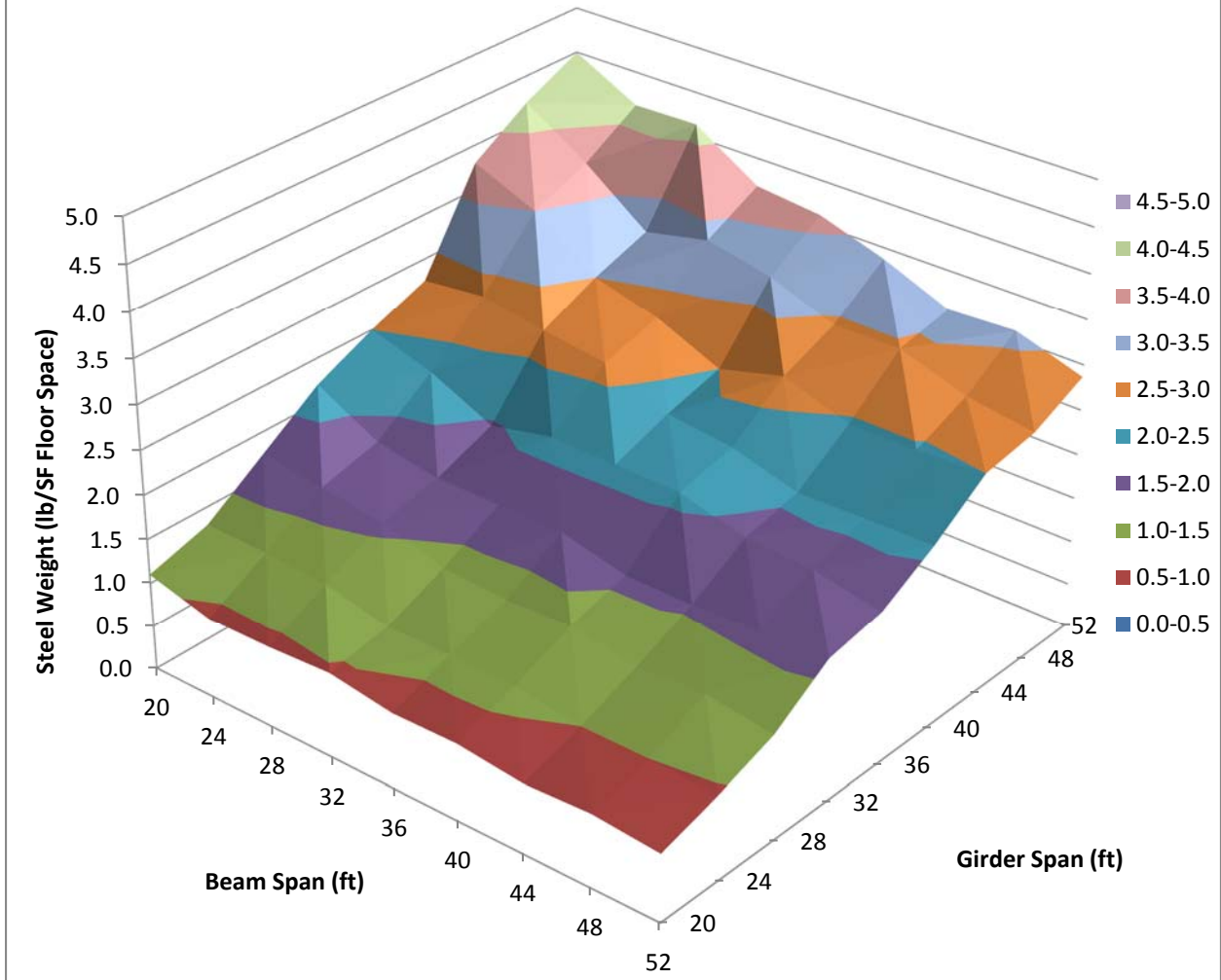

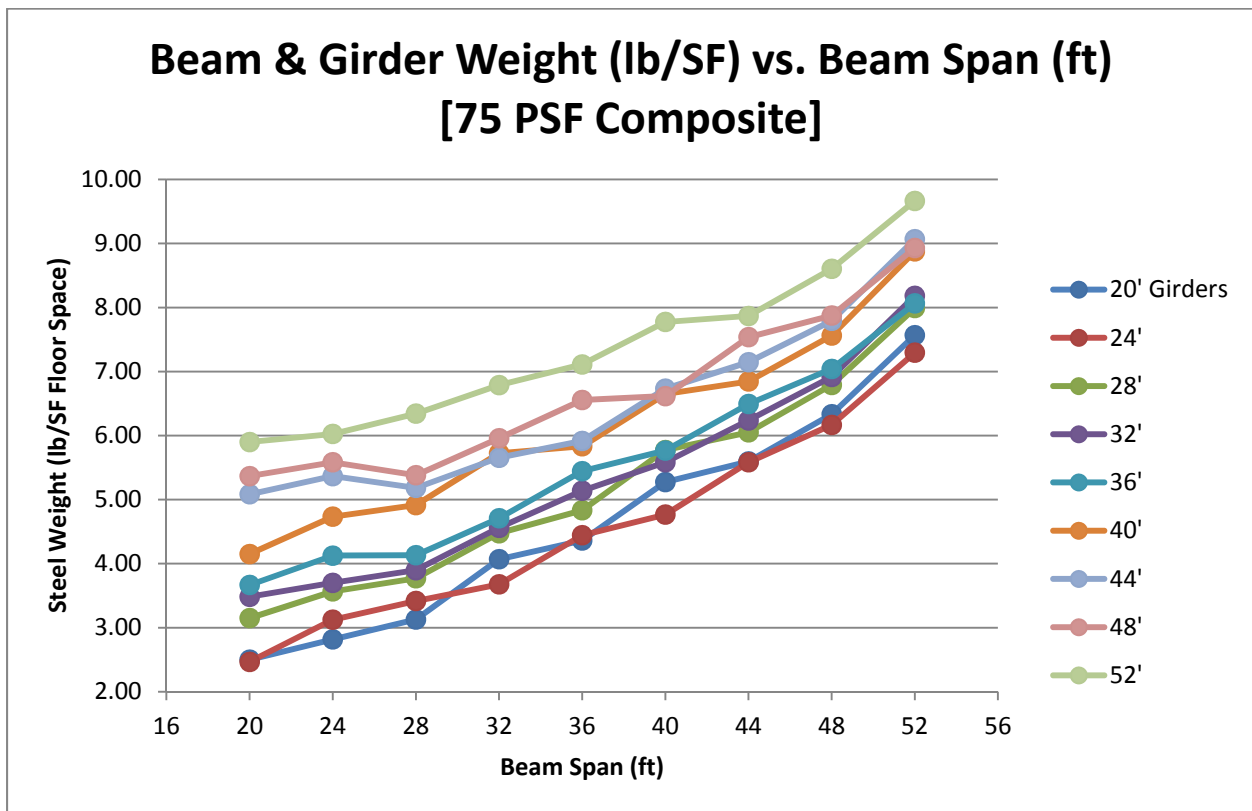
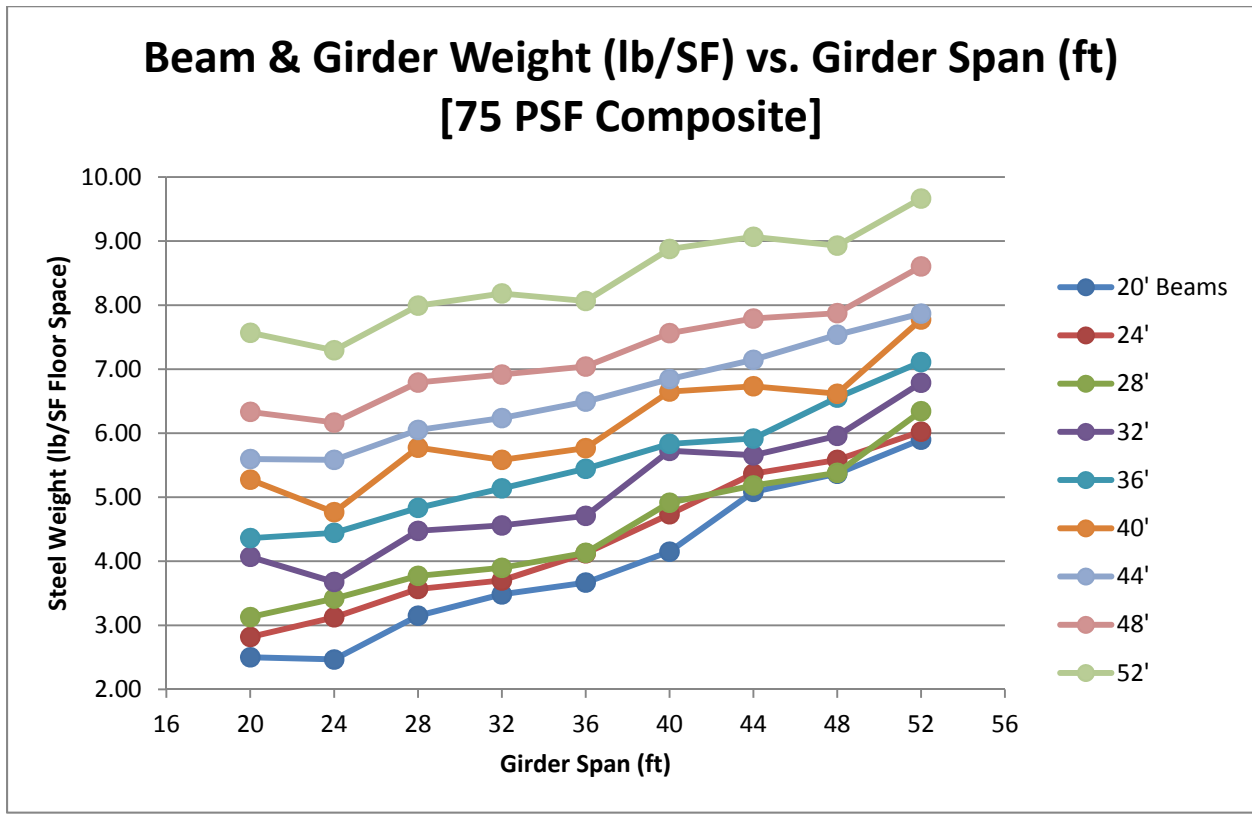

Beam & Girder Weight (lb/SF) vs. Bay Size (ft) [75 PSF Composite]

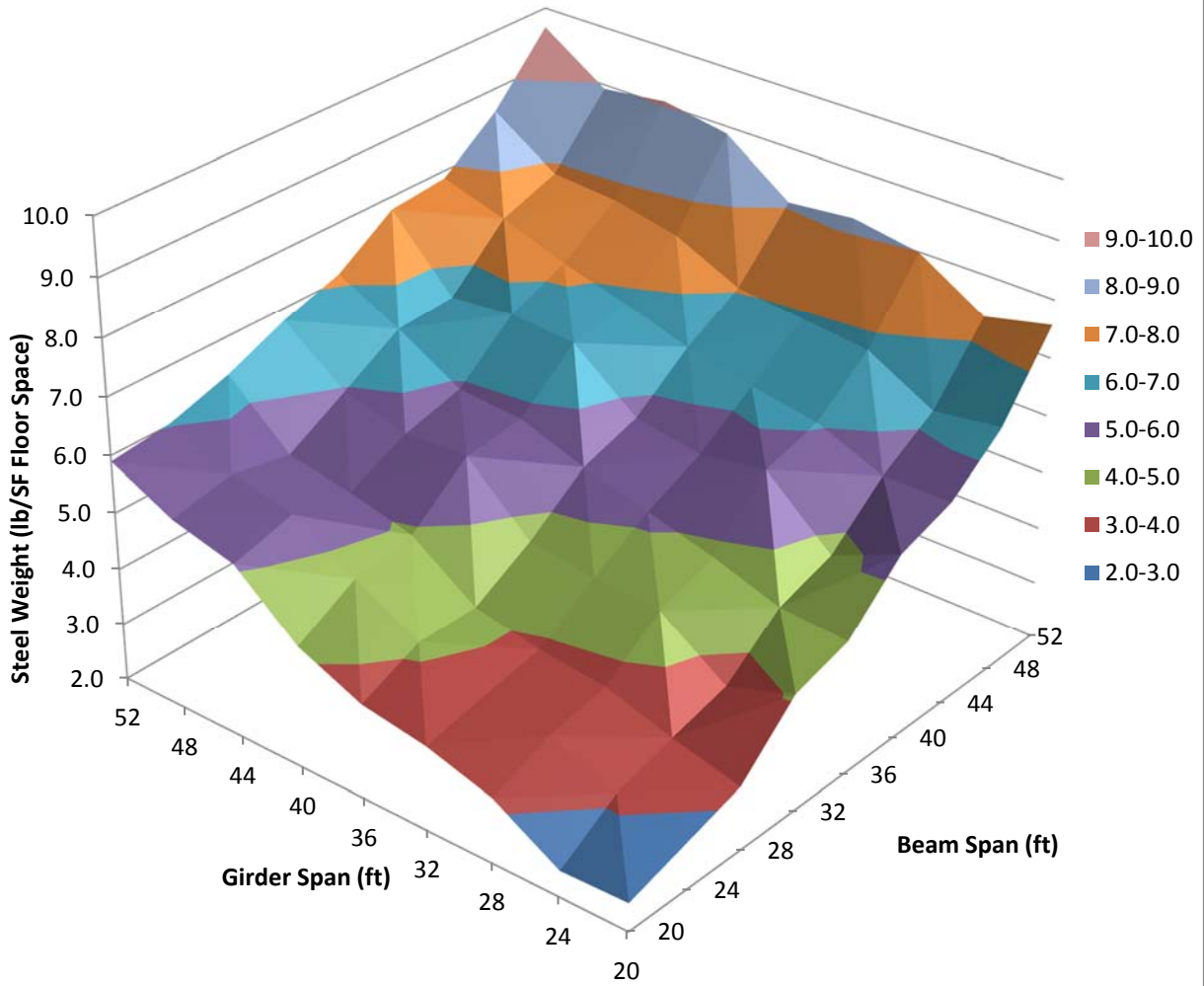

Column Weight (lb/SF) vs. Girder Span (ft) [75 PSF Composite]

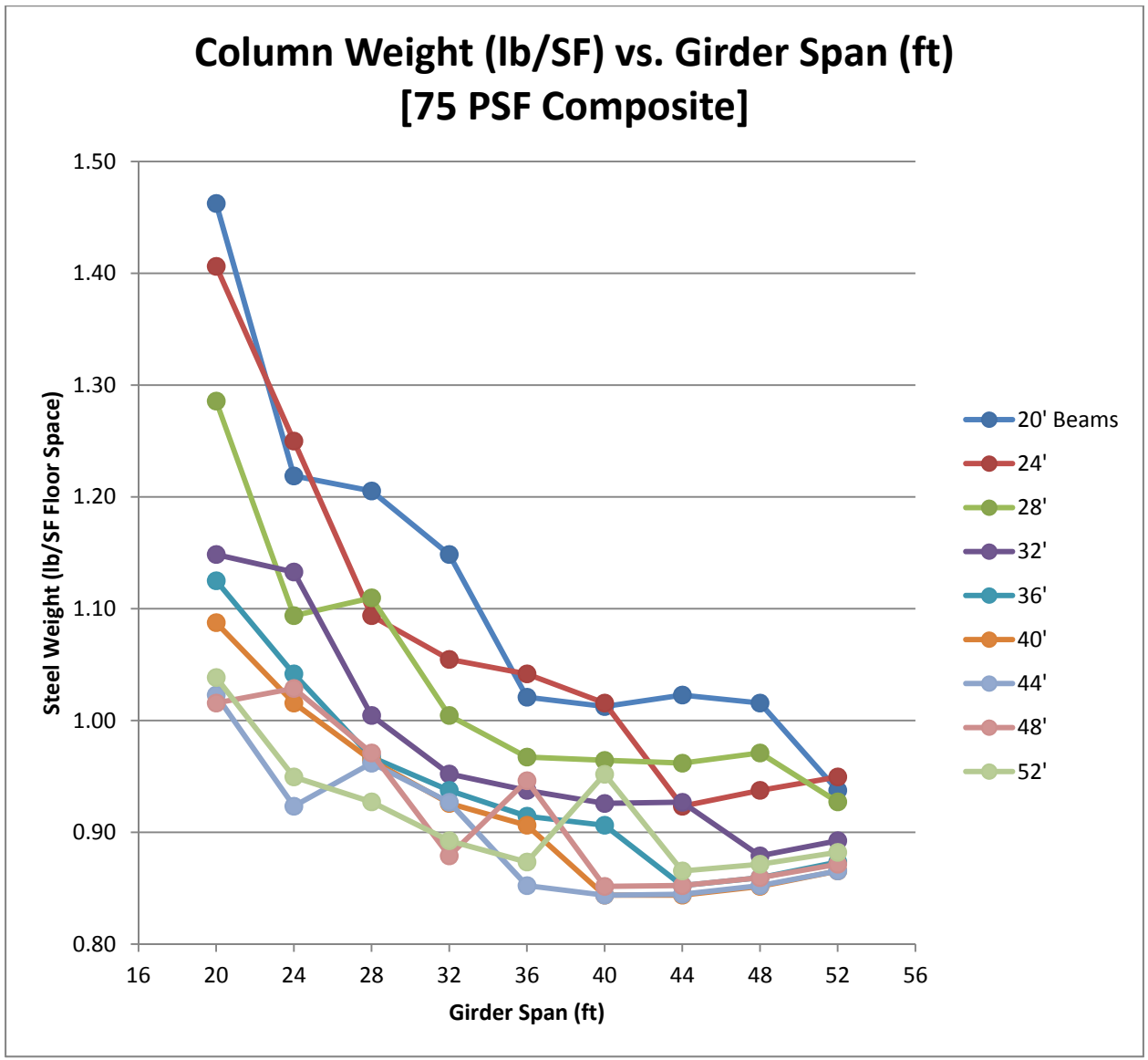

Total Composite 75 PSF

Total Steel Weight (lb/SF) vs. Beam Span (ft) [75 PSF Composite]

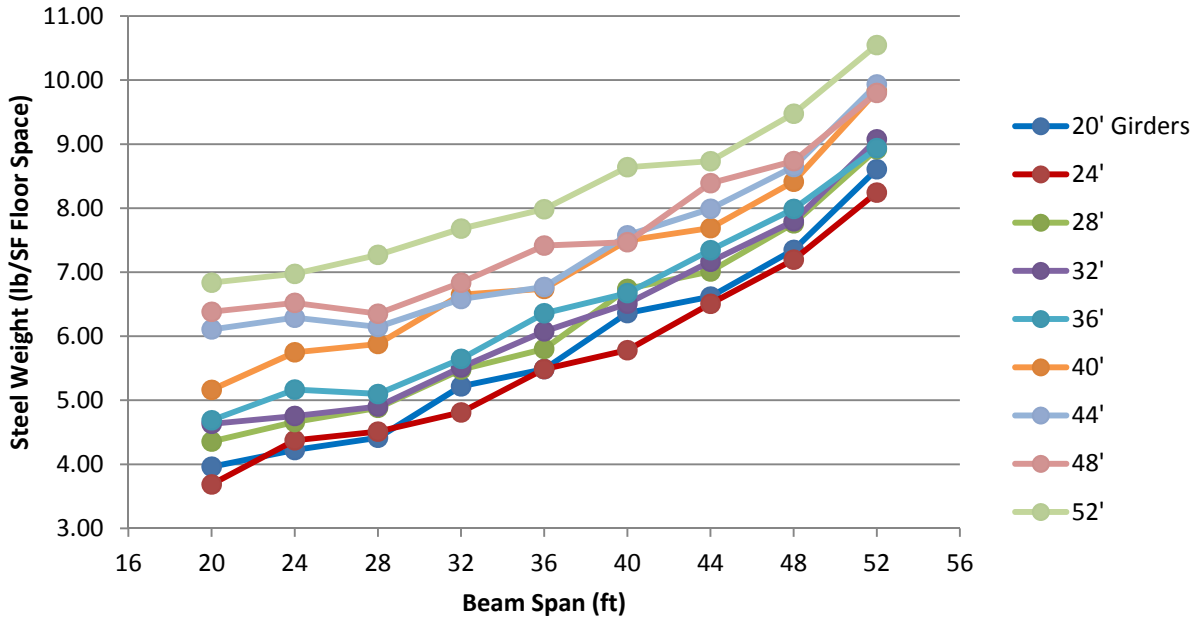

Total Steel Weight (lb/SF) vs. Girder Span (ft) [75 PSF Composite]

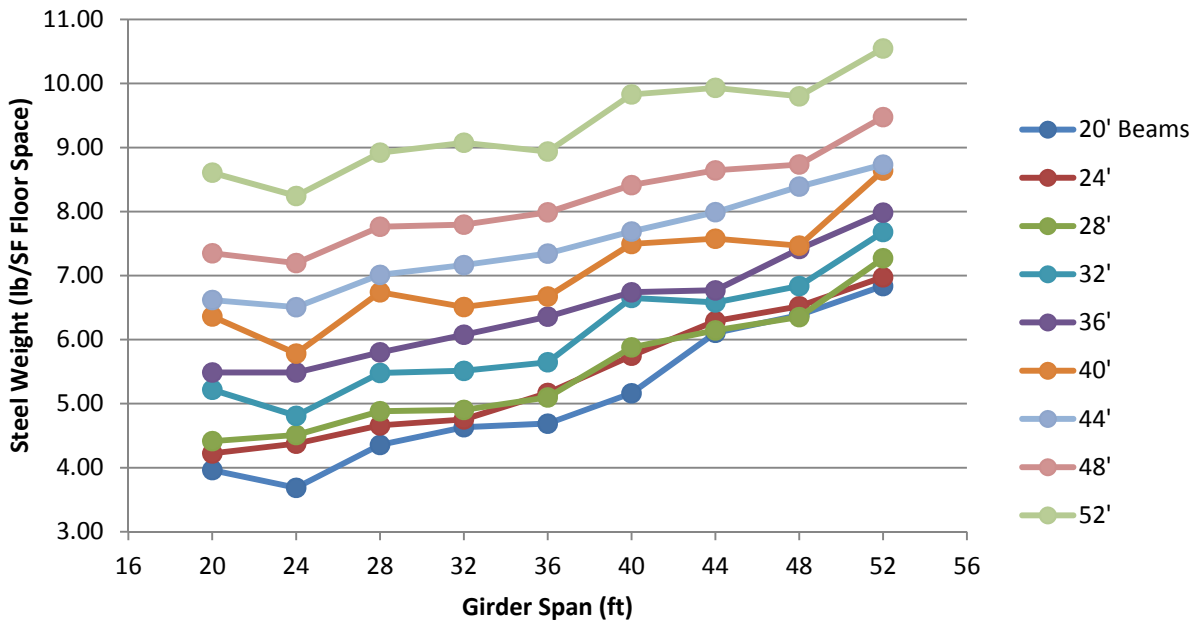

Total Steel Weight (lb/SF) vs. Bay Size (ft) [75 PSF Composite]

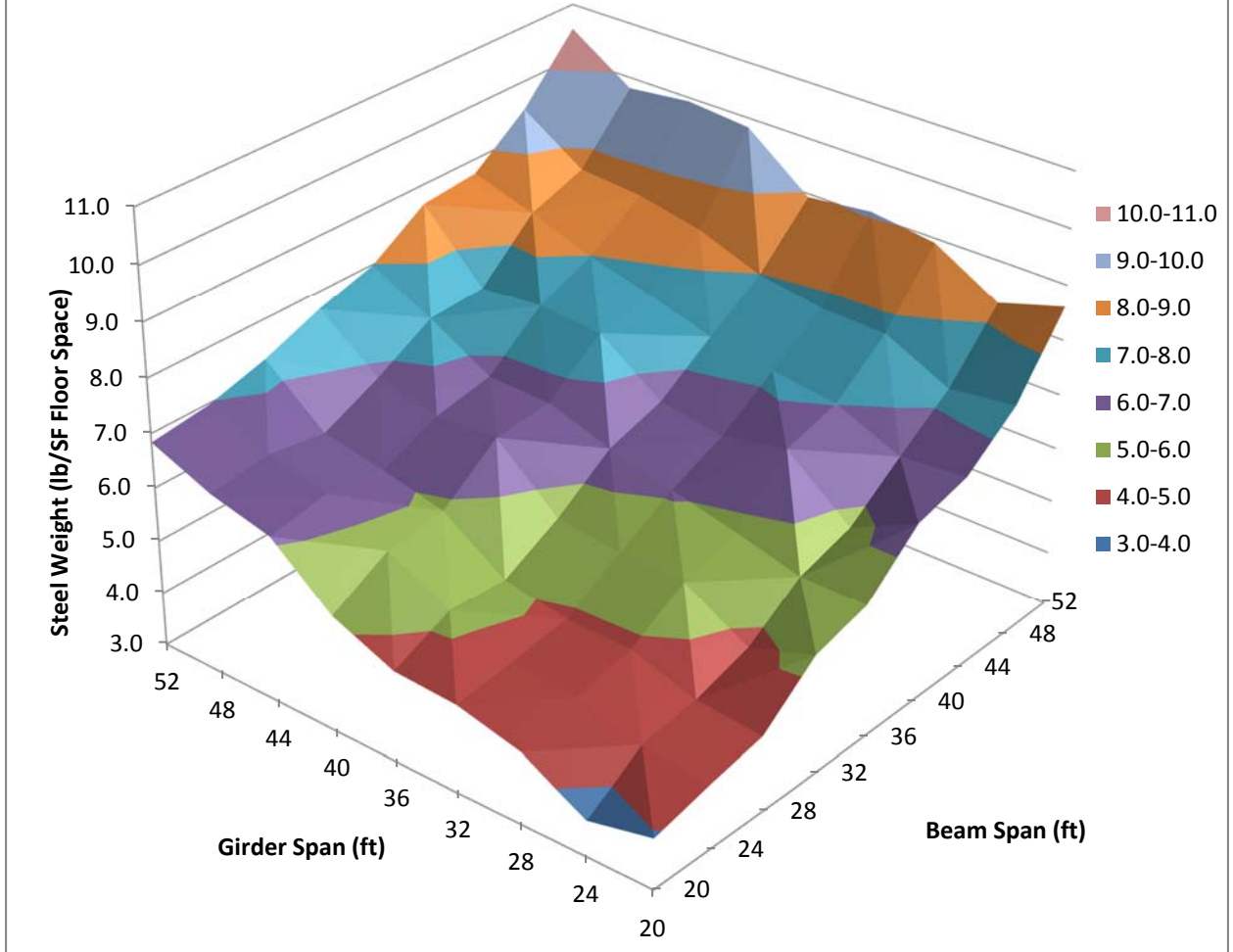

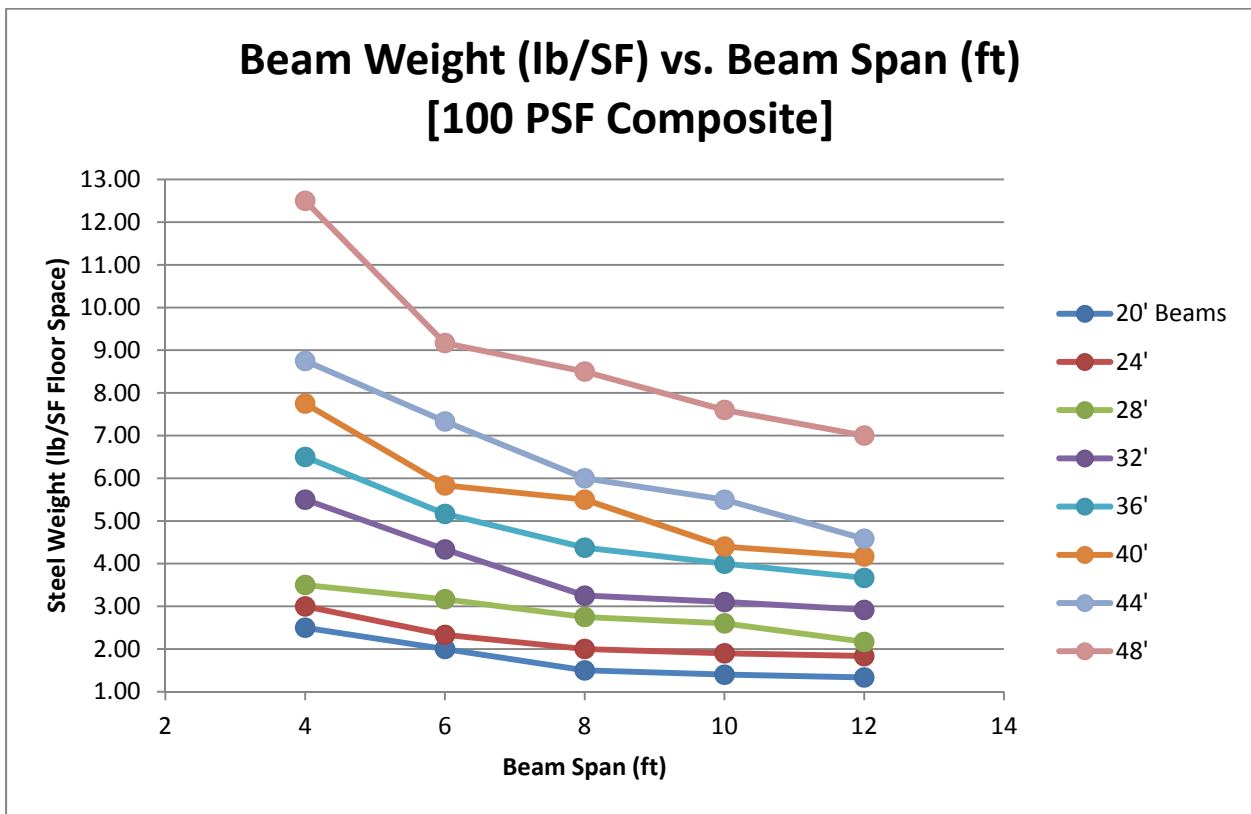
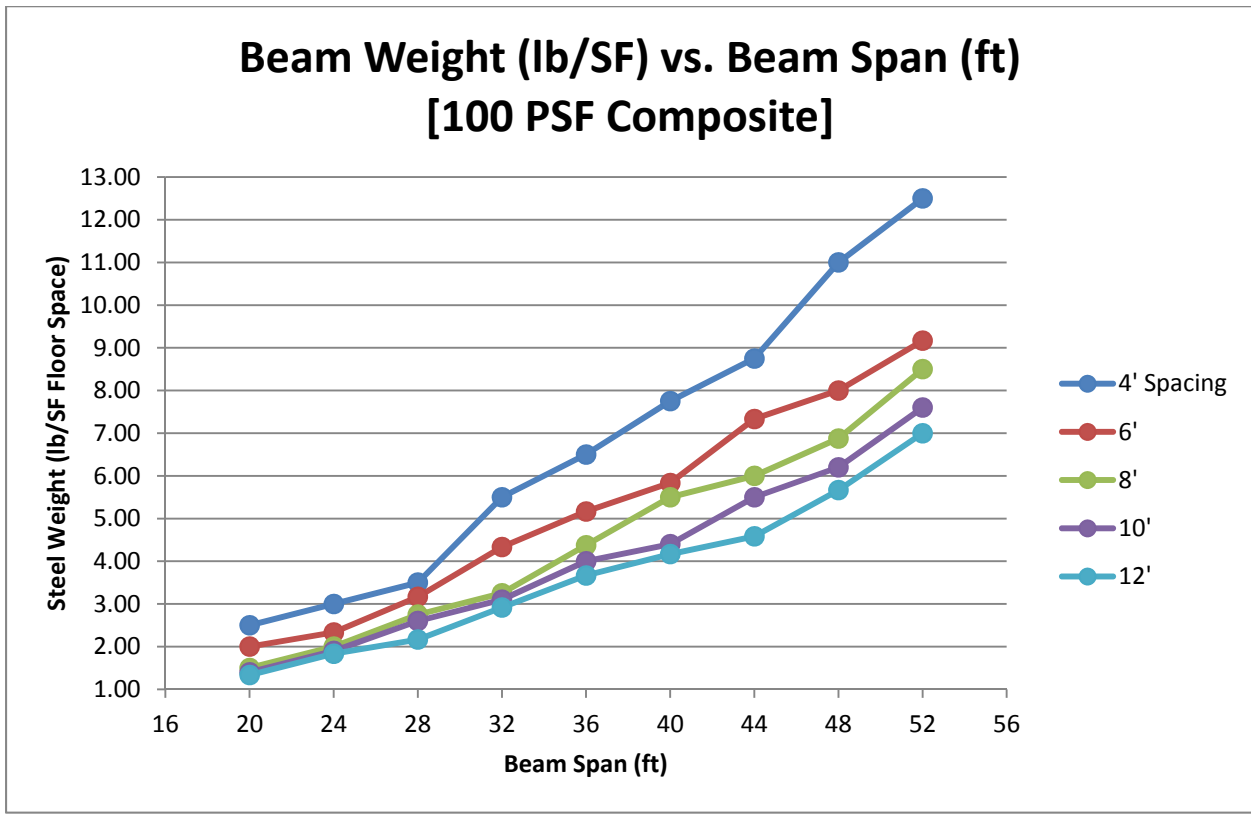

Beam Weight (lb/SF) vs. Beam Spacing (ft) [100 PSF Composite]

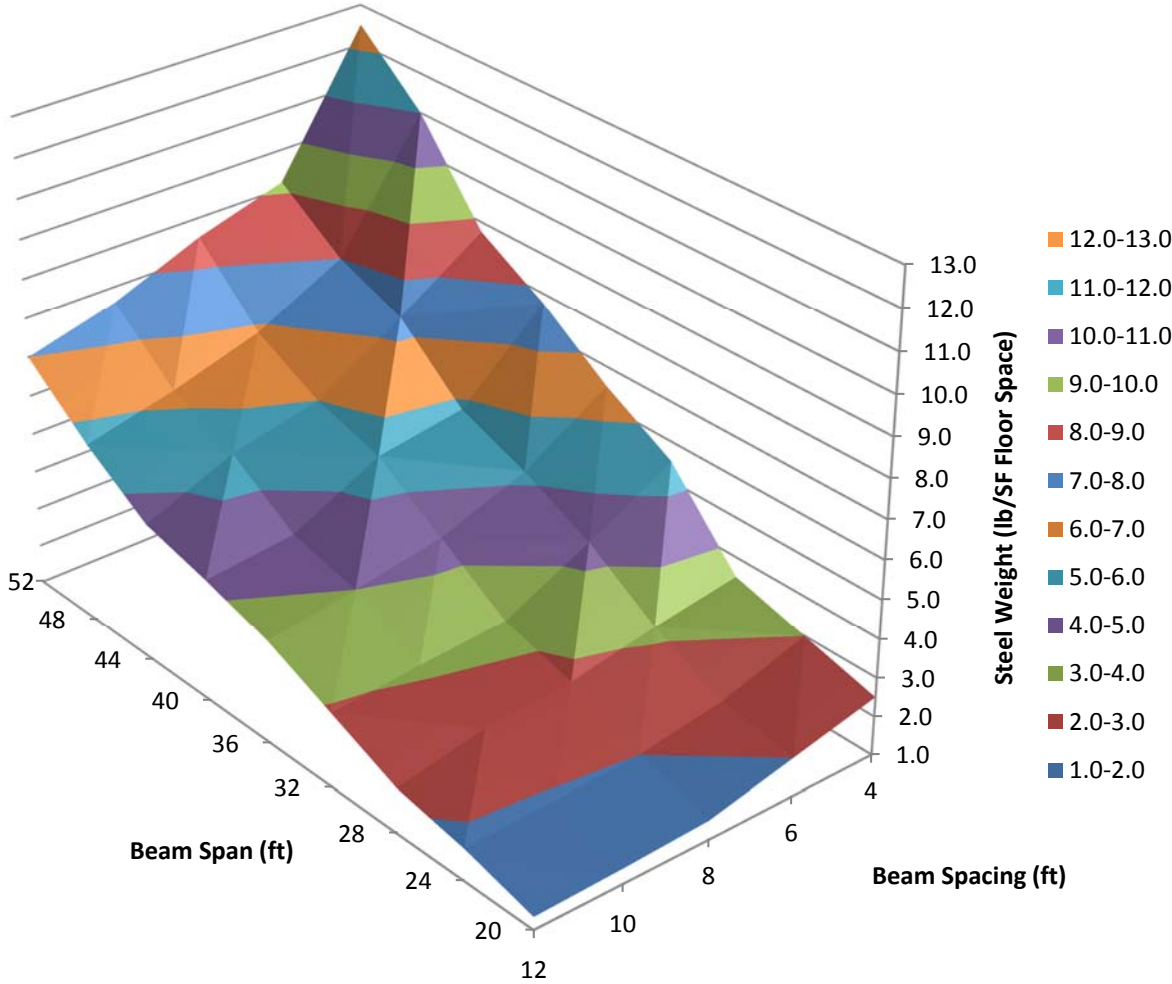

Girders

Composite

100 PSF

Girder Weight (lb/SF) vs. Girder Span (ft) [100 PSF Composite]

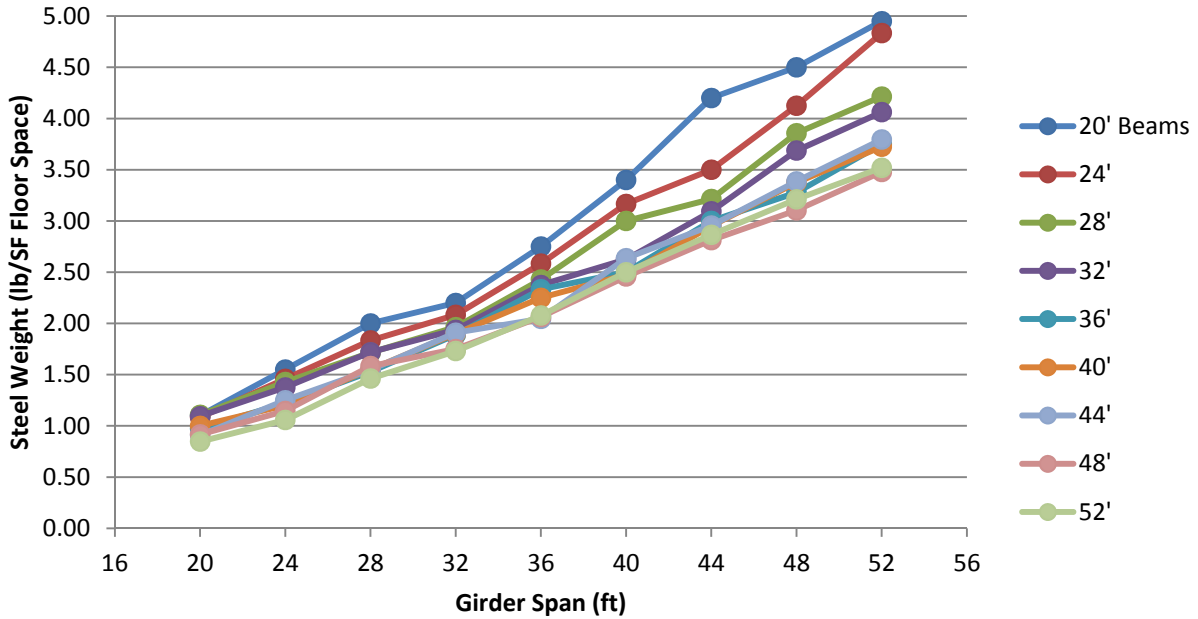

Girder Weight (lb/SF) vs. Beam Span (ft) [100 PSF Composite]

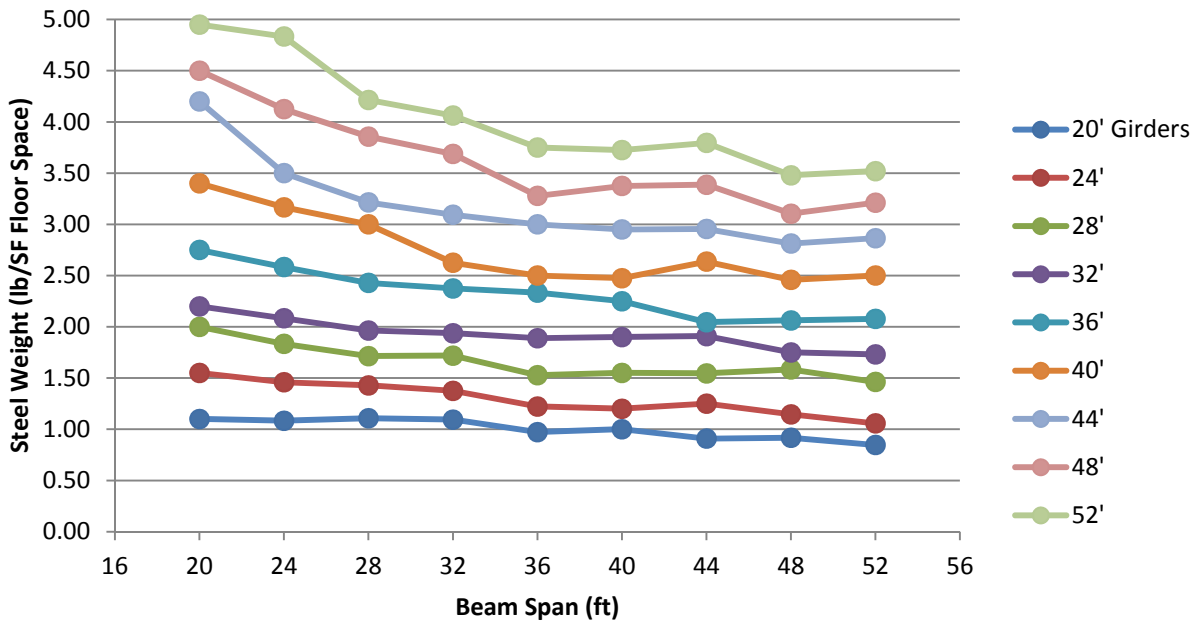

Girder Weight (lb/SF) vs. Bay Size (ft) [100 PSF Composite]

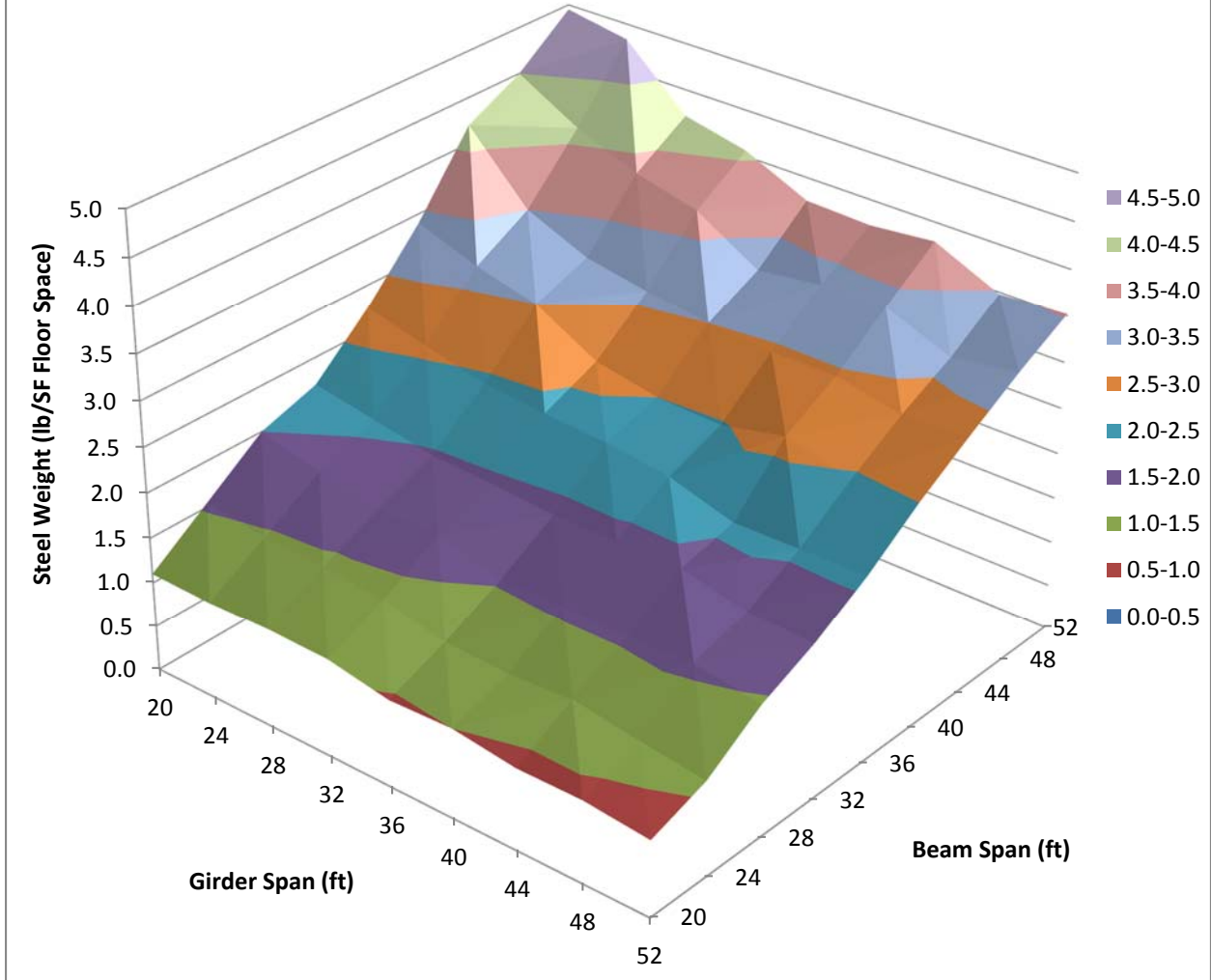

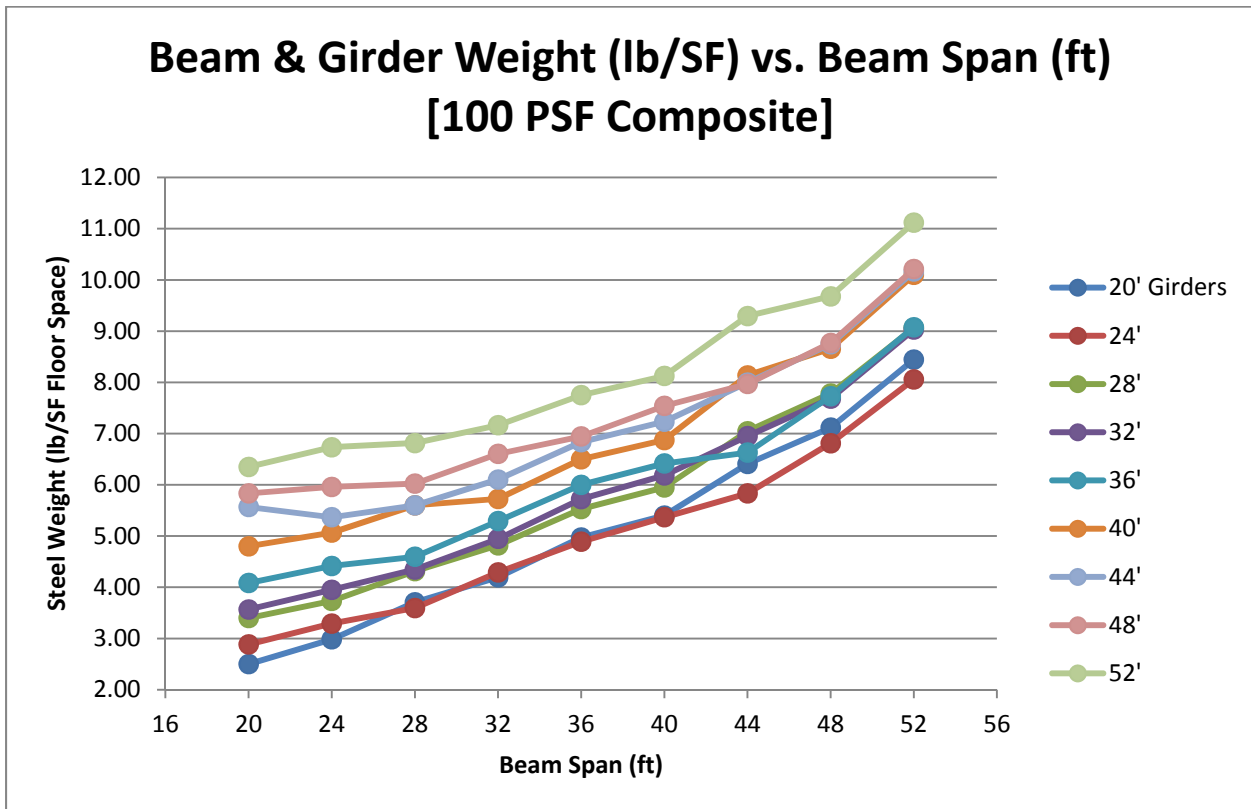
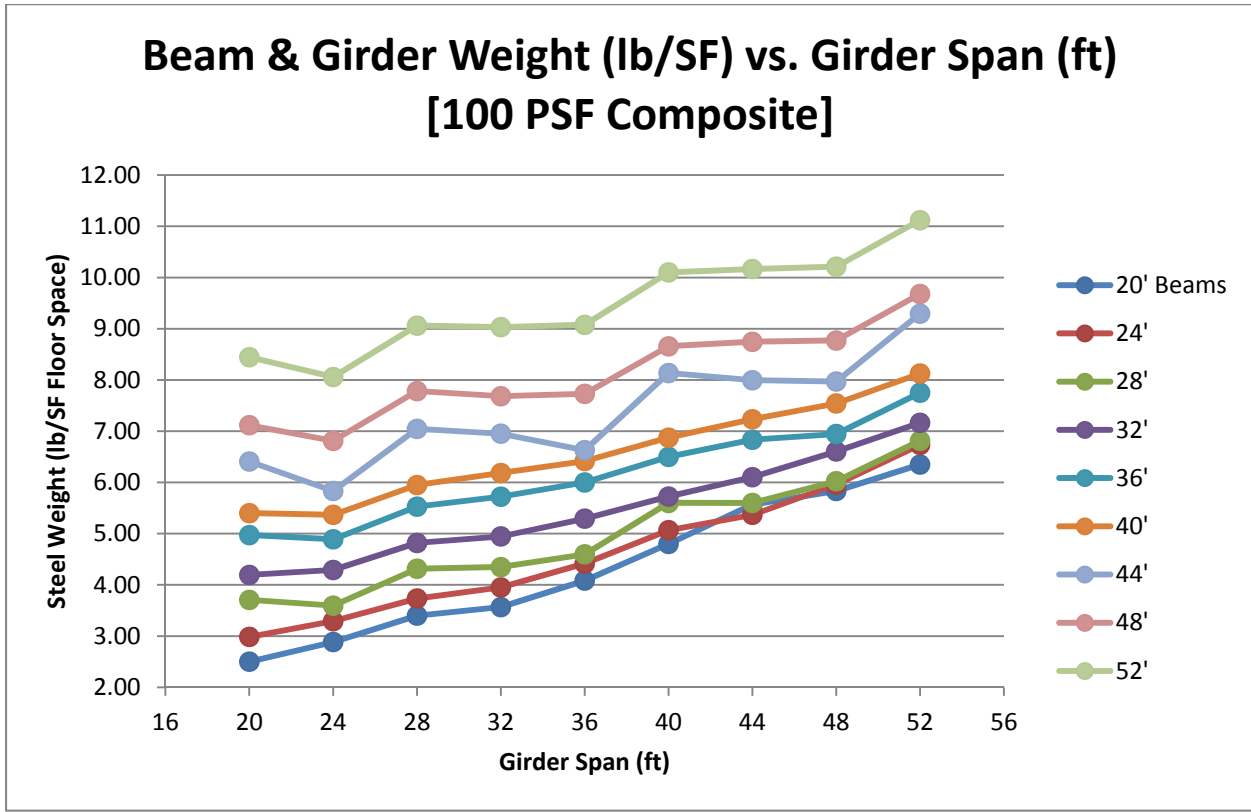

Beam & Girder Weight (lb/SF) vs. Bay Size (ft) [100 PSF Composite]

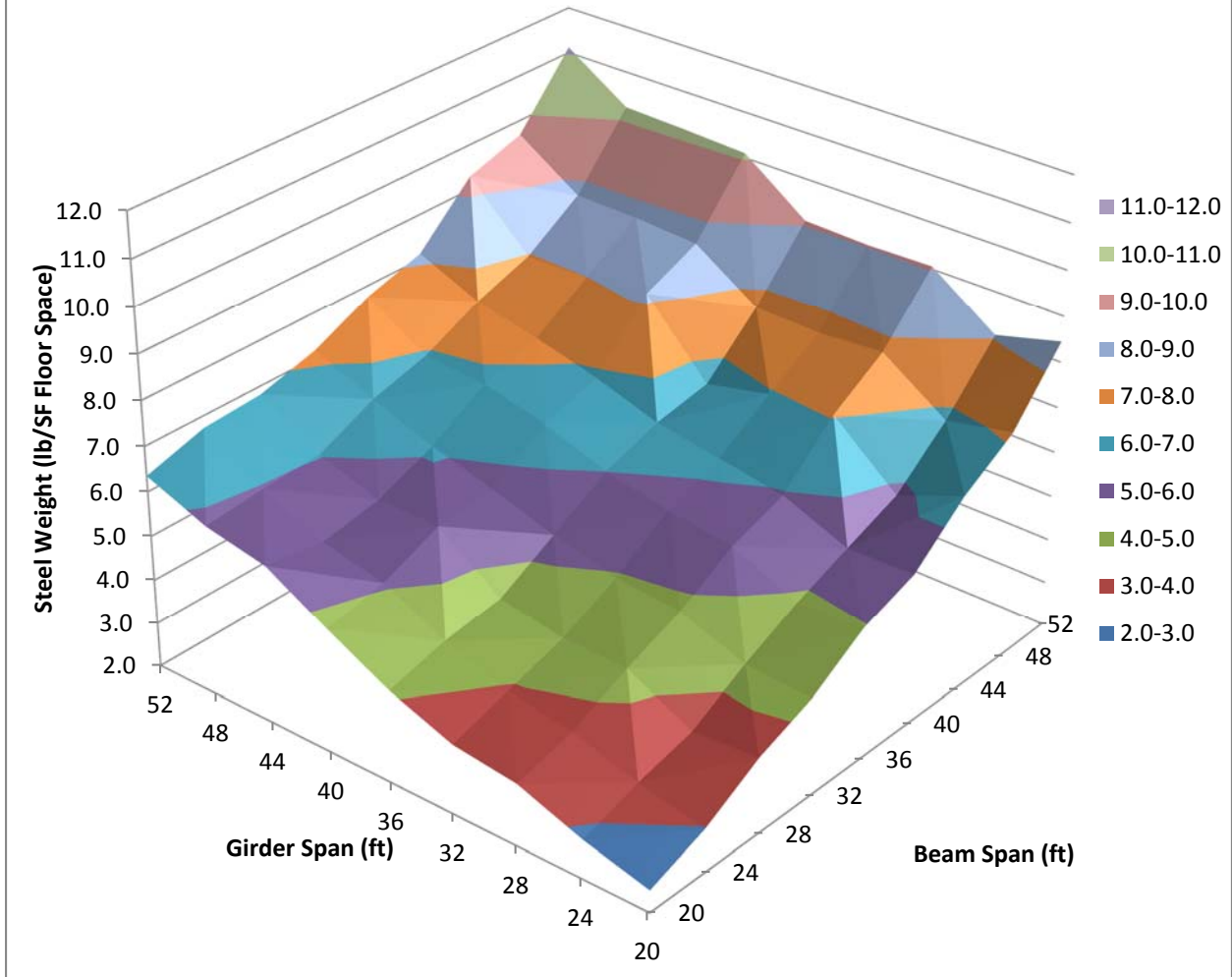

Column Weight (lb/SF) vs. Girder Span (ft) [100 PSF Composite]

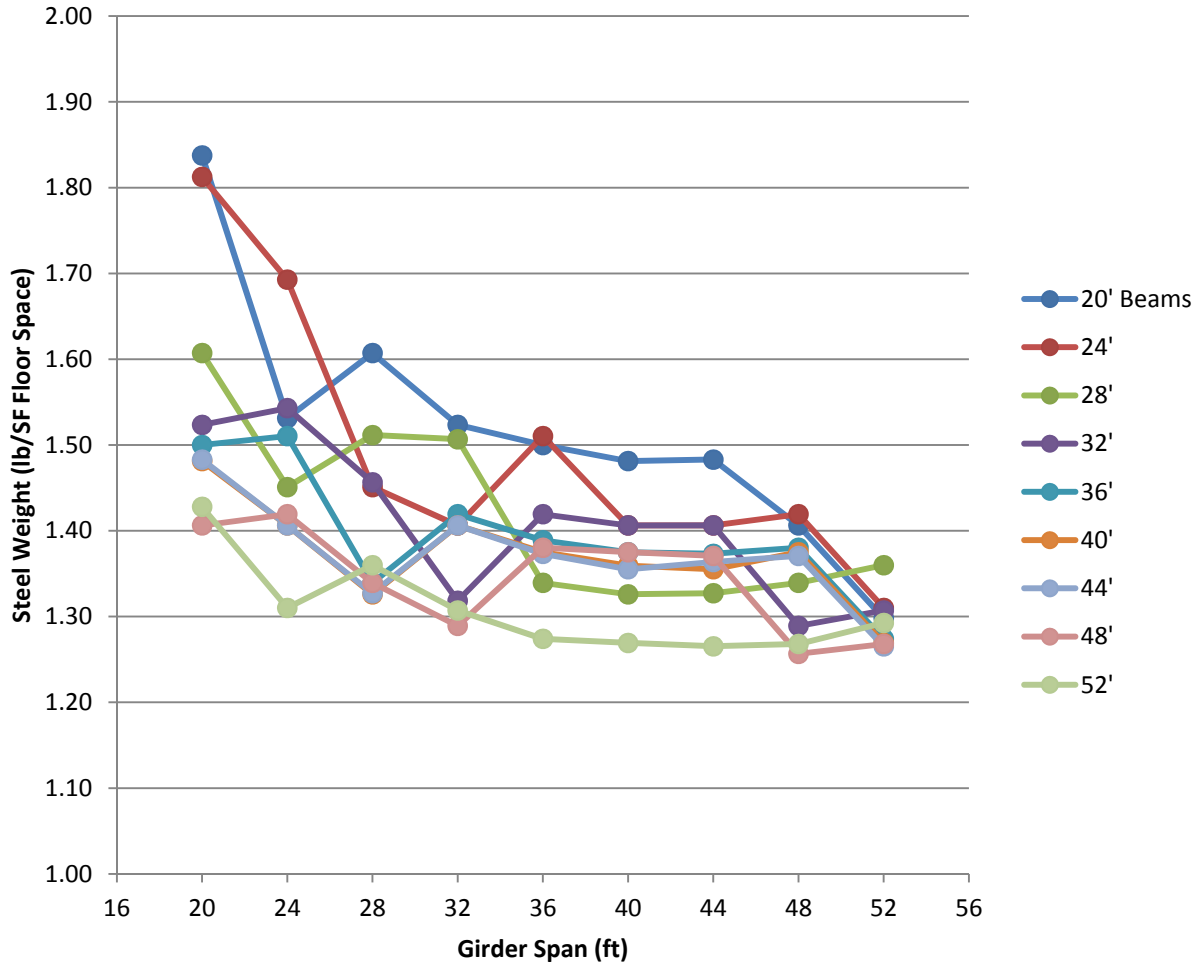

Total Composite 100 PSF

Total Steel Weight (lb/SF) vs. Beam Span (ft) [100 PSF Composite]

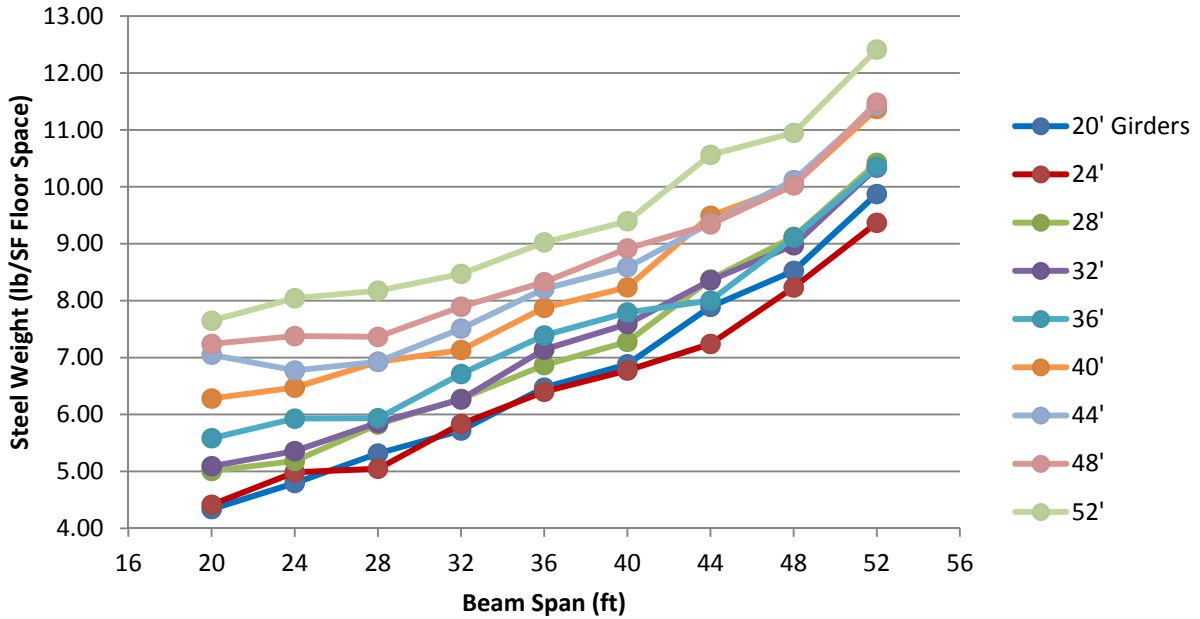

Total Steel Weight (lb/SF) vs. Girder Span (ft) [100 PSF Composite]

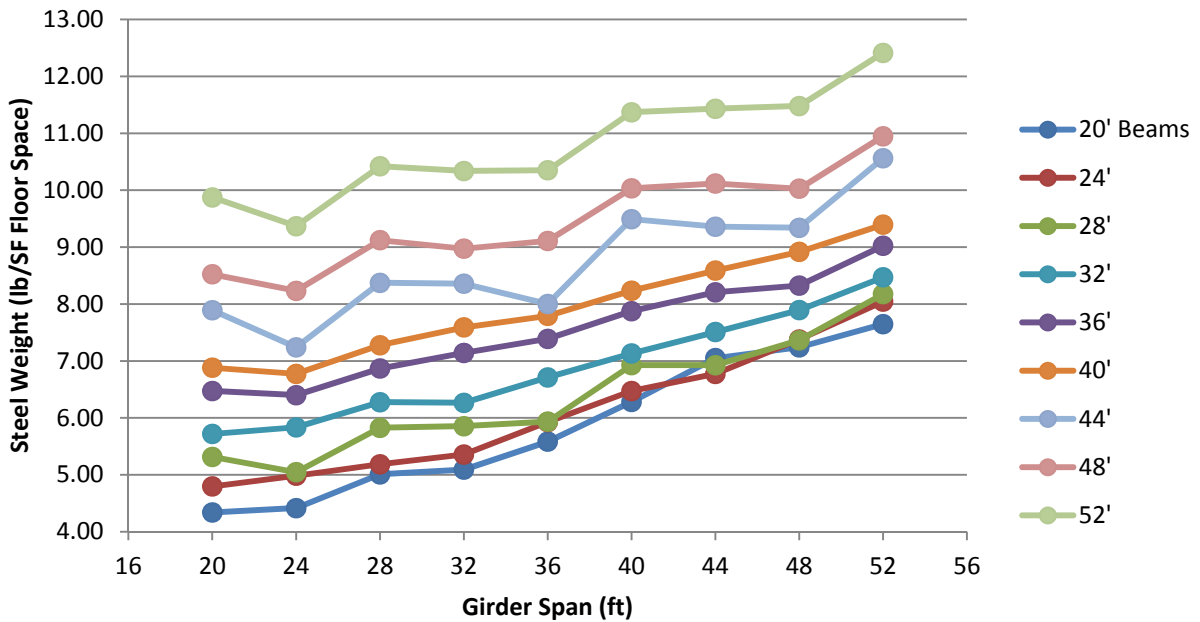

Total Steel Weight (lb/SF) vs. Bay Size (ft) [100 PSF Composite]

