

THE NATURE OF MAKING

RAPID PROTOTYPING IN ARCHITECTURE

**THE NATURE OF MAKING:
RAPID PROTOTYPING IN ARCHITECTURE**

by

MARK BACON

B.A., Kansas State University, 2004

A THESIS

Submitted in partial fulfillment of the
requirements for the degree

Master of Architecture

Department of Architecture
College of Architecture, Planning, and Design

KANSAS STATE UNIVERSITY
Manhattan, Kansas

2006

Approved by:
Major Professor
Matthew Knox

ABSTRACT

The purpose of this study is to examine how the industrial process of rapid prototyping might reshape practice and making in architecture. Rapid prototyping is defined as an accelerated, adaptive evolution of a system or its components in some form using computer-aided drafting and manufacturing.

Historically, all architecture was the intelligence of a single maker—the master builder. Specialization has caused architecture to fragment with architects serving only as designers. This report explores the ability of computer-aided drafting and manufacturing technologies to streamline the design procedure, which potentially increases the architect's input into the process of building. Effectually, the architect narrows the distance between the design and the built—returning the architect to the role of master builder.

An actual design exercise will examine the connection of architectural practice to making. To apply this research a habitable space was constructed through the incorporation of rapid prototyping.

TABLE OF CONTENTS

ii	—ACKNOWLEDGEMENTS
1	—OPERATIONAL DEFINITIONS
2	—ARGUMENT
9	—THEORETICAL BASIS
11	—DESIGN PARADIGM
13	—PROGRAM
15	—CONSTRUCTION INSTRUCTIONS
55	—CONCLUSION
63	—APPENDICES
64	—BUDGET
65	—LITERATURE MAP
66	—RESEARCH SCHEDULE

ACKNOWLEDGEMENTS

Many thanks to:

My wife: Jackie Bacon

Committee: Matthew Knox
Todd Gabbard
Allan Hastings

Editor: Mick Charney

Moving crew: Brad Buser
Chad Joyce
Joel Salts
Adam Bacon
(not pictured)
Mick Charney
Justin Helmbrecht

Facilities: Wendy Ornelas
David Sachs

Site & Materials: Tom Dill

Machining: Codie Phelps—AMI

Funding: Jeff Bremyer—Midwest Industries



OPERATIONAL DEFINITIONS

Rapid Prototyping:

the accelerated, adaptive evolution of a system or its components in some form using computer-aided drafting and computer-aided manufacturing.

Versioning:

recent shift in the way architects and designers use technology to expand potential effects of design

Master Builder:

intelligence of a single maker: part architect, part builder, part product and building engineer, and materials expert

Mass Customization:

the ability to mass-produce one-off, highly differentiated building components with the same facility as standardized parts without increasing costs.

Process Engineer:

dictating a series of actions, changes, or functions resulting in a plan or construct; typically associated with automobile, aerospace, or shipbuilding industries.

CAD:

computer-aided drafting

CAM:

computer-aided manufacturing

CNC:

computer numerical control

RP:

rapid prototyping

STL:

stereolithography computer file type; typical to CAD/CAM applications

ARGUMENT

Compare the state of architecture to the advances in the design and fabrication of automobiles, airplanes, and ships. These industries offer new materials and processes paralleled with the advancement of technology. Fabrication times have been drastically reduced along with production cost and waste. The end result of this advancement is the exponential growth in quality. The quality produced is inconceivable to any earlier parallel experience¹.

In these industries the process engineer is triumphing. In contrast, architecture remains content to focus on aesthetics rather than the substance of making. The process engineer moves past aesthetics into a deeper understanding of the substance of making. The main concern is the relationship between cost and time versus the quality and scope for the process engineer².

Likewise, design has extended far beyond the assembly line to embrace the complete life cycle of products. Unfortunately architecture has missed this opportunity, as it has tendencies to be wasteful, disposable, fragmented, and highly specialized³. Counter to architecture, the process engineer identifies the boundaries between designers and makers as a

catalyst to erode those very boundaries, not reinforce them. The nature of this catalyst exposes questions necessary to ask of the architecture field. Why is architecture immune to this transformation and progress? Why is it that today's master builders are not architects, but process engineers?

Architecture can rid itself of fragmentation through the agent of information tools—the computer. Master building through the computer integrates skills and intelligence inherent in architecture. It is arguably the most important visual tool that can be used to redefine space⁴. Architects can move away from traditional architectural explorations with the advent of the computer—repositioning it as a powerful tool.

This new form of communication has replaced the traditional tools of architects—communication is the new tool. It allows architects and collaborators to conceive, discuss, explore, and understand every detail before it is produced. As a result the process is accessible to all, including the user and the client. This accessibility no longer limits architects to the representation of physical ideas—they can now be fully pre-formed⁵. This composite un-

derstanding of architectural elements offers a deeper understanding before it actually becomes built.

Mass Customization

Mass-production was the ideal of the early twentieth century. Mass-customization has recently emerged as the reality of the twenty-first century⁶. Architecture has always encouraged unique solutions to designing buildings resulting in a one-off built approach. Each building may be similar to the next but is slightly different in its response to a certain unique situation. Therefore architecture as mass-customization is a hybrid. It is a proponent for a new building process using automation techniques, but it has the ability to evoke differentiation in each object in comparison to those that are built before it—in essence the one-off principle. Differentiation is distinguished in architecture based upon the site, its generative use, and perceived desire. With these prerequisites the computer allows for architecture to be customized through visualization and off-site fabrication. With as much as

systems (heating/cooling, data, and the like) and not structure, walls, and roof the need for a paradigm shift is unavoidable⁷.

The Architect: the Master Builder

Hundreds of years ago all architecture could be understood as the intelligence of a single maker—the master builder. The master builder was part architect, part builder, part product and building engineer, and a materials expert. The role of the master builder was summed up in the integration of all these respective parts. Architecture has been reduced to specialization, eliminating the once harmonious hand of the master builder. Specialization has caused architecture to fragment—architects now just play the part of the designer.

For most of our history, making by hand was the only option to fabricate objects. A great deal of effort was expended in order to create. In this context the designer was often the maker. A stable was built by the one who designed it; the factory was built by the owner for the unique needs available to the industry at hand. Therefore designing and building could not be separated.

Fundamentals of Rapid Prototyping

Rapid prototyping affords the opportunity to seek innovation. Instead of using clever ideas to come up with finished prototypes, the prototypes themselves drive the innovation process⁸. Greater room for exploitation in the manipulation of the design creates a greater degree of innovation. The process is allowed to adjust to changing conditions without being locked into a rigid paradigm.

Design through rapid prototyping is not seen as a static process controlled by fixed parameters—it is dynamic and nonlinear, and it is not necessarily a tripartite process with a definite beginning, middle, and end⁹. It is an evolution. What this encourages is a highly collaborative, interactive evolution that changes the practice of architecture.

Rapid prototyping [RP] is normally associated with designers and their products. However the designers are usually limited to the fields requiring computer-aided drafting [CAD], computer-aided manufacturing [CAM], and computer numerically controlled [CNC] machines as the means of production. Without CAD, the emergence of RP systems

could not have been possible.

The fundamental nature of RP common to all techniques in the industry are models or components that are generated by a CAD system, then integrated with CAM machines. The model represents the physical part or component that is to be built. The computer traces the surfaces while simultaneously translating the surface coordinates to the machine. For this to occur a surface model must be converted to a 'STL' file which originates from three-dimensional models¹⁰. The file conversion approximates the surface by polygons. Curved objects use numerous polygons to translate the surface into a machinable piece. A computer then will use the STL file to determine cross sections of the generated model to systemically recreate a built prototype.

Automated RP is extremely fast which highlights direct and indirect benefits. The best feature about RP is the ability to produce physical objects or components with precision extremely fast to act as an experimental piece. Complex surfaces and contouring can be explored through this procedure to test the design. In fact RP is up to ninety percent more

efficient in the evolution of production than historical counterparts in manufacturing¹¹. That is to say that a product can be designed and seen through the built process ninety times faster than the traditional production process. The steps RP removes are detailed shop drawings describing the parameters of the part or component and the need to assemble and test the product. Rapid prototyping models become the detailed shop drawings and the assembly is tested within the computer. It effectually simulates the entire functionality along with probable production processes. The design is calculated, visualized, analyzed, and simulated within the computer before the part or component is translated to the machines¹².

Benefits to designers are based on the complexity of the part or component. Less significance can be placed on lead-time or cost because the numerically controlled computer resolves the complexity. Organic, sculptured shapes can be accommodated for functional or aesthetic reasons. Each piece is highly customizable to fit client requirements with little restraint or restriction in manufacturing. Reduced component count during the manufac-

turing process is an advantage as single pieces can be combined in a precise manner with the CNC machine. With fewer parts the time spent on the design process to consider more tolerances, detailing joints, and assembly drawings is reduced. By using RP, the material chosen to build the component can be exploited due to the lack of restriction on nominal material sizes. Off-the-shelf materials are not needed to fit neatly within the machining or manufacturing process.

The indirect benefits include marketing and consumer satisfaction. New capabilities and opportunities excite people. Products that meet consumer needs are quick to reach the market for purchase. The consumer benefits because there is a quality product that can be purchased that meets more closely their needs and wants. With a much wider diversity of products that can be purchased and the possibility of a built-to-order option the consumer becomes directly involved. The supply and demand phenomena holds true in this case and lowers prices of the product since the manufacturing process was shortened.

Versioning

Much can be learned and applied to architecture through the understanding of the master builder concept and the newest technologies available. First the technologies must be understood in their abilities to transcend the original intent for them. The computer information age is a monumental breakthrough for architecture that has been a catalyst to shift the traditional paradigm.

SHoP architects have coined the term ‘versioning’ to describe the recent shift in the way architects and makers are using technology to expand the potential effects of design¹³. They have moved past the computer used simply as a visual tool to an understanding of the computer as a building tool. Technology offers the opportunity to promote technique rather than an image—as in a computer-generated rendering. Pixel-based simulation is an inadequate adaptation of a computer because it does not allow information to evoke immediate results that can be transformed and refined. The immediate results allow the evolving designs to become accelerated and adaptive in unison. Borrowing across disciplines such as film, fi-

nance, and manufacturing industries tactics can be reconstituted to fit the scope of architectural practice. The most important aspect of versioning is the attempt to remove architecture from a stylistically driven consumerism¹⁴—again; substance has been substituted for appearance.

Computers have enabled architects to rethink design processes in terms of procedure and outcome. The boundaries are blurred between architect and builder. The traditional hierarchical system created to construct a building has collapsed in the wake of inserting technologies foreign to architecture. Restructuring the traditional hierarchical system leans toward team collaboration evident in the master builder concept. The design is no longer a horizontal integration where designers simply generate a representational form. The process has been restructured in a vertical orientation where designers are directly responsible for the conception of space, how it is constructed, and what the effects are culturally¹⁵.

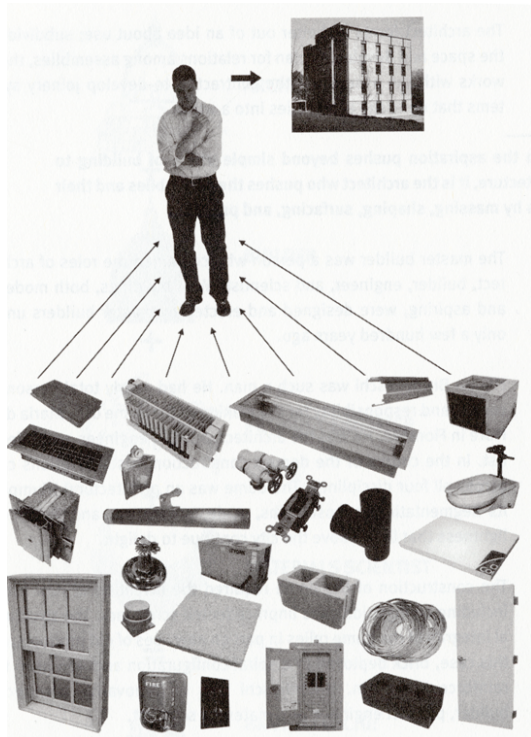

[source: Kieran, Stephen and James Timberlake. 2004. Refabricating architecture: how manufacturing methodologies are poised to transform building construction.]

7 All parts of the building are channeled through a single maker controlling the final built project.

END NOTES

- ¹ Kieran, Stephen, and James Timberlake, *Refabricating architecture : How manufacturing methodologies are poised to transform building construction* (New York: McGraw-Hill, 2004).
- ² *ibid*, 9.
- ³ *ibid*, xi.
- ⁴ William E. Massie, “Remaking a post-processed culture,” *Architectural Design* 72 (2002): 55.
- ⁵ *ibid*, 56.
- ⁶ Kieran et al., *Refabricating architecture*, 105.
- ⁷ Michael Speaks, “Design Intelligence: Or thinking after the end of metaphysics,” *Architectural Design* 72 (2002): 4.
- ⁸ C.K. Chua et al., *Rapid prototyping: principles and applications* (Singapore: World Scientific, 2003).
- ⁹ *ibid*, 1.
- ¹⁰ *ibid*, 11.
- ¹¹ *ibid*, 6.
- ¹² Ingeborg Rocker, “Versioning: Evolving architectures—dissolving identities,” *Architectural Design* 72 (2002): 11.
- ¹³ William Sharples et al., “Introduction,” *Architectural Design* 72 (2002): 7.
- ¹⁴ *ibid*, 7.
- ¹⁵ *ibid*, 7.

THEORETICAL BASIS

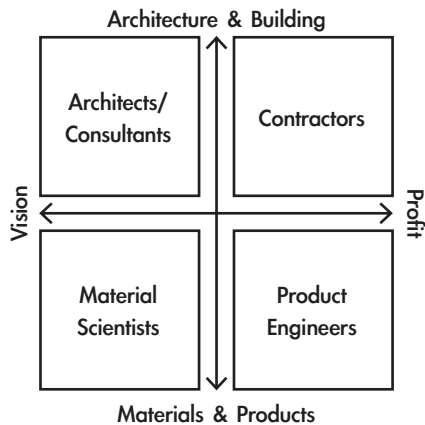

[source: Kieran, Stephen and James Timberlake. 2004. *Refabricating architecture: how manufacturing methodologies are poised to transform building construction.*]

Four separate professions comprise the structural model to design and implement a building. The current architectural procedures are segregated and stratified among the professions. Each discipline secures a compartmentalized relationship to the other resulting in no collective intelligence. Designers have been isolated from makers.

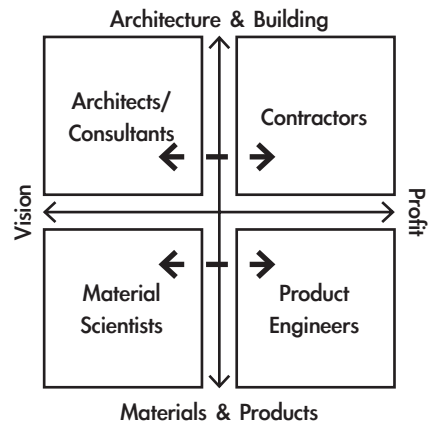

[source: Kieran, Stephen and James Timberlake. 2004. *Refabricating architecture: how manufacturing methodologies are poised to transform building construction.*]

Little communication exists between disciplines in this structural model. The communication evident is not a sound depiction of a true communicative relationship; rather it is relegated to a hierarchical one based on a specialized role. For instance, an acoustical consultant provides calculations for an architect.

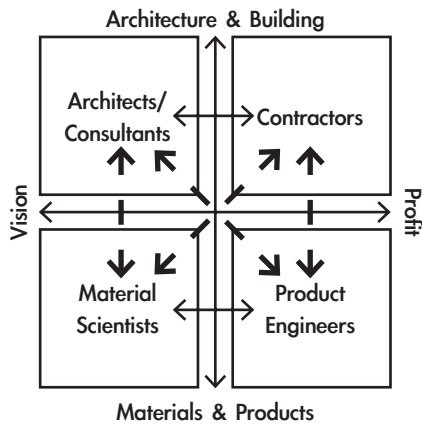

[source: Kieran, Stephen and James Timberlake. 2004. *Refabricating architecture: how manufacturing methodologies are poised to transform building construction.*]

Reciprocal relationships can be developed where collective intelligence in the design and the built is recognized. Designers can be reintroduced to making—removing the linearity and hierarchical production. Rather than segregation between disciplines, the collective mind of a single maker or team of makers inspires a paradigm shift in practice and making.

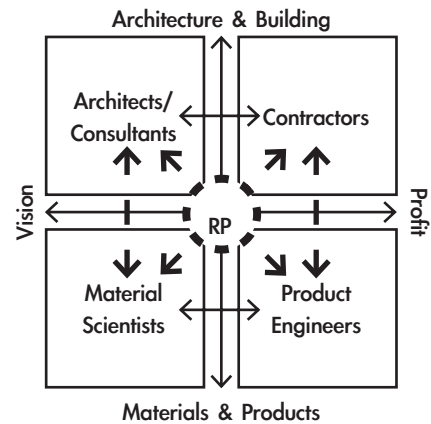

[source: adapted from Kieran, Stephen and James Timberlake. 2004. *Refabricating architecture: how manufacturing methodologies are poised to transform building construction.*]

In order to revolutionize the relationships in designing and making an agent must be introduced. The agent must be capable of sharing information instantaneously through an open communication network. By introducing rapid prototyping processes into architecture communication is no longer bounded by disciplines alone.

DESIGN PARADIGM

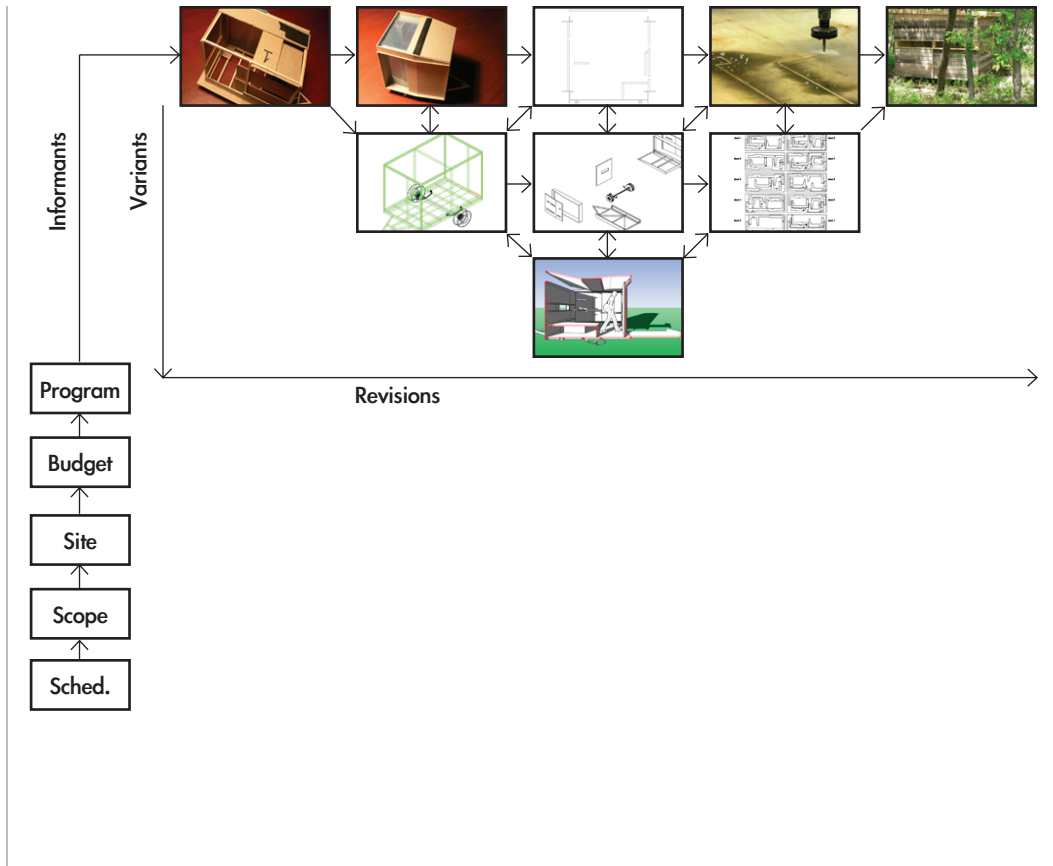

The illustration depicts the formative design process using rapid prototyping technology. Typical program informants control the initial design. As the design evolves, revisions and variants begin to impact one another. Constant collective intelligence streams from a single maker or team of makers to influence the design. Seen in the illustration is this instantaneous flux of communication determining the design. The original design may proceed to a revision, then be altered based upon an information exchange shown by a variant. The design then could move to the next revision stage or on to another variant. The design process is contingent upon the collective intelligence feeding the information tool. Another unique aspect about the design structure of a rapid prototyped project is the ability to test quickly a result. For instance, outputting the design to respective CAD/CAM machines could test a revision. If the resultant product is not acceptable the process begins where it left off. It has the uncanny ability to return to previous steps or continue on.

PROGRAM

Introduction

The focus of this project is to incorporate rapid prototyping procedures to identify a (re)connection of architectural design to fabrication. Careful attention will be placed on the design process as it seeks to potentially increase the architect's input into the fabrication process. In addition strong spatial understandings and spatial extensions should be considered. Focusing the attention on these investigations supports the development of four imposed objectives:

- The elimination of construction drawings
- Choreography of on-site construction—joinery, components, and the like.
- Use of off-the-shelf materials
- Portability with environmental and contextual issues considered

Project

The project will be predicated on an analysis of rapid prototyping procedures. Concurrent with the analysis, a nature observatory will be designed. The design should employ RP and the four objectives above. The final product will be the direct result of prototyped components.

Site

The site is to remain negligible to the design. An objective of this project is that of portability and how the design responds to a multitude of conditions—contextually and environmentally. As a result the design should reflect the nature of a (trans)portable structure, meanwhile refusing sedentary connotations.

Use

The nature observatory will be a singular space. This space will serve multiple functions: observation, study, sleep, and simple food preparation. Normal utilities will not be available forcing sustainable means for heating, cooling, and lighting to become an integral aspect of the design. The multiplicity of functions requires careful attention and should be partial to the architecture

as follows:

- For observation: ample views looking outward in varying directions
possibility of an outdoor observation deck and/or rooftop
- For study: a small desktop surface for writing
a small bookshelf
- For sleep: space for one person to rest
- For food prep: a work surface
a location for a propane and/or wood burning stove
appropriate storage

A primal consideration should be the inherent qualities of a (trans)portable structure (that is, how does the structure respond in transportation mode?).

Documentation

Documentation will consist of two-dimensional and three-dimensional working drawings as the design evolves through revisions and variants, supplemented with machined prototyped components. The seminal documentation will be the nature observatory built in accordance with the design using rapid prototyping techniques.

CONSTRUCTION INSTRUCTIONS

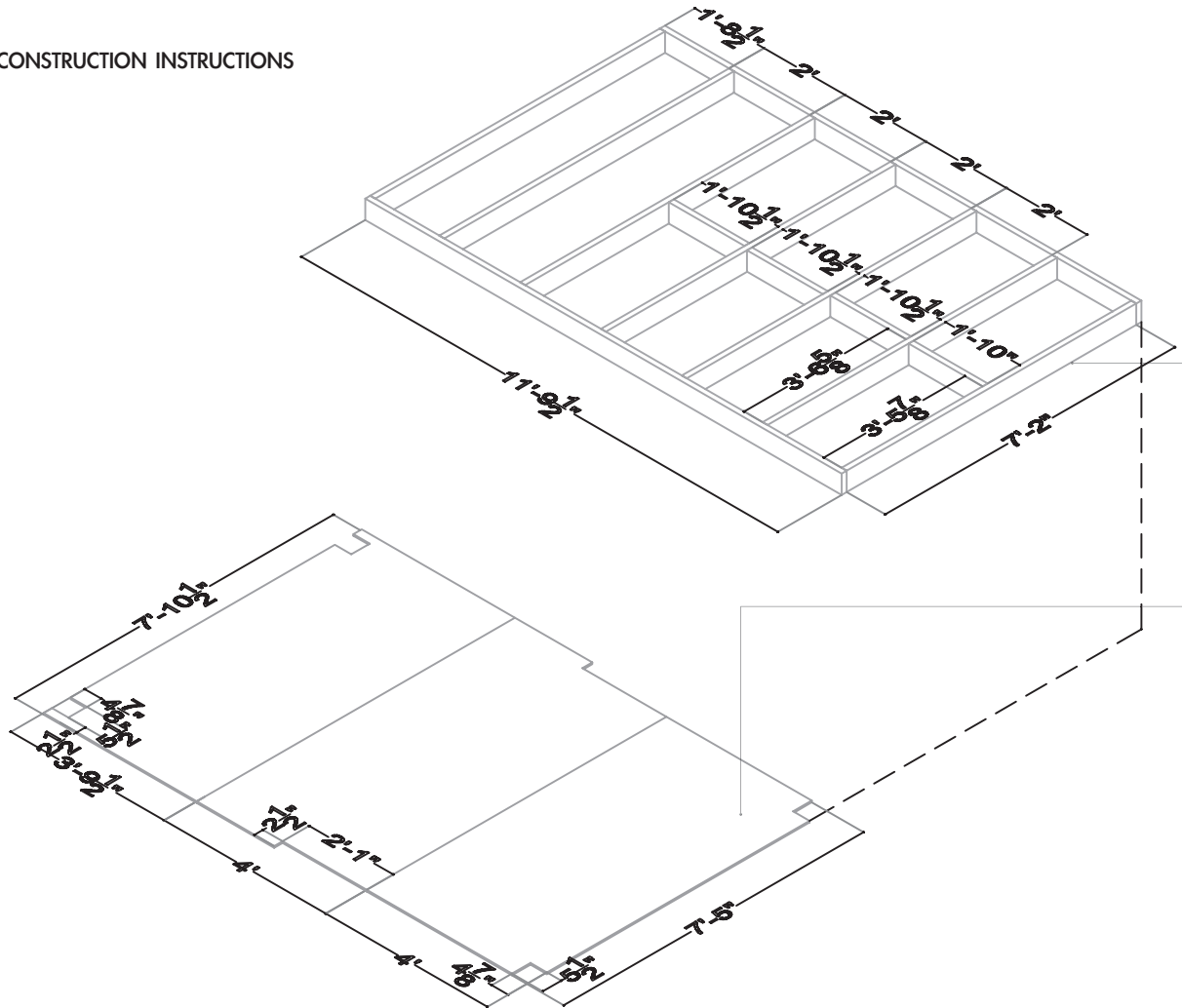

STEP 1

Floor structure assembly
plywood substrate installation

2x6 floor joist attached w/ 3"
exterior grade screws
Note: dimensions are to face of
stud

7/16" OSB attached w/
exterior grade screws 8" oc &
construction adhesive

CONSTRUCTION TIME: 7 hr

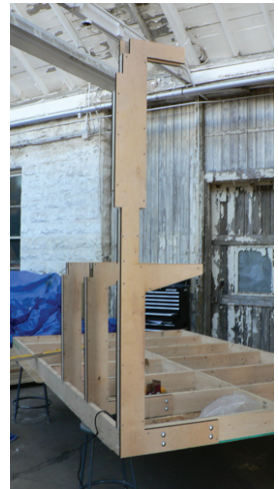

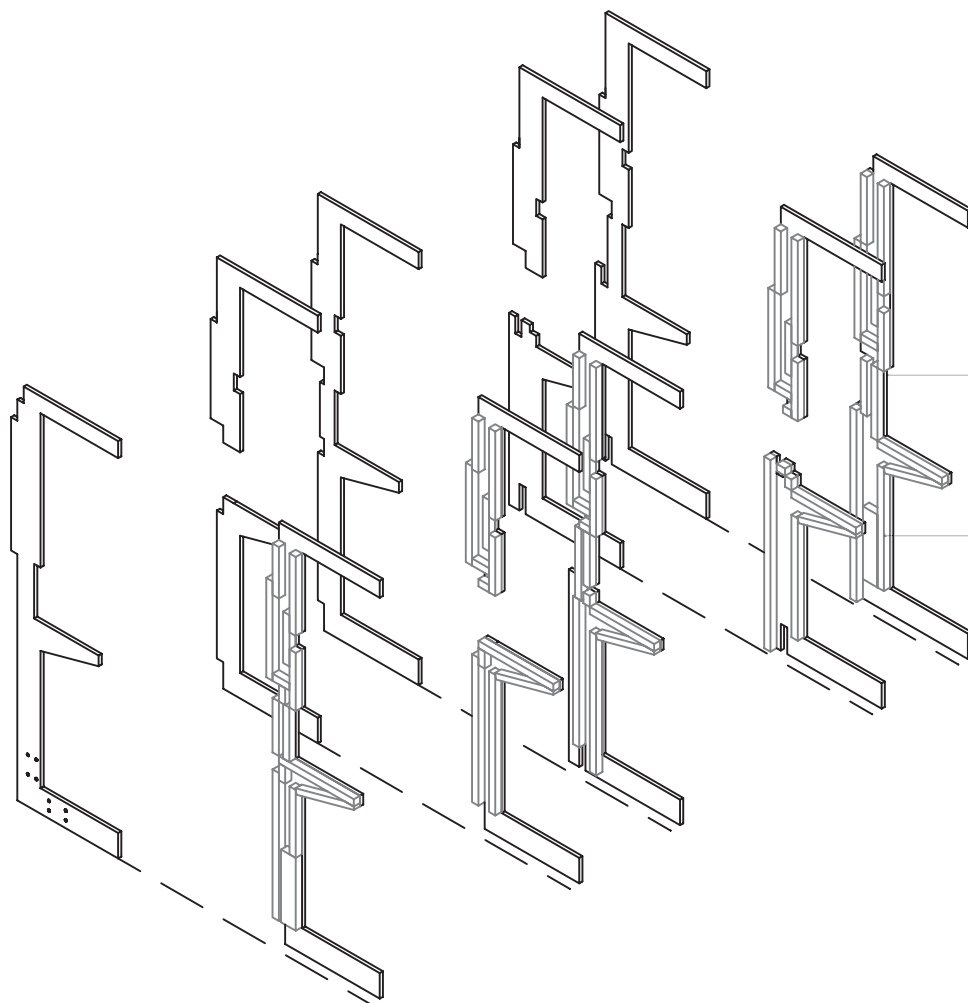

STEP 2

Plywood composite structure
sub-assembly—left side

Parts 1-14

Attach w/ exterior grade screws
& construction adhesive

1 1/2" x 1 1/2" stud nailers
attached finish nails

CONSTRUCTION TIME: 7.5 hr



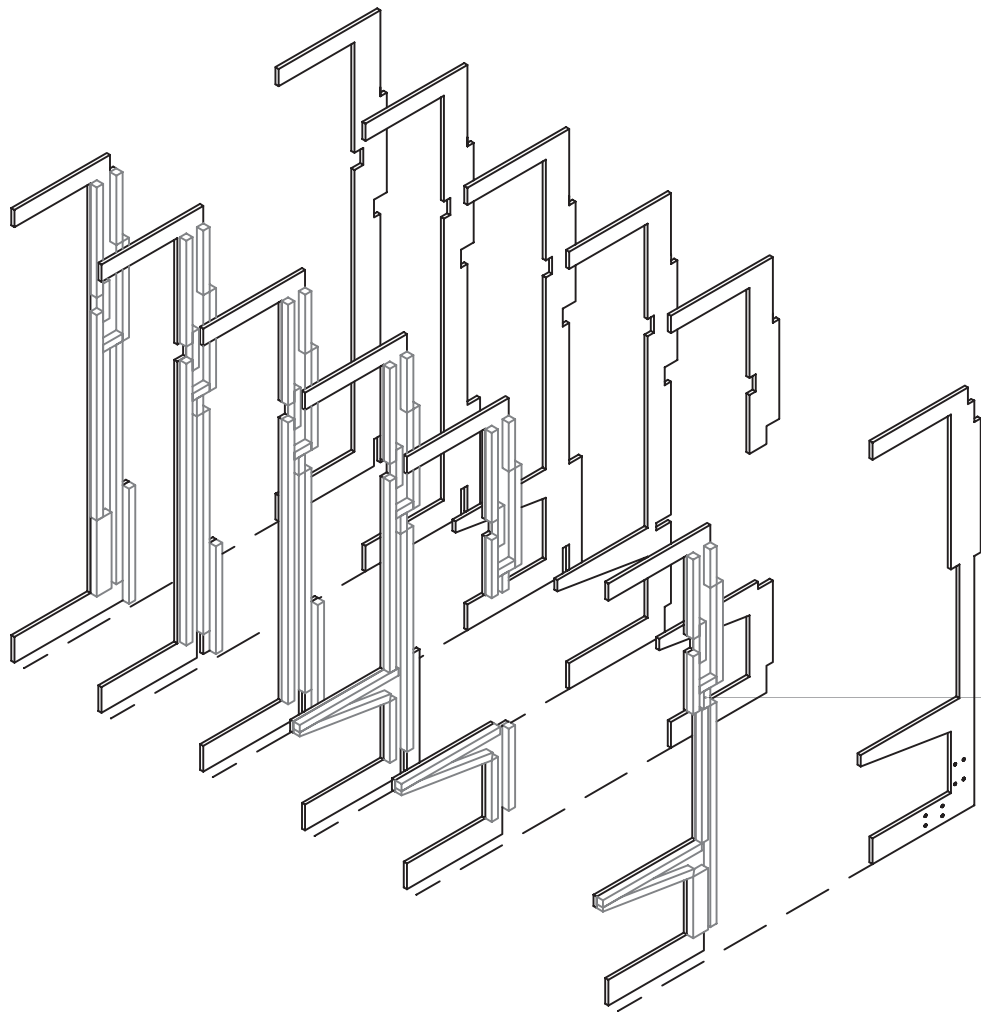

STEP 2A

Plywood composite structure
sub-assembly—right side

Parts 15-28

Attach w/ exterior grade screws
& construction adhesive

1 1/2" x 1 1/2" stud nailers
attached finish nails

CONSTRUCTION TIME: 7.5 hr



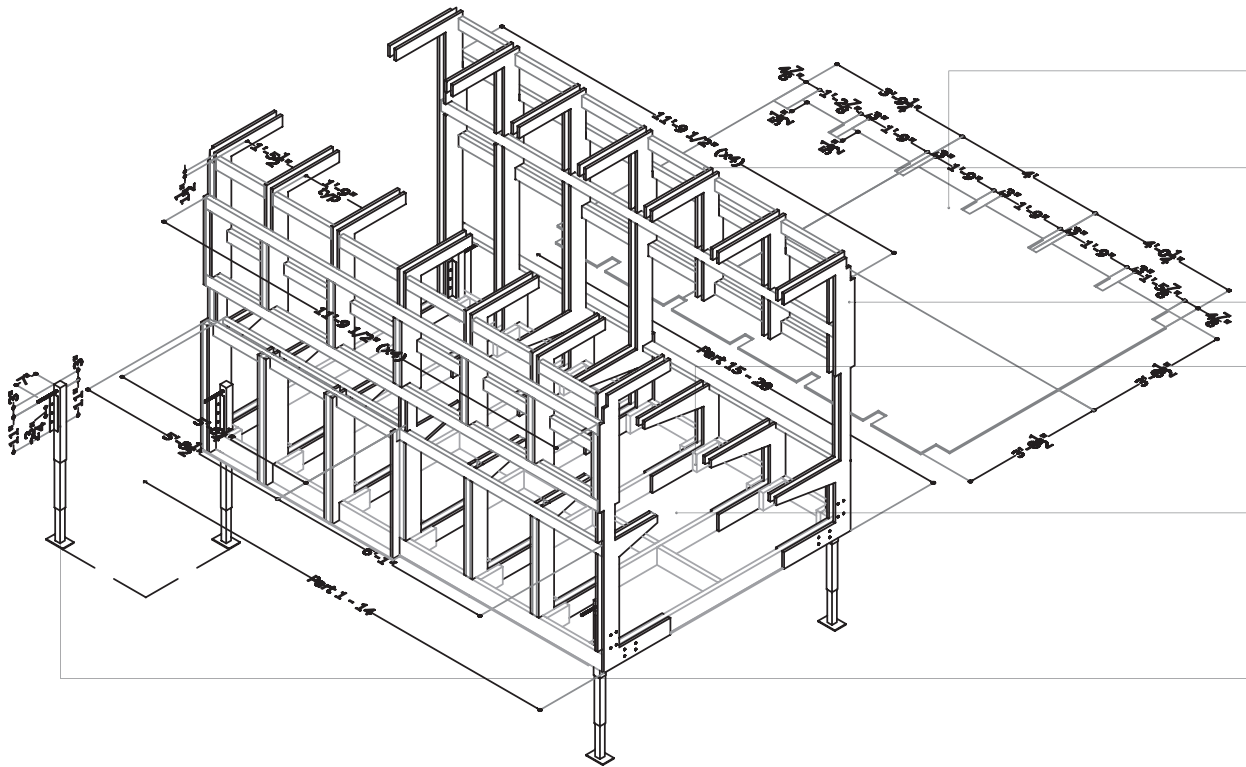

STEP 3

Jack attachment, install header, subfloor, & structure

7/16" OSB subfloor attached w/ screws atop vapor barrier

Attach all headers w/ exterior grade screws

Attach w/ 4" carriage bolts w/ washer & nut (56)

Blocking for subfloor attachment (typ)

Install R-11 batt insulation in floor cavity

1/2"x2"x1" steel angle 11" long welded (8). Attach w/ 4" carriage bolts w/ washer & nut (24)

CONSTRUCTION TIME: 27 hr



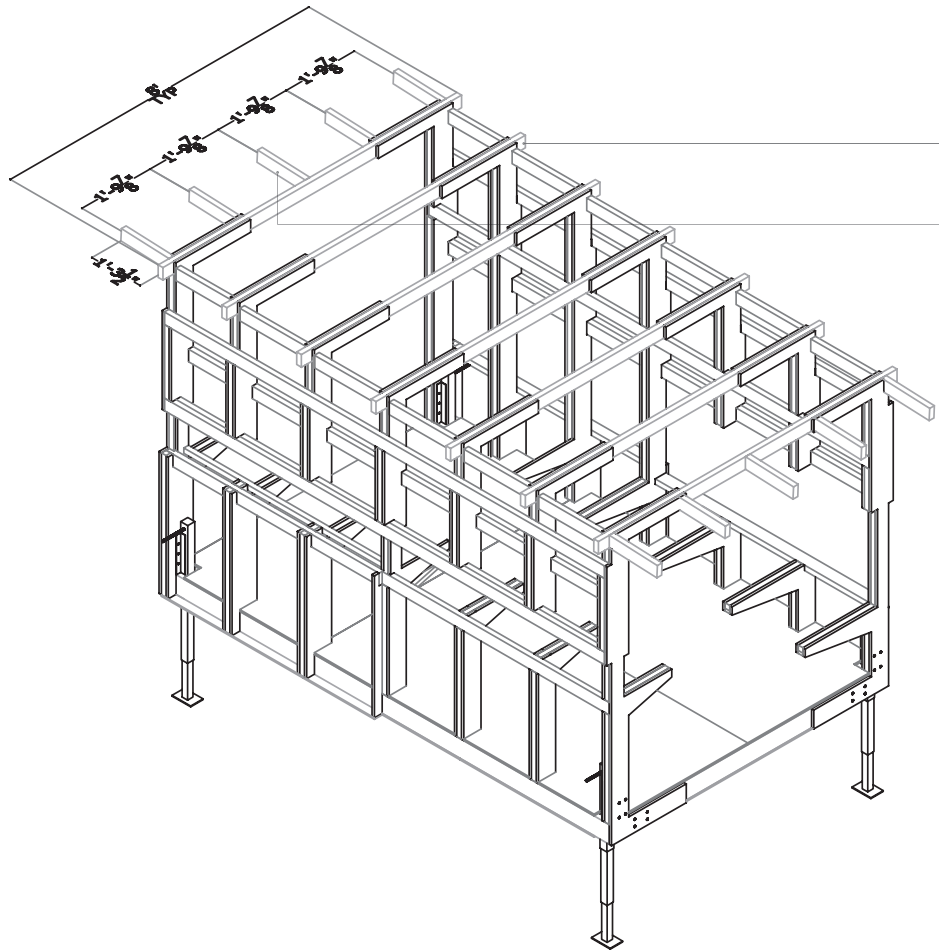

STEP 4

Roof structure assembly

Attach rafters w/ exterior grade screws

Attach lookouts w/ exterior grade screws & 2x4 joist hangers. End beveled @ 3°



CONSTRUCTION TIME: 6.5 hr

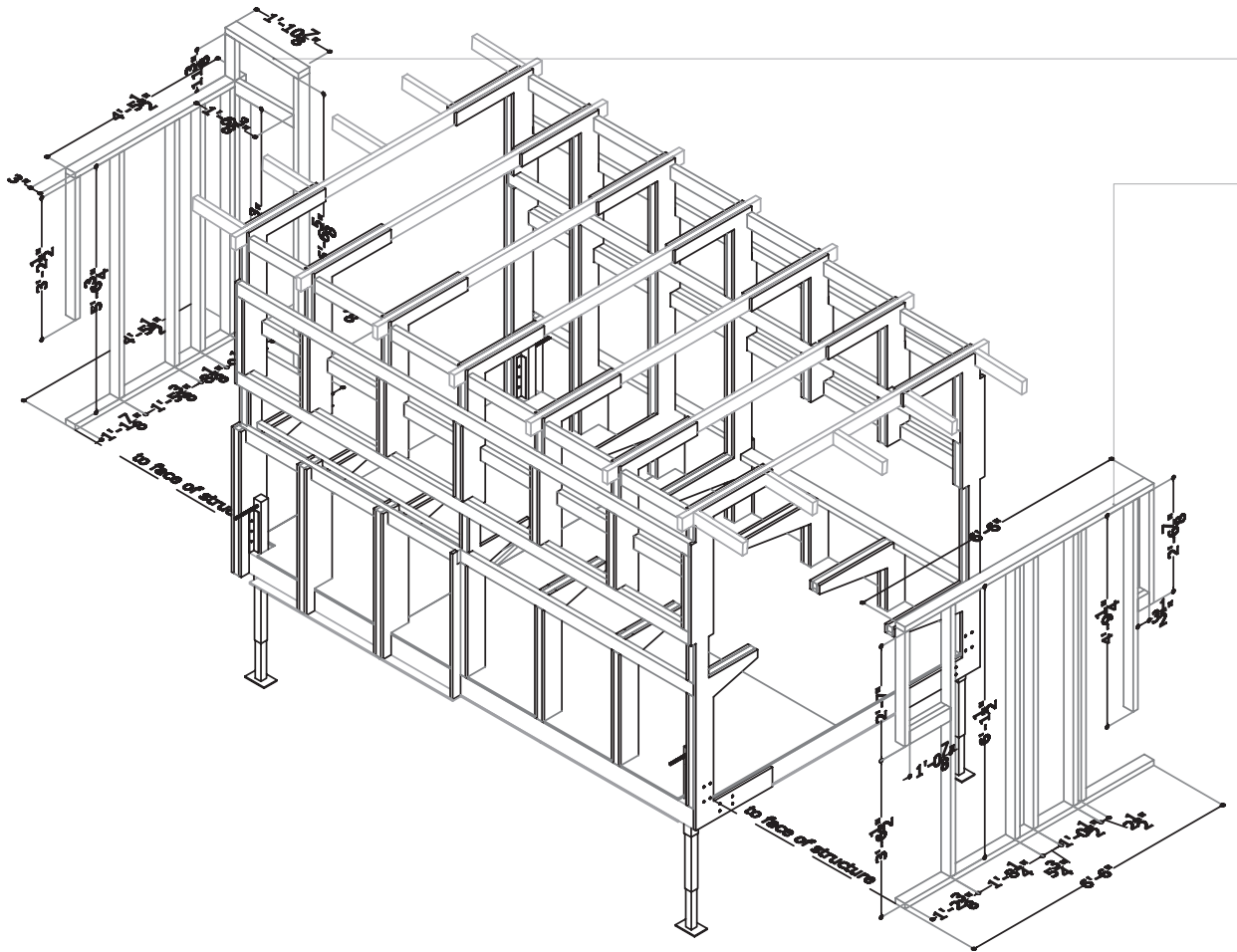

STEP 5

End wall assembly

3° taper

2 7/8" x 1 1/2" studs (typ). Attach
w/ exterior grade screws



CONSTRUCTION TIME: 4 hr

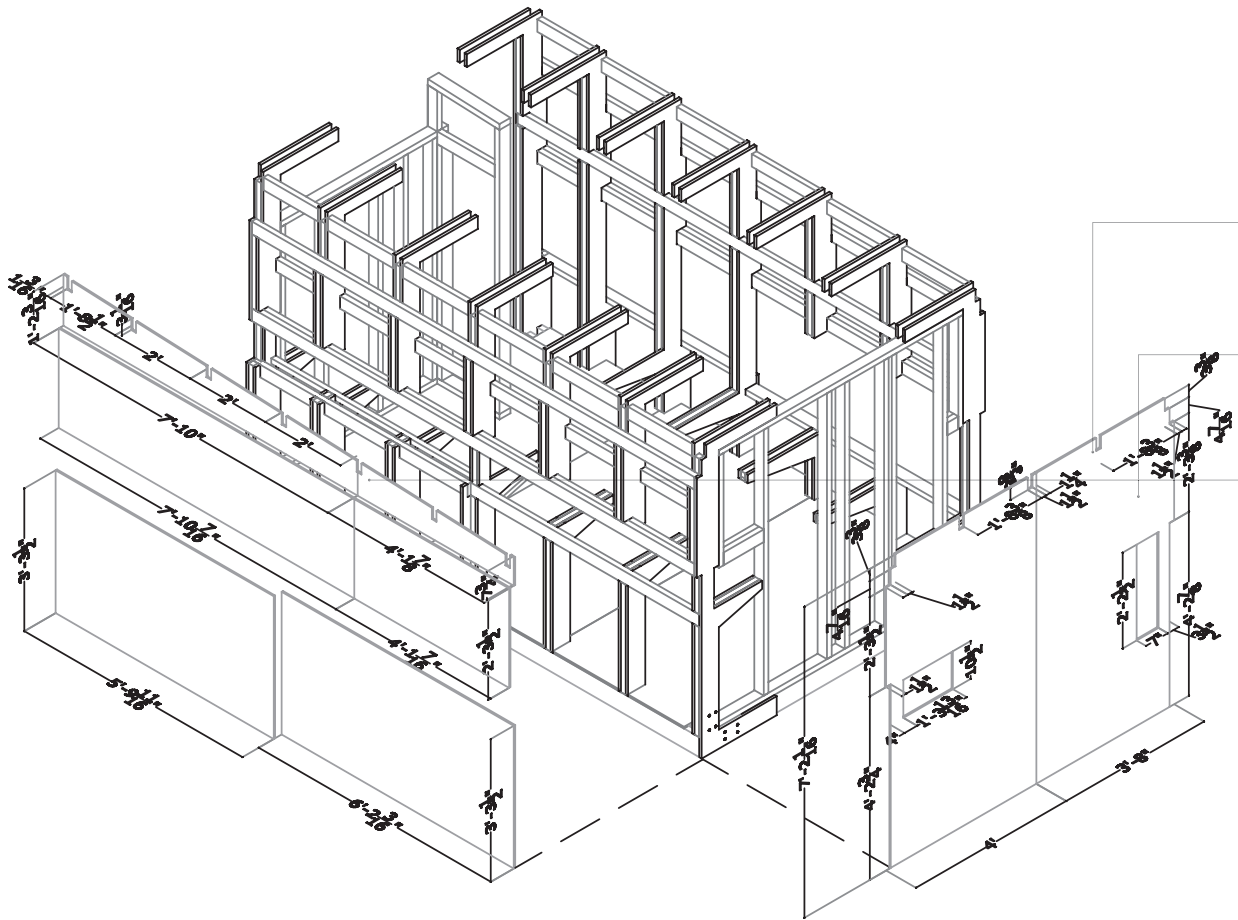

STEP 6

Exterior osb attachment—front
& left sides

7/16" osb attached w/ 1" galvanized staples & construction adhesive

Cover exterior osb w/ air infiltration barrier wrapping all corners & rough openings

Cut 2 pieces—one piece to be used in step 6A

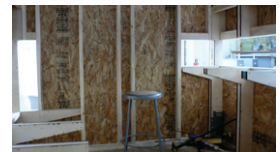
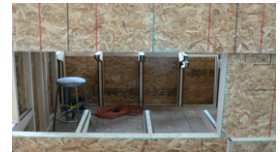

CONSTRUCTION TIME: 14 hr

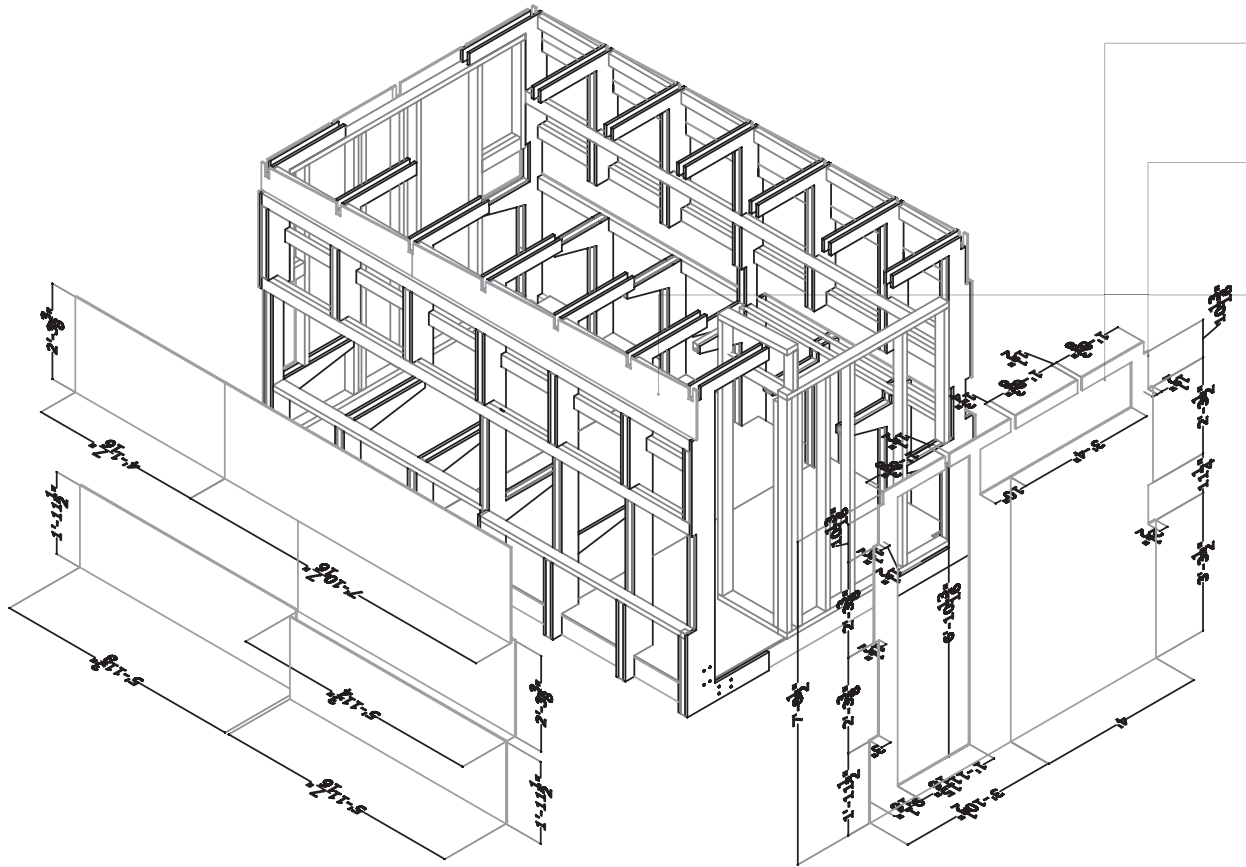

STEP 6A

Exterior osb attachment—back & right sides

7/16" osb attached w/ 1" galvanized staples & construction adhesive

Cover exterior osb w/ air infiltration barrier wrapping all corners & rough openings

Refer to step 6 for panel dimensions



CONSTRUCTION TIME: 13 hr

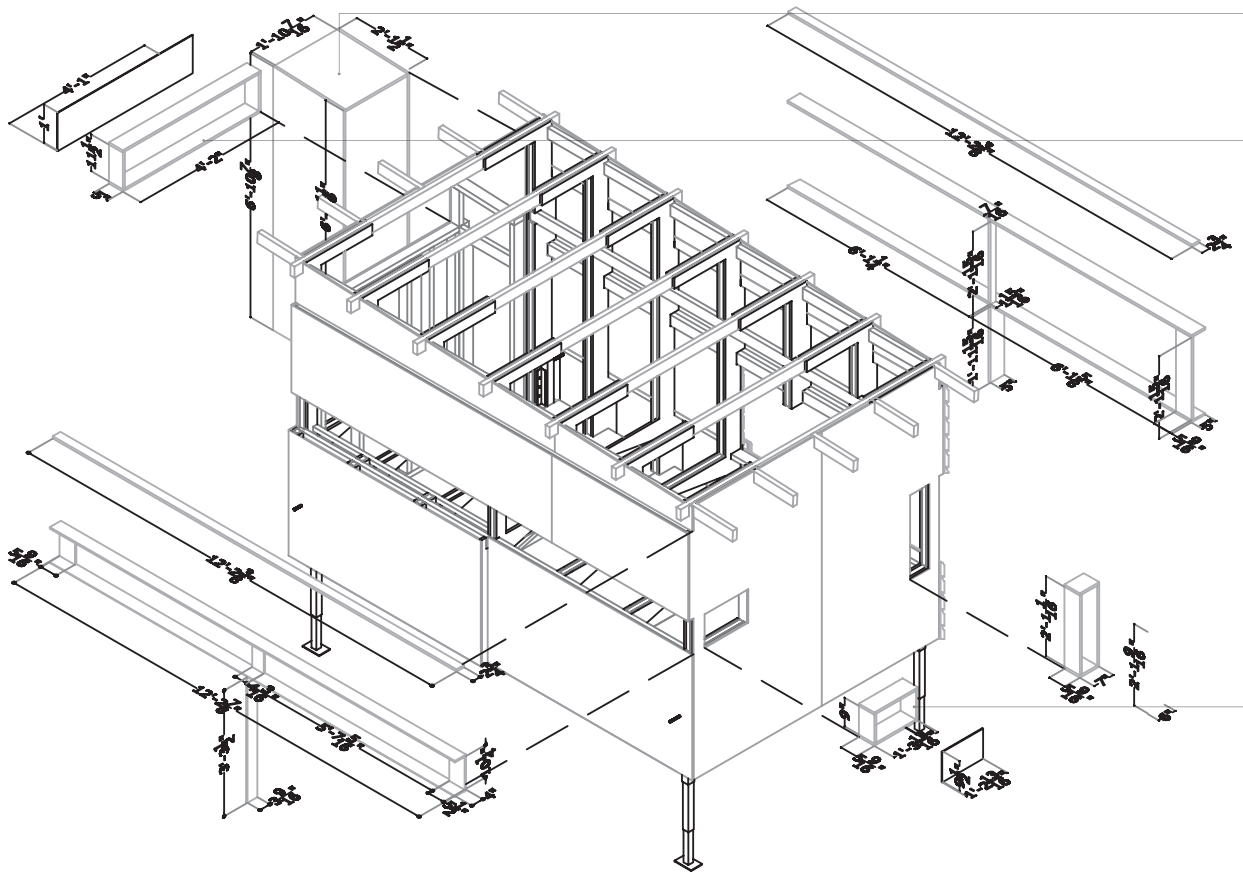

STEP 7

Exterior trim installation & window assembly

NOTE: All exterior trim 7/8" cedar cut to length

Plate join 5 cedar boards cut to length

5/16" x 3/8" dp dato 1" from back. Miter all corners to 45°. 1/8" thick polycarbonate. Caulk w/ clear exterior grade

NOTE: All window frames caulked around w/ clear exterior grade

5/16" x 3/8" dp dato 1" from back. Miter all corners to 45°. 1/8" thick polycarbonate. Caulk w/ clear exterior grade

CONSTRUCTION TIME: 14 hr



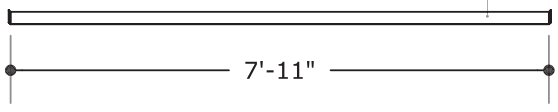
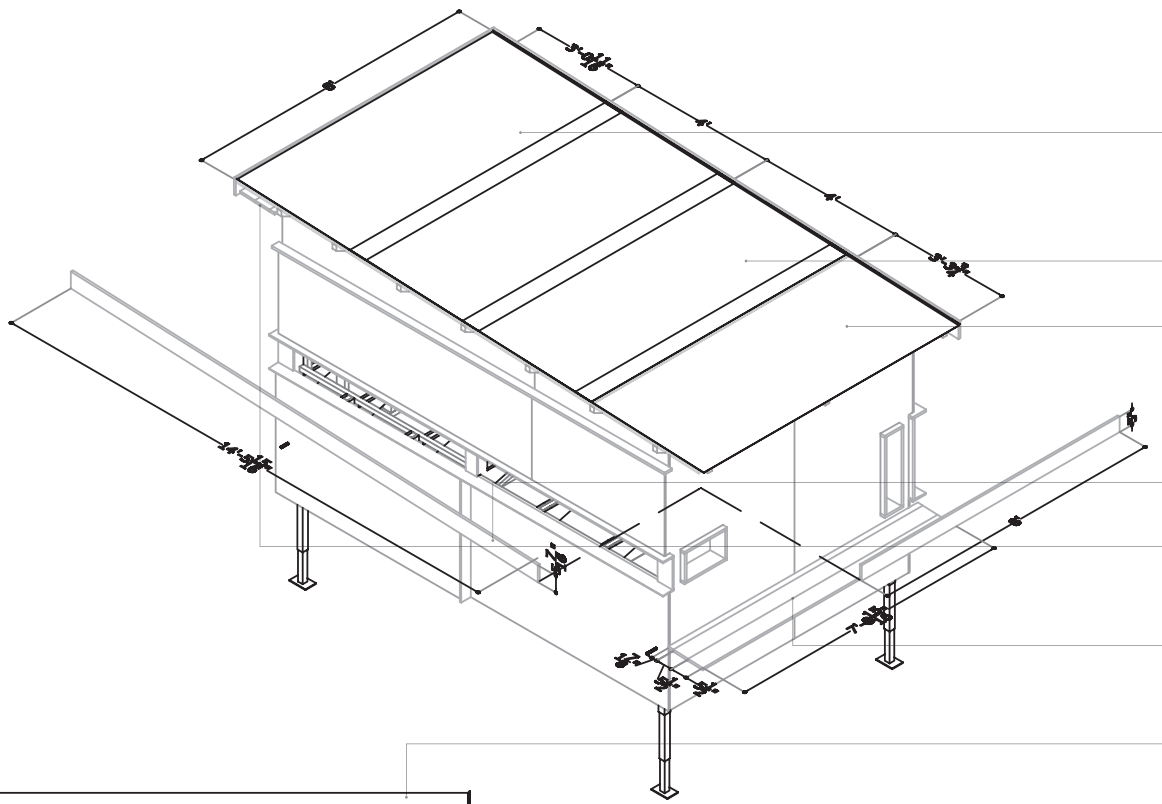

STEP 8

Exterior roof osb attachment

Metal roofing attachment

NOTE: All exterior trim 7/8"
cedar cut to length

7/16" osb attached w/ 1"
galvanized staples 6" oc &
construction adhesive

Asphalt felt overlapped 8"

22 ga galvanized metal roof
overlapped 9" sealed w/ tar,
attached w/ 1 1/4" neo-screws
sealed w/ tar

Cedar trim (both sides)

Cedar trim overhang flush w/
entry & window casing

Cedar trim underneath overhang
(front & back)

22 ga galvanized metal roof 8' x 3'
w/ 1/2" break at 45° angle



CONSTRUCTION TIME: 9.5 hr

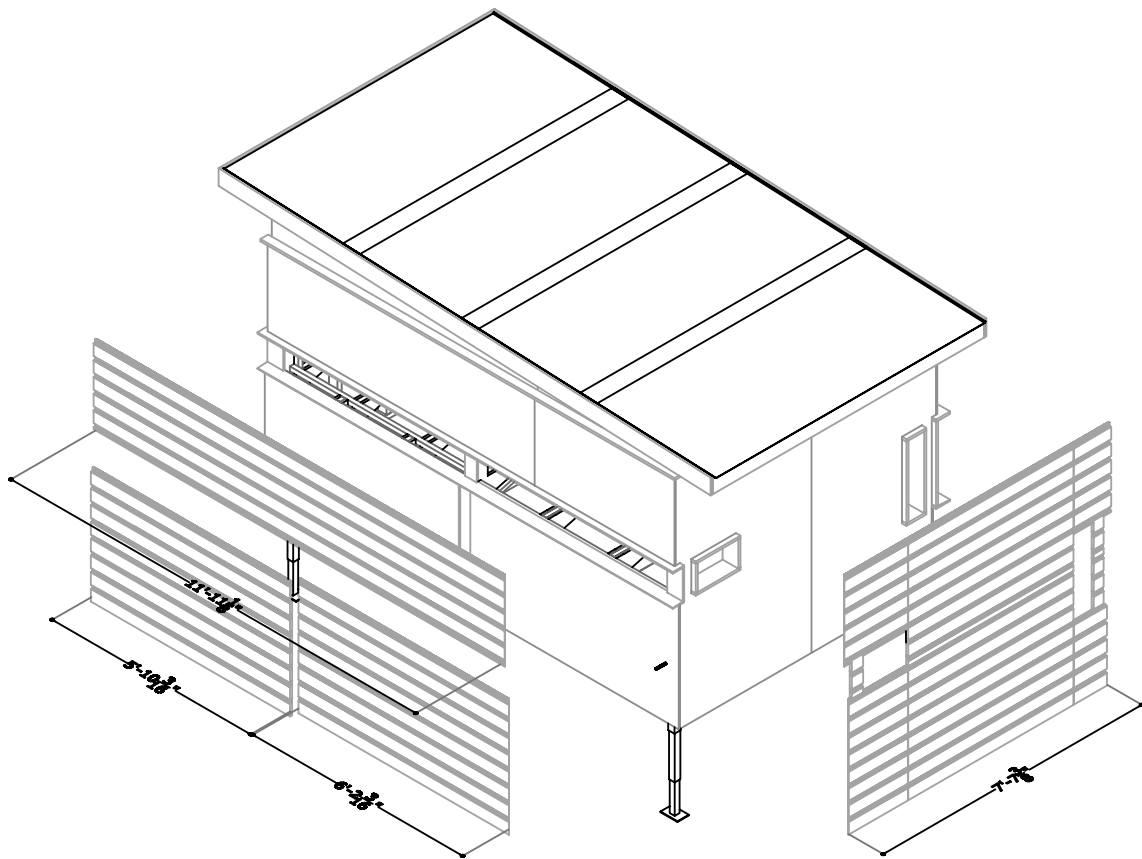

STEP 9

Exterior reclaimed cedar siding installation

NOTE: Due to the inconsistencies of the reclaimed cedar barn siding dimensions will vary. Splicing boards together may occur in order to clad entire exterior facades. Dimensions given are for reference only. Double check each board as attached.

Attach all cedar siding with 1" galvanized staples.

All corners 45°



CONSTRUCTION TIME: 56.5 hr

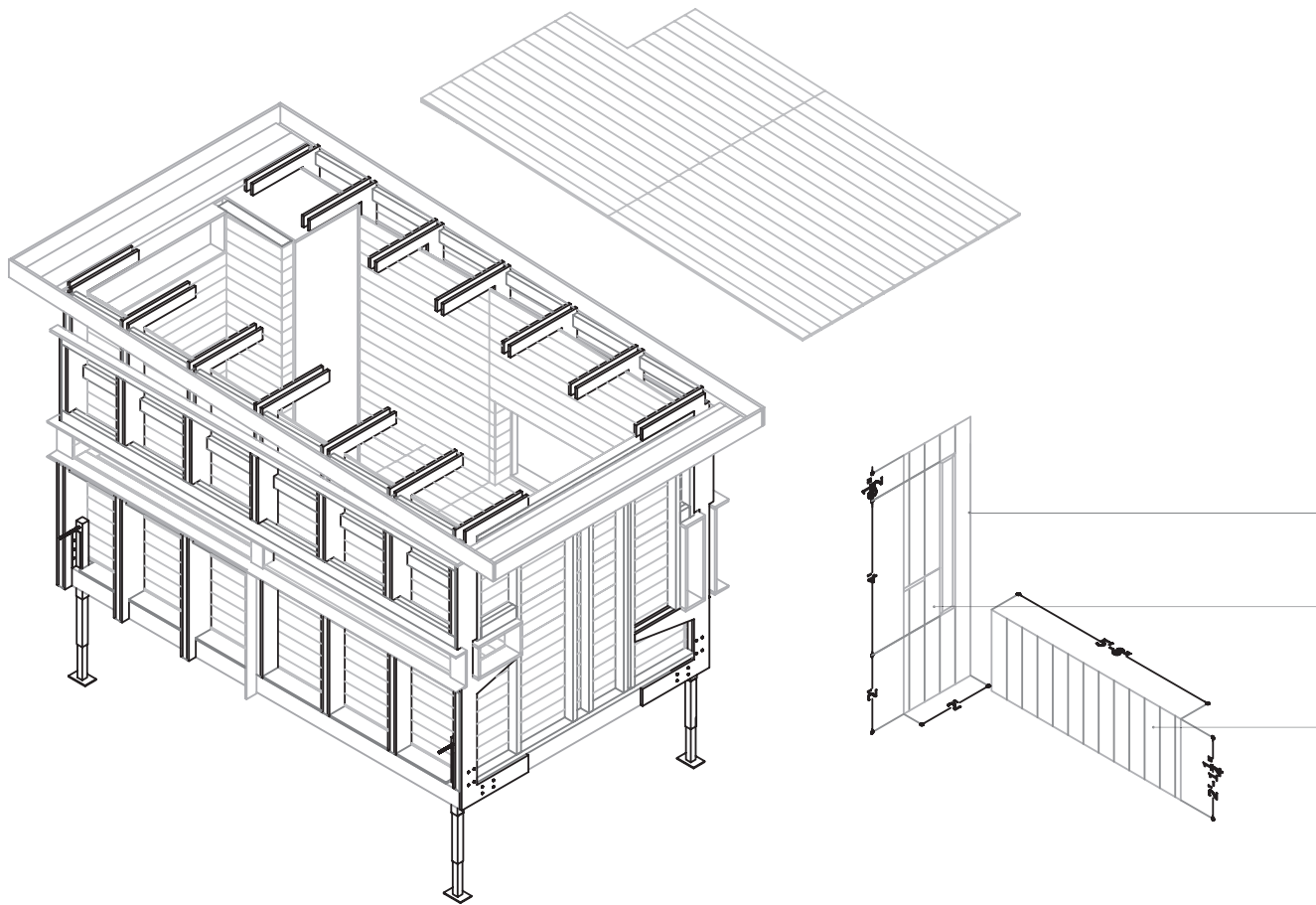

STEP 10

Interior bamboo attachment
Front and sliding door attachment

NOTE: Proper installation of bamboo flooring requires a procedure of utilizing each cut piece on the next row of planks. Each plank will have to be fit according to previous corresponding plank.

Attach with 1 1/4" 16 ga finish nails through tongue of plank.

All outside corners 45° and glued w/ construction adhesive

Plate join 5 cedar boards cut to length

Door opening to have wood plank pivoting on center dowl rod.

Plate join 14 cedar boards cut to length.

NOTE: All edges of doors shall be trimmed in weatherstripping

CONSTRUCTION TIME: 58.5 hr
TOTAL CONST. TIME: 225 hr







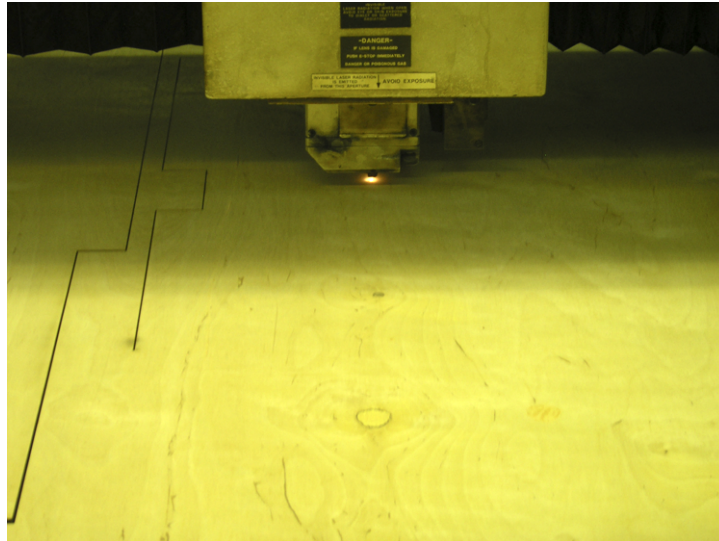
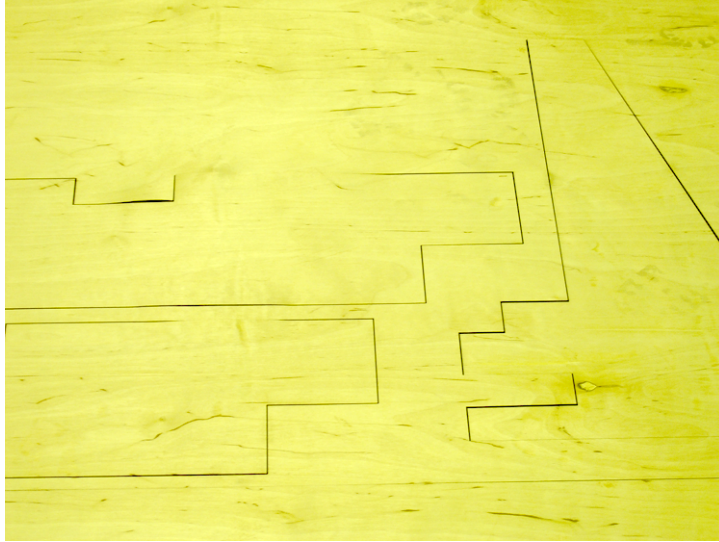

sheet 1

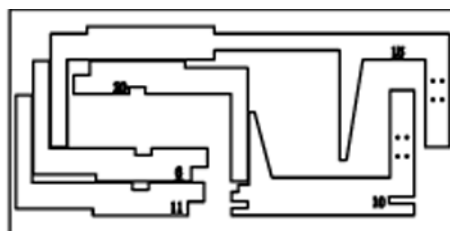

sheet 6

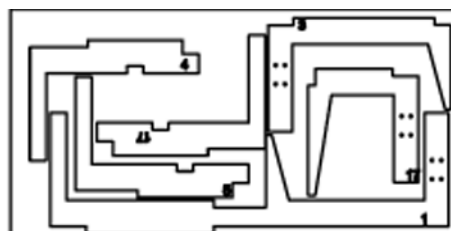

sheet 2

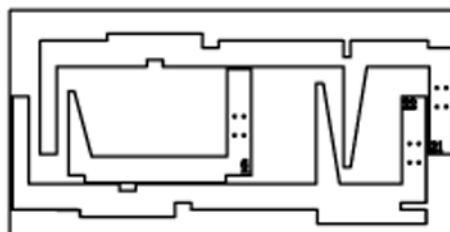

sheet 7



sheet 3

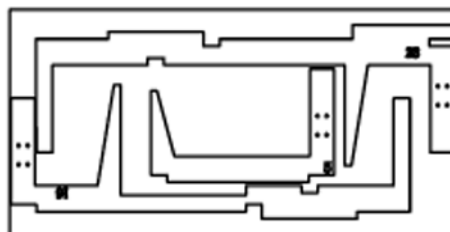

sheet 8



sheet 4

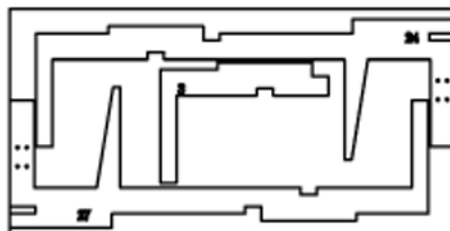

sheet 9



sheet 5

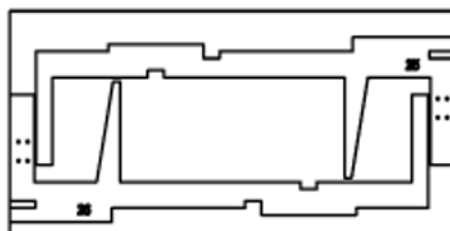

sheet 10

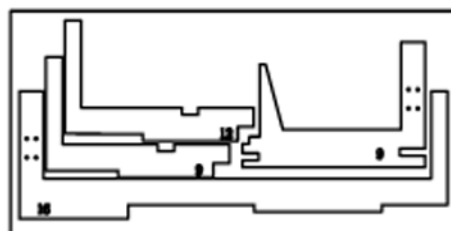

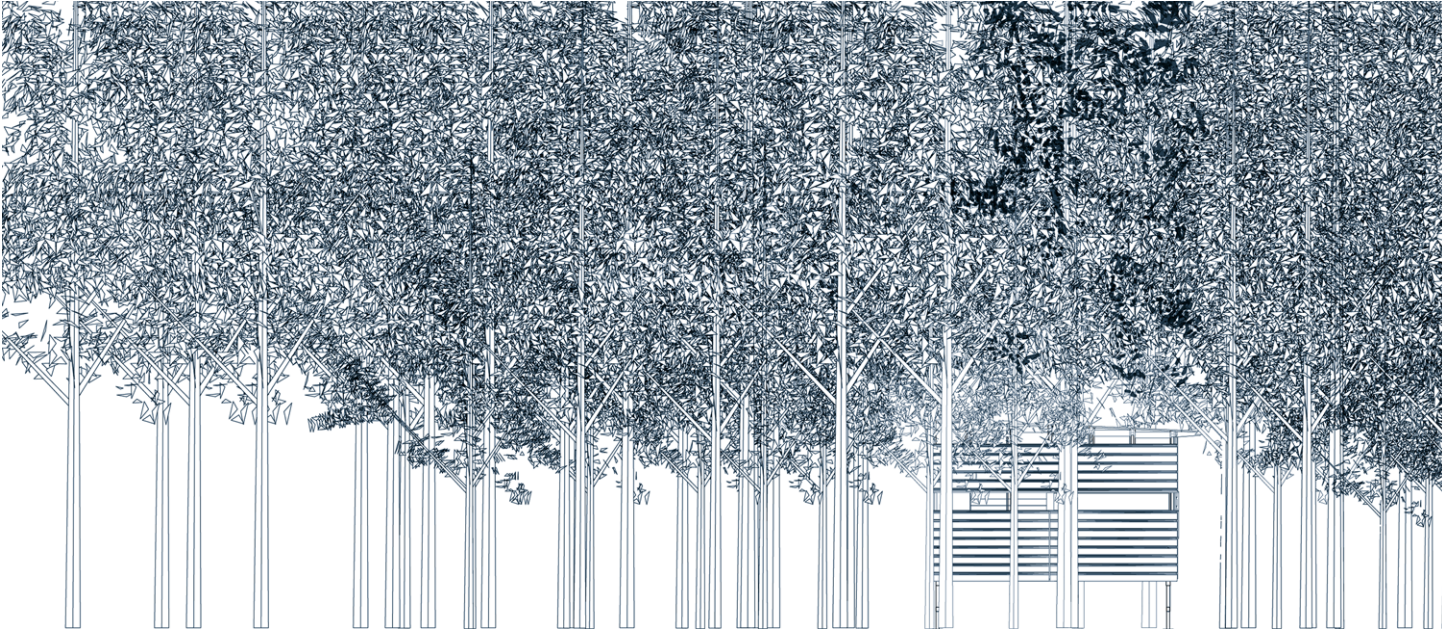

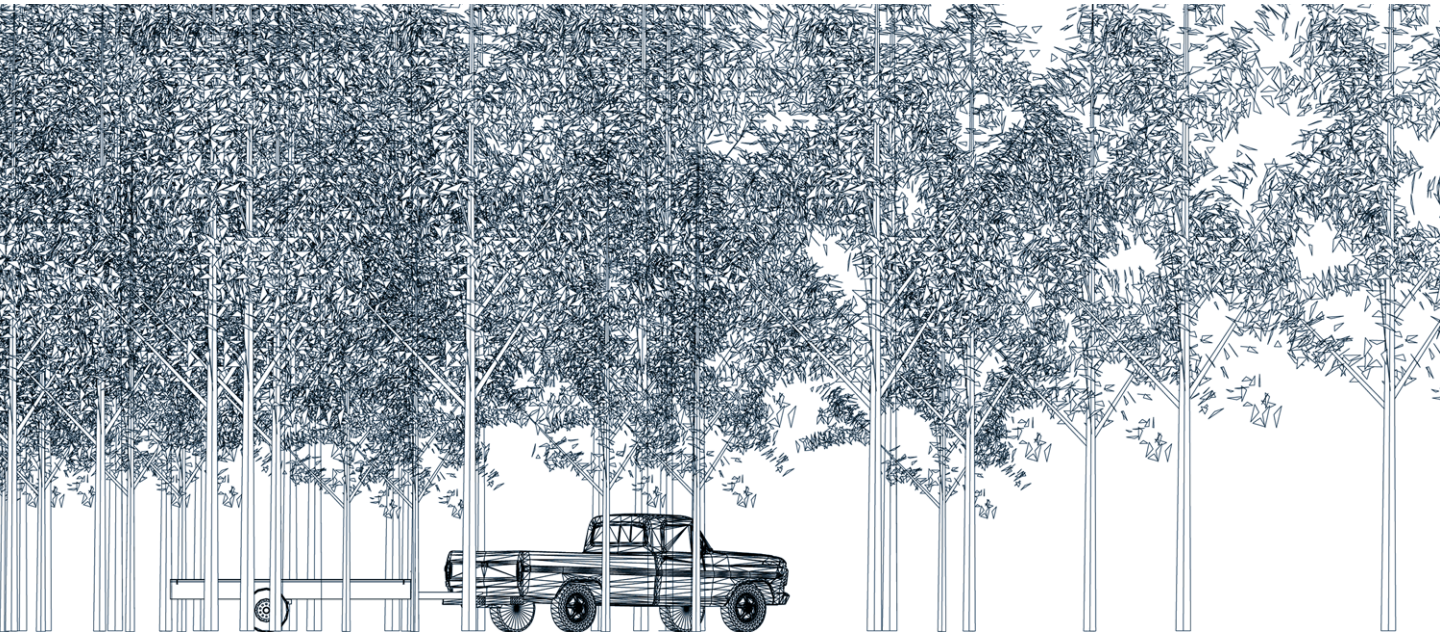
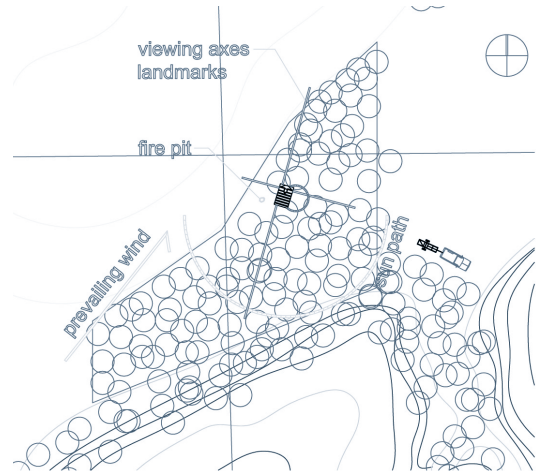

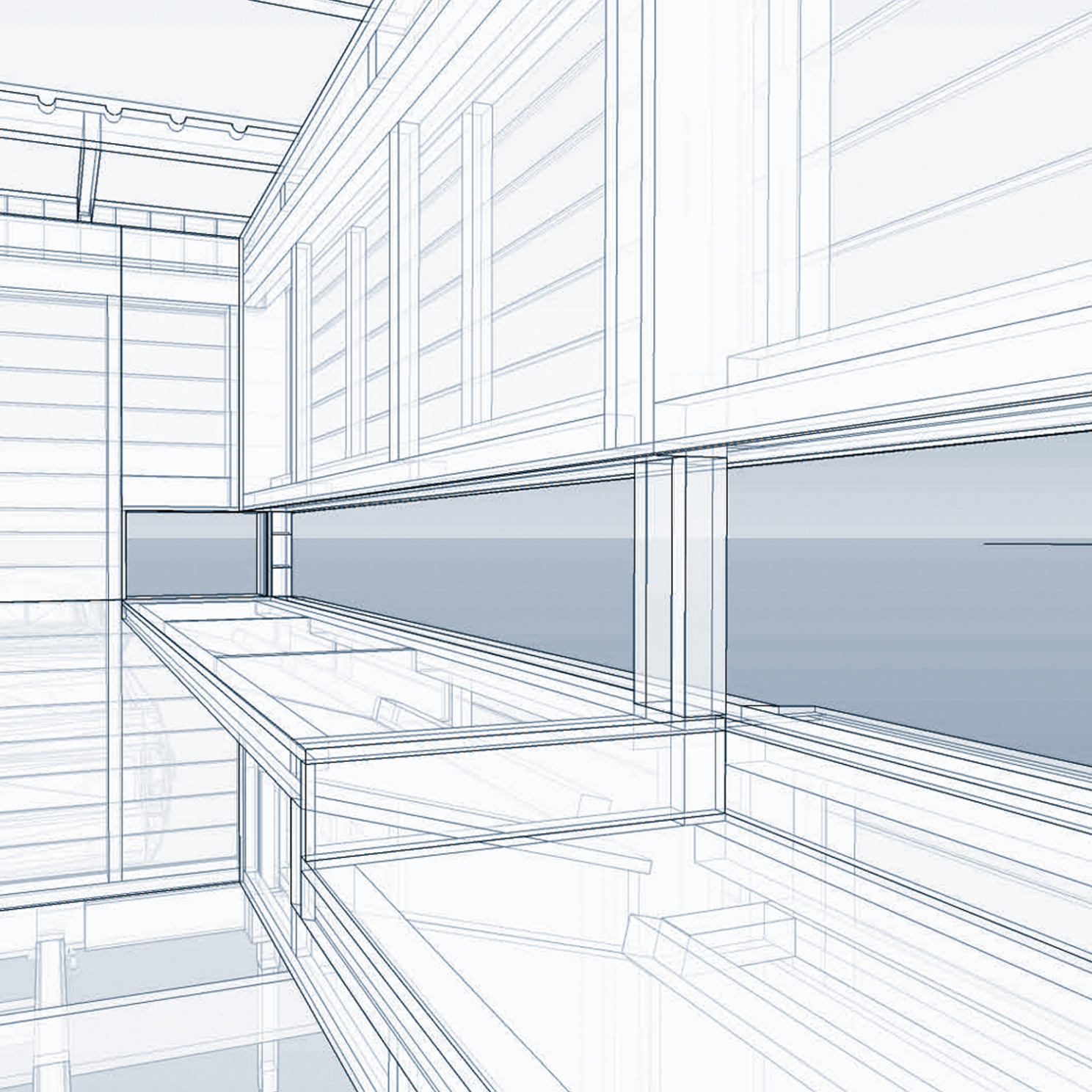

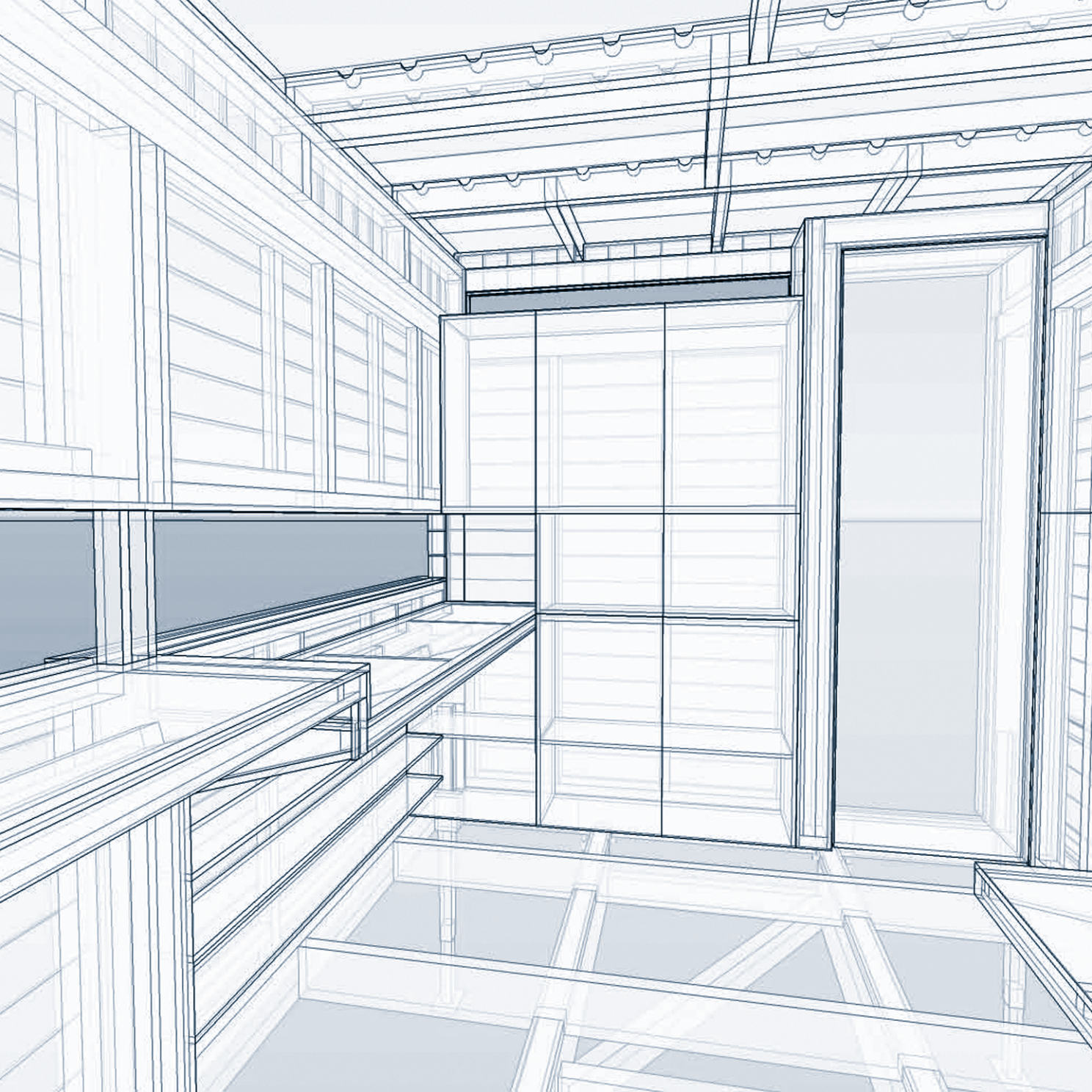



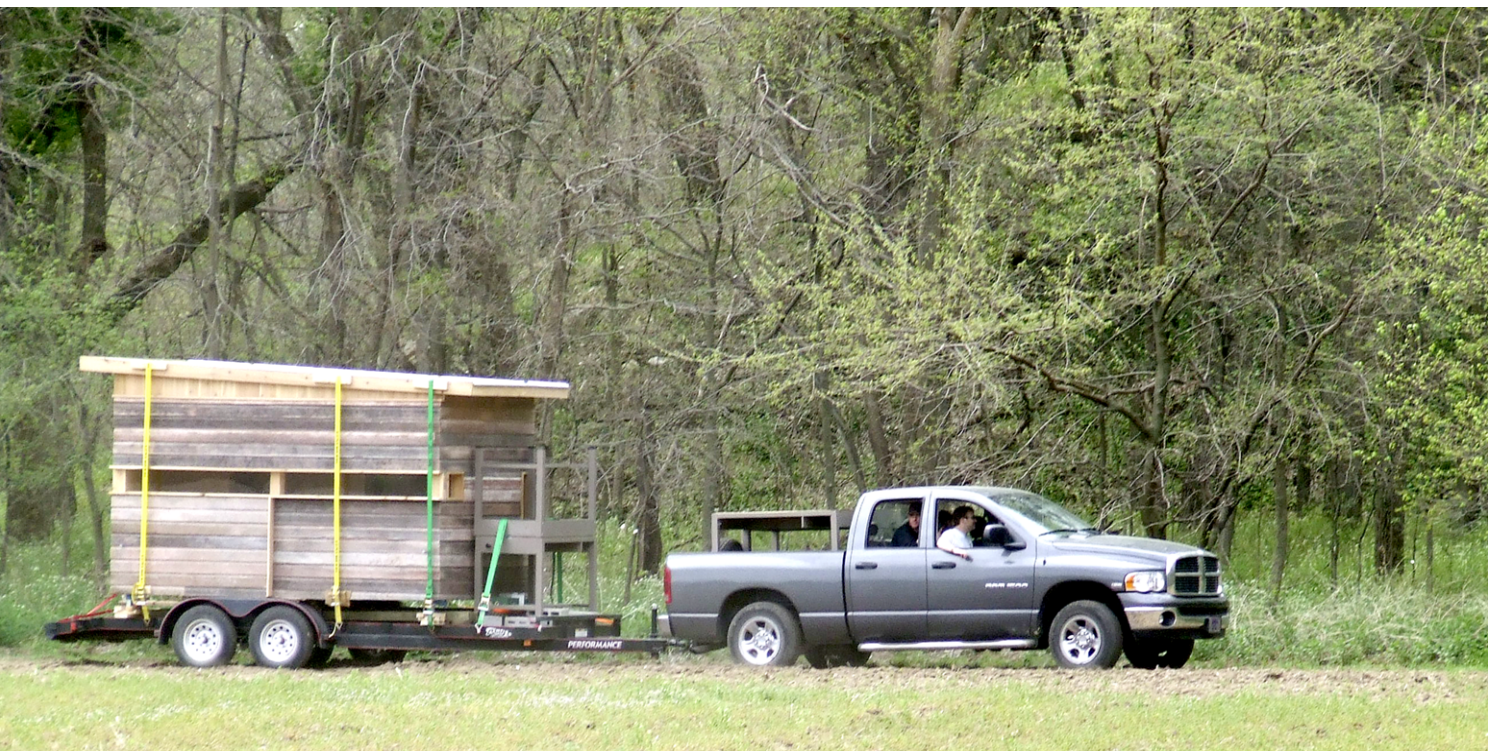













CONCLUSION

The desired intention of this research was to understand the process of rapid prototyping (RP) as it crosses the boundary into architecture. Little to no documentation currently exists to explain the implications of RP for architecture. Consequently this research was directed by fixed assertions with the hope of discovering and documenting these implications. The stringent progressions of this research were three-fold: to examine, to design, and to build. The first assertion was to examine how RP reshapes architectural practice and making; the second, to narrow the distance between architectural practice and making through a design; and lastly, to return the architect to the role of master builder by redefining his part in the construction of the design.

This study incorporated machines time-tested in their respective fields. However the computer numerically controlled (CNC) machines were not used in this study to test limitations. An innovative use of the CNC machine was not the desired outcome. Likewise new systematic formulations of space creation were not an intention of this thesis either.

Development

The project began development with the identification of a site, a budget, a program, a schedule, and a scope—typical informants for a project. In the initial stages the design process foundered, as it was arduous to be open to accepting a new approach to designing. The process seemed disconnected with RP and all too similar to a traditional approach to designing with physical model building, sketching, and the like.

In order to reconnect the project with the ideologies of RP all designing took place within the computer. The design started utilizing the cross-section of the first revised prototype. From that cross-section the profile was traced in order to create structural ribs, as seen in the laser cut patterns. Once this systematic approach was developed, the process proved to be insightful. All designing utilized CAD technology, specifically industry standard AutoCAD, to create a three-dimensional model to be rapid prototyped. As the design evolved in the computer quick decisions were being made, simultaneously affecting material choice, structural implications, and the like. Those decisions

were based upon the collective information of the complete design, not a singular event. For example, the standing height countertop, integrated into the wall structure as one panel, had to remain at standing height (36 inches). As the detail of the flooring composite evolved, it influenced the height of the countertop, in turn, causing the need to adjust the structure, which conflicted with the window placement, and so on. The correcting time involved was effectually minimized due to the process of rapid prototyping in a three-dimensional computer model. The 3-D model, detailed to the level of blocking and bolt locations, proved that what was drawn was inarguably buildable. Recall 3-D models used by the automotive industry or airline industry. These models are drawn with precision and conviction in order to be truly confident that each piece and component will fit in its designed place. From these models, components then have the possibility of being outputted on a CNC machine to precise dimensions. That machined part has a defined place within the design, now with the ability to be mass-produced or mass-customized. This logical, non-linear process influenced every aspect of the design. With a limited budget the

structure became the components to be outputted from the computer to a CNC lasercutter for manufacturing.

Outcome

Evidence of success in the design process incorporating RP can be seen through the speed of construction. With every piece and component of the design, precisely created dimensional parameters were extracted from the 3-D model for exact placement. Since the precise model provided these measurements the relative ease of construction was significant. Absent from the building process was the lack of clarity or uncertainty normally associated with construction, seen through change orders, request for information submittals, or architect's supplemental instructions.

This process would be inconsequential if it were not in a larger context. What has become evident by approaching an architectural project in this manner is the projection of an architect's role into the actual process of building. The architect, collectively working with the appropriate consultants, contractors, material scientists, and product engineers, influences

how the building is built. Each profession is no longer segregated, but rather operating as a collective maker. The specific distinction for the architect is that he is removed from the lone position of designer in order to have a greater input on the entire process of building. As with the architect, the design is no longer segregated from the built; more responsibility is now placed on the architect. The burden of material selection, structural systems, building sequence and scheduling, and the like, is directed toward the architect. The specific distinction for the project is reduced time and cost, while increasing quality and scope. With the use of RP and CAD/CAM technologies not only the project benefits, but more importantly the client receives a higher quality service. In return, RP acts as an agent to redefine the master builder, within the context of present day needs.

Pedagogy

The pedagogical implications of this process can be profound. Students training to be architects can be introduced to a new process that investigates the connection of designing and building. With the ability to quickly produce

scaled or full-scale mock-ups to study, the student can rapidly test details or the entire building. Students would have the tools at hand to explore details and come into contact with materials. Moreover, a student would no longer be estranged from construction details or building processes. Rapid prototyping allows this jump from design to the built to occur. Furthermore, design-build projects are more feasible. As evidence of the feasibility, this project was built by one person in one-half of a semester (approximately two months). Through the 3-D model construction steps are created to inform the builder on how the project is to be built. The design is reduced down to a logical sequence of steps that create a kit of parts for construction. Architecture instructors could capitalize on the opportunity to teach students to understand clearly what they are designing. Through RP instructors have a tangible product they can critique and use to demonstrate failures and successes. As students matriculate and transition into the work environment architectural practice and making would be changed. Students can gain the knowledge of building through RP in academia, thus affecting training time on the job. In turn, the

revolutionary introduction of RP changes how architecture is learned and practiced and how a building is constructed.

Criticism

A negative aspect of this process became apparent in the building process. Automotive industry components are machined to high tolerances primarily out of metals or plastics. By contrast, raw materials normally used for building construction are typically inconsistent in size; they may be warped, cupped, twisted, and so on. These inconsistencies present a problem in the construction of a project designed using a computer that can draw to a tolerance unmatched by raw building materials. Moreover when components are machined to the tolerance at which a computer can draw and attached to inconsistent raw materials all tolerances become negated, causing dimensional parameters to become inaccurate. This problem needs to be more carefully controlled and considered to insure accuracy if CAD/CAM technologies were to be incorporated broadly in the architectural field.

Also highlighted in the construction process

was the contrast between simple assembly and detailed carpentry. RP reduced the time taken to assemble the project, as seen in construction steps 1 through 8. The assembly steps acted like puzzle pieces, all having a unique place and order. In total, steps 1 through 8 took 110 hours to assemble. In contrast the final two steps took 115 hours to construct. The final two steps included applying the exterior barn siding and interior bamboo cladding. Steps 9 and 10 took more time because it was reliant on finish carpentry work. Cuts and joints required a higher level of precision. In hindsight steps 9 and 10 would have been CNC machined to achieve a high degree of precision. In doing so the process of incorporating CNC machining through rapid prototyping would have been maximized. This contrast in assembly and carpentry also argues that architecture may not ever be 100 percent manufactured; there is still a place for skilled tradesmen.

Reconciliation

Only within the last few years have the advances in CAD/CAM technologies started to have an impact on architectural practice and

making. This new digital aspect creates a direct link from design to construction. The consequences are profound as the relationship between fabrication and construction are challenging the traditional system of architectural practice and making.

Architects and the associated architectural disciplines have the opportunity to embrace these available technologies. They have proven to be effective and universal in other industries. As proven by this research the technology has its place in architecture. It is not a call to replace the human act of design with computer functions, but rather to find a common ground between the design and the execution, returning to the paradigm of a collective master builder.

Reflection

With research of this kind all possible scenarios could not be addressed, rather, the research leaves room for further exploration. The next logical step would be to integrate the construction more closely with the 3-D model. As seen in the drawings, construction was a sequential step process. The possibility exposed is to uti-

lize a demarcation system to instruct the builder as to where each piece is located. Without the architect on site of the project, the contractor could be misguided in the construction. Incorporating other technologies, such as a barcode system, could speed up the building process. Each component that is digitally created could be notated with a barcode when manufactured. When delivered on site, the component would be scanned. Information stored within a computer database would instruct the contractor on the location of the component, the type of fastener, the color of paint, or any other parametric or descriptive feature about it. Therefore the architect would not have to assume the role of general contractor while a building was under construction.

BIBLIOGRAPHY

- Chaszar, André. 2005. Blurring the lines - case study: An exploration of current CAD-CAM techniques. *Architectural Design* 75, (1) (Jan): pp.111-116.
- Chua, Chee Kai, Kah Fai Leong, and Chu Sing Lim. 2003. *Rapid prototyping : Principles and applications*. 2nd ed. Singapore ; New Jersey: World Scientific.
- Coticchia, Mark E., George W. Crawford, Edward J. Preston, and Edward J. Preston. 1993. *CAD/CAM/CAE systems : Justification, implementation, productivity measurement*. Computer-aided engineering. 2nd , rev. and expand ed. Vol. 2. New York: M. Dekker.
- Dollens, Dennis. 2001. *D2A, digital to analog*. Santa Fe, N.M.: Sites.
- Edmiston, Jeremy, and Douglas Gauthier. 2002. SYSTEMarchitects. *Architectural Design* 72, (5) (Sept): pp.79-82.
- Garofalo, Luca, and Peter Eisenman. 1999. *Digital eisenman : An office of the electronic era*. The IT revolution in architecture. [Eisenman digitale.]. Basel ; Boston: Birkhäuser-Publishers for Architecture.
- Gilmartin, Ben. 2004. (1:1) merging design and making: Bill massie. *Praxis: Journal of Writing + Building*, no.6(6): [18]-27.
- Hilton, Peter D., and Paul F. Jacobs. 2000. *Rapid tooling : Technologies and industrial applications*. New York: Marcel Dekker.
- Hubbard, Stuart W. 1985. *CAD/CAM : Applications for business*. Phoenix, AZ: Oryx Press.
- Keller, Ed. 2002. Versioning, time and design culture. *Architectural Design* 72, (5) (Sept): pp.29-33.
- Kieran, Stephen, and James Timberlake. 2004. *Refabricating architecture : How manufacturing methodologies are poised to transform building construction*. New York: Mc Graw-Hill.
- Kolarevic, Branko. 2003. *Architecture in the digital age : Design and manufacturing*. New York, NY: Spon Press.

- Kronenburg, Robert. 2001. *Spirit of the machine : Technology as an inspiration in architectural design*. Chichester: Wiley-Academy.
- LaVine, Lance. 2001. *Mechanics and meaning in architecture*. Minneapolis: University of Minnesota Press.
- Le Corbusier, and Frederick Etchells. 1946. *Towards a new architecture*. London: Architectural Press.
- Leach, Neil. 2002. *Designing for a digital world*. Chichester: Wiley-Academic, produced in association with RIBA Future Studies.
- Leach, Neil, David Turnbull, and Chris Williams. 2004. *Digital tectonics*. Chichester, West Sussex, U.K. ; Hoboken, NJ: Wiley-Academy.
- Liu, Yudong. 2003. *Developing digital architecture : 2002 FEIDAD award*. Basel ; Boston: Birkhäuser.
- Lynn, Greg. 2004. *Folding in architecture*. Architectural design. Rev. ed. Chichester, West Sussex ; Hoboken, NJ: Wiley-Academy.
- Lynn, Greg, and Hani Rashid. 2002. *Architectural laboratories*. Rotterdam; New York, NY: NAI; Available in North, South and Central America through D.A.P., Distributed Art Pubs.
- Massie, William E. 2002. Remaking in a post-processed culture. *Architectural Design* 72, (5) (Sept): pp.[54]-59.
- McCullough, Malcolm. 1996. *Abstracting craft : The practiced digital hand*. Cambridge, Mass.: MIT Press.
- Medland, A. J., and Piers Burnett. 1986. *CAD/CAM in practice : A manager's guide to understanding and using CAD/CAM*. New York: Wiley.
- Pelletier, Louise, Alberto Pérez Gómez, and 20 Institut de recherche en histoire de l'architecture. 1994. *Architecture, ethics, and technology*. <Montréal>; Buffalo: Institut de recherche en histoire de l'architecture, Canadian Centre for Architecture, McGill University ;\$aMontreal; McGill-Queen's University Press.

- Perrella, Stephen. 1999. *Hypersurface architecture II*. Architectural design profile. Vol. 141. Chichester: Academy Editions.
- Rahim, Ali. 2002. *Contemporary techniques in architecture*. Profile. Vol. 155. London ; New York: Wiley-Academy.
- ———. 2000. *Contemporary processes in architecture*. Profile. Vol. 145. London ; New York: Wiley-Academy.
- Reeser, Amanda. 2004. Complexity and customization - the porter house condominium: Sharples holden pasquarelli (SHoP). *Praxis: Journal of Writing + Building*, no.6(6): [46]-53.
- Rennie, A. E. W., D. M. Jacobson, C. E. Bocking, and Buckinghamshire Chilterns University College. Centre for Rapid Design and Manufacture. 2002. *Third national conference on rapid prototyping, tooling, and manufacturing : 20-21 june 2002, centre for rapid design and manufacture, buckinghamshire chilterns university college, bigg wycombe*, UK. Bury St. Edmunds: Professional Engineering Publishing.
- Rocker, Ingeborg. 2002. Versioning: Evolving architectures, dissolving identities - “nothing is as persistent as change”. *Architectural Design* 72, (5) (Sept): pp.[10]-17.
- Schodek, Daniel L. 2005. *Digital design and manufacturing : CAD/CAM applications in architecture and design*. Hoboken: John Wiley & Sons.
- Sharples, Christopher, William Sharples, Coren Sharples, Gregg Pasquarelli, Kimberly Holden, and SHoP / Sharples Holden Pasquarelli. 2002. Eroding the barriers: [SHoP - sharples holden pasquarelli]. *Architectural Design* 72, (5) (Sept): pp.90-100.
- ———. 2002. Introduction: [versioning - evolutionary techniques in architecture]. *Architectural Design* 72, (5) (Sept): pp.7-9.
- Speaks, Michael. 2002. Design intelligence: Or thinking after the end of metaphysics. *Architectural Design* 72, (5) (Sept): pp.4-6.

APPENDICES

BUDGET

MATERIALS	COST	SOURCE
• 2x4x12	\$77.76	Roberson Lumber
• 2x4x8	\$109.04	
• 2x6x12	\$12.08	
• 2x6x8	\$35.37	
• 4x8x7/16 OSB	\$244.22	
• 1x6-14 Cedar	\$337.78	
• Insulation	\$114.06	
• House Wrap	\$86.66	
• Clear Poly	\$32.87	
• Asphalt Felt	\$15.60	
• 1x6-16 Cedar	\$89.50	
• Side wind Jacks	\$282.90	Northern Tool
• CNC Cutting	\$356.85	AMI
• Bamboo Flooring	\$1,589.03	ifloor.com
• 3/4" Plywood	\$321.90	Home Depot
• 1/2" Plywood	\$25.95	
• Galvanized Roofing	\$147.30	Facilities
• Polycarbonate	\$97.15	McMaster Carr
• Miscellaneous	\$463.71	
	<hr/>	
	\$4,439.73	Total

LITERATURE MAP

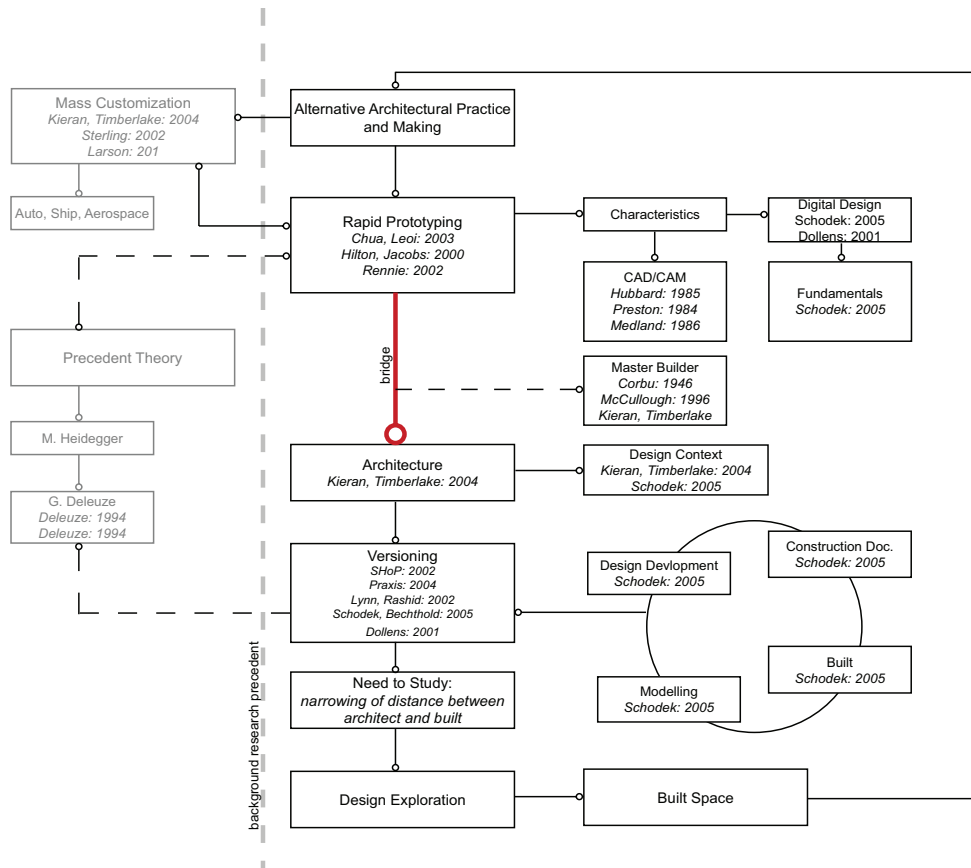

RESEARCH SCHEDULE

