

This is the author's final, peer-reviewed manuscript as accepted for publication. The publisher-formatted version may be available through the publisher's web site or your institution's library.

A study on laser-fiber coupling efficiency and ablation rate in femtosecond laser deep microdrilling

Xinwei Shen, Qiumei Bian, Zenghu Chang, Shuting Lei, and Benxin Wu

How to cite this manuscript

If you make reference to this version of the manuscript, use the following information:

Shen, X., Bian, Q., Chang, Z., Lei, S., & Wu, B. (2012). A study on laser-fiber coupling efficiency and ablation rate in femtosecond laser deep microdrilling. Retrieved from <http://krex.ksu.edu>

Published Version Information

Citation: Shen, X., Bian, Q., Chang, Z., Lei, S., & Wu, B. (2012). A study on laser-fiber coupling efficiency and ablation rate in femtosecond laser deep microdrilling. *International Journal of Mechatronics and Manufacturing Systems*, 5(3-4), 280-293.

Copyright: © 2012 Inderscience Publishers

Digital Object Identifier (DOI): doi:10.1504/IJMMS.2012.048232

Publisher's Link:

<http://www.ingentaconnect.com/content/ind/ijmms/2012/00000005/F0020003/art00007>

This item was retrieved from the K-State Research Exchange (K-REx), the institutional repository of Kansas State University. K-REx is available at <http://krex.ksu.edu>

A Study on Laser-Fiber Coupling Efficiency and Ablation Rate in Femtosecond Laser Deep Microdrilling

Xinwei Shen¹, Qiumei Bian¹, Zenghu Chang², Shuting Lei¹, and Benxin Wu³

¹Industrial and Manufacturing Systems Engineering, Kansas State University, USA

²Department of Physics, Kansas State University, USA

³Mechanical Engineering, Illinois Institute of Technology, USA

Abstract: Laser microdrilling is a common micromachining operation in many industrial applications. This paper presents a new laser microdrilling technique in which a hollow-core fiber is employed to transmit femtosecond laser pulses to the target position. The coupling efficiency between the laser and the fiber is investigated and found to be strongly related to pulse energy and pulse duration. A parametric study on the ablation rate indicates that in microdrilling of a stainless steel (type 303), the operating parameters including pulse energy, pulse duration, sample thickness, focal length and sample-fiber distance can affect the ablation rate. The experimental results show that the new technique developed in this study is feasible to conduct microdrilling of holes with high aspect ratio.

Keywords: Femtosecond laser, microdrilling, ablation rate, hollow-core fiber, stainless steel

Biographical notes: Xinwei Shen is a Ph.D. student in the Department of Industrial and Manufacturing Systems Engineering at Kansas State University. His research interests involve ultrashort pulse laser micro/nano-manufacturing and laser-assisted machining (LAM).

Qiumei Bian is a graduate research assistant in the Department of Industrial and Manufacturing Systems Engineering at Kansas State University. She started her Ph.D in 2008 fall. Her current research interests include femtosecond laser micromaching of different material and exploring the mechanisms of femtosecond laser ablation.

Zenghu Chang is a professor of physics at Kansas State University, currently working in the area of attosecond optics and physics. He received his doctorate in Optics at the Xi'an Institute of Optics and Precision Mechanics in 1988. In 2001 he joined the faculty at Kansas State University. He now serves as the chair of the optical attoscience technique group of the Optical Society of America. Chang is a fellow of the American Physical Society.

Shuting Lei is an Associate Professor in the Department of Industrial and Manufacturing Systems Engineering at Kansas State University. His research focus is to develop laser assisted machining processes and innovative cutting tool technologies to enable high performance machining techniques for difficult to machine materials such as structural ceramics and composites. He has published more than 40 papers in archival journals and conference proceedings in the area of advanced manufacturing processes.

Benxin Wu is an assistant professor at Illinois Institute of Technology. He received his doctorate in Mechanical Engineering at Purdue University. In 2007 he joined the faculty at Illinois Institute of Technology. His research area is laser-matter interactions, laser-based manufacturing and laser applications in micro/nanotechnology and biomedical engineering.

1. Introduction

There are many products associated with microdrilling such as engine blades, fuel injectors, high resolution circuitry, flow control devices, medical devices and so on. A conventional technique to produce microholes is by mechanical microdrilling (Foy et al., 2009; Jun et al., 2007) however, this technique has low efficiency due to chip generation, friction heating at the cutter/sample interface, and potential burr formation in the micromachining process (Richter, 2007). Nonconventional techniques like electrical discharge machining (EDM) and electrochemical microdrilling (ECM) (Kao, Shih, and Miller, 2008; Ahn et al., 2006) also have low efficiency and high machining cost. Other nonconventional techniques such as chemical milling (Torng, Huang, and Chang, 2009), electro-forming and plating (Hayes and Wallace, 1989; Ready, 2001), electron beam drilling (Howitt et al., 2008), ion beam milling (Martelli et al., 2007), mechanical punching/broaching (Joo, Rhim, and Oh, 2005), and glass fiber forming (Durante and Langella, 2009) have limitations in terms of the requirements for equipment or sample materials. However, laser microdrilling, especially with ultrashort pulsed lasers, does not have such limitations and can produce microholes with high quality and high aspect ratio.

Existing techniques for laser microdrilling (single-pulse, percussion, trepanning and helical drilling) (Abeln, Radtke, and Dausinger, 1999) are only suitable for the types of target that a laser beam can directly strike. For target samples with complex geometries that laser beam cannot directly reach, an alternative technique must be used. In this study, the laser beam is directed to propagate through a hollow-core fiber and then reach the target surface.

Due to the flexibility in the design of the machining system, laser beams delivered through a fiber have been used in laser machining (Jones and Georgalas, 1984; De Snaijer et al., 1998; Watanabe et al., 2000; Quintero et al., 2001) and laser assisted machining (Shen and Lei, 2009). The requirement for the beam quality in these applications is generally less stringent. However, for micromachining applications, high beam quality is particularly needed due to the small feature size. Currently, single mode hollow-core fibers are commonly adopted to transmit a high-quality laser beam. Dekel et al. (2000) coupled the CO₂ laser pulses into a single mode hollow-core glass fiber for marking a polyvinyl chloride (PVC) plate. Konorov et al. (2004) used a single mode hollow-core photonic-crystal fiber to transmit picosecond pulses from a Nd:YAG laser to ablate dental tissues. Shephard et al. (2005) delivered the laser beam from a Q-switched Nd:YAG laser through a single mode hollow-core photonic bandgap (PBG) fiber to conduct micromachining of metal sheets. However, so far no studies have been reported on deep microdrilling via a single mode hollow-core fiber transmitted femtosecond pulses.

Compared to nanosecond and picosecond lasers, femtosecond laser is regarded as a potentially ideal tool for precision micromachining. It deposits energy into the material in a very short time, thus resulting in a very small heat affected zone (HAZ) and minimal energy loss into the bulk material (Craig, 1998). This study therefore utilizes an fs laser to conduct percussion microdrilling where laser pulses are delivered through a single-mode hollow-core glass fiber. The main objective is to explore how the operating parameters affect the laser-fiber coupling efficiency and the ablation rate for the target material of a stainless steel (type 303). The paper's structure is organized as follows. The experimental setup for fs laser microdrilling is introduced in Section 2. Then, the investigation of laser-fiber coupling efficiency (Section 3) and ablation rate (Section 4) is followed. Finally, the main conclusions from this study are drawn in Section 5.

2. Experimental Setup

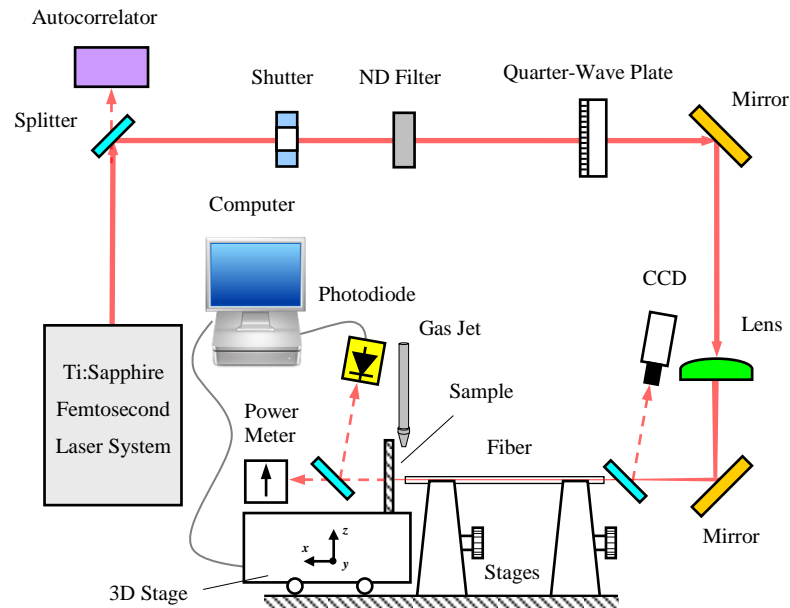

Fig. 1: Schematic diagram of the experimental setup

The experimental setup for microdrilling of a stainless steel (type 303) is schematically shown in Fig. 1. The femtosecond laser system consists of a Ti:Sapphire Coherent Legend Elite Duo chirped pulse amplifier (CPA) that operates at 1 kHz, seeded by a Rainbow oscillator. The laser beam has a center wavelength of 800 nm, repetition rate of 1 kHz, maximum pulse energy of 6 mJ, beam diameter of 10 mm, and beam M^2 factor of 1.33. It is first focused by a focusing lens and then coupled into a hollow-core borosilicate glass fiber mounted on two independent alignment stages. The sample is fixed on a micropositioning stage which is controlled by a computer to move in the x , y and z directions. A fast shutter is used to select the number of pulses. A neutral density filter is applied to adjust the pulse energy into the fiber. The pulse energy and the pulse duration are measured using a power meter and an autocorrelator, respectively. The focus spot is measured with a CCD camera. A quarter-wave plate is used to generate a circularly polarized beam. The laser pulses passing through the drilled hole are detected with a photodiode. The corresponding ablation time is recorded by the computer. In addition, a nitrogen gas jet is employed to blow away the generated debris from microdrilling, thus protecting the fiber end.

3. Investigation on Laser-Fiber Coupling Efficiency

Basically, the hollow-core fiber used in microdrilling has two functions. One is to transmit laser pulses to the target surface, and the other is to act as a spatial filter, thus improving the laser beam quality. In the former function of the hollow-core fiber, the laser-fiber coupling is found to be extremely important in microdrilling, because it decides how much laser energy can be transmitted through the fiber. Hence, the coupling efficiency is purposely investigated in this section. All the experiments in the following sections are conducted in air. The pulse repetition rate and the fiber length are fixed at 1 kHz and 20 mm, respectively.

Fig. 2 shows the variations of coupling efficiency and output pulse energy through the fiber when the input pulse energy changes from 0.17 to 3.65 mJ. The following parameters

are fixed: pulse duration $\tau = 400$ fs, focal length $L = 700$ mm and fiber inner diameter $D = 150$ μm . Initially, as the input pulse energy increases from 0.1 to 1.32 mJ (Zone A), the output pulse energy increase proportionally and the coupling efficiency is almost constant at around 70%. From 1.32 to 2.56 mJ (Zone B), however, the coupling efficiency starts to drop gradually. This is because the peak intensities at these pulse energies have reached the air breakdown threshold ($\sim 10^{14}$ W/cm²) (Shah et al., 2004), which results in air ionization and the loss of pulse energy. Once the fiber is filled with the maximum pulse energy after 2.56 mJ (Zone C), the output energy from the fiber end no longer increases and the coupling efficiency thereby continues to decrease.

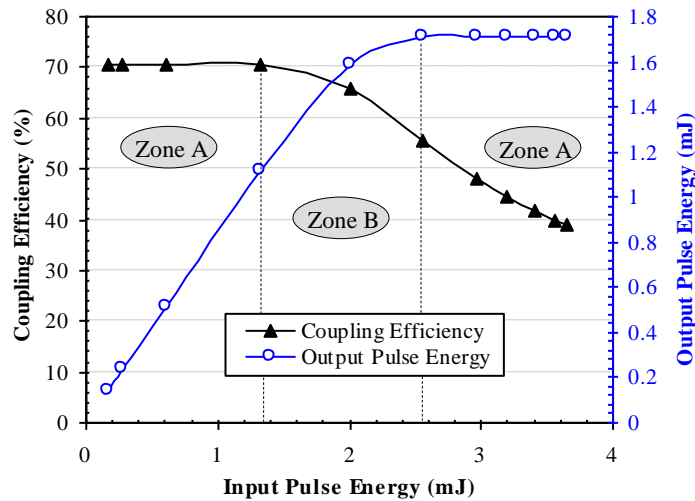

Fig. 2: Effect of pulse energy on coupling efficiency

The variations of coupling efficiency with pulse energy are shown in Fig. 3 for different pulse durations: 50, 200, 400 and 600 fs. The input pulse energy varies from 0.17 to 3.65 mJ and all the other parameters are fixed: fiber inner diameter $D = 150$ μm and focal length $L = 700$ mm. It can be seen that the coupling efficiencies for all four durations are almost the same before air breakdown happens, and a shorter duration leads to smaller pulse energy. In this situation, no energy is lost except the coupling loss. Once air breakdown happens, it can be seen that the coupling becomes less efficient for shorter pulses.

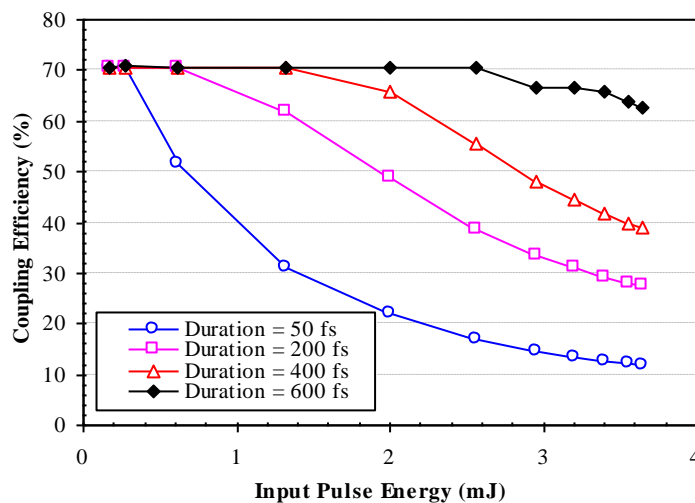

Fig. 3: Effect of pulse duration on coupling efficiency

Fig. 4 shows the variations of the coupling efficiency with pulse energy for different focal lengths: 500, 700 and 1000 mm. The fixed parameters are: pulse energy $E = 0.3$ mJ, pulse duration $\tau = 400$ fs and fiber inner diameter $D = 150$ μm . The laser spot sizes for the three focal lengths (500, 700 and 1000 mm) measured with the CCD camera are 66, 91 and 131 μm , respectively, and the corresponding divergence angles are 0.8, 0.65 and 0.58 deg.

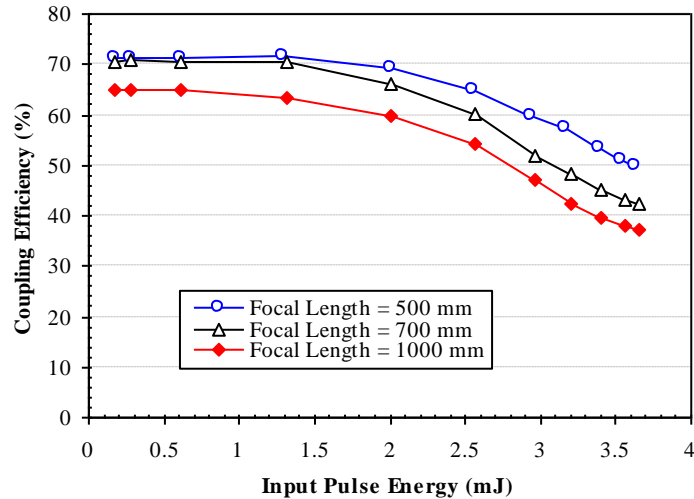

Fig. 4: Effect of focal length on coupling efficiency

For the focal lengths of 500, 700 and 1000 mm, the ratio between the laser spot size and the fiber inner diameter is 0.44, 0.61 and 0.87, respectively. Abrams (1972) pointed out that the ratio for the maximum coupling efficiency is 0.64 from the theoretical calculation. However, the maximum coupling efficiency does not occur for the focal length of 700 mm as shown in Fig. 4, although the ratio is very close to the theoretical value of 0.64. One probable reason is that the theoretical value is calculated based on some assumptions like perfect Gaussian beam, infinitely long fiber, exactly circular beam spot and inner hole of the fiber, etc. These assumptions, however, cannot be realized in the actual laser-fiber coupling setup. Another reason is that a small coupling ratio is prone to induce high-order beam modes that may enhance energy transmission.

4. Parametric Study on Ablation Rate

From the viewpoint of micromachining, a higher ablation rate means that the laser pulse energy is more efficiently applied to material removal. In this study, the ablation rate refers to the average ablation rate which is defined as the ratio between the sample thickness and the pulse number engaged in microdrilling. The pulse number is counted from when the shutter opens till after the first pulse pierces the sample and is detected by the photodiode.

In order to better understand the effects of the operating parameters on the ablation rate, a parametric study is conducted. The parameters include pulse energy, pulse duration, sample thickness, focal length of the focusing lens, and sample-fiber distance (distance between the sample surface and the fiber end). When one parameter is varied, the others are fixed at the reference values indicated in bold italic style in Table 1.

Table 1: Parameters in fs laser microdrilling

Output Pulse Energy (E , mJ)	Pulse Duration (τ , fs)	Sample Thickness (t , mm)	Focal Length (L , mm)	Sample-Fiber Distance (d , mm)
0.5	200			2
0.8	300	0.6	500	7
1.1	400	0.9	700	12
1.4	500	1.2	1000	17
1.7	600			22

4.1 Pulse Energy

The variations of the ablation rate with the output pulse energy from 0.5 to 1.7 mJ are shown in Fig. 5. The fixed parameters are: pulse duration $\tau = 400$ fs, sample thickness $t = 0.9$ mm, focal length $L = 700$ mm, and sample-fiber distance $d = 2$ mm.

It can be seen that higher pulse energy can cause a higher ablation rate and lead to a larger microhole size. As shown in Fig. 6, two microholes of 140 and 155 μm in diameter were produced with pulse energies of 0.5 and 1.7 mJ, respectively. The heated zone around the microholes (indicated by the arrows in Fig. 6) is small for the low pulse energy. Actually, for the laser beam with a Gaussian profile, most of the energy is concentrated in the central area of the microhole. With the pulse energy increasing, the energy at the edge also increases, which causes the microhole size to enlarge and more material to be removed around the edge of the microhole. The roundness of the holes is very good, which is mostly attributed to the spatial filtering effect of the hollow-core fiber.

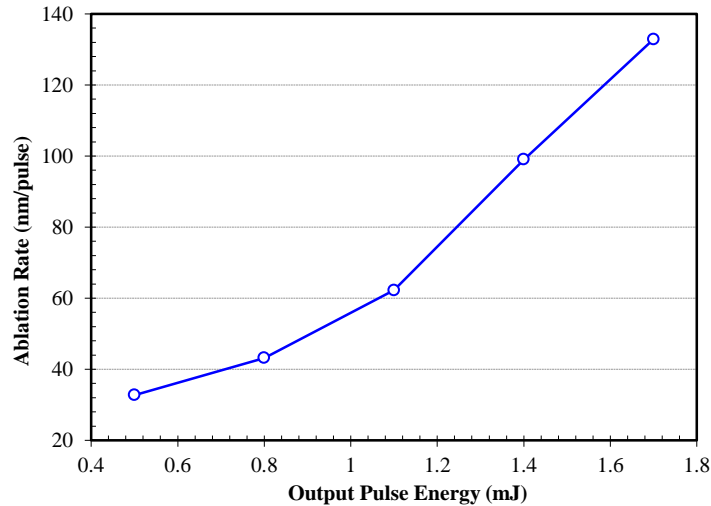
**Fig. 5: Effect of output pulse energy on ablation rate**

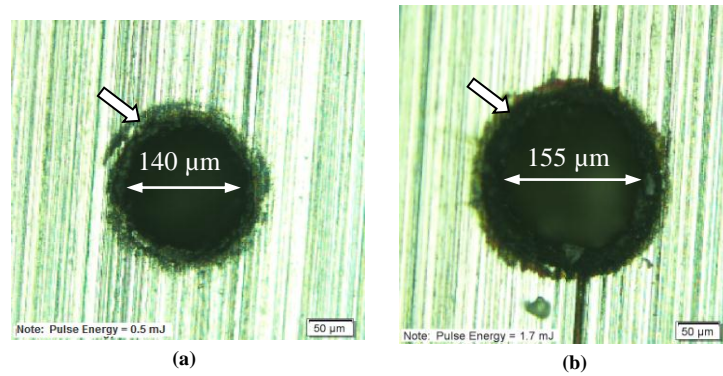

Fig. 6: Comparison of the microholes for (a) pulse energy $E = 0.5$ mJ and (b) pulse energy $E = 1.7$ mJ

4.2 Pulse Duration

Fig. 7 shows the variations of the ablation rate with the pulse duration from 200 to 600 fs. The following parameters are fixed at the reference values: pulse energy $E = 0.8$ mJ, sample thickness $t = 0.9$ mm, focal length $L = 700$ mm, and sample-fiber distance $d = 2$ mm.

It can be seen that with the pulse duration increasing from 200 to 600 fs, the ablation rate decreases. Actually, the pulse duration indicates the time during which optical energy is delivered to the target and absorbed by the sample. For the fixed pulse energy, a shorter pulse duration means a higher laser intensity. A higher intensity laser pulse could bring high temperature deeper into the material after thermalization, thus inducing a higher ablation rate. In addition, a long pulse may also suffer from energy loss due to reflections of the laser irradiation by the dense plasma produced by the leading edge of the pulse.

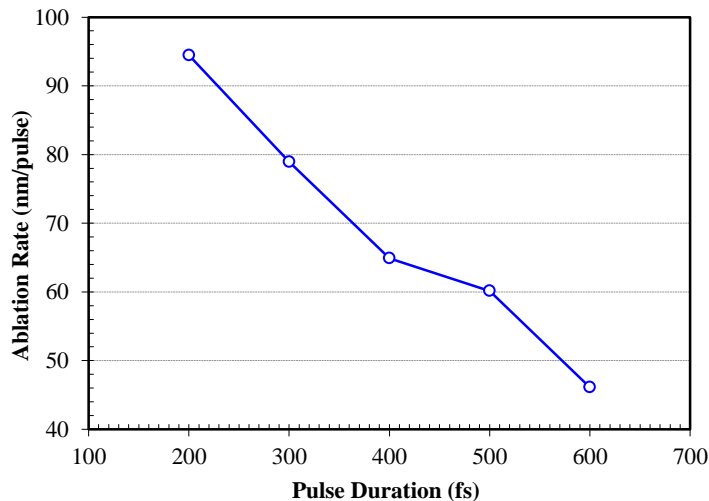

Fig. 7: Effect of pulse duration on ablation rate

4.3 Sample Thickness

The effect of sample thickness on ablation rate is illustrated in Fig. 8 for different thickness values: 0.6, 0.9 and 1.2 mm. The other parameters are fixed at the reference values:

pulse energy $E = 0.8$ mJ, pulse duration $\tau = 400$ fs, focal length $L = 700$ mm, and sample-fiber distance $d = 2$ mm.

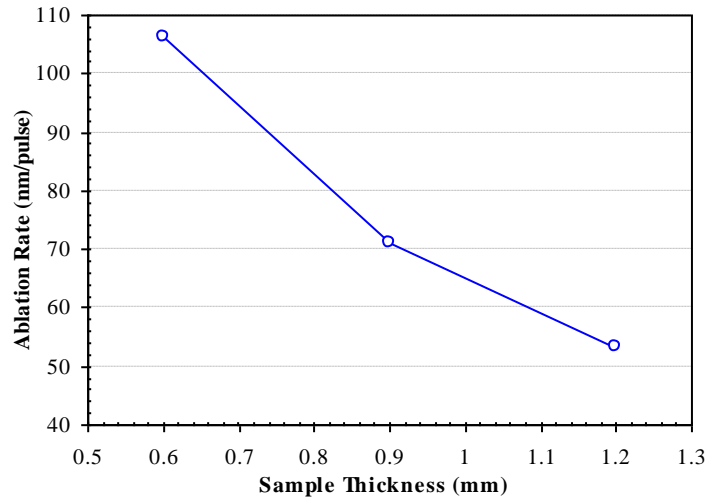

Fig. 8: Effect of sample thickness on ablation rate

As shown in Fig. 8, the ablation rate decreases with the sample thickness. For a series of laser pulses used in percussion microdrilling, it is generally true that more material can be ablated by the beginning pulses than the trailing ones. The reason is that, as the microhole goes deeper, more ablated particles will stay inside the microhole which partially scatter the laser radiation from the following pulses and thus attenuate the laser radiation engaged in material removal, although there is little effect of plasma shielding for femtosecond pulses. Note that the divergence of the laser beam can also reduce the ablation rate because of a decrease of the beam intensity as the beam propagates deeper into the hole.

4.4 Focal Length of the Focusing Lens

Fig. 9 shows the variations of the ablation rate with the focal length of 500, 700 and 1000 mm. The other parameters are fixed at the reference values: pulse energy $E = 0.8$ mJ, pulse duration $\tau = 400$ fs, sample thickness $t = 0.9$ mm, and sample-fiber distance $d = 2$ mm.

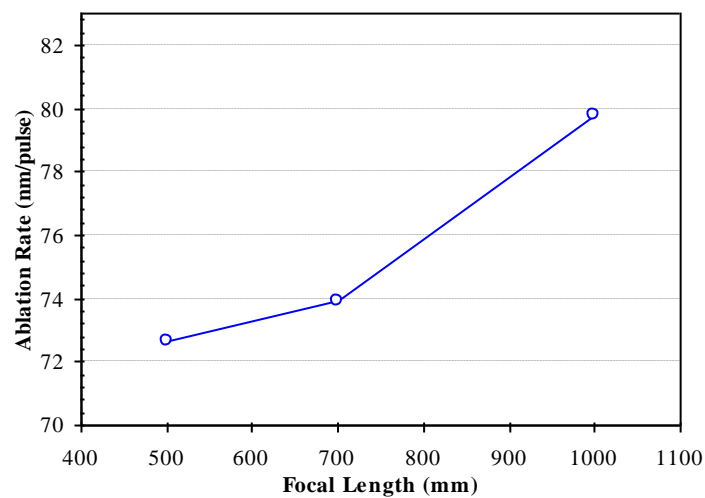

Fig. 9: Effect of focal length of the focusing lens on ablation rate

It is observed that the average ablation rate increases as the focal length changes from 500 to 1000 mm. This is attributed to the improvement in the beam quality as the focal length increases. It is found from our experiments that the laser beam for the focal length of 1000 mm has the best beam mode. In general, the laser intensity distribution after the hollow core fiber takes the shape of a strong central core surrounded by a few weak rings. It is very likely that the central beam for the 1000 mm focal length has the strongest intensity, thus resulting in the highest ablation rate.

4.5 Sample-Fiber Distance

Fig. 10 shows the variations of the ablation rate with the sample-fiber distance from 2 to 22 mm. The other parameters are fixed at the reference values: pulse energy $E = 0.8$ mJ, pulse duration $\tau = 400$ fs, sample thickness $t = 0.9$ mm, and focal length $L = 700$ mm.

It can be seen that the ablation rate decreases almost linearly as the sample-fiber distance increases. It is also noted that the microhole enlarges with the distance increasing. Fig. 11 illustrates two microholes produced with the current operating parameters. The sample-fiber distances are 2 and 22 mm, and the corresponding microhole sizes are 152 and 215 μm , respectively. This is attributed to the divergence of the laser beam. It means that the size of the microhole can be adjusted through the sample-fiber distance.

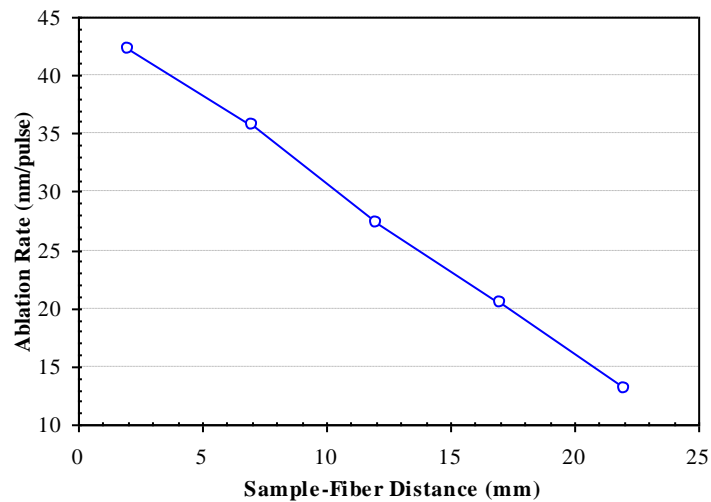

Fig. 10: Effect of sample-fiber distance on ablation rate

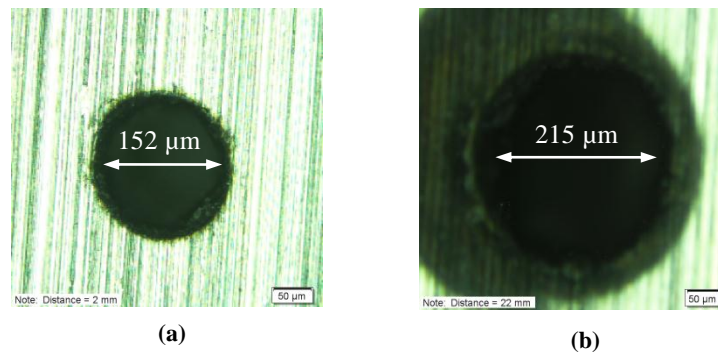

Fig. 11: Comparison of the microholes for (a) sample-fiber distance = 2 mm and (b) sample-fiber distance = 22 mm

The above parametric study reveals that the operating parameters strongly affect the ablation rate in microdrilling. They also influence the geometric quality of the microhole. Fig. 12 shows a typical microhole achievable in this study. The microhole was produced in air with the following operating parameters: pulse energy $E = 1.35$ mJ, pulse duration $\tau = 400$ fs, focal length $L = 700$ mm, fiber inner diameter $D = 150$ μm , and sample-fiber distance $d = 2$ mm. The sizes of the entry and exit holes are 152 and 120 μm , respectively, and the ratio is 1:0.8. It is observed that both the entry and exit sides of the hole have a good roundness. Also, no recast layer around the entry and exit surfaces is found in our experiments. It should be noted that the diameter of the microhole on the entry side where the beam enters the sample is generally larger than that on the exit side. This is mainly due to the fact that the laser beam diverges from the fiber end and thus the laser intensity decreases as it drills through the hole.

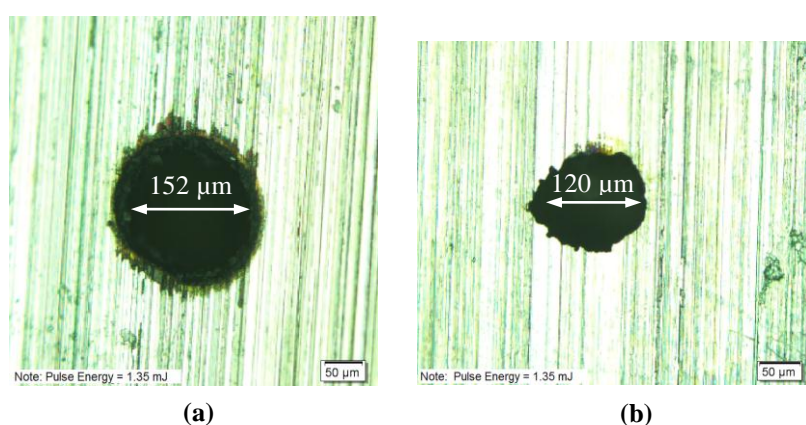

Fig. 12: A microhole (~ 1 mm deep) created in the stainless steel (a) entry side and (b) exit side.

6. Conclusions

The laser-fiber coupling efficiency is found to be strongly associated with air breakdown. Outside the breakdown zone, the coupling efficiency almost remains constant. Within the breakdown zone, it gradually decreases. Although pulse duration does not change the coupling efficiency, it can extend the energy range without air breakdown. A small coupling ratio may cause a high coupling efficiency with a reduction in beam quality. In contrast, a very large coupling ratio may lead to a low coupling efficiency, but the beam quality can be improved.

The new technique is demonstrated to be feasible to drill deep microholes using fs laser pulses delivered through a hollow-core fiber. With a given microhole size and the sample thickness, a high ablation rate can be obtained with a high pulse energy, a short pulse duration, and a long focal length. The microhole roundness is good on the entry side with small distortions caused by heat affected zone. The hole distortion is more pronounced on the exit side mainly due to the laser-material interactions inside the hole. In order to obtain a maximum ablation rate with good microhole quality such as size, roundness and cylindricity, optimization of the operating conditions is required, which will be studied in the next step.

Acknowledgments

Financial support of this work by the National Science Foundation (under Grant No.

CMMI-0826184 and CMMI-0826015) and the DoD Army Research Office (under the Agreement Number W911NF-07-1-0475) is gratefully acknowledged.

References

- Abeln, T., Radtke, J. and Dausinger, F. (1999) 'High precision drilling with short-pulsed solid-state lasers,' *Proc. Laser Microfabrication Conf. ICALEO '99*, San Diego, USA, pp. 195-203.
- Abrams, R.L. (1972) 'Coupling losses in hollow waveguide laser resonators,' *IEEE Journal of Quantum Electronics*, Vol. 8 No. 11, pp. 838-843.
- Ahn, Y., Kim, D.J., Lee, S.H. and Kim, Y.K. (2006) 'Voltage pulse frequency and duty ratio effects in an electrochemical discharge microdrilling process of pyrex glass,' *International Journal of Machine Tools & Manufacture*, Vol. 46 No. 10, pp. 1064-7.
- Craig, B. (1998) 'Ultrafast pulses promise better processing of fine structures,' *Laser Focus World*, Vol. 34 No. 9, pp.79.
- De Snaijer, A., Verdaasdonk, R.M., Grimbergen, M.C., Van S. and Christiaan F.P. (1998) 'Design and realization of a fiber delivery system for the continuous wave and pulsed CO₂ laser,' *Proceedings of SPIE - The International Society for Optical Engineering*, Vol. 3262, pp. 108-118.
- Dekel, B., Inberg, A., Croitoru, N., Shalem, S. and Katzir, A. (2000) 'Hollow glass waveguides and silver halide fibers as scanning elements for CO₂ laser marking systems,' *Optical Engineering*, Vol. 39 No. 5, pp. 1384-1390.
- Durante, M. and Langella, A. (2009) 'Bearing behavior of drilled and molded-in holes,' *Applied Composite Materials* Vol. 16 No. 5, pp. 297-306.
- Foy, K., Wei, Z., Matsumura, T. and Huang, Y. (2009) 'Effect of tilt angle on cutting regime transition in glass micromilling,' *International Journal of Machine Tools and Manufacture*, Vol. 49 No. 3-4, pp. 315-324.
- Hayes, D.J. and Wallace, D.B. (1989) 'Overview of small holes,' *Technical Paper - Society of Manufacturing Engineers*, MS89-814-1-11.
- Howitt, D.G., Chen, S.J., Gierhart, B.C., Smith, R.L. and Collins, S.D. (2008) 'The electron beam hole drilling of silicon nitride thin films,' *Journal of Applied Physics*, Vol. 103 No. 2, 024310 (7 pages).
- Jones, M.G. and Georgalas, G. (1984) 'Flexible beam delivery for material processing laser power through a fiber optic cable,' *Proceedings of the Scientific Applications of Lasers Symposium, ICALEO '83*, LIA (Laser Institute of America), Vol. 38, pp. 149-153.
- Joo, B.Y., Rhim, S.H. and Oh, S.I. (2005) 'Micro-hole fabrication by mechanical punching process,' *Journal of Materials Processing Technology*, Vol. 170 No. 3, pp. 593-601.
- Jun, M.B.G., Bourne, K., DeVor, R.E. and Kapoor, S.G. (2007) 'Estimation of effective error parameters in high-speed micro-endmilling,' *International Journal of Machine Tools and Manufacture*, Vol. 47 No. 9, pp. 1449-1454.
- Kao, C.C., Shih, A.J. and Miller, S.F. (2008) 'Fuzzy logic control of microhole electrical discharge machining,' *Journal of Manufacturing Science and Engineering*, Vol. 130 No. 6, pp. 0645021-0645026.
- Konorov, S.O., Mitrokhin, V.P., Fedotov, A.B., Sidorov-Biryukov, D.A., Beloglazov, V.I., Skibina, N.B., Shcherbakov, A.V., Wintner, E., Scalora, M. and Zheltikov, A.M. (2004) 'Laser ablation of dental tissues with picosecond pulses of 1.06- μm radiation transmitted through a hollow-core photonic-crystal fiber,' *Applied Optics*, Vol. 43 No. 11, pp. 2251-6.
- Martelli, C., Olivero, P., Canning, J., Groothoff, N., Gibson, B. and Huntington, S. (2007) 'Micromachining structured optical fibers using focused ion beam milling,' *Optics Letters*, Vol. 32 No. 11, pp. 1575-1577.

Quintero, F., Pou, J., Lusquinos, F., Larosi, M., Soto, R. and Perez-Amor, M. (2001) 'Cutting of ceramic plates by optical fiber guided Nd:YAG laser,' *Journal of Laser Applications*, Vol. 13 No. 2, pp. 84-88.

Ready, J.F., (editor) (2001) *LIA Handbook of Laser Materials Processing*, Laser Institute of America, magnolia Publishing, Inc.

Richter, A. (2007) 'Hole-down: options for and considerations for micro-holemaking,' *Cutting Tool Engineering*, Vol. 59 No. 2, pp. S2-7.

Shah, L., Tawney, J., Richardson, M. and Richardson, K. (2004) "Self-focusing during femtosecond micromachining of silicate glasses," *IEEE Journal of Quantum Electronics*, Vol. 40 No. 1, pp. 57-67.

Shen, X. and Lei, S. (2009) 'Thermal modeling and experimental investigation for laser assisted milling of silicon nitride ceramics,' *Journal of Manufacturing Science and Engineering*, Vol. 131, 051007 (10 pages).

Shephard, J.D., Couny, F., Russell, P.St.J., Jones, J.D.C., Knight, J.C. and Hand, D.P. (2005) 'Improved hollow-core photonic crystal fiber design for delivery of nanosecond pulses in laser micromachining applications,' *Applied Optics*, Vol. 44 No. 21, pp. 4582-8.

Torng, C.C., Huang, C. and Chang, H.M. (2009) 'Process control for aerospace chemical milling process,' *International Journal of Manufacturing Technology and Management*, Vol. 18 No. 3, pp. 308-318.

Watanabe, T., Kobayashi, H., Suzuki, K. and Beppu, S. (2000) 'Cutting of thick steel with fiber-delivered high power Nd:YAG laser beam,' *Proceedings of SPIE - The International Society for Optical Engineering*, Vol. 3888, pp. 635-642.