

125

EFFECT OF SONIC PULSES ON  
RATE OF EVAPORATION

325

by

WILLIAM HENRY BUCKHANNAN

B. S., Kansas State University, 1955

---

A MASTER'S THESIS

submitted in partial fulfillment of the

requirements for the degree

MASTER OF SCIENCE

Department of Chemical Engineering

KANSAS STATE UNIVERSITY  
Manhattan, Kansas

1966

Approved by:

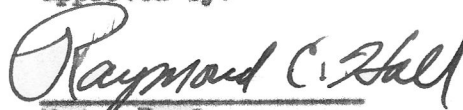
  
Major Professor

LD  
2668  
T4  
1966  
B84  
C.2  
Document

TABLE OF CONTENTS

INTRODUCTION . . . . . 1

    Review of Literature . . . . . 1

    Objectives of Study . . . . . 2

    Summary of Previous Investigations . . . . . 2

MATERIALS AND METHODS . . . . . 3

EQUIPMENT AND APPARATUS . . . . . 3

EXPERIMENTAL PROCEDURE . . . . . 10

DATA AND RESULTS . . . . . 11

    Sonic Intensities . . . . . 11

    Smoke Observations . . . . . 31

    Rates of Evaporation . . . . . 33

    Miscellaneous . . . . . 45

DISCUSSION . . . . . 45

    Sonic Intensities . . . . . 46

    Smoke Observations and Rates of Evaporation . . . . . 47

CONCLUSIONS . . . . . 56

RECOMMENDATIONS . . . . . 57

ACKNOWLEDGMENTS . . . . . 59

LITERATURE CITED . . . . . 60

APPENDIX . . . . . 62

## INTRODUCTION

### Review of Literature

A number of articles are available in the literature discussing various effects resulting from the application of sonic pulses in both the audible and ultrasonic frequency ranges. Among the phenomena that have been treated are liquid-liquid extraction (1), sublimation (2), evaporation (3, 4, 5), gas absorption (6), and heat transfer (7, 8). The articles which were of greatest interest during the present investigation were those dealing with streaming (9-16) and those by previous investigators (3, 4) whose experimental equipment was similar to that utilized in the present study.

It was known prior to the present century (17) that the passage of sonic pulses through a transmitting fluid can, under certain conditions, result in the development of flow in the fluid which is different in nature than the to-and-fro motion associated with the transmission of the sonic pulses. This flow is a steady flow and is called streaming. The streaming has been considered as resulting from two different sources (16). It can result either from an interaction between the transmitting fluid and the sonic pulses, or by an interaction between both of these and the solid boundaries which are contacted by the sonic pulses. The term sonic pulses does not distinguish between audible and ultrasonic pulses in this work unless specified otherwise.

A number of attempts have been made to determine solutions to the equations of fluid dynamics as applied to streaming; however, formal solutions exist only for relatively simple cases (9-16).

### Objectives of Study

The objectives of this study were to improve the understanding of the mechanism by which sonic pulses produced changes in evaporation rates and, if possible, to determine quantitative relationships between the evaporation rates and the operating conditions.

### Summary of Previous Investigations

Prior to the present study, both Chueh (3) and Nichols (4) conducted somewhat similar investigations of the effect of sonic pulses on rates of evaporation. Both Chueh and Nichols observed increases in evaporation rates as great as two hundred percent upon the application of sonic pulses. In addition, both Chueh and Nichols observed small reductions in evaporation rates upon the application of sonic pulses for some of the operating conditions used.

Only Chueh conducted any studies of flow patterns by smoke observations. Though he related little of the details of his work on smoke observations, he failed to observe a change in the smoke patterns upon the application of sonic pulses. These results led him to conclude that the movement of the diaphragm of the sonic driver did not create a "wind current," which could be responsible for the large increases in evaporation rates observed upon the application of sonic pulses.

The present study did not accept Chueh's conclusion that there was no "wind current." A number of observations of smoke patterns were made to further study the possible existence of a "wind current."

## MATERIALS AND METHODS

This study considered the effect of sonic pulses on the rates of evaporation of pure water into a stream of dry air. The rates of evaporation were determined both with and without the application of the sonic pulses. Observations were also made of the changes in air flow occurring upon the application of the sonic pulses; this was made possible by injection of smoke into the system. Data on evaporation rate and smoke patterns were compared for various equipment arrangement and operating conditions.

## EQUIPMENT AND APPARATUS

The arrangement of the equipment and apparatus used in this study was essentially the same as that employed by Nichols (4) except for the locations of the sonic driver and the evaporative surface. These locations were varied in five different equipment setups.

Figure 1 illustrates equipment setups N and A. Setup N was geometrically identical to the equipment setup used by Nichols where the evaporative surface was 1-3/4 in. below the ceiling of the main tunnel. Setup A was identical to setup N except for the relocation of the evaporative surface at a point three inches below the top of the main tunnel. Thus, the evaporative surface was centered in the main tunnel in setup A.

Figures 2, 3, and 4 illustrate setups B, C, and D, respectively. The central location of the evaporative surface in the main tunnel as used in setup A was maintained in these three setups, while the location of the sonic driver was varied. Setups B, C, and D each had a vertical tunnel between the sonic driver and the main tunnel containing the evaporative surface. The

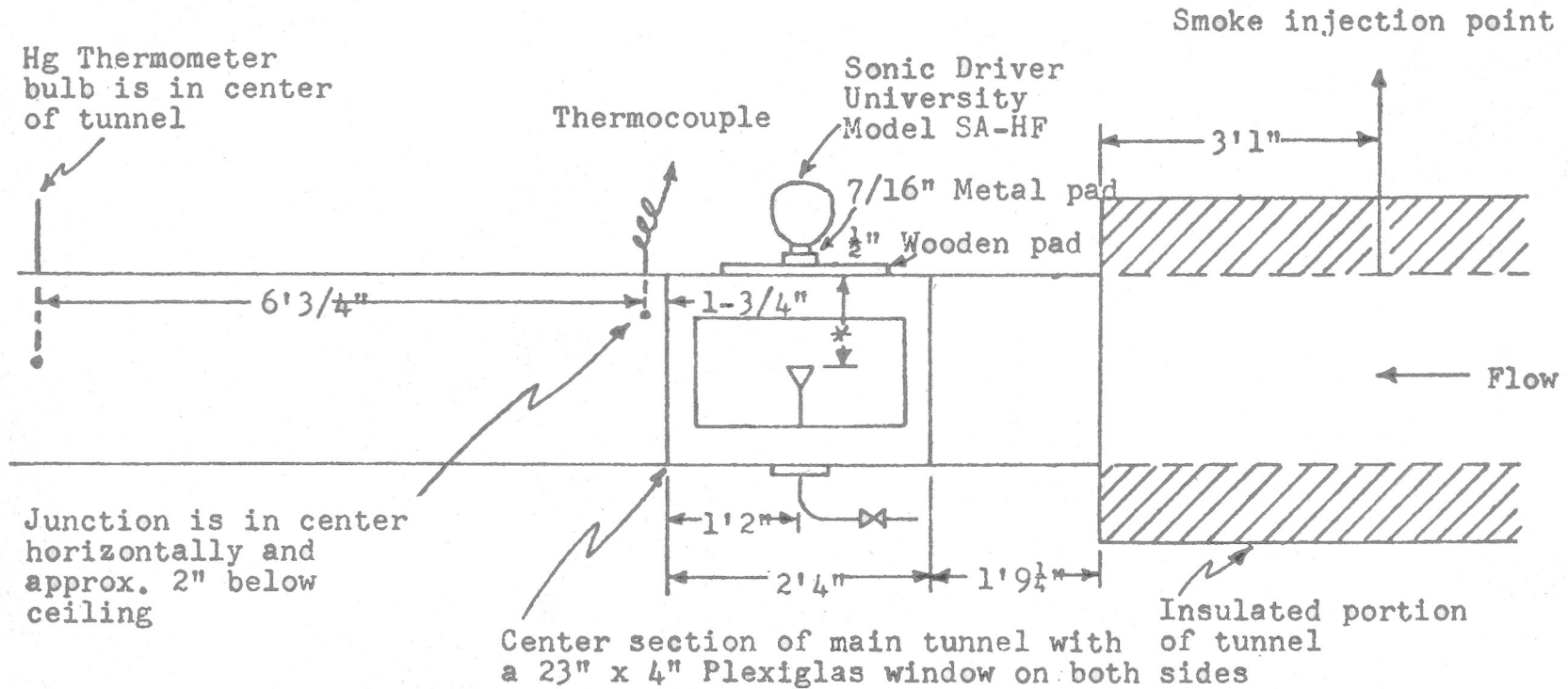

\*For this dimension experimental Setup N used 1-3/4" and Setup A used 3"

Figure 1

Equipment Setups N and A

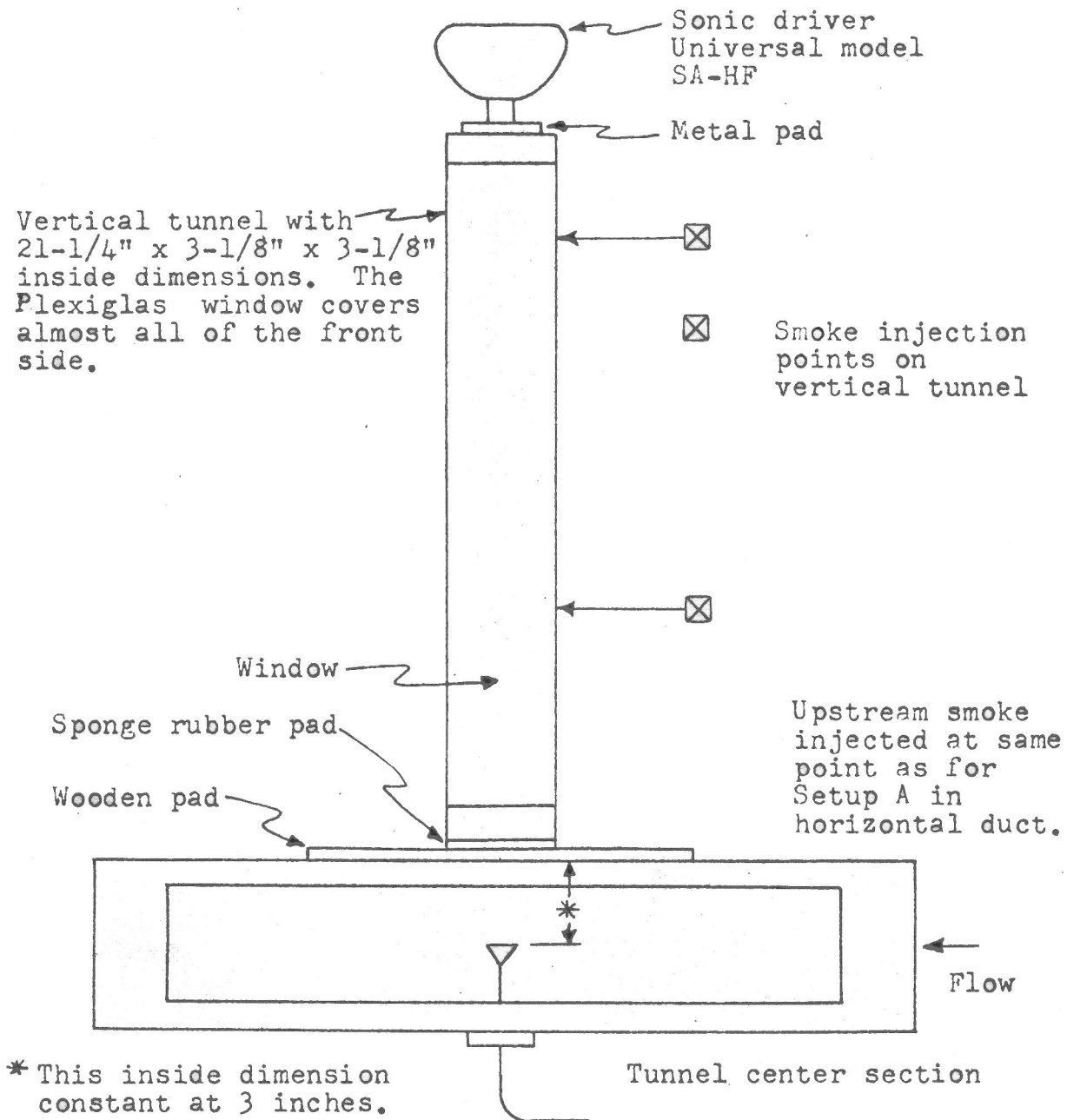

Figure 2

Equipment Setup B.

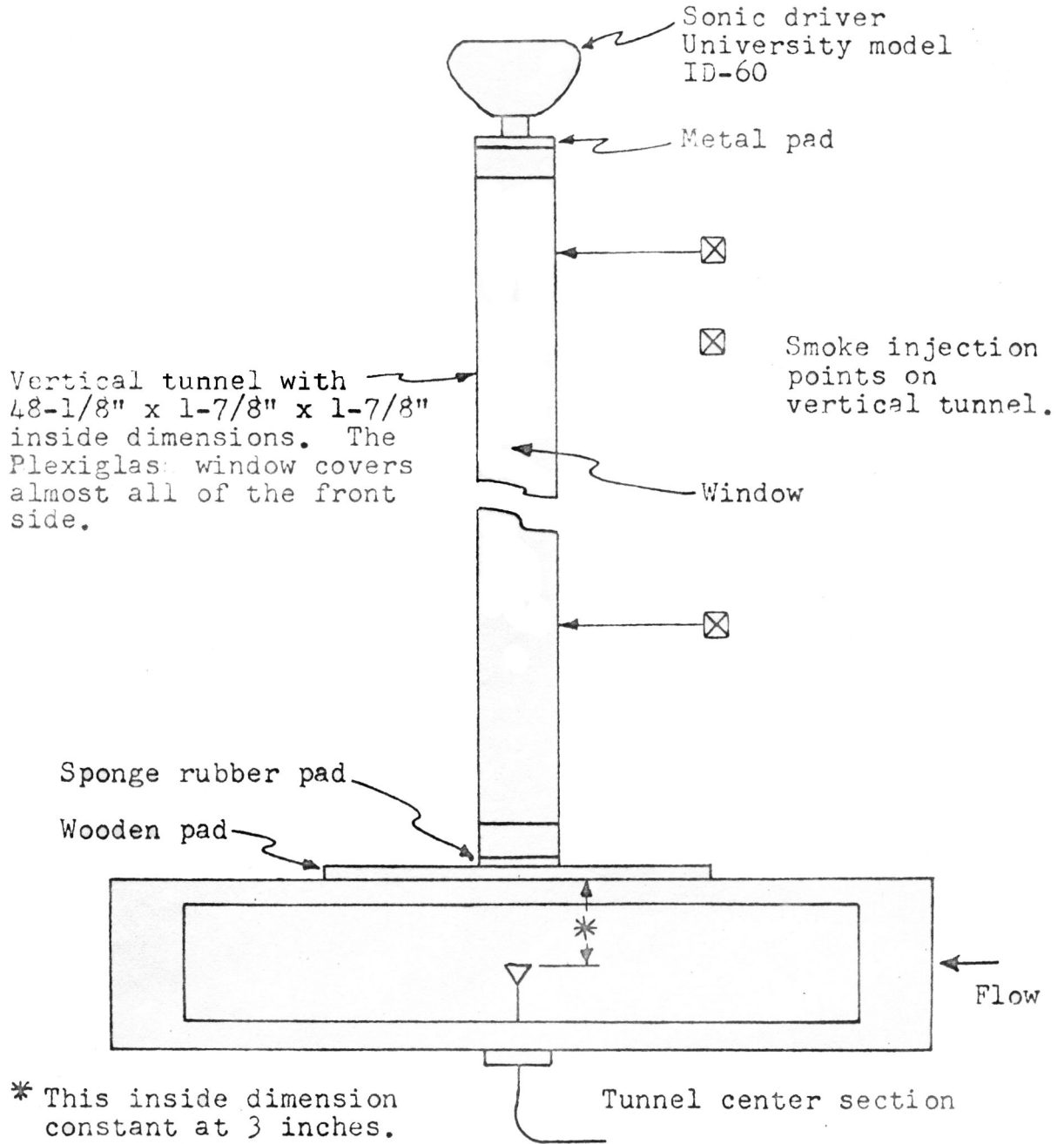

Figure 3  
Equipment Setup C.



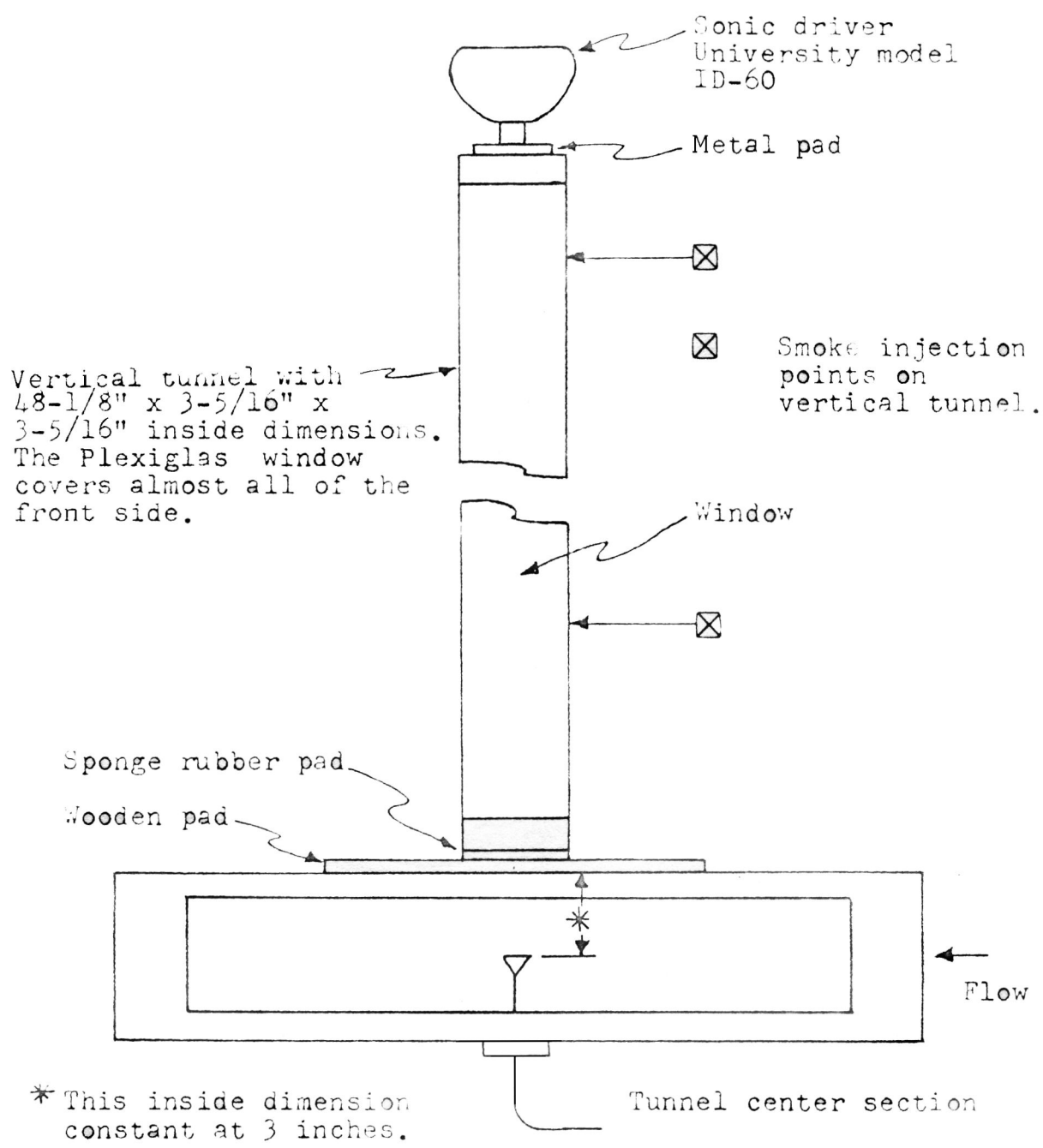

Figure 4  
Equipment Setup D.

dimensions of the vertical tunnel varied for setups B, C, and D and are given on Figures 2, 3, and 4, respectively.

While the above variations in the equipment setups were the principal differences between the equipment used by Nichols and that used in this study, a number of minor changes and similarities were as follows:

1. The center section of the main tunnel was replaced with a new section having the same internal shape and dimensions but with Flexiglas side windows to improve visual observation of the space surrounding the evaporative surface. This is illustrated in Figure 1.

2. Various sonic drivers were used. Sonic driver SP-3 was a University model SA-HF unit and was the same type as used by Nichols. This sonic driver was used in equipment setups A and B. Sonic driver SP-15 was a University model ID-60 unit and was used in equipment setups C and D.

3. The evaporative surface was similar to that used by Nichols. It is not known if it was identically the same evaporative surface.

4. The arrangement of the capillary tubing used to measure the rates of evaporation was altered in such a manner as to change the head of water supported by the evaporative surface. Work by Chueh (3) indicated this change would have no effect on the evaporation rates.

5. Smoke was injected into the experimental equipment at various times but not during evaporation runs. The points of smoke injection are given on Figures 1 to 4. Smoke observations for equipment setups A and B were made using light directed horizontally into the main tunnel through the Flexiglas side; this light illuminated the entire center section of the main tunnel. A beam of light was directed vertically up through a hole in the bottom of the main tunnel when equipment setups C and D were used; this beam was approximately 1-3/4 in. in diameter and illumination of the smoke was limited to the

path of the vertical beam of light. The evaporative surface was not used during smoke observations for equipment setups C and D.

6. The air flow meter was the same as that used by both Chueh and Nichols; its calibration was checked and found not to have changed.

7. The equipment used to determine sonic intensities was the same as that used by Nichols except that an additional microphone and two additional extension cables were also used. The new microphone was a Shure Model 76B lapel microphone that had been removed from its case and mounted on the end of a piece of copper tubing. An extension cable was made up for use with the lapel microphone and was not used with any of the other microphones. The other new extension cable was a General Radio Company Type 759-P30 twenty-five ft. extension cable designed for use with the Shure 9898 microphone supplied with the sound level meter (General Radio Company Type 1551-A). Extension cable 759-P30 was used for all work using setups C and D. The older extension cable (General Radio Company Type 759-P23) was the one supplied with the dynamic microphone assembly (General Radio Company Type 759-P25); this was probably the extension cable Nichols employed and was used in the present study for all work using the Shure 9898 microphone with setups N, A, and B. The Type 759-P23 extension cable is not recommended for use with the Shure 9898 microphone; therefore, some errors may have resulted from the use of this cable in the present study and possibly by Nichols.

8. The volumes of the sections on the capillary measuring tube are given in Table 1.

The smoke injected into the tunnels was produced either by burning tobacco or by bubbling air through titanium tetrachloride. The air used to generate the smoke was less than two percent of the main air flow through the tunnel; hence, its influence on the measured air flow was assumed to be negligible.

The terminal settling velocities of the titanium tetrachloride and tobacco smoke particles were estimated to be less than 0.33 ft./min. and 0.01 ft./min., respectively. These low settling velocities indicated that smoke observations would provide a satisfactory means of detecting air disturbances that had sufficient movement to be detected by visual observation.

The smoke generated from the titanium tetrachloride was corrosive. This made it necessary to dismantle and clean the equipment, including the air blower, after completing the runs with the titanium tetrachloride smoke.

#### EXPERIMENTAL PROCEDURE

The principal variables studied in this work were rates of evaporation, the arrangement or geometry of the apparatus (setups N, A, B, C and D), and the frequency and intensity of the sonic pulses. A group of consecutive runs was usually made to determine the rates of evaporation both with and without the application of sonic pulses for each set of operating conditions. The effect of the sonic pulses was considered to be indicated by comparisons within a group of runs.

Observations were also made when smoke was injected into the system to determine if the application of the sonic pulses would cause a disturbance in the smoke flow patterns that might be visually discernible. Although the smoke was introduced both with and without the evaporative surface present, no data on rates of evaporation were taken without cleaning of the evaporative surface after smoke had been used. This was done to avoid any possible contamination of the evaporative surface.

The effects of temperature and air velocity were not studied. Temperatures were in the 81 to 85°F range for groups of runs where sonic pulses were

applied. Temperature variations in this range were assumed to have a negligible effect on the ratio of the rate of evaporation with application of sonic pulses to the evaporation rate without sonic pulses. Although air velocity was not controlled over as small a range as temperature, two narrow subranges of velocities were used for most of the evaporation runs. Air velocities were generally low as Nichols' results (4) indicated the effect of the sonic pulses were more obvious at low velocities.

Sonic intensities were determined by replacing the evaporative surface with a microphone which was connected to the sound level meter. These intensity determinations were taken either before or after the evaporation runs and for certain equipment setups, were not repeated as frequently as the evaporation runs.

#### DATA AND RESULTS

The principal data of interest obtained in this study may be divided into the three following classes: 1. Data on sonic intensities, 2. Observations of air agitation as indicated by movement of smoke particles, and 3. Data on rates of evaporation.

#### Sonic Intensities

The data obtained on sonic intensities are given in Tables 2, 3, and 4, and in Figures 5 through 20. These sonic intensities were determined by positioning a microphone at the location of interest which usually was the location of the evaporative surface. Sonic intensities are to be considered as corrected for any effects of the sound level equipment unless specified otherwise.

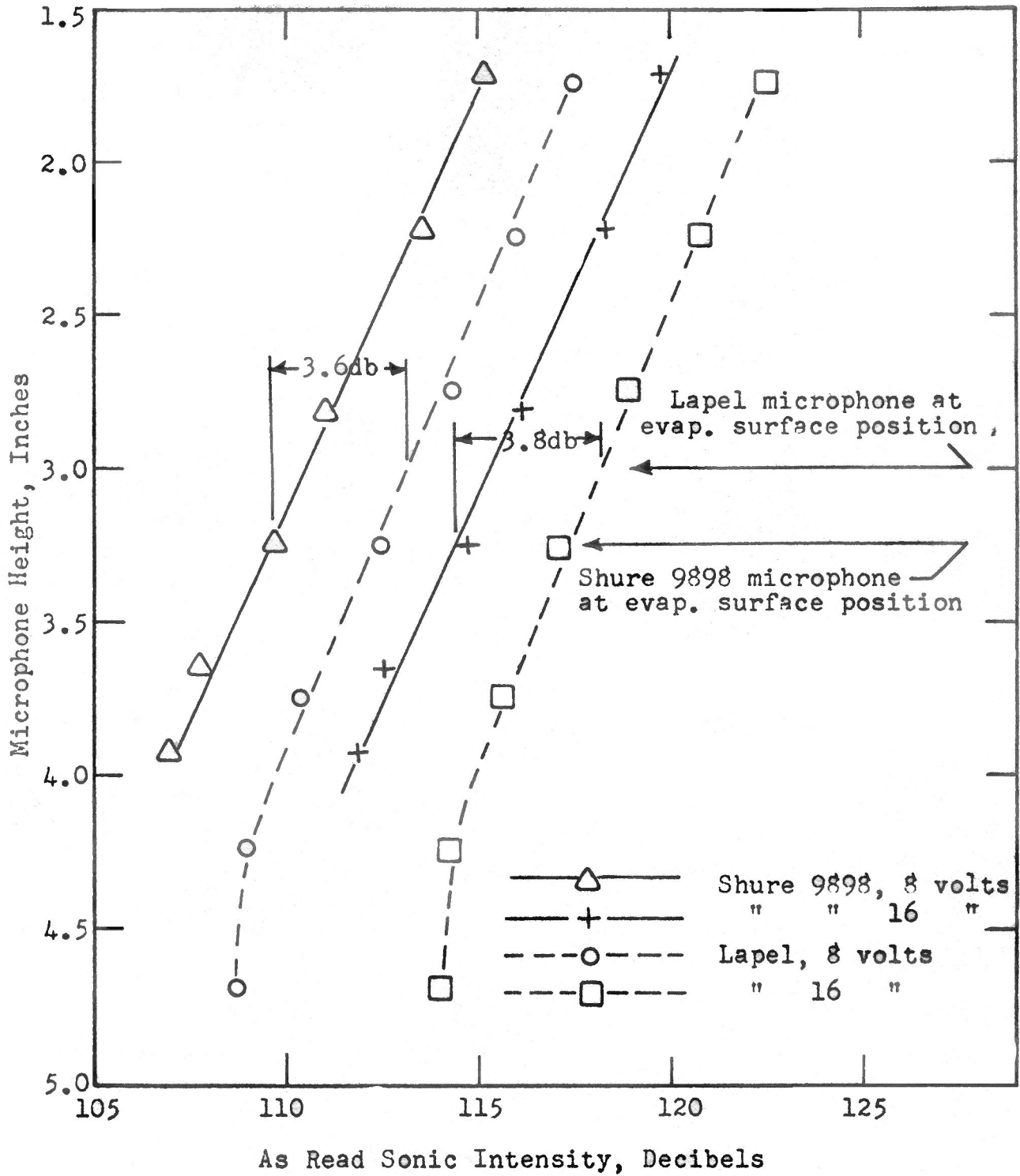

Figure 5

As Read Sonic Intensity vs. Microphone Height  
 Equipment Setup B, 600 cps, Shure 9898 and Lapel Microphones

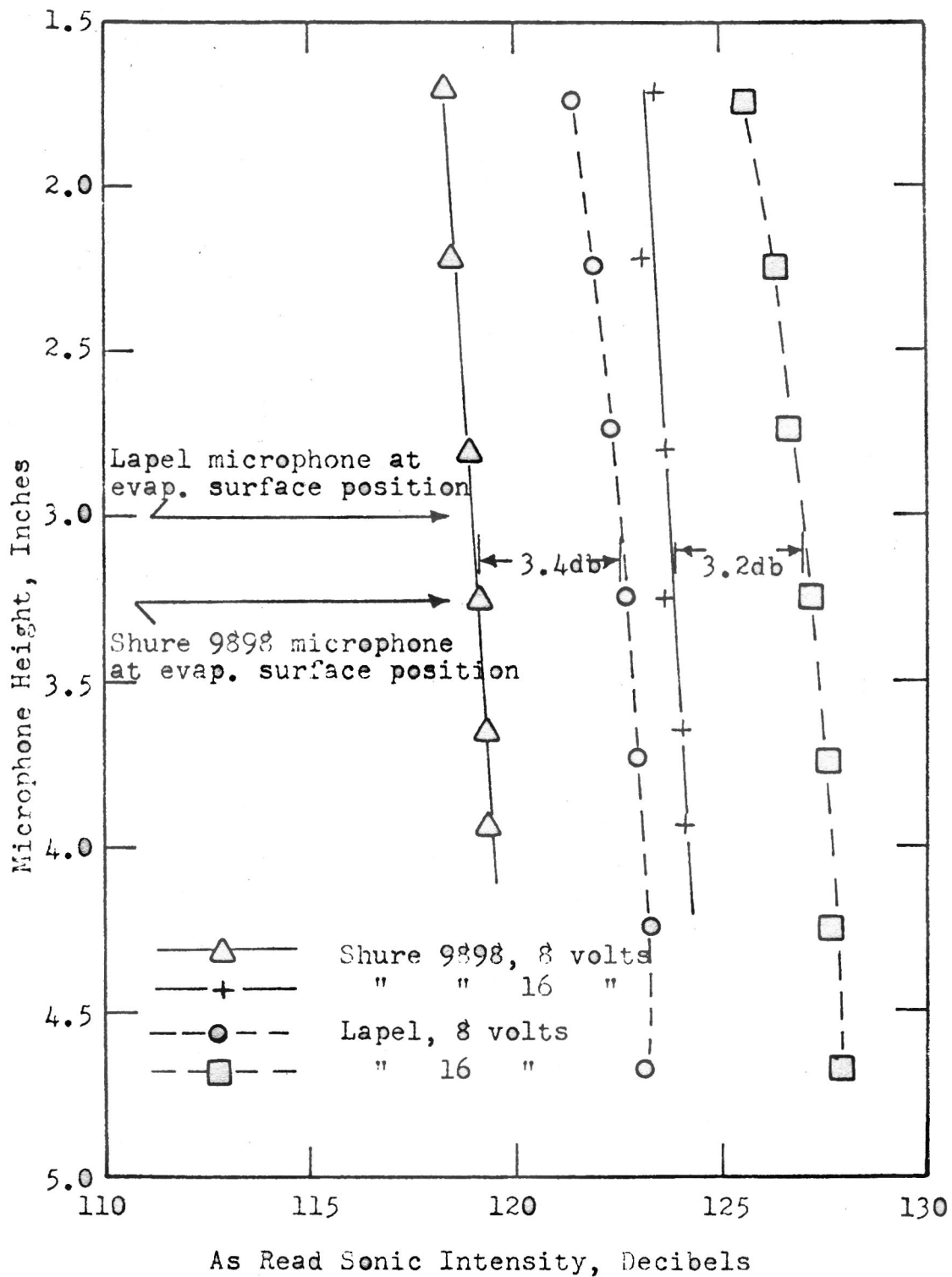

Figure 6

As Read Sonic Intensity vs. Microphone Height  
 Equipment Setup B, 660 cps, Shure 9898 and Lapel Microphones

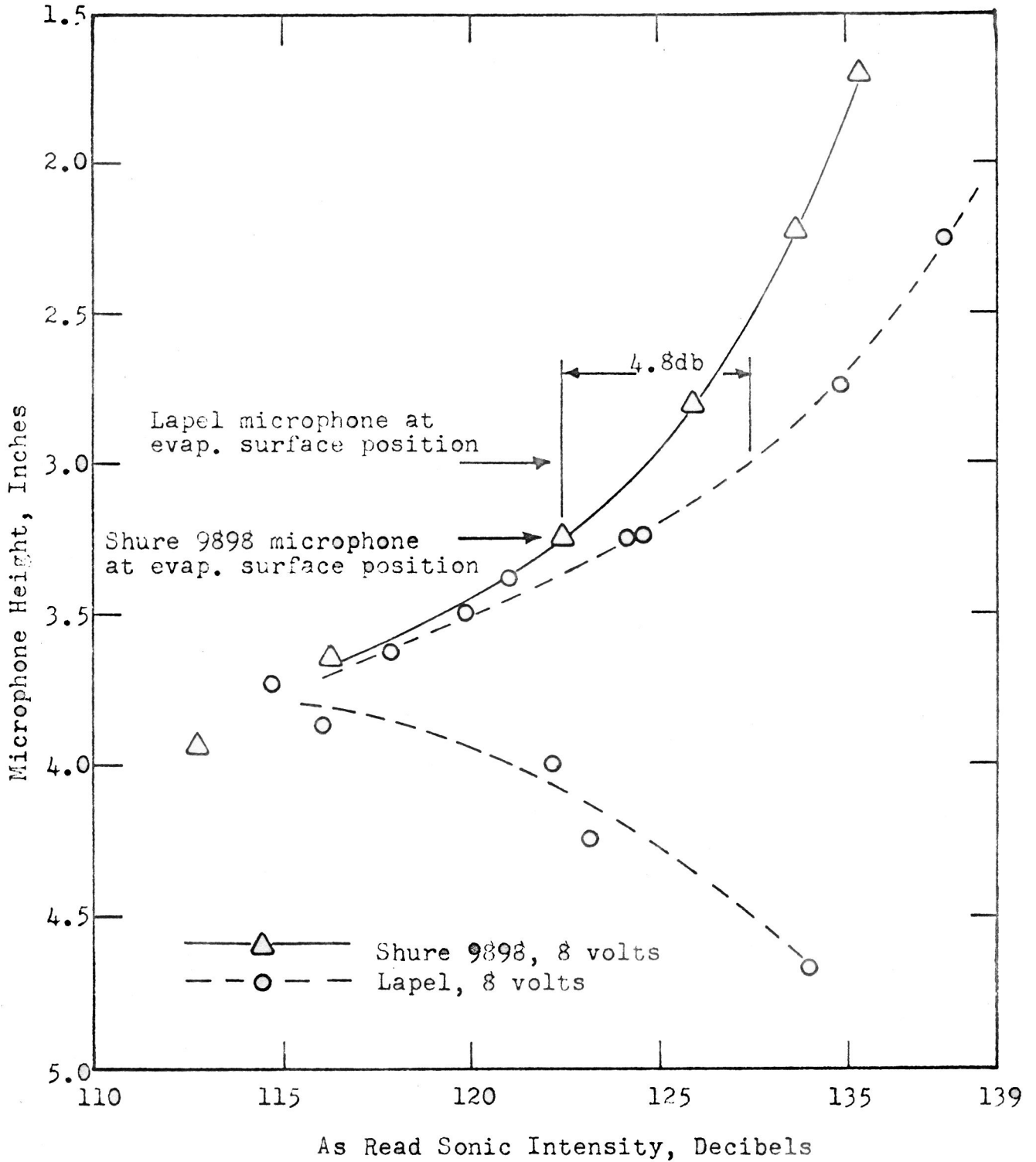

Figure 7

As Read Sonic Intensity vs. Microphone Height  
Equipment Setup B, 1200 cps, Shure 9898 and Lapel Microphones



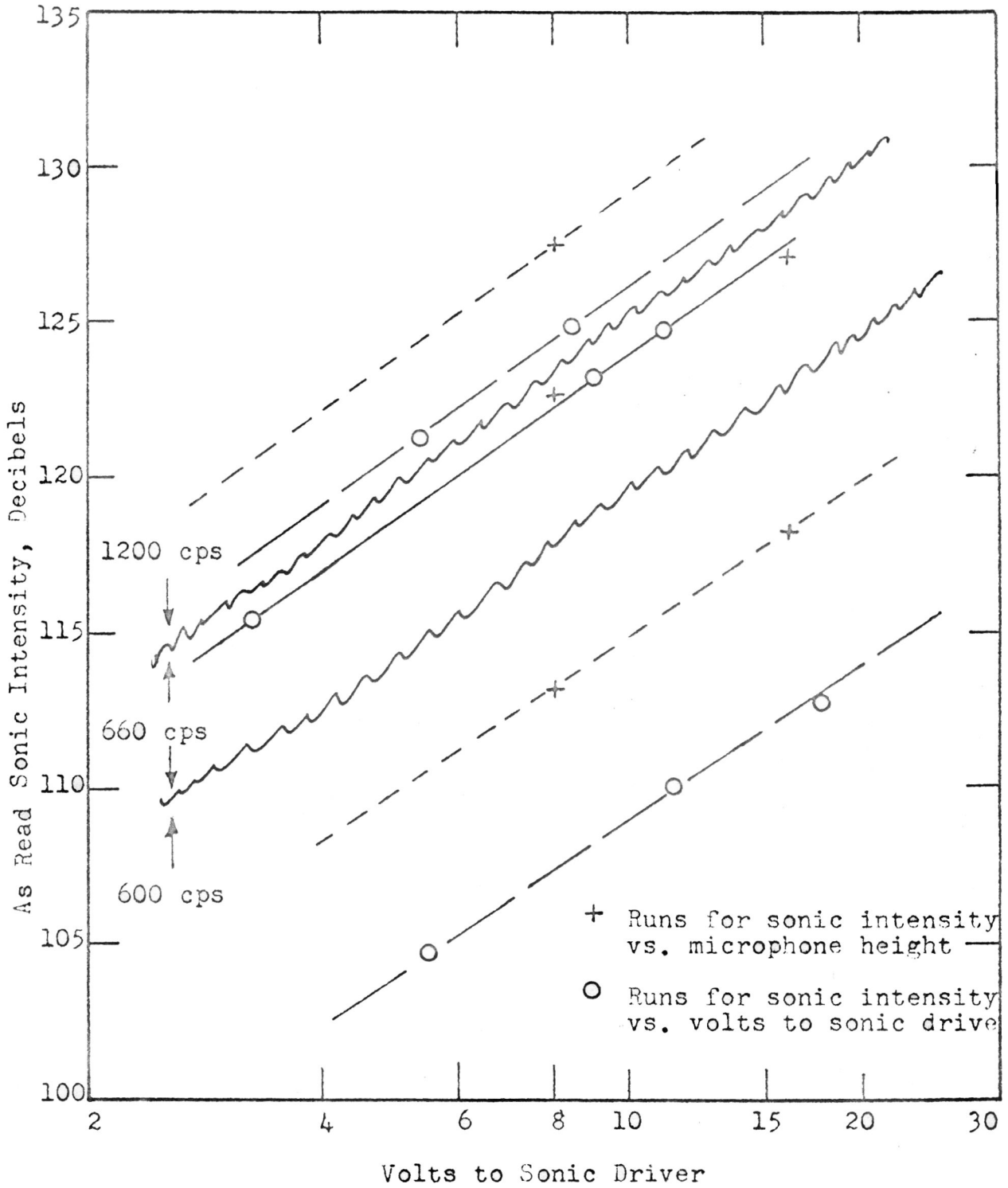

Figure 8

As Read Sonic Intensity vs. Volts to Sonic Driver  
Equipment Setup B, Lapel Microphone

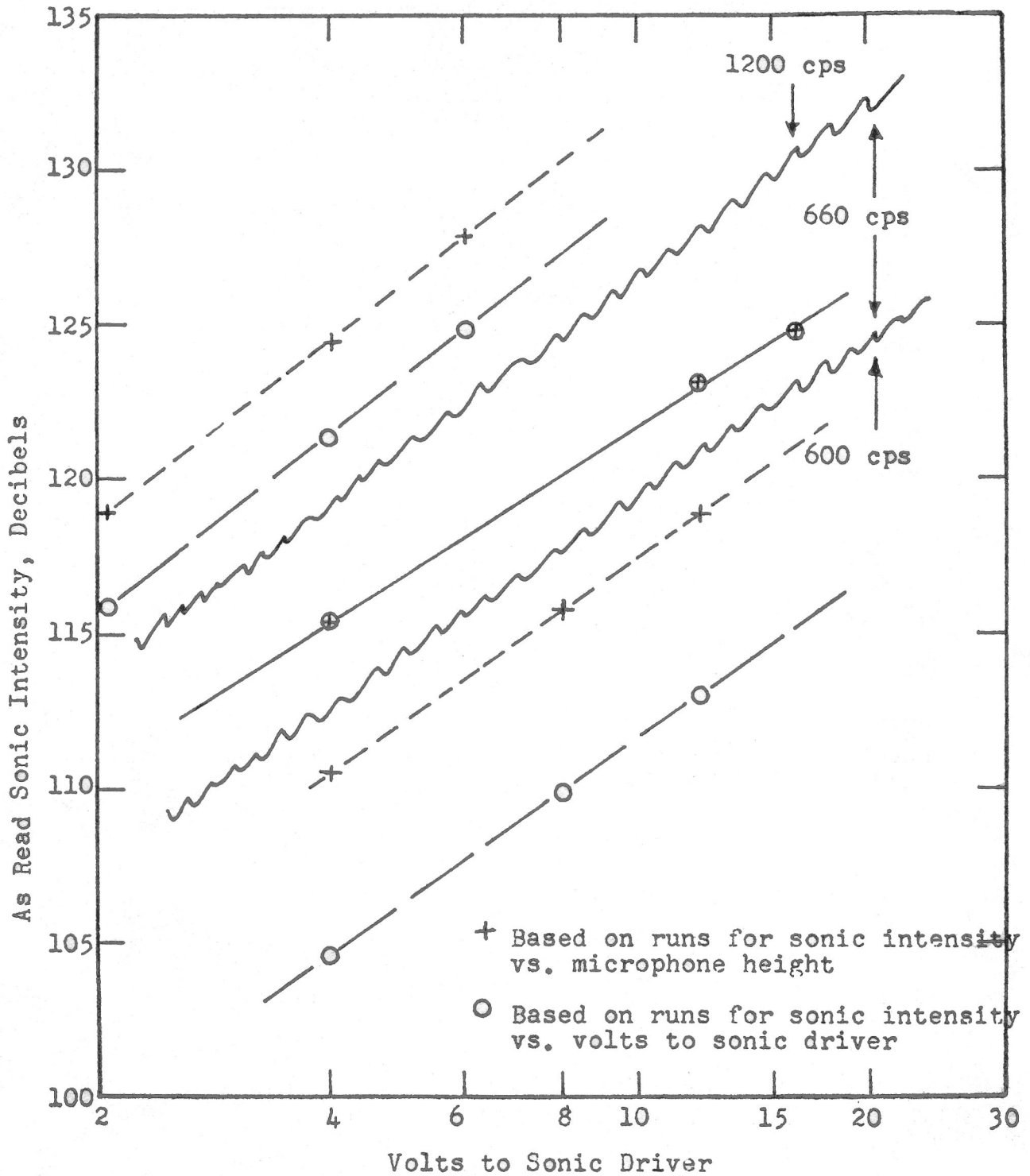

Figure 9

As Read Sonic Intensity vs. Volts to Sonic Driver  
 Equipment Setup A, Lapel Microphone

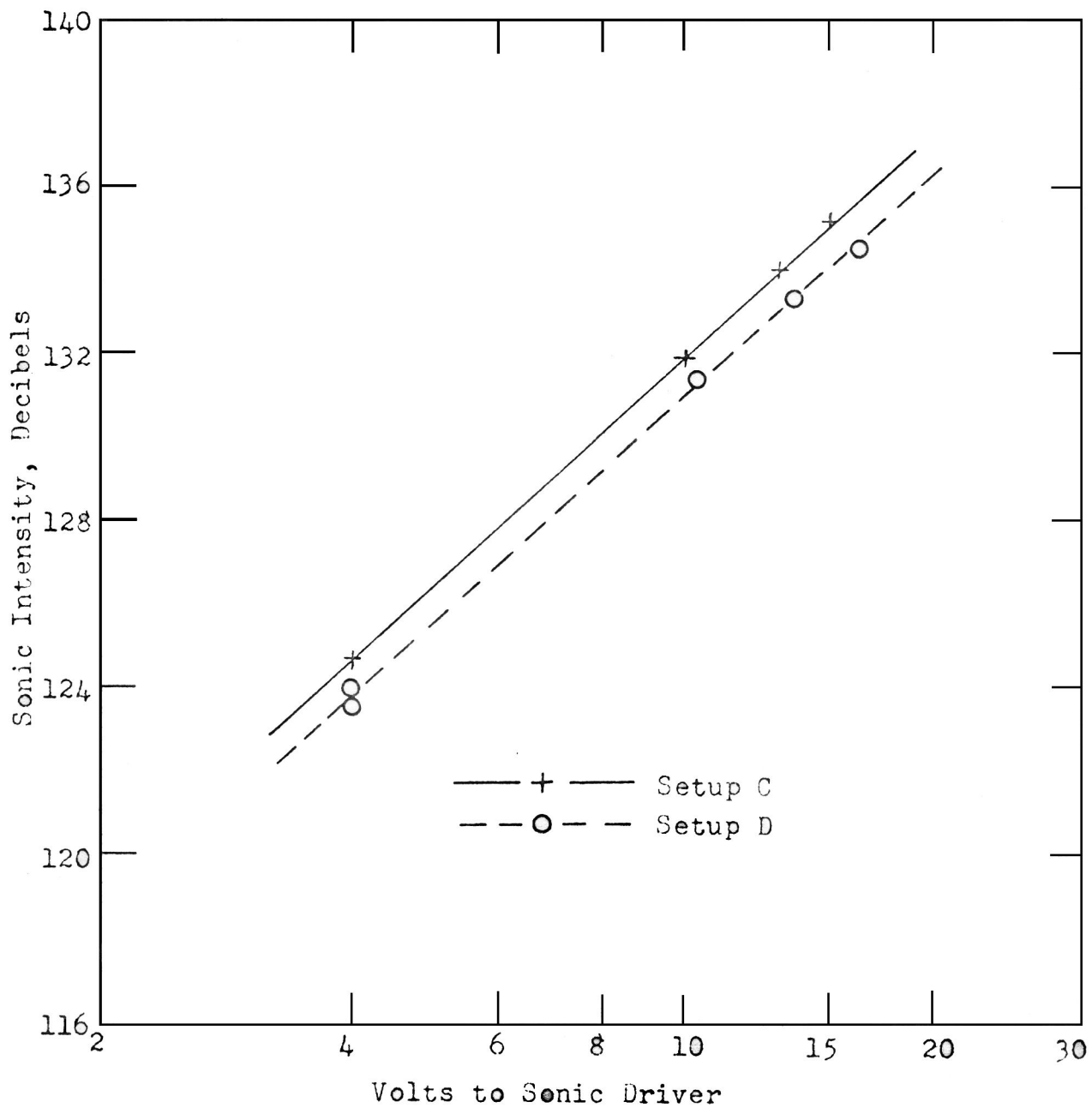

Figure 10

Sonic Intensity vs. Volts to Sonic Driver  
Equipment Setups C and D, 330 cps

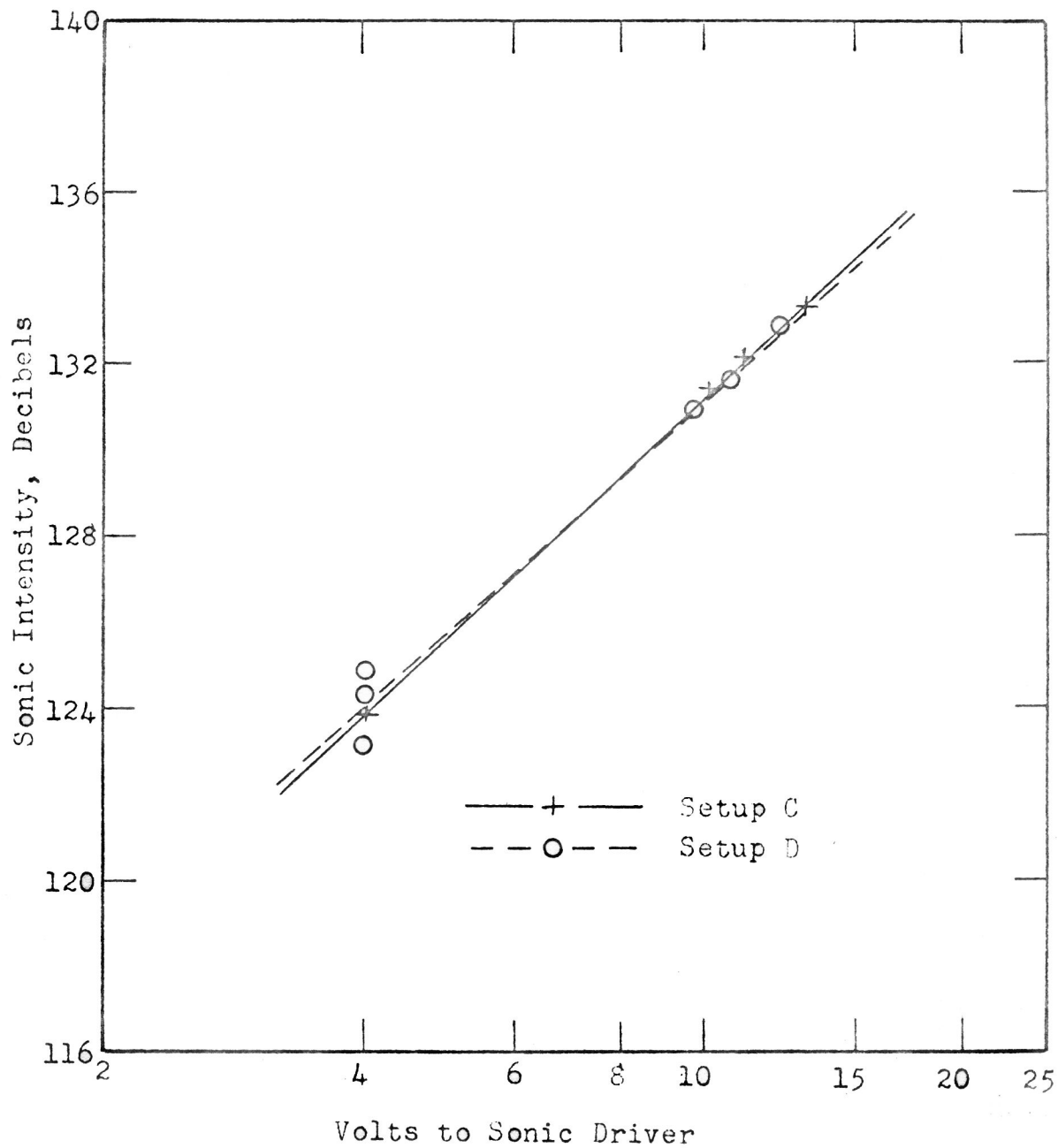

Figure 11

Sonic Intensity vs. Volts to Sonic Driver  
Equipment Setups C and D, 570 cps

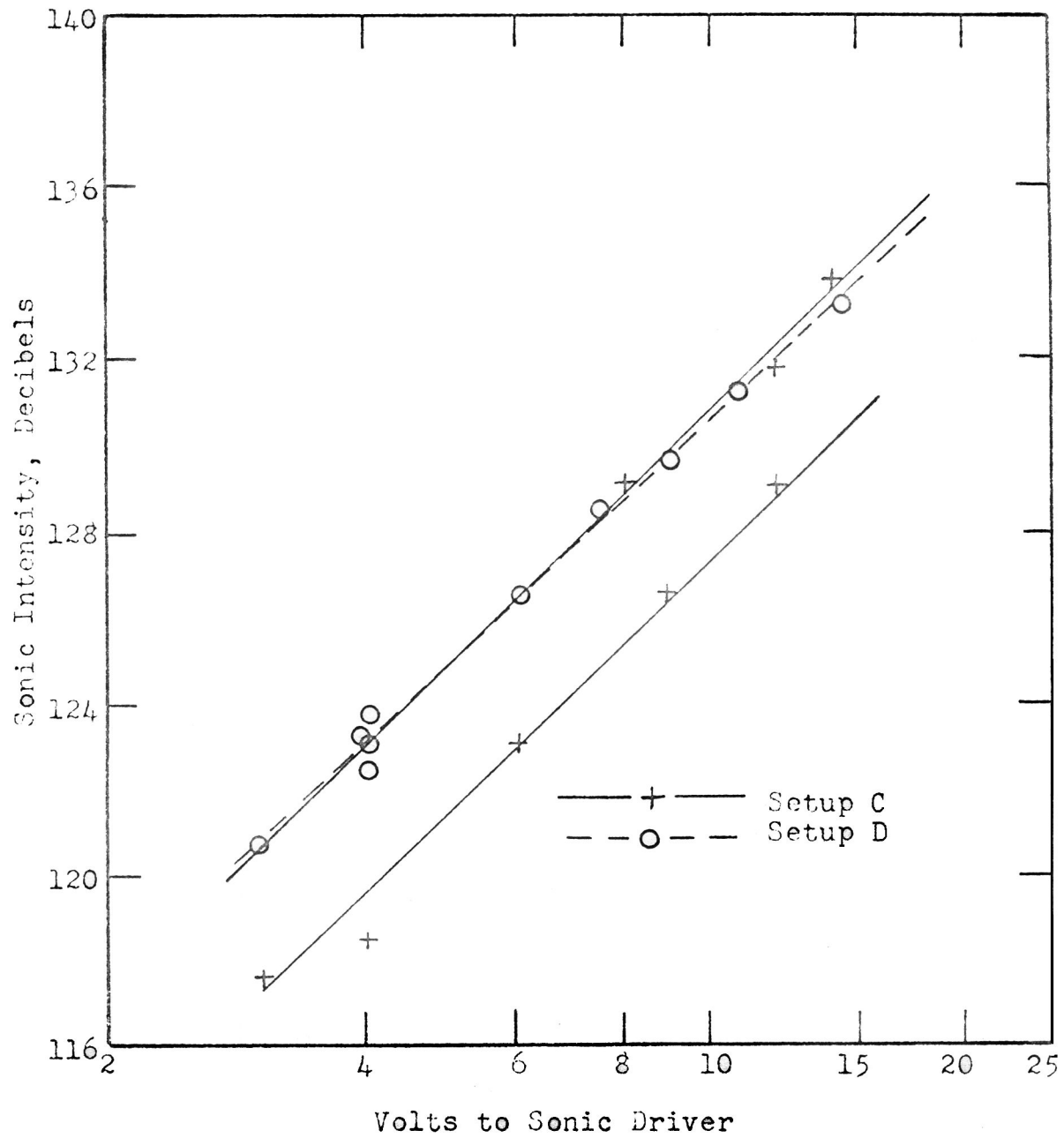

Figure 12

Sonic Intensity vs. Volts to Sonic Driver  
Equipment Setups C and D, 600 cps

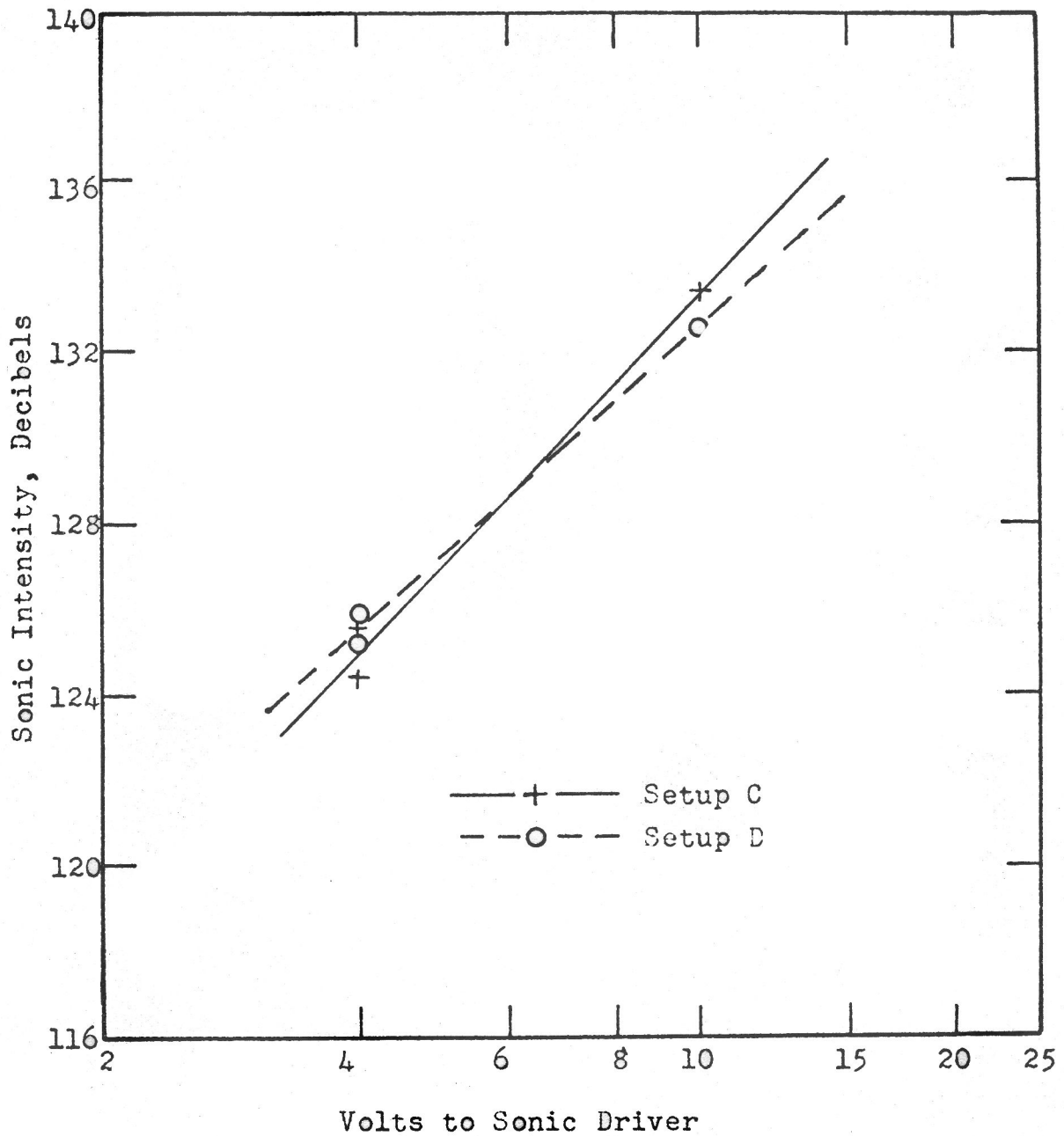

Figure 13

Sonic Intensity vs. Volts to Sonic Driver  
Equipment Setups C and D, 1380 cps

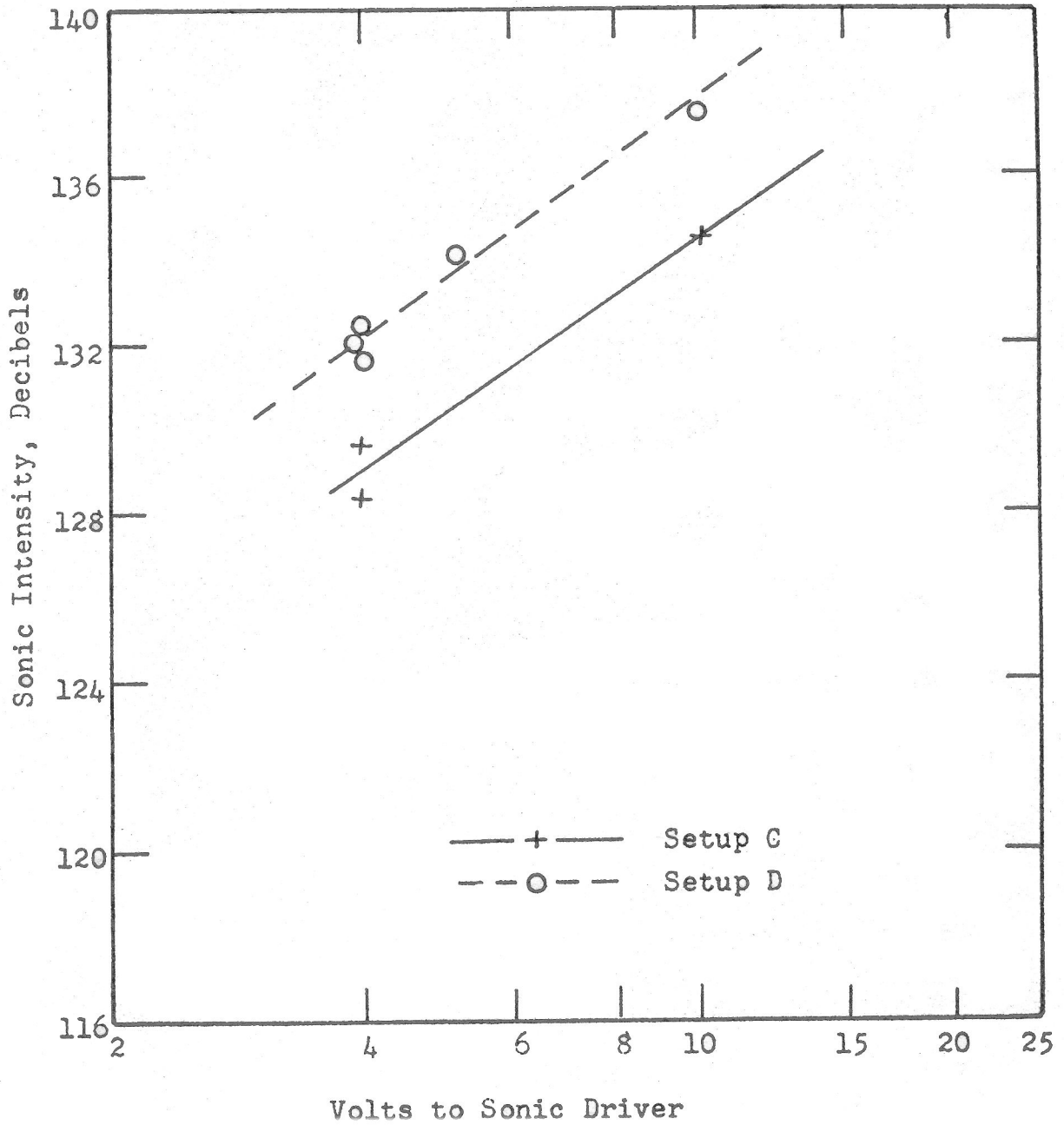

Figure 14

Sonic Intensity vs. Volts to Sonic Driver  
Equipment Setups C and D, 1440 cps

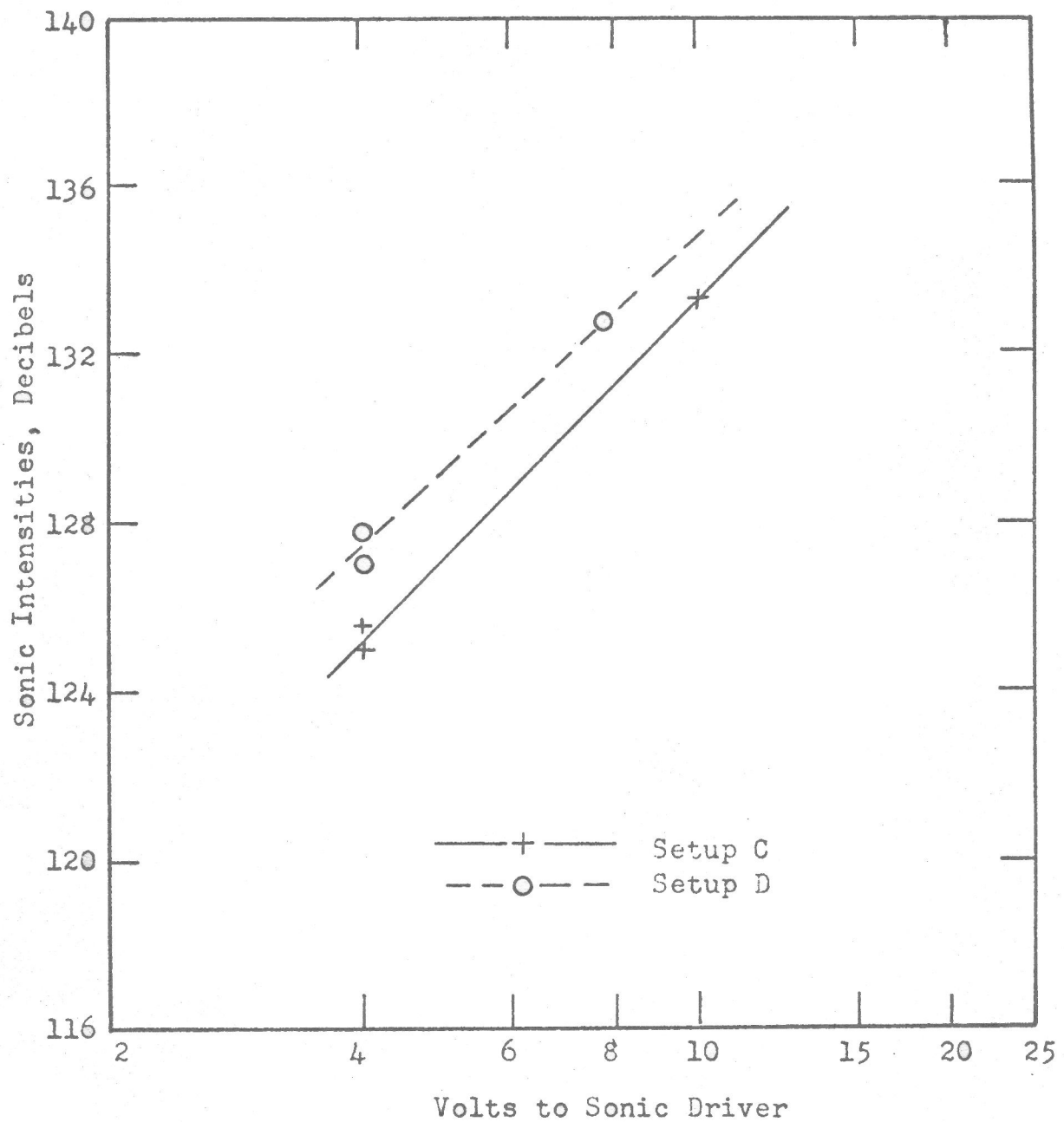

Figure 15

Sonic Intensity vs. Volts to Sonic Driver  
Equipment Setups C and D, 1320 cps



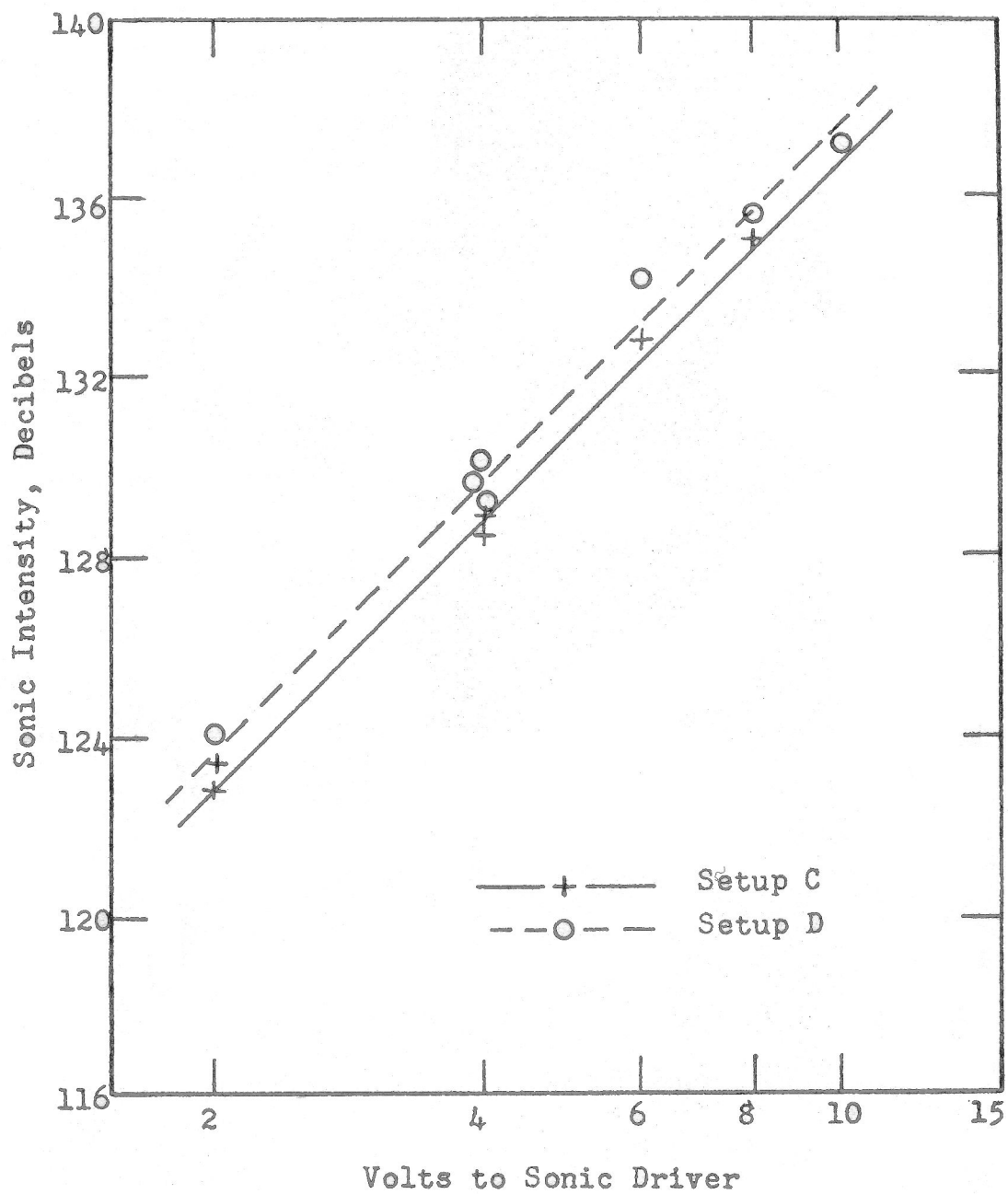

Figure 16

Sonic Intensity vs. Volts to Sonic Driver  
Equipment Setups C and D, 1500 cps

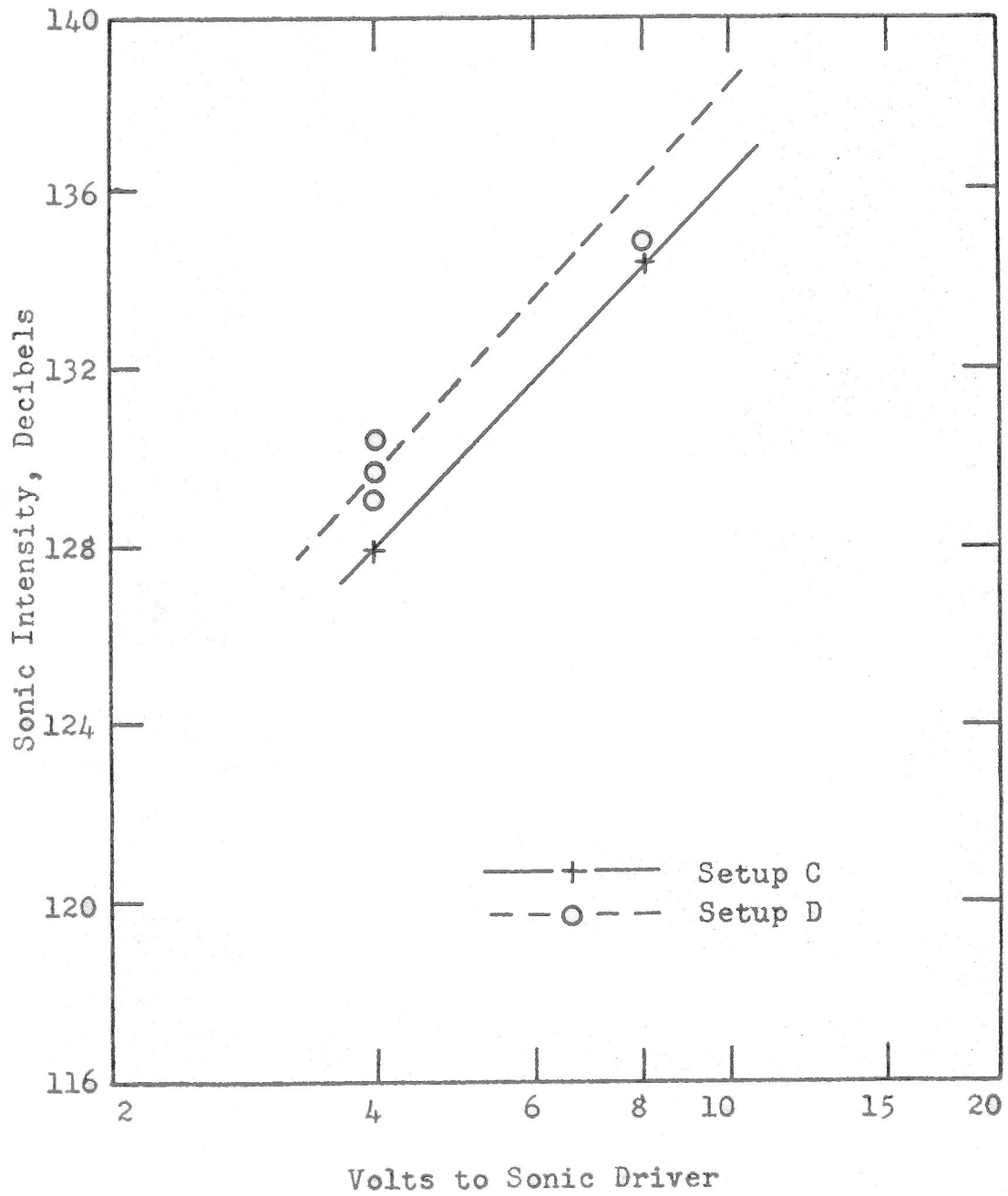

Figure 17

Sonic Intensity vs. Volts to Sonic Driver  
Equipment Setups C and D, 1680 cps

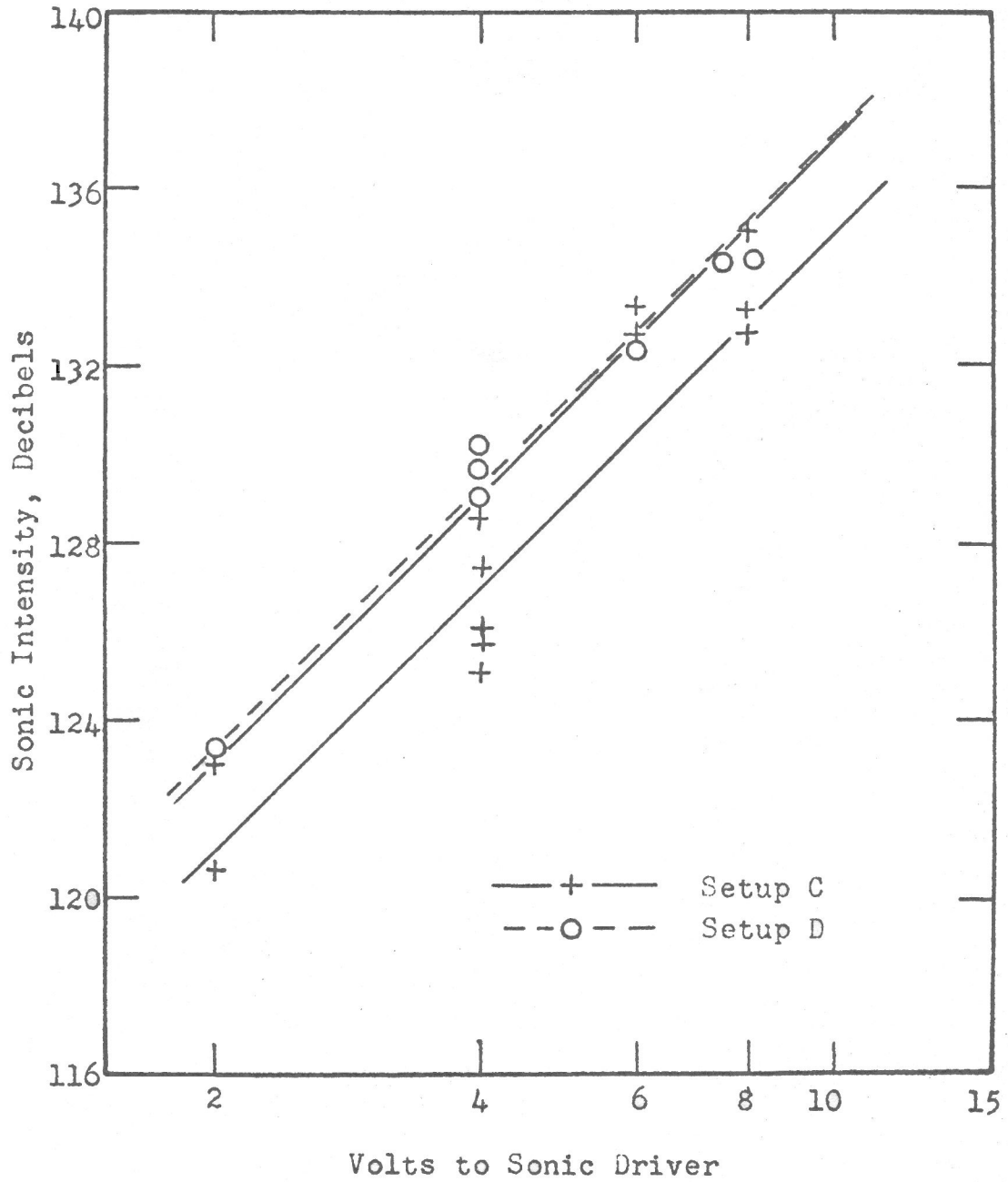

Figure 18

Sonic Intensity vs. Volts to Sonic Driver  
Equipment Setups C and D, 1800 cps

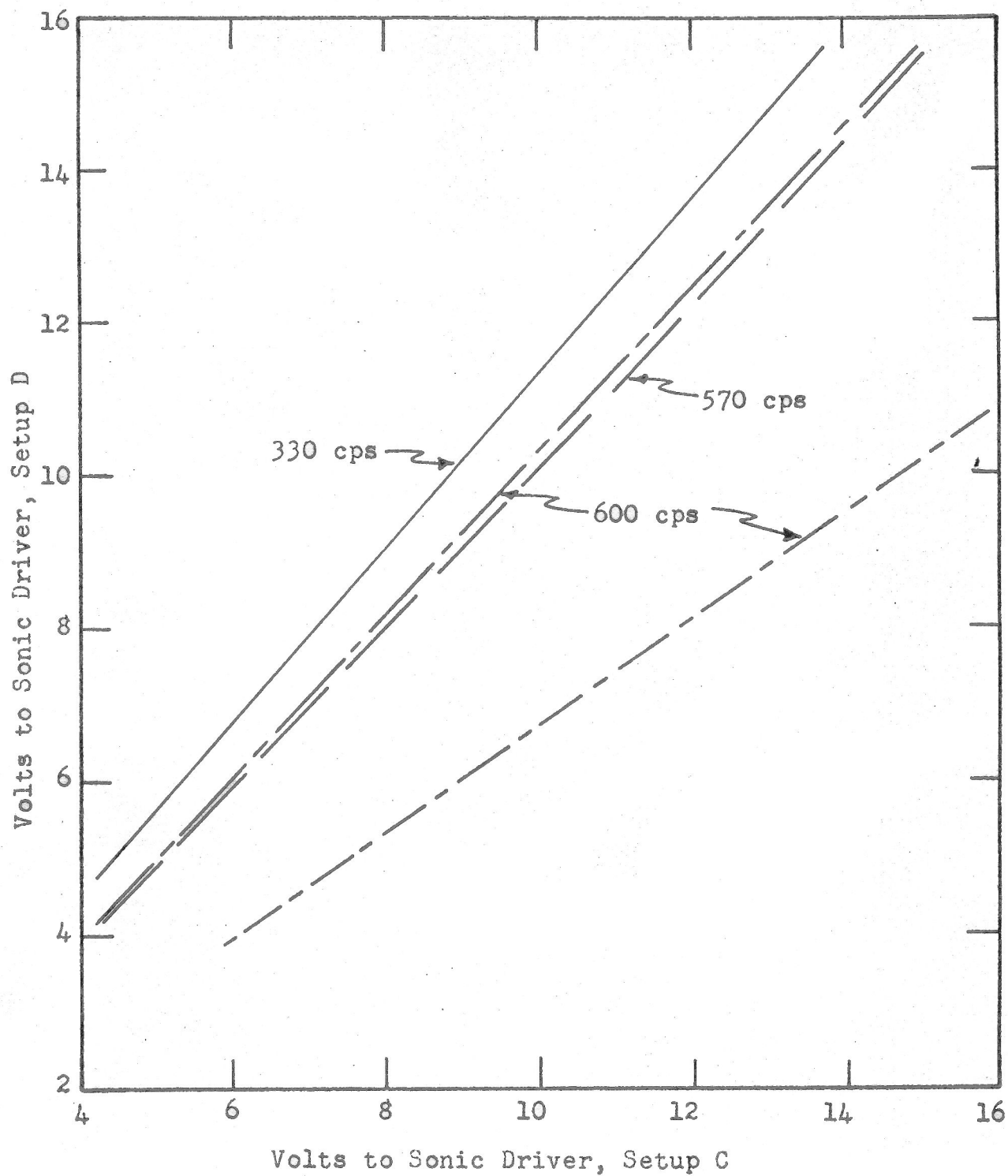

Figure 19

Volts to Sonic Driver at Constant Sonic Intensity  
Equipment Setup D vs. Equipment Setup C

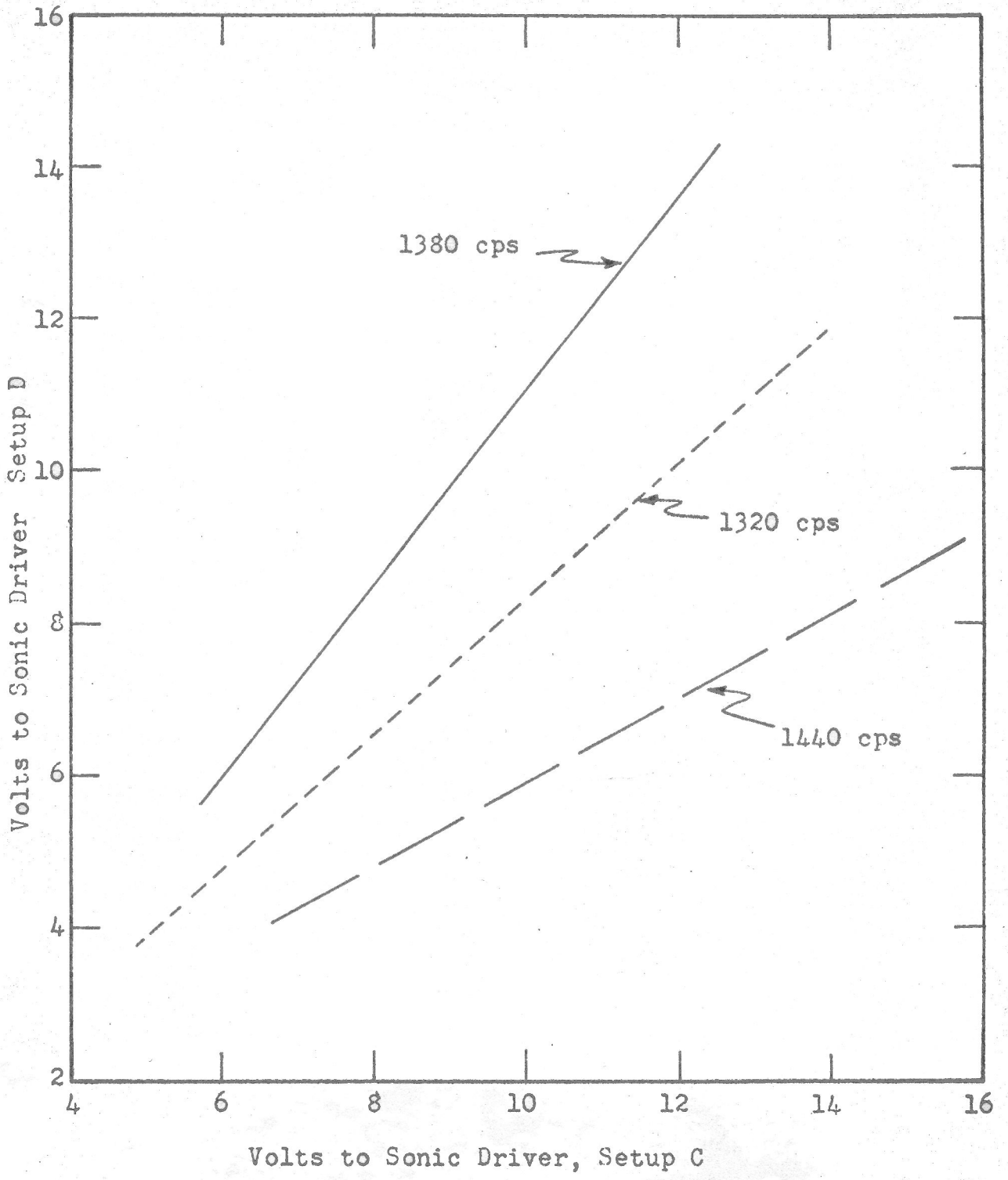

Figure 20

Volts to Sonic Driver at Constant Sonic Intensity  
Equipment Setup D vs. Equipment Setup C

If intensity values are not corrected they are referred to as the "as read" sonic intensities to distinguish them from the corrected or "absolute" sonic intensities.

Table 2 contains as read sonic intensity data for setup B of the experimental equipment. These data are plotted in Figures 5, 6, and 7 and were used to determine the difference (noted on the figures) between the as read sonic intensity values for the lapel and Shure 9898 microphones when the microphones were at the evaporative surface position and "absolute" sonic intensities were the same. These three figures were also used to determine interpolated values for the as read sonic intensities at the evaporative head position based on the lapel microphone determinations. Figure 21 explains the method of determining the vertical position or height of the microphones.

Table 3 presents data for setups A and B on the necessary voltages to the sonic driver for the same as read sonic intensities to be measured with the lapel microphone positioned at the evaporative surface location.

Figure 8 is a plot of as read sonic intensity versus voltage to the sonic driver for setup B. The as read sonic intensities are the values observed with the lapel microphone at the location of the evaporative surface. These values were based on the data presented in Tables 2 and 3. Two of the three frequencies used, 600 and 1200 cps, resulted in different relationships between sonic intensity and voltage because of the failure of the data in the Tables 2 and 3 to reproduce each other.

Figure 9 is a plot of as read sonic intensity versus voltage to the sonic driver when setup A was used. The as read sonic intensity values were determined from the lines plotted on Figure 8 at the various sonic driver voltages used with setup B given in Table 3. These intensities were then plotted against the corresponding voltages for setup A, Table 3, which had the same as read sonic intensities.

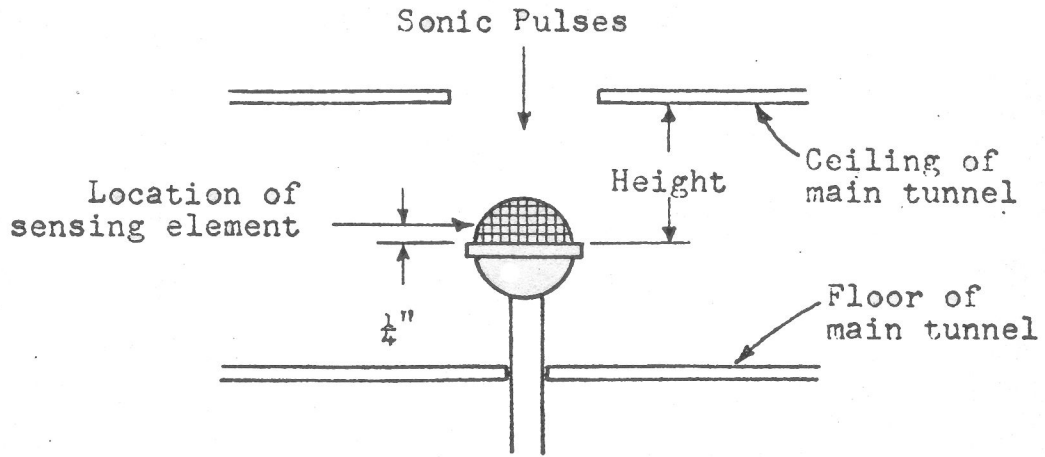

Shure 9898 Microphone

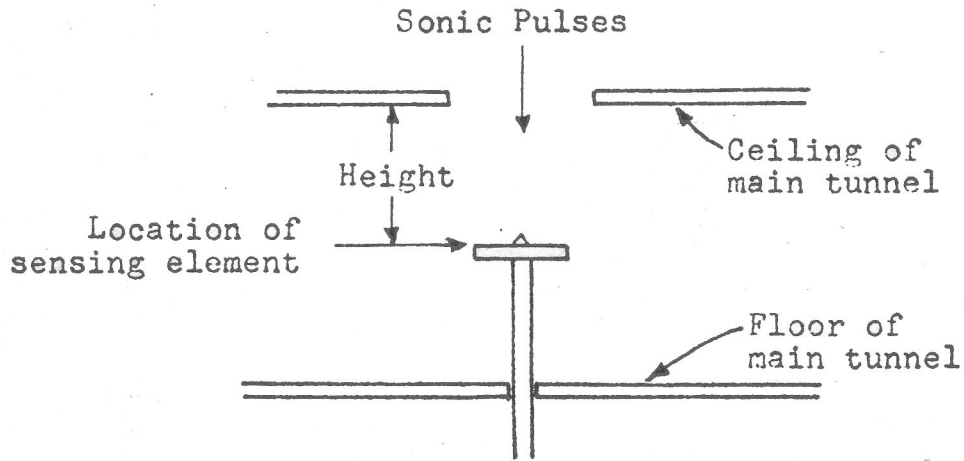

Lapel Microphone

Figure 21

Measurement of Microphone Height

Thus the relationships between as read sonic intensity with the lapel microphone and voltage to the sonic driver are given in Figures 8 and 9 for setups A and B, respectively. These figures were used in determining sonic intensities for evaporation runs with setups A and B. The approximate average of the two possible values were used for frequencies of 600 and 1200 cps.

The as read intensity values in Figures 8 and 9 required adjustment for two factors to put them on an absolute sonic intensity basis. One adjustment was for the difference between the as read db values using the lapel microphone and the db values given by the Shure 9898 microphone. These adjustments are indicated on Figures 5, 6, and 7. The other adjustment was for the use of the extension cable with the Shure 9898 microphone so that its as read sonic intensities could be placed on an absolute sonic intensity basis. This adjustment could be only approximate as the extension cable used was not the proper one and subsequent inspection of the sound level meter indicated the meter was not operating properly during this period. Values of 8 to 10 db were estimated from available data to allow for faulty operation and the use of the extension cable; an "average" of 9 db was used.

The absolute sonic intensity values given in subsequent tables and figures for setups A and B were obtained by making the adjustments indicated above to intensity values from Figures 8 and 9.

Table 4 presents the as read sonic intensity data used to determine sonic intensities when using setups C and D of the equipment. As read sonic intensities from Table 4 were adjusted for use of the extension cable using manufacturer's data (18) and were then plotted in Figures 10 through 18. In some cases the data was limited and the parallel line relationship often obtained both in this work and in the work of Nichols (4) was used in drawing lines through the data. In several cases it was necessary to use more than one



line to represent the intensity-voltage relationship because of poor reproducibility of the data. Figures 19 and 20 are plots of the voltages required in setups C and D to produce the same sonic intensities at the evaporative surface. These plots were constructed using the lines drawn in Figures 10 through 15.

The sonic intensities in subsequent tables and figures for setups C and D were obtained from the plots in Figures 10 through 18. A range of intensity values was used in some cases because of the poor reproducibility of the data.

Some other miscellaneous testing indicated the sonic intensity to be sensitive to frequency changes at constant voltage to the sonic driver. This result was also obtained by Nichols, pp. 10 and 11.

#### Smoke Observations

The observations of disturbances in smoke patterns, i.e., streaming, caused by the application of sonic pulses are given in Tables 5, 6, and 7 and Figure 22. In addition to these results a number of other observations were also made for various experimental setups and operating conditions.

Tables 5 and 6 present streaming observations made using equipment setups A and B, respectively. These data were obtained by injection of titanium tetrachloride smoke into the main tunnel upstream of the evaporative head. Air was flowing through the tunnel and the evaporative head was in position when these data were taken. Figure 22 shows the sweeping action of high air flow on the streaming caused by application of sonic pulses for setup A. It was observed that when the application of sonic pulses resulted in strong streaming in the center region of the main tunnel where the evaporative

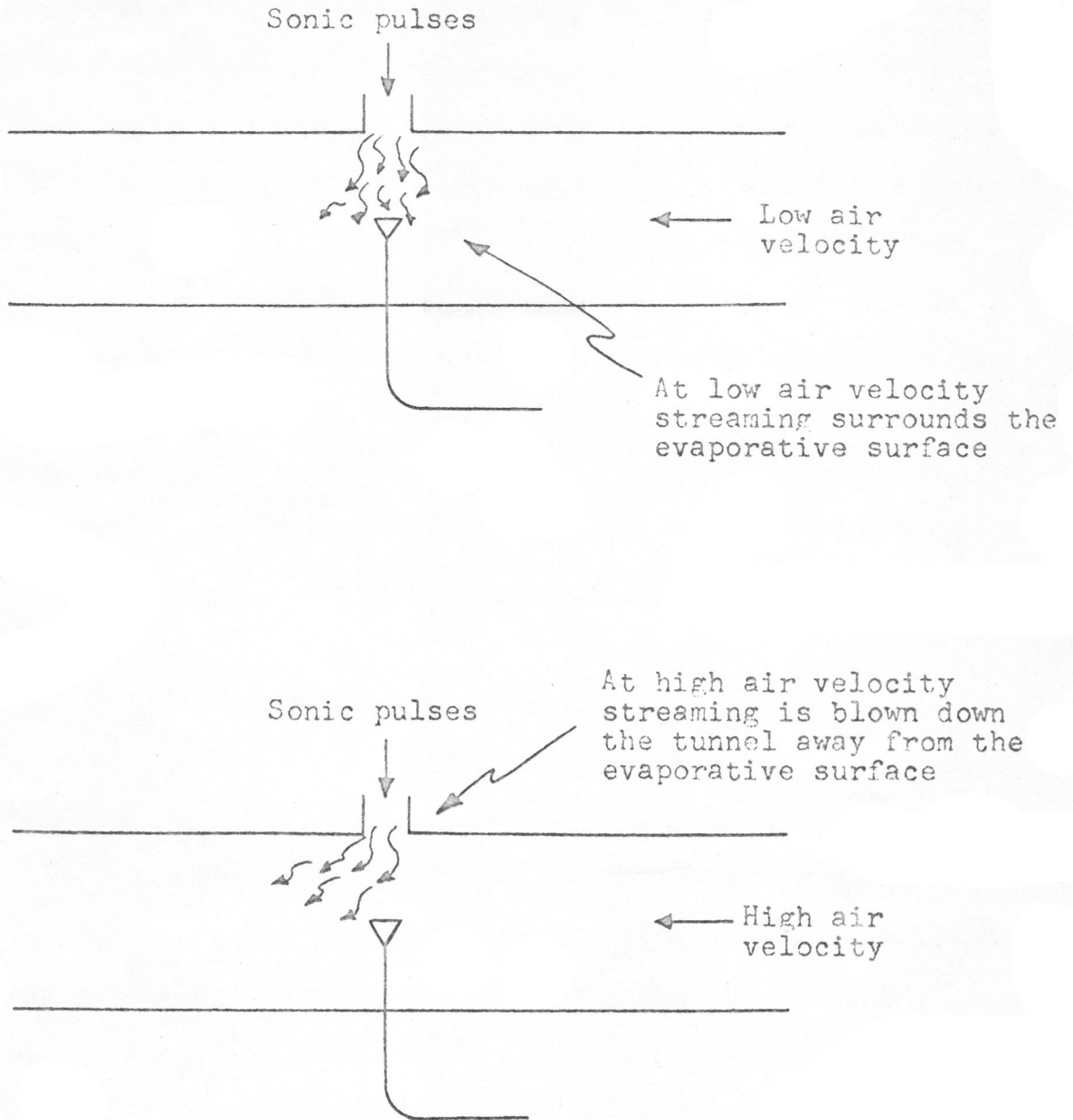

Figure 22

Effect of Forced Air Flow on Streaming

surface was located, the streaming generally took the form of a jet of air directed down toward the evaporative surface.

Table 7 contains streaming observations for equipment setups C and D. For these data tobacco smoke was injected into the vertical tunnel. There was no air flow through the main tunnel and the evaporative head was not used when these data were obtained. The appearance of streaming in the vertical beam of light was often similar to a jet of air directed downward when the streaming was very strong. However, this similarity in appearance was not as pronounced as described above for setup A.

#### Rates of Evaporation

Data and results on rates of evaporation are given in Tables 8 and 9 and in Figures 23 through 33. Table 8 contains data and results obtained on rates of evaporation when using equipment setups N, A, and B. These results are plotted in Figures 23 through 27. Figure 27 also contains some results from Table 9. Data and results on rates of evaporation for equipment setups C and D are given in Table 9 and in Figures 27 through 33.

The sonic intensity values given in these tables and figures were obtained from plots of the data on sonic intensities referred to in the above discussion on sonic intensities. All the sonic intensity values used in the tables and figures on rates of evaporation are the best estimates of the absolute intensities (as opposed to the as-read values). In some cases the poor reproducibility of the data has prompted the use of a range of values for the sonic intensity.

All plots of evaporation data versus sonic intensity use average values for evaporation rates. The data in Tables 8 and 9 are in groups of nine or

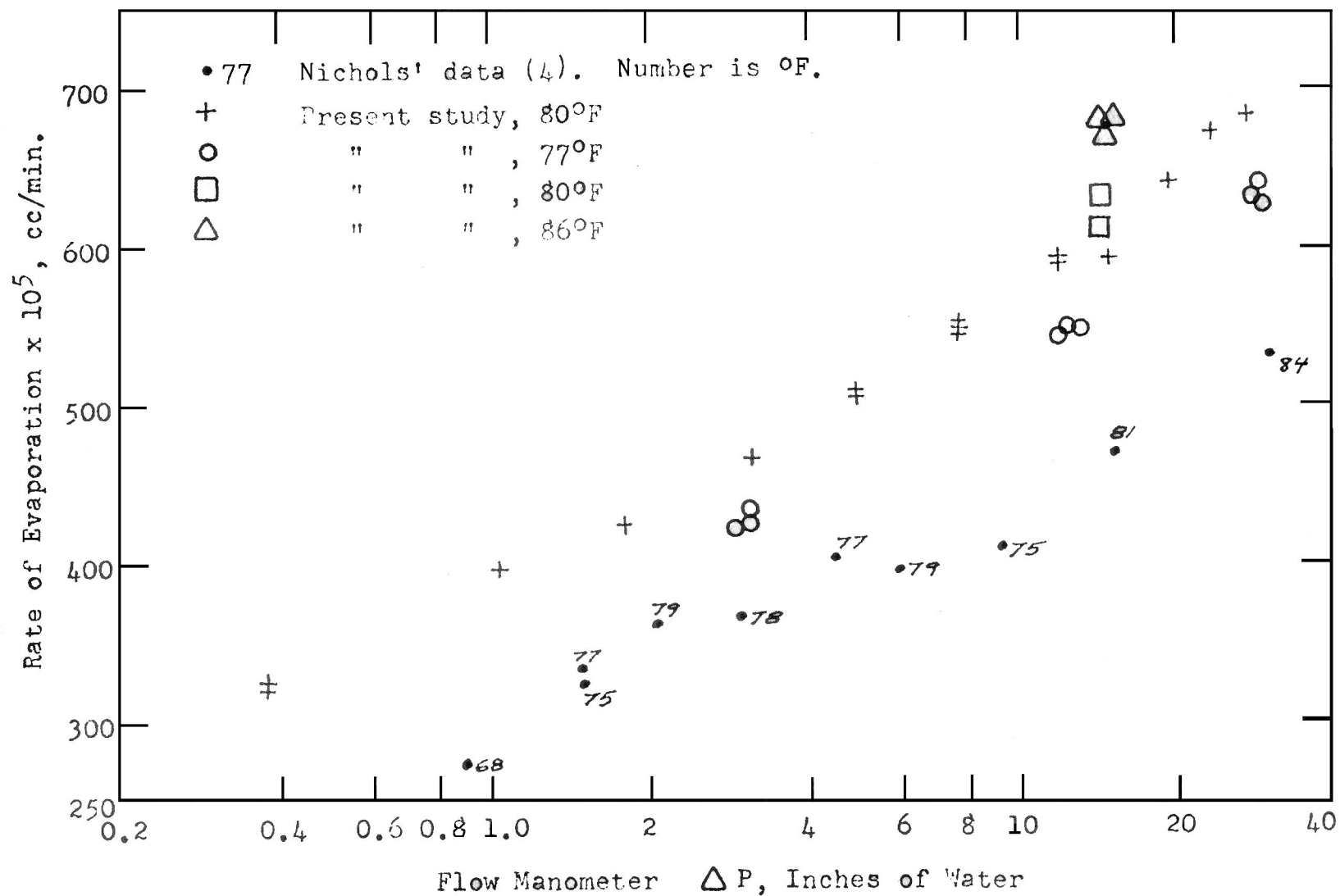

Figure 23

Rates of Evaporation Without Sound  
Equipment Setup N

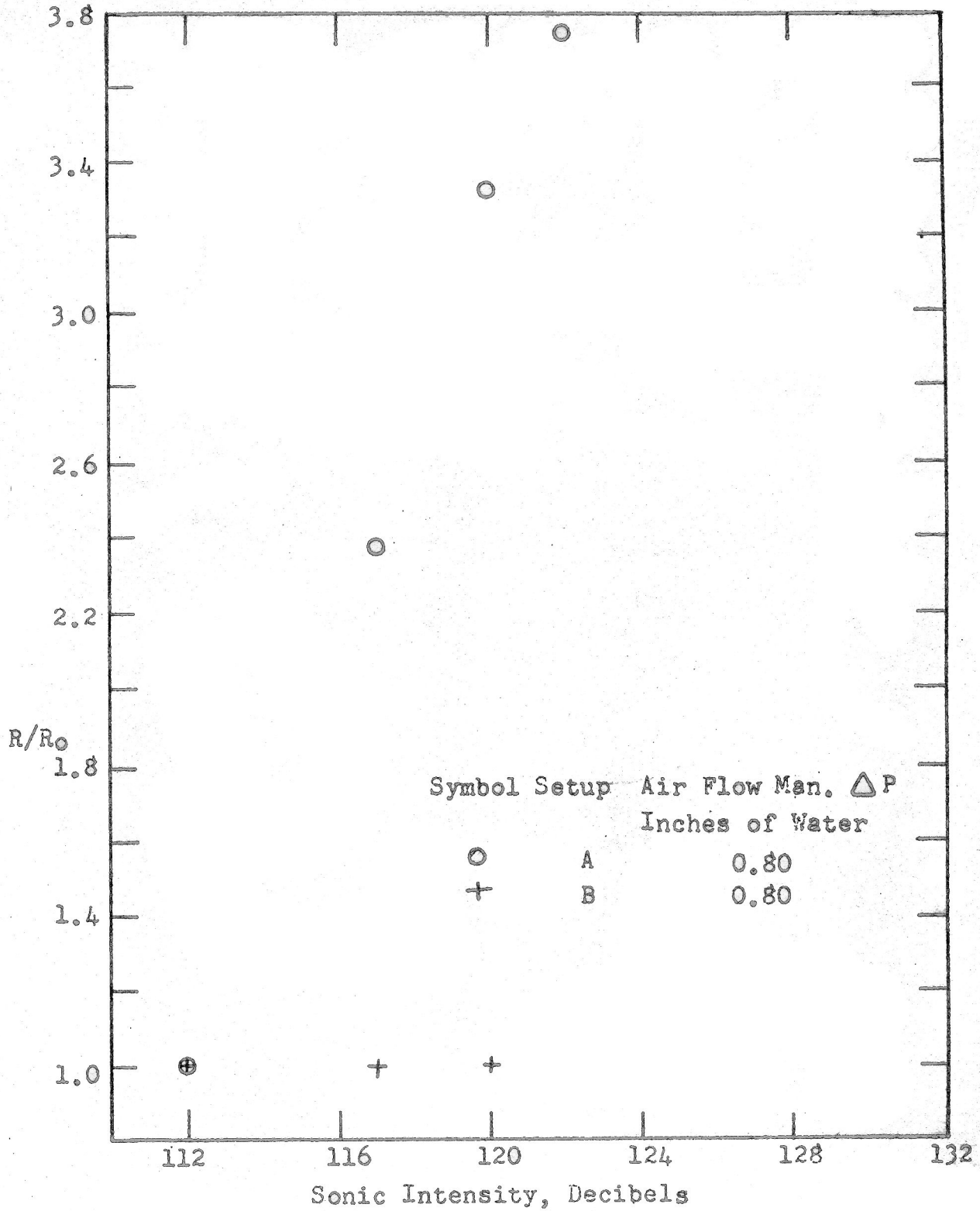

Figure 24

R/R<sub>0</sub> vs. Sonic Intensity  
Equipment Setups A and B, 600 cps

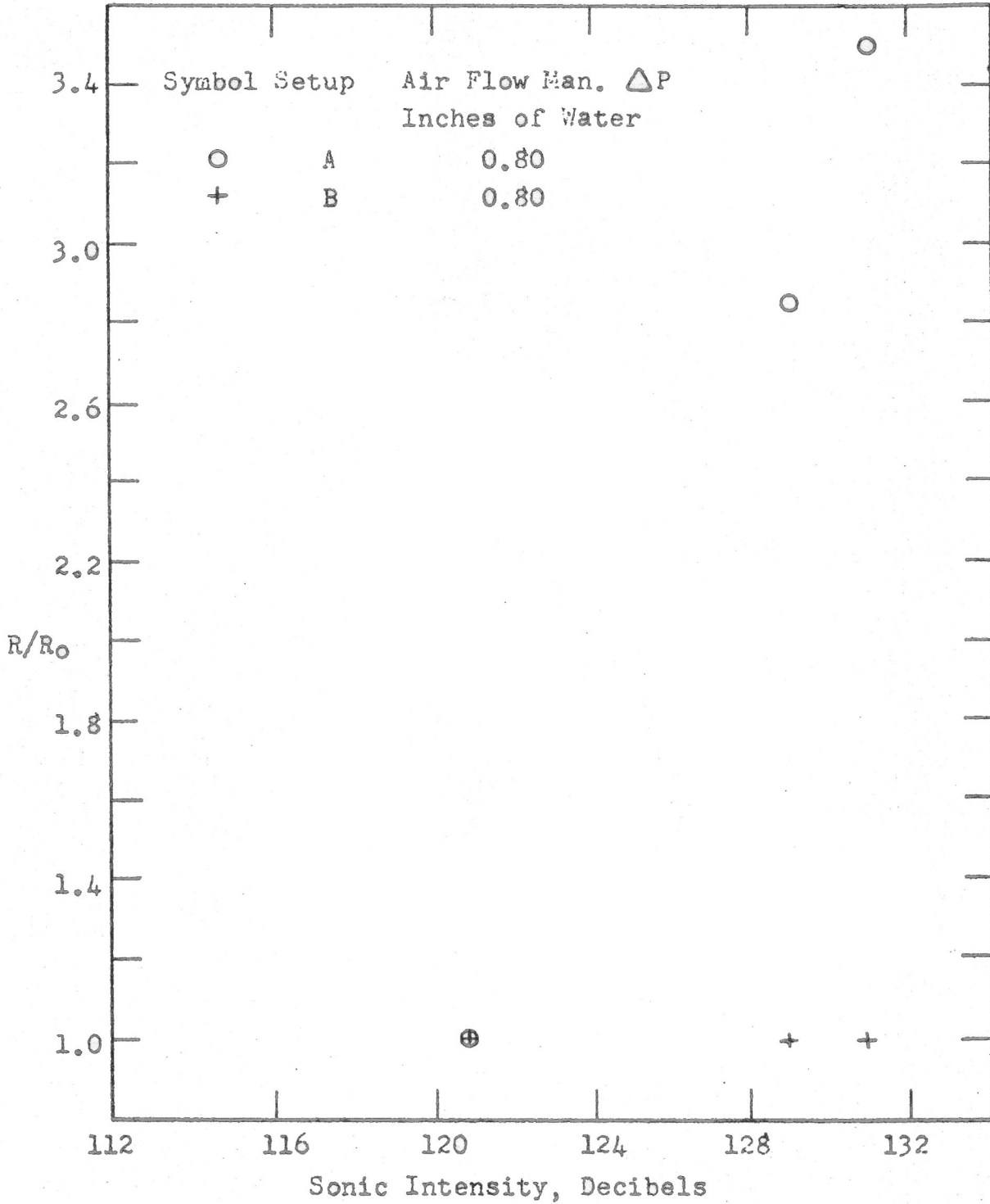

Figure 25

$R/R_0$  vs. Sonic Intensity  
 Equipment Setups A and B, 660 cps

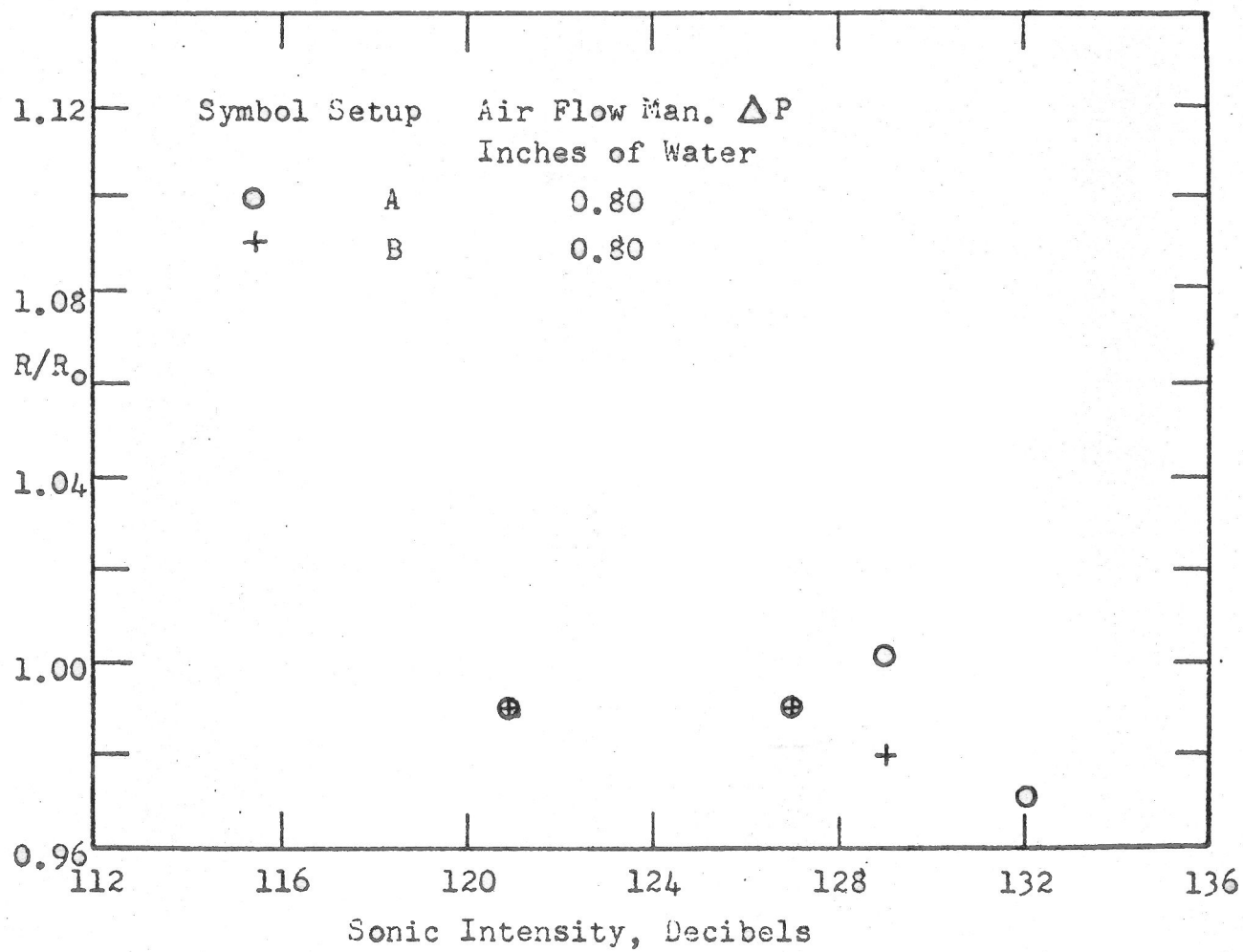

Figure 26

$R/R_0$  vs. Sonic Intensity  
Equipment Setups A and B, 1200 cps

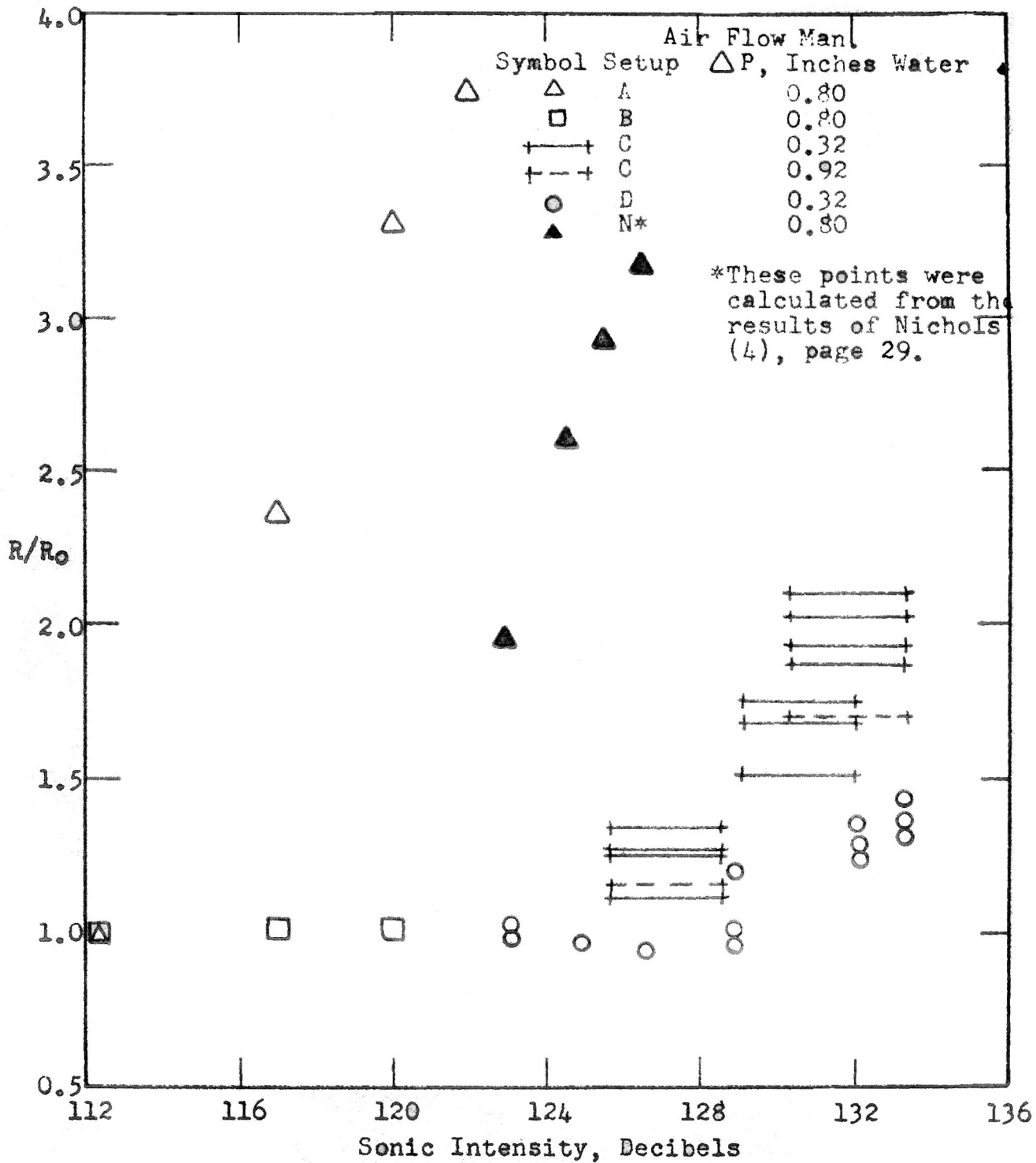

Figure 27

R/R<sub>0</sub> vs. Sonic Intensity  
 Equipment Setups A, B, C, D and Nichols' Results, 600 cps



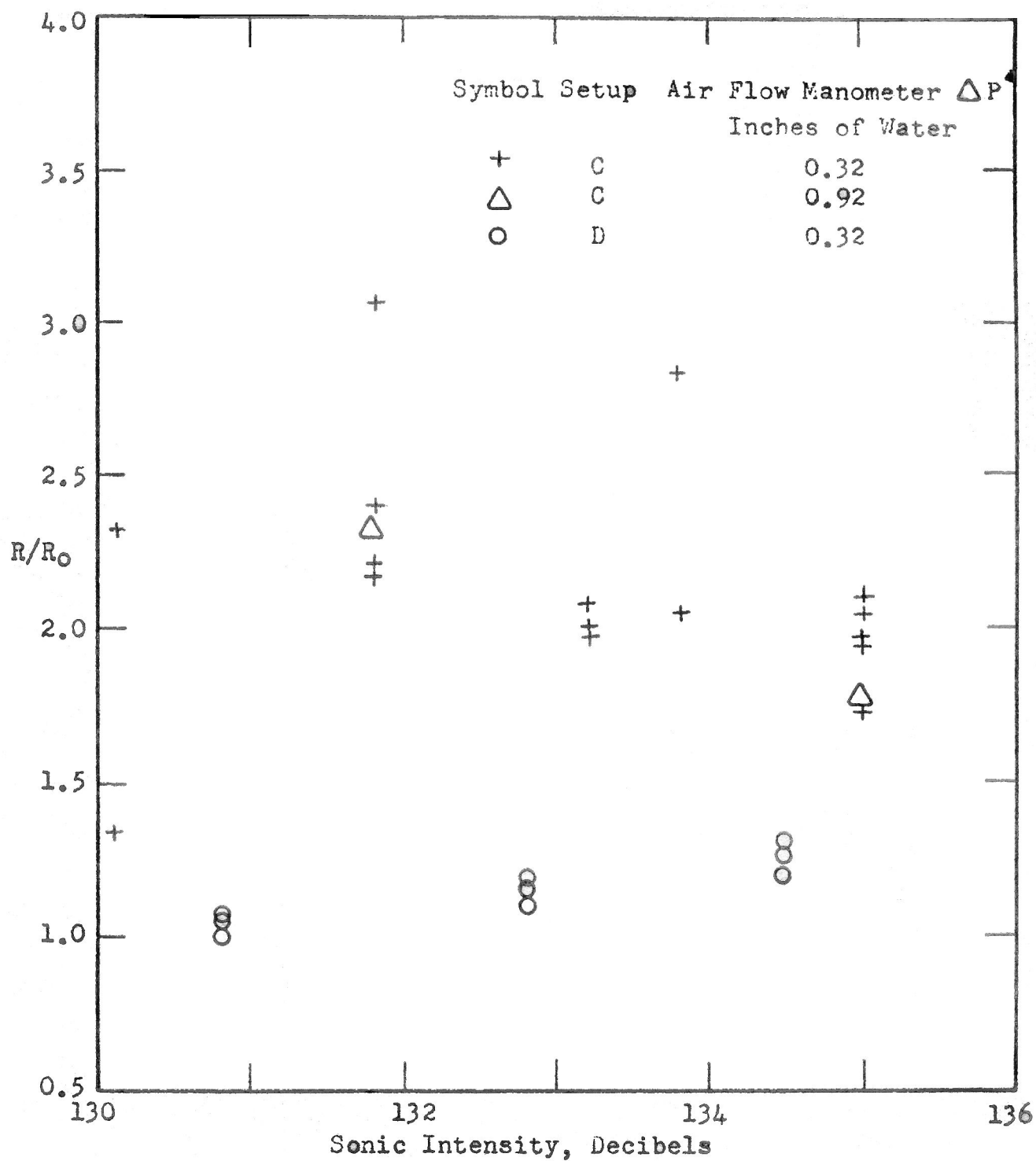

Figure 28

$R/R_0$  vs. Sonic Intensity  
Equipment Setups C and D, 330 cps

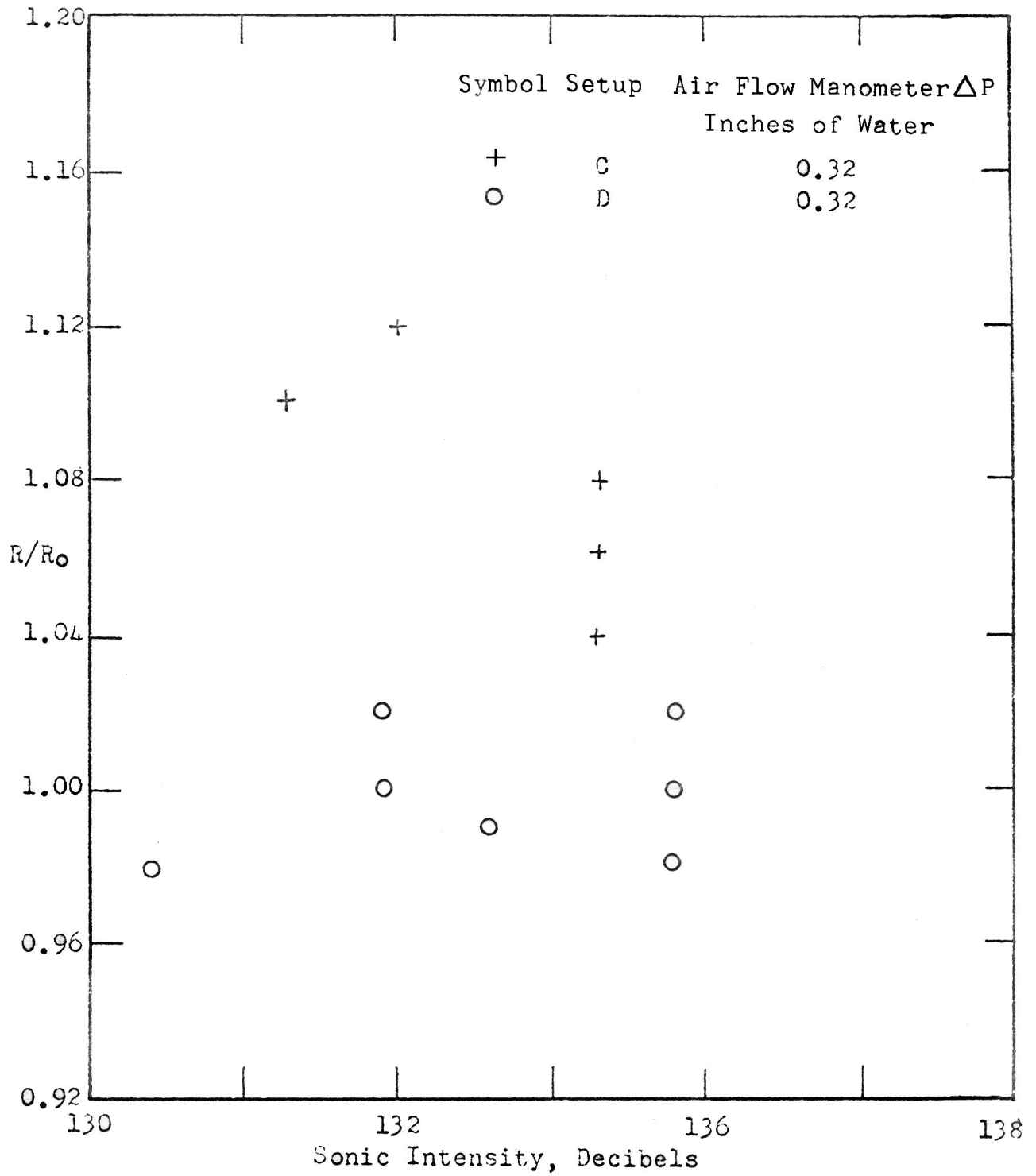

Figure 29

R/R<sub>0</sub> vs. Sonic Intensity  
Equipment Setups C and D, 570 cps

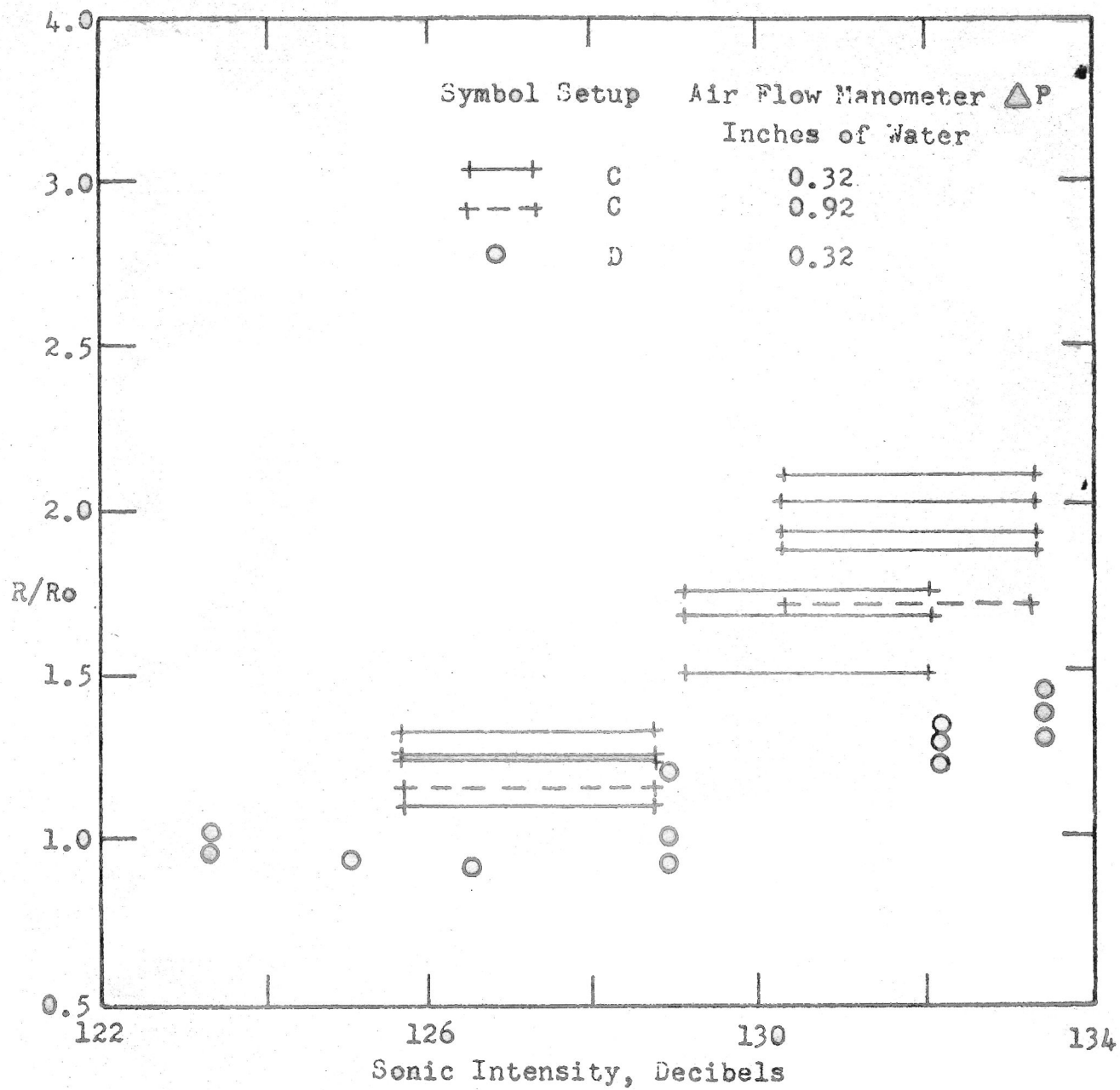

Figure 30

R/Ro vs. Sonic Intensity  
Equipment Setups C and D, 600 cps

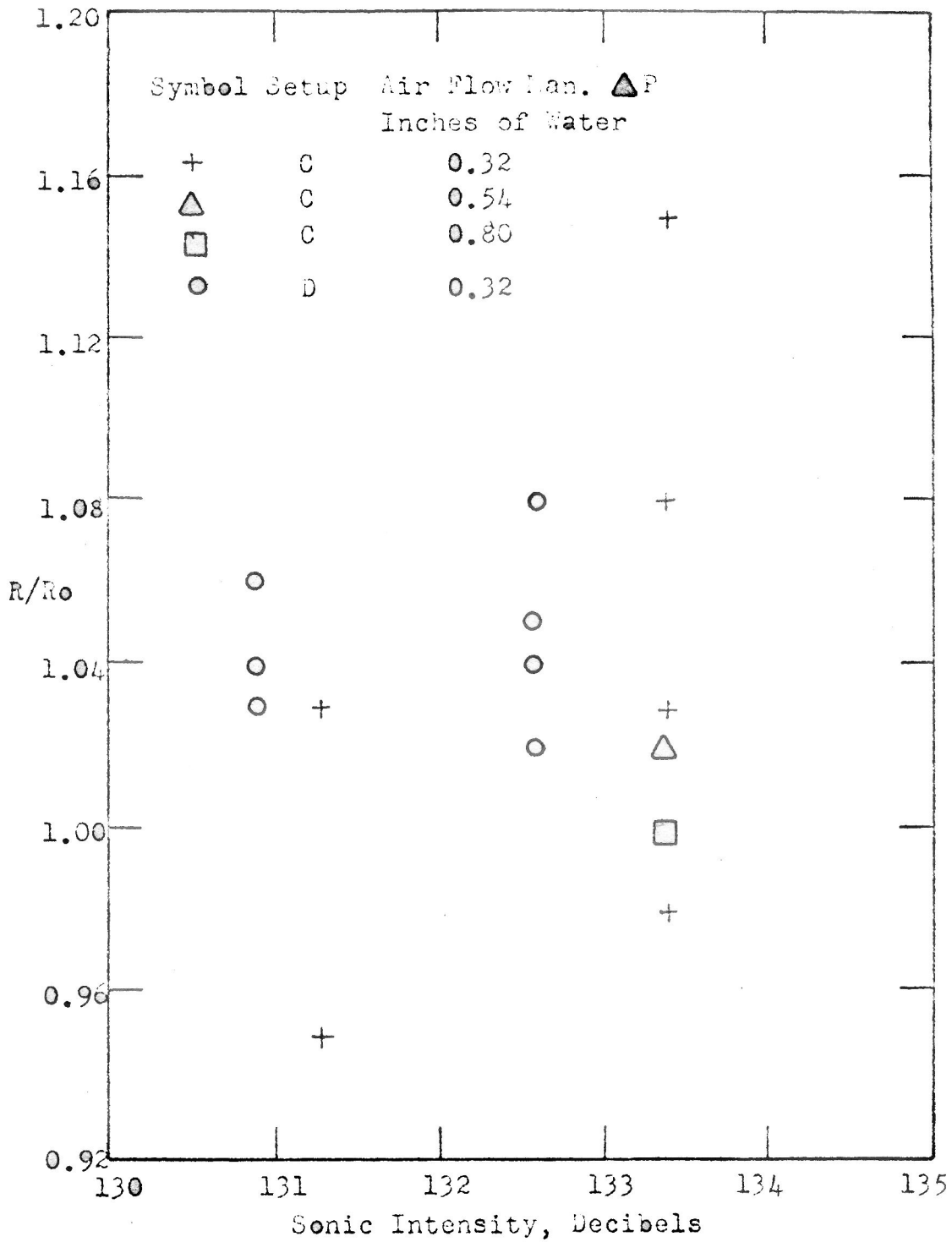

Figure 31

R/Ro vs. Sonic Intensity  
 Equipment Setups C and D, 1380 cps

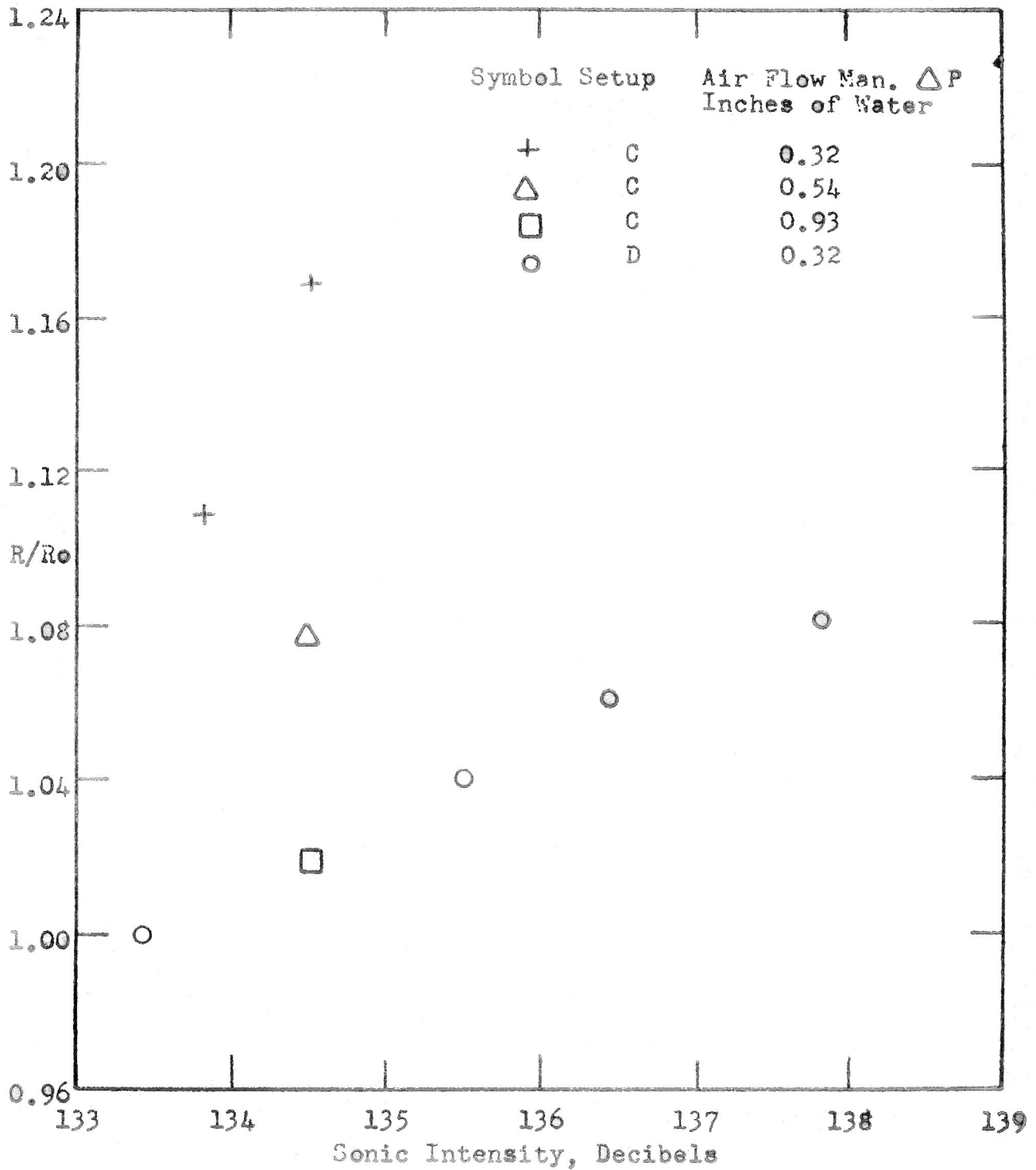

Figure 32

R/Ro vs. Sonic Intensity  
Equipment Setups C and D, 1440 cps

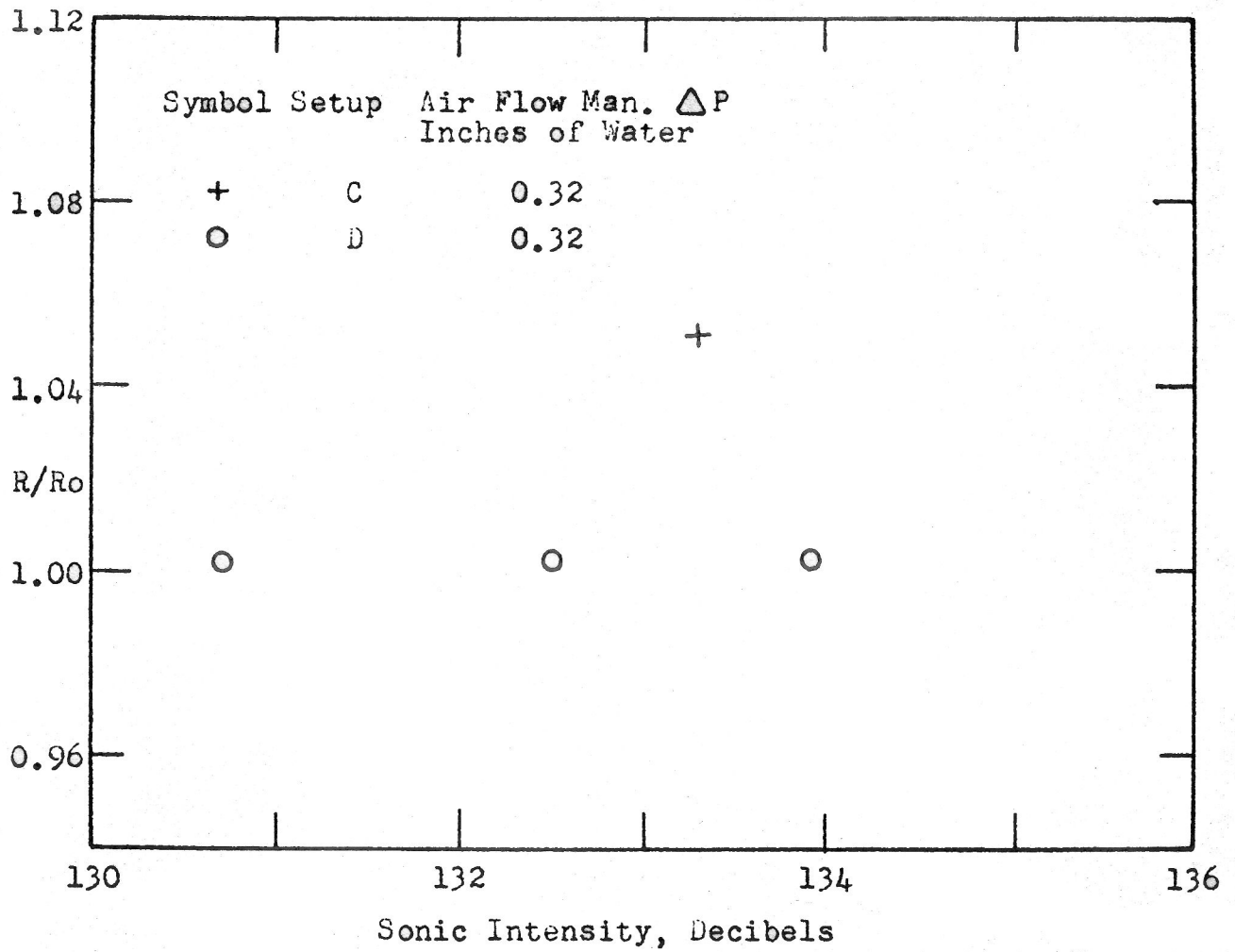

Figure 33

R/Ro vs. Sonic Intensity  
Equipment Setups C and D, 1320 cps

less runs where sonic pulses were applied during some of the runs. The rates without sonic pulses were averaged within each group and this average value,  $R_0$ , divided into each evaporation rate within the same group of runs. This resulted in values,  $R/R_0$ , expressing evaporation rate relative to the average rate without sound. The  $R/R_0$  values were averaged within each group for all runs at the same frequency and voltage to the sonic driver; these are the average values used in the plots. Note that some of the  $R/R_0$  values in Tables 8 and 9 are for runs when no sound was used.

#### Miscellaneous

The calibration curve of the flow meter used to determine air flow through the main tunnel was checked. No change in the calibration was observed.

Early efforts were directed toward the use of a hot wire anemometer to characterize the effect of the application of the sonic pulses. Results indicated that it was possible to use the anemometer to detect both the sonic pulses and the streaming observed by smoke observations. However, time limitations became critical and it was not possible to continue this work to a satisfactory conclusion permitting the use of hot wire anemometer observations to describe streaming.

#### DISCUSSION

The discussion of the results of this work considers first the sonic intensity data and second the smoke observations and the evaporation runs.

Data on the latter two items are interrelated and therefore lend themselves to simultaneous consideration.

### Sonic Intensities

The data on sonic intensities generally appeared to approximate the series of parallel straight line plots as was obtained by Nichols (4) in plotting sonic intensity vs. the log of the voltage to the sonic driver. The principal difficulty in the use of these data was the failure of the data to always yield reproducible plots.

The intensity data in Tables 2 and 3 were used to determine sonic intensities for equipment setups A and B. As previously discussed these data could not be expected to accurately indicate absolute values for the intensities because of equipmental difficulties. Therefore, the averages of the indicated range of values were used in describing the sonic intensities for the evaporation runs while the range of these estimated sonic intensities may be as great as 3 db.

The difficulties with the sonic intensity equipment were corrected before obtaining the sonic intensity data, Table 4, for equipment setups C and D. These data are thus expected to give more accurate representation of the true sonic intensities. Where the reproducibility of the data was poor, ranges of intensity values have been used to describe sonic intensities for the evaporation runs using equipment setups C and D.

Two possible factors contributing to the poor reproducibility of the data on sonic intensities may be indicated by the dependence of measured intensity values on the frequency and the location of the point whose intensity is being determined. As frequency was varied at constant volts to the sonic driver



the intensity varied through a series of maximum and minimum values probably resulting from various conditions of resonance. Sonic intensity was also found to vary with microphone position. It also seems likely that variations in the positioning of the sonic driver might also affect intensity measurements. Thus if the frequency and equipment setup were not exactly identical each time sonic intensities were determined, and this undoubtedly was the case, the sonic intensities would be expected to exhibit a lack of reproducibility.

#### Smoke Observations and Rates of Evaporation

The results of preliminary runs to determine rates of evaporation are given in Figure 23; these data were taken using equipment setup N and without the use of sonic pulses. Some of Nichols' data, (4), were averaged and plotted in Figure 23 for purposes of comparison. The results for the present study demonstrated the expected steady increase in rate of evaporation as air velocity was increased. The failure of these results to roughly coincide with Nichols' result is not understood. The use of different evaporative surfaces may have contributed to the observed differences although this is not believed to be the case.

The initial work in the present study considered the possibility that operation of the sonic driver resulted in a sort of "wind effect" which was the mechanism responsible for the large increases (as much as two hundred percent) in rates of evaporation observed by previous investigators (3)(4). Chueh (3), p. 73, defined the "wind effect" as "the disturbances caused by the 'wind current' created by the movement of the diaphragm of the sonic driver." Chueh considered that "the difference between 'wind current' and

'sound wave' is that the former is a kind of flow motion, while the latter is transmitted through the molecular motion." Thus, if a wind effect existed, it would occur next to the diaphragm and extend away from the diaphragm until it was dissipated in the transmitting fluid. Chueh observed smoke patterns to test for the existence of a "wind current" and concluded that none was present. Details of the operating conditions he used are not available except for one set of conditions using sonic pulses at about 1150 cps and 129 db. Chueh had observed increases in rates of evaporation of over two hundred percent upon application of sonic pulses at these conditions.

All disturbances of smoke patterns that are reported in this work are considered to indicate the existence of streaming. Preliminary tests with an experimental setup similar to Nichols' showed disturbances in smoke patterns immediately below the sonic driver. These disturbances indicated the existence of either a "wind current" or streaming. At this time, these disturbances were believed to indicate the presence of a "wind current" and was considered to be the probable cause of the large increases in evaporation rates that had been observed by previous investigators. However, subsequent work showed it was possible to generate smoke disturbances at some distance from the sonic driver while maintaining a stagnant region between these disturbances and the sonic driver. This discontinuity in the smoke disturbances could not occur if only a wind current existed. Also the smoke disturbances next to the sonic driver were very similar in appearance to an air jet which is the form of disturbance that streaming would be expected to take under these conditions (9) (19). These results led to the conclusion that streaming was responsible for the observed smoke disturbances.

A test was run to determine if the existence of streaming, as indicated by observations of disturbances in smoke patterns, was responsible for large

increases in evaporation rates. Two experimental setups were chosen in an attempt to be able to operate with and without the presence of streaming in the region surrounding the evaporative surface. Equipment setup A was identical to that used by Nichols except for the evaporative surface location. Smoke observations demonstrated that for some operating conditions the application of sonic pulses resulted in streaming around the evaporative surface.

Equipment setup B was the same as setup A except for the use of a vertical tunnel section between the sonic driver and the main tunnel in which the evaporative surface was located. This vertical tunnel section served as a buffer chamber in which the streaming occurring immediately below the sonic driver had an opportunity to dissipate its energy without affecting the flow in the vicinity of the evaporative surface.

The results with setup A supported the hypothesis that streaming was responsible for the increases in evaporation rates observed upon application of sonic pulses. Streaming observations using smoke injection are given in Table 5. The evaporation data are in Table 8 and are plotted in Figures 24, 25, and 26. Comparisons between Table 5 and the figures show that increases in evaporation rates were observed only when the streaming was present around the evaporative surface and became larger as the intensity of the streaming increased. Although the sonic intensities used at 1200 cps were as great as those at lower frequencies, no streaming was observed in the vicinity of the evaporative surface and no effect of sonic pulses on evaporation rates was readily apparent.

Figure 22 illustrates the sweeping action that high air flow rates had on the streaming generated by the application of sonic pulses using setup A. It was possible to sweep the streaming flow down the tunnel before it could reach the region immediately surrounding the evaporative surface. This effect

might explain the results plotted on Plates X and XIII by Nichols. These results indicate that evaporation rates increased as sonic intensity was increased at constant air flow. However, increases in air flow at constant intensity had a positive, negative, or no effect on evaporation rates. For a given sonic intensity the change in rate of evaporation, as air flow rate was increased, could have depended on how much the increased evaporation rate, resulting from higher air flow, compensated for the reduction in evaporation rate caused by the streaming flow being swept away from the evaporative surface.

The results with setup B also indicated the dependence of change in evaporation rates on the existence of streaming next to the evaporative surface as indicated by visual observations of smoke patterns. The operating conditions in setup B, including the frequency and intensity of the sonic pulses at the evaporative surface, were the same as those used with setup A. Although streaming was observed in the vertical tunnel immediately below the sonic driver, it was never present in the main tunnel. These streaming observations, given in Table 6, are consistent with the failure to detect significant increases in evaporation rates with the application of sonic pulses using setup B. The evaporation data are given in Table 8 and plotted in Figures 24, 25, and 26. The evaporation data at 1200 cps for both setups A and B indicated that the sonic pulses might have caused a small decrease in evaporation rates, that is, a negative effect. No further work was performed to confirm this possibility.

Further investigation of the application of sonic pulses and their effect on evaporation rates and streaming patterns was directed toward developing a better understanding of those factors in the experimental setup which might be important in establishing evaporation rates. It was decided to use

equipment setups C and D which differed only in the cross sectional size of the vertical tunnel section.

Smoke observations were taken on setups C and D with no evaporative head or main air flow to determine the frequencies to be used for evaporation runs. Those frequencies which resulted in the most intense streaming at the usual location of the evaporative surface were selected for the evaporation runs. Frequencies of 1500, 1680, and 1800 cps were also chosen because they had high sonic intensities with little or no streaming. These three frequencies were selected to provide contrast with the runs with considerable streaming while still operating at about the same sonic intensities at the evaporative surface. The frequencies with high sonic intensities and little streaming were selected also to see if the application of sonic pulses might reduce evaporation rates under these conditions. Nichols, p. 17 and p. 36, had observed such a negative effect of sonic pulses at operating conditions that were indicated in the present study to have relatively minor streaming when compared to runs where sonic pulses increased evaporation rates.

Table 7 records the smoke observations with equipment setups C and D. It may be noted that the values of the voltages applied to the sonic driver in Table 7 were not the exact values required for the same sonic intensities at the evaporative surface for setups C and D. This made it necessary to interpolate to compare, at constant sonic intensities, the intensities of the streaming at the evaporative surface location between setups C and D. Figures 19 and 20 plot the voltage to the sonic driver which produced the same sonic intensities at the evaporative surface for setups C and D.

By comparisons, at constant sonic intensity, of the intensities of the streaming for setups C and D, it was possible to predict how the effect of the sonic pulses on evaporation rates would compare for the two equipment setups.

This was done on the basis that the more frequent and intense or vigorous streaming at the evaporative surface location would result in a greater increase in evaporation rate. Table 10 lists the predictions which were made. Table 10 also shows how the changes in evaporation rates resulting from the application of sonic pulses compared between setups C and D. Table 10 shows good agreement between the predictions of evaporation rates and the experimental data on evaporation.

It was also possible to use the streaming observations in Table 7 to make a series of predictions of evaporation rates for all frequencies contained in Table 7. These predictions are given in Table 11 and, like those in Table 10, are based on the assumption that more frequent and intense streaming will result in a greater change in evaporation rate when sonic pulses are applied. However, unlike the Table 10 predictions, the anticipated evaporation rates, i.e.,  $R/R_0$  in Table 11, are not on the basis of constant sonic intensity. The evaporation rates, i.e.,  $R/R_0$  values, were sight values taken from the trends established in Figures 28 to 33. Table 11 exhibits relatively good agreement between the predictions and the experimental data on evaporation rates.

The evaporation runs at 1500, 1680, and 1800 cps showed no appreciable effect of sonic pulses on evaporation rates. As with the runs at 1200 cps for setups A and B, a large number of runs would be required to determine if the application of sonic pulses results in a small change in rate of evaporation.

The results of comparisons between equipment setups A and B in previous discussions and between setups C and D in Table 10, indicate that the geometry of the enclosure or tunnel system of the experimental setups is a vital factor in determining the effect of the sonic pulses on evaporation rates. The effect on evaporation rates increased as the intensity of the streaming increased and the streaming intensity was dependent on the geometry of the enclosure. As

the comparisons were made at identical operating conditions (i.e., sonic frequency, sonic intensity, and air velocity) at the same location for the evaporative surface, it is indicated that any streaming which resulted from the sonic pulses contacting the evaporative head was minor in its effect on evaporation rates for the operating conditions used in this work. The conclusion that more intense streaming resulted in higher evaporation rates is also supported by the agreement between predictions and data in Table 11.

Comparisons between all four of equipment setups A, B, C, and D also show the importance of the enclosure of the equipment setup. Figure 27 shows this in a plot of the results of evaporation runs at the only frequency, 600 cps, common to the evaporation runs on all four of these setups.

The intensity of the streaming increased as sonic intensity increased. This relationship is indicated by the smoke observations in Tables 5, 6, and 7. However, if sonic frequency is also allowed to vary, then the relationship between streaming intensity and sonic intensity is unknown.

No effort was made to derive quantitative relationships relating evaporation rates to the other operating conditions, e.g., sonic frequency, sonic intensity, and air flow rate. Relationships of this nature would have limited usefulness because they would apply to only a few specific situations, i.e., the experimental setups used in this study.

In addition to the evaporation data obtained in the present work, Figure 27 also includes evaporation results in the form of  $R/R_0$  values calculated from the results of Nichols, p. 29. Although these values indicate a large change in evaporation rates upon the application of sonic pulses, the  $R/R_0$  values for experimental setup A are larger at the same sonic intensities. The opposite result was expected because the evaporative surface was closer to

the sonic driver in Nichols' experimental setup and this was expected to result in greater impingement of the streaming flow upon the evaporative surface.

Although the overall results of the evaporation runs in the present study seem fairly consistent with the results obtained by Nichols, there is one outstanding point of disagreement when considering the work by Chueh. Chueh observed increases in evaporation rates up to two hundred and ten percent (or  $R/R_0 = 3.10$ ) by applying sonic pulses at 1150 cps and 129 db. Using titanium tetrachloride smoke, Chueh observed no streaming (i.e., "wind current" in Chueh's terminology) with sonic pulses at 1150 cps and 129 db. The results of the present study indicate that streaming should be detectable at sonic conditions resulting in such large increases in evaporation rates.

While a satisfactory explanation of Chueh's results cannot be made on the basis of the present work the following points should be considered.

1. Chueh used up to a 20.5 volt signal to the sonic driver which was the same type as used with experimental setups A and B in the present study. However, the sonic driver became overloaded in the present work with voltages greater than about 10 volts when frequencies were above 1000 cps. The sonic intensity-voltage relationships at the evaporative surface in Chueh's work were probably not the same as in the present study.

2. Some mild streaming was observed in the present study at 1200 cps and 4 to 8 volts to the sonic driver. However, the streaming did not impinge upon the evaporative surface probably as a result of the sweeping action of the air flow through the main tunnel.

3. With zero air flow through the main tunnel, Chueh did observe a thirty-five percent increase in evaporation rate at 1200 cps, 124 db, and 15.5 volts to the sonic driver.



4. The region in which streaming flow is generated may be very close to the sonic driver and the db-voltage relationship in this region might be considerably different from that determined at the location of the evaporative surface. These differences might help explain the observed variations in streaming flow as frequency varied and sonic intensity at the evaporative surface was constant.

Thus the results of the present study indicate that streaming might exist for Chueh's operating conditions. The results also demonstrate the existence of streaming in the vicinity of the evaporative surface when sonic conditions result in a change in evaporation rate greater than a few percent.

The smoke observations generally indicated that an air jet like effect was directed toward the evaporative surface when conditions were such as to result in strong streaming flow. This flow pattern would indicate that the streaming was of the type first analyzed by Eckart (9). This type of streaming results from an interaction between the sonic pulses and the transmitting fluid where the sound beam does not contact a solid surface. This condition existed in each of the experimental setups in the region between the evaporative head and the top of the main tunnel where the sonic pulses entered into the main tunnel.

Though generally it appeared that conditions resulting in greater streaming flow also resulted in increased evaporation, it should be recognized that anomalous results sometimes occurred. Setup D exhibited a consistent reduction in evaporation rates upon the application of sonic pulses at 600 cps at sonic intensities in the lower portion of the range of intensity covered. Another unexpected result which occurred for some of the operating conditions used (e.g., setup D at 600 cps and less than 127 db) was the indicated decrease in evaporation rates as sonic intensities were increased. Though it might be supposed that some combinations of streaming and forced air flows may result

in unusual net flow, a suitable explanation for these unexpected results has not been deduced.

The analysis of the evaporation data and streaming observations was made more complex by not being subject to reproducibility problems with just these particular data. The reproducibility of the sonic intensity data also was important because comparisons were made at the same sonic intensities for the different experimental setups.

### CONCLUSIONS

The effect of the application of sonic pulses on rate of evaporation results at least in considerable degree from the streaming phenomena. When an effect or change in rate of evaporation existed, it usually took the form of an increase in evaporation rate and conditions which led to more vigorous streaming in the vicinity of the evaporative surface usually resulted in greater increases in rates of evaporation. The streaming was a function of the acoustic conditions and of the geometry of the enclosure or tunnel system in the experimental setup. If any streaming resulted from the sonic pulses contacting the evaporative head, it had a relatively minor effect on evaporation rates. The intensity of the streaming increased as sonic intensity increased with other operating conditions being held constant. The quantitative results obtained in the present study are specific to the particular systems used and are thus restricted in their application. The predominant streaming observed appeared to be the type that results from an interaction between the sonic pulses and the transmitting fluid with no solid surface required to be present for its generation.

## RECOMMENDATIONS

The following recommendations are given for consideration in any future study:

The study should be reconsidered with attention given to the importance of the streaming phenomena in determining the effect of the application of sonic pulses on rates of evaporation or any other physical phenomena being considered. It may sometimes prove advantageous to consider this work as primarily a study of streaming. This viewpoint can make it possible to better define the problem and its solution. Studies of streaming may permit more rapid examination of possible experimental conditions to determine those conditions which should be given more detailed consideration. This approach could lead to improved optimization in the choice of experimental conditions whose evaporation rates should be evaluated. It is possible that radical changes in the operating conditions and the geometry of the experimental setup may be desirable. A more precise means of measuring streaming flow is also needed.

A more carefully constructed equipment setup is desirable to improve the reproducibility of the results. This can become especially important as the equipment is varied back and forth between several various choices.

Three other equipment changes are also recommended as desirable. The first is the use of a smaller sensing element for determination of sonic intensities. This could be used to determine sonic intensities at various points when the evaporative surface is in place. This might also be useful in determining sonic intensities at the evaporative surface while using a sensing element which has the same acoustical properties as the evaporative surface. A second desirable equipment change would be the use of a more

stable signal generation system and one not so dependent on being set to certain multiples of 60 cps. This improvement in frequency control would be useful but may not be necessary. The third desirable equipment change is the necessary alterations to provide for the use of higher sonic intensities. This would make the effects being studied more pronounced and permit them to be more easily detected and determined. It may also be helpful in the analysis of the results to have data taken over a wider range of sonic intensities.

## ACKNOWLEDGMENTS

Acknowledgment is given to Professor Raymond C. Hall, major instructor and advisor, for his interest and consultation during the course of this work.

Acknowledgment is given to Dr. William H. Honstead, Professor and Head of the Chemical Engineering Department.

Acknowledgment is given to Mr. Fremont Wiley for his assistance in construction of various portions of the equipment.

Acknowledgment is given to the Dow Chemical Company for providing Fellowship funds.

Acknowledgment is given to the Engineering Experiment Station of Kansas State University for providing funds for equipment requirements.

Acknowledgment is given to the Procter and Gamble Company for the use of their hot wire anemometer.

## LITERATURE CITED

- (1) Thompson, Dudley and D. G. Sutherland  
Ultrasonic Insonation Effect on Liquid-Solid Extraction. *Industrial and Engineering Chemistry*, 47:1167-1169 (1955).
- (2) Hodgins, J. W., T. W. Hoffman, and D. C. Pei  
The Effect of Sonic Energy in Solid-Gas Contacting Operations. *Canadian Journal of Chemical Engineering*, 35 (1):18-24 (1957).
- (3) Chueh, Chun-Fei  
The Effect of Sonic Vibrations on the Rates of Mass Transfer. Unpublished paper. Department of Chemical Engineering, Kansas State University, Manhattan (1957).
- (4) Nichols, Donald L.  
The Effect of Sonic Vibrations on the Rates of Mass Transfer. Unpublished paper. Department of Chemical Engineering, Kansas State University, Manhattan (1958).
- (5) Boucher, R. J. G.  
Ultrasonics Boosts Heatless Drying. *Chemical Engineering*, 66 (19): 151-154 (1959).
- (6) Harbaun, K. L. and G. Houghton  
Effects of Sonic Vibrations on the Rate of Absorption of Gases from Bubble Beds. *Chemical Engineering Science*, 13:90-92 (1960).
- (7) Lemlich, R. L. and Chung-Kong Huri  
The Effect of Acoustic Vibrations on Forced Convection Heat Transfer. *AIChE Journal*, 7:102-106 (1961).
- (8) Lemlich, R. L.  
Vibration and Pulsation Boost Heat Transfer. *Chemical Engineering*, 68 (1):171-176 (1961).
- (9) Eckart, Carl  
Vortices and Streams Caused by Sound Waves. *Physical Review*, 73 (1): 68-76 (1948).
- (10) Jackson, F. J. and W. L. Nyborg  
Sonically Induced Microstreaming Near a Plane Boundary. I. The Sonic Generator and Associated Acoustic Field. *Journal of the Acoustical Society of America*, 32:1243-1250 (1960).
- (11) Medwin, H. and I. Rudnick  
Surface and Volume Sources of Vorticity in Acoustic Fields. *Journal of the Acoustical Society of America*, 25:538-540 (1953).

- (12) Nyborg, W. L.  
Acoustic Streaming Due to Attenuated Plane Waves. Journal of the Acoustical Society of America, 25:68-75 (1953).
- (13) Nyborg, W. L.  
Acoustic Streaming Near a Boundary. Journal of the Acoustical Society of America, 30:329-339 (1958).
- (14) Lord Rayleigh  
Theory of Sound. Dover Publications, New York (1945).
- (15) Schlichting, H.  
Physik 7, 33:327 (1932).
- (16) Westervelt, P. J.  
Theory of Rotational Flow Generated by a Sound Field. Journal of the Acoustical Society of America, 25:60-67 (1953).
- (17) Piercy, J. E. and J. Lamb  
Acoustic Streaming in Liquids. Proceedings of the Royal Society, A226:43-50 (1954).
- (18) Peterson, A. P. G., L. L. Beranek and E. E. Gras  
Handbook of Noise Measurement and Measurement of Vibration. General Radio Company.
- (19) Liebermann, L. N.  
The Second Viscosity of Liquids. Physical Review, 75:1415-1422 (1949).

APPENDIX



Table 1. Volumes of sections of capillary tube.

Section	:	Volume ml.
0-1	:	0.01159
1-2	:	0.01203
2-3	:	0.01103
3-4	:	0.01174
4-5	:	0.01135
5-6	:	0.01128
6-7	:	0.01163
7-8	:	0.01160
8-9	:	0.01136

Table 2. Sonic intensities for equipment setup B. Sonic driver SP-3. Microphone height varies.

Run	Microphone	Microphone Height Inches	Temp. °F.	Freq. cps	Volts to Sonic Driver	As Read Sonic Intensity db
I61-195- 1	Shure 9898	1-23/32	79	600	8	115.2
- 2	"	"	"	600	16	119.8
- 3	"	"	"	660	8	118.4
- 4	"	"	"	660	16	123.4
- 5	"	"	"	1200	8	130.4
- 6	"	2-7/32	"	1200	8	128.8
- 7	"	"	"	660	8	118.6
- 8	"	"	"	660	16	123.2
- 9	"	"	"	600	8	113.6
-10	"	"	"	600	16	118.4
-11	"	2-13/16	"	600	8	111.1
-12	"	"	"	600	16	116.2
-13	"	"	"	660	8	119.0
-14	"	"	"	660	16	123.7
-15	"	"	"	1200	8	126.0
-16	"	3-1/4	"	1200	8	122.5
-17	"	"	"	660	8	119.3
-18	"	"	"	660	16	123.8
-19	"	"	"	600	8	109.7
-20	"	"	"	600	16	114.8
-21	"	3-23/32	"	600	8	107.6
-22	"	"	"	600	16	112.6
-23	"	"	"	660	8	119.4
-24	"	"	"	660	16	124.1
-25	"	"	"	1200	8	116.3
-26	"	3-15/16	"	1200	8	112.8
-27	"	"	"	660	8	119.4
-28	"	"	"	660	16	124.2
-29	"	"	"	600	8	107.0
-30	"	"	"	600	16	111.9
-31	Lapel	1-3/4	"	600	8	117.5
-32	"	"	"	600	16	122.6
-33	"	"	"	660	8	121.4
-34	"	"	"	660	16	125.5
-35	"	"	"	1200	8	134.9
-36	"	2-1/4	"	1200	8	132.6
-37	"	"	"	660	8	122.0
-38	"	"	"	660	16	126.4
-39	"	"	"	600	8	116.0
-40	"	"	"	600	16	120.9
-41	"	2-3/4	"	600	8	114.3
-42	"	"	"	600	16	119.0
-43	"	"	"	660	8	122.4
-44	"	"	"	660	16	126.8
-45	"	"	"	1200	8	129.8

Table 2. (concl.)

Run	Microphone	Microphone Height Inches	Temp. OF.	Freq. cps	Volts to Sonic Driver	As Read Sonic Intensity db
I61-195-46	Lapel	3-1/4	79	1200	8	124.6
-47	"	"	"	660	8	122.7
-48	"	"	"	660	16	127.2
-49	"	"	"	600	8	112.5
-50	"	"	"	600	16	117.2
-51	"	3-3/4	"	600	8	110.4
-52	"	"	"	600	16	115.7
-53	"	"	"	660	8	123.0
-54	"	"	"	660	16	127.7
-55	"	"	"	1200	8	108.0
-56	"	4-1/4	"	1200	8	123.2
-57	"	"	"	660	8	123.4
-58	"	"	"	660	16	127.8
-59	"	"	"	600	8	109.0
-60	"	"	"	600	16	114.3
-61	"	4-11/16	"	600	8	108.7
-62	"	"	"	600	16	114.1
-63	"	"	"	660	16	123.2
-64	"	"	"	660	16	128.0
-65	"	"	"	1200	8	129.1
-66	"	4-0	"	1200	8	122.3
-67	"	3-7/8	"	1200	8	116.0
-68	"	3-3/4	"	1200	8	116.3
-69	"	3-5/8	"	1200	8	117.9
-70	"	3-1/2	"	1200	8	119.9
-71	"	3-3/8	"	1200	8	121.1
-72	"	3-1/4	"	1200	8	124.3
-73	"	3-3/4	"	1200	8	114.7

Table 3. Sonic intensities for equipment setups A and B. Sonic driver SP-3. Microphone at evaporative surface position.

Run	Equipment Setup	Microphone	Temp. °F.	Freq. cps	Volts to Sonic Driver	As Read Sonic Intensity db
161-207- 1	A	Lapel	81	600	4	104.8
- 2	"	"	"	600	8	110.0
- 3	"	"	"	600	12	112.7
- 4	"	"	"	600	16	114.5
- 5	"	"	"	660	4	115.4
- 6	"	"	"	660	12	123.2
- 7	"	"	"	660	16	124.8
- 8	"	"	"	1200	2	115.7
- 9	"	"	"	1200	4	121.2
-10	"	"	"	1200	6	124.7
-11	"	"	"	1200	8	126.9
-12	"	"	"	610	8	116-122
-13	"	"	"	610	12	118-122
-14	B	"	"	600	5.6	104.8
-15	"	"	"	600	11.4	110.0
-16	"	"	"	600	17.65	112.7
-18	"	"	"	660	3.3	115.4
-19	"	"	"	660	9.1	123.2
-20	"	"	"	660	11.25	124.8
-21	"	"	"	1200	2.65	115.7
-22	"	"	"	1200	5.45	121.2
-23	"	"	"	1200	8.5	124.7
-25	"	"	"	610	8	118.0
-26	"	"	"	610	12.5	121.0
-27	"	"	"	600	5.5	104.8
-28	"	"	"	600	11.1	110.0
-29	"	"	"	600	17.6	112.7
-31	"	"	"	660	3.3	115.4
-32	"	"	"	660	8.9	123.2
-33	"	"	"	660	11.15	124.8
-34	"	"	"	1200	2.6	115.7
-35	"	"	"	1200	5.4	121.2
-36	"	"	"	1200	8.4	124.7
-38	"	"	"	600	4	104.4
-39	"	"	"	600	8	109.9
-40	"	"	"	600	12	112.7
-41	A	"	"	600	16	114.7
-42	"	"	"	660	4	115.2
-43	"	"	"	660	12	123.0
-44	"	"	"	660	16	124.6
-45	"	"	"	1200	2	115.4
-46	"	"	"	1200	4	121.2
-47	"	"	"	1200	6	124.8
-48	"	"	"	1200	8	126.7
-49	B	"	"	600	5.5	104.4

Table 3. (concl.)

Run	Equipment Setup	Microphone	Temp. OF.	Freq. cps	Volts to Sonic Driver	As Read Sonic Intensity db
I61-207-50	B	Lapel	81	600	11.75	109.9
-51	"	"	"	600	17.4	112.7
-53	"	"	"	660	3.2	115.2
-54	"	"	"	660	8.85	123.0
-55	"	"	"	660	11.05	124.6
-56	"	"	"	1200	2.55	115.4
-57	"	"	"	1200	5.35	121.2
-58	"	"	"	1200	8.5	124.8

Table 4. Sonic intensities for equipment setups C and D. Sonic driver SP-15. Shure 9898 microphone at evaporative surface position.

Run	Equipment Setup	Temp. °F.	Freq. cps	Volts to Sonic Driver	As Read Sonic Intensity db	Temp. Correction db	Sonic Intensity db
I62-198-247	C	84	300	4.0	104.0	2.9	106.9
-248	"	"	330	4.0	121.9	"	124.8
-256	"	"	570	4.0	121.2	"	124.1
-257	"	"	600	4.0	115.9	"	118.8
-259	"	"	660	4.0	117.4	"	120.3
-272	"	"	1200	4.0	122.4	"	125.3
-276	"	"	1320	4.0	122.4	"	125.3
-277	"	"	1320	4.0	122.9	"	125.8
-278	"	"	1380	4.0	121.8	"	124.7
-279	"	"	1380	4.0	122.9	"	125.8
-280	"	"	1440	4.0	125.7	"	128.6
-281	"	"	1440	4.0	127.0	"	129.9
-282	"	"	1500	4.0	125.8	"	128.7
-283	"	"	1500	4.0	126.2	"	129.1
-286	"	"	1680	4.0	125.3	"	128.2
-288	"	"	1800	4.0	124.8	"	127.7
-289	"	"	300	3.0	101.0	"	103.9
-290	"	"	300	6.0	107.0	"	109.9
-291	"	"	300	9.0	110.9	"	113.8
-292	"	"	300	12.0	113.2	"	116.1
-293	"	"	300	15.0	115.0	"	117.9
-294	"	"	600	3.0	114.9	"	117.8
-295	"	"	600	6.0	120.4	"	123.3
-296	"	"	600	9.0	123.9	"	126.8
-297	"	"	600	12.0	126.3	"	129.2
-298	"	"	900	2.0	103.6	"	106.5
-299	"	"	900	4.0	109.3	"	112.2
-300	"	"	900	6.8	112.6	"	115.5
-301	"	"	900	8.0	114.9	"	117.8
-302	"	"	900	10.0	116.7	"	119.6
-303	"	"	1200	2.0	117.0	"	119.9
-304	"	"	1200	2.0	116.9	"	119.8
-305	"	"	1200	4.0	122.4	"	125.3
-306	"	"	1200	4.0	122.4	"	125.3
-307	"	"	1200	6.0	127.0	"	129.9
-309	"	"	1200	6.0	128.4	"	131.3
-310	"	"	1200	8.0	127.8	"	130.7
-311	"	"	1200	8.0	127.8	"	130.7
-312	"	"	1500	2.0	120.7	"	123.6
-313	"	"	1500	2.0	120.2	"	123.1
-314	"	"	1500	4.0	125.8	"	128.7
-315	"	"	1500	6.0	130.0	"	132.9
-316	"	"	1500	8.0	132.3	"	135.2
-317	"	"	1800	2.0	118.0	"	120.9
-318	"	"	1800	4.0	124.8	"	127.7

Table 4. (cont.)

Run	Equipment Setup	Temp. °F.	Freq. cps	Volts to Sonic Driver	As Read Sonic Intensity db	Temp. Correction db	Sonic Intensity db
I62-198-319	C	84	1800	6.0	130.0	2.9	132.9
-320	"	"	1800	8.0	130.5	"	133.4
-321	"	"	1800	2.0	120.4	"	123.3
-322	"	"	1800	4.0	125.9	"	128.8
-323	"	"	1800	6.0	130.7	"	133.6
-324	"	"	1800	8.0	132.3	"	135.2
-325	"	"	1800	8.0	130.1	"	133.0
-326	"	"	1800	8.0	131.8	"	134.7
-327	"	"	1800	4.0	125.1	"	128.0
-328	"	"	1800	4.0	126.1	"	129.0
-329	"	"	1800	4.0	123.1	"	126.0
I62-204- 1	C	86	330	10.0	128.6	3.2	131.8
- 2	"	"	330	13.0	130.6	"	133.8
- 3	"	"	330	15.0	131.8	"	135.0
- 4	"	"	600	8.0	125.9	"	129.1
- 5	"	"	600	12.0	128.6	"	131.8
- 6	"	"	600	14.0	130.6	"	133.8
- 7	"	"	570	10.0	128.2	"	131.4
- 8	"	"	570	11.0	128.9	"	132.1
- 9	"	"	570	13.0	130.1	"	133.3
-10	"	"	1320	10.0	130.1	"	133.3
-11	"	"	1380	10.0	130.2	"	133.4
-12	"	"	1440	10.0	131.3	"	134.5
-13	"	"	1680	8.0	133.1	"	134.3
-14	"	"	1800	8.0	131.7	"	134.9
I62-197- 2	D	80	330	2.0	115.3	2.3	117.6
-15	"	"	570	4.0	122.1	"	124.4
-16	"	"	600	4.0	120.3	"	122.6
I62-198- 2	D	83	330	4.0	120.9	2.7	123.6
-10	"	"	570	4.0	122.1	"	124.8
-11	"	"	600	4.0	120.3	"	123.0
-13	"	"	660	4.0	117.6	"	119.7
-26	"	"	1200	4.0	122.0	"	124.7
-28	"	"	1320	4.0	125.1	"	127.8
-29	"	"	1380	4.0	122.7	"	125.4
-30	"	"	1440	4.0	129.4	"	132.1
-31	"	"	1500	4.0	127.4	"	130.1
-34	"	"	1680	4.0	126.4	"	129.1
-36	"	"	1800	4.0	126.4	"	129.1
-37	"	"	300	3.0	100.5	"	103.2
-38	"	"	300	6.0	106.9	"	109.6
-39	"	"	300	9.0	110.3	"	113.0
-40	"	"	300	12.0	113.1	"	115.8
-41	"	"	300	15.0	115.0	"	117.7

Table 4. (cont.)

Run	Equipment Setup	Temp. °F.	Freq. cps	Volts to Sonic Driver	As Read Sonic Intensity db	Temp. Correction db	Sonic Intensity db
162-198-42	D	83	600	3.0	118.0	2.7	120.7
-43	"	"	600	6.0	123.8	"	126.5
-44	"	"	600	9.0	126.9	"	129.6
-45	"	"	600	12.0	129.1	"	131.8
-46	"	"	900	2.0	104.3	"	107.0
-47	"	"	900	4.0	110.1	"	112.8
-48	"	"	900	6.0	112.4	"	115.1
-49	"	"	900	8.0	115.5	"	118.2
-50	"	"	900	10.0	117.1	"	119.8
-51	"	"	1200	2.0	116.4	"	119.1
-52	"	"	1200	4.0	122.0	"	124.7
-53	"	"	1200	6.0	125.5	"	128.2
-54	"	"	1200	8.0	127.7	"	130.4
-55	"	"	1200	2.0	121.4	"	124.1
-56	"	"	1500	4.0	127.4	"	130.1
-57	"	"	1500	6.0	131.5	"	134.2
-58	"	"	1500	8.0	132.9	"	135.6
-59	"	"	1800	2.0	120.6	"	123.3
-60	"	"	1800	4.0	126.4	"	129.1
-61	"	"	1800	6.0	129.7	"	132.4
-62	"	"	1800	8.0	131.7	"	134.4
162-200-2	D	82	330	4.0	121.1	2.6	123.7
-10	"	"	570	4.0	122.2	"	124.8
-11	"	"	600	4.0	121.1	"	123.7
-13	"	"	660	4.0	117.9	"	120.5
-26	"	"	1200	4.0	122.7	"	125.3
-28	"	"	1320	4.0	124.6	"	127.3
-29	"	"	1380	4.0	122.8	"	125.4
-30	"	"	1440	4.0	129.1	"	131.7
-31	"	"	1500	4.0	126.6	"	129.2
-34	"	"	1680	4.0	127.7	"	130.3
-36	"	"	1800	4.0	127.6	"	130.2
-42	"	"	600	4.0	120.6	"	123.2
-43	"	"	660	4.0	117.5	"	120.1
-53	"	"	1200	4.0	122.2	"	124.8
-55	"	"	1320	4.0	125.2	"	127.8
-56	"	"	1380	4.0	123.1	"	125.7
-57	"	"	1440	4.0	129.7	"	132.3
-58	"	"	1500	4.0	127.0	"	129.6
-61	"	"	1680	4.0	127.1	"	129.7
-63	"	"	1800	4.0	127.0	"	129.6
162-205-17	D	84	330	10.4	128.6	2.9	131.5
-18	"	"	330	13.7	130.6	"	133.5
-19	"	"	330	16.4	131.8	"	134.7
-20	"	"	600	7.45	125.9	"	128.8



Table 4. (concl.)

Run	Equipment Setup	Temp. °F.	Freq. cps	Volts to Sonic Driver	As Read Sonic Intensity db	Temp. Correction db	Sonic Intensity db
162-205-21	D	84	600	10.8	128.6	2.9	131.5
-22	"	"	600	14.4	130.6	"	133.5
-23	"	"	570	9.7	128.2	"	131.1
-24	"	"	570	10.6	128.9	"	131.8
-25	"	"	570	12.15	130.1	"	133.0
-26	"	"	1320	7.75	130.1	"	133.0
-27	"	"	1380	10.0	129.9	"	132.8
-28	"	"	1440	5.2	131.3	"	134.2
-29	"	"	1680	8.0	132.0	"	134.9
-30	"	"	1800	7.65	131.7	"	134.6
-31	"	"	1440	10.0	136.7	"	137.6
-32	"	"	1500	10.0	134.4	"	137.3

Table 5. Smoke observations for equipment setup A.

Run	Frequency cps	Volts to Sonic Driver	Air Flow Manometer P Inches of Water
1	-	0	0.78
2	600	4	0.81
3	600	8	0.81
4	600	12	-
5	600	16	0.80
6	Approx. 610	8	-
7	Approx. 610	12	-
8	660	4	-
9	660	12	-
10	660	16	-
11	1200	2	-
12	1200	4	-
13	1200	6	-
14	1200	8	0.81

Table 5 (Cont.)

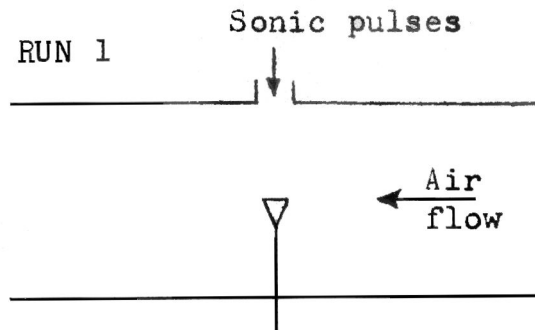

No turbulence detected.

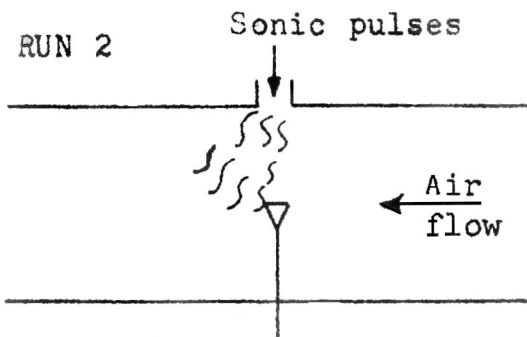

Some turbulence (not very violent) but it generally did not appear to impinge upon the evaporative surface to any great extent.

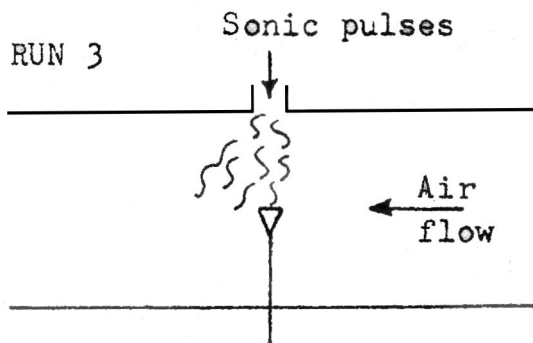

Considerable turbulence usually covering most of the evaporative surface.

Table 5 (Cont.)

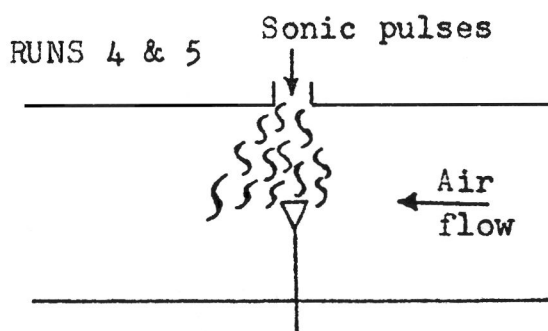

Strong turbulence over all of the evaporative surface and even upstream of it. Turbulence stronger than in Run 3 but could not detect any difference between Runs 4 and 5.

RUNS 6 & 7

Similar to Runs 3 and 4, respectively.

RUNS 8, 9, & 10

Similar to Runs 2, 4, and 5, respectively.

RUN 11

Essentially no turbulence.

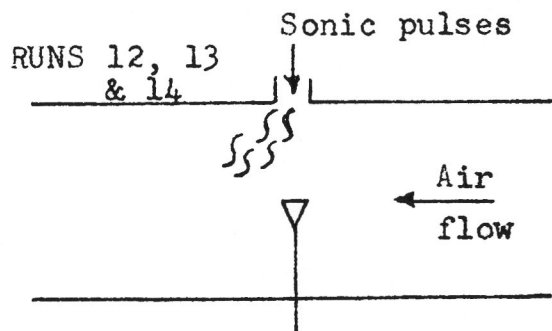

Slight turbulence but it did not impinge upon the evaporative surface.

Table 5. (concl.)

---

---

**Notes:**

In the above runs the streaming was somewhat similar in appearance to a turbulent jet of air blowing downward from the sonic driver. This was especially true as the streaming became more intense.

At a constant value of 8 volts to the sonic driver, and starting at 2000 cps, no streaming was observed until the frequency was less than 1000 cps. A careful check was made for streaming at 1140 cps and none was observed. Frequency generally had to be less than 700 cps for pronounced streaming to appear.

The descriptions of the streaming follow fairly closely the original observations. This was purposely done in this manner and has resulted in the use of the term turbulence. Turbulence was initially used to describe the streaming when it was believed that the streaming was a wind current generated by the diaphragm of the sonic driver. As the streaming became more intense, the flow variations were more rapid and appeared to have random components resulting in the streaming being called turbulence.

---

Table 6. Smoke observations for equipment setup B.

Run	Frequency cps	Volts to Sonic Driver	Air Flow Manometer P Inches of Water
1	-	0	0.80
2	600	5.5	-
3	600	11.4	-
4	600	17.55	0.81
5	660	3.25	-
6	660	8.95	-
7	660	11.15	-
8	1200	2.6	-
9	1200	5.4	0.82
10	1200	8.5	-

## Notes:

No streaming was observed in the main tunnel or in the lower portion of the vertical tunnel. The upper position of the main tunnel had a region of relatively stagnant smoke. This region extended approximately halfway to the evaporative surface. Smoke injection into the upper portion of the vertical tunnel indicated streaming was present immediately below the sonic driver.

Table 7. Smoke observations for equipment setups C and D.

Comparison Number	Freq. cps	Conditions Used		Compared To		Smoke Observations For Conditions Used Also See Notes
		Equipment Setup	Volts to Sonic Driver	Equipment Setup	Volts for Same Sonic Intensity	
1	330	C	10.0	D	11.3	Very strong turbulence extends down about to evaporative surface position.
1	330	C	14.3	D	16.3	Same as at 10.0 volts but now turbulence extends to bottom of main tunnel.
1	330	D	11.7	C	10.3	Intermittant turbulence fairly often extending to and past evaporative surface position. Below the turbulence there was strong swirling up and to the side.
1	330	D	12.8	C	11.3	Same as at 11.7 volts but stronger and more like turbulence all the way to the bottom of the main tunnel.
1	330	D	16.0	C	14.1	
2	570	C	11.2	D	11.3	Swirling moving down past evaporative surface position but only part of the time.
2	570	C	14.0	D	14.4	Similar to 11.2 volts but movement is stronger.
2	570	D	12.1	C	11.9	No movement at evaporative head position.
3	600	C	8.75	D	5.9-9.0	Usually strong upward moving swirls in evaporative surface position.
3	600	C	14.0	D	9.5-14.6	Strong turbulence down past evaporative surface position.
3	600	D	6.6	C	6.5-9.8	Turbulence not down to evaporative surface position. Movement to side and up at evaporative surface position.
3	600	D	9.8	C	9.6-14.8	Turbulent like movement at evaporative surface position but not generally of the type moving down.
3	600	D	10.2	C		

Table 7. (concl.)

Comparison Number	Freq. cps	Conditions Used		Compared To		Smoke Observations For Conditions Used Also See Notes
		Equipment Setup	Volts to Sonic Driver	Equipment Setup	Volts for Same Sonic Intensity	
4	1380	C	10.0	D	11.1	Turbulence rather frequently down to and past evaporative surface position.
4	1380	D	10.0	C	9.2	No movement at evaporative surface position.
5	1440	C	10.0	D	5.9	Similar to 1380 cps and 10 volts but weaker.
5	1440	D	10.0	C	17.3	No movement at evaporative head position.
6	1320	C	10.0	D	8.3	Similar to 1380 cps and 10 volts but weaker.
6	1320	D	10.0	C	11.9	No movement at evaporative surface position.
Data not taken for comparison	1500	D	10.0	-	-	Little if any movement at evaporative surface position.
	1680	C	8.0	-	-	Little to no movement at evaporative surface position.
	1800	C	8.0	-	-	No movement at evaporative surface position.

## Notes:

The streaming was observed to occur most readily at the top of the vertical tunnel just below the sonic driver and at the base of the vertical tunnel. At the latter position it overlapped into both the main tunnel and the lower portion of the vertical tunnel. By using certain operating conditions it was sometimes possible to produce agitation of smoke almost throughout the vertical tunnel.

No air flow was used in the above work.

The motion of the disturbances noted in the smoke observations was generally directed downward unless specified otherwise.

The descriptions of the streaming follow fairly closely the original observations made. This was purposely done in this manner. This has resulted in the use of the term turbulence which was initially used when the streaming was thought to be a wind current generated by the movement of the diaphragm of the sonic driver.



Table 8. Rates of evaporation for equipment setups N, A, and B. Sonic driver SP-3.

Run	Equipment Setup	Air Flow Manometer P Inches of Water	Air Flow lb/ft <sup>2</sup> x sec.	Temp. °F.	Freq. cps	Volts to Sonic Driver	Sonic Intensity db	Time min.	Sections on Capillary Tube	Evaporation Rate 10 <sup>5</sup> x ml/min.	R/Ro
E61-166- 1	N	28.3	0.1084	-	-	0	-	4.94	0-3	702	-
- 2	"	4.78	0.0432	-	-	0	-	8.89	1-5	520	-
- 3	"	0.88	0.0163	-	-	0	-	11.63	0-3	298	-
E61-170- 1	N	27.3	0.1064	80.8	-	0	-	5.06	0-3	684	-
- 2	"	23.5	0.0988	80.8	-	0	-	3.49	0-2	677	-
- 3	"	19.4	0.0896	80.8	-	0	-	1.77	0-1	642	-
- 4	"	14.9	0.0788	80.8	-	0	-	1.95	0-1	594	-
- 5	"	11.8	0.0700	80.7	-	0	-	1.96	0-1	593	-
- 6	"	11.8	0.0700	80.7	-	0	-	1.87	2-3	590	-
- 7	"	7.73	0.0564	80.6	-	0	-	2.13	0-1	544	-
- 8	"	7.73	0.0564	-	-	0	-	2.18	1-2	553	-
- 9	"	7.73	0.0564	80.5	-	0	-	2.00	2-3	550	-
-10	"	4.99	0.0444	80.3	-	0	-	2.27	0-1	509	-
-11	"	4.99	0.0444	80.2	-	0	-	2.38	1-2	507	-
-12	"	3.13	0.0356	80.1	-	0	-	2.46	0-1	470	-
-13	"	1.80	0.0252	79.9	-	0	-	2.70	0-1	428	-
-14	"	1.03	0.0180	79.7	-	0	-	2.94	0-1	394	-
-15	"	0.38	0.0094	78.9	-	0	-	7.32	0-2	323	-
-16	"	0.38	0.0094	78.8	-	0	-	3.61	3-4	326	-
E61-171- 1	N	28.8	0.1092	76.7	-	0	-	1.81	0-1	639	-
- 2	"	28.8	0.1092	76.8	-	0	-	3.64	1-3	634	-
- 3	"	28.8	0.1092	76.9	-	0	-	1.86	3-4	632	-
- 4	N	12.4	0.0716	76.9	-	0	-	2.13	0-1	544	-
- 5	"	12.4	0.0716	76.9	-	0	-	4.25	1-3	543	-
- 6	"	12.4	0.0716	76.9	-	0	-	2.16	3-4	543	-
- 7	N	3.04	0.0340	76.5	-	0	-	2.70	0-1	430	-
- 8	"	3.01	0.0340	76.3	-	0	-	5.38	1-3	429	-
- 9	"	3.04	0.0340	76.3	-	0	-	2.72	3-4	432	-
-10	N	29.0	0.1100	136.6	-	0	-	2.19	0-5	2,640	-
-11	"	29.0	0.1100	136.4	-	0	-	1.74	5-9	2,640	-
-12	N	12.3	0.0708	127.0	-	0	-	2.07	0-4	2,240	-
-13	"	12.3	0.0708	126.7	-	0	-	2.59	4-9	2,210	-
-14	"	12.3	0.0708	126.2	-	0	-	2.12	0-4	2,190	-
-15	N	3.04	0.0340	112.0	-	0	-	2.05	0-3	1,693	-
-16	"	3.04	0.0340	111.0	-	0	-	2.12	3-6	1,626	-
E61-178- 1	N	14.1	0.0764	80.4	-	0	-	1.89	0-1	612	-
- 2	"	14.1	0.0764	80.4	-	0	-	1.90	1-2	633	-

Table 8. (cont.)

Run	Equipment Setup	Air Flow Manometer Inches of Water	Air Flow P lb/ft <sup>2</sup> x sec.	Temp. °F.	Freq. cps	Volts to Sonic Driver	Sonic Intensity db	Time min.	Sections on Capillary Tube	Evaporation Rate 10 <sup>5</sup> x ml/min.	R/Ro
E61-182- 1	N	15.0	0.0788	85.8	-	0	-	1.71	0-1	678	-
- 2	"	15.0	0.0788	85.8	-	0	-	1.63	2-3	678	-
- 3	"	15.0	0.0788	85.8	-	0	-	1.68	4-5	674	-
E61-201- 1	A	25.4	0.1022	82.0	-	0	-	1.68	1-2	718	-
- 2	"	25.5	0.1024	82.0	-	0	-	1.71	3-4	685	-
- 3	"	25.5	0.1024	82.0	-	0	-	1.67	5-6	679	-
- 4	A	25.4	0.1022	82.0	-	0	-	1.94	1-2	622	-
- 5	"	25.5	0.1024	82.0	-	0	-	1.90	3-4	619	-
- 6	"	25.4	0.1022	82.0	-	0	-	1.81	5-6	622	-
- 7	A	25.4	0.1022	82.1	-	0	-	1.97	1-2	612	-
- 8	"	25.2	0.1018	82.1	-	0	-	1.92	3-4	611	-
- 9	"	25.1	0.1016	82.1	-	0	-	1.85	5-6	609	-
-10	A	25.1	0.1016	82.4	-	0	-	1.91	0-1	606	-
-11	"	25.1	0.1016	82.3	-	0	-	1.83	2-3	604	-
-12	A	0.79	0.0153	81.8	-	0	-	5.66	0-2	417	-
-13	"	0.79	0.0153	81.8	-	0	-	5.64	2-3	418	-
-14	"	0.79	0.0153	81.8	-	0	-	2.77	3-4	424	-
-15	"	-	-	-	-	0	-	2.67	4-5	425	-
-16	"	0.79	0.0153	81.8	-	0	-	2.65	5-6	426	-
E61-202- 1	A	0.79	0.0153	81.7	-	0	-	2.83	0-1	409	-
- 2	"	0.80	0.0154	81.7	-	0	-	2.93	1-2	410	-
- 3	"	0.80	0.0154	81.7	-	0	-	2.70	2-3	409	-
- 4	A	0.80	0.0154	81.8	-	0	-	2.81	0-1	412	1.00
- 5	"	0.80	0.0154	81.8	600	4	112	2.94	1-2	410	1.00
- 6	"	-	-	-	-	0	-	2.69	2-3	410	1.00
- 7	"	0.80	0.0154	81.8	600	4	112	2.87	3-4	409	0.99
- 8	"	-	-	-	600	4	112	2.76	4-5	410	1.00
- 9	"	0.80	0.0154	81.8	-	0	-	2.75	5-6	411	1.00
-10	A	0.80	0.0154	82.0	-	0	-	2.84	0-1	408	1.02
-11	"	0.80	0.0154	82.0	600	8	117	2.40	1-3	958	2.40
-12	"	-	-	-	-	0	-	2.97	3-4	395	0.99
-13	"	0.80	0.0154	82.1	600	8	117	2.40	4-6	945	2.37
-14	"	0.80	0.0154	82.1	-	0	-	2.94	6-7	395	0.99
-15	"	-	-	-	600	8	117	1.25	7-8	927	2.32
-16	"	0.80	0.0154	82.2	600	8	117	1.18	8-9	958	2.40

Table 8. (cont.)

Run	Equipment Setup	Air Flow Manometer P Inches of Water	Air Flow lb/ft <sup>2</sup> x sec.	Temp. °F.	Freq. cps	Volts to Sonic Driver	Sonic Intensity db	Time min.	Sections on Capillary Tube	Evaporation Rate 10 <sup>5</sup> x ml/min.	R/Ro
E61-202-17	A	0.80	0.0154	82.2	-	0	-	3.05	0-1	380	1.00
-18	"	-	-	-	600	12	120	0.96	1-2	1,254	3.31
-19	"	-	-	-	600	12	120	0.87	2-3	1,271	3.35
-20	"	0.80	0.0154	82.2	-	0	-	3.12	3-4	377	1.00
-21	"	-	-	-	600	12	120	0.91	4-5	1,242	3.28
-22	"	0.80	0.0154	82.2	-	0	-	2.98	5-6	378	1.00
-23	A	0.80	0.0154	82.2	-	0	-	2.96	0-1	391	1.02
-24	"	-	-	-	600	16	122	0.83	1-2	1,456	3.78
-25	"	-	-	-	-	0	-	2.80	2-3	393	1.02
-26	"	-	-	-	600	16	122	0.84	3-4	1,406	3.65
-27	"	-	-	-	600	16	122	0.78	4-5	1,461	3.80
-28	"	-	-	-	600	16	122	0.79	5-6	1,426	3.70
-29	"	0.80	0.0154	82.3	-	0	-	3.13	6-7	372	0.97
-30	A	0.80	0.0154	81.4	-	0	-	2.92	0-1	397	1.02
-31	"	-	-	-	610	8	Unknown	1.32	1-2	914	2.35
-32	"	0.80	0.0154	81.5	-	0	-	2.81	2-3	393	1.01
-33	"	-	-	-	610	8	Unknown	1.32	3-4	887	2.28
-34	"	-	-	-	610	8	Unknown	1.26	4-5	901	2.32
-35	"	0.80	0.0154	81.5	-	0	-	2.99	5-6	377	0.97
-36	A	0.80	0.0154	81.5	-	0	-	3.00	0-1	385	1.02
-37	"	-	-	-	610	12	Unknown	1.01	1-2	1,187	3.16
-38	"	0.80	0.0154	81.6	-	0	-	2.88	2-3	384	1.02
-39	"	-	-	-	610	12	Unknown	1.01	3-4	1,165	3.10
-40	"	-	-	-	610	12	Unknown	0.96	4-5	1,183	3.15
-41	"	0.80	0.0154	81.6	-	0	-	3.15	5-6	359	0.96
-42	A	0.80	0.0154	81.7	-	0	-	3.80	0-1	377	0.98
-43	"	-	-	-	660	4	121	3.17	1-2	379	0.99
-44	"	0.80	0.0154	81.7	-	0	-	2.88	2-3	384	1.00
-45	"	-	-	-	660	4	121	3.05	3-4	385	1.01
-46	"	0.80	0.0154	81.7	660	4	121	2.94	4-5	386	1.01
-47	"	-	-	-	-	0	-	2.90	5-6	388	1.01
-48	A	0.80	0.0154	81.7	-	0	-	2.99	0-1	387	1.01
-49	"	-	-	-	660	12	129	1.08	1-2	1,109	2.89
-50	"	0.80	0.0154	81.7	-	0	-	2.87	2-3	385	1.00
-51	"	-	-	-	660	12	129	1.09	3-4	1,076	2.80
-52	"	-	-	-	660	12	129	1.04	4-5	1,088	2.83
-53	"	0.80	0.0154	81.6	-	0	-	2.97	5-6	380	0.99
-54	A	-	-	-	660	16	131	0.88	0-1	1,314	3.55
-55	"	-	-	-	660	16	131	0.94	1-2	1,282	3.46
-56	"	0.80	0.0154	81.7	-	0	-	2.99	2-3	375	1.01
-57	"	-	-	-	-	0	-	3.21	3-4	366	0.99

Table 8. (cont.)

Run	Equipment Setup	Air Flow Manometer Inches of Water	Air Flow lb/ft <sup>2</sup> x sec.	Temp. °F.	Freq. cps	Volts to Sonic Driver	Sonic Intensity db	Time min.	Sections on Capillary Tube	Evaporation Rate 10 <sup>5</sup> x ml/min.	R/Ro
E61-202-58	A	-	-	-	-	0	-	2.94	0-1	394	1.00
-59	"	0.80	0.0154	81.2	1200	2	121	2.97	0-1	390	0.99
-60	A	-	-	-	1200	4	127	2.96	0-1	391	1.00
-61	"	0.80	0.0154	81.3	-	0	-	3.08	1-2	390	1.00
-62	"	-	-	-	-	0	-	2.82	2-3	392	1.00
-63	"	0.80	0.0154	81.4	1200	4	127	3.04	3-4	387	0.99
-64	"	-	-	-	1200	4	127	2.92	4-5	388	0.99
-65	A	0.80	0.0154	81.5	1200	6	129	3.00	0-1	387	1.01
-66	"	-	-	-	1200	6	129	3.12	1-2	386	1.01
-67	"	0.80	0.0154	81.6	-	0	-	2.88	2-3	383	1.00
-68	"	-	-	-	-	0	-	3.05	3-4	385	1.00
-69	A	-	-	-	1200	8	132	3.13	0-1	371	0.97
-70	"	0.80	0.0154	81.6	1200	8	132	3.24	1-2	371	0.97
-71	"	-	-	-	-	0	-	2.84	2-3	381	1.00
-72	"	-	-	-	-	0	-	3.06	3-4	383	1.00
E61-209- 1	B	0.80	0.0154	82.7	-	0	-	3.18	0-1	364	-
- 2	"	-	-	-	-	0	-	3.31	1-2	363	-
- 3	"	0.80	0.0154	82.7	-	0	-	3.03	2-3	364	-
- 4	"	-	-	-	-	0	-	3.20	3-4	367	-
- 5	"	0.80	0.0154	82.6	-	0	-	3.08	4-5	368	-
- 6	"	-	-	-	-	0	-	3.06	5-6	369	-
- 7	"	0.80	0.0154	82.6	-	0	-	3.16	6-7	369	-
- 8	"	0.81	0.0156	82.6	-	0	-	3.15	7-8	368	-
- 9	"	-	-	-	-	0	-	3.08	8-9	368	-
-10	B	0.81	0.0156	82.6	-	0	-	3.18	0-1	364	1.00
-11	"	-	-	-	600	5.5	112	3.31	1-2	364	1.00
-12	"	-	-	-	600	5.5	112	3.02	2-3	365	1.00
-13	"	0.80	0.0154	82.6	600	5.5	112	3.21	3-4	366	1.01
-14	"	-	-	-	-	0	-	3.12	4-5	364	1.00
-15	B	0.81	0.0156	82.7	-	0	-	3.16	0-1	367	1.00
-16	"	-	-	-	600	11.4	117	3.31	1-2	364	0.99
-17	"	-	-	-	600	11.4	117	3.03	2-3	364	0.99
-18	"	0.80	0.0154	82.6	600	11.4	117	3.20	3-4	367	1.00
-19	"	-	-	-	-	0	-	3.11	4-5	365	1.00
-20	B	0.80	0.0154	82.6	-	0	-	3.15	0-1	368	1.01
-21	"	-	-	-	600	17.55	120	3.29	1-2	365	1.00
-22	"	0.80	0.0154	82.6	600	17.55	120	3.04	2-3	363	0.99
-23	"	-	-	-	600	17.55	120	3.21	3-4	366	1.00
-24	"	0.81	0.0156	82.6	-	0	-	3.11	4-5	365	1.00
-25	"	-	-	-	-	0	-	3.08	5-6	366	1.00

Table 8. (concl.)

Run	Equipment Setup	Air Flow Manometer Inches of Water	P Air Flow lb/ft <sup>2</sup> x sec.	Temp. °F.	Freq. cps	Volts to Sonic Driver	Sonic Intensity db	Time min.	Sections on Capillary Tube	Evaporation Rate 10 <sup>5</sup> x ml/min.	R/Ro
E61-209-26	B	0.80	0.0154	82.7	-	0	-	3.14	0-1	369	1.00
-27	"	-	-	-	660	3.25	121	3.31	1-2	363	0.99
-28	"	-	-	-	660	3.25	121	3.02	2-3	365	0.99
-29	"	0.81	0.0156	82.7	660	3.25	121	3.20	3-4	367	1.00
-30	"	-	-	-	-	0	-	3.10	4-5	366	0.99
-31	B	0.81	0.0156	82.7	-	0	-	3.13	0-1	370	1.01
-32	"	-	-	-	660	8.95	129	3.29	1-2	365	0.99
-33	"	0.80	0.0154	82.7	660	8.95	129	3.00	2-3	367	1.00
-34	"	0.80	0.0154	82.7	660	8.95	129	3.20	3-4	367	1.00
-35	"	-	-	-	-	0	-	3.10	4-5	366	0.99
-36	B	0.80	0.0154	82.7	-	0	-	3.07	0-1	377	1.00
-37	"	-	-	-	-	0	-	3.21	1-2	374	0.99
-38	"	0.81	0.0156	82.7	660	11.15	131	2.93	2-3	376	1.00
-39	"	0.81	0.0156	-	660	11.15	131	3.11	3-4	377	1.00
-40	"	-	-	-	660	11.15	131	3.02	4-5	375	1.00
-41	B	0.80	0.0154	82.8	-	0	-	3.06	0-1	379	1.00
-42	"	-	-	-	1200	2.6	121	3.21	1-2	375	0.99
-43	"	0.80	0.0154	82.8	1200	2.6	121	2.94	2-3	375	0.99
-44	"	-	-	-	-	0	-	3.11	3-4	378	1.00
-45	B	0.81	0.0156	82.8	-	0	-	3.10	0-1	374	1.00
-46	"	-	-	-	1200	5.4	127	3.23	1-2	372	0.99
-47	"	0.80	0.0154	82.8	1200	5.4	127	2.95	2-3	373	1.00
-48	"	-	-	-	-	0	-	3.13	3-4	375	1.00
-49	B	0.80	0.0154	82.8	-	0	-	3.10	0-1	374	1.01
-50	"	-	-	-	1200	8.5	129	3.33	1-2	361	0.97
-51	"	0.80	0.0154	82.8	1200	8.5	129	3.06	2-3	361	0.97
-52	"	-	-	-	1200	8.5	129	3.24	3-4	362	0.97
-53	"	0.80	0.0154	82.9	-	0	-	3.03	4-5	374	1.01
-54	"	-	-	-	-	0	-	3.05	5-6	370	0.99
-55	"	-	-	-	-	0	-	3.14	6-7	370	0.99
-56	"	0.80	0.0154	82.9	1200	8.5	129	3.18	7-8	365	0.98
-57	"	-	-	-	1200	8.5	129	3.08	8-9	368	0.99

Table 9. Rates of evaporation for equipment setups C and D. Sonic driver SP-15.

Run	Equipment Setup	Air Flow Manometer Inches of Water	Air Flow lb/ft <sup>2</sup> x sec.	Temp. °F.	Freq. cps	Volts to Sonic Driver	Sonic Intensity db	Time min.	Sections on Capillary Tube	Evaporation Rate 10 <sup>5</sup> x ml/min.	R/R <sub>0</sub>
E62-203- 1	C	0.80	0.0154	84.5	-	0	-	2.58	0-1	449	1.01
- 2	"	-	-	-	-	0	-	2.75	1-2	438	0.99
- 3	"	-	-	-	-	0	-	2.48	2-3	446	1.01
- 4	"	-	-	-	1380	10	133.4	2.64	3-4	444	1.00
- 5	"	-	-	-	1380	10	133.4	2.58	4-5	441	1.00
- 6	"	-	-	-	-	0	-	2.56	5-6	441	1.00
- 7	"	0.80	0.0154	85.1	-	0	-	2.68	6-7	435	0.98
- 8	C	0.54	0.0119	84.7	-	0	-	2.88	0-1	403	1.00
- 9	"	-	-	-	1380	10	133.4	2.97	1-2	405	1.01
-10	"	-	-	-	-	0	-	2.76	2-3	400	1.00
-11	"	-	-	-	1380	10	133.4	2.85	3-4	412	1.03
-12	"	-	-	-	-	0	-	2.81	4-5	404	1.01
-13	"	-	-	-	1380	10	133.4	2.72	5-6	415	1.03
-14	"	-	-	-	-	0	-	2.90	6-7	401	1.00
-15	"	0.53	0.0118	84.9	1380	10	133.4	2.88	7-8	409	1.02
E62-204- 1	C	0.31	0.0082	82.3	-	0	-	3.54	0-1	327	1.01
- 2	"	-	-	-	-	0	-	3.75	1-2	321	0.99
- 3	"	-	-	-	-	0	-	3.42	2-3	323	1.00
- 4	C	0.31	0.0082	82.7	-	0	-	3.62	0-1	320	0.99
- 5	"	-	-	-	570	13	133.3	3.52	1-2	342	1.06
- 6	"	-	-	-	-	0	-	3.42	2-3	322	1.00
- 7	"	-	-	-	570	11	132.0	3.27	3-4	359	1.11
- 8	"	0.31	0.0082	82.9	-	0	-	3.52	4-5	322	1.00
- 9	"	-	-	-	570	11	132.0	3.10	5-6	364	1.13
-10	"	-	-	-	-	0	-	3.60	6-7	323	1.00
-11	"	-	-	-	570	10	131.3	3.34	7-8	348	1.08
-12	"	0.32	0.0084	83.0	570	10	131.3	3.15	8-9	360	1.12
-13	C	0.32	0.0084	83.0	-	0	-	3.48	0-1	334	1.01
-14	"	-	-	-	1320	10	133.3	3.52	1-2	343	1.04
-15	"	-	-	-	-	0	-	3.38	2-3	327	0.99
-16	"	-	-	-	1320	10	133.3	3.41	3-4	344	1.04
-17	"	0.32	0.0084	-	-	0	-	3.46	4-5	329	1.00
-18	"	-	-	-	1320	10	133.3	3.24	5-6	347	1.05
-19	"	0.32	0.0084	83.2	-	0	-	3.55	6-7	328	0.99
-20	"	-	-	-	1320	10	133.3	3.31	7-8	350	1.06
-21	"	0.32	0.0084	83.3	1320	10	133.3	3.27	8-9	347	1.05

Table 9. (cont.)

Run	Equipment Setup	Air Flow Manometer P Inches of Water	Air Flow lb/ft <sup>2</sup> x sec.	Temp. °F.	Freq. cps	Volts to Sonic Driver	Sonic Intensity db	Time min.	Sections on Capillary Tube	Evaporation Rate 10 <sup>5</sup> x ml/min.	R/Ro
E62-204-22	C	0.32	0.0084	83.5	-	0	-	3.58	0-1	323	1.00
-23	"	-	-	-	1380	10	133.4	3.27	1-2	368	1.14
-24	"	-	-	-	-	0	-	3.42	2-3	323	1.00
-25	"	-	-	-	1380	10	133.4	3.15	3-4	373	1.16
-26	"	-	-	-	1380	10	133.4	2.97	4-5	382	1.18
-27	"	-	-	-	1380	10	133.4	3.07	5-6	367	1.14
-28	"	-	-	-	1380	10	133.4	3.14	6-7	370	1.15
-29	"	-	-	83.6	-	0	-	3.59	7-8	323	1.00
-30	"	0.32	0.0084	-	1380	10	133.4	3.10	8-9	366	1.13
-31	C	0.32	0.0084	83.8	-	0	-	3.59	0-1	323	0.99
-32	"	-	-	-	1440	10	134.5	3.22	1-2	374	1.15
-33	"	-	-	-	-	0	-	3.83	2-3	326	1.00
-34	"	-	-	-	1440	10	134.5	3.02	3-4	389	1.20
-35	"	-	-	-	1440	10	134.5	3.00	4-5	378	1.16
-36	"	0.32	0.0084	83.9	1440	9	133.8	3.12	5-6	362	1.11
-37	"	-	-	-	1440	9	133.8	3.26	6-7	356	1.10
-38	"	-	-	-	1440	9	133.8	3.21	7-8	361	1.11
-39	"	0.32	0.0084	83.7	-	0	-	3.47	8-9	327	1.01
-40	C	0.32	0.0084	83.6	-	0	-	3.58	0-1	324	1.00
-41	"	-	-	-	1680	8	134.2	3.74	1-2	321	0.99
-42	"	-	-	-	1680	8	134.2	3.41	2-3	323	1.00
-43	"	0.32	0.0084	83.5	-	0	-	3.61	3-4	325	1.01
-44	"	-	-	-	1680	8	134.2	3.55	4-5	320	0.99
-45	"	-	-	-	1680	8	134.2	3.51	5-6	321	0.99
-46	"	-	-	-	1680	8	134.2	3.66	6-7	317	0.98
-47	"	0.32	0.0084	83.5	-	0	-	3.60	7-8	322	1.00
-48	"	0.32	0.0084	-	-	0	-	3.52	8-9	322	1.00
-49	C	0.32	0.0084	83.5	-	0	-	3.58	0-1	324	1.01
-50	"	-	-	-	1800	8	134.9-137.2	3.80	1-2	317	0.99
-51	"	-	-	-	1800	8	134.9-137.2	3.47	2-3	309	0.96
-52	"	0.32	0.00	83.5	1800	8	134.9-137.2	3.69	3-4	320	1.00
-53	"	-	-	-	1800	8	134.9-137.2	3.57	4-5	318	0.99
-54	"	-	-	-	1800	8	134.9-137.2	3.54	5-6	318	0.99
-55	"	-	-	83.4	-	0	-	3.66	6-7	318	0.99
-56	"	0.32	0.0084	-	-	0	-	3.62	7-8	321	1.00
-57	"	-	-	-	-	0	-	3.55	8-9	320	1.00

Table 9. (cont.)

Run	Equipment Setup	Air Flow Manometer P Inches of Water	Air Flow lb/ft <sup>2</sup> x sec.	Temp. °F.	Freq. cps	Volts to Sonic Driver	Sonic Intensity db	Time min.	Sections on Capillary Tube	Evaporation Rate 10 <sup>5</sup> x ml/min.	R/Re
#62-204-58	C	0.32	0.0084	82.2	-	0	-	3.75	0-1	309	1.05
-59	"	-	-	-	330	10	131.8	1.33	1-2	907	3.08
-60	"	-	-	-	330	10	131.8	1.22	2-3	907	3.08
-61	"	-	-	-	330	13	133.8	1.40	3-4	839	2.94
-62	"	-	-	-	330	13	133.8	1.39	4-5	817	2.77
-63	"	-	-	-	330	15	135.0	1.86	5-6	606	2.06
-64	"	-	-	-	330	15	135.0	1.91	6-7	610	2.07
-65	"	0.32	0.0084	82.5	-	0	-	4.07	7-8	285	0.97
-66	"	0.32	0.0084	82.7	-	0	-	3.89	8-9	292	0.99
-67	C	0.32	0.0084	83.1	-	0	-	3.89	0-1	298	0.99
-68	"	-	-	-	600	8	125.5-128.9	3.05	1-2	394	1.31
-69	"	-	-	-	600	8	125.5-128.9	2.73	2-3	404	1.35
-70	"	-	-	83.1	600	12	128.9-132.2	2.20	3-4	534	1.78
-71	"	-	-	-	600	12	128.9-132.2	2.19	4-5	518	1.73
-72	"	-	-	-	600	14	130.1-133.5	1.79	5-6	630	2.10
-73	"	-	-	-	600	14	130.1-133.5	1.86	6-7	625	2.08
-74	"	0.32	0.0084	83.5	-	0	-	3.88	7-8	299	1.00
-75	"	-	-	-	-	0	-	3.75	8-9	303	1.01
-76	C	0.54	0.0119	83.0	-	0	-	3.10	0-1	374	1.02
-77	"	-	-	-	1800	8	134.9-137.2	3.30	1-2	365	1.00
-78	"	0.54	0.0119	-	1800	8	134.9-137.2	3.06	2-3	361	0.99
-79	"	-	-	-	1800	8	134.9-137.2	3.25	3-4	361	0.99
-80	"	-	-	-	-	0	-	3.13	4-5	362	0.99
-81	"	-	-	-	-	0	-	3.10	5-6	362	0.99
-82	"	-	-	-	-	0	-	3.20	6-7	363	0.99
-83	"	-	-	-	1800	8	134.9-137.2	3.28	7-8	354	0.97
-84	"	-	-	-	1800	8	134.9-137.2	3.15	8-9	360	0.99
-85	C	0.54	0.0119	83.5	-	0	-	3.15	0-1	368	1.00
-86	"	-	-	-	-	0	-	3.31	1-2	364	0.99
-87	"	-	-	-	1440	10	134.5	2.80	2-3	395	1.07
-88	"	-	-	-	1440	10	134.5	2.95	3-4	398	1.08
-89	"	0.54	0.0119	83.5	-	0	-	6.08	4-6	373	1.01
-90	"	-	-	-	1440	10	134.5	2.95	6-7	394	1.07
-91	"	-	-	-	1440	10	134.5	2.87	7-8	404	1.10
-92	"	0.54	0.0119	83.5	1440	10	134.5	2.82	8-9	402	1.09



Table 9. (cont.)

Run	Equipment Setup	Air Flow Manometer Inches of Water	P	Air Flow lb/ft <sup>2</sup> x sec.	Temp. °F.	Freq. cps	Volts to Sonic Driver	Sonic Intensity db	Time min.	Sections on Capillary Tube	Evaporation Rate 10 <sup>5</sup> x ml/min.	R/Ro
E62-204-93	C	0.93		0.0169	83.1	1800	8	134.9-137.2	2.79	0-1	415	1.01
-94	"	0.93		0.0169	-	1800	8	134.9-137.2	2.93	1-2	412	1.00
-95	"	-		-	83.1	1800	8	134.9-137.2	2.67	2-3	414	1.01
-96	"	0.93		0.0169	-	-	0	-	2.84	3-4	413	1.00
-97	"	-		-	-	-	0	-	2.76	4-5	412	1.00
-98	"	0.93		0.0169	-	1440	10	134.5	2.70	5-6	418	1.01
-99	"	-		-	83.1	1440	10	134.5	2.80	6-7	417	1.01
-100	"	-		-	-	1440	10	134.5	2.74	7-8	424	1.03
-101	"	0.94		0.0170	83.1	-	0	-	2.76	8-9	412	1.00
-102	C	0.93		0.0169	83.2	330	10	131.8	1.25	0-1	924	2.38
-103	"	0.92		0.0168	83.2	330	10	131.8	1.34	1-2	902	2.32
-104	"	0.92		0.0168	-	330	15	135.0	1.68	2-3	657	1.70
-105	"	0.92		0.0168	-	330	15	135.0	1.60	3-4	733	1.89
-106	"	0.92		0.0168	83.3	-	-	-	2.93	4-5	387	1.00
-107	"	0.93		0.0169	-	600	-	125.5-128.9	2.53	5-6	445	1.15
-108	"	0.93		0.0169	83.3	600	-	125.5-128.9	2.59	6-7	449	1.16
-109	"	-		-	-	600	-	130.1-133.5	1.76	7-8	659	1.70
-110	"	0.93		0.0169	-	600	-	130.1-133.5	1.71	8-9	664	1.71
E62-205- 1	D	-		-	82.5	-	0	-	3.40	0-1	341	1.01
- 2	"	-		-	82.6	-	0	-	3.57	1-2	337	0.99
- 3	"	0.32		0.0084	-	1440	8	136.4	3.08	2-3	359	1.06
- 4	"	-		-	-	1440	8	136.4	3.26	3-4	361	1.06
- 5	"	-		-	-	1440	8	136.4	3.15	4-5	361	1.06
- 6	"	-		-	-	-	0	-	3.31	5-6	340	1.00
- 7	"	-		-	-	1380	10	132.6	3.39	6-7	343	1.01
- 8	"	0.33		0.0086	82.7	1380	10	132.6	3.34	7-8	347	1.02
- 9	"	0.33		0.0086	-	1380	10	132.6	3.29	8-9	345	1.02
E62-206- 1	D	0.31		0.0062	82.3	-	0	-	3.59	0-1	323	0.99
- 2	"	-		-	-	330	10	130.8	3.59	1-2	335	1.03
- 3	"	0.31		0.0062	82.4	330	10	130.8	3.17	2-3	348	1.07
- 4	"	-		-	-	-	0	-	3.60	3-4	326	1.00
- 5	"	-		-	-	330	13	132.8	2.99	4-5	379	1.17
- 6	"	0.31		0.0082	82.7	330	13	132.8	2.91	5-6	388	1.19
- 7	"	0.32		0.0064	82.8	-	0	-	3.55	6-7	328	1.01
- 8	"	-		-	-	330	16	134.5	2.75	7-8	422	1.30
- 9	"	0.31		0.0062	82.9	330	16	134.5	2.60	8-9	437	1.34

Table 9. (cont.)

Run	Equipment Setup	Air Flow Manometer Inches of water	Air Flow P lb/ft <sup>2</sup> x sec.	Temp. °F.	Freq. cps	Volts to Sonic Driver	Sonic Intensity db	Time min.	Sections on Capillary Tube	Evaporation Rate 10 <sup>5</sup> x ml/min.	R/Ro
E62-206-10	D	0.32	0.0084	83.0	570	9	130.4	3.52	0-1	329	0.98
-11	"	-	-	-	570	9	130.4	3.69	1-2	326	0.97
-12	"	0.32	0.0084	83.0	-	0	-	3.30	2-3	334	1.00
-13	"	-	-	-	570	12	132.6	3.52	3-4	333	0.99
-14	"	-	-	-	570	12	132.6	3.40	4-5	333	0.99
-15	"	0.32	0.0084	83.0	-	0	-	6.81	5-7	336	1.00
-16	"	-	-	-	570	14	133.8	3.60	7-8	322	0.96
-17	"	0.32	0.0084	83.0	570	14	133.8	3.38	8-9	336	1.00
-18	D	0.32	0.0084	82.6	600	5	125.0	3.62	0-1	320	0.95
-19	"	-	-	-	600	5	125.0	3.72	1-2	323	0.96
-20	"	-	-	-	-	0	-	3.28	2-3	337	1.00
-21	"	-	-	-	600	8	128.8	3.50	3-4	315	0.93
-22	"	0.32	0.0084	82.6	600	8	128.8	3.28	4-5	346	0.94
-23	"	-	-	-	600	12	132.1	2.59	5-6	435	1.29
-24	"	-	-	-	600	12	132.1	2.76	6-7	423	1.26
-25	"	-	-	-	600	14	133.3	2.54	7-8	456	1.35
-26	"	0.32	0.0084	82.6	600	14	133.3	2.49	8-9	456	1.35
-27	D	0.32	0.0084	82.7	600	6	126.5	3.75	0-1	309	0.91
-28	"	-	-	-	600	6	126.5	3.93	1-2	306	0.90
-29	"	0.32	0.0084	82.7	-	0	-	3.30	2-3	335	0.99
-30	"	-	-	-	-	0	-	3.50	3-4	335	0.99
-31	"	0.32	0.0084	82.7	600	6	126.5	3.70	4-5	307	0.91
-32	"	-	-	-	600	6	126.5	3.55	5-6	317	0.91
-33	"	0.32	0.0084	82.7	600	6	126.5	3.75	6-7	310	0.92
-34	"	-	-	-	-	0	-	3.42	7-8	339	1.00
-35	"	0.32	0.0084	82.7	-	0	-	3.32	8-9	342	1.01
-36	D	0.32	0.0084	82.6	1320	6	130.7	3.51	0-1	330	1.00
-37	"	-	-	-	1320	6	130.7	3.67	1-2	328	1.00
-38	"	-	-	-	-	0	-	3.34	2-3	331	1.01
-39	"	-	-	-	1320	7.5	132.5	3.56	3-4	330	1.00
-40	"	-	-	-	1320	7.5	132.5	3.47	4-5	327	0.99
-41	"	0.32	0.0084	82.5	-	0	-	3.43	5-6	329	1.00
-42	"	-	-	-	1320	9	133.9	3.55	6-7	328	1.00
-43	"	-	-	-	1320	9	133.9	3.53	7-8	329	1.00
-44	"	0.32	0.0084	82.5	-	0	-	3.48	8-9	326	0.99

Table 9. (cont.)

Run	Equipment Setup	Air Flow Manometer P Inches of Water	Air Flow lb/ft <sup>2</sup> x sec.	Temp. °F.	Freq. cps	Volts to Sonic Driver	Sonic Intensity db	Time min.	Sections on Capillary Tube	Evaporation Rate 10 <sup>5</sup> x ml/min.	R/R <sub>0</sub>
E62-206-45	D	-	-	-	1380	8	130.9	3.46	0-1	335	1.04
-46	"	0.32	0.0084	82.4	1380	8	130.9	3.64	1-2	331	1.02
-47	"	-	-	-	-	0	-	3.42	2-3	323	1.00
-48	"	-	-	-	1380	10	132.6	3.45	3-4	340	1.05
-49	"	0.32	0.0084	82.4	1380	10	132.6	3.36	4-5	338	1.05
-50	"	-	-	-	-	0	-	3.49	5-6	323	1.00
-51	"	0.31	0.0082	82.4	1500	10	137.6	3.61	6-7	322	1.00
-52	"	0.32	0.0084	82.4	1500	10	137.6	3.58	7-8	324	1.00
-53	"	-	-	-	1500	10	137.6	3.50	8-9	325	1.01
-54	D	0.30	0.0080	82.4	1440	5	133.4	3.57	0-1	325	1.01
-55	"	0.30	0.0080	-	1440	5	133.4	3.74	1-2	322	1.00
-56	"	0.31	0.0082	-	-	0	-	3.44	2-3	321	1.00
-57	"	0.31	0.0082	-	1440	7	135.5	3.53	3-4	333	1.04
-58	"	0.31	0.0082	82.4	1440	7	135.5	3.40	4-5	334	1.04
-59	"	0.31	0.0082	-	-	0	-	3.51	5-6	321	1.00
-60	"	0.31	0.0082	82.4	1440	10	137.8	3.33	6-7	349	1.09
-61	"	0.31	0.0082	-	1440	10	137.8	3.36	7-8	345	1.07
-62	"	-	-	-	-	0	-	3.53	8-9	322	1.00
-63	C	0.33	0.0086	82.5	330	10	131.8	1.60	0-1	724	2.43
-64	"	0.31	0.0082	82.5	330	10	131.8	1.68	1-2	717	2.40
-65	"	0.32	0.0084	82.5	-	0	-	3.69	2-3	299	1.00
-66	"	0.32	0.0084	-	330	15	135.0	1.87	3-4	627	2.10
-67	"	0.32	0.0084	-	330	15	135.0	1.77	4-5	640	2.15
-68	"	0.32	0.0084	-	-	0	-	3.80	5-6	297	1.00
-69	"	-	-	-	1380	10	133.4	3.81	6-7	305	1.02
-70	"	-	-	-	1380	10	133.4	3.77	7-8	307	1.03
-71	"	0.32	0.0084	82.5	1380	10	133.4	3.66	8-9	311	1.04
-72	C	0.33	0.0086	81.9	600	8	125.5-128.9	3.02	0-1	384	1.28
-73	"	-	-	-	600	8	125.5-128.9	3.21	1-2	375	1.25
-74	"	0.32	0.0084	81.9	-	0	-	3.64	2-3	303	1.01
-75	"	-	-	-	600	14	130.1-133.5	2.02	3-4	580	1.93
-76	"	0.32	0.0084	-	600	14	130.1-133.5	1.98	4-5	572	1.91
-77	"	-	-	-	-	0	-	3.77	5-6	299	1.00
-78	"	0.33	0.0086	81.8	1800	8	134.9-137.2	3.93	6-7	296	0.99
-79	"	-	-	-	1800	8	134.9-137.2	3.91	7-8	297	0.99
-80	"	0.33	0.0086	-	-	0	-	3.80	8-9	299	1.00

Table 9. (cont.)

Run	Equipment Setup	Air Flow Manometer Inches of Water	Air Flow lb/ft <sup>2</sup> x sec.	Temp. °F.	Freq. cps	Volts to Sonic Driver	Sonic Intensity db	Time min.	Sections on Capillary Tube	Evaporation Rate 10 <sup>5</sup> x ml/min.	R/R <sub>0</sub>
E62-209- 1	C	0.32	0.0084	82.6	330	8	130.1	2.68	0-1	433	1.34
- 2	"	-	-	-	330	8	130.1	2.80	1-2	430	1.33
- 3	"	0.31	0.0082	82.7	-	0	-	3.36	2-3	329	1.02
- 4	"	-	-	-	330	10	131.8	1.64	3-4	718	2.23
- 5	"	-	-	-	330	12	133.2	1.75	4-5	648	2.01
- 6	"	0.31	0.0082	-	330	12	133.2	1.74	5-6	646	2.01
- 7	"	0.32	0.0084	82.9	-	0	-	3.69	6-7	315	0.98
- 8	"	-	-	-	330	15	135.0	1.81	7-8	642	1.99
- 9	"	-	-	-	330	15	135.0	1.84	8-9	617	1.92
-10	C	0.32	0.0084	83.3	330	10	131.8	1.65	0-1	703	2.20
-11	"	-	-	-	330	10	131.8	1.74	1-2	692	2.17
-12	"	0.31	0.0082	-	-	0	-	3.46	2-3	319	1.00
-13	"	0.31	0.0082	83.4	330	12	133.2	1.81	3-4	649	2.03
-14	"	0.31	0.0082	-	330	12	133.2	1.76	4-5	647	2.02
-15	"	-	-	-	330	13	133.8	1.68	5-6	672	2.10
-16	"	-	-	-	330	13	133.8	1.78	6-7	652	2.04
-17	"	0.31	0.0082	83.4	330	15	135.0	1.84	7-8	629	1.97
-18	"	-	-	-	330	15	135.0	1.78	8-9	638	2.00
-19	C	0.32	0.0084	83.4	600	8	125.5-128.9	3.13	0-1	365	1.11
-20	"	-	-	-	600	8	125.5-128.9	3.30	1-2	365	1.11
-21	"	0.30	0.0080	83.4	-	0	-	3.35	2-3	329	1.00
-22	"	-	-	-	600	12	128.9-132.2	2.34	3-4	501	1.52
-23	"	-	-	-	600	12	128.9-132.2	2.31	4-5	491	1.49
-24	"	0.31	0.0082	83.4	-	0	-	3.41	5-6	331	1.00
-25	"	0.31	0.0082	83.4	-	0	-	3.52	6-7	330	1.00
-26	"	-	-	-	600	14	130.1-133.5	1.89	7-8	614	1.86
-27	"	0.30	0.0080	-	600	14	130.1-133.5	1.83	8-9	619	1.88
-28	C	0.31	0.0082	83.4	570	13	133.3	3.24	0-1	358	1.09
-29	"	-	-	-	570	13	133.3	3.40	1-2	353	1.07
-30	"	-	-	-	-	0	-	3.40	2-3	325	0.98
-31	"	0.31	0.0082	83.4	1380	8	131.3	3.47	3-4	339	1.03
-32	"	-	-	-	1380	8	131.3	3.33	4-5	341	1.03
-33	"	0.31	0.0082	-	-	0	-	3.40	5-6	332	1.01
-34	"	0.31	0.0082	83.4	1380	10	133.4	3.27	6-7	356	1.08
-35	"	-	-	-	1380	10	133.4	3.21	7-8	361	1.09
-36	"	0.32	0.0084	83.4	-	0	-	3.40	8-9	334	1.01

Table 9. (cont.)

Run	Equipment Setup	Air Flow Manometer P Inches of Water	Air Flow lb/ft <sup>2</sup> x sec.	Temp. °F.	Freq. cps	Volts to Sonic Driver	Sonic Intensity db	Time min.	Sections on Capillary Tube	Evaporation Rate 10 <sup>5</sup> x ml/min.	R/Ro
E62-209-37	D	0.32	0.0084	82.5	330	10	130.8	3.51	0-1	330	1.02
-38	"	0.31	0.0082	82.6	330	10	130.8	3.60	1-2	335	1.03
-39	"	0.31	0.0082	-	-	0	-	3.42	2-3	323	1.00
-40	"	0.30	0.0080	82.7	330	13	132.8	3.24	3-4	362	1.12
-41	"	-	-	-	330	13	132.8	3.00	4-5	378	1.17
-42	"	0.31	0.0082	82.7	-	0	-	3.46	5-6	326	1.01
-43	"	0.31	0.0082	-	330	16	134.5	2.89	6-7	403	1.24
-44	"	0.31	0.0082	82.7	330	16	134.5	3.05	7-8	380	1.17
-45	"	-	-	-	330	16	134.5	3.02	8-9	375	1.16
-46	D	0.31	0.0082	82.8	600	4	123.2	3.55	0-1	326	1.02
-47	"	0.32	0.0084	-	600	4	123.2	3.87	1-2	311	0.97
-48	"	-	-	82.8	-	0	-	3.44	2-3	321	1.00
-49	"	0.31	0.0082	-	600	8	128.8	3.62	3-4	324	1.01
-50	"	-	-	-	600	8	128.8	3.62	4-5	313	0.98
-51	"	-	-	-	600	12	132.1	2.96	5-6	395	1.23
-52	"	0.31	0.0082	82.9	600	12	132.1	2.93	6-7	397	1.24
-53	"	-	-	-	600	14	133.3	2.71	7-8	428	1.33
-54	"	-	-	-	600	14	133.3	2.70	8-9	421	1.31
-55	D	0.32	0.0082	83.0	570	11	131.9	3.69	0-1	314	1.00
-56	"	-	-	-	570	11	131.9	3.83	1-2	310	0.99
-57	"	0.31	0.0082	83.2	570	14	133.8	3.55	2-3	311	0.99
-58	"	0.31	0.0082	-	570	14	133.8	3.74	3-4	314	1.00
-59	"	-	-	-	-	0	-	3.62	4-5	313	1.00
-60	"	0.32	0.0084	83.2	1380	8	130.9	3.44	5-6	327	1.04
-61	"	-	-	-	1380	10	132.6	3.53	6-7	329	1.05
-62	"	-	-	-	1380	10	132.6	3.54	7-8	328	1.04
-63	"	0.31	0.0082	83.2	-	0	-	3.62	8-9	314	1.00
-64	C	0.32	0.0084	82.2	330	8	130.1	1.61	0-1	719	2.33
-65	"	-	-	-	330	8	130.1	1.74	1-2	692	2.29
-66	"	0.32	0.0084	82.2	-	0	-	3.65	2-3	303	1.00
-67	"	-	-	-	330	12	133.2	1.89	3-4	621	2.05
-68	"	0.32	0.0084	82.3	330	12	133.2	1.74	4-5	651	2.15
-69	"	-	-	-	-	0	-	3.74	5-6	301	1.00
-70	"	0.32	0.0084	82.4	330	15	135.0	2.24	6-7	520	1.72
-71	"	-	-	-	330	15	135.0	2.14	7-8	542	1.79

Table 9. (cont.)

Run	Equipment Setup	Air Flow Manometer Inches of Water	Air Flow lb/ft <sup>2</sup> x sec.	Temp. °F.	Freq. cps	Volts to Sonic Driver	Sonic Intensity db	Time min.	Sections on Capillary Tube	Evaporation Rate 10 <sup>5</sup> x ml/min.	R/Ro
E62-209-72	C	0.32	0.0084	82.6	600	8	125.5-128.9	3.01	0-1	385	1.27
-73	"	0.32	0.0084	-	600	8	125.5-128.9	3.20	1-2	376	1.24
-74	"	-	-	-	-	0	-	3.66	2-3	302	1.00
-75	"	-	-	-	600	12	128.9-132.2	2.28	3-4	517	1.71
-76	"	0.32	0.0084	82.7	600	12	128.9-132.2	2.26	4-5	502	1.66
-77	"	0.32	0.0084	-	-	0	-	3.75	5-6	301	1.00
-78	"	-	-	-	600	14	130.1-133.5	1.89	6-7	616	2.04
-79	"	0.32	0.0084	-	600	14	130.1-133.5	1.91	7-8	608	2.01
-80	C	0.32	0.0084	82.8	570	13	133.3	3.69	0-1	314	1.03
-81	"	-	-	-	570	13	133.3	3.78	1-2	319	1.05
-82	"	0.33	0.0086	82.9	0	0	-	3.67	2-3	301	0.99
-83	"	-	-	-	1380	8	131.3	3.99	3-4	294	0.96
-84	"	-	-	-	1380	8	131.3	3.96	4-5	287	0.94
-85	"	-	-	-	-	0	-	3.66	5-6	308	1.01
-86	"	0.32	0.0084	83.0	1380	10	133.4	3.93	6-7	296	0.97
-87	"	-	-	-	1380	10	133.4	3.81	7-8	304	1.00
-88	"	0.31	0.0082	83.1	-	0	-	3.70	8-9	307	1.01
-89	D	0.31	0.0082	81.0	330	10	130.8	3.65	0-1	317	1.04
-90	"	0.31	0.0082	-	330	10	130.8	3.76	1-2	320	1.05
-91	"	-	-	81.1	-	0	-	3.59	2-3	307	1.01
-92	"	0.31	0.0082	-	330	13	132.8	3.29	3-4	357	1.17
-93	"	0.32	0.0084	81.2	330	13	132.8	3.18	4-5	357	1.17
-94	"	-	-	81.4	330	0	-	3.75	5-6	301	0.99
-95	"	0.31	0.0082	81.4	330	16	134.5	3.08	6-7	377	1.24
-96	"	-	-	-	330	16	134.5	2.94	7-8	394	1.30
-97	D	0.31	0.0082	81.4	600	4	123.2	3.91	0-1	297	1.00
-98	"	-	-	-	-	0	-	4.08	1-2	295	1.00
-99	"	0.32	0.0084	81.7	600	8	128.8	3.10	2-3	356	1.20
-100	"	-	-	-	600	8	128.8	3.32	3-4	354	1.20
-101	"	0.33	0.0086	81.8	600	12	132.1	2.85	4-5	398	1.35
-102	"	-	-	-	600	12	132.1	2.83	5-6	398	1.35
-103	"	0.32	0.0084	81.9	-	0	-	3.92	6-7	297	1.00
-104	"	0.32	0.0084	81.9	600	14	133.3	2.73	7-8	425	1.44
-105	"	-	-	-	600	14	133.3	2.64	8-9	420	1.42

Table 9. (concl.)

Run	Equipment Setup	Air Flow Manometer P Inches of Water	Air Flow lb/ft <sup>2</sup> x sec.	Temp. °F.	Freq. cps	Volts to Sonic Driver	Sonic Intensity db	Time min.	Sections on Capillary Tube	Evaporation Rate 10 <sup>5</sup> x ml/min.	R/Ro
E62-209-106	D	0.32	0.0084	82.1	570	11	131.9	3.86	0-1	300	1.02
-107	"	-	-	-	-	0	-	4.08	1-2	295	1.00
-108	"	0.32	0.0084	82.2	570	14	133.8	3.67	2-3	301	1.02
-109	"	-	-	-	570	14	133.8	3.87	3-4	304	1.03
-110	"	0.32	0.0084	82.2	1380	8	130.9	3.62	4-5	314	1.06
-111	"	-	-	-	1380	8	130.9	3.57	5-6	316	1.07
-112	"	0.32	0.0084	82.3	-	0	-	3.95	6-7	295	1.00
-113	"	-	-	-	1380	10	132.6	3.60	7-8	322	1.09
-114	"	0.32	0.0084	82.4	1380	10	132.6	3.57	8-9	318	1.08

Table 10. Predictions and results of evaporation runs for equipment setups C and D. Based on constant frequency and constant sonic intensity.

Freq. cps	Prediction From * Smoke Observations			Result of Evaporation Runs From Inspection of Graphs
330	$(R/Ro)_C$	$(R/Ro)_D$	1	As predicted.
570	$(R/Ro)_C$	$(R/Ro)_D$	1	As predicted.
600	$(R/Ro)_C$	$(R/Ro)_D$	1	As predicted except that $(R/Ro)_D$ 1 at lower sonic intensities.
1380	$(R/Ro)_C$	$(R/Ro)_D$	1	Too much scatter to observe difference in $(R/Ro)_C$ and $(R/Ro)_D$ .  Also $(R/Ro)_D$ 1.04 1 .
1440	$(R/Ro)_C$	$(R/Ro)_D$	1	$(R/Ro)_C$ $(R/Ro)_D$ as predicted but $(R/Ro)_D$ 1 as sonic intensity increases.
1320	$(R/Ro)_C$	$(R/Ro)_D$	1	As predicted.
1500	$(R/Ro)_D$	1		As predicted.
1680	$(R/Ro)_C$	1		As predicted.
1800	$(R/Ro)_C$	1		As predicted.

\* Subscript denotes equipment setup. Based on 0.32 inches of water on air flow manometer.



Table 11. Predictions and results of evaporation runs for equipment setups C and D. Both frequency and sonic intensity vary.

Equipment Setup	C	C	D	D	C	C	C	C	D	D	D	D		
Frequency, cps	330	600	330	600	1380	570	1440	1320	570	1380	1440	1320		
Volts to Sonic Driver	14.3	14.0	16.5	9.5-14.6	10.0	14.0	10.0	10.0	14.4	11.1	5.9	8.3		
Sonic Intensity, db	134.6	130.1-133.5	134.6	130.1-133.5	133.4	134.0	134.5	133.3	134.0	133.4	134.5	133.3		
R/Ro Predictions at Above Conditions Based on Smoke Observations	R/Ro	R/Ro	R/Ro	R/Ro	R/Ro	R/Ro	R/Ro	R/Ro	R/Ro	R/Ro	R/Ro	R/Ro	R/Ro	1
R/Ro Results from Plots of Evaporation Rate Data	2.0	2.0	1.25	1.1-1.4	1.06	1.07	1.15	1.05	1.00	1.05	1.02	1.00		

Notes:

Since little if any streaming was observed at 1500, 1680, and 1800 cps, these frequencies would have predicted values of R/Ro = 1 which agree with the results of the evaporation runs.

All R/Ro values at 0.32 inches water on air flow manometer.

The db values are from Figures 10 to 15 at the voltages given above.

EFFECT OF SONIC PULSES ON  
RATE OF EVAPORATION

by

WILLIAM HENRY BUCKHANNAN

B. S., Kansas State University, 1955

---

AN ABSTRACT OF A THESIS

submitted in partial fulfillment of the

requirements for the degree

MASTER OF SCIENCE

Department of Chemical Engineering

KANSAS STATE UNIVERSITY  
Manhattan, Kansas

1966

## ABSTRACT

The objectives of this study were to improve the understanding of the mechanism by which the application of sonic pulses had been demonstrated to affect rates of evaporation and to determine what quantitative relationships might exist between operating variables and evaporation rates. The particular system used in this study was the evaporation of water from a flat surface of frittered glass into a slowly moving air stream which flowed over the evaporative surface. Sonic pulses were directed along the normal to the evaporative surface.

The effects of the sonic pulses ranged from reductions in evaporation rates of several percent to over two hundred percent increases. Variation of the operating conditions and of the experimental setup indicated virtually any value in this range of alteration of evaporation rates could be produced by proper specification of these variables. The usual direction of change was an increase.

Streaming was indicated to be the principal mechanism by which the application of sonic pulses increased evaporation rates. Streaming is a steady flow generated by an interaction between the sonic pulses and the transmitting fluid or between these and the solid boundaries in the system (16). Streaming flow was studied by observations of smoke patterns in the transmitting fluid, air. Consideration of these observations and data on evaporation rates led to the conclusion that streaming in the vicinity of the evaporative surface was responsible for the increases in evaporation rates caused by the application of sonic pulses. Increases in evaporation rates generally became larger as the intensity of the streaming flow increased.

The operating variables and their effect on the generation of streaming in the vicinity of the evaporative surface were not completely defined. Streaming intensity increased as sonic intensity increased for a given experimental setup and sonic frequency. Both the experimental setup and sonic frequency were observed to be critical factors in determining the intensity of the streaming in the vicinity of the evaporative surface. The pertinent differences between the experimental setups were in the geometry of the tunnel system or enclosure.

The results of this work were compared to the results obtained by previous investigators, Cheuh (3) and Nichols (4). While the latter's results are fairly consistent with the present study, Cheuh's failure to detect streaming does not seem consistent with the increases in evaporation rates that he observed.

Further study of the effects of sonic pulses might be expedited by more detailed consideration of the streaming phenomena.