

**ULTRASONIC VIBRATION-ASSISTED PELLETING OF CELLULOSIC  
BIOMASS FOR ETHANOL MANUFACTURING**

BY

PENGFEI ZHANG

B.S., Beijing Institute of Technology, 2002  
M.S., Beijing Institute of Technology, 2005

AN ABSTRACT OF A DISSERTATION

submitted in partial fulfillment of the requirements for the degree

DOCTOR OF PHILOSOPHY

Department of Industrial and Manufacturing Systems Engineering  
College of Engineering

KANSAS STATE UNIVERSITY  
Manhattan, Kansas

2011

## **Abstract**

Both the U.S. and world economies have been depending on petroleum based liquid transportation fuels (such as gasoline, diesel, and jet fuels), which are finite and nonrenewable energy sources. Increasing demands and concerns for the reliable supply of liquid transportation fuels make it important to find alternative sources to petroleum based fuels. One such alternative is cellulosic ethanol. Research, development, and production of cellulosic ethanol have received significant support from both the U.S. government and private investors. However, several technical barriers have hindered large-scale, cost-effective manufacturing of cellulosic ethanol. One such barrier is related to the low density of cellulosic feedstocks, causing high cost in their transportation and storage. Another barrier is the lack of efficient pretreatment procedures, making pretreatment one of the most expensive processing steps and causing efficiency in the subsequent enzymatic hydrolysis to be very low. There is a crucial need to develop more cost-effective processes to manufacture cellulosic ethanol. Ultrasonic vibration-assisted (UV-A) pelleting can increase not only the density of cellulosic feedstocks but also sugar and ethanol yields. It can help realize cost-effective manufacturing of cellulosic ethanol.

This PhD research consists of eleven chapters. Firstly, an introduction of this research is given in Chapter 1. Secondly, a literature review on ultrasonic pretreatment for ethanol manufacturing is given in Chapter 2 to show what has been done in this field. Thirdly, a feasibility test on UV-A pelleting of cellulosic biomass is conducted in Chapter 3. Comparisons

of the pellet density and sugar yield are also made between pelleting with and without ultrasonic vibration. Next, effects of process variables (such as biomass moisture content, biomass particle size, pelleting pressure, and ultrasonic power) on output variables (such as pellet density, durability, stability, and sugar yield) have been studied in Chapters 4~6. Chapter 7 compares sugar yields between two kinds of materials: pellets processed by UV-A pelleting and biomass not processed by UV-A pelleting under different combinations of three pretreatment variables (temperature, processing time, and solid content). Next, mechanisms through which UV-A pelleting increases sugar and ethanol yields are investigated in Chapters 8 and 9. Then, a predictive model of pellet density is developed for UV-A pelleting in Chapter 10. Finally, conclusions are given in Chapter 11.

**ULTRASONIC VIBRATION-ASSISTED PELLETING OF CELLULOSIC  
BIOMASS FOR ETHANOL MANUFACTURING**

BY

PENGFEI ZHANG

B.S., Beijing Institute of Technology, 2002  
M.S., Beijing Institute of Technology, 2005

A DISSERTATION

Submitted in partial fulfillment of the requirements for the degree

DOCTOR OF PHILOSOPHY

Department of Industrial and Manufacturing Systems Engineering  
College of Engineering

KANSAS STATE UNIVERSITY  
Manhattan, Kansas

2011

Approved by;

Co-Major Professor  
Dr. Zhijian Pei

Approved by;

Co-Major Professor  
Dr. Donghai Wang

**Copyright**

Pengfei Zhang

2011

## **Abstract**

Both the U.S. and world economies have been depending on petroleum based liquid transportation fuels (such as gasoline, diesel, and jet fuels), which are finite and nonrenewable energy sources. Increasing demands and concerns for the reliable supply of liquid transportation fuels make it important to find alternative sources to petroleum based fuels. One such alternative is cellulosic ethanol. Research, development, and production of cellulosic ethanol have received significant support from both the U.S. government and private investors. However, several technical barriers have hindered large-scale, cost-effective manufacturing of cellulosic ethanol. One such barrier is related to the low density of cellulosic feedstocks, causing high cost in their transportation and storage. Another barrier is the lack of efficient pretreatment procedures, making pretreatment one of the most expensive processing steps and causing efficiency in the subsequent enzymatic hydrolysis to be very low. There is a crucial need to develop more cost-effective processes to manufacture cellulosic ethanol. Ultrasonic vibration-assisted (UV-A) pelleting can increase not only the density of cellulosic feedstocks but also sugar and ethanol yields. It can help realize cost-effective manufacturing of cellulosic ethanol.

This PhD research consists of eleven chapters. Firstly, an introduction of this research is given in Chapter 1. Secondly, a literature review on ultrasonic pretreatment for ethanol manufacturing is given in Chapter 2 to show what has been done in this field. Thirdly, a feasibility test on UV-A pelleting of cellulosic biomass is conducted in Chapter 3. Comparisons

of the pellet density and sugar yield are also made between pelleting with and without ultrasonic vibration. Next, effects of process variables (such as biomass moisture content, biomass particle size, pelleting pressure, and ultrasonic power) on output variables (such as pellet density, durability, stability, and sugar yield) have been studied in Chapters 4~6. Chapter 7 compares sugar yields between two kinds of materials: pellets processed by UV-A pelleting and biomass not processed by UV-A pelleting under different combinations of three pretreatment variables (temperature, processing time, and solid content). Next, mechanisms through which UV-A pelleting increases sugar and ethanol yields are investigated in Chapters 8 and 9. Then, a predictive model of pellet density is developed for UV-A pelleting in Chapter 10. Finally, conclusions are given in Chapter 11.

# Table of Contents

List of Figures .....	xv
List of Tables .....	xx
Acknowledgements .....	xxii
Chapter 1 - Introduction .....	1
1.1 Significance of cellulosic ethanol.....	1
1.2 Composition and structure of cellulosic biomass.....	2
1.3 Manufacturing processes of cellulosic ethanol .....	5
1.4 Pretreatment in manufacturing of cellulosic ethanol.....	7
1.5 Ultrasonic vibration-assisted pelleting of cellulosic biomass .....	9
1.6 Objectives and scope of this research .....	10
Chapter 2 - Literature review.....	20
2.1 Introduction .....	21
2.2 Experimental conditions .....	24
2.2.1 Cellulosic materials .....	24
2.2.2 Test conditions .....	25
2.2.3 Ultrasonic treatments.....	26
2.3 Output variables and their measurements .....	29
2.3.1 Sugar yield and ethanol yield.....	29
2.3.2 Accessibility of cellulose.....	29
2.3.3 Crystallinity of cellulose.....	29
2.3.4 Polymerization degree of cellulose .....	30
2.3.5 Morphological structure of cellulose.....	31



2.4 Effects on sugar yield and ethanol yield .....	31
2.5 Effects on accessibility of cellulose.....	34
2.6 Effects on crystallinity of cellulose .....	36
2.7 Effects on polymerization degree of cellulose .....	39
2.8 Effects on morphological structure.....	39
2.9 Concluding remarks.....	40
Chapter 3 - Feasibility study.....	45
3.1 Introduction .....	46
3.2 Experimental procedure and conditions.....	50
3.2.1 Major steps in UV-A pelleting experiments .....	50
3.2.2 Illustration of UV-A pelleting process .....	51
3.2.3 Important process variables .....	52
3.2.4 Measurements of output variables.....	54
3.3 Results on pellet density .....	57
3.3.1 Effects of ultrasonic vibration.....	57
3.3.2 Effects of moisture content.....	57
3.3.3 Effects of particle size .....	58
3.4 Results on pellet stability .....	60
3.4.1 Effects of ultrasonic vibration.....	60
3.4.2 Effects of moisture content .....	60
3.4.3 Effects of particle size .....	61
3.5 Results on pellet durability.....	62
3.5.1 Effects of ultrasonic vibration.....	62

3.5.2 Effects of moisture content .....	63
3.6 Results on pelleting force.....	64
3.7 Results on sugar yield .....	64
3.8 Conclusions .....	65
Chapter 4 - effects of biomass moisture content on pellet quality.....	73
4.1 Introduction .....	74
4.2 Experimental conditions and measurement procedures.....	76
4.2.1 Experimental conditions .....	76
4.2.2 Measurement procedures of output variables .....	80
4.3 Results and discussion .....	82
4.3.1 Effects of moisture content on pellet density.....	82
4.3.2 Effects of moisture content on pellet spring-back.....	83
4.3.3 Effects of moisture content on pellet durability.....	85
4.4 Conclusions .....	85
Chapter 5 - Effects of biomass particle size on sugar yield .....	89
5.1 Introduction .....	90
5.2 Experimental conditions .....	93
5.2.1 Cutting milling .....	94
5.2.2 Hammer milling .....	94
5.2.3 Manual cutting .....	95
5.2.4 Particle size separation .....	96
5.2.5 Measurement of CI.....	97
5.2.6 Pretreatment .....	97

5.2.7 Enzymatic hydrolysis .....	98
5.2.8 Measurement of sugar yield.....	98
5.3 Experimental results .....	99
5.3.1 Results on CI.....	99
5.3.2 Results on sugar yield.....	100
5.4 Conclusions .....	101
Chapter 6 - Effects of process variables on pellet quality and sugar yield .....	105
6.1 Introduction .....	107
6.2 Experimental conditions .....	109
6.2.1 Major processes in UV-A pelleting experiments .....	109
6.2.2 Important process variables .....	110
6.2.3 Design of experiments .....	111
6.2.4 Measurements of the output variables .....	113
6.3 Results on pellet density .....	114
6.4 Results on pellet durability.....	117
6.5 Results on pellet stability .....	118
6.6 Results on sugar yield .....	120
6.7 Conclusions .....	121
Chapter 7 - Comparison of sugar yield from biomass processed and not processed by UV-A pelleting .....	125
7.1 Introduction .....	126
7.2 Experimental procedures and conditions .....	129
7.2.1 Hammer milling .....	129

7.2.2 UV-A pelleting.....	131
7.2.3 Pretreatment .....	132
7.2.4 Hydrolysis.....	133
7.2.5 Sugar yield measurement.....	134
7.3 Results and discussion .....	135
7.3.1 Sugar yield of powders.....	135
7.3.2 Sugar yield of UV-A pellets .....	137
7.3.3 Comparison of sugar yield.....	138
7.4 Conclusions .....	141
Chapter 8 - Mechanism of UV-A pelleting to enhance sugar yield – an investigation on biomass particle size .....	144
8.1 Introduction .....	145
8.2 Experimental conditions .....	148
8.2.1 Milling .....	149
8.2.2 Manual cutting .....	150
8.2.3 Ultrasonic vibration-assisted pelleting .....	151
8.2.4 Water soaking .....	153
8.2.5 Air drying.....	153
8.2.6 Measurement of particle size .....	153
8.3 Experimental results .....	156
8.3.1 Effects of water soaking on particle size .....	156
8.3.2 Effects of UV-A pelleting on particle size .....	158
8.3.3 Comparison of two measurement methods.....	161

8.4 Conclusions .....	162
Chapter 9 - Mechanism of UV-A pelleting to enhance sugar yield – microscopic examination on biomass surface morphology .....	167
9.1 Introduction .....	169
9.2 Literature review on effects of surface morphology on sugar yield.....	170
9.3 Experimental procedures and conditions .....	171
9.3.1 Size reduction of wheat straw to powder using hammer milling.....	171
9.3.2 UV-A pelleting.....	171
9.3.3 Pretreatment .....	174
9.3.4 Scanning electron microscopic observation .....	175
9.4 Experimental results .....	175
9.5 Conclusions .....	177
Chapter 10 – Pellet density model in UV-A pelleting .....	180
10.1 Introduction .....	181
10.1.1 Manufacturing of cellulosic ethanol.....	181
10.1.2 Approaches of biomass pelleting .....	182
10.1.3 Reported studies on pellet density in UV-A pelleting.....	183
10.1.4 Density models for biomass pelleting .....	183
10.1.5 Outline of this paper .....	185
10.2 Development of the mechanistic density model.....	185
10.2.1 Model assumptions.....	185
10.2.2 Derivation of the model.....	186
10.3 Determination of mechanistic parameter b using experiments .....	189

10.3.1 Experimental setup and conditions.....	189
10.3.2 Experimental results .....	190
10.4 Experimental verification.....	192
10.5 Conclusions .....	196
Chapter 11 - Conclusions .....	200
11.1 Summaries and conclusions of this dissertation.....	200
11.2 Contributions of this dissertation.....	203
Appendix A - Publications during Ph.D. study .....	205
Journal publications.....	205
Conference publications .....	207
Submitted papers .....	212
Working papers .....	213
Posters.....	214

## List of Figures

Figure 1.1 Composition of cellulosic biomass .....	3
Figure 1.2 Structure of cellulose molecule.....	3
Figure 1.3 Crystallized structure of cellulose .....	4
Figure 1.4 Structure of cellulose.....	5
Figure 1.5 The matrix structure in the cell wall of cellulosic biomass .....	5
Figure 1.6 Major steps for manufacturing of cellulosic ethanol.....	6
Figure 1.7 Purpose of pretreatment.....	8
Figure 1.8 Major steps in UV-A pelleting experiments .....	10
Figure 2.1 Major processes for manufacturing of cellulosic biofuels.....	22
Figure 2.2 Purpose of pretreatment in biofuel manufacturing.....	23
Figure 2.3 Purpose of hydrolysis in biofuel manufacturing .....	27
Figure 2.4 Schematic illustration of the ultrasound vessel.....	28
Figure 2.5 Schematic illustration of the ultrasound horn .....	28
Figure 2.6 Mixed amorphous and crystalline regions in cellulose structure.....	30
Figure 2.7 Comparison of sugar yield with and without ultrasonic treatments.....	32
Figure 2.8 Effects of ultrasonic treating time on sugar yield .....	33
Figure 2.9 Effects of ultrasonic intensity on sugar yield.....	33
Figure 2.10 Effects of ultrasonic treatment time on accessible surface area.....	35
Figure 2.11 Effects of ultrasonic intensity on accessible surface area.....	35
Figure 2.12 Effects of ultrasonic treatment time on WRV.....	36
Figure 2.13 Effects of ultrasonic intensity on cellulose crystallinity.....	37
Figure 2.14 Effects of ultrasonic treatment time on cellulose crystallinity.....	38

Figure 3.1 Major processes for manufacturing of cellulosic biofuels.....	48
Figure 3.2 Purpose of pretreatment in biofuel manufacturing.....	49
Figure 3.3 Major steps of UV-A pelleting experiments.....	51
Figure 3.4 Illustration of UV-A pelleting process .....	52
Figure 3.5 A sieve used in the cutting mill to control the particle size of the biomass powder ....	53
Figure 3.6 Illustration of the stop position of the tool .....	54
Figure 3.7 Illustration of pelleting force measurement.....	56
Figure 3.8 Effects of ultrasonic vibration on switchgrass pellet density .....	57
Figure 3.9 Effects of MC on switchgrass pellet density .....	58
Figure 3.10 Effects of particle size on pellet density.....	59
Figure 3.11 Effects of mixed particle sizes on pellet density.....	59
Figure 3.12 Effects of ultrasonic vibration on pellet stability .....	60
Figure 3.13 Effects of MC on pellet stability .....	61
Figure 3.14 Effects of particle size on pellet stability.....	61
Figure 3.15 Effects of mixed particle sizes on pellet stability.....	62
Figure 3.16 Effects of ultrasonic vibration on durability .....	63
Figure 3.17 Effects of moisture content on durability .....	63
Figure 3.18 Effects of ultrasonic vibration on pelleting force.....	64
Figure 3.19 Effects of UV-A pelleting on sugar yield .....	65
Figure 4.1 Major steps for manufacturing of cellulosic biofuels.....	75
Figure 4.2 Switchgrass before and after milling.....	77
Figure 4.3 Sieve with 1 mm holes .....	77
Figure 4.4 Major steps of UV-A pelleting experiments.....	78



Figure 4.5 Illustration of UV-A pelleting of biomass .....	78
Figure 4.6 Illustration of the initial pellet volume .....	80
Figure 4.7 Pellet shape after UV-A pelleting .....	81
Figure 4.8 Effects of MC on pellet density .....	83
Figure 4.9 Effects of MC on pellet spring-back .....	84
Figure 4.10 Effects of MC on pellet durability.....	85
Figure 5.1 Major steps in manufacturing of cellulosic biofuels .....	92
Figure 5.2 Experimental procedure.....	93
Figure 5.3 Cutting milling .....	94
Figure 5.4 Hammer milling .....	95
Figure 5.5 Manual cutting with scissors.....	95
Figure 5.6 Sieve shaker .....	96
Figure 5.7 Measurement results on CI .....	100
Figure 5.8 Measurement results on sugar yield .....	101
Figure 6.1 Major steps for manufacturing of cellulosic biofuels.....	108
Figure 6.2 Major processes of UV-A pelleting experiments.....	109
Figure 6.3 Illustration of experimental setup.....	110
Figure 6.4 Main and interaction effects on pellet density .....	116
Figure 6.5 Main and interaction effects on pellet durability .....	118
Figure 6.6 Main effect on pellet stability .....	119
Figure 6.7 Main and interaction effects on sugar yield.....	121
Figure 7.1 Major steps in cellulosic ethanol manufacturing .....	128
Figure 7.2 Experimental procedure.....	130

Figure 7.3 Hammer milling .....	130
Figure 7.4 Illustration of UV-A pelleting setup.....	131
Figure 7.5 Illustration of pretreatment reactor.....	133
Figure 7.6 Relations between powder sugar yield and pretreatment variables .....	137
Figure 7.7 Relations between pellet sugar yield and pretreatment variables .....	138
Figure 7.8 Sugar yield with different temperature.....	139
Figure 7.9 Sugar yield with different processing time.....	140
Figure 7.10 Sugar yield with different solid content .....	141
Figure 8.1 Major steps in manufacturing of cellulosic biofuels .....	147
Figure 8.2 Experimental procedure.....	149
Figure 8.3 Wheat straw particles after knife milling .....	150
Figure 8.4 Shape and size of a manually-cut particle .....	150
Figure 8.5 Illustration of UV-A pelleting setup.....	152
Figure 8.6 Top surface and thickness of a wheat straw particle.....	154
Figure 8.7 Shapes of a manually-cut particle at three different stages .....	155
Figure 8.8 Measurement of a particle's length and width using a microscope .....	155
Figure 8.9 A photograph used by Image J to measure particle size .....	156
Figure 9.1 Major steps in cellulosic ethanol manufacturing .....	170
Figure 9.2 Experimental procedure.....	172
Figure 9.3 Hammer milling .....	173
Figure 9.4 Illustration of UV-A pelleting setup.....	173
Figure 9.5 Illustration of pretreatment reactor.....	174
Figure 9.6 SEM images of wheat straw before pretreatment .....	175

Figure 9.7 SEM images of wheat straw after pretreatment .....	176
Figure 10.1 Major steps in cellulosic ethanol manufacturing .....	182
Figure 10.2 Sketch of the arrangement of mold, tool, and biomass with relevant forces.....	188
Figure 10.3 Illustration of UV-A pelleting setup.....	190
Figure 10.4 Experimental results on b value .....	191
Figure 10.5 Relation between b value and ultrasonic power.....	192
Figure 10.6 Comparison of pellet densities between prediction and experiments without ultrasonic vibration applied on the tool.....	193
Figure 10.7 Comparison of pellet densities between predictions and experiments at different levels of ultrasonic power.....	194
Figure 10.8 Comparison of pellet densities between predictions and experiments at different levels of pelleting pressure .....	195
Figure 11.1 Studies of this dissertation .....	201

## List of Tables

Table 1.1 Summary of pretreatment approaches .....	8
Table 2.1 Cellulosic materials tested with ultrasonic treatments .....	25
Table 2.2 Solutions used in hydrolysis processes.....	26
Table 2.3 Experimental conditions to test cellulose crystallinity (after [16,18]) .....	40
Table 2.4 Experimental conditions to test DP of cellulose (after [15,16,19,21]).....	40
Table 2.5 Summary of the reported investigations .....	41
Table 4.1 Values of main UV-A pelleting parameters.....	79
Table 5.1 Screen sizes of sieves.....	97
Table 5.2 Measurement results on CI .....	99
Table 5.3 Measurement results on sugar yield .....	100
Table 6.1 Variables and their levels.....	112
Table 6.2 Matrix of the experiments.....	112
Table 6.3 Results on pellet density .....	115
Table 6.4 Results on pellet durability .....	117
Table 6.5 Results on pellet stability .....	119
Table 6.6 Results on sugar yield.....	120
Table 7.1 Values of main UV-A pelleting variables.....	132
Table 7.2 Values of main UV-A pelleting variables.....	134
Table 7.3 Experimental matrix and results.....	136
Table 8.1 Input parameters and their values.....	153
Table 8.2 Measurement data of the pilot test.....	157
Table 8.3 Paired T-test results on particle size before and after soaking.....	158

Table 8.4 Measurement data of the pilot UV-A pelleting test.....	159
Table 8.5 Particle size measured using a microscope.....	160
Table 8.6 Particle size measured using Image J .....	160
Table 8.7 Comparison of the two measurement methods .....	161
Table 10.1 Models on pellet density of cellulosic biomass.....	184
Table 10.2 Experimental results on b value .....	191
Table 10.3 Data of pellet density obtained from experiments and model without ultrasonic vibration applied on the tool.....	193
Table 10.4 Data of pellet density obtained from experiments and predictions at different levels of ultrasonic power (pelleting pressure = 650 psi).....	194
Table 10.5 Data of pellet density obtained from experiments and predictions at different levels of pelleting pressure (ultrasonic power = 30%).....	195

## **Acknowledgements**

I would like to take this opportunity to express my appreciation to many people who have been helping me during my PhD study.

Firstly, I wish to express my deepest gratitude to my advisor Dr. Z.J. Pei for his excellent guidance, concern, and support to my research and my career development. Dr. Pei's rigorous scientific attitude has been very helpful to me. His research strategies and approaches inspired me all the time in my research. I also would like to thank Dr. Donghai Wang, my co-advisor, who is always ready to give valuable advice and share his abundant experiences and broad knowledge.

I also wish to thank Dr. Malgorzata J. Rys, Dr. Gurpreet Singh, and Dr. Praveen V. Vadlani for their advice, feedback, and consent to serve on my supervisory committee. I am very thankful to Dr. Singh for his assistance in observation of biomass structure by SEM. I would like to thank Dr. Mary Rezac to serve as my outside chair. I would also like to thank Dr. Shuting Lei for his generous help on my research and consent to be the examiner of my preliminary written examination.

I would like to thank the constant support from my department head Dr. Bradley A. Kramer. His support encourages me to achieve my goals in research and courses. I also thank the kind assistance from our department staff: Mrs. Vicky Geyer, Doris Galvan, and Danielle Kavan. Their offices are always enjoyable places for me to look for help on my research. I want to thank Mr. Timothy Deines, for his excellent technical assistance in setting up the machines and instruments. His constant support is indispensable for the success of my experiments. I also thank Dr. Shing I. Chang, Dr. E. Stanley Lee and all the other faculty members in my department

for their kindly help on my academic courses during my PhD study. I also really appreciate the position of teaching assistant provided by my department. I really learned many teaching skills and gained a lot of experience from this opportunity.

I would like to express my sincere gratitude to Dr. Yunbiao Xin and Crystal Technology Inc. for giving me such a precious opportunity of doing research in industry. I learned a lot of knowledge and experience of working in industries which is very helpful for my future career. Dr. Xin is a career mentor and a personal friend whom I can turn to at any time.

Thanks are also due to the support from my family. I must thank my wife, Qi Zhang, whose unconditional love has been very supportive to me. Many thanks also go to Mr. Weilong Cong, Ms. Na Qin, Mr. Meng Zhang, Ms. Xiaoxu Song, Mr. Daniel Nottingham, Ms. Emily Jones, Mr. Eric Zinke, Mr. Graham Pritchett, Mr. Cameron Harder, and Ms. Abigail Lewis for providing technical assistance in setting up the machines and conducting experiments.

Finally I would like to give my gratitude to the financial support from National Science Foundation. I would like to thank Mr. Clyde Treadwell at Sonic-Mill for providing experimental equipment. I also would like to thank all my friends, classmates, and colleagues for their friendship and support.

# **Chapter 1 - Introduction**

## **1.1 Significance of cellulosic ethanol**

In the last three decades, the consumption of liquid transportation fuels (including gasoline, diesel, and jet fuels) in the U.S. increased by 50% (DOE, 2008a). Conventional liquid transportation fuels are distilled from petroleum and account for 70% of total petroleum consumption (DOE, 2008a; DOE, 2008b; DOE, 2008c). In 2008, the U.S. transportation sector consumed about 14 million barrels of petroleum every day, and 60% of them were imported (NAS et al., 2009). Also, the use of conventional liquid transportation fuels contributes to the accumulation of greenhouse gas (GHG) in the atmosphere. Finite reserves, non-uniform distribution, volatile prices, and contribution to GHG emissions of petroleum make it extremely important to promote development of domestic sustainable sources to replace conventional liquid transportation fuels.

Ethanol produced from cellulosic biomass (the fibrous, woody, and generally inedible portions of plant matter) offers an alternative to reduce the nation's dependence on foreign petroleum, and cut GHG emissions while continuing to meet the nation's transportation energy needs (Anonymous, 2008; DOE, 2006). According to estimates from DOE's Argonne National Laboratory, cellulosic ethanol has the potential to reduce GHG emissions by more than 85%, and its production consumes about 10% of the fossil energy needed to produce conventional gasoline (Decker, 2009). Manufacturing of ethanol from cellulosic biomass can also create new jobs and improve rural economies (DOE, 2006).



Land resources in the U.S. are sufficient to sustain production of over one billion dry tons of biomass annually, enough to displace 30% or more of the nation's current consumption of liquid transportation fuels (Perlack et al., 2005). In contrast to other potential feedstocks for biofuels (e.g. corn, sugar cane, and beans), cellulosic biomass does not compete for limited agricultural land which is also needed for food and feed production. Furthermore, advances in agriculture and biotechnology have made it possible to inexpensively produce cellulosic biomass at costs that are significantly lower than crude oil (Huber, 2008).

Due to the benefits of cellulosic ethanol, tremendous interest exists to produce more cellulosic ethanol efficiently and economically. The U.S. government recently called for annual production of 36 billion gallons of "renewable and alternative fuels" by 2017 and continuous investing in new methods of producing ethanol from cellulosic biomass (Bush, 2007). Many pilot ethanol plants using cellulosic feedstocks have been or will be built in the U.S. (Adams, 2008; Laws, 2008; Gardner, 2009).

## **1.2 Composition and structure of cellulosic biomass**

Cellulosic biomass is mainly composed of three compositions: cellulose, hemicellulose, and lignin (Hon, 1996). As shown in Figure 1.1, cellulose is the principal carbohydrate component in cellulosic biomass. Cellulose molecule consists of glucose units linked by glucoside bond (Hon, 1996; Hu et al., 2008), as shown in Figure 1.2. Hemicellulose is composed of both six-carbon sugars and five-carbon sugars including arabinose, galactose, glucose, mannose, xylose, and other species (Hon, 1996; Hu et al., 2008). Xylose is believed to be present in the largest amount in hemicellulose (Hu et al., 2008). Lignin contains no sugars (Demirbas, 2005), and is not convertible to ethanol using the current technologies (Demirbas, 2005).

**Figure 1.1 Composition of cellulosic biomass (after Hon, 1996)**

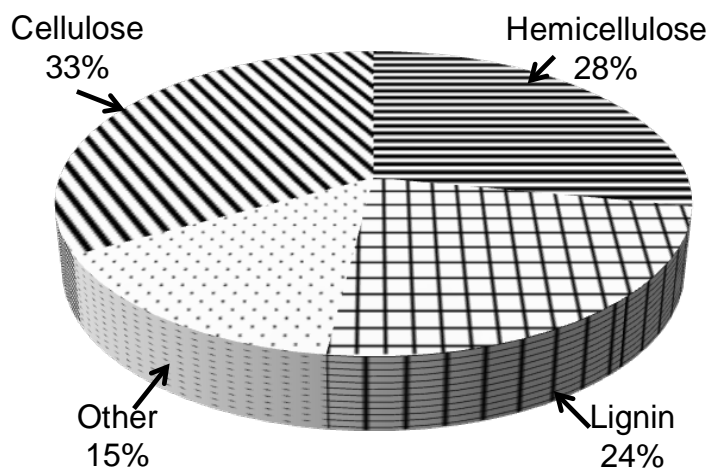

**Figure 1.2 Structure of cellulose molecule (after Hu et al., 2008)**

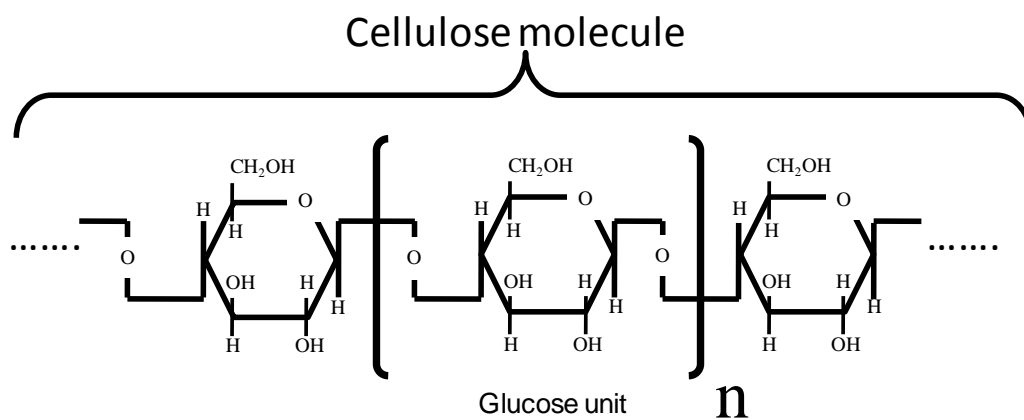

Although both cellulose and hemicellulose can be converted into ethanol, they play different roles in ethanol production based on current technologies. Cellulose is believed to have a highly crystallized structure composed of crystalline regions and amorphous regions, as shown in Figure 1.3. In contrast to amorphous regions, crystalline regions are difficult to be hydrolyzed to glucose (Fan et al., 1980; Bertran, 1984). After cellulose is converted into glucose, yeast is

used to ferment glucose into ethanol. Unlike cellulose, hemicellulose has a random and amorphous structure making it easier to be hydrolyzed (Hon, 1996). But the majority of the component sugars hydrolyzed from hemicellulose (e.g. xylose) are very difficult or uneconomical to be fermented to ethanol (Demirbas, 2005). Therefore, cellulose is considered as the main source in cellulosic biomass to manufacture ethanol.

**Figure 1.3 Crystallized structure of cellulose (after Statton, 1959)**

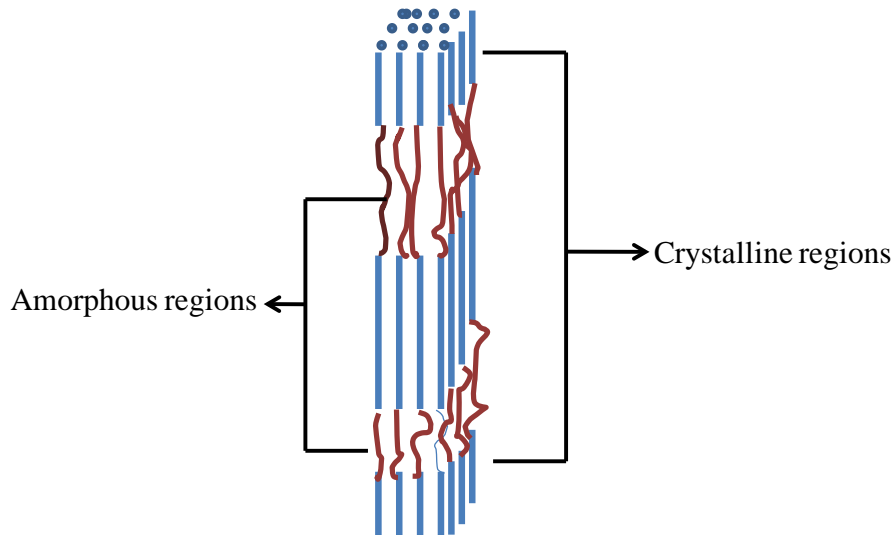

In cellulosic biomass, cellulose molecules have a strong tendency to form cellulose chains which can be aggregated to form microfibrils (Hon, 1996). Microfibrils can be further aggregated to form fibrils and then fibers, as shown in Figure 1.4. Cellulose fibers act as the structural component of the primary cell wall of cellulosic biomass and are always imbedded in a matrix of other polysaccharides (e.g. hemicellulose) and lignin (Hon, 1996), as shown in Figure 1.5. In manufacturing of ethanol, the matrix structure reduces the accessibility to cellulose by reagents which are used to convert cellulose into glucose.

**Figure 1.4 Structure of cellulose (after Anonymous, 2006)**

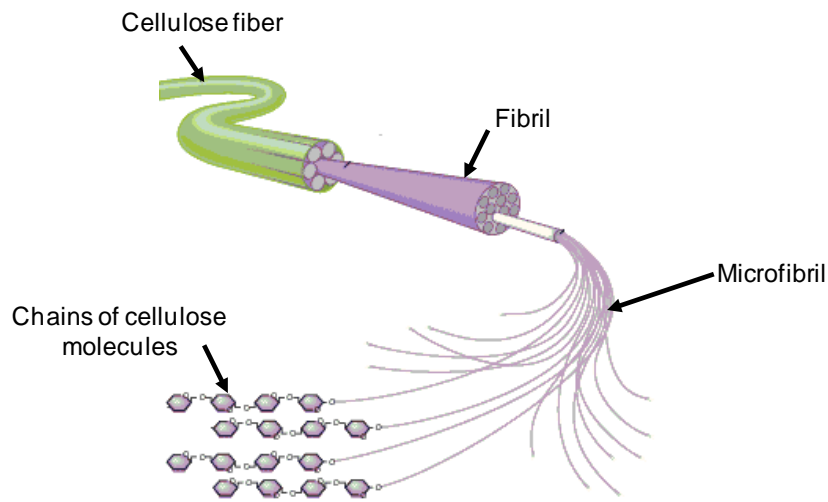

**Figure 1.5 The matrix structure in the cell wall of cellulosic biomass (after DOE, 2006)**

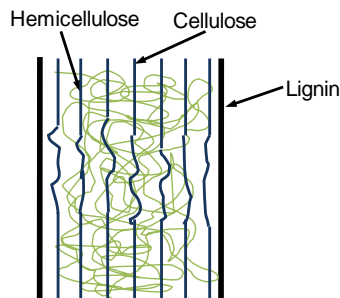

### **1.3 Manufacturing processes of cellulosic ethanol**

Figure 1.6 shows major steps for manufacturing of cellulosic ethanol. After harvest and collection, cellulosic biomass (feedstock for ethanol production) is transported from the field to the bioconversion plants, and is stored for future use. Hydrolysis is used to break down cellulose into its component sugars that are convertible to ethanol by fermentation (DOE, 2006; Rubin, 2008). There are two major types of hydrolysis processes used widely nowadays: acid hydrolysis

and enzymatic hydrolysis (Jones and Semrau, 1984). In acid hydrolysis, concentrated or diluted acids are used to soak cellulosic biomass resulting in problems with acid recovery, equipment corrosion, and decomposition of product sugars (Jones and Semrau, 1984). Enzymatic hydrolysis does not have these problems, but its efficiency is very low leading to a high production cost (Jones and Semrau, 1984). Therefore, cellulosic biomass needs to undergo extensive pretreatment first to increase the efficiency of enzymatic hydrolysis (Hu et al., 2008; Leustean 2009). More information on pretreatment is provided in Section 1.4.

**Figure 1.6 Major steps for manufacturing of cellulosic ethanol (after Rubin, 2008)**

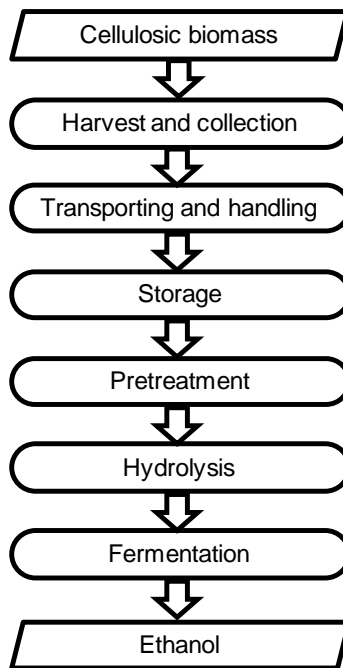

Currently there are only pilot ethanol plants that use cellulosic feedstocks in the U.S. (Moresco, 2008). Several technical barriers have hindered large-scale, cost-effective manufacturing of cellulosic ethanol (Hess, 2007; Huber, 2008). One such barrier is the low density of cellulosic feedstocks, causing high transportation and storage costs (Huber, 2008; Kho,

2009; Waves, 2009). The high costs related to cellulosic feedstock production and logistics (e.g. transportation and storage) can constitute 35% or more of total manufacturing costs of cellulosic ethanol (Aden et al., 2002; Phillips et al., 2007). Specifically, the logistics associated with transportation and storage of low-density biomass can make up more than 50% of the feedstock costs (Hess et al., 2007).

Another barrier to large-scale manufacturing of cellulosic ethanol is the lack of efficient and economical pretreatment procedures for enzymatic hydrolysis, causing pretreatment to be one of the most expensive processing steps (Wooley et al., 1999; Aden et al., 2002; DOE, 2006; Yang and Wyman, 2008).

#### **1.4 Pretreatment in manufacturing of cellulosic ethanol**

The purpose of pretreatment of cellulosic biomass in manufacturing of ethanol is illustrated in Figure 1.7. Pretreatment can break the lignin seal and disrupt the crystalline structure of cellulose, increasing its surface area and making it more accessible to enzymatic hydrolysis (DOE, 2006; Rubin, 2008). In general, pretreatment can be classified into biological pretreatment, chemical pretreatment, and physical pretreatment according to the different types of energy consumed in the pretreatment processes. Table 1.1 summarizes some pretreatment approaches.

**Figure 1.7 Purpose of pretreatment (after DOE, 2006)**

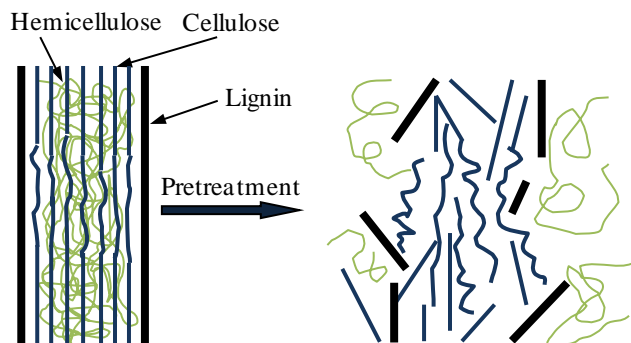

**Table 1.1 Summary of pretreatment approaches**

Category	Approach	Reference
Biological	Fungi	Zhang et al., 2007; Kuhar et al., 2008
Chemical	Acid	Knappert et al., 1980; Nguyen et al., 2000; Guerra et al., 2006
	Alkaline	Chang et al., 2001
	Gas	Fan et al., 1982
	Oxidant	Schmidt and Thomsen, 1998; Palonen et al., 2004
Physical	Electron beam	Fatarella et al., 2010; Shin and Sung, 2010
	Gamma-ray	Yang et al., 2009
	Microwave	Zhu et al., 2005
	Hot water	Bouchard et al., 1991; Mok and Antal, 1992
	Steam	Ramos et al., 1993; Avellar and Glasser, 1998
	Ultrasonics	Wood et al., 1997; Aliyu and Hephher, 2000

It has been reported that use of ultrasonics during pretreatment (of “wet” biomass) is beneficial to hydrolysis and ethanol fermentation. Toma et al. (2006) used ultrasonics for pretreatment and for ultrasonically assisted hydrolysis of biomass. Their results showed that direct exposure of cellulosic biomass to 20 kHz ultrasonics could increase the enzyme-accessible area of pretreated biomass and enhance the saccharification (extracting sugar out) of cellulose. Wood et al. (1997) increased ethanol production from mixed waste office paper by 20% with

intermittent exposure of simultaneous saccharification and fermentation processes (these processes combine enzymes and fermentative organisms so that, as sugars are produced, fermentative organisms convert them to ethanol) to ultrasonic energy under selected conditions. Montalbo-Lomboy et al. (2007) examined sequential ammonia-steeping and ultrasonic pretreatment of switchgrass. The experimental variables included ultrasonic energy dissipation and ultrasonic amplitude, biomass concentrations, and antibacterial agents. They found that sequential ammonia-steeping and ultrasonic pretreatment released about 10% more fermentable sugars than ammonia steeping alone. It was also reported that fiber structure of recycled paper was altered by ultrasonic treatment (Norman et al., 1994; Scott and Gerber, 1995; Sell et al., 1995). Such changes in fiber structure might be beneficial for the bioconversion of cellulose to ethanol (Wood et al., 1997).

### **1.5 Ultrasonic vibration-assisted pelleting of cellulosic biomass**

Pelleting is generally described as “the agglomeration of small particles into larger particles by the means of a mechanical process, and in some applications, thermal processing” (Falk, 1985). If cellulosic biomass is pelleted, its density is increased and handling efficiencies improved (Robinson, 1975; Leaver, 1984), resulting in a reduction in logistics costs (Hess et al., 2007). Furthermore, the pellets can be handled and transported with existing grain-handling equipment in the field, on the road, and at biorefinery plants (Hess et al., 2007).

Traditional pelleting methods (e.g. using a screw extruder, a briquetting press, or a rolling machine (Mani et al., 2003; Sokhansanj et al., 2005)) generally involve high-temperature steam and high pressure, and often use binder materials, making it difficult to realize cost-effective pelleting on or near the field where cellulosic biomass is available. Ultrasonic vibration-assisted (UV-A) pelleting, without using high-temperature steam and binder materials, can produce



biomass pellets whose density is comparable to that processed by traditional pelleting methods (Cong et al., 2009; Pei et al., 2009). Therefore, UV-A pelleting can reduce the overall manufacturing cost of ethanol by increasing the density of cellulosic feedstock. Another benefit of UV-A pelleting is that it can increase sugar and ethanol yields in ethanol production. Experiments show that the biomass feedstocks treated by UV-A pelleting can produce more glucose and ethanol than those without UV-A pelleting.

Major steps in UV-A pelleting experiments are shown in Figure 1.8. Biomass samples are milled into powder using a cutting mill with different sieve sizes. Moisture contents of the biomass powder after milling are measured and adjusted to the desired levels before pelleting. A Sonic-Mill ultrasonic machine is used to perform pelleting. After UV-A pelleting, a cylinder shaped pellet is obtained.

**Figure 1.8 Major steps in UV-A pelleting experiments**

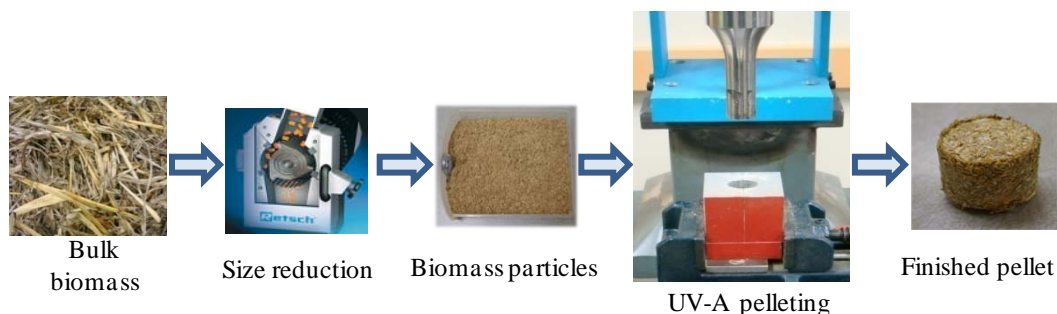

## **1.6 Objectives and scope of this research**

The objectives of this research are as the following:

(1) To study the feasibility of UV-A pelleting of cellulosic biomass as a pretreatment approach in the manufacturing of ethanol.

- (2) To evaluate the effects of process variables on pellet quality and sugar yield.
- (3) To investigate the mechanisms through which UV-A pelleting increases sugar yield.
- (4) To develop a model to predict pellet density in UV-A pelleting of cellulosic biomass.

This dissertation is organized into an introduction and a collection of nine papers (that either have been or to be published). Each paper has been used as one chapter. The entire dissertation has

Chapter 1 is an introduction providing the background and the objectives of this work.

Chapter 2 is a review of reported investigations on ultrasonic pretreatment in ethanol production. Various ultrasonic treatments are described and their effects on sugar and ethanol yields are summarized.

Chapter 3 is a feasibility investigation of UV-A pelleting in ethanol production. Three cellulosic biomass materials (such as sorghum stalks, switchgrass, and wheat straw) are used. Comparisons are made between pellets made by UV-A pelleting and non-ultrasonic-vibration-assisted pelleting in terms of their quality (such as density, stability, and durability) and sugar yield.

Chapters 4, 5, and 6 are experimental investigations on effects of input variables on pellet quality and sugar yield. Chapter 4 investigates effects of biomass moisture content on pellet quality. Results are obtained at three levels of moisture content while keeping all other input variables constant. Chapter 5 investigates effects of biomass particle size on sugar yield. Size reduction of biomass is performed by three different methods. Results are obtained at five levels of particle size while keeping all other input variables constant. Chapter 6 uses a  $2^4$  full design of experiment (DOE) to investigate main and interaction effects of four input variables (biomass moisture content, biomass particle size, pelleting pressure, and ultrasonic vibration power) on

pellet quality (density, durability, and stability) and sugar yield.

Chapter 7 compares sugar yields between two kinds of materials: pellets processed by UV-A pelleting and biomass not processed by UV-A pelleting under different combinations of three pretreatment variables (temperature, processing time, and solid content).

Chapter 8 and 9 investigates the mechanisms of UV-A pelleting to increase sugar yields. Particle sizes of biomass processed and not processed by UV-A pelleting are compared. A scanning electron microscopy (SEM) is used to observe and compare the surface morphology of biomass processed and not processed by UV-A pelleting.

Chapter 10 develops a mechanistic model to predict pellet density in UV-A pelleting.

Chapter 11 summarizes the conclusions and contributions of this research.

## References

Adams, D., 2008, University of Florida unveils cellulosic ethanol pilot plant, available at: <http://blogs.tampabay.com/energy/2008/10/university-of-f.html>.

Aden, A., Ruth, M., Ibsen, K., Jechura, J., Neeves, K., Sheehan, J., Wallace, B., Montague, L., Slayton, A., and Lukas, J., 2002, Lignocellulosic biomass to ethanol process design and economics utilizing co-current dilute acid prehydrolysis and enzymatic hydrolysis for corn stover, NREL/TP-510-32438, National Renewable Energy Laboratory, Golden, CO, available at: <http://www.nrel.gov/docs/fy02osti/32438.pdf>.

Aliyu, M., and Hephher, M.J., 2000, "Effects of ultrasound energy on degradation of cellulose material", *Ultrasonics Sonochemistry*, Vol. 7, No. 4, pp. 265-268.

Anonymous, 2006, Carbohydrates, available at: <http://nutrition.jbpub.com/resources/chemistryreview9.cfm>.

Anonymous, 2008, US pumps more money into cellulosic ethanol research, available at:

<http://sl.farmonline.com.au/news/nationalrural/agribusiness-and-genral/general/us-pumps-more-money-into-cellulosic-ethanol-research/1234385.aspx>.

Avellar, B.K., and Glasser, W.G., 1998, "Steam-assisted biomass fractionation: process considerations and economic evaluation", *Biomass Bioenergy*, Vol. 14, No. 3, pp. 205-218.

Bertran, M.S., 1983, "The effect of cellulose crystallinity on enzymatic hydrolysis", *Proceedings of the 13th Annual Biochemical Engineering Symposium*, pp. 57-66.

Bouchard, J., Nguyen, T.S., Chornet, E., and Overend, R.P., 1991, "Analytical methodology for biomass pretreatment. Part 2: Characterization of the filtrates and cumulative product distribution as a function of treatment severity", *Bioresource Technology*, Vol. 36, No. 2, pp. 121-131.

Bush, G.W., 2007, State of the union address, available at: <http://www.washingtonpost.com/wp-dyn/content/article/2007/01/23/AR2007012301075.html>.

Chang, V.S., Kaar, W.E., Burr, B., and Holtzapple, M.T., 2001, "Simultaneous saccharification and fermentation of lime-treated biomass", *Biotechnology Letters*, Vol. 23, No. 16, pp. 1327-1333.

Cong, W.L., Zhang, P.F., Qin, N., Zhang, M., Song, X.X., Zhang, Q., Nottingham, D., Clark, R., Deines, T., Pei, Z.J., and Wang, D.H., 2009, "Ultrasonic vibration-assisted pelleting of cellulosic biomass for biofuel manufacturing", Poster presentation at the 2009 International Manufacturing Science and Engineering Conference (MSEC), October 4-7, 2009, West Lafayette, IN, USA, MSEC2009-84432.

Decker, J., 2009, Going against the grain: ethanol from lignocellulosics, *Renewable Energy World*, available at:

- <http://www.renewableenergyworld.com/rea/news/article/2009/01/goingagainst-the-grain-ethanol-from-lignocellulosics-54346>.
- Demirbas, A., 2005, "Bioethanol from cellulosic materials: a renewable motor fuel from biomass", *Energy Sources*, Vol. 27, No. 4, pp. 327-337.
- U.S. Department of Energy (DOE), 2006, Breaking the biological barriers to cellulosic ethanol: a joint research agenda, <http://genomicscience.energy.gov/biofuels/b2bworkshop.shtml>.
- U.S. Department of Energy (DOE), 2008a, Energy consumption by sector (1949-2008), available at: <http://www.eia.doe.gov/emeu/aer/txt/ptb0201a.html>.
- U.S. Department of Energy (DOE), 2008b, Petroleum products supplied by type (1949-2008), available at: <http://www.eia.doe.gov/emeu/aer/txt/ptb0511.html>.
- U.S. Department of Energy (DOE), 2008c, Transportation sector energy consumption estimates (2007), available at: [http://www.eia.doe.gov/emeu/states/sep\\_sum/html/sum\\_btu\\_tra.html](http://www.eia.doe.gov/emeu/states/sep_sum/html/sum_btu_tra.html).
- Falk, D., 1985, Pelleting cost center, In: *Feed Manufacturing Technology*, 3rd edition, M.M. McEllhiney (ed.), American Feed Industry Association, Arlington, VA, USA.
- Fan, L.T., Lee, Y.H., and Brardmore, D.H., 1980, "Mechanism of the enzymatic hydrolysis of cellulose: effects of major structural features of cellulose on enzymatic hydrolysis", *Biotechnology and Bioengineering*, Vol. 22, No. 1, pp. 177-199.
- Fan, L.T., Lee, Y.H., and Gharpuray, H., 1982, "The nature of lignocellulosics and their pretreatments for enzymatic hydrolysis", *Advances in Biochemical Engineering/Biotechnology*, Vol. 23, pp. 158-183.
- Fatarella, E., Ciabatti, I., and Cortez, J., 2010, "Plasma and electron-beam processes as pretreatments for enzymatic processes", *Enzyme and Microbial Technology*, Vol. 46, No. 2, pp. 100-106.

- Gardner, T., 2009, Poet opens first cellulosic ethanol pilot plant, available at: <http://www.reuters.com/article/vcCandidateFeed2/idUSTRE50B6ZF20090112.html>.
- Guerra, A., Filpponen, I., Lucia, L.A., and Argyropoulos, D.S., 2006, “Comparative evaluation of three lignin isolation protocols for various wood species”, *Journal of Agricultural and Food Chemistry*, Vol. 54, No. 26, pp. 9696-9705.
- Hess, J.R., Wright, C.T., and Kenney, K.L., 2007, “Cellulosic biomass feedstocks and logistics for ethanol production”, *Biofuels, Bioproducts and Biorefining*, Vol. 1, No. 3, pp. 181–190.
- Hon, D.N.S., 1996, Functional natural polymers: a new dimensional creativity in lignocellulosic chemistry, In: D.N.S. Hon (Ed.), *Chemical modification of lignocellulosic materials*, Marcel Dekker Inc., New York, USA.
- Hu, G., Heitmann, J.A., and Rojas, O.J., 2008, “Feedstock pretreatment strategies for producing ethanol from wood, bark, and forest residues”, *BioResources*, Vol. 3, No. 1, pp. 270-294.
- Huber, G.W., 2008, Chemical, bioengineering, environmental, and transport systems division, available at: <http://www.ecs.umass.edu/biofuels/Images/Roadmap2-08.pdf>.
- Jones, J.L., and Semrau, K.T., 1984, “Wood hydrolysis for ethanol production – previous experience and the economics of selected processes”, *Biomass*, Vol. 5, No. 2, pp. 109-135.
- Kho, J., 2009, Fuel from utility poles: cellulosic ethanol heats up in cool economy, *Clean Technica*, available at: <http://cleantechnica.com/2009/01/19/fuel-from-utility-poles-cellulosicethanol-heats-up-in-cool-economy/>.
- Knappert, D., Grethlein, H., and Converse, A., 1980, “Partial acid hydrolysis of cellulosic materials as a pretreatment for enzymatic hydrolysis”, *Biotechnology and Bioengineering*,

Vol. 22, No. 7, pp. 1449-1463.

Kuhar, S., Nair, L.M., and Kuhad, R.C., 2008, "Pretreatment of lignocellulosic material with fungi capable of higher lignin degradation and lower carbohydrate degradation improves substrate acid hydrolysis and the eventual conversion to ethanol", *Canadian Journal of Microbiology*, Vol. 54, No. 4, pp. 305-313.

Laws, F., 2008, Cellulosic ethanol pilot plant: UT/DuPont, available at: <http://deltafarmpress.com/biofuels/ethanol-plant-0729/>.

Leaver, R.H., 1984, *The pelleting process*, Sprout-Waldron, Muncy, PA, USA.

Leustean, I., 2009, "Bioethanol from lignocellulosic materials", *Journal of Agroalimentary Processes and Technologies*, Vol. 15, No. 1, pp. 94-101.

Mani, S., Tabil, L.G., and Sokhansanj, S., 2003, "An overview of compaction of biomass grinds", *Powder Handling and Processing*, Vol. 15, No. 3, pp. 160-168.

Mok, W.S.L., and Antal, M.J., 1992, "Uncatalyzed solvolysis of whole biomass hemicellulose by hot compressed liquid water," *Industrial and Engineering Chemistry Research*, Vol. 31, No. 4, pp. 1157-1161.

Montalbo-Lombay, M., Srinivasan, G., Raman, D.R., Anex R.P., and Grewell, D., 2007, "Influence of ultrasonics in ammonia steeped switchgrass for enzymatic hydrolysis", *Technical Papers of the 2007 ASABE Annual International Meeting*, June 17-20, 2007, American Society of Agricultural and Biological Engineers, St. Joseph., MI.

Moresco, J., 2008, U.S. biofuel output to miss mandates, available at: <http://www.redherring.com/Home/25682>.

National Academy of Sciences (NAS), National Academy of Engineering (NAE), and National Research Council (NRC), 2009, *Liquid transportation fuels from coal and biomass*, The

- National Academies Press, Washington, US.
- Nguyen, Q.A., Tucker, M.P., Keller, F.A., and Eddy, F.P., 2000, "Two-stage dilute acid pretreatment of softwoods", *Applied Biochemistry and Biotechnology*, Vol. 84-86, pp. 561-576.
- Norman, J.C., Sell, N.J., and Danelski, M., 1994, "Deinking laser-print paper using ultrasound", *TAPPI Journal*, Vol. 77, No. 3, pp. 151-158.
- Palonen, H., Thomsen, A.B., Tenkanen, M., Schmidt, A.S., and Viikari, L., 2004, "Evaluation of wet oxidation pretreatment for enzymatic hydrolysis of softwood", *Applied Biochemistry and Biotechnology*, Vol. 117, No. 1, pp. 1-17.
- Pei, Z.J., Wang, D.H., and Clark, R., 2009, "Ultrasonic vibration-assisted pelleting of cellulosic biomass: a preliminary experiment", *Proceedings of the 2009 International Manufacturing Science and Engineering Conference (MSEC)*, October 4-7, 2009, West Lafayette, IN, USA, MSEC2009-84205.
- Perlack, R.D., Wright, L.L., Turhollow, A.F., Graham, R.L., Stokes, B.J., and Erbach, D.C., 2005, "Biomass as feedstocks for a bioenergy and byproducts industry: the technical feasibility of a billion-ton annual supply", DOE Technical paper, GO-102005-2135.
- Phillips, S., Aden, A., Jechura, J., Dayton, D., and Eggeman, T., 2007, *Thermochemical ethanol via indirect gasification and mixed alcohol synthesis of lignocellulosic biomass*, NREL Technical Report, TP-510-41168, National Renewable Energy Laboratory, Golden, CO, available at: <http://www.nrel.gov/docs/fy07osti/41168.pdf>.
- Ramos, L.P., Breuil, C., and Saddler, J.N., 1993, "The use of enzyme recycling and the influence of sugar accumulation on cellulose hydrolysis by *Trichoderma* cellulases", *Enzyme and Microbial Technology*, Vol. 15, No. 1, pp. 19-25.



- Robinson, R.A., 1975, "The pelleting of millfeed", Bulletin Association of Operative Millers (July), pp. 3545-3549.
- Rubin, E.M., 2008, "Genomics of cellulosic biofuels", Nature, Vol. 454, No. 14, pp. 841-845.
- Schmidt, A., and Thomsen, A., 1998, "Optimization of wet oxidation pretreatment of wheat straw", Bioresource Technology, Vol. 64, No. 2, pp. 139-151.
- Sell, N.J., Norman, J.C., and Jayaprakash, D., 1995, "Deinking secondary fiber using ultrasound", Progress in Paper Recycling, Vol. 4, No. 4, pp. 28-34.
- Scott, W.E., and Gerber, P., 1995, "Using ultrasound to deink xerographic waste", TAPPI Journal, Vol. 78, pp. 125-130.
- Shin, S.J., and Sung, Y.J., 2010, "Improving enzymatic saccharification of hybrid poplar by electron beam irradiation pretreatment", Journal of Biobased Materials and Bioenergy, Vol. 4, No. 1, pp. 23-26.
- Sokhansanj, S., Mani, S., and Zaini, P., 2005, "Binderless pelletization of biomass", ASABE Paper No. 056061, American Society of Agricultural and Biological Engineers, St. Joseph, MI.
- Statton, W.O., 1959, "Polymer texture: the arrangement of crystallites", Journal of Polymer Science, Vol. 41, No. 138, pp. 143-148.
- Toma, M., Bandow, H., Vinatoru, M., and Maeda, Y., 2006, "Ultrasonically assisted conversion of lignocellulosic biomass to ethanol", Proceedings of the 2006 AIChE Annual Meeting, November 12-17, 2006, San Francisco, CA.
- Waves, A., 2009, Ethanol faces challenges ahead, Oregon Natural Resource Report, available at: <http://naturalresourcereport.com/2009/08/ethanol-faces-challenges-ahead/>.
- Wood, B.E., Aldrich, H.C., and Ingram, L.O., 1997, "Ultrasound stimulates ethanol production

- during the simultaneous saccharification and fermentation of mixed waste office paper”, *Biotechnology Progress*, Vol. 13, No. 3, pp. 232-237.
- Wooley, R., Ruth, M., Sheehan, J., Ibsen, K., Majdeski, H., and Galvez, A., 1999, Lignocellulosic biomass to ethanol process design and economics utilizing co-current dilute acid prehydrolysis and enzymatic hydrolysis current and futuristic scenarios, NREL/TP-580-26157, National Renewable Energy Laboratory, Golden, CO, available at: <http://www.nrel.gov/docs/fy99osti/26157.pdf>.
- Yang, B., and Wyman, E., 2008, “Pretreatment: the key to unlocking low-cost cellulosic ethanol”, *Biofuels, Bioproducts, and Biorefining*, Vol. 2, No. 1, pp. 26-40.
- Yang, C.P., Shen, Z.Q., Yu, G.C., and Wang, J.L., 2009, “Effect of gamma ray radiation pretreatment on enzymatic hydrolysis of wheat straw to produce sugar”, *Atomic Energy Science and Technology*, Vol. 43, No. 1, pp. 36-40.
- Zhang, X.Y., Yu, H.B., Huang, H.Y., and Liu, Y.X., 2007, “Evaluation of biological pretreatment with white rot fungi for the enzymatic hydrolysis of bamboo culms”, *International Biodeterioration and Biodegradation*, Vol. 60, No. 3, pp. 159-164.
- Zhu, S., Wu, Y., Yu, Z., Liao, J., and Zhang, Y., 2005, “Pretreatment by microwave/alkali of rice straw and its enzymatic hydrolysis”, *Process Biochemistry*, Vol. 40, No. 9, pp. 3082-3086.

## **Chapter 2 - Literature review**

Many investigations have been conducted to evaluate the effects of ultrasonics in pretreatment on sugar and ethanol yields. In these investigations, cellulosic biomass is soaked in water or other solvents through which ultrasonic energy is transferred from ultrasonic generator to cellulosic biomass. It is found that ultrasonic treatments can increase the sugar and ethanol yields by changing physical features of biomass such as crystallinity, degree of polymerization, and morphology. This literature review describes the experimental conditions and summarizes the results of these investigations. The content of this chapter has been published as a technical paper.

### Paper title:

Effects of ultrasonic treatments on cellulose in cellulosic biofuel manufacturing: a literature review

### Published in:

Proceedings of the ASME International Conference on Manufacturing Science and Engineering (MSEC), October 12-15, 2010, Erie, PA, USA, MSEC 2010-34180.

### Authors' names:

Pengfei Zhang, Z.J. Pei

### Authors' Affiliation:

Department of Industrial and Manufacturing Systems Engineering, Kansas State University, 2037 Durland Hall, Manhattan, KS 66506

## **Abstract**

Cellulosic biofuels are one type of renewable energy, and have been proposed to replace traditional liquid transportation fuels. Cellulosic biomass is the feedstocks in cellulosic biofuel manufacturing. Cellulose accounts for approximately 30% of the total weight in cellulosic biomass. Glucose, one type of monosaccharide convertible to ethanol, can be obtained by hydrolyzing the polymeric structure of cellulose. Currently enzymatic methods are the most common for the hydrolysis of cellulose. However, the low efficiency of enzymatic hydrolysis increases production cost and hinders the large-scale manufacturing of cellulosic biofuels. Ultrasonic treatments applied on cellulosic biomass were found to improve the efficiency of hydrolysis and subsequently increase the sugar yield of hydrolysis. To understand the effects of ultrasonics on cellulose, investigations have been conducted on the effects on cellulose characteristics caused by ultrasonic treatments during hydrolysis. This paper reviews the effects of ultrasonic treatments on cellulose during hydrolysis in terms of sugar yield and some characteristics of cellulose, such as accessibility, crystallinity, degree of polymerization, and morphological structure.

## **2.1 Introduction**

Biofuels have been promoted as an alternative to traditional liquid transportation fuels (e.g. gasoline, diesel, and jet fuels distilled from petroleum). Bioethanol is the most widely used liquid biofuel [1]. At present, most commercial production of bioethanol is from maize and sugar cane [1,2]. However, cellulosic biomass (such as wood, waste paper, and crop residue resources)

has become more and more attractive as feedstocks for bioethanol manufacturing due to its abundant sources and non-competition with food [3].

Cellulosic biomass is mainly comprised of cellulose, hemicellulose, and lignin [1]. Cellulose is the dominant source of material for bioethanol manufacturing. Cellulose molecules consist of the polymeric glucose, which can be converted into ethanol via fermentation [4-11]. Hemicellulose contains many different sugar monomers; however, most of these sugars are difficult to convert into ethanol [12]. Lignin is undesired in bioethanol manufacturing. Lignin contains no sugar and its presence impedes the accessibility of cellulose to enzymes during the hydrolysis process [12].

Major manufacturing processes for cellulosic bioethanol are shown in Figure 2.1. The purpose of pretreatment is to break the lignin seal and disrupt the crystalline structure of cellulose, increasing its surface area and making it more accessible to enzyme hydrolysis [13,14], as shown in Figure 2.2. Hydrolysis is performed to break the polymeric structure of cellulose into soluble glucose, which can be converted into ethanol in a fermentation process, as shown in Figure 2.3.

**Figure 2.1 Major processes for manufacturing of cellulosic biofuels (after [14])**

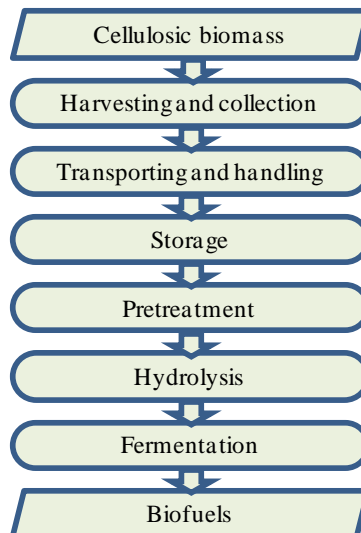

**Figure 2.2 Purpose of pretreatment in biofuel manufacturing (after [13])**

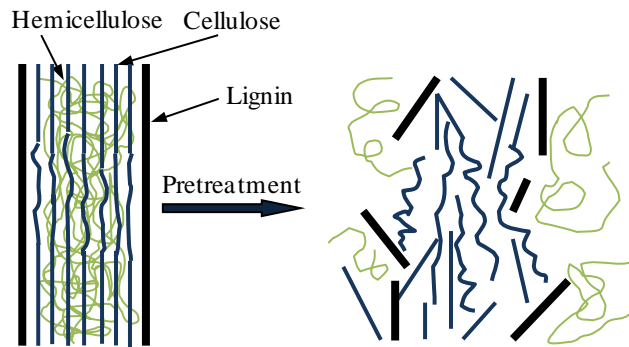

The low efficiency of enzymatic hydrolysis hinders the large-scale and cost-effective manufacturing of cellulosic biofuels. In order to reduce the production cost of cellulosic biofuels, intensive investigations have been conducted on different pretreatment approaches, including biological (such as enzymes and bacteria), chemical (such as sulfuric acid, sulfur dioxide, and ammonia), and physical (such as heat and ultrasonics). The hydrolysis of cellulose is carried out based on the action of cellulolytic enzymes and various kinds of chemicals [5]. Ultrasonic treatments have been used in both the pretreatment and hydrolysis processes of cellulosic biomass. In hydrolysis, the effects of ultrasonic treatments on the sugar yield have been investigated [4-11]. In pretreatment, investigations are focused on the effects of ultrasonic treatments on some cellulose characteristics, such as accessibility, crystallinity, degree of polymerization, and morphological structure [5,7,15-21]. In all of the reported investigations, ultrasonic treatments were applied to various solutions in which cellulosic materials were suspended.

Higher sugar yield is desirable in bioethanol manufacturing. The investigations on accessibility, crystallinity, degree of polymerization, and morphological structure are also

valuable, because it is believed that sugar yield is highly influenced by these characteristics. These investigations can help to understand the mechanisms of the improvement on the sugar yield caused by ultrasonic treatments. At present, there are no review papers in the literature about the effects of ultrasonic treatments on cellulose in hydrolysis or pretreatment. Such review papers would be desirable in order to provide readers with the overview on the effects of ultrasonic treatments on the sugar yield and the characteristics of cellulose.

This paper reviews the effects of ultrasonic treatments on cellulose in both pretreatment and hydrolysis. Various cellulose materials, hydrolysis conditions, and ultrasonic treatments are summarized. Important output variables and their measurement processes are described.

## **2.2 Experimental conditions**

### ***2.2.1 Cellulosic materials***

Two major categories of cellulosic materials have been investigated: microcrystalline cellulose (MCC) and various cellulosic biomasses (such as corn stover, cotton fiber, switchgrass, etc.). Table 2.1 lists the cellulosic materials tested with ultrasonic treatments. Most of these cellulosic materials are commercially available and are used for hydrolysis without pretreatment [4-6,8,9,16-19,21]. Some of these materials are pretreated by the authors before hydrolysis [10,11,15,20]. Some materials are prepared by the researchers themselves [19].

**Table 2.1 Cellulosic materials tested with ultrasonic treatments**

Material	Referances	Pre-experiment condition
Bacterial cellulose	[19]	Incubated
Corn stover	[6]	Commercial available
Cotton cellulose	[15]	Pretreated in KHSO <sub>4</sub> solution
	[18]	Commercial available
Eucalyptus pulp	[20]	After prehydrolysis
MCC	[4,5,16,17,19,21]	Commercial available
Paper pulp	[8, 9]	Commercial available
Pine powder	[10]	Pretreated in sodium hydroxide
Powdered cellulose	[21]	Commercial available
Switchgrass	[11]	Ground

### ***2.2.2 Test conditions***

In enzymatic hydrolysis processes, both enzymes and chemicals were used. Comparisons of the sugar yield were made between the hydrolyses with and without ultrasonics [4,6-11,21]. In pretreatment processes, no enzyme was used. The effects of ultrasonic treatments on cellulose were evaluated in water or chemical solutions [5,15-20].

Important parameters of a hydrolysis process include the type of enzymes, chemical solution, and the pH value of the solution. Three types of cellulase enzymes are widely used in hydrolysis process: *trichoderma viride* [4,8-10], *trichoderma reesei* [6,21], and spezyme CP [7,11]. Various chemical solutions were used in hydrolysis process. The pH values of these solutions are commonly adjusted to around 5. Table 2.2 lists the solutions used in the reported processes (including hydrolysis and pretreatment).



**Table 2.2 Solutions used in hydrolysis processes**

Solution	Reference	Concentration	pH value
Acetate buffer solution	[6,8-11,21]	0.001-0.05 M	4.8 - 5
Citrate buffer solution	[7]	0.05 M	5.2
Cuprammonium hydroxide	[19]		
Ethyl acetate	[15]	0.045-0.15 M	
HCL	[4]	0.1 M	4.8-5.5
Methyl alcohol	[18]		
Sodium periodate	[20]		
Water	[5,16,17]		

### *2.2.3 Ultrasonic treatments*

Reported ultrasonic treatments were performed by using an ultrasound vessel [6,19] or using an ultrasonic horn [4,5,7-11,15-18,20,21]. When using an ultrasound vessel, the container (which contains the solution with enzyme and suspension of cellulosic materials) is put into a vessel filled with coupling liquid. The vessel embedded with ultrasound transducers is vibrated ultrasonically during hydrolysis, as shown in Figure 2.4. Submerging an ultrasonic horn in the solution to generate ultrasound waves in the solution is another way, as shown in Figure 2.5. Most of the reported investigations utilized this method.

**Figure 2.3 Purpose of hydrolysis in biofuel manufacturing (after [13])**

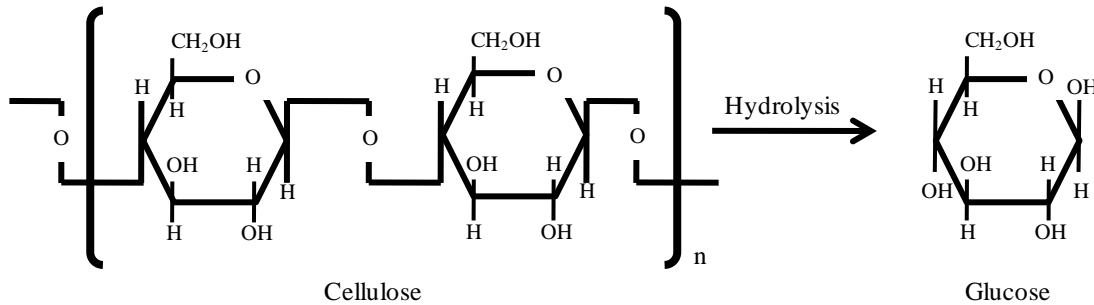

Important process parameters of ultrasonic treatments include treatment time, ultrasonic frequency and intensity, and ultrasonic type (continuous or periodic). The treatment time ranges from several hours to several days. The applied ultrasonic frequency ranges from 20 kHz to 50 kHz. The intensity of ultrasonic treatments is measured by the input power (Watts) of the ultrasonic generators. The most commonly used intensity range is from about 100 to 700 Watts.

**Figure 2.4 Schematic illustration of the ultrasound vessel (after [6])**

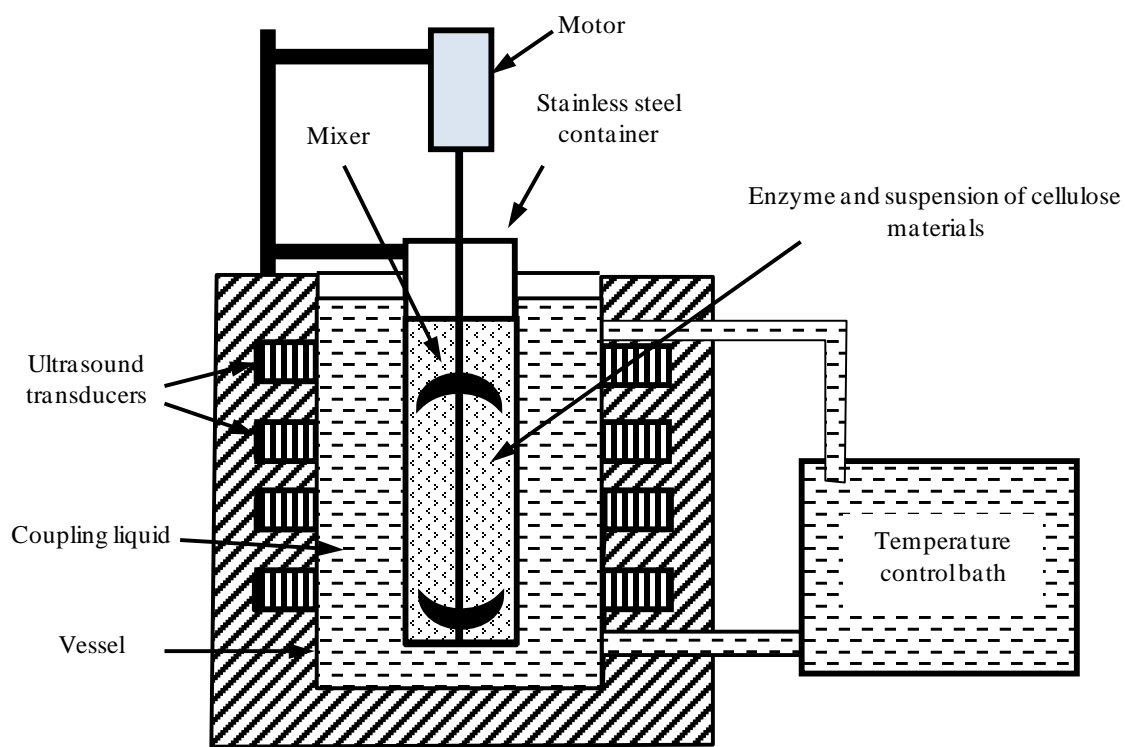

**Figure 2.5 Schematic illustration of the ultrasound horn (after [8,20])**

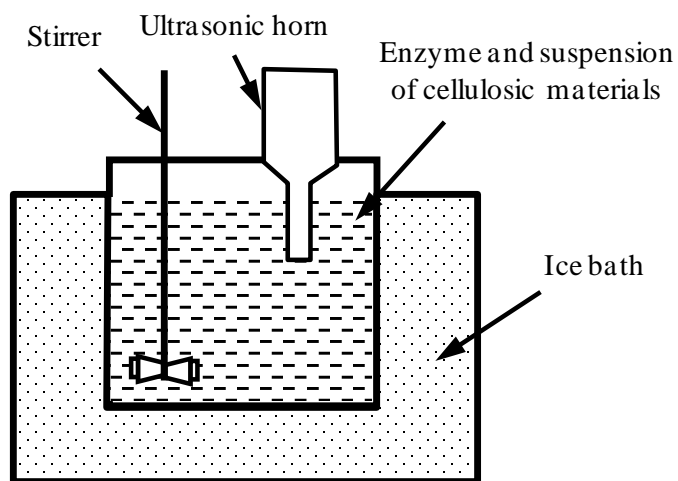

## **2.3 Output variables and their measurements**

### ***2.3.1 Sugar yield and ethanol yield***

Sugar yield represents the amount of the glucose saccharified in hydrolysis process. A higher sugar yield means more glucose is obtained. Ethanol yield represents the amount of ethanol obtained after fermentation. Sugar yield and ethanol yield are usually considered proportional, so most of the investigations were conducted only on sugar yield. Reported measurement methods of sugar yield include glucose oxidase method [8-10] and DNS method [6,11]. Measured sugar yield is often expressed as the concentration of the sugar.

### ***2.3.2 Accessibility of cellulose***

Accessibility of cellulose is used to describe the susceptibility of cellulose to the action of cellulase (enzymes used for the hydrolysis of cellulose). Accessibility of cellulose has been measured by a variety of techniques [22]. Quantitative measurements include determination of the accessible surface area of cellulose available to the cellulase enzyme by means of nitrogen sorption and moisture sorption [23], and determination of the size of accessing pores distributed on cellulose surface by means of water retention value (WRV) [23,24]. A higher sorption rate and WRV represent higher accessibility of cellulose, which is preferable because the increased cellulose accessibility can lead to a higher efficiency of enzymatic hydrolysis so that the sugar yield will be increased.

### ***2.3.3 Crystallinity of cellulose***

Generally, cellulose is partially crystalline with crystalline regions dispersed with amorphous regions, as shown in Figure 2.6. Crystallinity measures the percentage of crystalline region within the total structure, referred to as crystallinity index (CrI). X-ray diffraction (XRD)

is the most common used method to determine crystallinity index [16-19]. Diffraction profiles of the cellulose were fitted with a Gaussian function to resolve into separate diffraction peaks. The crystallinity index can be determined following the method reported by Wang et al. [16] as:

$$\text{CrI} = \frac{A_{\text{Crystal}}}{A_{\text{Total}}} * 100\%$$

where,  $A_{\text{Crystal}}$  is the sum of the areas under the crystalline diffraction peaks and  $A_{\text{Total}}$  is the total area under the diffraction curve [19]. It is believed that lower crystallinity of cellulose can lead to higher sugar yield, because amorphous region are more accessible to enzyme attacks than crystalline regions [16,17,19].

**Figure 2.6 Mixed amorphous and crystalline regions in cellulose structure (after [18])**

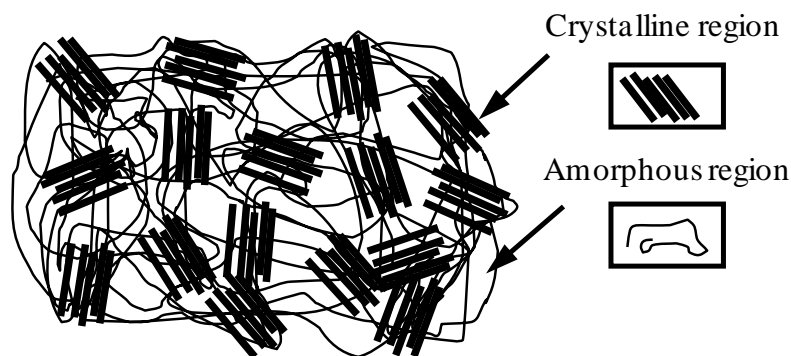

### ***2.3.4 Polymerization degree of cellulose***

As a polymer, cellulose molecules have different sizes and weights due to their distinguished degrees of polymerization (DP). Larger sizes and weights of cellulose molecule are associated with higher DPs. DP can be determined viscosimetrically as well as by size exclusion chromatography (SEC). With the proper solvent (e.g. copper ammonia), DP is determined from

viscosity measurement at  $25\pm 1^\circ\text{C}$  using a capillary viscometer according to the equations of Craig and Henderson [25]. DP determinations by SEC were performed using a high performance liquid chromatography (HPLC) unit with UV-detector. The SEC process was described by Marx-Figini [15], Dupont [26], and Wong et al. [19]. It means that ultrasonics can disrupt the polymeric structure of cellulose if DP becomes lower after ultrasonic treatments [15].

### ***2.3.5 Morphological structure of cellulose***

The morphological structures of cellulose before and after ultrasonic treatments were compared by using transmission electron microscopy (TEM) or scanning electron microscope (SEM). The magnification ranges from  $2500\times$  to  $25000\times$ . Rougher and cracked surfaces are preferable to the adsorption of enzyme [5, 7,16,17,19,20]. The particle sizes of the cellulosic materials before and after the ultrasonic treatments are also measured to evaluate the effects of ultrasonics [5,7,16,17,19].

## **2.4 Effects on sugar yield and ethanol yield**

A higher sugar yield was obtained in hydrolysis with ultrasonic treatments than without ultrasonic treatments. Yachmenev et al. [6] found that ultrasonic treatments could increase the sugar yield by more than 10%, as shown in Figure 2.7. Similar results were found by other researchers [7-10].

**Figure 2.7 Comparison of sugar yield with and without ultrasonic treatments (after [6])**

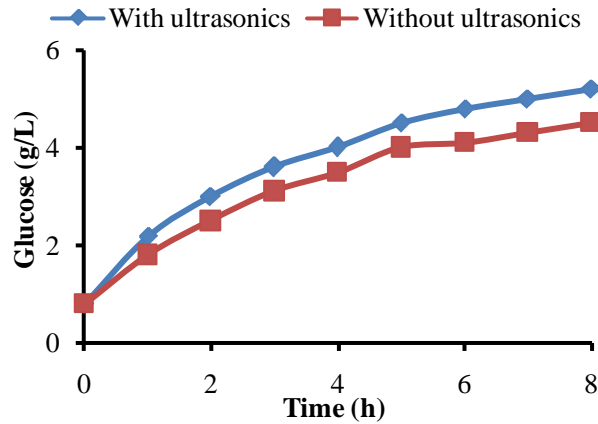

Biomass material - corn stover

Ultrasonic treatment - vessel

Ultrasonic frequency (kHz) - 50

Longer time of ultrasonic treatments was found to increase the sugar yield, as shown in Figure 2.8. The adjusted glucose yield is the difference between the glucose yields in two hydrolysis conditions (with and without ultrasonic treatments). It can be seen from Figure 2.7 that much more adjusted glucose is obtained with longer treatment time. Similar results were found by Yachmenev et al. [6] and Nakao et al. [10].

Higher sugar yield can be obtained by increasing the ultrasonic intensity. Nakao et al. [10] applied three levels of ultrasonic intensity to compare their sugar yield for several cellulosic materials. It was found that, with the same treatment time, higher sugar yields were always associated with higher ultrasonic intensities, as shown in Figure 2.9. Similar results were obtained by other researchers [8,9,11].

**Figure 2.8 Effects of ultrasonic treating time on sugar yield (after [7])**

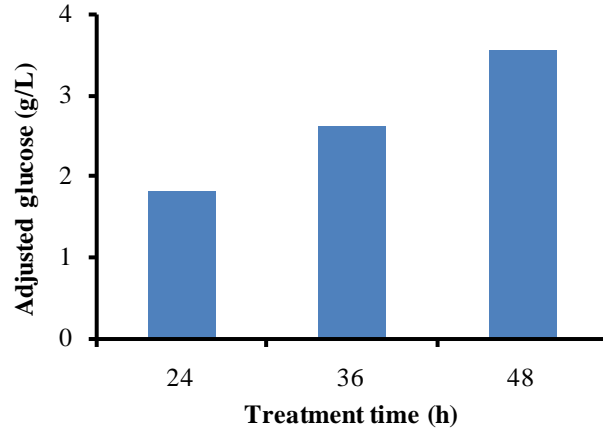

Biomass material - waste office paper

Ultrasonic treatment - horn

Ultrasonic intensity (W) - 150

Ultrasonic frequency (kHz) - 36

**Figure 2.9 Effects of ultrasonic intensity on sugar yield (after [10])**

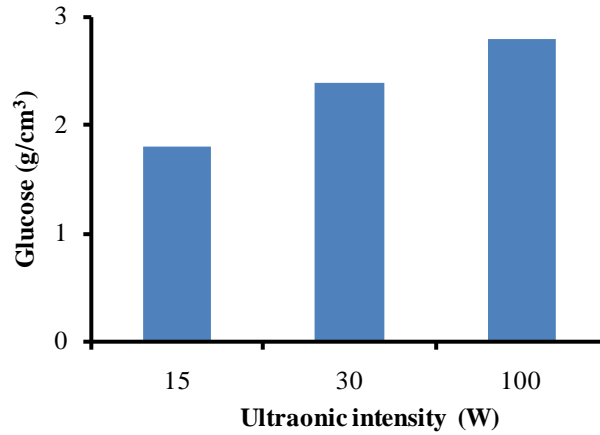

Biomass material - pine powder

Ultrasonic treatment - horn

Ultrasonic intensity (W) - 200

Ultrasonic frequency (kHz) - 20



Wood et al. [7] compared the effects of continuous ultrasonics on the sugar yield with periodic ultrasonics. The cycle time of the periodic ultrasonics was 120 minutes with 15 minutes on and 105 minutes off. It was found that periodic ultrasonics could generate about 20% higher sugar yield than continuous ultrasonics. They also reported that ethanol yield was increased as the ultrasonic treatment time increased. The periodic ultrasonics could generate about 30% higher ethanol yields than the continuous ultrasonics.

## **2.5 Effects on accessibility of cellulose**

Wang et al. [16] found that the accessible surface area increased first with ultrasonic treatment time and then decreased, as shown in Figure 2.10. They suggested that the accessible surface area of cellulose could increase dramatically with the control of proper ultrasonic treatment time. They also reported that using higher ultrasonic intensity could lead to larger accessible surface area, as shown in Figure 2.11.

There is one other piece of evidence that shows ultrasonic treatments can increase the accessibility of cellulose in terms of water retention value (WRV). It is clear from Figure 2.12 that WRV increased with an increase in ultrasonic treatment time [16]. Similar results were found by Tang et al. [20].

**Figure 2.10 Effects of ultrasonic treatment time on accessible surface area (after [16])**

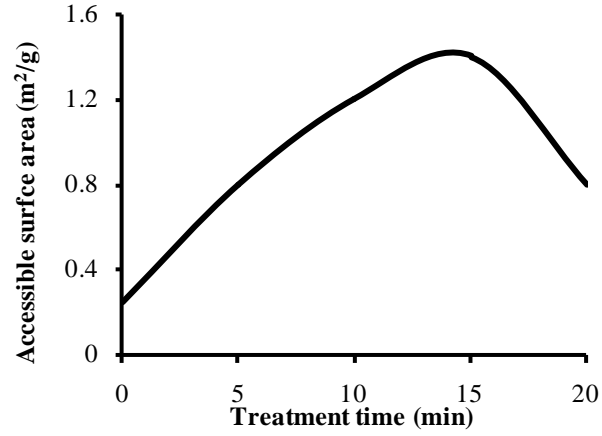

Biomass material - microcrystalline cellulose

Solution - water

Ultrasonic treatment - horn

Ultrasonic intensity (W) - 300

Ultrasonic frequency (kHz) - 20

**Figure 2.11 Effects of ultrasonic intensity on accessible surface area (after [16])**

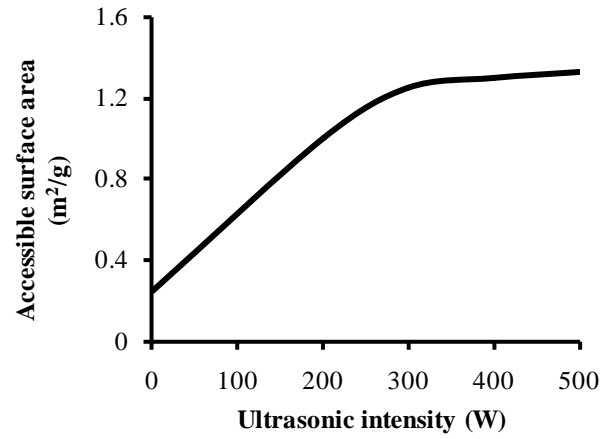

Biomass material - microcrystalline cellulose

Solution - water

Ultrasonic treatment - horn

Ultrasonic time (min) - 15

Ultrasonic frequency (kHz) - 20

**Figure 2.12 Effects of ultrasonic treatment time on WRV (after [16])**

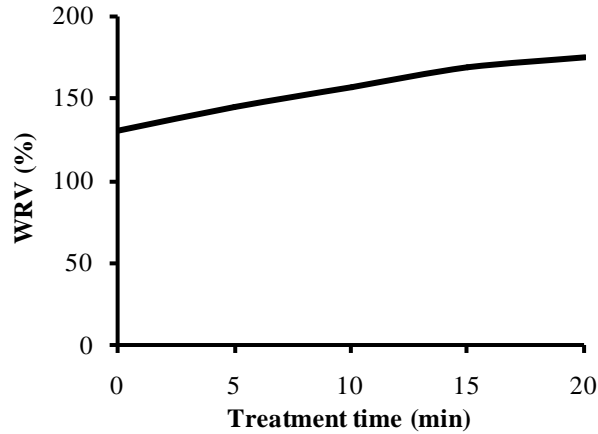

Biomass material - microcrystalline cellulose

Solution - water

Ultrasonic treatment - horn

Ultrasonic intensity (W) - 500

Ultrasonic frequency (kHz) - 20

## **2.6 Effects on crystallinity of cellulose**

The results on crystallinity index from different investigations are controversial. Figure 2.13 shows the effects of ultrasonic intensity on crystallinity of cellulose from two investigations. Wang et al. [16] reported that the crystallinity index decreased as the ultrasonic intensity increased, as shown in Figure 2.13 (a). Xiong et al. [18] reported that, as the ultrasonic intensity increased, the crystallinity index decreased first and then increased and increased again, as shown in Figure 2.13 (b). Table 2.3 lists the experimental conditions used in their tests. Wong et al. [19] compared the effects of ultrasonic treatment time on crystallinity of cellulose between two kinds of cellulosic materials: bacterial cellulose (incubated by themselves) and plant cellulose (cotton lint). These two materials went through the same test procedure. It was reported that the crystallinity index of bacterial cellulose increased as the ultrasonic treatment time

increased, and the crystallinity index of plant cellulose decreased slightly as the treatment time increased, as shown in Figure 2.14.

**Figure 2.13 Effects of ultrasonic intensity on cellulose crystallinity (after [16,18])**

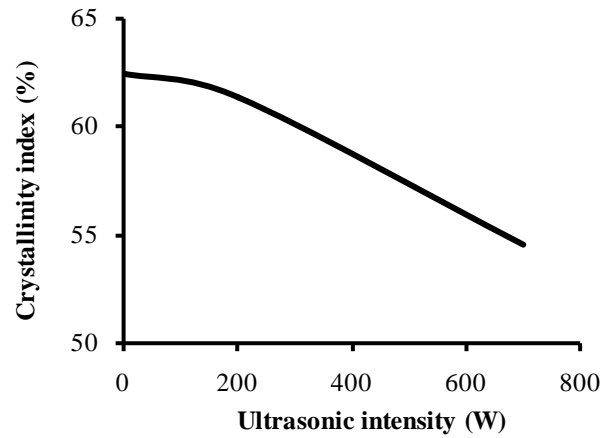

(a) After Wang et al.

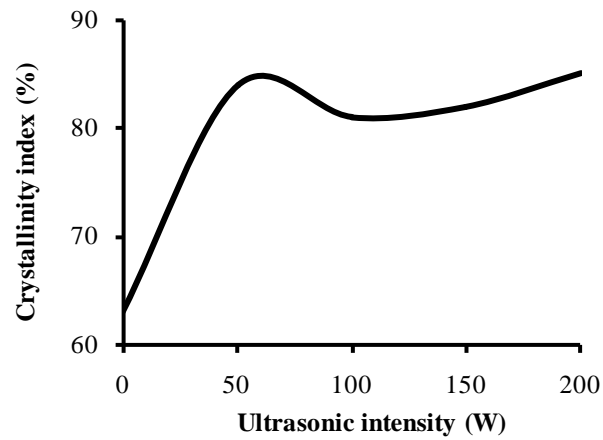

(b) After Xiong et al.

Figure 2.14 Effects of ultrasonic treatment time on cellulose crystallinity (after [19])

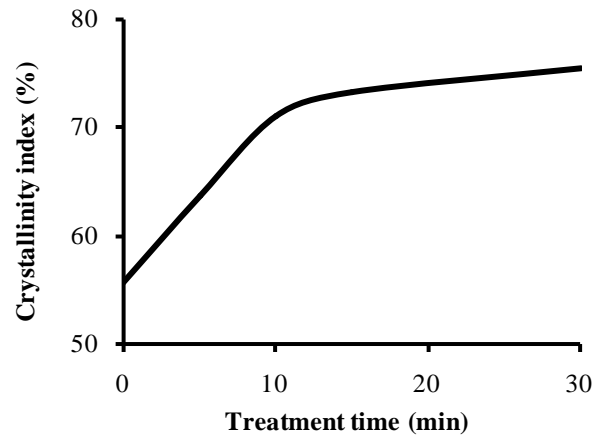

(a) Bacterial cellulose

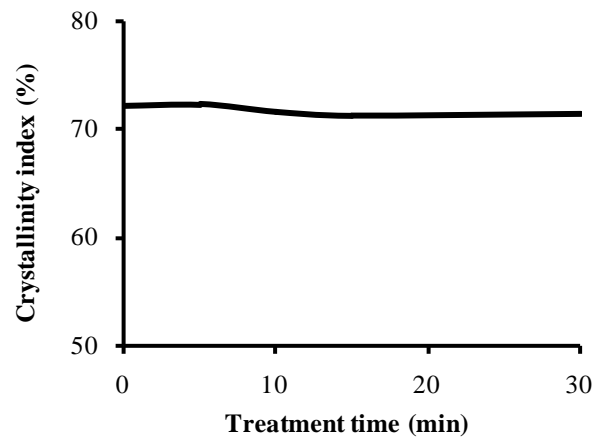

(b) Plant cellulose

Solution - Cuprammonium hydroxide

Ultrasonic treatment - vessel

Ultrasonic intensity (W) - 150

Ultrasonic frequency (kHz) - 37

## **2.7 Effects on polymerization degree of cellulose**

Controversial results on the effects of ultrasonic treatments on the DP of cellulose were reported [15,16,19,21]. Some researchers got the results that ultrasonic treatments could decrease the DP of cellulose [15,19,21]. Marx-Figini [15] reported that higher intensity of ultrasonic treatments got remarkably more rapid degradation of cellulose. Within the same period of time, smaller DP was obtained as the ultrasonic intensity increased, and the distribution of DP became narrower with higher ultrasonic intensity. Similar results were found by Wong et al. [19] and Gama et al. [21].

However, Wang et al. [16] reported that ultrasonic treatments themselves could only change the DP very little for cellulose. They believed that the energy of ultrasonic treatments was low, and not enough to break the chemical bond. Table 2.4 lists the experimental conditions used in their tests.

## **2.8 Effects on morphological structure**

Investigations on the morphological structure of cellulose performed with SEM and TEM revealed that the dimensions of the cellulosic samples had been significantly reduced, especially when subjected to direct sonication with ultrasonic horn [5,16,17,19]. However, Wood et al. [7] reported that the dimensions of their cellulosic samples had not been altered even they also used ultrasonic horn.

All of the related investigations reported that the surface morphology of the cellulosic sample was changed after ultrasonic treatments. Erosion was found on the sample surface by Toma et al. [5]. Wood et al. found that ultrasonic treatments converted the sample surface into a tangle of filaments, each 20-40 nm in diameter and many microns in length [7]. Many concave pits and cracks were found on the surfaces of treated samples by Wang et al. [16]. Tang et al.

found the peeling of the sample's surface in the form of large pieces or in the form of smaller flakes [20].

**Table 2.3 Experimental conditions to test cellulose crystallinity (after [16,18])**

Author	Biomass material	Solution	Ultrasonic treatment	Ultrasonic intensity (W)	Ultrasonic time (min)	Ultrasonic frequency (kHz)
Wang et al.	MCC	Water	horn	0, 200, 700	15	20
Xiong et al.	Cotton	Methyl alcohol	horn	0, 50, 100, 150, 200	0.5	20

**Table 2.4 Experimental conditions to test DP of cellulose (after [15,16,19,21])**

Author	Biomass material	Solution	Enzyme	Ultrasonic treatment	Ultrasonic intensity	Ultrasonic time (h)	Ultrasonic frequency (kHz)	Particle size decreased
Gama et al.	MCC	Acetate buffer	Yes	\	\	36 h	\	Yes
Marx-Figini	Cotton	Ethyl acetate	No	horn	22	1	20	Yes
Wang et al.	MCC	Water	No	horn	500	0.3	20	No
Wong et al.	Cotton	Methyl alcohol	No	horn	150	0.5	37	Yes

## 2.9 Concluding remarks

Effects of ultrasonic treatments on cellulose in hydrolysis have been investigated in terms of sugar yield, accessibility, crystallinity, degree of polymerization, and morphological structure. The reviewed investigations in this paper are summarized in Table 2.5. Ultrasonic treatments have beneficial effects on sugar yield in enzymatic hydrolysis when applied to wet cellulosic materials (which are suspended in solutions). However, controversial results on the other four characteristics (accessibility, crystallinity, degree of polymerization, and morphological structure) were reported. It is hard to give the reason for these controversial results, because there are too

many different conditions (such as materials, solutions, ultrasonic parameters, etc.) used in the investigations among different authors. The effects of ultrasonic treatments on cellulosic materials in pretreatment and hydrolysis are still not very clear. Moreover, all of these investigations were conducted on the cellulosic materials suspended in various solutions. So far there is no report in the literature about the effects of ultrasonic treatments on cellulosic materials in dry state (not submerged in solutions).

**Table 2.5 Summary of the reported investigations**

Reference	Sugar yield	Accessibility	Crystallinity	Degree of polymerization	Morphology structure
Aliyu and Hephher [4]	√				
Gama et al. [21]				√	
Li et al. [8,9]	√				
Lomboy et al. [11]	√				
Marx-Figini [15]				√	
Nakao et al. [10]	√				
Tang et al. [20]		√	√		
Toma et al. [5]	√				√
Wang et al. [16,17]		√	√	√	√
Wong et al. [19]			√	√	√
Wood et al. [7]	√	√			
Xiong et al. [18]			√		
Yachmenev et al. [6]	√				

## References

- [1] A. Demirbas, “Bioethanol from cellulosic materials: a renewable motor fuel from biomass,” *Energy Sources*, Vol. 27, No. 4, pp. 327-337, 2005.
- [2] M. Galbe, and G. Zacchi, “A review of the production of ethanol from softwood,” *Applied Microbiology and Biotechnology*, Vol. 59, No. 6, pp. 618-628, 2002.



- [3] D.E. Salter, "Production of fuel pellets by the densification of biomass," Solar Energy Society of Canada, Vol. 2, pp. 1130-1132, 1982.
- [4] M. Aliyu, and M.J. Hephher, "Effects of ultrasound energy on degradation of cellulose material," Ultrasonics Sonochemistry, Vol. 7, No. 4, pp. 265-268, 2000.
- [5] M. Toma, H. Bandow, M. Vinatoru, and Y. Maeda, "Ultrasonic assisted conversion of lignocellulosic biomass to ethanol," Proceedings of AIChE Annual Meeting, San Francisco, CA, USA, November 12 - 17, 2006.
- [6] V. Yachmenev, B. Condon, T. Klasson, and A. Lambert, "Acceleration of the enzymatic hydrolysis of corn stover and sugar cane bagasse celluloses by low intensity uniform ultrasound," Journal of Biobased Materials and Bioenergy, Vol. 3, No. 1, pp. 25-31, 2009.
- [7] B.E. Wood, H.C. Aldrich, and L.O. Ingram, "Ultrasound stimulates ethanol production during the simultaneous saccharification and fermentation of mixed waste office paper," Biotechnology Progress, Vol. 13, No. 3, pp. 232-237, 1997.
- [8] C.Z. Li, M. Yoshimoto, N. Tsukuda, K. Fukunaga, and K. Nakao, "A kinetic study on enzymatic hydrolysis of a variety of pulps for its enhancement with continuous ultrasonic irradiation," Biochemical Engineering Journal, Vol. 19, No. 2, pp. 155-164, 2004.
- [9] C.Z. Li, and K. Seki, "Enzymatic hydrolysis of waste paper in an external loop airlift bubble column with continuous ultrasonic irradiation," Journal of Chemical Engineering of Japan, Vol. 37, No. 8, pp. 1041-1049, 2004.
- [10] K. Nakao, K. Fukunaga, Y. Yasuda, and M. Kimura, "Enzymatic hydrolysis of lignocellulosics with continuous irradiation of supersonic wave," Annals of the New York Academy of Science, Vol. 613, pp. 802-806, 1990.

- [11] M.M. Lomboy, G. Srinivasan, D.R. Raman, R.P. Anex, and D. Grewell, "Influence of ultrasonics in ammonia steeped switchgrass for enzymatic hydrolysis," ASABE Annual International Meeting, Technical paper 076231, 2007.
- [12] C.T. Brett, and K.W. Waldron, *Physiology and Biochemistry of Plant Cell Walls* (second edition), University Press, Cambridge, Great Britain, 1996.
- [13] DOE, "Breaking the biological barriers to cellulosic ethanol: a joint research agenda," DOE Office of Science and Office of Energy Efficiency and Renewable Energy, <http://genomicsgtl.energy.gov/biofuels/b2bworkshop.shtml>, 2006.
- [14] E.M. Rubin, "Genomics of cellulosic biofuels," *Nature*, Vol. 454, No. 14, pp. 841-845, 2008.
- [15] M. Marx-Figini, "Studies on the ultrasonic degradation of cellulose," *Angewandte Makromolekulare Chemie*, Vol. 250, pp. 85-92, 1996.
- [16] X.L. Wang, G.Z. Fang, C.P. Hu, and T.C. Du, "Application of ultrasonic waves in activation of microcrystalline cellulose," *Journal of Applied Polymer Science*, Vol. 109, No. 5, pp. 2762-2767, 2008.
- [17] N. Wang, E.Y. Ding, and R.S. Cheng, "Thermal degradation behaviors of spherical cellulose nanocrystals with sulfate groups," *Polymer*, Vol. 48, No. 12, pp. 3486-3493, 2007.
- [18] J. Xiong, J. Ye, and W.Z. Liang, "The influence of ultrasonic wave on supermolecular structure of cellulose," *Acta Acustica*, Vol. 24. No. 1, pp. 66-69, 1999.
- [19] S.S. Wong, S. Kasapis, and Y.F. Tan, "Bacterial and plant cellulose modification using ultrasound irradiation," *Carbohydrate Polymers*, Vol. 77, No. 2, pp. 280-287, 2009.

- [20] A.M. Tang, H.W. Zhang, G. Chen, G.H. Xie, and W.Z. Liang, "Influence of ultrasound treatment on accessibility and regioselective oxidation reactivity of cellulose," *Ultrasonics Sonochemistry*, Vol. 12, No. 6, pp. 467-472, 2005.
- [21] F.M. Gama, M.G. Carvalho, M.M. Figueiredo, and M. Mota, "Comparative study of cellulose fragmentation by enzymes and ultrasound," *Enzyme and Microbial Technology*, Vol. 20, No. 1, pp. 12-17, 1997.
- [22] J.E. Stone, and A.M. Scallan, "A structural model for the cell wall of water-swollen wood pulp fibres based on their accessibility to macromolecules," *Cellulose Chemistry and Technology*, Vol. 2, pp. 343-358, 1968.
- [23] M.K. Inglesby, and S.H. Zeronian, "The accessibility of cellulose as determined by dye adsorption," *Cellulose*, Vol. 3, No. 1, pp. 165-181, 1996.
- [24] S. Okubayashi, U.J. Griesser, and T. Bechtold, "Moisture sorption/desorption behavior of various manmade cellulosic fibers," *Journal of Applied Polymer Science*, Vol. 97, No. 4, pp. 1621-1625, 2005.
- [25] A.W. Craig, and D.A. Henderson, "A viscometer for dilute polymer solutions," *Journal of Polymer Science*, Vol. 19, No. 91, pp. 215, 1956.
- [26] A.L. Dupont, "Cellulose in lithium chloride/N, N-dimethylacetamide, optimisation of a dissolution method using paper substrates and stability of the solutions," *Polymer*, Vol. 44, No. 15, pp. 4117-4126, 2003.

## Chapter 3 - Feasibility study

Although ultrasonic treatments on soaked cellulosic biomass have been proved beneficial to manufacturing of ethanol, there are no reports in the literature showing that direct actions of ultrasonic energy on dry biomass have positive effects on ethanol yield. As described in Section 1.5, ultrasonic forces and energy act on dry biomass directly in UV-A pelleting. In this chapter, the benefits of UV-A pelleting are verified in terms of its ability to improve the density of biomass feedstock and to increase sugar yield. The content of this chapter has been published as a technical paper.

Paper title:

Ultrasonic vibration-assisted pelleting of cellulosic biomass for biofuel manufacturing

Published in:

Journal of Manufacturing Science and Engineering, 2011, 133 (1).

Authors' names:

Pengfei Zhang<sup>1</sup>, Z.J. Pei<sup>1</sup>, Donghai Wang<sup>2</sup>, Xiaorong Wu<sup>2</sup>, Weilong Cong<sup>1</sup>, Meng Zhang<sup>1</sup>,  
Timothy Deines<sup>1</sup>

Authors' Affiliations:

1. Department of Industrial and Manufacturing Systems Engineering, Kansas State University, 2037 Durland Hall, Manhattan, KS 66506

2. Department of Biological and Agricultural Engineering, Kansas State University, 150 Seaton Hall, Manhattan, KS 66506

## **Abstract**

Increasing demands and concerns for the reliable supply of liquid transportation fuels make it important to find alternative sources to petroleum based fuels. One such alternative is cellulosic biofuels. However, several technical barriers have hindered large-scale, cost-effective manufacturing of cellulosic biofuels, such as the low density of cellulosic feedstocks (causing high transportation and storage costs) and the lack of efficient pretreatment procedures of biomass feedstocks. This paper reports experimental investigations on ultrasonic vibration-assisted (UV-A) pelleting of cellulosic feedstocks. It studies the effects of input variables (ultrasonic vibration, moisture content, and particle size) on output variables (pellet density, stability, durability, pelleting force, and yield of biofuel conversion) in UV-A pelleting. The results showed that UV-A pelleting could increase the density of cellulosic feedstocks and the yield of biofuel conversion.

### **Keywords**

Biofuel, cellulosic biomass, density, pellet, ultrasonic vibration-assisted pelleting

## **3.1 Introduction**

In the last three decades, the consumption of liquid transportation fuels (e.g. gasoline, diesel, and jet fuels) in the U.S. increased by 50% [1]. Conventional liquid transportation fuels are distilled from petroleum and account for 70% of total petroleum consumption [1-3]. In 2008, the U.S. transportation sector consumed about 14 million barrels of petroleum every day, and 60% of them were imported [4]. Also, the use of conventional liquid transportation fuels contributes

to the accumulation of greenhouse gas (GHG) in the atmosphere. Finite reserves, non-uniform distribution, volatile prices, and contribution to GHG emissions of petroleum make it extremely important to promote development of domestic sustainable sources to replace conventional liquid transportation fuels.

Biofuels produced from cellulosic biomass (the fibrous, woody, and generally inedible portions of plant matter) offer an alternative to reduce the nation's dependence on foreign petroleum, and cut GHG emissions while continuing to meet the nation's transportation energy needs [5,6]. Land resources in the U.S. are sufficient to sustain production of enough biomass annually to displace 30% or more of the nation's current consumption of liquid transportation fuels [7]. In contrast to other potential feedstocks for biofuels (e.g. corn, sugar cane, and beans), cellulosic biomass does not compete for limited agricultural land which is also needed for food and feed production.

Figure 3.1 shows major processes for manufacturing of cellulosic biofuels. Currently there are only pilot biofuel plants that use cellulosic feedstocks in the U.S. [8]. Several technical barriers have hindered large-scale, cost-effective manufacturing of cellulosic biofuels [10,11]. One such barrier is the low density of cellulosic feedstocks, which causes higher transportation and storage costs [10,12,13]. Another barrier is the lack of efficient pretreatment procedures, causing pretreatment to be one of the most expensive processing steps [5,14-16].

**Figure 3.1 Major processes for manufacturing of cellulosic biofuels (after [8,9])**

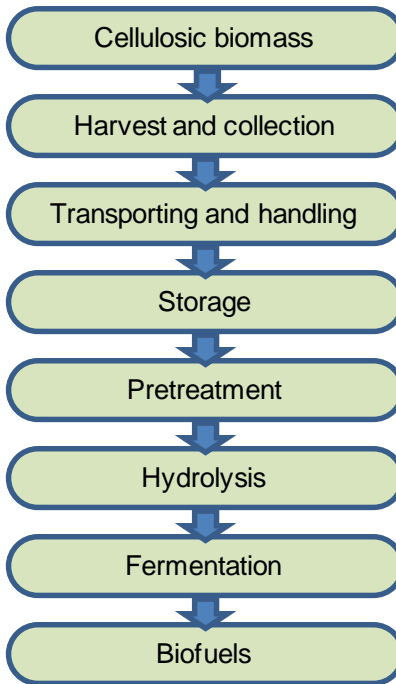

The high costs related to cellulosic feedstock production and logistics (e.g. transportation and storage) can constitute 35% or more of total manufacturing costs of cellulosic biofuels [15,17]. Specifically, the logistics associated with transportation and storage of low-density biomass can make up more than 50% of the feedstock costs [11]. If cellulosic biomass is pelleted, its density is increased and handling efficiencies are improved [18,19], resulting in a reduction in logistics costs [11]. Traditional pelleting methods (e.g. using a screw extruder, a briquetting press, or a rolling machine [20,21]) generally involve high-temperature steam and high pressure, and often use binder materials, making it difficult to realize cost-effective pelleting on or near the field where cellulosic biomass is available. Ultrasonic vibration-assisted (UV-A) pelleting, without using high-temperature steam and binder materials, can produce biomass pellets whose density is comparable to that processed by traditional pelleting methods [22,23].

The purpose of pretreatment of cellulosic biomass in manufacturing of biofuels is illustrated in Figure 3.2. Pretreatment can break the lignin seal and disrupt the crystalline structure of cellulose, increasing its surface area and making it more accessible to enzyme hydrolysis [5,9]. The goal of hydrolysis is to break down cellulose into its component sugars that are convertible to ethanol by fermentation [5,9]. A number of different pretreatment approaches have been investigated, including biological (such as enzymes and bacteria) [24,25], chemical (such as sulfuric acid, sulfur dioxide, and ammonia) [26-31], physical (such as heat and ultrasonics) [32,33], and thermal means [34-36]. So far, only those that employ chemicals offer the high yield vital to economic success [26-30].

It has been reported that use of ultrasonics during pretreatment (of “wet” biomass) is beneficial to hydrolysis and ethanol fermentation [32,37,38]. Until now, there have been no reports about the effects of ultrasonic vibration during pelleting (of “dry” biomass) on hydrolysis and ethanol fermentation.

**Figure 3.2 Purpose of pretreatment in biofuel manufacturing (after [5])**

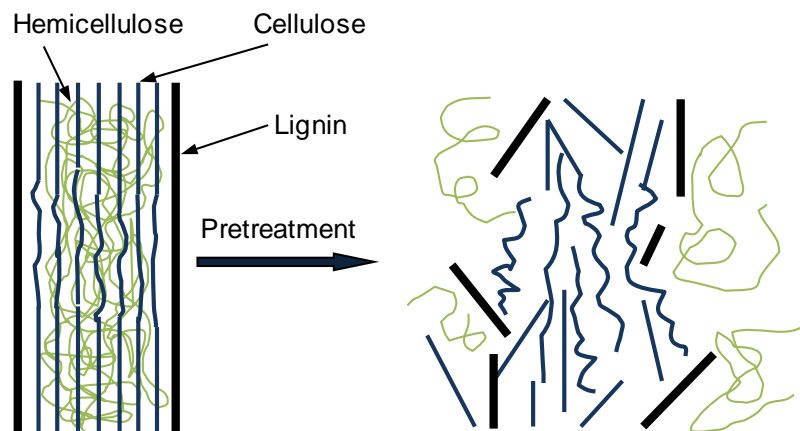



Most publications on pelleting deal with biomass pellets that were used as either feed or fuels (not as feedstocks for conversion to liquid biofuels) [39,40]. The pelleting literature includes economical analyses [19,39,41,42] as well as experiments on effects of pelleting process variables (such as compressive force or pressure, temperature, particle size, moisture content, and binder type and content) on pellet mechanical properties (such as density, stability, and durability) [43-51]. So far, there are few publications on effects of pelleting on pretreatment and biofuel conversion, and none on UV-A pelleting of biomass.

This paper reports experimental investigations on UV-A pelleting of cellulosic feedstocks. Effects of process variables (ultrasonic vibration, moisture content, and particle size) on output variables (pellet density, stability, durability, pelleting force, and yield of biofuel conversion) have been studied over several biomass types (including sorghum stalks, switchgrass, and wheat straw).

## **3.2 Experimental procedure and conditions**

### ***3.2.1 Major steps in UV-A pelleting experiments***

Major steps in UV-A pelleting experiments are shown in Figure 3.3. Biomass samples were milled into powder using a cutting mill (model SM 2000, Retsch, Inc., Haan, Germany) with different sieve sizes. Moisture contents of the biomass powder after milling were measured and adjusted to the desired levels before pelleting. A Sonic-Mill rotary ultrasonic machine (Sonic-Mill, Albuquerque, NM, USA) was used to perform pelleting. After UV-A pelleting, a cylinder shaped pellet was obtained.

**Figure 3.3 Major steps of UV-A pelleting experiments**

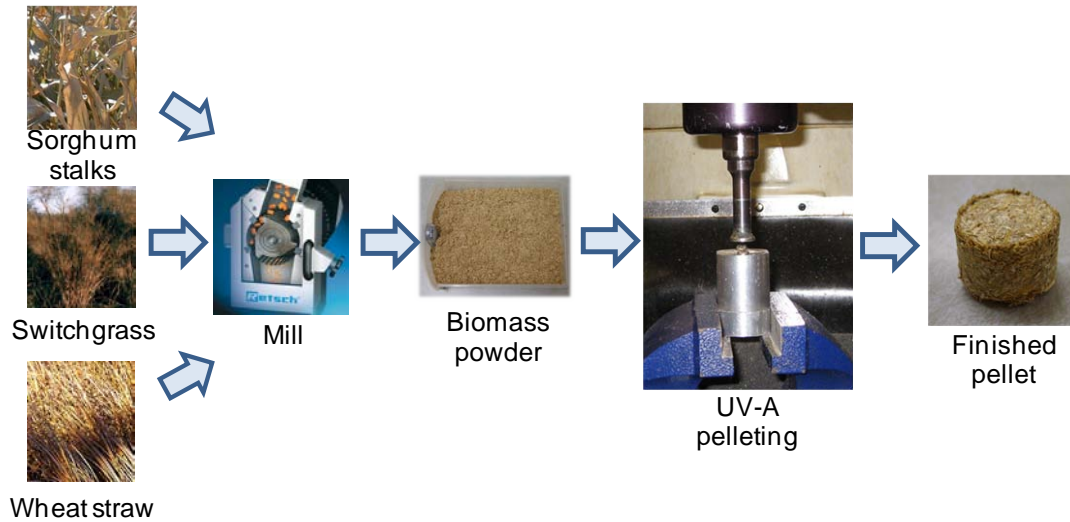

### ***3.2.2 Illustration of UV-A pelleting process***

Figure 3.4 illustrates the process of UV-A pelleting. The tool was mounted to a rotary ultrasonic spindle that provided both rotation and ultrasonic vibration to the tool. The molds were made in two separate parts, the top part a hollow cylinder and the bottom a disk-shaped base, which were assembled together with two screws. Biomass was loaded into the center cavity of the mold, and the tool was fed into this cavity at a certain feedrate. The diameter of the tool (17.4 mm) was slightly smaller than that of the central hole (18.6 mm) in the mold. When the tool reached a selected depth inside the cavity, it was retracted and the mold disassembled to unload the pellet.

**Figure 3.4 Illustration of UV-A pelleting process**

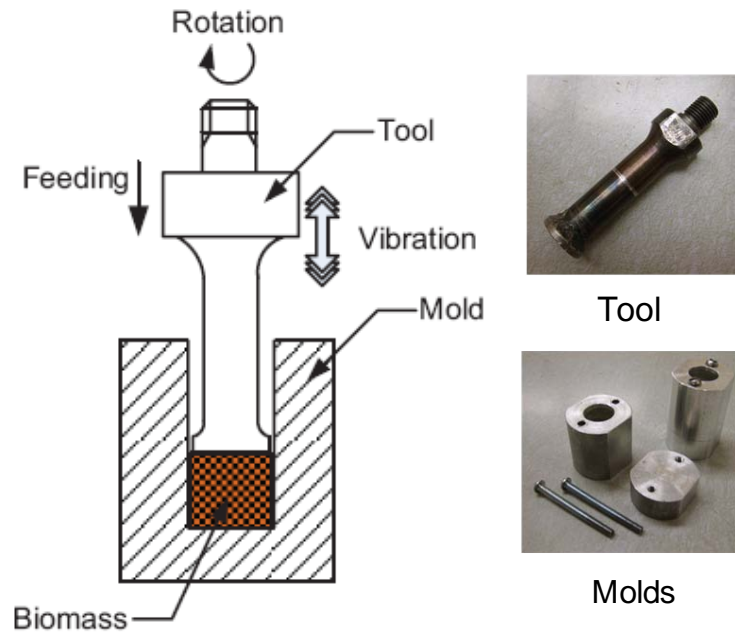

### ***3.2.3 Important process variables***

#### ***3.2.3.1 Moisture content of biomass powder***

Moisture content represents the amount of moisture (water) contained in a certain amount of biomass. A higher moisture content means more water in the biomass material. Moisture content was calculated by the ratio of the weight of the water in the biomass material to the total weight of the biomass material. After measuring the initial moisture content of the biomass powder, a certain amount of distilled water was sprayed on the biomass powder to adjust the moisture content to the desired levels. Three moisture content levels (9%, 15%, and 20%) were used for the investigations.

### ***3.2.3.2 Particle size of biomass powder***

The particle size of the biomass powder was controlled by a sieve in the mill, as shown in Figure 3.5. Five different sieves (whose hole diameters were 0.25, 1, 1.5, 2, and 8 mm respectively) were used for the investigations.

**Figure 3.5 A sieve used in the cutting mill to control the particle size of the biomass powder**

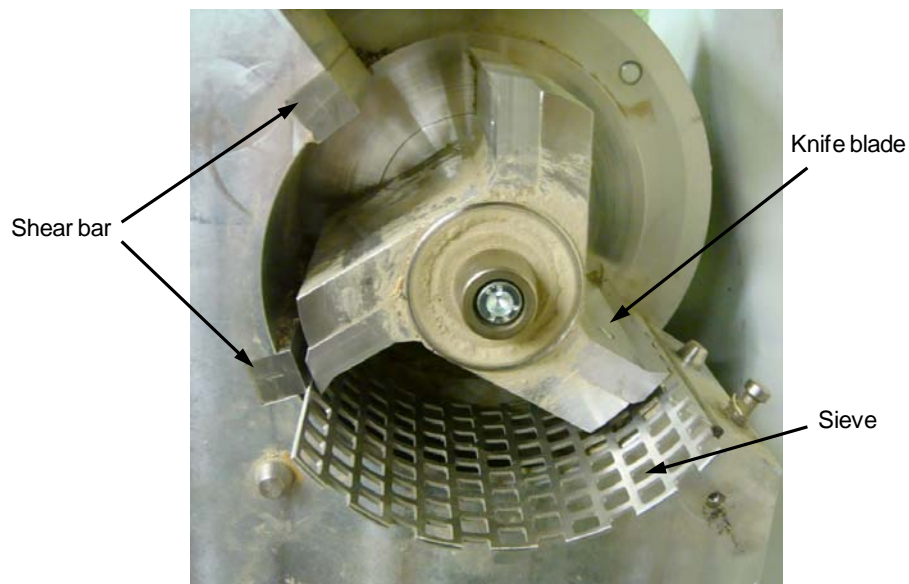

### ***3.2.3.3 Ultrasonic vibration of the tool***

The vibration frequency of the tool was fixed at 20 kHz. The vibration amplitude of the tool was controlled by ultrasonic power. A larger ultrasonic power percentage produced a higher vibration amplitude. Two levels of ultrasonic power used for the investigations were 25% (corresponding to about 10  $\mu\text{m}$  of vibration amplitude) and 35% (corresponding to about 24  $\mu\text{m}$  of vibration amplitude).

### 3.2.3.4 Other process variables

Other process variables were kept the same for the investigations. The feedrate of the tool was 0.267 mm/s, and the tool rotation speed was 50 rpm. Three grams of biomass powder was put into the cavity of the mold to produce one pellet. The stop position of the tool (in the cavity of the mold) was constant for every pellet, as shown in Figure 3.6 where H was the height of the pellet before being taken out from the mold and when the tool hit its stop position before retracting.

**Figure 3.6 Illustration of the stop position of the tool**

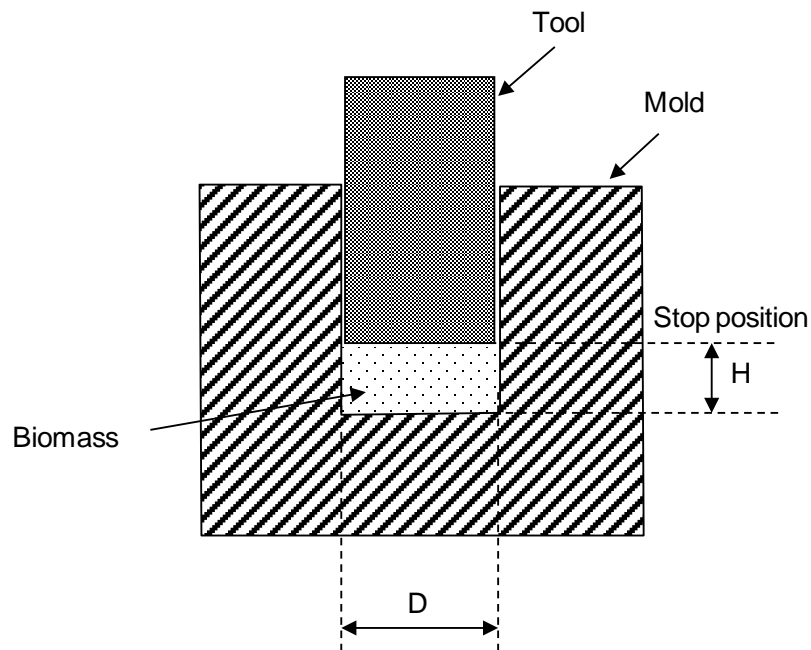

### 3.2.4 Measurements of output variables

#### 3.2.4.1 Pellet density

Density of a pellet was calculated by the ratio of its weight over its volume. The weight of pellets was measured by an electronic scale (model TAJ602, Ohaus, Pine Brook, NJ, USA).

The volume of pellets was obtained by measuring the height and diameter of the pellets with a caliper. For all of the tests, the density of each pellet was recorded once a day for 10 days.

#### ***3.2.4.2 Pellet stability***

Stability of a pellet was determined by evaluating changes in its dimensions (or volume) with time. A general trend was observed: the volume of the pellets would increase (spring-back) with time after they were taken out from the mold. The stability of the pellets was measured by the spring-back of the pellets which was calculated by

$$\text{Spring-back} = \frac{\text{Measured volume} - \text{Initial pellet volume}}{\text{Initial pellet volume}}$$

where, measured volume is the volume of pellets measured every day after the pellets were taken out from the mold, and initial pellet volume is the theoretical volume of the pellet calculated by the diameter of the mold cavity and the stop position of the tool. For each pellet, the spring-back was measured once a day for 10 days.

#### ***3.2.4.3 Pellet durability***

Pellet durability is the ability of the pellet to withstand impact and other forces encountered during handling and transportation [52]. It is determined by following the ASABE standard S269.4 [52]. Five hundred grams of pellets were kept tumbling inside a pellet durability tester (Seedburo Equipment, Des Plaines, IL, USA) for 10 minutes and then sieved through a U.S. No. 6 sieve. The pellet durability index was calculated as the ratio of the weight of the remaining pellets (that did not fall through the No. 6 sieve) after tumbling to the weight of the pellets before tumbling.

#### ***3.2.4.4 Pelleting force***

Forces in the tool axial direction were measured during pelleting with and without

ultrasonic vibration. As shown in Figure 3.7, the pelleting force measurement system included a piezoelectric dynamometer (Kistler 9272, Kistler Instrument Corp, Amherst, NY, USA), an amplifier, an A/D converter, and a computer with Lab-VIEW software package (Version 5.1, National Instruments, Austin, TX, USA). The mold was clamped by a fixture mounted on top of a dynamometer.

**Figure 3.7 Illustration of pelleting force measurement**

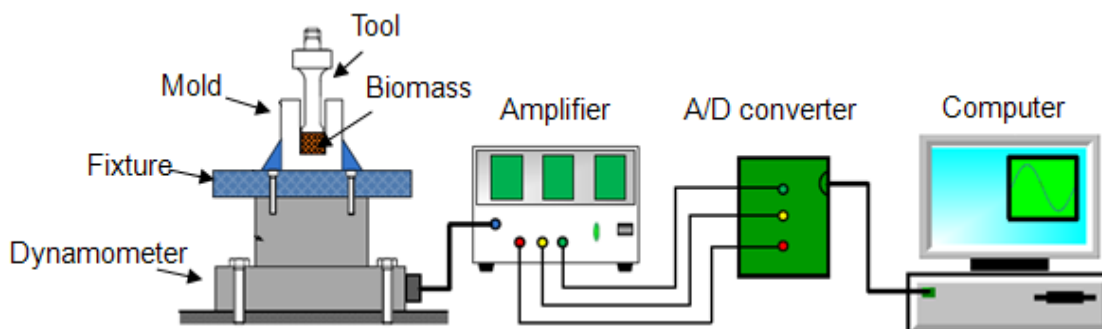

#### **3.2.4.5 Sugar yield**

Pretreatment was carried out in a pressure reactor apparatus (Parr Instrument Company, Moline, IL, USA) equipped with impeller mixers and a pressurized injection device. Dissociated biomass was mixed with a sulfuric acid solution to obtain 10% dry matter. The slurry was loaded into a 1-L reactor and treated at a temperature of 180°C for 15 minutes with diluted sulfuric acid (at a ratio of 20 g per liter of distilled water). Enzyme hydrolysis of pretreated biomass was conducted, following the NREL LAP procedure [53], in sealed serum bottles in a 50°C reciprocal water bath shaker running at 100 rpm for 72 hours. The enzyme used in the hydrolysis was Accellerase 1500 from Genencor (Rochester, NY, USA).

### 3.3 Results on pellet density

#### 3.3.1 Effects of ultrasonic vibration

Figure 3.8 shows a density comparison between pellets processed with and without ultrasonic vibration using switchgrass (with a 1 mm sieve, and 15% moisture content). The density of the pellets processed with ultrasonic vibration was consistently higher than that without ultrasonic vibration. For all density measurements, at least four pellets were measured and average values were used. Similar results were found from the tests using sorghum stalks (with a 1 mm sieve, and 15% moisture content) [22].

**Figure 3.8 Effects of ultrasonic vibration on switchgrass pellet density**

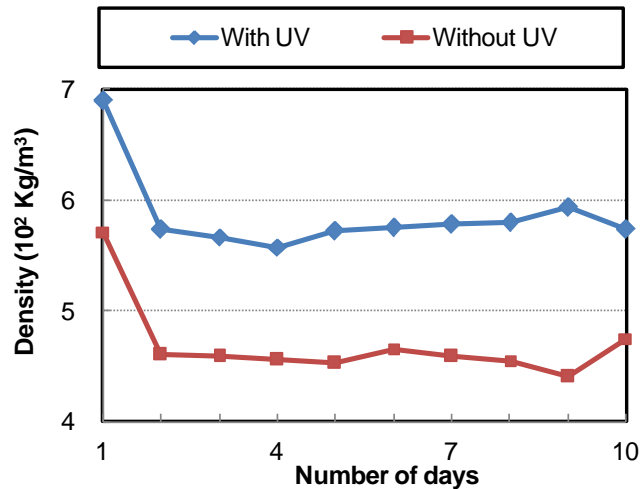

#### 3.3.2 Effects of moisture content

Figure 3.9 shows the effects of moisture content on pellet density in UV-A pelleting of switchgrass (with a 1 mm sieve). The milled powder with a lower moisture content produced pellets with a higher density. Similar results were obtained from the pellets made of wheat straw.



**Figure 3.9 Effects of MC on switchgrass pellet density**

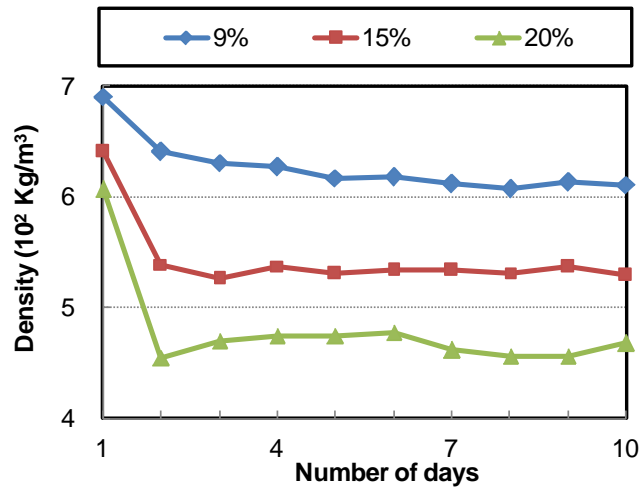

### ***3.3.3 Effects of particle size***

Figure 3.10 shows the effects of particle size on pellet density in UV-A pelleting of wheat straw (with 7% moisture content). The results show a clear trend: a smaller particle size produced a higher density. Pellets were also produced with mixed particle sizes. For example, one half of the milled wheat straw (by weight) had a particle size of 0.25 mm and the other half have a size of 8 mm. They were mixed together thoroughly. The density of the pellets with mixed particle sizes was higher than that of the pellets with one particle size alone, as shown in Figure 3.11.

**Figure 3.10 Effects of particle size on pellet density**

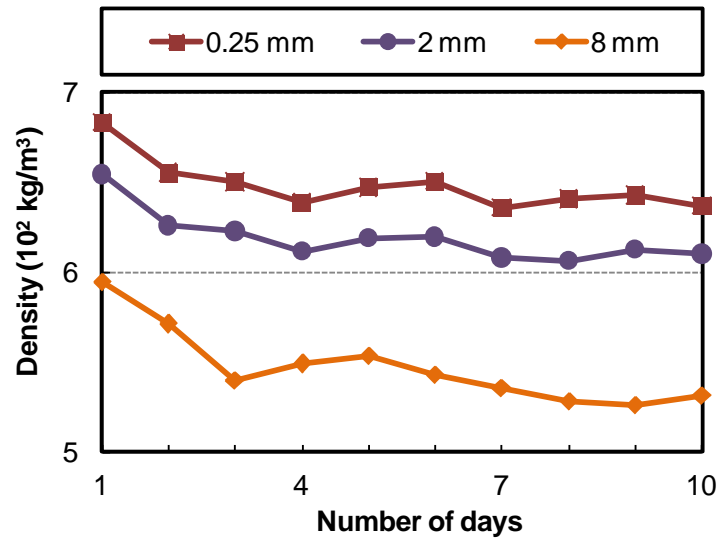

**Figure 3.11 Effects of mixed particle sizes on pellet density**

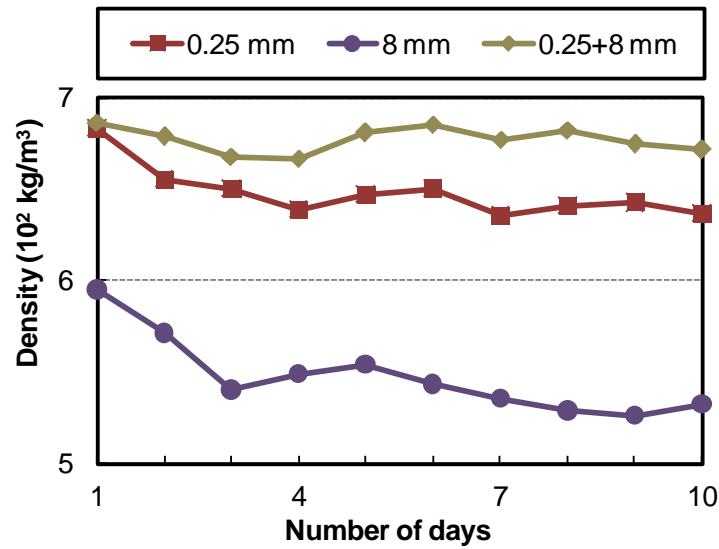

### 3.4 Results on pellet stability

#### 3.4.1 Effects of ultrasonic vibration

Figure 3.12 shows a stability comparison between pellets processed with and without ultrasonic vibration using switchgrass (with a 1 mm sieve, and 15% moisture content). It is clear that the pellets processed with ultrasonic vibration were more stable (or had smaller spring-back). A similar result was observed with sorghum stalks.

**Figure 3.12 Effects of ultrasonic vibration on pellet stability**

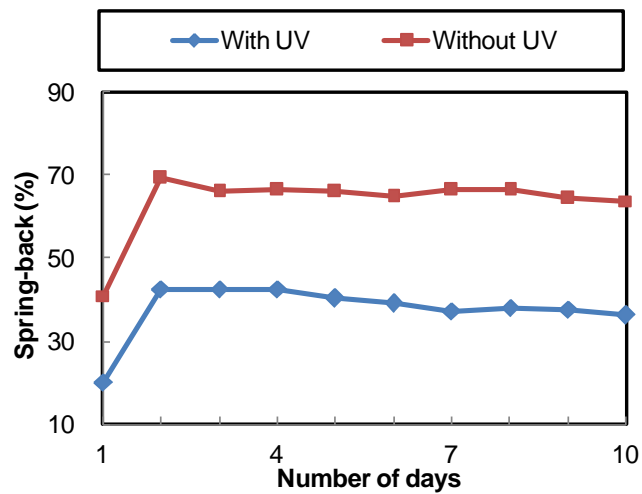

#### 3.4.2 Effects of moisture content

Figure 3.13 shows the effects of moisture content on pellet stability (spring-back) in UV-processed pellets of switchgrass (with a 1 mm sieve). It can be seen that spring-back increased as moisture content increased from 9% to 20%. A similar trend was observed with wheat straw.

**Figure 3.13 Effects of MC on pellet stability**

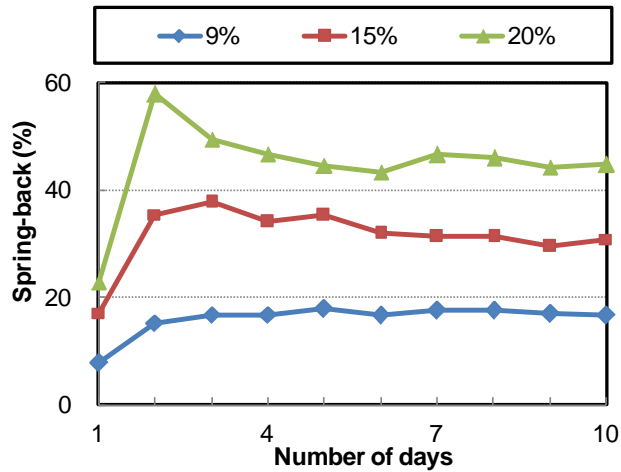

### 3.4.3 Effects of particle size

Figure 3.14 shows the effects of particle size on pellet stability in UV-A pelleting of wheat straw (with 7% moisture content). Pellets with a smaller particle size were more stable (or had smaller spring-back). As shown in Figure 3.15, the spring-back of the pellets with mixed particle sizes (0.25 and 8 mm) was larger than that of the pellets with a particle size of 0.25 mm but smaller than that of the pellets with a particle size of 8 mm.

**Figure 3.14 Effects of particle size on pellet stability**

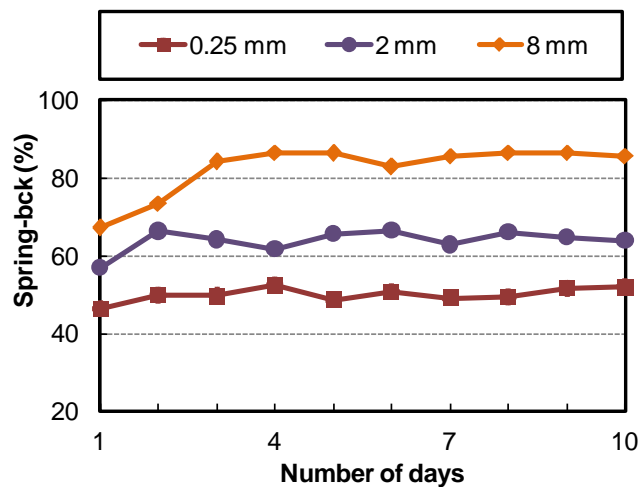

**Figure 3.15 Effects of mixed particle sizes on pellet stability**

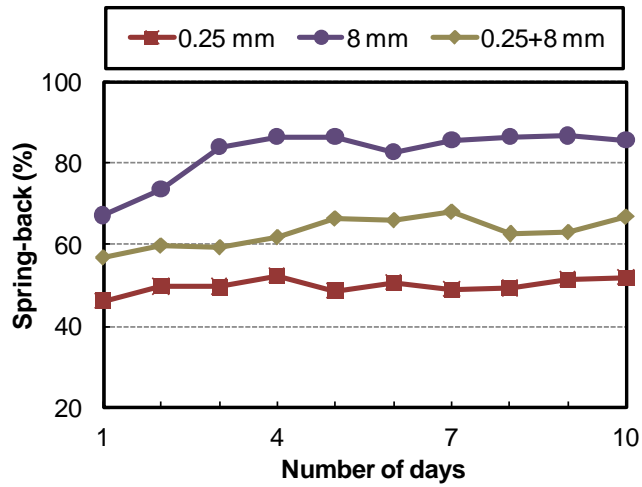

### **3.5 Results on pellet durability**

#### ***3.5.1 Effects of ultrasonic vibration***

Figure 3.16 shows the durability comparison between pellets processed with and without ultrasonic vibration using switchgrass (with a 1 mm sieve, and 15% moisture content). The durability index for the pellets with ultrasonic vibration was 40%, measured after 10 minutes of tumbling. However, the pellets processed without ultrasonic vibration did not survive after two minutes of tumbling.

**Figure 3.16 Effects of ultrasonic vibration on durability**

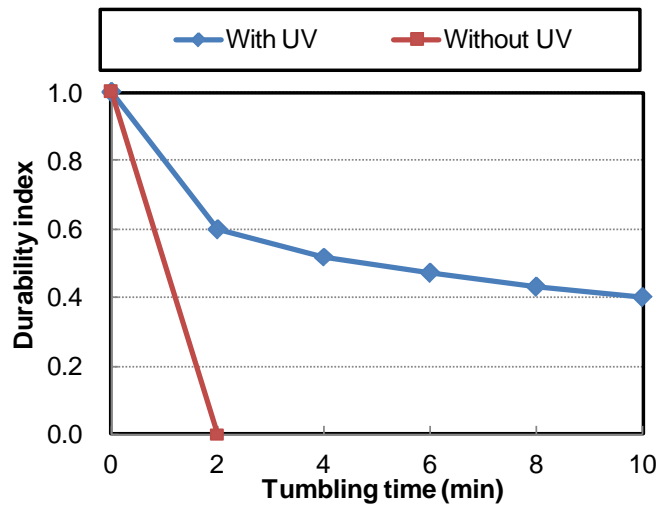

### ***3.5.2 Effects of moisture content***

Figure 3.17 shows the effects of moisture content on pellet durability in UV-A pelleting of switchgrass (with a 1 mm sieve). It can be seen that 9% moisture content produced pellets that had the highest durability index, while pellets with 15% and 20% moisture content produced pellets that had a similar durability index value.

**Figure 3.17 Effects of moisture content on durability**

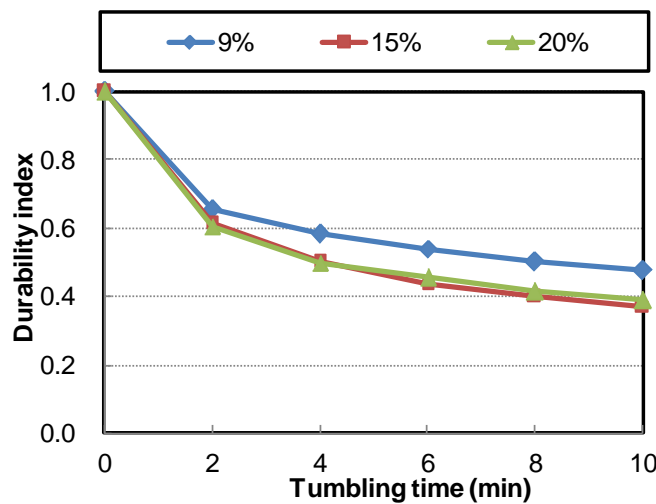

### 3.6 Results on pelleting force

As shown in Figure 3.18, the maximum force with ultrasonic vibration was only about two third of that without ultrasonic vibration. In both cases, the force kept increasing from the beginning of the pelleting till the end of the pelleting.

**Figure 3.18 Effects of ultrasonic vibration on pelleting force**

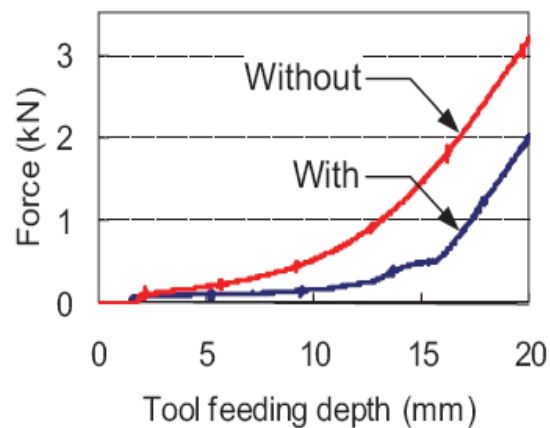

### 3.7 Results on sugar yield

The biofuel conversion was compared among three groups (200 g each) of switchgrass (with a 1 mm sieve, and 20% moisture content): milled switchgrass powder (without pelleting), pelleted with ultrasonic vibration, and pelleted without ultrasonic vibration. Half of the samples in each group were further processed through two more important steps in biofuel (ethanol) production from cellulosic biomass: pretreatment and enzyme hydrolysis; and half of the samples were processed through enzyme hydrolysis without pretreatment.

Figure 3.19 shows the effects of UV-A pelleting on sugar (glucose) yield with and without pretreatment (using a sulfuric acid). With pretreatment, the sugar yield after UV-A pelleting (86.4%) was 23% higher than the sugar yield without UV-A pelleting (69.9% for non-

pelleted switchgrass and 70.3% for switchgrass pelleted without ultrasonic vibration). Without pretreatment, the sugar yield after UV-A pelleting (24.7%) was 75% higher than the sugar yields without UV-A pelleting (13.6% for non-pelleted switchgrass and 14% for switchgrass pelleted without ultrasonic vibration). Since the ethanol yield (from fermentation) is proportional to the sugar yield [54], UV-A pelleting will increase ethanol yield by more than 20% after fermentation.

**Figure 3.19 Effects of UV-A pelleting on sugar yield**

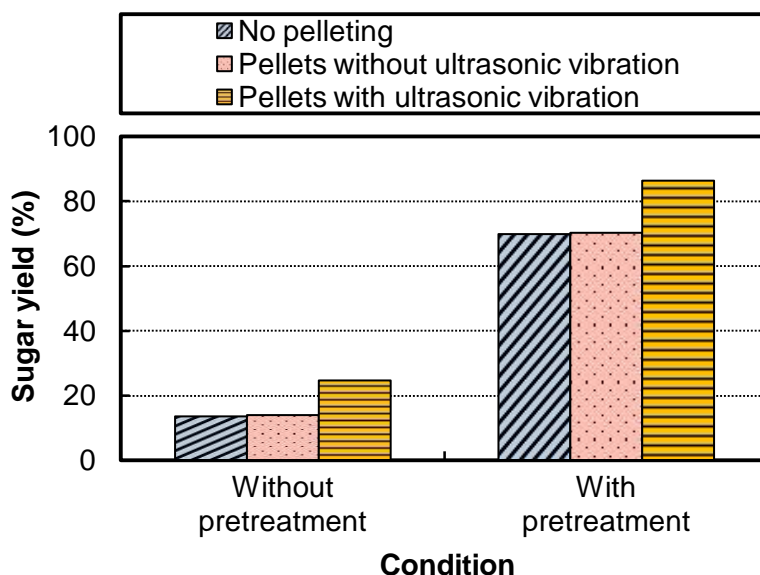

### 3.8 Conclusions

This paper reports experimental investigations on ultrasonic vibration-assisted (UV-A) pelleting of three types of cellulosic biomass (sorghum stalks, switchgrass, and wheat straw). Major conclusions are:

1. Pelleting with ultrasonic vibration can produce pellets with higher density, stability, and durability than without ultrasonic vibration. Ultrasonic vibration can also reduce pelleting force.



2. Moisture content and particle size of the milled biomass have significant effects on density, stability, and durability of the pellets.
3. Compared with non-pelleted biomass or biomass pelleted without ultrasonic vibration, UV-A pelleted biomass can increase sugar yield (ethanol yield) by more than 20%.

### **Acknowledgements**

The authors gratefully extend their acknowledgements to Daniel Nottingham, Emily Jones, Rob Clark, Qiang Feng, Na Qin, Xiaoxu Song, and Qi Zhang at Kansas State University for their help in conducting experiments, and Mr. Clyde Treadwell at Sonic Mill for his technical support on experimental equipment.

### **References**

- [1] U.S. Department of Energy, 2008, Energy Consumption by Sector (1949-2008), <http://www.eia.doe.gov/emeu/aer/txt/ptb0201a.html>
- [2] U.S. Department of Energy, 2008, Petroleum Products Supplied by Type (1949-2008), <http://www.eia.doe.gov/emeu/aer/txt/ptb0511.html>
- [3] U.S. Department of Energy, 2008, Transportation Sector Energy Consumption Estimates (2007), [http://www.eia.doe.gov/emeu/states/sep\\_sum/html/sum\\_btu\\_tra.html](http://www.eia.doe.gov/emeu/states/sep_sum/html/sum_btu_tra.html)
- [4] National Academy of Sciences, National Academy of Engineering, and National Research Council, 2009, *Liquid Transportation Fuels from Coal and Biomass*, The National Academies Press, Washington, US.
- [5] U.S. Department of Energy, 2009, Breaking the Biological Barriers to Cellulosic Ethanol: A Joint Research Agenda, <http://genomicscience.energy.gov/biofuels/b2bworkshop.shtml>

- [6] Fairfax Media, 2008, US Pumps More Money into Cellulosic Ethanol Research, <http://sl.farmonline.com.au/news/nationalrural/agribusiness-and-general/general/us-pumps-more-money-into-cellulosic-ethanol-research/1234385.aspx>
- [7] Perlack, R.D., Wright, L.L., Turhollow, A.F., Graham, R.L., Stokes, B.J., and Erbach, D.C., 2005, "Biomass as Feedstocks for a Bioenergy and Byproducts Industry: The Technical Feasibility of a Billion-Ton Annual Supply," DOE Technical paper, GO-102005-2135.
- [8] Moresco, J., 2008, U.S. Biofuel Output to Miss Mandates, <http://www.redherring.com/Home/25682>
- [9] Rubin, E. M., 2008, "Genomics of Cellulosic Biofuels," *Nature*, 454(14), pp. 841-845.
- [10] Huber, G.W., 2008, Breaking the Chemical and Engineering Barriers to Lignocellulosic Biofuels: Next Generation Hydrocarbon Biorefineries, <http://www.ecs.umass.edu/biofuels/Images/Roadmap2-08.pdf>
- [11] Hess, J.R., Wright, C.T., and Kenney, K.L., 2007, "Cellulosic Biomass Feedstocks and Logistics for Ethanol Production," *Biofuels, Bioproducts and Biorefining*, 1(3), pp. 181–190.
- [12] Waves, A., 2009, Ethanol Faces Challenges Ahead, <http://naturalresourcereport.com/2009/08/ethanol-faces-challenges-ahead/>
- [13] Kho, J., 2009, Fuel From Utility Poles: Cellulosic Ethanol Heats Up in Cool Economy, <http://cleantechnica.com/2009/01/19/fuel-from-utility-poles-cellulosic-ethanol-heats-up-in-cool-economy/>
- [14] Yang, B., and Wyman, E., 2008, "Pretreatment: The Key to Unlocking Low-Cost Cellulosic Ethanol," *Biofuels, Bioproducts, and Biorefining*, 2(1), pp. 26-40.

- [15] Aden, A., Ruth, M., Ibsen, K., Jechura, J., Neeves, K., Sheehan, J., Wallace, B., Montague, L., Slayton, A., and Lukas, J., 2002, "Lignocellulosic Biomass to Ethanol Process Design and Economics Utilizing Co-Current Dilute Acid Prehydrolysis and Enzymatic Hydrolysis for Corn Stover," NREL Technical paper, TP-510-32438.
- [16] Wooley, R., Ruth, M., Sheehan, J., Ibsen, K., Majdeski, H., and Galvez, A., 1999, "Lignocellulosic Biomass to Ethanol Process Design and Economics Utilizing Co-Current Dilute Acid Prehydrolysis and Enzymatic Hydrolysis Current and Futuristic Scenarios," NREL Technical Paper, TP-580-26157.
- [17] Phillips, S., Aden, A., Jechura, J., Dayton, D., and Eggeman, T., 2007, "Thermochemical Ethanol Via Indirect Gasification and Mixed Alcohol Synthesis of Lignocellulosic Biomass," NREL Technical Paper, TP-510-41168.
- [18] Leaver, R.H., 1984, *The Pelleting Process*, Sprout-Waldron, Muncy, PA, US.
- [19] Robinson, R.A., 1975, "The Pelleting of Millfeed," Bull. Assoc. Opera. Millers, July, pp. 3545-3549.
- [20] Mani, S., Tabil, L.G., and Sokhansanj, S., 2003, "An Overview of Compaction of Biomass Grinds," Powder Handling Proc., 15(3), pp. 160-168.
- [21] Sokhansanj, S., Mani, S., and Zaini, P., 2005, "Binderless Pelletization of Biomass," ASABE Technical Paper, 056061.
- [22] Pei, Z.J., Wang, D.H., and Clark, R., 2009, "Ultrasonic Vibration-Assisted Pelleting of Cellulosic Biomass: A Preliminary Experiment," *Proceedings of the 2009 International Manufacturing Science and Engineering Conference*, West Lafayette, IN, US, October 4-7, MSEC2009-84205.

- [23] Cong, W.L., Zhang, P.F., Qin, N., Zhang, M., Song, X.X., Zhang, Q., Nottingham, D., Clark, R., Deines, T., Pei, Z.J. and Wang, D.H., 2009, "Ultrasonic Vibration-Assisted Pelleting of Cellulosic Biomass for Biofuel Manufacturing," *Poster presentation at the 2009 International Manufacturing Science and Engineering Conference*, West Lafayette, IN, US, October 4-7, MSEC2009-84432.
- [24] Lyberatos, G., and Nzihou, A., 2009, "Biological and Pretreatment Processes for the Valorization of Waste and Biomass Into Energy/Fuel and Useful Materials," *Bioresource Technol.*, 100(15), pp. 3689.
- [25] Sawada, T., Nakamura, Y., Kobayashi, F., Kuwahara, M., and Watanabe, T., 1995, "Effects of Fungal Pretreatment and Steam Explosion Pretreatment on Enzymatic Saccharification of Plant Biomass," *J. Biosci. Bioeng.*, 48(6), pp. 719-724.
- [26] Taylor, T.A., and Dorfman, S.J., 2008, Federal Government Betting Big on Cellulosic Biofuels, [http://www.fredlaw.com/articles/energy/energy\\_tat\\_sjd\\_0807.html](http://www.fredlaw.com/articles/energy/energy_tat_sjd_0807.html)
- [27] Hsu, T.A., 1996, *Handbook on Bioethanol: Production and Utilization*, CRC Press, Boca Raton, FL, US.
- [28] McMillan, J.D., 1994, *Pretreatment of Lignocellulosic Biomass*, American Chemical Society, Washington, US.
- [29] Mosier, N.S., Wyman, C.E., Dale, B.E., Elander, R., Holtzapple, M., and Ladisch, M.R., 2005, "Features of Promising Technologies for Pretreatment of Lignocellulosic Biomass," *Bioresource Technol.*, 96(6), pp. 673–686.
- [30] Wyman, C., Dale, B.E., Elander, R.T., Holtzapple, M., Ladish, M.R., and Lee, Y.Y., 2005, "Coordinated Development of Leading Biomass Pretreatment Technologies," *Bioresource Technol.*, 96(18), pp. 1959-1966.

- [31] Dong, D.X., Sun, J., Huang, F.Y., Gao, Q., Wang, Y., and Li, R.X., 2009, "Using Trifluoroacetic Acid to Pretreat Lignocellulosic Biomass," *Biomass and Bioenergy*, 33(12), pp. 1719-1723.
- [32] Toma, M., Bandow, H., Vinatoru, M., and Maeda, Y., 2006, "Ultrasonically Assisted Conversion of Lignocellulosic Biomass to Ethanol," *Proceedings of AIChE Annual Meeting*, San Francisco, CA, US, November 12-17.
- [33] Sears, K.J., Alleman, J.E., and Gong, W.L., 2005, "Feasibility of Using Ultrasonic Irradiation to Recover Active Biomass From Waste Activated Sludge," *J. Biotechnol.*, 119(4), pp. 389-399.
- [34] He, W., Park, C.S., and Norbeck, J.M., 2009, "Rheological Study of Comingled Biomass and Coal Slurries With Hydrothermal Pretreatment," *Energy and Fuels*, 23(10), pp. 4763-4767.
- [35] Hosseini, S.A., and Shah, N., 2009, "Multiscale Modelling of Hydrothermal Biomass Pretreatment for Chip Size Optimization," *Biosource Technol.*, 100(9), pp. 2621-2628.
- [36] Yan, W., Acharjee, T.C., Coronella, C.J., and Vasquez, V.R., 2009, "Thermal Pretreatment of Lignocellulosic Biomass," *Environ. Prog. Sustain. Energy*, 28(3), pp. 435-440.
- [37] Wood, B.E., Aldrich, H.C., and Ingram, L.O., 1997, "Ultrasound Stimulates Ethanol Production During the Simultaneous Saccharification and Fermentation of Mixed Waste Office Paper," *Biotechnol. Prog.*, 13(3), pp. 232-237.
- [38] Montalbo-Lomboy, M., Srinivasan, G., Raman, D.R., Anex Jr., R.P., and Grewell, D., 2007, "Influence of Ultrasonics in Ammonia Steeped Switchgrass for Enzymatic Hydrolysis," *ASABE Technical Papers*, 076231.

- [39] Mani, S., Sokhansanj, S., Bi, X., and Turhollow, A., 2006, "Economics of Producing Fuel Pellets from Biomass," *Appl. Eng. Agric.*, 22(3), pp. 421-426.
- [40] Salter, D.E., 1982, "Production of Fuel Pellets by the Densification of Biomass," *Proceedings of the 8th Annual Conference of Solar Energy Society of Canada*, Winnipeg, Manito, Canada, pp. 1130-1132.
- [41] Sokhansanj, S., and Turhollow, A., 2004, "Biomass Densification-Cubing Operations and Costs for Cornstover," *Appl. Eng. Agric.*, 20(4), pp. 495-499.
- [42] Mani, S., Bi, X., and Sokhansanj, S., 2005, "Environmental Systems Assessment of Biomass Densification Process," *CSAI Technical Paper*, 05081.
- [43] Mani, S., Sokhansanj, S., Bi, X., and Tabil, L.G., 2004, "Compaction of Corn Stover," *ASABE Technical Paper*, 041160.
- [44] Mani, S., Tabil, L.G., and Sokhansanj, S., 2006, "Effects of Compressive Force, Particle Size and Moisture Content on Mechanical Properties of Biomass Pellets From Grasses," *Biomass and Bioenergy*, 30(7), pp. 648-654.
- [45] Gustafson, A.S., and Kjelgaard, W.L., 1963, "Hay Pellet Geometry and Stability," *Agric. Eng.*, 44(8), pp. 442-445.
- [46] Srivastava, A.C., Bilanski, W.K., and Graham, V.A., 1981, "Feasibility of Producing Large Size Hay Wafers," *Can. Agric. Eng.*, 23(2), pp. 109-112.
- [47] Orth, H.W., and Lowe, R., 1977, "Influence of Temperature on Wafering in a Continuous Extrusion Process," *J. Agric. Eng. Res.*, 22(3), pp. 283-289.
- [48] Bilanski, W.K., Graham, V.A., and Hanusiak, J.A., 1985, "Mechanics of Bulk Forage Deformation With Application to Wafering," *Trans. Am. Soc. Agric. Eng.*, 28(3), pp. 697-702.

- [49] Reece, F.N., 1966, "Temperature, Pressure and Time Relationships in Forming Dense Hay Wafers," *Trans. Am. Soc. Agric. Eng.*, 9(6), pp. 749-751.
- [50] Smith, I.E., Probert, S.D., Stokes, R.E., and Hansford, R.J., 1977, "The Briquetting of Wheat Straw," *J. Agric. Eng. Res.*, 22(2), pp. 105-111.
- [51] Faborode, M.O., 1990, "Analysis of Extrusion Compaction of Fibrous Agricultural Residues for Fuel Applications," *Biomass*, 21(2), pp. 115-128.
- [52] ASABE Standard S269.4, 2002, "Cubes, Pellets, and Crumbles-Definitions and Methods for Determining Density, Durability, and Moisture Content," American Society of Agricultural and Biological Engineers, St. Joseph, US.
- [53] Selig, M., Weiss, N., and Ji, Y., 2008, "Enzymatic Saccharification of Lignocellulosic Biomass," NRELLAP Technical Paper, NREL/TP-510-42629.
- [54] Nigam, J.N., 2002, "Bioconversion of Water-yacinth (*Eichhornia Crassipes*) Hemicellulose Acid Hydrolysate to Motor Fuel Ethanol by Xylose-Fermenting Yeast," *Journal of Biotechnology*, 97(2), pp. 107-116.

## **Chapter 4 - effects of biomass moisture content on pellet quality**

This chapter presents an experimental investigation on the effects of biomass moisture content on pellet quality (density, spring-back, and durability). Results are measured at three levels of moisture content while keeping all other process variables constant. It is found that moisture content has great effects on pellet quality. Lower moisture content leads to higher pellet density, lower spring-back, and higher durability. The content of this chapter has been published as a technical paper.

### Paper title:

Ultrasonic vibration-assisted pelleting of switchgrass: effects of moisture content on pellet density, spring-back, and durability

### Published in:

Proceedings of the Flexible Automation and Intelligent Manufacturing (FAIM) international conference, July 12-14, 2010, Oakland, CA, USA.

### Author's names:

Pengfei Zhang, Timothy Deines, Weilong Cong, Na Qin, Z.J. Pei, Daniel Nottingham

### Author's Affiliation:



Department of Industrial and Manufacturing Systems Engineering, Kansas State University, 2037 Durland Hall, Manhattan, KS 66506

## **Abstract**

Biofuels can be used to replace traditional liquid transportation fuels. Cellulosic biomass is one type of feedstocks in manufacturing of biofuels. The low density of cellulosic feedstocks causes high transportation and storage cost that hinders the large-scale production of cellulosic biofuels. Unlike traditional pelleting methods, ultrasonic vibration-assisted (UV-A) pelleting can produce pellets of comparable density without using high-temperature steam and binder materials. The moisture content of the biomass material before pelleting is an important parameter in UV-A pelleting. This paper reports an experimental investigation on effects of moisture content on pellet density, spring-back, and durability in UV-A pelleting of switchgrass.

## **4.1 Introduction**

In the last three decades, the consumption of the liquid transportation fuels in the U.S. increased by 50% [1]. Most of these liquid transportation fuels are distilled from petroleum and account for 70% of total petroleum consumption [1-3]. The increasing demand for liquid transportation fuels increases the demand for petroleum [4]. The petroleum reserve is not uniformly distributed around the world. The dependence of the U.S. on foreign petroleum has increased significantly from 1980 to 2008 [5]. Concerns for the reliable supply of liquid transportation fuels in the future are driving people to find alternative sources to petroleum. Biofuels are an attractive candidate to replace the traditional liquid transportation fuels. This is due to their merits in renewability and their suitability for combustion engines [6-9].

Cellulosic biomass can be used as feedstocks for biofuel manufacturing. There is abundant source of various types of cellulosic biomass in different areas of the U.S., enough to replace about 30% of current consumption of liquid transportation fuels [10]. In contrast to other potential feedstocks (e.g. corn, sugar cane, and beans), an increase in consumption of cellulosic biomass as feedstocks has no effects on food supply and price. Typical cellulosic biomass materials include switchgrass, wheat straw, corn stover, and sorghum stalk [11]. Switchgrass is used in the tests for this paper.

Figure 4.1 shows the major steps for manufacturing of cellulosic biofuels. Currently there are only pilot biofuel plants that use cellulosic biomass feedstocks in the U.S. [13]. The large-scale and cost-effective manufacturing of cellulosic biofuels is hindered by several technical barriers [14,15]. One such barrier is the low density of cellulosic feedstocks, which causes high transportation and storage cost [14,16,17].

**Figure 4.1 Major steps for manufacturing of cellulosic biofuels (after [12, 13])**

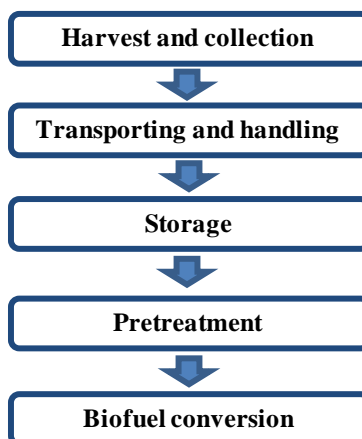

Traditional pelleting methods (like extruding, briquetting, and rolling) have been used to

increase the density of biomass feedstocks [18,19]. These pelleting methods generally require high-temperature steam, high pressure, and binder materials. This is uneconomical for use in or near the field of biomass. Without using high-temperature steam and binder materials, ultrasonic vibration-assisted (UV-A) pelleting can produce pellets with a density comparable to those processed by traditional pelleting methods [20,21].

Moisture content (MC) is an important variable of the biomass material used for UV-A pelleting. MC represents the amount of moisture (water) contained in a certain amount of biomass. A higher MC means more water in the biomass material. MC is calculated by the ratio of the weight of the water in the biomass material to the total weight of the biomass material.

Investigations on the effects of MC on pellet quality (e.g. density, spring-back, and durability) can produce a better understanding of the mechanisms of UV-A pelleting. The literature does not contain reports on this topic. This paper, for the first time, investigates the effects of MC on the density, spring-back, and durability of the pellets processed by UV-A pelleting.

## **4.2 Experimental conditions and measurement procedures**

### ***4.2.1 Experimental conditions***

#### ***4.2.1.1 Biomass material***

Switchgrass is milled into particles by a SM 2000 cutting mill (Retsch, Newtown, PA, USA). Figure 4.2 shows un-milled switchgrass and milled switchgrass particles used for the experiments. The size of the switchgrass particles is controlled by a sieve in the mill. The holes

in the sieve have a diameter of 1 mm, as shown in Figure 4.3. After measuring the initial MC of the switchgrass particles by following the ASABE standard S358.2 [22], distilled water is sprayed on the switchgrass particles to adjust the MC to the desired levels. Three MC levels (9%, 15%, and 20%) are used for the tests. For each pellet, 3 grams of switchgrass particles are loaded into the mold.

**Figure 4.2 Switchgrass before and after milling**

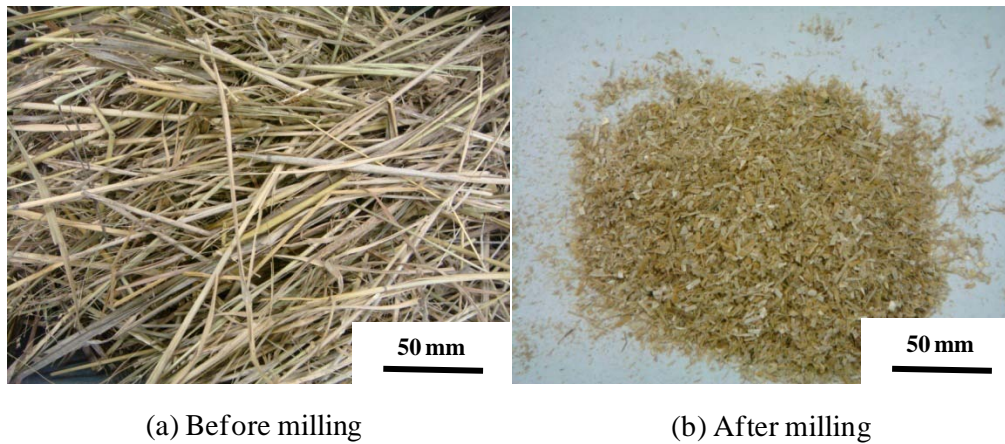

**Figure 4.3 Sieve with 1 mm holes**



#### 4.2.1.2 Major steps of UV-A pelleting experiments

Major steps of ultrasonic vibration-assisted (UV-A) pelleting experiments are shown in Figure 4.4. After the biomass material is milled into particles, the MC of the particles is measured and adjusted to the desired levels. Pelleting is performed on a Sonic-Mill rotary ultrasonic machine (Sonic-Mill, Albuquerque, NM, USA) and illustrated in Figure 4.5.

**Figure 4.4 Major steps of UV-A pelleting experiments (after [21])**

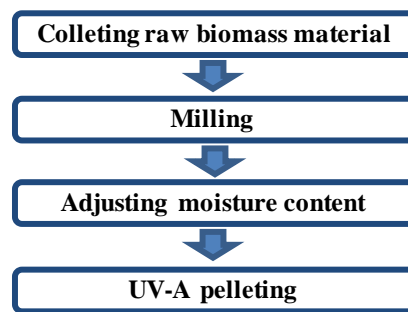

**Figure 4.5 Illustration of UV-A pelleting of biomass (after [21])**

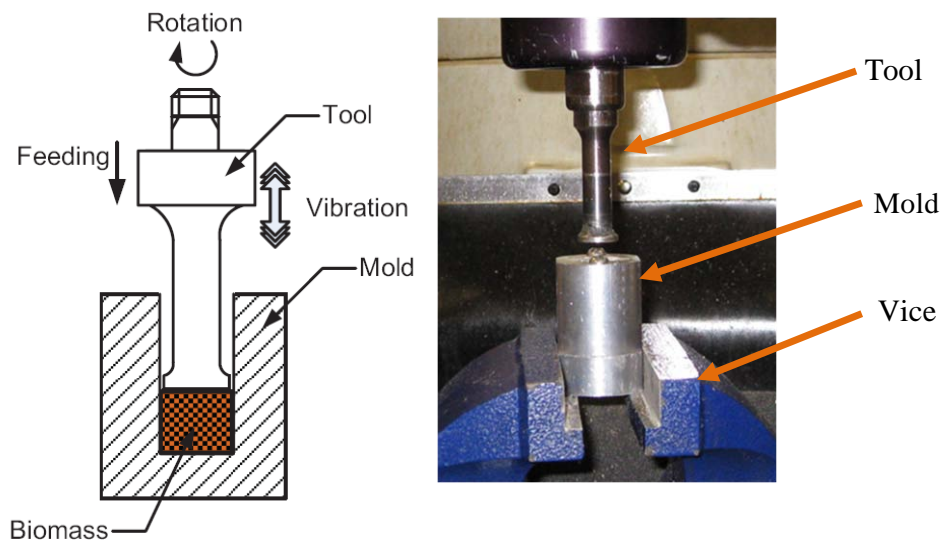

In UV-A pelleting, a tool is mounted to a rotary ultrasonic spindle which provides both rotation and ultrasonic vibration (20 kHz) to the tool. A mold with cylindrical cavity in its center is fixed by a vice. The diameter of the tool is slightly smaller than that of the cavity in the mold. The tool is fed down to compress switchgrass particles with a preset feedrate. Once the tool reaches the preset depth in the cavity of the mold, it will be retracted and the pellet will be taken out from the mold.

#### ***4.2.1.3 Major input parameters of UV-A pelleting experiments***

Table 4.1 shows the values of the important parameters in UV-A pelleting. Ultrasonic power controls the tool's vibration amplitude. A larger ultrasonic power percentage produces a higher vibration amplitude. Initial pellet volume represents the theoretical volume of the pellet when the tool reaches the preset stop position in the mold before retracting. As illustrated in Figure 4.6, the initial pellet volume is calculated by

$$\text{Initial pellet volume} = \pi \cdot H \cdot (D/2)^2$$

where, D is the diameter of the mold cavity, and H is the height of the compressed biomass when the tool reaches the preset stop position.

**Table 4.1 Values of main UV-A pelleting parameters**

<b>Parameter</b>	<b>Value</b>
Feedrate (mm/s)	0.267
Spindle rotation speed (rpm)	50
Ultrasonic power (%)	35
Initial pellet volume (mm <sup>3</sup> )	3500; 3800

**Figure 4.6 Illustration of the initial pellet volume**

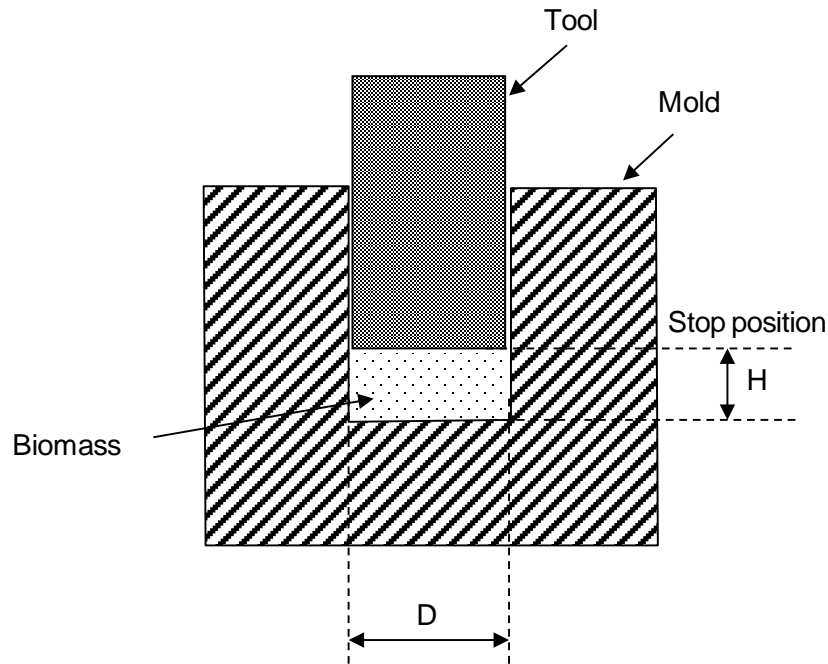

#### ***4.2.2 Measurement procedures of output variables***

##### ***4.2.2.1 Density***

Pellet density is calculated by the ratio of the weight over the volume. The weight of pellets was measured by a scale (Ohaus, Pine Brook, NJ, USA). Because of the shape of mold's cavity, all of the pellets were cylindrical in shape, as shown in Figure 4.7. The volume of pellets was obtained by measuring the height and diameter of the pellets. The density of each pellet was recorded once a day for 10 days during which all the pellets were put in sealed plastic bags to keep the constant moisture content in the pellets.

**Figure 4.7 Pellet shape after UV-A pelleting**



#### ***4.2.2.2 Spring-back***

It was observed that the volume of the pellets started expanding when the tool retracted. After pellets were made, they would keep expanding during the next few days and then became stabilized. Spring-back of pellets is used to evaluate the changes in volume with time. Spring-back was calculated by

$$\text{Spring-back} = \frac{\text{Measured volume} - \text{Initial pellet volume}}{\text{Initial pellet volume}}$$

where, measured volume is the volume of pellets measured everyday after the pellets were taken out from the mold, and initial pellet volume is the theoretical volume introduced in 3.1. For each pellet, the spring-back was recorded once a day for 10 days.

#### ***4.2.2.3 Durability***

Pellet durability is the ability of the pellet to withstand impact and other forces encountered during handling and transportation [21]. It is determined by following the ASABE standard S269.4 [23]. Five hundred grams of pellets, processed by UV-A pelleting, were kept tumbling inside a pellet durability tester (Seedburo Equipment, Des Plaines, IL, USA) for 10



minutes and then sieved through a No. 6 U.S. sieve. The pellet durability index is calculated as the ratio of the weight of the remaining pellets (that did not fall through the No. 6 sieve) after tumbling to the weight of the pellets before tumbling. In order to obtain more test data, the pellet durability index was measured after tumbling for every 2 minutes.

## **4.3 Results and discussion**

### ***4.3.1 Effects of moisture content on pellet density***

The results on pellet density are shown in Figure 4.8. The error bars in Figures 4.8 and 4.9 represent the standard deviation of the measured results. Five pellets were measured for each result. With the same amount of switchgrass (3 grams), pellets were made with two different initial volumes: 3500 mm<sup>3</sup> and 3800 mm<sup>3</sup>. As a result, two levels of initial density were obtained. For both levels, the densities of pellets underwent a sharp decrease in the first two days before they became stabilized. 9% MC produced the highest density, followed by 15% and 20% MC. For the pellets with lower initial pellet volume (higher initial density), their deviations are much larger than those from the pellets with higher initial pellet volume (lower initial density).

**Figure 4.8 Effects of MC on pellet density**

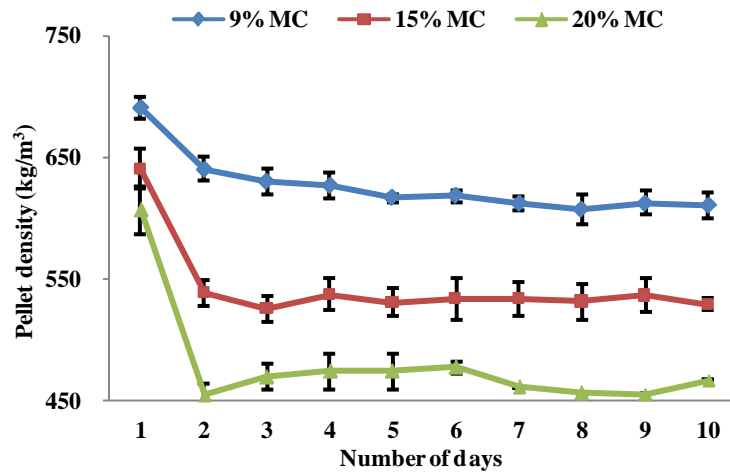

(a) Initial pellet volume = 3800 mm<sup>3</sup>

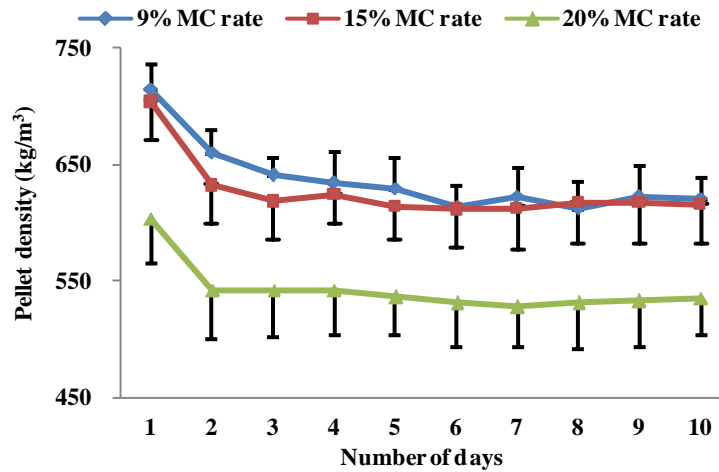

(b) Initial pellet volume = 3500 mm<sup>3</sup>

### 4.3.2 Effects of moisture content on pellet spring-back

Figure 4.9 shows the results on pellet spring-back with the standard deviations. The volumes of pellets expanded in the first two days and then became stabilized. For both initial volumes, 9% MC produced the smallest spring-back, and 20% MC produced the largest spring-

back. Larger deviations were observed for the pellets with lower initial pellet volume (higher initial density).

**Figure 4.9 Effects of MC on pellet spring-back**

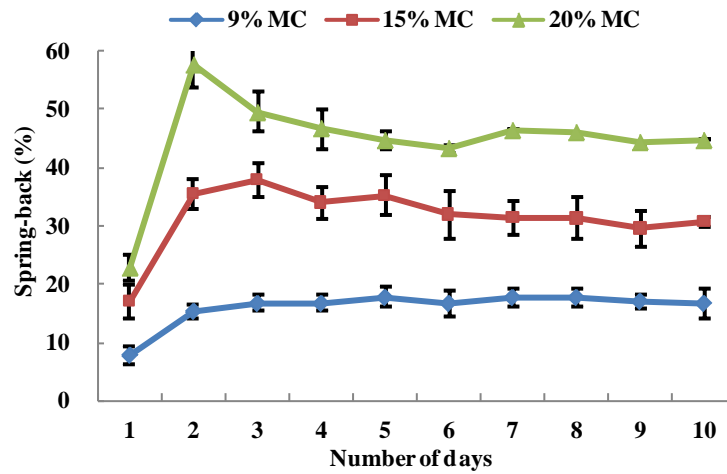

(a) Initial pellet volume = 3800 mm<sup>3</sup>

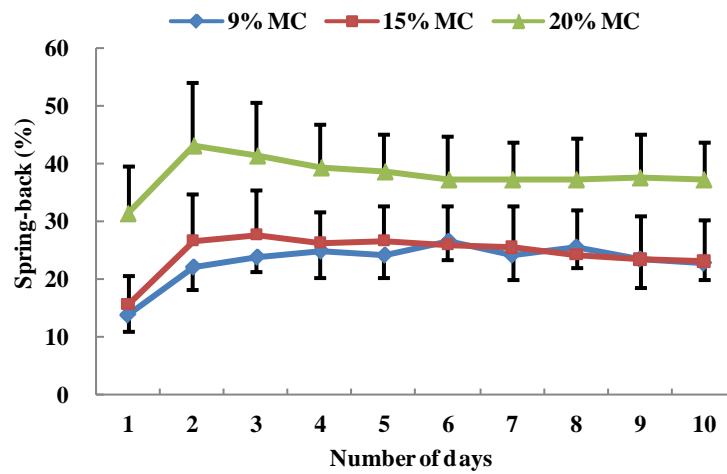

(b) Initial pellet volume = 3500 mm<sup>3</sup>

### 4.3.3 Effects of moisture content on pellet durability

The results on pellet durability are shown in Figure 4.10. The initial volume of the pellet was 3800 mm<sup>3</sup>. Pellets with 9% MC produced the highest durability. Pellets with 15% and 20% MC had similar durability.

**Figure 4.10** Effects of MC on pellet durability

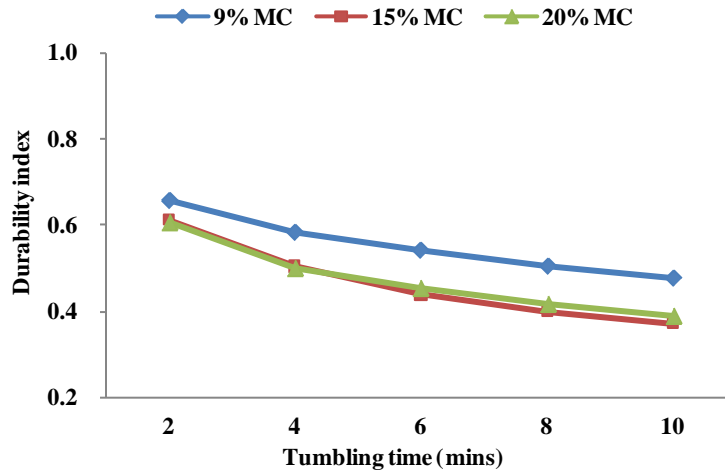

## 4.4 Conclusions

This paper reports an experimental investigation on the effects of biomass moisture content on pellet density, spring-back, and durability in ultrasonic vibration-assisted (UV-A) pelleting of switchgrass. It was found that moisture content had significant effects on these three output variables. Lower moisture content led to higher density, lower spring-back, and higher durability.

## Acknowledgements

The authors gratefully extend their acknowledgements to Mr. Clyde Treadwell at Sonic Mill for his technical support on experimental equipment.

## References

- [1] <http://www.eia.doe.gov/emeu/aer/txt/ptb0201a.html> (accessed December 20, 2009).
- [2] <http://www.eia.doe.gov/emeu/aer/txt/ptb0511.html> (accessed December 20, 2009).
- [3] [http://www.eia.doe.gov/emeu/states/sep\\_sum/html/sum\\_btu\\_tra.html](http://www.eia.doe.gov/emeu/states/sep_sum/html/sum_btu_tra.html) (accessed December 20, 2009).
- [4] [http://www.eia.doe.gov/emeu/aer/ep/fig\\_source.html](http://www.eia.doe.gov/emeu/aer/ep/fig_source.html) (accessed December 20, 2009).
- [5] <http://www.eia.doe.gov/emeu/aer/txt/ptb0501.html> (accessed December 20, 2009).
- [6] <http://sl.farmonline.com.au/news/nationalrural/agribusiness-and-general/general/us-pumps-more-money-into-cellulosic-ethanol-research/1234385.aspx> (accessed December 20, 2009).
- [7] N. Moreira: "Growing expectations", Science News, Vol. 168, No. 14, pp.218-220, 2005.
- [8] <http://www.5822.com/com/neste/download/1159763758.pdf> (accessed December 20, 2009).
- [9] [http://www.globalbioenergy.org/uploads/media/0703\\_Altieri\\_Bravo\\_The\\_ecological\\_and\\_social\\_tragedy\\_of\\_cropbased\\_biofuel\\_production\\_in\\_the\\_Americas.pdf](http://www.globalbioenergy.org/uploads/media/0703_Altieri_Bravo_The_ecological_and_social_tragedy_of_cropbased_biofuel_production_in_the_Americas.pdf) (accessed December 20, 2009).
- [10] [http://feedstockreview.ornl.gov/pdf/billion\\_ton\\_vision.pdf](http://feedstockreview.ornl.gov/pdf/billion_ton_vision.pdf) (accessed December 20,

- 2009).
- [11] I.S. Goldstein, Organics chemicals from biomass, CRC Press, Inc., 1981.
- [12] <http://www.redherring.com/Home/25682> (accessed December 20, 2009).
- [13] E. M. Rubin: “Genomics of cellulosic biofuels”, Nature, Vol. 454, No. 14, pp.841-845, 2008.
- [14] <http://www.ecs.umass.edu/biofuels/Images/Roadmap2-08.pdf> (accessed December 20, 2009).
- [15] J.R. Hess, C.T. Wright, and K.L. Kenney: “Cellulosic biomass feedstocks and logistics for ethanol production”, Biofuels, Bioproducts and Biorefining, Vol. 1, pp.181–190, 2007.
- [16] <http://naturalresourcereport.com/2009/08/ethanol-faces-challenges-ahead/> (accessed December 20, 2009).
- [17] <http://cleantechnica.com/2009/01/19/fuel-from-utility-poles-cellulosicethanol-heats-up-in-cool-economy/> (accessed December 20, 2009).
- [18] S. Mani, L.G. Tabil, and S. Sokhansanj: “An overview of compaction of biomass grinds”, Powder Handling and Processing, Vol. 15, No. 3, pp.160-168, 2003.
- [19] S. Sokhansanj, S. Mani, and P. Zaini: “Binderless pelletization of biomass”, ASABE Paper No. 056061, American Society of Agricultural and Biological Engineers, 2005.
- [20] Z.J. Pei, D.H. Wang, and R. Clark: “Ultrasonic vibration-assisted pelleting of cellulosic biomass: a preliminary experiment”, Proceedings of the 2009 International Manufacturing Science and Engineering Conference (MSEC), West Lafayette, IN, USA,

2009.

- [21] W.L. Cong, P.F. Zhang, N. Qin, M. Zhang, X.X. Song, Q. Zhang, D. Nottingham, R. Clark, T. Deines, Z.J. Pei, D.H. Wang: “Ultrasonic vibration-assisted pelleting of cellulosic biomass for biofuel manufacturing”, Poster presentation at the 2009 International Manufacturing Science and Engineering Conference (MSEC), West Lafayette, IN, USA, 2009.
- [22] ASABE Standard S358.2, Moisture Measurement—Forages, American Society of Agricultural and Biological Engineers, St. Joseph., 2002.
- [23] ASABE Standard S269.4, Cubes, pellets, and crumbles-definitions and methods for determining density, durability, and moisture content, American Society of Agricultural and Biological Engineers, St. Joseph., 2002.

## **Chapter 5 - Effects of biomass particle size on sugar yield**

This chapter presents an experimental investigation on effects of biomass particle size on sugar yield. Particles are generated by three methods (cutting milling, hammer milling, and manual cutting). Results are measured at five levels of particle size while keeping all other process variables constant. Crystallinity index (CI) of particles at each level is also measured. It is found that particles with different sizes but generated by a same method have approximately equal CI. Without changing CI, particle size has no effects on sugar yield. The content of this chapter has been published as a technical paper.

### Paper title:

An experimental investigation on cellulosic biofuel manufacturing: effects of biomass particle size on sugar yield

### Published in:

Proceedings of the ASME International Conference on Manufacturing Science and Engineering (IMECE), November 11-17, 2011, Denver, CO, USA

### Author's names:

Pengfei Zhang<sup>1</sup>, Qi Zhang<sup>1</sup>, Z.J. Pei<sup>1</sup>, Linda Pei<sup>2</sup>

### Author's Affiliation:



1. Department of Industrial and Manufacturing Systems Engineering, Kansas State University, 2037 Durland Hall, Manhattan, KS 66506

2. Manhattan High School, Manhattan, KS 66506

## **Abstract**

Biofuels made from cellulosic biomass are an alternative to petroleum-based liquid transportation fuels. A key barrier to cost-effective manufacturing of cellulosic biofuel is low sugar yield in enzymatic hydrolysis. Particle size and crystallinity index of cellulosic biomass are two important parameters in enzymatic hydrolysis. The current literature contains many experimental investigations about effects of biomass particle size on sugar yield. However, particle size, often reduced by ball milling, is correlated with crystallinity index. Changes in particle size usually cause changes in crystallinity index. Therefore, particle size and crystallinity index may have confounding effects on sugar yield. Relations between particle size and sugar yield are not clear. This paper reports an experimental investigation on sugar yields from switchgrass particles produced by three methods: cutting milling, hammer milling, and manual cutting. The particles have different sizes but the same crystallinity index. Results show that there are no significant differences among sugar yields from these particles of different sizes. Particle size within the tested range has no significant effects on sugar yield.

## **5.1 Introduction**

During the last three decades, consumption of conventional liquid transportation fuels (including gasoline, diesel, and jet fuels) in the U.S. has increased by 50% [1]. Conventional liquid transportation fuels are distilled from petroleum and account for 70% of total petroleum

consumption [1,2]. In 2010, the U.S. transportation sector consumed about 19.1 million barrels of petroleum every day, and 49.4% of them were imported [3]. Also, use of conventional liquid transportation fuels contributes to accumulation of greenhouse gas (GHG) in the atmosphere. This, combined with finite reserves, non-uniform distribution, and volatile prices of petroleum make it extremely important to develop domestic sustainable sources for liquid transportation fuels in the U.S..

Biofuels produced from cellulosic biomass, the fibrous, woody, and generally inedible portions of plant matter, can reduce the U.S.'s dependence on foreign petroleum, and cut GHG emissions while continuing to meet the nation's needs for liquid transportation fuels [4-6]. The U.S. government has recently called for an annual production of 36 billion gallons of biofuels by 2022 [7]. In 2009, about 10.8 billion gallons of bioethanol (one type of biofuel) was produced in the U.S. [8]. At present, more than 90% of bioethanol is produced from corn [9]. A dramatic increase in bioethanol production from corn may be limited because corn production for bioethanol will compete with food and feed production for limited agricultural land. Cellulosic biofuels do not possess such limitations.

Figure 5.1 shows major steps in manufacturing of cellulosic ethanol. The purpose of hydrolysis is to break down cellulose into its component sugars that are convertible to ethanol by fermentation. A key barrier to cost-effective manufacturing of cellulosic ethanol is low sugar yield in enzymatic hydrolysis, making hydrolysis one of the most costly processes [5,11-13].

**Figure 5.1 Major steps in manufacturing of cellulosic biofuels (after [10,11])**

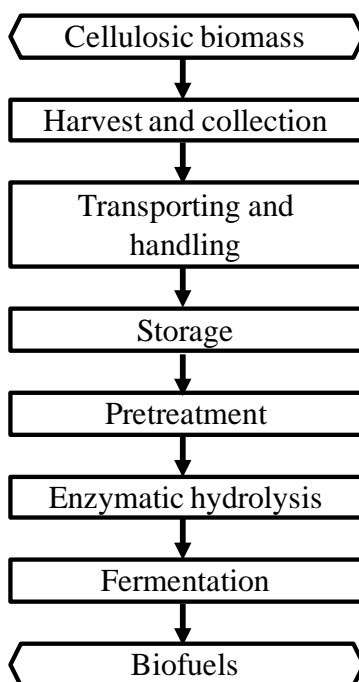

Particle size and crystallinity index (CI) of cellulosic biomass are two important parameters in enzymatic hydrolysis. The current literature contains many experimental investigations about effects of biomass particle size on sugar yield. However, particle size is correlated with crystallinity index. Changes in particle size usually cause changes in CI. In the reported investigations, ball milling is most widely used to reduce particle size of cellulosic biomass [14-18]. It has been found that both CI and particle size will decrease when the cycle time of ball milling is sufficiently long [15,17,19,20]. Therefore, particle size and CI may have confounding effects on sugar yield. Relations between particle size and sugar yield are not clear.

This paper reports an experimental investigation on sugar yields from switchgrass particles produced by three methods: cutting milling, hammer milling, and manual cutting. The particles have different sizes but the same crystallinity index. Sugar yields of the particles are

measured and compared. Effects of particle size on sugar yield are evaluated.

## 5.2 Experimental conditions

The experimental procedure is shown in Figure 5.2. Bulky switchgrass was harvested from Riley County, Kansas, and stored indoors before use. Switchgrass particles were produced by three methods: cutting milling, hammer milling, and manual cutting. Particles produced from the three methods were referred to as  $P_c$ ,  $P_h$ , and  $P_m$  respectively. The particles obtained from each method were separated into different sizes using a series of sieves. The CIs of the separated particles (from different methods and with different sizes) were measured. The particles were then pretreated and enzymatically hydrolyzed. Sugar yields of the particles were measured.

**Figure 5.2 Experimental procedure**

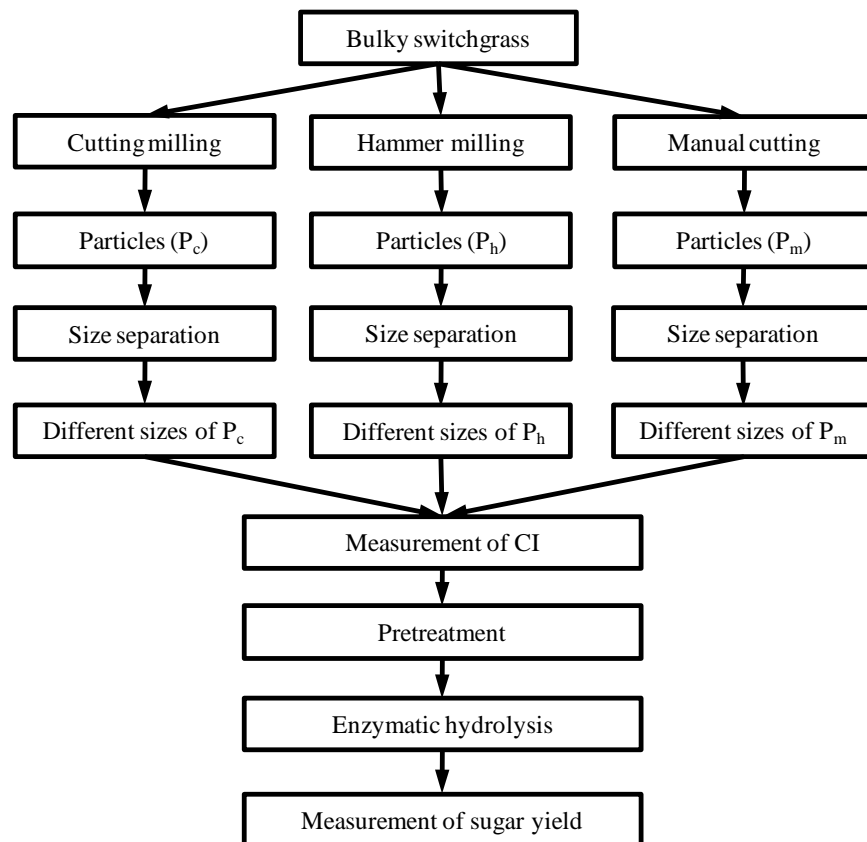

### ***5.2.1 Cutting milling***

In cutting milling, a set of rotating blades inside a chamber cut down the size of bulky switchgrass. Milled switchgrass is trapped inside the chamber until it is the right size to pass through the sieve that is located under the blades, as shown in Figure 5.3. In this investigation, a cutting mill (model SM 2000, Retsch, Inc., Haan, Germany) was used to produce particles  $P_c$ . A sieve with a 2 mm screen size was put in the cutting mill to control particle size.

**Figure 5.3 Cutting milling**

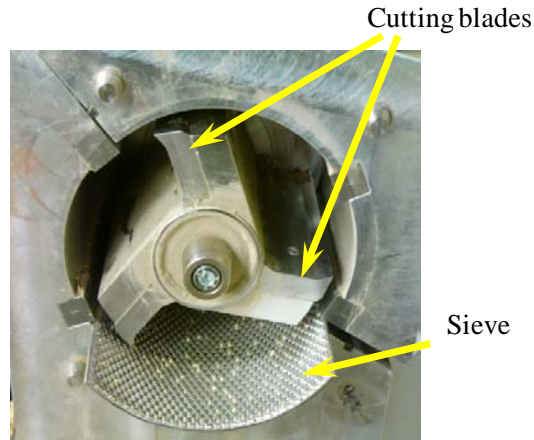

### ***5.2.2 Hammer milling***

A hammer mill has a steel drum containing a horizontal rotating shaft on which hammers are mounted, as shown in Figure 5.4. The hammers are free to swing on the ends of the panels which are mounted on the shaft. The size of biomass particles is reduced through an impact-induced material fragmentation [21]. Particles leaving contact with the hammers reach the sieve and fall through if they are small enough [22]. In this investigation, a hammer mill (model 35, Meadows Mills, Inc., North Wilkesboro, NC, USA) was used to produce particles  $P_h$ . A sieve with a 2 mm screen size was put in the hammer mill to control particle size.

**Figure 5.4 Hammer milling**

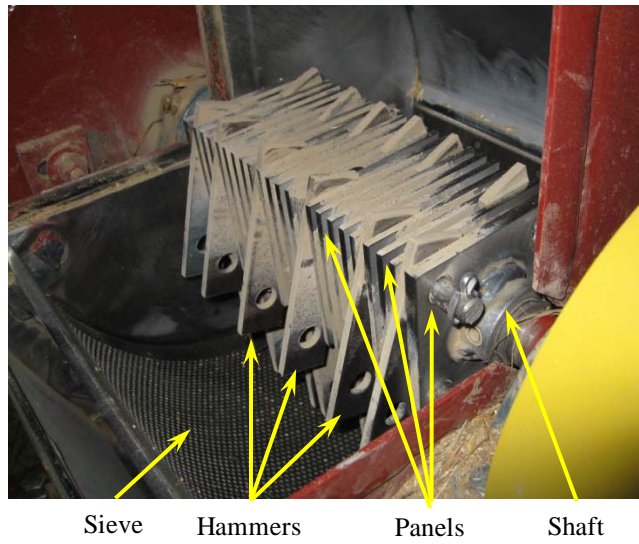

### ***5.2.3 Manual cutting***

Particles  $P_m$  were produced by manual cutting with scissors, as shown in Figure 5.5. The size of manually-cut particles was controlled to be less than 2 mm during manual cutting.

**Figure 5.5 Manual cutting with scissors**



### 5.2.4 Particle size separation

A sieve shaker (model RX-29, W.S. Tyler, Inc., Mentor, OH, U.S.) was used to separate  $P_c$ ,  $P_h$ , and  $P_m$  into different sizes. A series of sieves (with different screen sizes) was loaded on an agitation tray, as shown in Figure 5.6. Particles were put on the top sieve that had the largest screen size. A hammer located above the sieves stroke the sieves three times per second to help particles fall through. Meanwhile, the agitation tray was driven by a motor to move circularly around a center point at about 200 rpm. The process lasted for ten minutes.

**Figure 5.6 Sieve shaker**

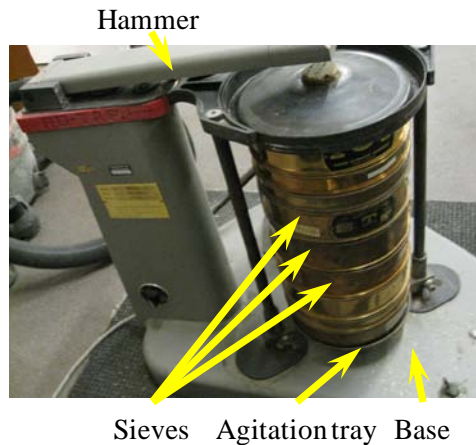

In this investigation, six sieves were used. Their screen sizes are listed in Table 5.1. Theoretically, particles could be separated into seven different sizes. However, almost all particles fell through the 2.4 mm sieve, so the particle size of  $> 2.4$  mm was excluded. In addition, those particles that fell through the 0.2 mm sieve were also excluded due to concern about a high percentage of impurities (e.g. dust) in the particles. Therefore,  $P_c$ ,  $P_h$ , and  $P_m$  were separated into five different sizes: 0.2 – 0.3, 0.3 – 0.4, 0.4 – 0.6, 0.6 – 1.2, and 1.2 – 2.4 mm.

**Table 5.1 Screen sizes of sieves**

Sieve #	Screen size (mm)
1	2.4
2	1.2
3	0.6
4	0.4
5	0.3
6	0.2

### ***5.2.5 Measurement of CI***

The CI of switchgrass particles was measured by X - ray diffraction (XRD) with a Bruker AXS D - 8 diffractometer (AXS GmbH, Karlsruhe, Germany) operating at 40 kW and 40 mA. The radiation was copper K $\alpha$  ( $\lambda = 1.54$  A), and grade range was between 12° and 28° with a step size of 0.05°. The presence of crystallinity in a sample can be detected by absorption peaks. In this paper, the CI was calculated using the method described by Segal et al. [23] as follows:

$$CI = \frac{I_{002} - I_{\text{amorphous}}}{I_{002}} \times 100\% \quad (1)$$

where  $I_{002}$  is the intensity of the crystalline portion of switchgrass samples at about  $2\theta = 22.5^\circ$ , and  $I_{\text{amorphous}}$  is the peak for the amorphous portion at about  $2\theta = 16^\circ$ .

### ***5.2.6 Pretreatment***

Pretreatment was carried out in a pressure reactor (Parr Instrument Company, Moline, IL, USA) with a 600 mL reaction vessel. Switchgrass particles were mixed with diluted sulfuric acid (2% w/v) in the vessel to obtain 1% solid content (approximately 1 gram in 100 mL diluted



sulfuric acid solution). The slurry was stirred by two impeller mixers and treated at a temperature of 140 °C for 30 minutes. Pretreated particles were washed with hot distilled water to remove dissolved sugars and sulfuric acid.

### ***5.2.7 Enzymatic hydrolysis***

Pretreated switchgrass particles were enzymatically hydrolyzed in solution with sodium acetate buffer (100 mM, pH 4.8) and 0.02% (w/v) sodium azide to prevent microbial growth during hydrolysis. The dry mass content of the hydrolysis slurries was 2% (w/v). Enzymatic hydrolysis was carried out in 125 mL flasks with 80 mL of slurry in a 50 °C water bath shaker (Model C76, New Brunswick Scientific, Edison, NJ, USA) agitating at 110 rpm for 24 h. The loading of enzyme (Accellerase 1500, Danisco US, Inc., Genencor Division, Rochester, NY) was 1 mL per gram of cellulose.

After enzymatic hydrolysis, the hydrolysis slurries were sampled by withdrawing 0.1 mL of slurry from each flask. Sample slurries were then mixed with 0.9 mL double-distilled water in 1.5 mL vials. The vials were placed to boiling water for 15 min to deactivate the enzyme. After the enzyme was deactivated, samples were centrifuged at 10,000 rpm for 15 minutes. The supernatants were then further diluted and filtered into 1.5 mL autosampler vials through 0.2 µm syringe filters (Millipore, Billerica, MA, USA). Filtered samples were kept at 4 °C before sugar yield measurement.

### ***5.2.8 Measurement of sugar yield***

Sugar concentrations in the prepared samples were determined by an HPLC (high-performance liquid chromatography) (Shimadzu, Kyoto, Japan) equipped with an RCM-monosaccharide column (300 × 7.8 mm; Phenomenex, Torrance, CA, USA) and a refractive

index detector (RID-10A, Shimadzu, Kyoto, Japan). A higher sugar concentration indicates a higher sugar yield.

## 5.3 Experimental results

### 5.3.1 Results on CI

Measurement results on CI (obtained according to equation 1) of different particles are shown in Table 5.2 and Figure 5.7. CI does not show any clear trends as particle size decreases. Standard deviation is shown as error bars in Figure 5.7. It indicates that particles that are produced by the same method have approximately the same CI even if they have different sizes.

**Table 5.2 Measurement results on CI**

Particle size (mm)	CI (%)		
	P <sub>c</sub>	P <sub>h</sub>	P <sub>m</sub>
1.2-2.4	59	48	54
0.6-1.2	57	50	60
0.4-0.6	54	47	57
0.3-0.4	57	51	54
0.2-0.3	58	51	54

**Figure 5.7 Measurement results on CI**

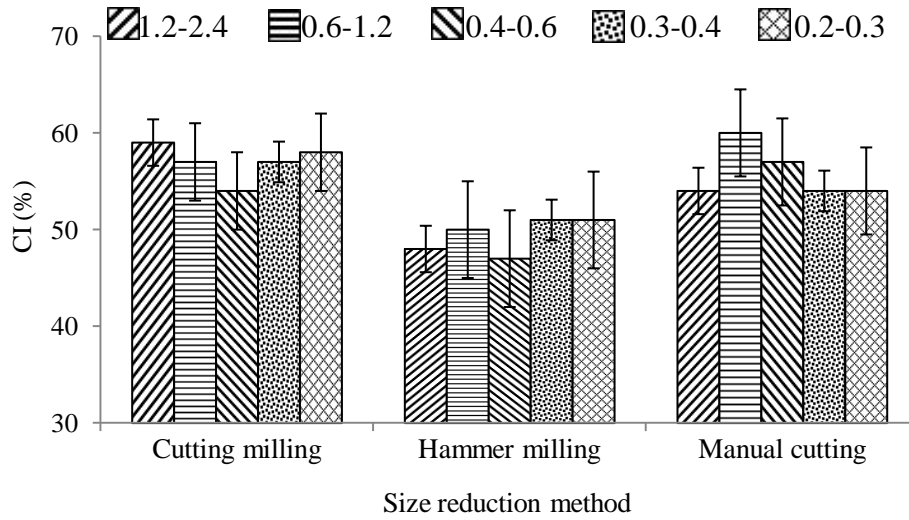

### 5.3.2 Results on sugar yield

Measurement results on sugar yield of different particles are shown in Table 5.3 and Figure 5.8. As particle size decreases, sugar yield remains the same for all three size reduction methods. It indicates that particle size (in the range of 0.2 - 2.4 mm) of switchgrass has no significant effects on sugar yield.

**Table 5.3 Measurement results on sugar yield**

Particle size (mm)	Sugar yield (g/L)		
	P <sub>c</sub>	P <sub>h</sub>	P <sub>m</sub>
1.2-2.4	10.48	10.28	10.26
0.6-1.2	10.62	10.26	10.26
0.4-0.6	10.62	10.42	10.32
0.3-0.4	10.62	10.44	10.28
0.2-0.3	10.36	10.28	10.26

**Figure 5.8 Measurement results on sugar yield**

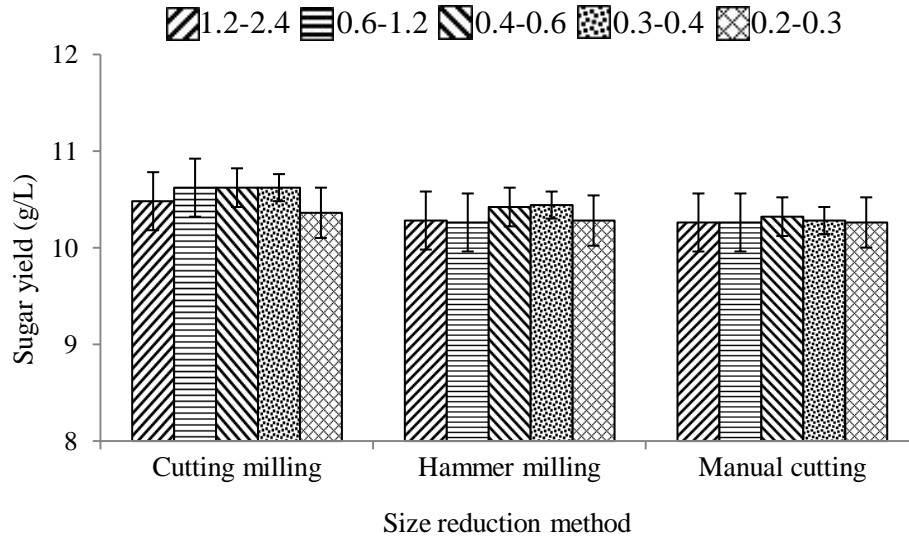

## 5.4 Conclusions

This paper reports an experimental investigation on sugar yields from switchgrass particles produced by three methods: cutting milling, hammer milling, and manual cutting. Sugar yields of the particles are measured and compared. The following conclusions can be drawn:

- (1) Cutting milling, hammer milling, and manual cutting produce biomass particles with different sizes but the same CI (obtained according to equation 1).
- (2) Without changing CI, particle size (in the range of 0.2 - 2.4 mm) has no effects on sugar yield.

## Acknowledgements

This study is supported by NSF award CMMI-0970112. The authors gratefully extend their acknowledgements to Graham Pritchett and Eric Zinke (undergraduate students) at Kansas State University for their help in preparing manually-cut particles.

## References

- [1] Energy Information Administration, "U.S. energy consumption by sector of 1949-2009," 2009, retrieved from: <http://www.eia.doe.gov/emeu/aer/pdf/pages/sec2.pdf>.
- [2] Energy Information Administration, "Petroleum products supplied by type of 1949-2009," 2009, retrieved from: <http://www.eia.doe.gov/emeu/aer/txt/ptb0511.html>.
- [3] Energy Information Administration, "Short-term energy outlook," 2011, retrieved from: [http://www.eia.doe.gov/emeu/steo/pub/steo\\_full.pdf](http://www.eia.doe.gov/emeu/steo/pub/steo_full.pdf).
- [4] Fairfax Media, "U.S. pumps more money into cellulosic ethanol research," 2008, retrieved from: <http://sl.farmonline.com.au/news/nationalrural/agribusiness-and-general/us-pumps-more-money-into-cellulosic-ethanol-research/1234385.aspx>.
- [5] DOE, "Breaking the biological barriers to cellulosic ethanol: a joint research agenda," 2009, retrieved from: <http://genomicsgtl.energy.gov/biofuels/b2bworkshop.shtml>.
- [6] G.W. Bush, "2007 State of the Union Address," 2007, retrieved from: <http://www.washingtonpost.com/wpdyn/content/article/2007/01/23/AR2007012301075.html>.
- [7] Energy Information Administration, "Annual Energy Review 2009," 2010, retrieved from: <http://www.eia.doe.gov/aer/pdf/aer.pdf>.
- [8] Energy Information Administration, "Annual Energy Outlook 2011," 2010, retrieved from: [http://www.eia.gov/neic/speeches/newell\\_12162010.pdf](http://www.eia.gov/neic/speeches/newell_12162010.pdf).
- [9] J. Decker, "Going against the grain: ethanol from lignocellulosics," 2009, retrieved from: <http://www.renewableenergyworld.com/rea/news/article/2009/01/goingagainst-the-grain-ethanol-from-lignocellulosics-54346>.
- [10] J. Moresco, "U.S. biofuel output to miss mandates," 2008, retrieved from:

- <http://www.redherring.com/Home/25682>.
- [11] E. M. Rubin, "Genomics of cellulosic biofuels," *Nature*, Vol. 454, No. 7206, pp. 841-845, 2008.
- [12] P. Kent, Biofuels pilot plant set for Clemson University Restoration Institute in North Charleston, November 15, 2007, [http://www.clemson.edu/newsroom/articles/top-stories/Biofuel\\_Plant\\_CURI.php5](http://www.clemson.edu/newsroom/articles/top-stories/Biofuel_Plant_CURI.php5).
- [13] A. Aden, M. Ruth, K. Ibsen, J. Jechura, K. Neeves, J. Sheehan, Lignocellulosic biomass to ethanol process design and economics utilizing co-current dilute acid prehydrolysis and enzymatic hydrolysis for corn stover, NREL/TP-510-32438, National Renewable Energy Laboratory, Golden, CO, (2002), <http://www.nrel.gov/docs/fy02osti/32438.pdf>.
- [14] K. Fukazawa, J.F. Revol, L. Jurasek, and D.A.I. Goring, D.A.I., "Relationship between ball milling and the susceptibility of wood to digestion by cellulose," *Wood science and technology*, Vol. 16, No. 4, pp. 279-285, 1982.
- [15] D.B. Rivers, and G.H. Emert, G.H., "Lignocellulose pretreatment: a comparison of wet and dry ball attrition," *Biotechnology Letters*, Vol. 9, No. 5, pp. 365-368, 1987.
- [16] A.P. Sinitsyn, A.V. Gusakov, and E.Y. Vlasenko, "Effect of structural and physicochemical features of cellulosic substrates on the efficiency of enzymatic hydrolysis," *Journal of Applied Biochemistry and Biotechnology*, Vol. 30, No. 1, pp. 43-59, 1991.
- [17] W.E. Karr, and M.T. Holtzaple, "Using lime pretreatment to facilitate the enzymic hydrolysis of corn stover," *Biomass and Bioenergy*, Vol. 18, No. 3, pp. 189-199, 2000.
- [18] I.V. Mikushina, I.B. Troitakaya, A.V. Dushkin, Y.A. Olkhov, and N.G. Bazarnova, "Transformations of wood structure under mechanochemical treatment," *Chemistry for Sustainable Development*, Vol. 11, No. 2, pp. 363-370, 2003.

- [19] M.M. Gharpuray, Y.H. Lee, and L.T. Fan, L.T., "Structural modification of lignocellulosics by pretreatments to enhance enzymatic hydrolysis," *Biotechnology and Bioengineering*, Vol. 25, No. 1, pp. 157-172, 1983.
- [20] J.A. Howsmon, and R.H. Marchessault, "The ball-milling of cellulose fibers and recrystallization effects," *Journal of Applied Polymer Science*, Vol. 1, No. 3, pp. 313-322, 1959.
- [21] L. Austin, "A treatment of impact breakage of particles," *Powder Technology*, Vol. 126, No. 1, pp. 85-90, 2002.
- [22] L. Austin, "A preliminary simulation model for fine grinding in high speed hammer mills," *Powder Technology*, Vol. 143, pp. 240-252, 2004.
- [23] L. Segal, J.J. Creely, A.E.J. Martin, and C.M. Conrad, "An empirical method for estimating the degree of crystallinity of native cellulose using the x-ray diffractometer," *Textile Research Journal*, Vol. 29, No. 10, pp. 786-794, 1959.

## **Chapter 6 - Effects of process variables on pellet quality and sugar yield**

This chapter focuses on experimental investigations on the effects of process variables (such as biomass moisture content, biomass particle size, pelleting pressure, and ultrasonic vibration power) on pellet quality (such as pellet density, durability, and stability) and sugar yield. A two level four factor ( $2^4$ ) DOE is employed to investigate main effects and interaction effects of these process variables on pellet quality and sugar yield. The content of this chapter has been published as a technical paper.

### Paper title:

Ultrasonic vibration-assisted pelleting of biomass: a designed experimental investigation on pellet quality and sugar yield

### Published in:

Proceedings of the ASME International Conference on Manufacturing Science and Engineering (MSEC), October 12-15, 2010, Erie, PA, USA.

### Author's names:

Pengfei Zhang<sup>1</sup>, Timothy Deines<sup>1</sup>, Z.J. Pei<sup>1</sup>, Daniel Nottingham<sup>1</sup>, Donghai Wang<sup>2</sup>,  
Xiaorong Wu<sup>2</sup>

### Author's Affiliation:



1. Department of Industrial and Manufacturing Systems Engineering, Kansas State University, 2037 Durland Hall, Manhattan, KS 66506

2. Department of Biological and Agricultural Engineering, Kansas State University, 150 Seaton Hall, Manhattan, KS 66506

## **Abstract**

Increasing demands and concerns for the reliable supply of liquid transportation fuels make it important to find alternative sources to petroleum based fuels. One such alternative is cellulosic biofuels. However, several technical barriers have hindered large-scale, cost-effective manufacturing of cellulosic biofuels, such as the low density of cellulosic feedstocks (causing high transportation and storage costs) and the low efficiency of enzymatic hydrolysis process (causing longer processing time and low sugar yield). Ultrasonic vibration-assisted (UV-A) pelleting can increase the density of cellulosic materials by compressing them into pellets. UV-A pelleting can also increase the sugar yield of cellulosic biomass materials in hydrolysis. At present, the effects of process variables in UV-A pelleting on pellet quality (density, durability, and stability) and sugar yield have not been adequately investigated. This paper reports an experimental investigation on UV-A pelleting of wheat straw. A  $2^4$  factorial design is employed to evaluate the effects of process variables (moisture content, particle size, pelleting pressure, and ultrasonic power) on output variables (pellet density, durability, stability, and sugar yield).

### **Keywords**

Biofuel, biomass, cellulosic, energy manufacturing, pellet, ultrasonic vibration

## 6.1 Introduction

In the last three decades, the consumption of liquid transportation fuels (e.g., gasoline, diesel, and jet fuels) in the U.S. has increased by 50% [1]. Conventional liquid transportation fuels are distilled from petroleum and account for 70% of total petroleum consumption [1-3]. In 2008, the U.S. transportation sector consumed about 14 million barrels of petroleum every day, and 60% of them were imported [4]. Also, the use of conventional liquid transportation fuels contributes to the accumulation of greenhouse gas (GHG) in the atmosphere. Finite reserves, non-uniform distribution, volatile prices, and contribution to GHG emissions of petroleum make it extremely important to promote development of domestic sustainable energy sources to replace conventional liquid transportation fuels.

Cellulosic biofuels produced from cellulosic biomass (the fibrous, woody, and generally inedible portions of plant matter) offer an alternative to reduce the nation's dependence on foreign petroleum, and cut GHG emissions while continuing to meet the nation's transportation energy needs [5,6].

Figure 6.1 shows major steps for manufacturing of cellulosic biofuels. Currently there are only pilot biofuel plants that use cellulosic feedstocks in the U.S. [7]. Several technical barriers have hindered large-scale, cost-effective manufacturing of cellulosic biofuels [9,10]. One such barrier is the low density of cellulosic feedstocks, causing higher transportation and storage costs [9,11,12]. Another barrier is the lack of efficient hydrolysis procedures, causing expensive and slow hydrolysis processes [5,13-15].

Traditional pelleting methods (e.g., using a screw extruder, a briquetting press, or a rolling machine [16,17]) can be used to increase the density of cellulosic feedstocks. But they generally involve high-temperature steam and high pressure, and often use binder materials.

Therefore, it is difficult to realize cost-effective pelleting on or near the field where cellulosic biomass is available with traditional pelleting methods. Ultrasonic vibration-assisted (UV-A) pelleting, without using high-temperature steam and binder materials, can produce biomass pellets whose density is comparable to that processed by traditional pelleting methods [18,19]. Also, UV-A pelleting can increase the sugar yield of cellulosic biomass materials [20].

**Figure 6.1 Major steps for manufacturing of cellulosic biofuels (after [7, 8])**

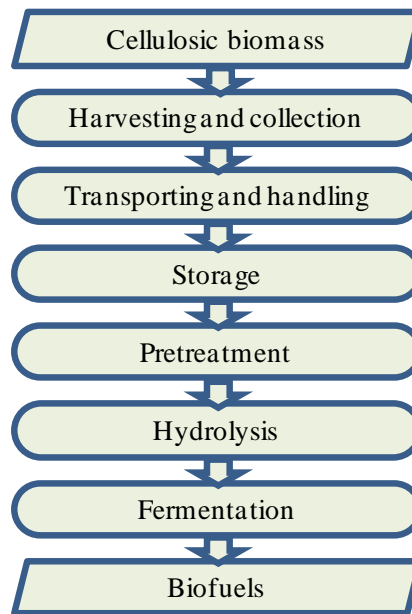

So far, there are few publications on effects of pelleting on pretreatment and biofuel conversion, and none on effects of UV-A pelleting of biomass on pretreatment and biofuel conversion. UV-A pelleting of cellulosic biomass is systematically investigated for the first time. This paper reports an experimental investigation on UV-A pelleting of wheat straw. The main and interaction effects of process variables (moisture content, particle size, pelleting pressure, and ultrasonic power) on output variables (pellet density, durability, stability, and sugar yield) are studied via employing the  $2^4$  factorial design.

## 6.2 Experimental conditions

### 6.2.1 Major processes in UV-A pelleting experiments

Major processes in UV-A pelleting experiments are shown in Figure 6.2. Wheat straw was milled into particles using a knife mill (model SM 2000, Retsch, Inc., Haan, Germany). Sieves with different screen sizes were used to control the particle size. After milling, the moisture content of the biomass powder was measured and adjusted to the desired levels according to the ASABE standard S358.2 [21]. A Sonic-Mill ultrasonic machine (Sonic-Mill, Albuquerque, NM, USA) was used to perform pelleting.

**Figure 6.2 Major processes of UV-A pelleting experiments**

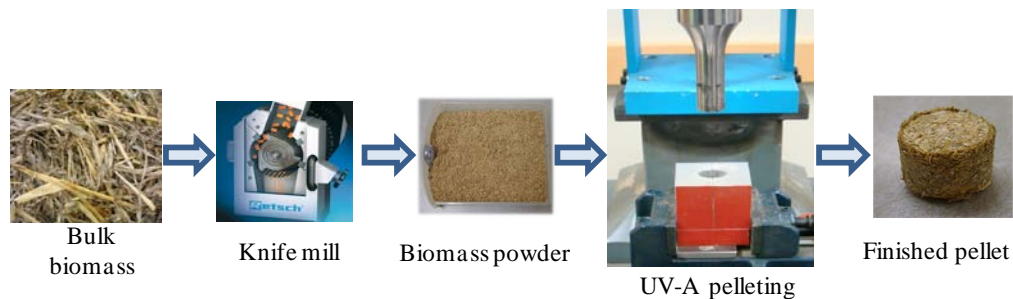

The experimental setup of UV-A pelleting is schematically illustrated in Figure 6.3. The tool was mounted to a tool holder that was connected to an ultrasonic converter that provided ultrasonic vibration to the tool. The mold was made in three separate parts which were assembled together with pins. The top two parts formed a hollow cylinder and the bottom part served as a base. Biomass was loaded into the center cavity of the mold, and the tool was fed into this cavity. The tip of the tool was a solid cylinder that had a diameter of 17.4 mm, slightly smaller than that

of the central hole (18.6 mm) in the mold. After a predetermined period of time, the tool was retracted and the mold disassembled to unload the pellet. After UV-A pelleting, a cylinder shaped pellet was obtained.

**Figure 6.3 Illustration of experimental setup**

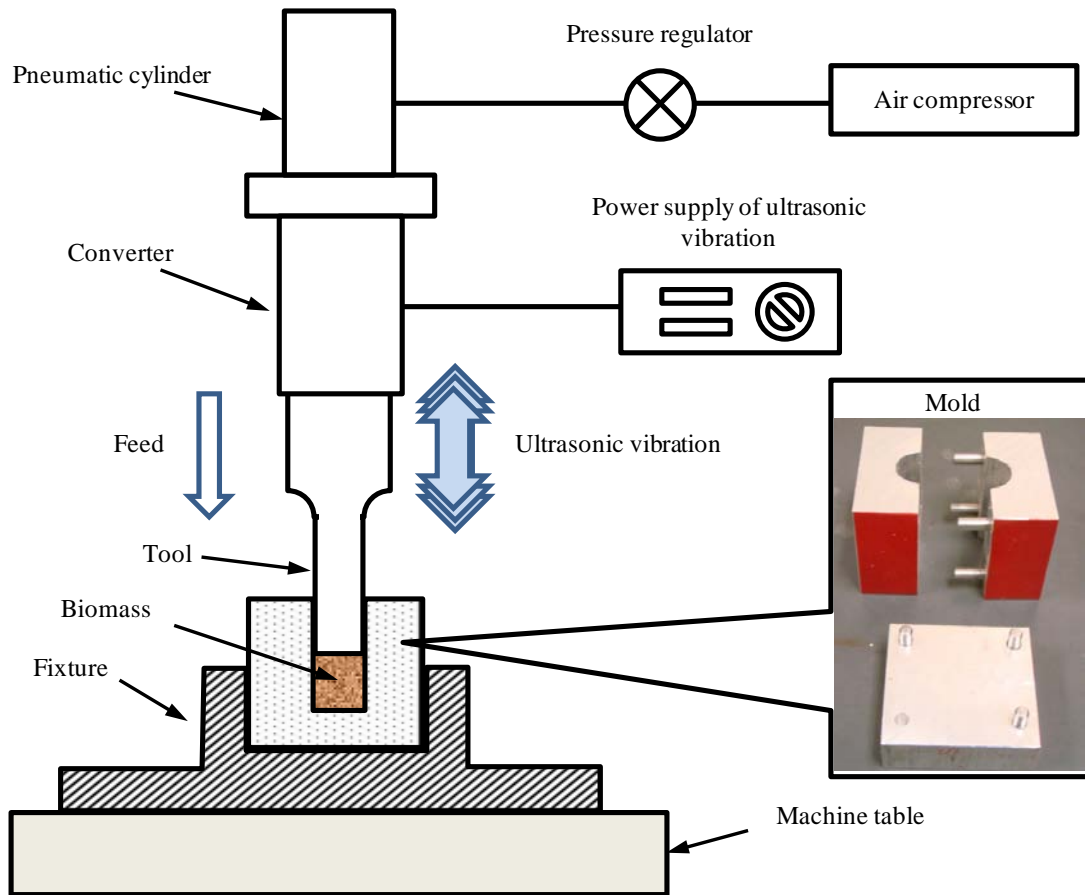

### ***6.2.2 Important process variables***

UV-A pelleting is an innovative pelleting process and only little research has been done on it. Previous tests show that moisture content and particle size can affect the pellet quality in terms of density, durability, and stability [20]. Pelleting pressure and ultrasonic power are two

important process variables in UV-A pelleting.

Moisture content in this paper refers to the moisture content of the wheat straw particles right before UV-A pelleting. It represents the amount of moisture (water) contained in them. A higher moisture content means more water in the wheat straw particles. Moisture content was calculated by the ratio of the weight of the water in the wheat straw particles to the total weight of the wheat straw particles. When the moisture content was adjusted to the desired level, the wheat straw particles were stored in zip-lock bags to maintain that moisture content. The screen size used to mill the wheat straw particles is referred to as particle size in this paper.

The pelleting pressure in this paper is the air pressure in the pneumatic cylinder. It was controlled by a pressure regulator (shown in Figure 6.3) connected to an air compressor. A higher pelleting pressure represents a higher compression pressure applied on the wheat straw particles by the tool in the pelleting process.

Ultrasonic power refers to the power provided to the ultrasonic converter by a power supply. It controls the amplitude of the tool vibration. A larger ultrasonic power creates a larger vibration amplitude. The selected ultrasonic power is expressed as a percentage of the maximum ultrasonic power for the machine. The frequency of the tool vibration was 20 kHz.

### ***6.2.3 Design of experiments***

A  $2^4$  (four variables, two-levels) full factorial design was used for the experiments with three replications under each condition for the tests of density and stability. No replication was obtained under each condition for the tests of durability and sugar yield because both tests are quite time consuming. The variable levels are listed in Table 6.1 and the matrix of the experiments is shown in Table 6.2. These tests were conducted in a random order. The variable levels were determined according to the previous test [20].

Minitab (Version 15) was used to process the data. To identify the significant effects, the analysis of variance (ANOVA) was performed for each output variable.

**Table 6.1 Variables and their levels**

Variable	Unit	Low level (-)	High level (+)
Moisture content	%	10	20
Particle size	mm	1	2
Pelleting pressure	psi	30	40
Ultrasonic power	%	30	40

**Table 6.2 Matrix of the experiments**

Test number	Moisture content	Particle size	Pelleting pressure	Ultrasonic power
Test 1, 13, 40	1	-1	-1	1
Test 2, 26, 36	1	1	-1	1
Test 3, 5, 48	-1	-1	1	-1
Test 4, 6, 44	1	1	1	-1
Test 7, 9, 38	1	-1	-1	-1
Test 8, 12, 20	-1	-1	1	1
Test 10, 30, 47	1	-1	1	1
Test 11, 29, 42	-1	1	1	-1
Test 14, 33, 37	-1	-1	-1	1
Test 15, 32, 39	1	1	1	1
Test 16, 31, 35	-1	1	-1	1
Test 17, 21, 24	-1	1	1	1
Test 18, 27, 41	-1	1	-1	-1
Test 19, 22, 43	1	-1	1	-1
Test 23, 28, 45	-1	-1	-1	-1
Test 25, 34, 46	1	1	-1	-1

#### ***6.2.4 Measurements of the output variables***

Previous experiments showed that the weight and volume of the pellets would not change much after the third day after pelleting [20]. After measuring their initial weights and volumes right after pelleting, the pellets were stored in zip-lock bags. They were taken out from the bags to measure the weight and volume once a day for 5 days. For each pellet, its reported “stable” weight and volume were determined as the average value of the measurements at day 3, 4, and 5.

Density of a pellet was calculated by the ratio of its weight over its volume. The weight of pellets was measured by an electronic scale (model TAJ602, Ohaus, Pine Brook, NJ, USA). The volume of pellets (with cylindrical shape) was obtained by measuring the height and diameter of the pellets with a caliper.

Durability is the ability of the pellet to withstand impact and other forces encountered during handling and transportation [22]. Pellet durability was measured based on the ASABE standard S269.4 [22] with some modifications. Twenty grams of pellets were kept tumbling inside a pellet durability tester (Seedburo Equipment, Des Plaines, IL, USA) for 10 minutes and then sieved through a U.S. No. 6 sieve. The pellet durability index was calculated as the ratio of the weight of the remaining pellets (that did not fall through the No. 6 sieve) after tumbling to the weight of the pellets before tumbling.

Stability of a pellet was determined by evaluating changes in its dimensions (or volume) with time. A general trend was observed: the volume of the pellets would increase (spring-back) with time after they were taken out from the mold. The spring-back of a pellet was expressed as:

$$\text{Spring – back (\%)} = \frac{\text{volume}_2 - \text{volume}_1}{\text{volume}_1} * 100\%$$

where,  $\text{volume}_1$  is the initial pellet volume obtained right after pelleting,  $\text{volume}_2$  is the stable pellet volume (the average value of the pellet volumes from day 3 to day 5). A smaller spring-



back represents a higher pellet stability.

Sugar yield is the amount of glucose obtained after pretreatment and hydrolysis. Pretreatment was carried out in a pressure reactor apparatus (Parr Instrument Company, Moline, IL, USA) equipped with impeller mixers and a pressurized injection device. Dissociated biomass was mixed with a sulfuric acid solution to obtain 10% dry matter. The slurry was loaded into a 1-L reactor and treated at 140°C for 30 minutes with diluted sulfuric acid (at a ratio of 20 g per liter of distilled water). Enzyme hydrolysis of pretreated biomass was conducted, following the NREL LAP procedure [23], in sealed serum bottles in a 50°C reciprocal water bath shaker running at 140 rpm for 48 hours. The enzyme used in the hydrolysis was Accellerase 1500 from Genencor (Rochester, NY, USA). After hydrolysis, a high performance liquid chromatography (HPLC) was used to measure the sugar yield.

### **6.3 Results on pellet density**

The results on pellet density are presented in Table 6.3. The significant main and interaction effects of process variables on pellet density are shown in Figure 6.4. All the main effects of the process variables are significant at the significant level of  $\alpha = 0.01$ . From Figure 6.4, it can be seen that pellet density increases with an increase of moisture content, pressure, and ultrasonic power. Pellet density decreases as particle size increases. Two interaction effects are significant at the significant level of  $\alpha = 0.002$ . From the interactions between ultrasonic power and pressure, it can be seen that the effects of pressure on pellet density are much stronger at the higher level of ultrasonic power. The interactions between ultrasonic power and moisture content show that, with the increase of ultrasonic power, pellet density will increase at the lower level of moisture content while decrease at the higher level of moisture content.

**Table 6.3 Results on pellet density**

Moisture content	Particle size	Pelleting pressure	Ultrasonic power	Pellet density (kg/m <sup>3</sup> )		
				Replication 1	Replication 2	Replication 3
1	1	1	1	644	675	670
-1	1	1	1	691	704	686
1	-1	1	1	935	929	908
-1	-1	1	1	963	966	929
1	1	-1	1	678	585	614
-1	1	-1	1	644	642	641
1	-1	-1	1	829	766	897
-1	-1	-1	1	861	873	888
1	1	1	-1	645	662	659
-1	1	1	-1	607	554	582
1	-1	1	-1	901	904	944
-1	-1	1	-1	856	870	889
1	1	-1	-1	605	674	697
-1	1	-1	-1	588	584	533
1	-1	-1	-1	879	954	885
-1	-1	-1	-1	862	842	831

**Figure 6.4 Main and interaction effects on pellet density**

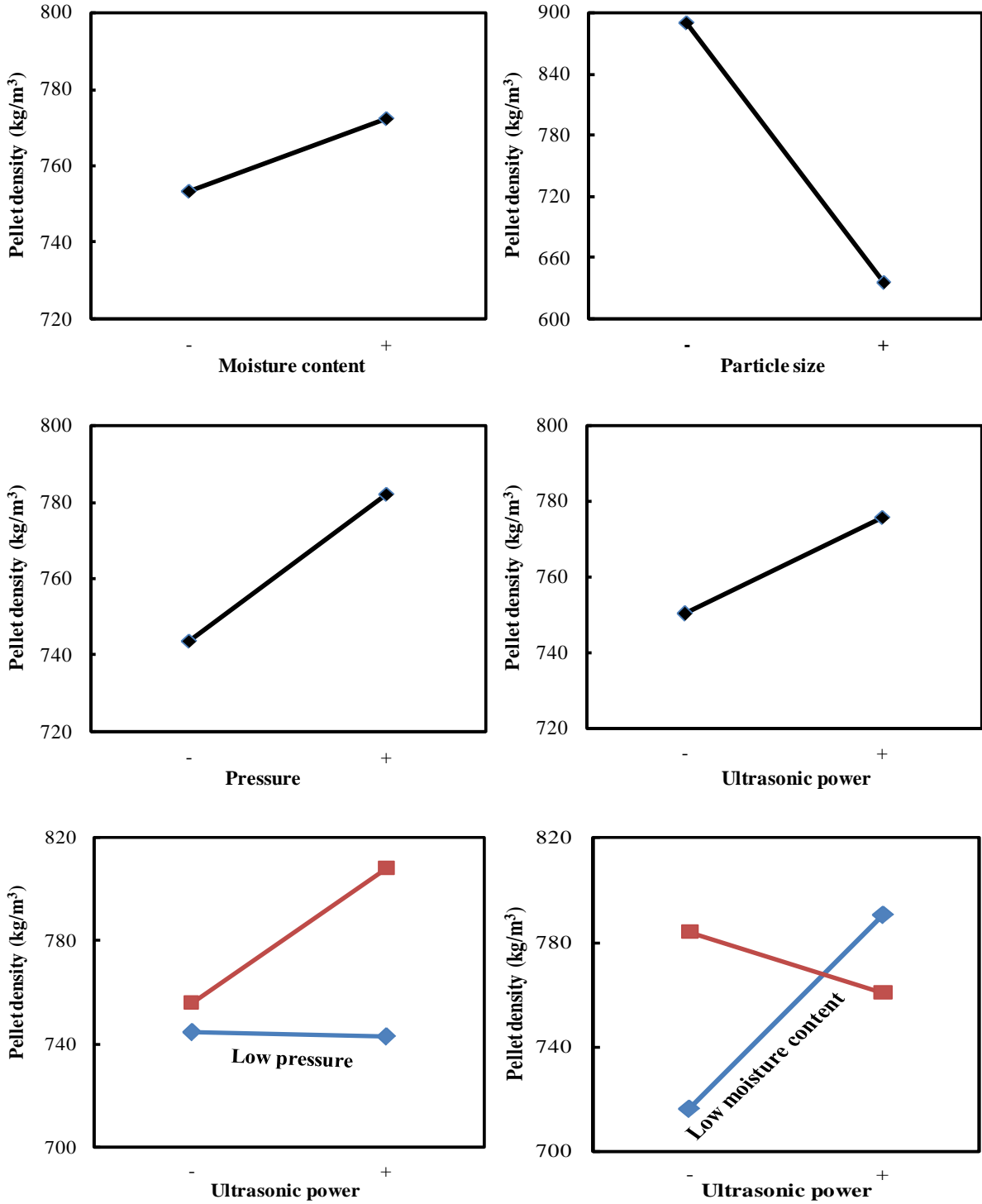

## 6.4 Results on pellet durability

The results on pellet durability are shown in Table 6.4. Moisture content, particle size, and ultrasonic power have significant main effects on pellet durability at the significance level of  $\alpha = 0.001$ , as shown in Figure 6.5. Pellet durability increases with an increased moisture content or ultrasonic power, or decreased particle size. At the significance level of  $\alpha = 0.02$ , the interaction effect between moisture content and ultrasonic power is significant. The effects of moisture content are much stronger at the lower level of ultrasonic power.

**Table 6.4 Results on pellet durability**

Moisture content	Particle size	Pelleting pressure	Ultrasonic power	Pellet durability (%)
1	1	1	1	71
-1	1	1	1	39
1	-1	1	1	94
-1	-1	1	1	67
1	1	-1	1	69
-1	1	-1	1	31
1	-1	-1	1	85
-1	-1	-1	1	70
1	1	1	-1	56
-1	1	1	-1	14
1	-1	1	-1	93
-1	-1	1	-1	49
1	1	-1	-1	50
-1	1	-1	-1	5
1	-1	-1	-1	91
-1	-1	-1	-1	44

**Figure 6.5 Main and interaction effects on pellet durability**

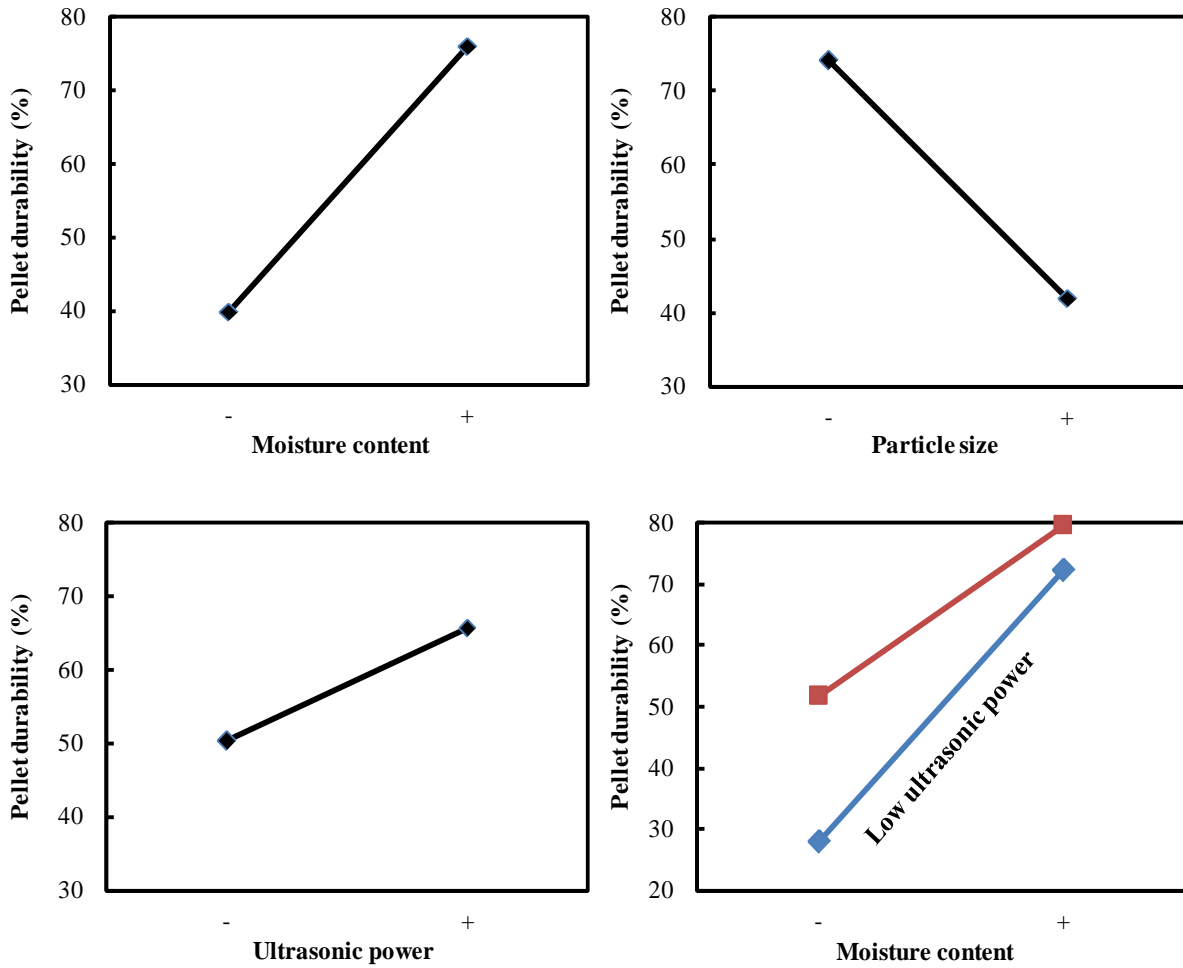

### 6.5 Results on pellet stability

Table 6.5 shows the results on pellet stability. ANOVA results show that the main effect of particle size is significant at the significance level of  $\alpha = 0.05$ . As shown in Figure 6.6, pellet stability decreases (spring-back increases) as particle size increases. There are no significant interactions between the input variables.

**Table 6.5 Results on pellet stability**

Moisture content	Particle size	Pelleting pressure	Ultrasonic power	Spring-back (%)		
				Replication 1	Replication 2	Replication 3
1	1	1	1	2.33	2.14	1.94
-1	1	1	1	0.31	0.10	0.22
1	-1	1	1	0.02	0.01	0.01
-1	-1	1	1	1.12	0.51	0.50
1	1	-1	1	3.61	2.42	3.01
-1	1	-1	1	1.91	2.77	2.05
1	-1	-1	1	0.02	0.03	0.02
-1	-1	-1	1	0.05	0.04	0.05
1	1	1	-1	1.20	1.49	1.32
-1	1	1	-1	2.29	2.75	2.60
1	-1	1	-1	0.52	0.76	0.35
-1	-1	1	-1	0.63	0.58	0.12
1	1	-1	-1	5.12	5.64	4.06
-1	1	-1	-1	0.75	1.05	0.86
1	-1	-1	-1	1.05	1.18	1.11
-1	-1	-1	-1	1.94	2.01	1.93

**Figure 6.6 Main effect on pellet stability**

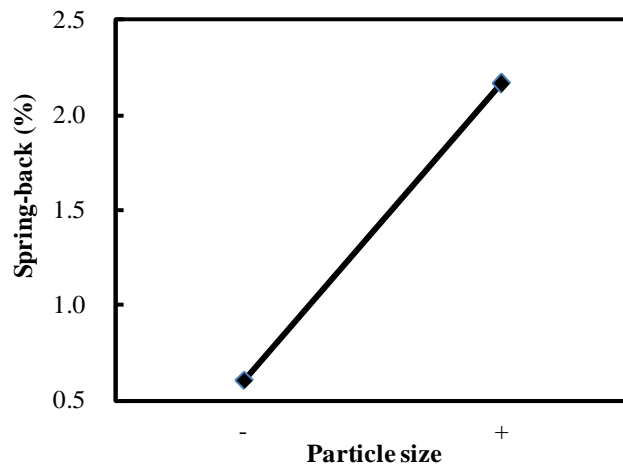

## 6.6 Results on sugar yield

The results on sugar yield are shown in Table 6.6. ANOVA results show that the main effect of particle size is significant at the significance level of  $\alpha = 0.05$ . As shown in Figure 6.7, sugar yield increases as particle size increases. A significance interaction effect can be found between particle size and moisture content at the significance level of  $\alpha = 0.05$ . With the increase of particle size, sugar yield will increase slightly at the low level of moisture content while increase dramatically at the high level of moisture content.

**Table 6.6 Results on sugar yield**

Moisture content	Particle size	Pelleting pressure	Ultrasonic power	Sugar yield (g/L)
1	1	1	1	1.75
-1	1	1	1	1.41
1	-1	1	1	1.18
-1	-1	1	1	1.08
1	1	-1	1	1.92
-1	1	-1	1	1.54
1	-1	-1	1	1.40
-1	-1	-1	1	1.50
1	1	1	-1	1.75
-1	1	1	-1	1.44
1	-1	1	-1	0.77
-1	-1	1	-1	1.31
1	1	-1	-1	1.73
-1	1	-1	-1	1.06
1	-1	-1	-1	1.41
-1	-1	-1	-1	1.26

**Figure 6.7 Main and interaction effects on sugar yield**

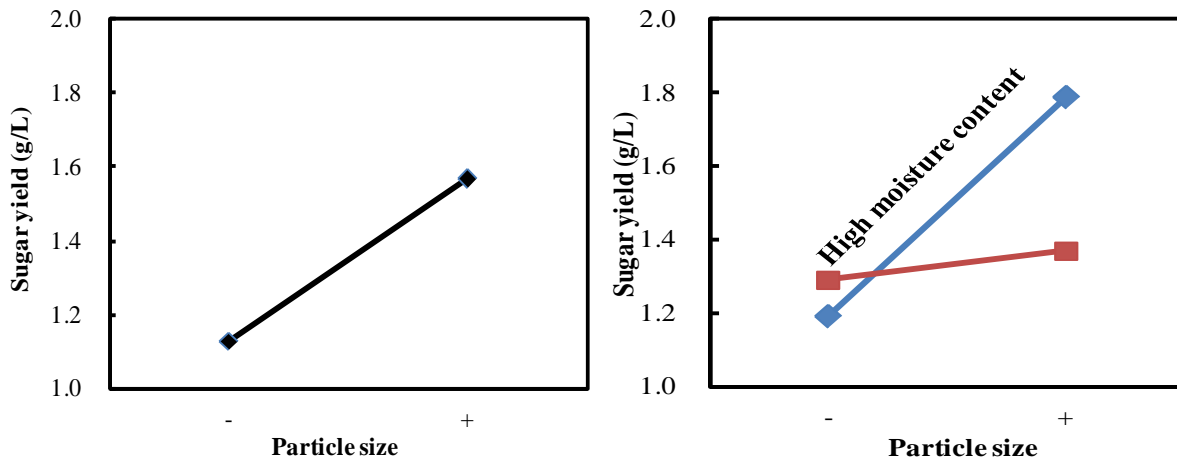

## 6.7 Conclusions

A  $2^4$  full factorial design was used to conduct a set of parametric experiments of ultrasonic vibration-assisted (UV-A) pelleting on wheat straw. The main effects and two-factor interactions of input variables (moisture content, particle size, pelleting pressure, and ultrasonic power) on output variables (pellet density, durability, stability, and sugar yield) are evaluated. The following conclusions can be drawn from the experiments:

(1) For pellet density, the main effects of all four input variables (moisture content, particle size, pelleting pressure, and ultrasonic power) are significant. Two interaction effects (between ultrasonic power and pressure, and between ultrasonic power and moisture content) are significant.

(2) For pellet durability, moisture content, particle size, and ultrasonic power, as well as the interaction effects between moisture content and ultrasonic power are significant.

(3) For pellet stability, only the main effect of particle size is significant.

(4) For sugar yield, the main effect of particle size and the interaction effects between particle size and moisture content are significant.



## Acknowledgements

The authors gratefully extend their acknowledgements to Mr. Clyde Treadwell at Sonic Mill for his technical support on experimental equipment.

## References

- [1] Energy Information Administration, "U.S. energy consumption by sector of 1949-2008," 2008, retrieved from: <http://www.eia.doe.gov/emeu/aer/txt/ptb0202a.html>.
- [2] Energy Information Administration, "Petroleum products supplied by type of 1949-2008," 2008, retrieved from: <http://www.eia.doe.gov/emeu/aer/txt/ptb0511.html>.
- [3] Energy Information Administration, "Transportation sector energy consumption estimates," 2007, retrieved from: [http://www.eia.doe.gov/emeu/states/sep\\_sum/html/sum\\_btu\\_tra.html](http://www.eia.doe.gov/emeu/states/sep_sum/html/sum_btu_tra.html).
- [4] National academy of sciences, National academy of engineering, and National research council, Liquid transportation fuels from coal and biomass, The National Academies Press, Washington, USA, 2009.
- [5] U.S. Department of Energy, "Breaking the biological barriers to cellulosic ethanol: A joint research agenda," 2009, retrieved from: <http://genomicscience.energy.gov/biofuels/b2bworkshop.shtml>.
- [6] Fairfax Media, "US pumps more money into cellulosic ethanol research," 2008, retrieved from: <http://sl.farmonline.com.au/news/nationalrural/agribusiness-and-general/general/us-pumps-more-money-into-cellulosic-ethanol-research/1234385.aspx>.
- [7] J. Moresco, "U.S. biofuel output to miss mandates," 2008, retrieved from: <http://www.redherring.com/Home/25682>.
- [8] E.M. Rubin, "Genomics of cellulosic biofuels," Nature, Vol. 454, No. 14, pp. 841-845,

2008.

- [9] G.W. Huber, “Breaking the Chemical and Engineering Barriers to Lignocellulosic Biofuels: Next Generation Hydrocarbon Biorefineries,” 2008, retrieved from: <http://www.ecs.umass.edu/biofuels/Images/Roadmap2-08.pdf>.
- [10] J.R. Hess, C.T. Wright, and K.L. Kenney, “Cellulosic Biomass Feedstocks and Logistics for Ethanol Production,” *Biofuels, Bioproducts and Biorefining*, Vol. 1, No. 3, pp. 181–190, 2007.
- [11] A. Waves, “Ethanol Faces Challenges Ahead,” 2009, retrieved from: <http://naturalresourcereport.com/2009/08/ethanol-faces-challenges-ahead/>.
- [12] J. Kho, “Fuel From Utility Poles: Cellulosic Ethanol Heats Up in Cool Economy,” 2009, retrieved from: <http://cleantechnica.com/2009/01/19/fuel-from-utility-poles-cellulosic-ethanol-heats-up-in-cool-economy/>
- [13] B. Yang, and E. Wyman, “Pretreatment: The Key to Unlocking Low-Cost Cellulosic Ethanol,” *Biofuels, Bioproducts, and Biorefining*, Vol. 2, No. 1, pp. 26-40, 2008.
- [14] A. Aden, M. Ruth, K. Ibsen, J. Jechura, K. Neeves, J. Sheehan, B. Wallace, L. Montague, A. Slayton, and J. Lukas, “Lignocellulosic biomass to ethanol process design and economics utilizing co-current dilute acid prehydrolysis and enzymatic hydrolysis for corn stover,” NREL Technical paper, TP-510-32438, 2002.
- [15] R. Wooley, M. Ruth, J. Sheehan, K. Ibsen, H. Majdeski, and A. Galvez, “Lignocellulosic biomass to ethanol process design and economics utilizing co-current dilute acid prehydrolysis and enzymatic hydrolysis current and futuristic scenarios,” NREL Technical Paper, TP-580-26157, 1999.
- [16] S. Mani, L.G. Tabil, and S. Sokhansanj, 2003, “An overview of compaction of biomass

- grinds,” *Powder Handling and Processing*, Vol. 15, No. 3, pp. 160-168, 2003.
- [17] S. Sokhansanj, S. Mani, and P. Zaini, “Binderless pelletization of biomass,” ASABE Technical Paper, 056061, American Society of Agricultural and Biological Engineers, St. Joseph, MI, 2005.
- [18] Z.J. Pei, D.H. Wang, and R. Clark, “Ultrasonic vibration-assisted pelleting of cellulosic biomass: A preliminary experiment,” *Proceedings of the 2009 International Manufacturing Science and Engineering Conference*, West Lafayette, IN, US, October 4-7, 2009, MSEC2009-84205.
- [19] W.L. Cong, P.F. Zhang, N. Qin, M. Zhang, X.X. Song, Q. Zhang, D. Nottingham, R. Clark, T. Deines, Z.J. Pei, and D.H. Wang, “Ultrasonic Vibration-Assisted Pelleting of Cellulosic Biomass for Biofuel Manufacturing,” Poster presentation at the 2009 International Manufacturing Science and Engineering Conference, West Lafayette, IN, US, October 4-7, 2009, MSEC2009-84432.
- [20] P.F. Zhang, Z.J. Pei, D.H. Wang, X.R. Wu, W.L. Cong, M. Zhang, and T. Deines, “Ultrasonic vibration-assisted pelleting of cellulosic biomass for biofuel manufacturing,” submitted to *Journal of Manufacturing Science and Engineering*.
- [21] ASABE Standard S358.2, “Moisture Measurement—Forages,” American Society of Agricultural and Biological Engineers, St. Joseph, US, 2002.
- [22] ASABE Standard S269.4, “Cubes, pellets, and crumbles—definitions and methods for determining density, durability, and moisture content,” American Society of Agricultural and Biological Engineers, St. Joseph, US, 2002.

## **Chapter 7 - Comparison of sugar yield from biomass processed and not processed by UV-A pelleting**

This chapter focuses on comparing the sugar yield from biomass processed and not processed by UV-A pelleting. Box-Behnken design is employed to investigate the sugar yield under different pretreatment conditions. The obtained data are analyzed based on response surface methodology (RSM). The content of this chapter will be submitted to Journal of Manufacturing Science and Engineering.

### Paper Title:

Ultrasonic vibration-assisted pelleting in manufacturing of cellulosic ethanol: comparing sugar yield under different pretreatment conditions

### To be submitted to:

Journal of Manufacturing Science and Engineering

### Author's names:

Pengfei Zhang<sup>1</sup>, Kangqi Fan<sup>1,2</sup>, Qi Zhang<sup>1</sup>, Z.J. Pei<sup>1</sup>, Feng Xu<sup>3</sup>, Donghai Wang<sup>3</sup>

### Author's Affiliation:

1. Department of Industrial and Manufacturing Systems Engineering, Kansas State University, 2037 Durland Hall, Manhattan, KS 66506

2. School of Electronical and Mechanical Engineering, Xidian University, P.O. Box 181, Xi'an, Shaanxi 710071, China

3. Department of Biological and Agricultural Engineering, Kansas State University, 150 Seaton Hall, Manhattan, KS 66506

## **Abstract**

Ultrasonic vibration-assisted (UV-A) pelleting of cellulosic biomass can increase biomass density and reduce transportation costs in cellulosic ethanol manufacturing. A preliminary study shows that sugar yield of pellets processed by UV-A pelleting is higher than that of biomass not processed by UV-A pelleting. However, this result is obtained under a specific pretreatment condition. This paper reports an investigation to compare sugar yields between two kinds of materials: pellets processed by UV-A pelleting (or UV-A pellets) and biomass not processed by UV-A pelleting (or powders) under different combinations of three pretreatment variables (temperature, processing time, and solid content). For each kind of material, a Box-Behnken design is employed to investigate sugar yields from three levels of each pretreatment variable, and the results are analyzed based on response surface methodology (RSM). Regression models of sugar yield are obtained. Sugar yields of the two kinds of materials are compared based on experimental data and regression models. Results show that UV-A pellets have higher sugar yield than powders under all combinations of pretreatment variables. The sugar yield difference is larger with shorter processing time and more solid content.

## **7.1 Introduction**

During the last three decades, consumption of liquid transportation fuels (including gasoline, diesel, and jet fuels) in the U.S. has increased by more than 30% [1]. Conventional

liquid transportation fuels are distilled from petroleum and account for about 70% of total petroleum consumption [1]. In 2010, about 15 million barrels of petroleum was consumed in the U.S. every day, and over 60% of them were imported [2]. In addition, price of petroleum in the U.S. has almost doubled during the last ten years [1]. Rising petroleum price and concerns about the nation's energy security necessitates finding alternatives to petroleum-based liquid transportation fuels.

Biofuels can be used as liquid transportation fuels. Ethanol (which has been used as additive to gasoline) is the most widely used biofuel [3]. Ethanol can be used readily by current-generation vehicles and distributed through the existing infrastructure without (or with slight) modifications [4]. In 2010, about 14.7 billion gallons of ethanol was produced in the U.S. [2]. The U.S. government has called for increasing the ethanol production to levels that would replace about 30% of the annual petroleum consumption (or roughly 90 billion gallons) by 2030 [5,6].

Cellulosic biomass (fibrous, woody, and generally inedible portions of plant matter) has been regarded as an important feedstock for ethanol production due to environmental, social, and other benefits [4,7]. Major steps in cellulosic ethanol manufacturing are shown in Figure 7.1. Planting, harvesting, and collection are required to produce cellulosic feedstocks. Storage and transportation of biomass are required by feedstock logistics. Pretreatment, hydrolysis, and fermentation are the three major steps to convert biomass into ethanol. The purpose of pretreatment is to make cellulose more accessible to hydrolysis [4,8]. Hydrolysis breaks down cellulose into its component sugars that are converted to ethanol by fermentation [4,8].

**Figure 7.1 Major steps in cellulosic ethanol manufacturing (after [8])**

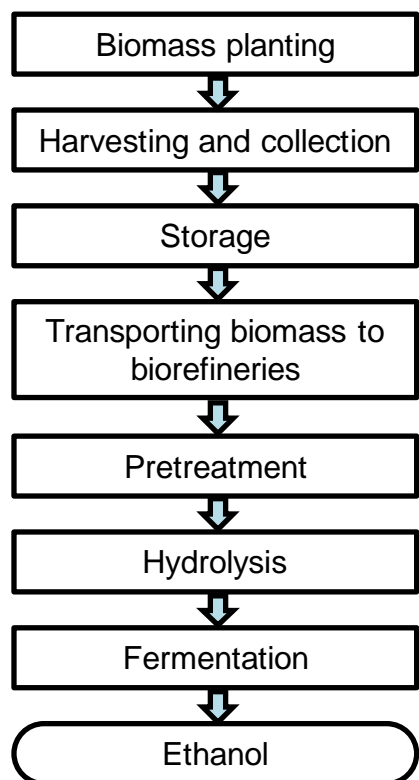

A major challenge in cellulosic ethanol manufacturing is high manufacturing costs that are attributed, to a great extent, to low density of cellulosic feedstocks (causing high transportation costs) and low efficiency of hydrolysis. Ultrasonic vibration-assisted (UV-A) pelleting can increase the density of cellulosic biomass by more than 10 times [9,10]. A preliminary study also shows that sugar yield of biomass processed by UV-A pelleting (or UV-A pellets) is 23% higher than that of biomass not processed by UV-A pelleting (or powders) under a specific pretreatment condition [10]. However, there is lack of comparisons on sugar yields of UV-A pellets and powders under other pretreatment conditions. This paper reports an investigation to compare sugar yields between UV-A pellets and powders under different combinations of three pretreatment variables (temperature, processing time, and solid content).

For each kind of material, a Box-Behnken design is employed to investigate sugar yields from three levels of each pretreatment variable, and the results are analyzed based on response surface methodology (RSM). Regression models of sugar yield are obtained. Sugar yields of the two kinds of materials are compared based on experimental data and regression models.

## **7.2 Experimental procedures and conditions**

The experimental procedure is presented in Figure 7.2. The cellulosic biomass used in this study was wheat straw which was harvested from northwestern Kansas and stored indoors before use. Hammer milling was used for size reduction of wheat straw to powders. The straw powders were separated into two groups. One group went through pretreatment and hydrolysis. Then its sugar yield was measured and referred to as sugar yield A. The other group was compressed into pellets by using UV-A pelleting. The produced pellets went through pretreatment and hydrolysis. Their sugar yield was then measured and referred to as sugar yield B.

### ***7.2.1 Hammer milling***

In this study, a hammer mill (model 35, Meadows Mills, Inc., North Wilkesboro, NC, USA) was used to produce wheat straw powders. A sieve with a 2 mm screen size was put in the hammer mill to control particle size. The hammer mill had a steel drum containing a horizontal rotating shaft on which panels were welded, as shown in Figure 7.3. The hammers were mounted on panels using a pin and were free to swing on the ends of the panels. Biomass particle size was reduced by hammers hitting biomass. The particles fell through the sieve if they were small enough. Large particles were hit more by hammers until they could fall through the sieve.



**Figure 7.2 Experimental procedure**

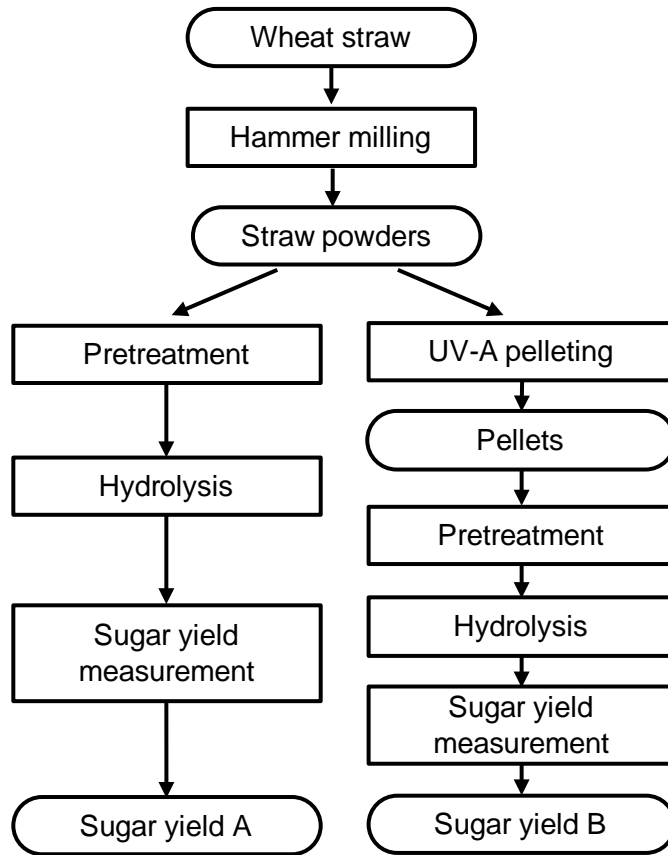

**Figure 7.3 Hammer milling**

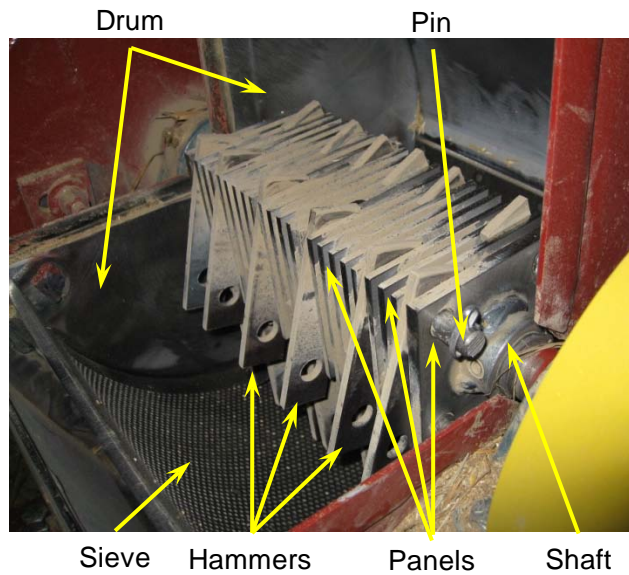

### 7.2.2 UV-A pelleting

The experimental setup of UV-A pelleting is schematically illustrated in Figure 7.4. A mold was fixed on a machine table using a fixture. The mold was made in three separate parts which were assembled together with pins. The top two parts formed a hollow cylindrical chamber and the bottom part served as a base. A certain amount of biomass (which was referred to as pellet weight) was loaded into the mold chamber.

**Figure 7.4 Illustration of UV-A pelleting setup**

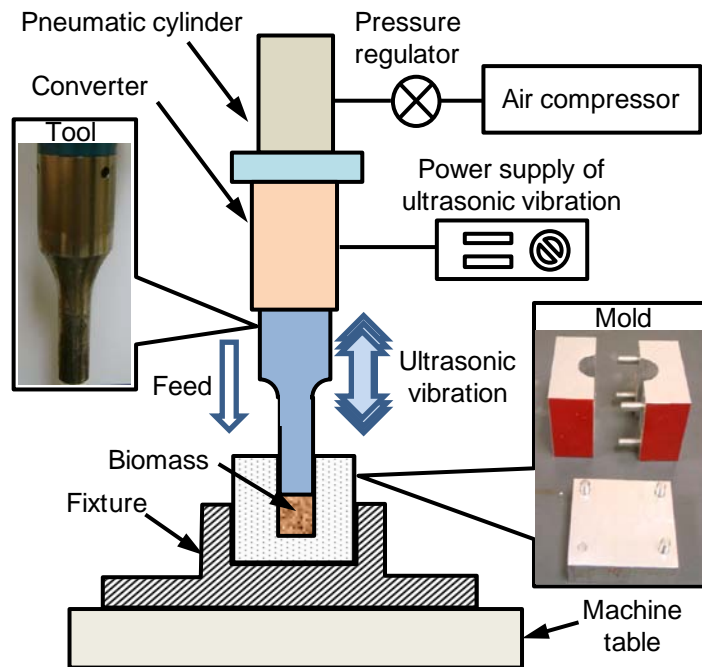

A tool with a solid cylinder tip was used to compress biomass. The diameter of the tool tip was 17.4 mm, slightly smaller than that of the mold chamber (18.6 mm). The tool was connected to an ultrasonic converter that generated ultrasonic vibration and transferred the vibration to the tool. A power supply provided the power needed to generate the ultrasonic

vibration and controlled the amplitude of the vibration. The frequency of the vibration was 20 kHz.

In UV-A pelleting, the tool was fed down with a constant pressure which was provided by an air compressor and controlled by a pressure regulator. In this study, the pressure applied on the top surface of wheat straw was referred to as pelleting pressure. When the tool moved down, the ultrasonic vibration was applied on it. The period of time when biomass was compressed was referred to as pelleting time. When the predetermined pelleting time was over, the tool was retracted and the mold disassembled to unload the pellet. The values of the main UV-A pelleting variables in this study were shown in Table 7.1.

**Table 7.1 Values of main UV-A pelleting variables**

Variable	Value
Pelleting pressure (psi)	1600
Pellet weight (gram)	2
Pelleting time (min)	1

### ***7.2.3 Pretreatment***

Pretreatment was carried out in a pressure reactor (Parr Instrument Company, Moline, IL, USA). As illustrated in Figure 7.5, the reactor had a 600 mL reaction vessel. Wheat straw and 300 mL diluted sulfuric acid (1% w/v) were loaded in the vessel. The amount of wheat straw loaded (by weight) was referred to as solid content. The mixture of wheat straw and acid was stirred by two impeller mixers and treated at high temperatures that were generated by a heater.

The period of time when wheat straw was treated in the reactor was referred to as processing time. In this study, three levels of pretreatment variables (temperature, processing time, and solid content) were investigated, as shown in Table 7.2.

#### 7.2.4 Hydrolysis

Enzymatic hydrolysis was carried out in 125 mL flasks in a 50 °C water bath shaker (Model C76, New Brunswick Scientific, Edison, NJ, USA). The flasks were agitated at 110 rpm. In enzymatic hydrolysis, pretreated wheat straw was loaded in 50 mL solution with sodium acetate buffer (100 mM, pH 4.8) and 0.02% (w/v) sodium azide. Then, 1 mL enzyme (Accellerase 1500, Danisco US, Inc., Genencor Division, Rochester, NY) was loaded in the solution.

**Figure 7.5 Illustration of pretreatment reactor**

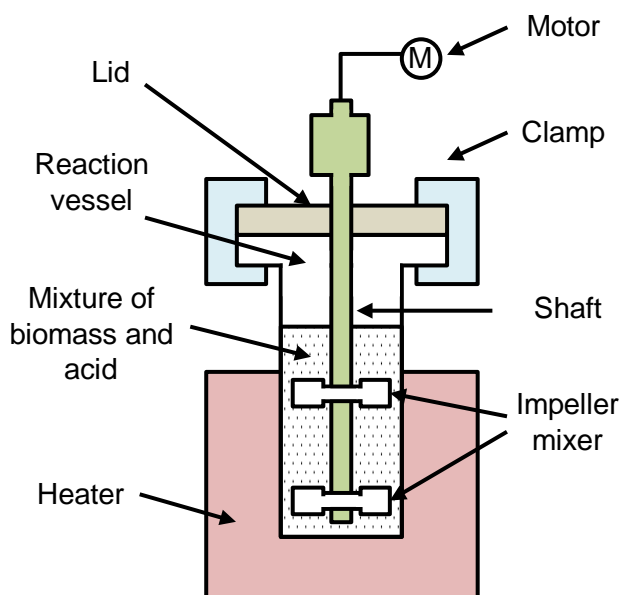

**Table 7.2 Values of main UV-A pelleting variables**

Variable	Unit	Low level	Middle level	High level
Solid content	g	10	15	20
Temperature	°C	120	140	160
Treat time	min	10	30	50

After enzymatic hydrolysis, the hydrolysis slurries were sampled by withdrawing 0.1 mL of slurry from each flask. Sample slurries were then mixed with 0.9 mL double-distilled water in 1.5 mL vials. The vials were placed to boiling water for 15 min to deactivate the enzyme. After the enzyme was deactivated, samples were centrifuged at 10,000 rpm for 15 minutes. The supernatants were then further diluted and filtered into 1.5 mL autosampler vials through 0.2  $\mu$ m syringe filters (Millipore, Billerica, MA, USA). Filtered samples were kept at 4 °C before sugar yield measurement.

### ***7.2.5 Sugar yield measurement***

In this study, sugar yield means the concentration of glucose in the prepared samples. It was determined by an HPLC (high-performance liquid chromatography) (Shimadzu, Kyoto, Japan) equipped with an RCM-monosaccharide column (300  $\times$  7.8 mm; Phenomenex, Torrance, CA, USA) and a refractive index detector (RID-10A, Shimadzu, Kyoto, Japan). In this investigation, sugar yield was referred to as the measured glucose concentration.

## 7.3 Results and discussion

Box-Behnken design was employed to setup the matrix of the experiments, as shown in Table 7.3. Such a matrix (including 15 runs) was applied for each type of wheat straw (UV-A pellets and powders). Results, also shown in Table 7.3, were analyzed by using analysis of variance (ANOVA) and response surface methodology (RSM) with Design Expert (StatEase, Inc., Minneapolis, MN, USA). The relationship between sugar yield and pretreatment variables was fitted by the following equation:

$$f(Y) = \beta_0 + \sum \beta_i x_i + \sum \beta_{ij} x_i x_j + \sum \beta_{ij} x^2 \quad (1)$$

where, Y represents the sugar yield,  $\beta$  represents the coefficient for each term, and x represents the pretreatment variables.

### 7.3.1 Sugar yield of powders

The relations between powder sugar yield and pretreatment variables are shown in Figure 7.6. It can be seen that a higher sugar yield can be obtained with a higher temperature, a longer processing time, or a less solid content. Through analysis in Design Expert, a regression model was obtained corresponding to the three pretreatment variables. ANOVA was then conducted to remove insignificant terms. A reduced model for powder sugar yield was obtained as:

$$\text{Powder sugar yield} = -43.025 + 0.598 \times A - 0.356 \times B + 0.09 \times C - 0.002 \times A^2 \quad (2)$$

where, A represents temperature, B represents processing time, and C represents solid content.

The analysis results of ANOVA indicated that the model was highly significant (p-value <0.001), and the value of R-squared was 0.9887, indicating that the regression model fitted the experimental results very well. Lack-of-fit test was performed to measure the failure of the model by representing data in the experimental domain at the points that are not included in the regression [11]. In this study, the test implied that lack-of-fit was insignificant, which suggested

that the model could well predict the powder sugar yield for the combinations of pretreatment variables which were not tested experimentally.

**Table 7.3 Experimental matrix and results**

Test #	Temperature (°C)	Processing time (min)	Solid content (g)	Powder sugar yield (g/L)	Pellet sugar yield (g/L)
1	160	20	30	9.10	10.19
2	140	20	50	8.01	8.58
3	140	20	10	5.44	7.02
4	140	15	30	7.60	8.44
5	120	10	30	4.56	4.97
6	160	10	30	10.12	10.63
7	120	15	50	4.64	5.01
8	160	15	10	8.98	10.51
9	160	15	50	10.12	10.63
10	140	15	30	7.04	7.74
11	140	10	10	6.90	7.87
12	120	20	30	3.32	3.95
13	120	15	10	2.98	3.67
14	140	15	30	7.26	8.20
15	140	10	50	9.46	9.74

**Figure 7.6 Relations between powder sugar yield and pretreatment variables**

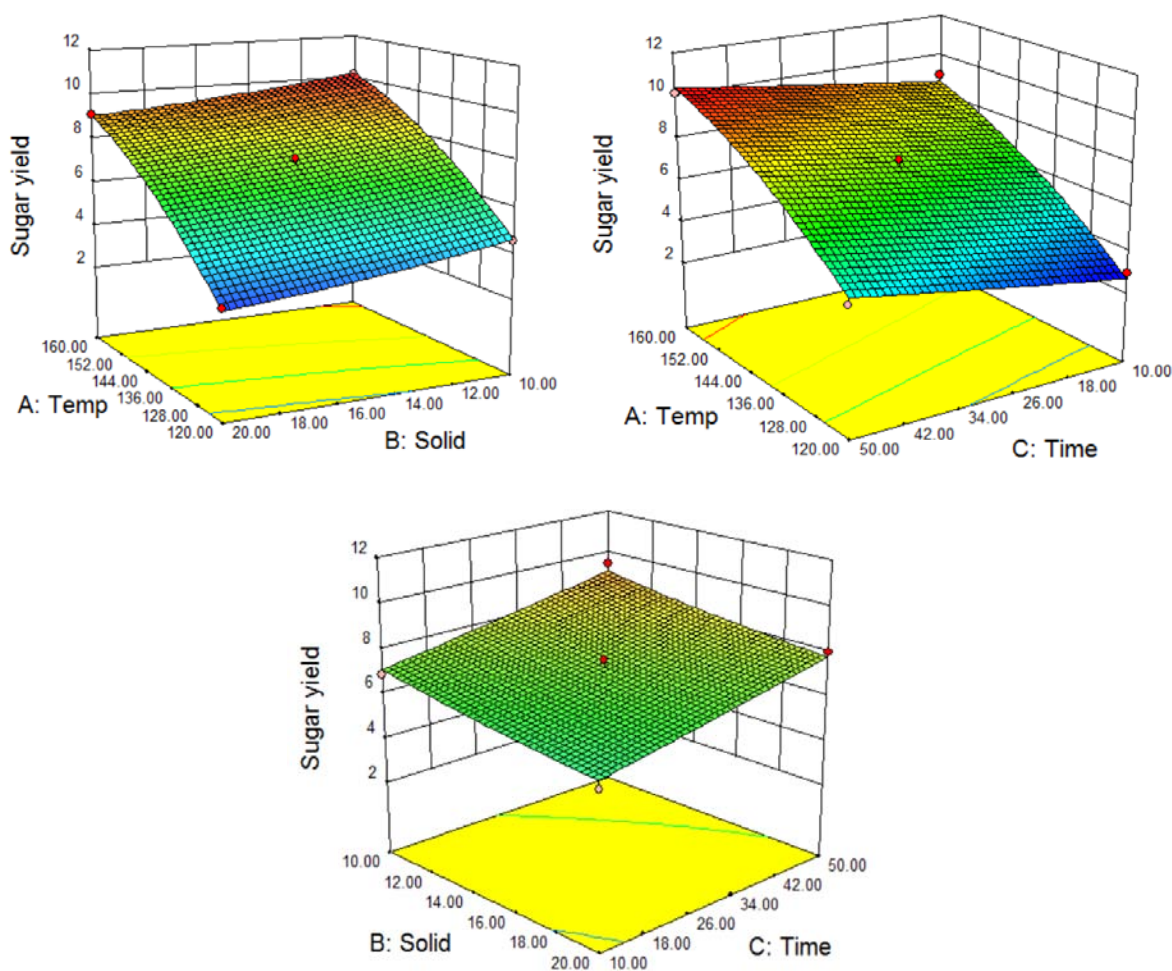

### **7.3.2 Sugar yield of UV-A pellets**

The relations between pellet sugar yield and pretreatment variables are shown in Figure 7.7. A higher temperature, a longer processing time, or a less solid content would lead to a higher sugar yield. Through analysis in Design Expert and analysis of ANOVA, a reduced model for sugar yield of UV-A pellets was obtained as:

$$\text{Pellet sugar yield} = -50.187 + 0.693 \times A - 0.36 \times B + 0.135 \times C - 0.002 \times A^2 \quad (3)$$

where, A represents temperature, B represents processing time, and C represents solid content.

The model was highly significant (p-value <0.001), and the value of R-squared was 0.9902,



indicating that the regression model fitted the experimental results very well. Lack-of-fit test was insignificant, which suggested that the model could provide good prediction.

**Figure 7.7 Relations between pellet sugar yield and pretreatment variables**

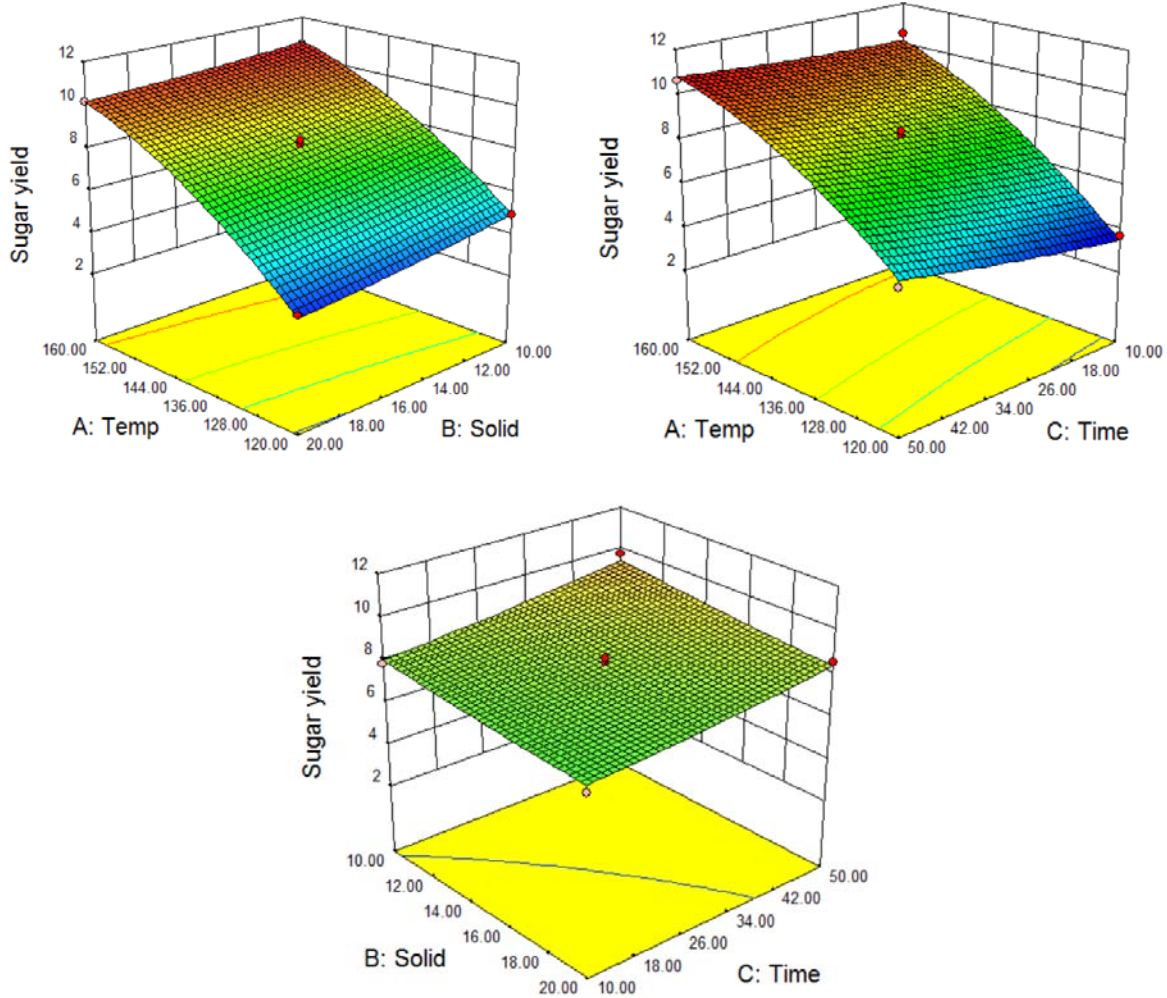

### ***7.3.3 Comparison of sugar yield***

Sugar yields of UV-A pellets and powders were compared over the entire range of one variable while keeping the other two variables constant. The sugar yield data were obtained from both experimental results and model prediction.

### 7.3.3.1 Sugar yield with different temperature

Figure 7.8 shows the comparison of sugar yield between UV-A pellets and powders when temperature changed. The two lines in Figure 7.8 presented predicted sugar yield for UV-A pellets and powders from regression models. Experimental results were plotted as single points. It can be seen that, UV-A pellets have higher sugar yield than powders. This is true for the entire temperature range investigated in this study.

**Figure 7.8 Sugar yield with different temperature**

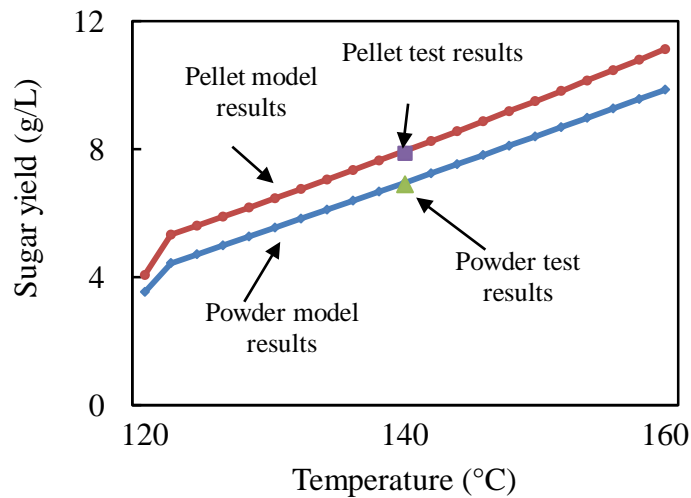

Processing time: 10 mins

Solid content: 10 grams

### 7.3.3.2 Sugar yield with different processing time

Figure 7.9 shows the comparison of sugar yield between UV-A pellets and powders when processing time changed. The two lines in Figure 7.9 presented predicted sugar yield for UV-A pellets and powders from regression models. Experimental results were plotted as single points. UV-A pellets have higher sugar yield than powders for the entire range of processing time. The

difference of sugar yield between UV-A pellets and powders are larger when processing time is shorter. As the processing time increases, difference of sugar yields between UV-A pellets and powders are much smaller.

### 7.3.3.3 Sugar yield with different solid content

Figure 7.10 shows the comparison of sugar yield between UV-A pellets and powders when solid content changed. The two lines in Figure 7.10 presented predicted sugar yield for UV-A pellets and powders from regression models. For the entire range of solid content, UV-A pellets have higher sugar yield than powders. The difference of sugar yield between UV-A pellets and powders become larger as solid content is increased.

**Figure 7.9 Sugar yield with different processing time**

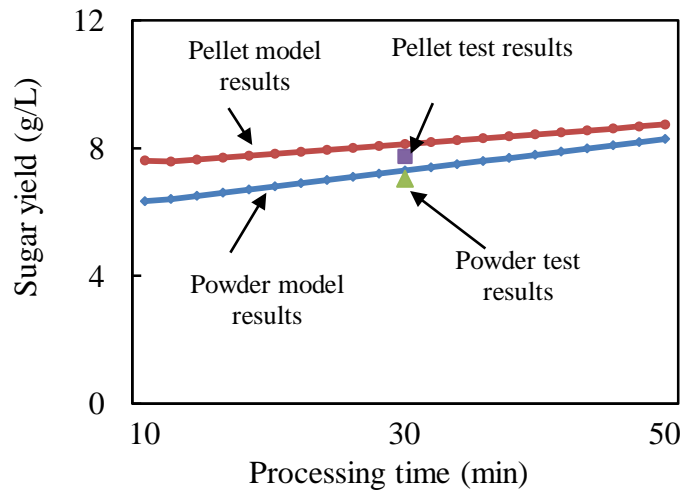

Temperature: 140 °C

Solid content: 15 grams

**Figure 7.10 Sugar yield with different solid content**

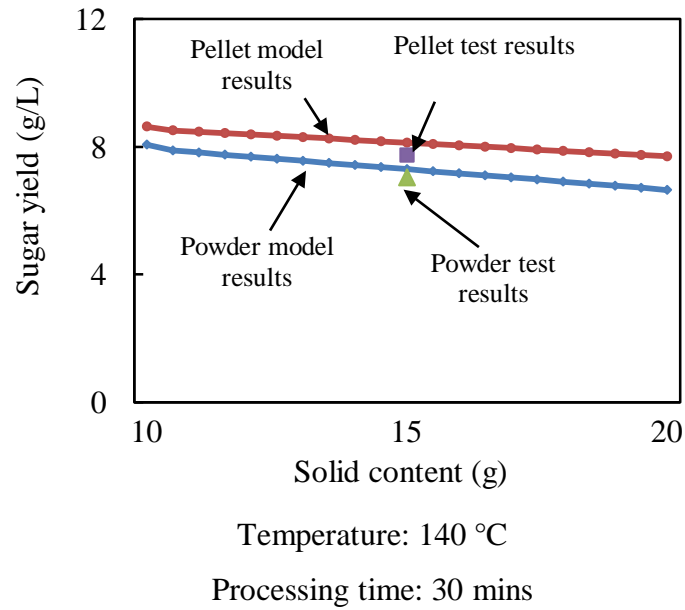

## 7.4 Conclusions

This paper reports an investigation to compare sugar yields between biomass processed by UV-A pelleting (or UV-A pellets) and biomass not processed by UV-A pelleting (or powders) under different combinations of three pretreatment variables (temperature, processing time, and solid content). Major conclusions are:

- (1) Same trend of relations between pretreatment variables and sugar yield are found for both powders and UV-A pellets. A higher sugar yield can be obtained with a higher temperature, a longer processing time, or a less solid content.
- (2) UV-A pellets have higher sugar yield than powders for the entire range of the investigated pretreatment variables. The difference of sugar yield between powders and UV-A pellets is larger when shorter processing time or more solid content is applied.

## Acknowledgements

This study is supported by NSF award CMMI-0970112. The authors gratefully extend their acknowledgements to Mr. Clyde Treadwell at Sonic Mill for providing the UV-A pelleting unit.

## References

- [1] Energy Information Administration, 2009, U.S. energy consumption by sector of 1949-2009, <http://www.eia.doe.gov/emeu/aer/pdf/pages/sec2.pdf>.
- [2] Energy Information Administration, Short-term energy outlook, July, 2011, [http://www.eia.gov/steo/steo\\_full.pdf](http://www.eia.gov/steo/steo_full.pdf).
- [3] Demirbas, A., 2005, "Bioethanol from cellulosic materials: a renewable motor fuel from biomass," *Energy Source*, 27, pp. 327-337.
- [4] U.S. Department of Energy, 2006, Breaking the biological barriers to cellulosic ethanol: a joint research agenda, <http://genomicscience.energy.gov/biofuels/2005workshop/b2bhighres63006.pdf>.
- [5] U.S. Department of Energy, 2003, Roadmap for agriculture biomass feedstock supply in the United States, <http://www.inl.gov/technicalpublications/Documents/3323197.pdf>.
- [6] Sokhansanj, S., Turhollow, A., Tagore, S., and Mani, S., 2006, "Integrating biomass feedstock with an existing grain handling system for biofuels," ASABE Technical Paper No. 066189, American Society of Agricultural and Biological Engineers, St. Joseph, MI, USA.
- [7] Decker, J., 2009, Going against the grain: ethanol from lignocellulosics, *Renewable Energy World*, <http://www.renewableenergyworld.com/rea/news/article/2009/01/going-against-the-grain-ethanol-from-lignocellulosics-54346>.

- [8] Rubin, E.M., 2008, "Genomics of cellulosic biofuels," *Nature*, 454, pp. 841-845.
- [9] Zhang, P.F., Deines, T., Nottingham, D., Pei, Z.J., Wang, D.H., and Wu, X.R., "Ultrasonic vibration-assisted pelleting of biomass: a designed experimental investigation on pellet quality and sugar yield," *Proceedings of the 2010 International Manufacturing Science and Engineering Conference*, Erie, PA, US, October 12-15.
- [10] Zhang, P.F., Pei, Z.J., Wang, D.H., Wu, X.R., Cong, W.L., Zhang, M., and Deines, T., 2011, "Ultrasonic vibration-assisted pelleting of cellulosic biomass for biofuel manufacturing," *Journal of Manufacturing Science and Engineering*, 133(1), pp. 1087-1357.
- [11] Rastogi, N., and Rashmi, K., 1999, "Optimisation of enzymatic liquefaction of mango pulp by response surface methodology," *European food research and technology*, 209 (1), 57-62.

## **Chapter 8 - Mechanism of UV-A pelleting to enhance sugar yield – an investigation on biomass particle size**

This chapter presents an investigation on the mechanisms for UV-A pelleting to increase sugar yield. A hypothesis for UV-A pelleting to increase sugar yield is that UV-A pelleting reduces the particle size of cellulosic biomass. This paper reports an experimental investigation on effects of UV-A pelleting on biomass particle size. Particle sizes before and after UV-A pelleting are measured and compared. The content of this chapter has been published as a technical paper.

### Paper title:

Ultrasonic vibration-assisted pelleting in manufacturing of cellulosic biofuels: an investigation on biomass particle size

### Published in:

Proceedings of the ASME International Conference on Manufacturing Science and Engineering (IMECE), November 11-17, 2011, Denver, CO, USA

### Authors' names:

Pengfei Zhang<sup>1</sup>, Qi Zhang<sup>1</sup>, Z.J. Pei<sup>1</sup>, Linda Pei<sup>2</sup>

### Authors' Affiliations:

1. Department of Industrial and Manufacturing Systems Engineering, Kansas State University, 2037 Durland Hall, Manhattan, KS 66506

2. Manhattan High School, Manhattan, KS 66506

## **Abstract**

Biofuels made from cellulosic biomass are an alternative to petroleum-based liquid transportation fuels. However, several technical barriers have hindered cost-effective manufacturing of cellulosic biofuels, such as low density of cellulosic feedstocks (causing high transportation and storage costs) and low sugar yield in enzymatic hydrolysis. Ultrasonic vibration-assisted (UV-A) pelleting can increase the density of cellulosic feedstocks and the sugar yield in enzymatic hydrolysis. A hypothesis for UV-A pelleting to increase sugar yield is that UV-A pelleting reduces the particle size of cellulosic biomass. This paper reports an experimental investigation on effects of UV-A pelleting on biomass particle size. Particle sizes before and after UV-A pelleting are measured and compared. The results show that there is no significant difference between particle sizes before and after UV-A pelleting. Therefore, the hypothesis is rejected.

## **8.1 Introduction**

During the last three decades, consumption of conventional liquid transportation fuels (including gasoline, diesel, and jet fuels) in the U.S. has increased by 50% [1]. Conventional liquid transportation fuels are distilled from petroleum and account for 70% of total petroleum consumption [1,2]. In 2010, the U.S. transportation sector consumed about 19.1 million barrels of petroleum every day, and 49.4% of them were imported [3]. Also, use of conventional liquid transportation fuels contributes to accumulation of greenhouse gas (GHG) in the atmosphere.



Finite reserves, non-uniform distribution, volatile prices, and GHG emissions of petroleum make it very important to develop domestic sustainable sources for liquid transportation fuels in the U.S..

Cellulosic biofuels produced from cellulosic biomass (the fibrous, woody, and generally inedible portions of plant matter) can reduce the U.S.'s dependence on foreign petroleum and cut GHG emissions while continuing to meet the nation's needs for liquid transportation fuels [4-6]. The U.S. government recently has called for an annual production of 36 billion gallons of biofuels by 2022 [7]. In 2009, about 10.8 billion gallons of bioethanol (one type of biofuel) was produced in the U.S. [8]. At present, more than 90% of bioethanol is produced from corn [9]. A dramatic increase in bioethanol production from corn may be limited because corn production for bioethanol will compete with food and feed production for limited agricultural land. Cellulosic biofuels do not possess such limitations.

Figure 8.1 shows major steps in manufacturing of cellulosic biofuels. A key barrier to cost-effective manufacturing of cellulosic biofuels is their high manufacturing costs which are, to a great extent, caused by low density of bulky cellulosic feedstocks (resulting in high transportation costs) [12-15] and low sugar yield in enzymatic hydrolysis (making hydrolysis one of the most costly processes) [5,16-18].

**Figure 8.1 Major steps in manufacturing of cellulosic biofuels (after [10,11])**

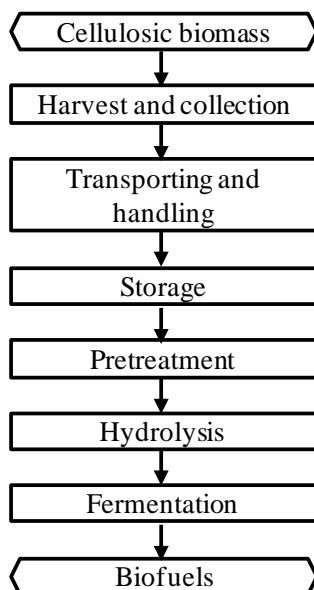

Traditional pelleting methods (e.g., using a screw extruder, a briquetting press, or a rolling machine [19,20]) have been used to increase the density of cellulosic feedstocks. But they generally involve high-temperature steam and high pressure, and often use binder materials. It is difficult to realize cost-effective pelleting on or near the field (where cellulosic biomass is available) with traditional pelleting methods. Ultrasonic vibration-assisted (UV-A) pelleting, without using high-temperature steam, high pressure, and binder materials, can produce biomass pellets whose density is comparable to those produced by traditional pelleting methods [21-23]. In addition, UV-A pelleting can significantly increase sugar yield of cellulosic biomass in enzymatic hydrolysis. Results of preliminary tests show that sugar yield from cellulosic biomass processed with UV-A pelleting is more than 20% higher than that without UV-A pelleting [24].

Up to now, the mechanisms through which UV-A pelleting can increase sugar yield of cellulosic biomass are not clear. Knowledge of such mechanisms will be useful in optimizing the

parameters of UV-A pelleting for further increasing of sugar yield. Therefore, investigations on such mechanisms are of high interest.

Bulky cellulosic feedstocks need to be turned into particles before UV-A pelleting and enzymatic hydrolysis. The size of these cellulosic particles is an important input parameter of enzymatic hydrolysis. Many researchers have reported that smaller particle sizes usually produce higher sugar yields [25-30]. A hypothesis for UV-A pelleting to increase sugar yield is that UV-A pelleting reduces the particle size of cellulosic biomass. The hypothesis will be rejected if UV-A pelleting has no effects on particle size. This paper reports an experimental investigation on effects of UV-A pelleting on biomass particle size. Particle sizes before and after UV-A pelleting are measured and compared.

## **8.2 Experimental conditions**

The experimental procedure is shown in Figure 8.2. Bulky wheat straw was harvested from northwestern Kansas and stored indoors before use. Milling and manual cutting were used to produce wheat straw particles. After UV-A pelleting, pellets were soaked in distilled water to separate them into individual particles for measurements. Particle sizes before and after UV-A pelleting (and water soaking) were referred to as size 1 and size 2 respectively.

**Figure 8.2 Experimental procedure**

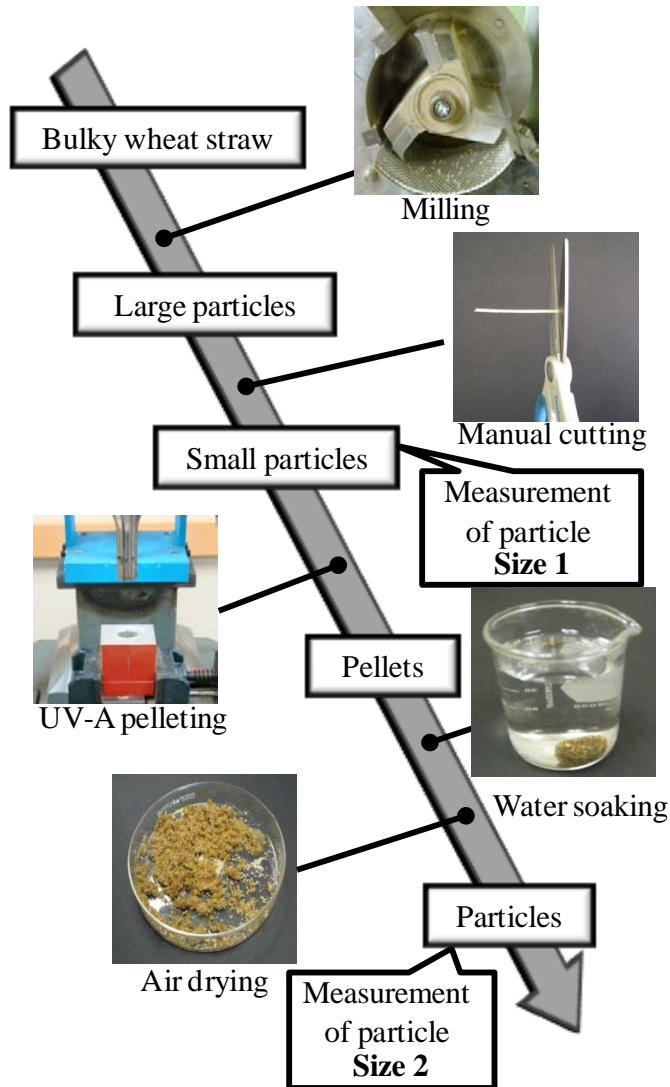

### ***8.2.1 Milling***

A knife mill (model SM 2000, Retsch, Inc., Haan, Germany) was used to mill bulky wheat straw into particles. A sieve with 2 mm screen size was put in the knife mill to control particle size. Wheat straw particles after knife milling had a wide range of lengths (from less than 10 mm to more than 50 mm), as shown in Figure 8.3.

**Figure 8.3 Wheat straw particles after knife milling**

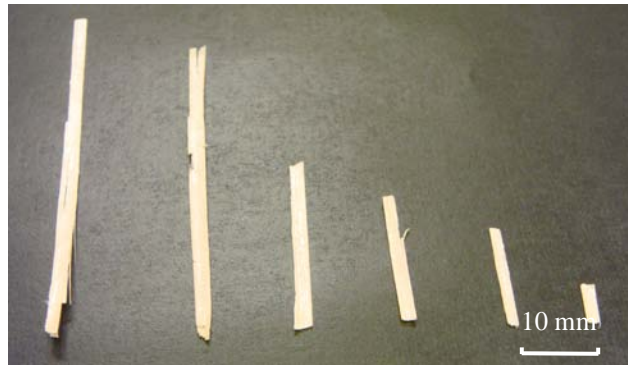

### ***8.2.2 Manual cutting***

Ten grams of milled particles were cut into smaller particles manually with scissors. The manually-cut particles had a roughly rectangular shape, as shown in Figure 8.4. A ruler was used to control the particle size to be between 1 to 2 mm.

**Figure 8.4 Shape and size of a manually-cut particle**

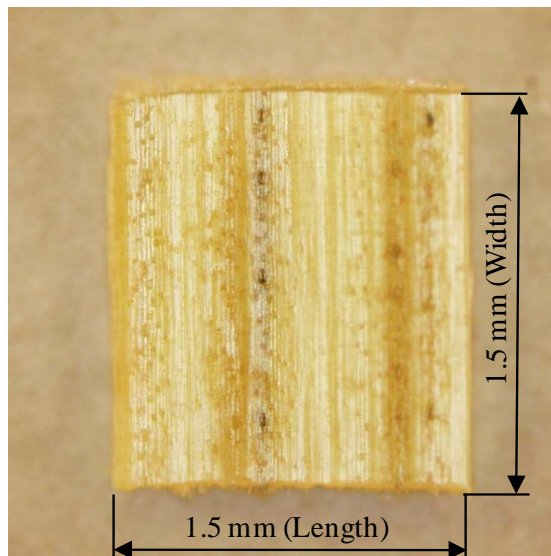

### ***8.2.3 Ultrasonic vibration-assisted pelleting***

Moisture content (amount of water contained in cellulosic biomass) of manually-cut wheat straw particles was adjusted to 10% by following the ASABE Standard S358.2 [31]. Then the manually-cut particles were pelleted into 10 pellets (1 gram per pellet) using an ultrasonic machine (Sonic-Mill, Albuquerque, NM, USA). The experimental setup of UV-A pelleting is illustrated in Figure 8.5. The tool was connected to an ultrasonic converter that provided ultrasonic vibration to the tool. The mold was made in three separate parts which were assembled together with pins. The top two parts formed a hollow cylinder and the bottom part served as a base. Biomass was loaded into the center cavity of the mold, and the tool was fed into this cavity. The tip of the tool was a solid cylinder that had a diameter of 17.4 mm, slightly smaller than that of the central hole (18.6 mm) in the mold. After a predetermined period of time, the tool was retracted and the mold disassembled to unload the pellet. After UV-A pelleting, a cylinder shaped pellet was obtained.

**Figure 8.5 Illustration of UV-A pelleting setup**

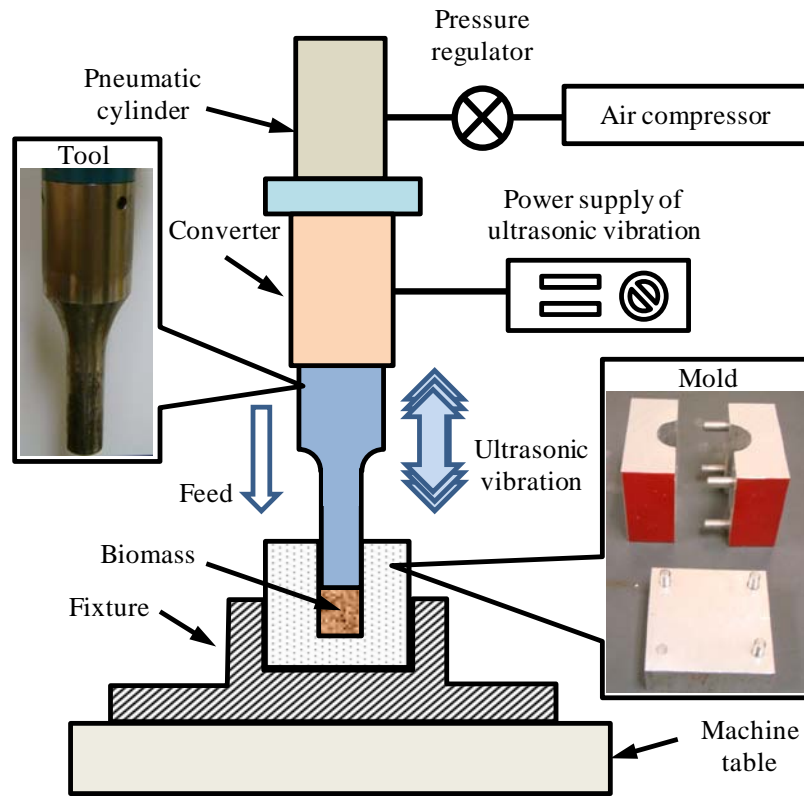

Important input parameters in UV-A pelleting and their values are shown in Table 8.1. Pelleting pressure was the air pressure in the pneumatic cylinder. It was controlled by a pressure regulator connected to an air compressor. A higher pelleting pressure represented a higher compression pressure applied on the wheat straw particles by the tool. Vibration frequency of the tool was 20 kHz (a fixed value on the UV-A pelleting machine used in this experiment). Ultrasonic power referred to the power provided to the ultrasonic converter by a power supply. It could be adjusted from 0 to 100 percent. It controlled the amplitude of the tool vibration. A larger ultrasonic power percentage produced a higher vibration amplitude. Pelleting time referred to the period of time during which the pelleting tool was compressing wheat straw particles inside the mold.

**Table 8.1 Input parameters and their values**

Input parameter	Unit	Value
Pelleting pressure	psi	40
Ultrasonic vibration frequency	kHz	20
Ultrasonic power	%	60
Pelleting time	sec	20

#### ***8.2.4 Water soaking***

After UV-A pelleting, the pellets were soaked in distilled water for one hour to separate them into individual particles. Water soaking could separate the pellets produced by UV-A pelleting into particles without using any mechanical forces. Using mechanical forces to separate pellets into particles might reduce particle size.

#### ***8.2.5 Air drying***

After the pellet was separated into individual particles, these particles were taken out from water and dried in the air. The drying time was controlled so that the moisture content of the dried particles reached 10% (the same as the moisture content before UV-A pelleting). In order to obtain the desired moisture content, moisture content of these particles was measured every two hours during drying until it reached 10%.

#### ***8.2.6 Measurement of particle size***

As shown in Figure 8.6, milled wheat straw particles had small thickness and large top surfaces. In this paper, particle size was referred to as the area of the top surface of a particle. Particles with larger top surface area were considered having larger sizes. Both size 1 and size 2



in Figure 8.2 were measured by two methods: using a microscope (model BX51, Olympus, Inc., Center Valley, PA, USA) and Image J (an image-processing program).

**Figure 8.6 Top surface and thickness of a wheat straw particle**

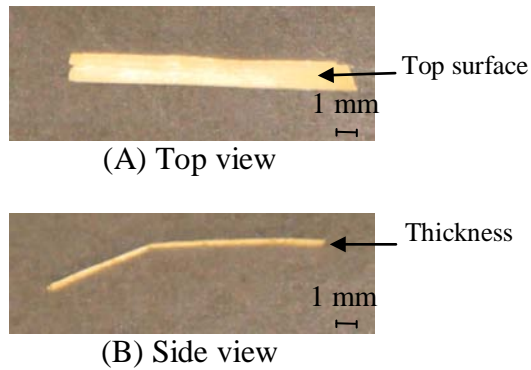

#### ***8.2.6.1 Measurement of particle size using a microscope***

The shape of manually-cut particles was remained after UV-A pelleting and water soaking. Figure 8.7 shows the shapes of a manually-cut particle at three different stages. The size of a particle was calculated by multiplying its length and width that were measured using a microscope. The length and width of a particle were measured at three different locations, as shown in Figure 8.8. Their average values were used to calculate particle sizes. This method can provide information on each of individual particles. But it is tedious and time consuming.

**Figure 8.7 Shapes of a manually-cut particle at three different stages**

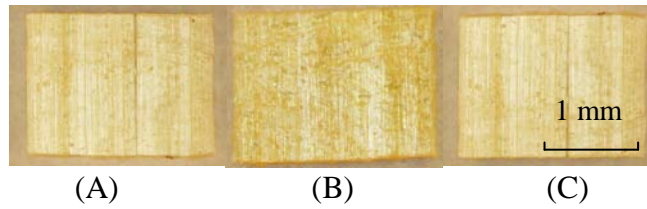

- (A) Before UV-A pelleting;
- (B) After UV-A pelleting;
- (C) After water soaking.

**Figure 8.8 Measurement of a particle's length and width using a microscope**

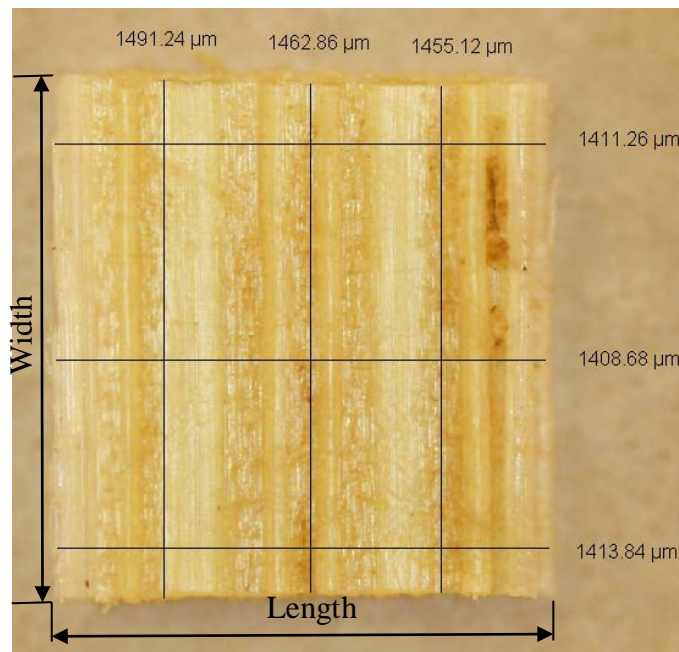

### **8.2.6.2 Measurement of particle size using Image J**

Using Image J could measure the size of many particles simultaneously thus increase measurement efficiency. This method was developed at the National Institutes of Health (NIH). Image J can process and analyze an image (e.g. a photograph) of the particles [32], as shown in

Figure 8.9. Based on the color contrast in the processed photograph, Image J could calculate the size of the particles in the photograph.

**Figure 8.9 A photograph used by Image J to measure particle size**

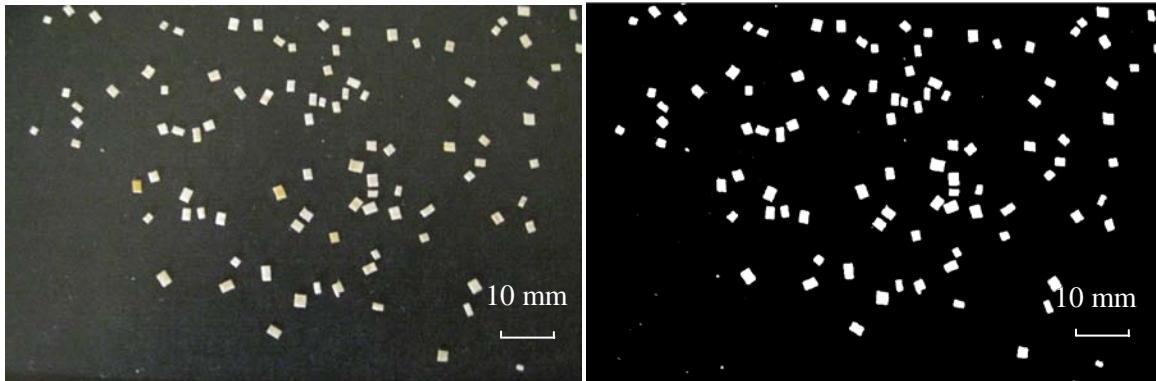

(A)

(B)

(A) Original photograph

(B) Processed by Image J

## 8.3 Experimental results

### *8.3.1 Effects of water soaking on particle size*

There are no reports in the current literature on effects of water soaking on the size of the soaked particles. In order to study the effects of UV-A pelleting on particle size, it is necessary to know the effects of water soaking on particle size, because water soaking is needed to separate pellets into individual particles.

The particle sizes before and after water soaking were compared using a paired T-test. The sample size of the T-test was determined based on a pilot water soaking test in which ten particles (which were collected from a pellet using tweezers) were soaked and their sizes before and after water soaking were measured. The measurement data of the pilot test were shown in Table 8.2. The difference between the mean values (before and after water soaking) was 0.01

mm<sup>2</sup>. The standard deviations of the measured particle size were 0.01 mm<sup>2</sup>. Sample size was calculated to be 20 by using operating characteristic curves with the power of the test being 0.8 [33]. It meant that the probability of type II error (failed to detect the difference between the particles sizes before and after water soaking while they were indeed different) in the T-test would be 20% when 20 sample particles were measured and compared in the paired T-test. A smaller sample size would cause a larger type II error.

**Table 8.2 Measurement data of the pilot test**

Particle #	Particle size Before soaking (mm <sup>2</sup> )	Particle size After soaking (mm <sup>2</sup> )
1	2.97	2.97
2	2.96	2.97
3	2.94	2.95
4	2.95	2.99
5	2.96	2.98
6	2.95	2.97
7	2.96	2.96
8	2.97	2.96
9	2.98	2.99
10	2.95	2.96
Mean	2.96	2.97
Standard deviation	0.01	0.01

The 20 sample particles that were used to evaluate effects of water soaking on particle size were collected from a pellet using tweezers. The pellet was produced using the conditions described in Table 8.1. The moisture content of the particles before and after water soaking was adjusted to 10%. The particle sizes before and after water soaking were measured using a microscope. The measurement data were shown in Table 8.3. The obtained P value of the paired T-test was 0.19. It indicated that the particle sizes before and after water soaking were not significantly different at any significance level lower than 0.19 ( $\alpha < 0.19$ ).

**Table 8.3 Paired T-test results on particle size before and after soaking**

Particle #	Particle size	
	Before soaking (mm <sup>2</sup> )	After soaking (mm <sup>2</sup> )
1	2.97	2.97
2	2.89	2.93
3	2.94	2.95
4	2.95	2.93
5	2.96	2.98
6	2.91	2.93
7	3.06	3.06
8	2.97	2.96
9	2.98	2.96
10	3.05	3.06
11	2.97	2.97
12	2.89	2.91
13	2.92	2.93
14	2.97	3.01
15	2.96	2.98
16	2.89	2.91
17	3.06	3.06
18	2.98	2.97
19	3.07	3.03
20	3.05	3.06
P value	0.19	

### ***8.3.2 Effects of UV-A pelleting on particle size***

The particle sizes before and after UV-A pelleting were compared using a two-sample T-test. The sample size of the T-test was determined based on a pilot UV-A pelleting test in which one gram of manually-cut particles was pelleted and the pellet was separated into particles by water soaking. Before and after UV-A pelleting, ten particles were randomly collected respectively and their sizes were measured. The measurement data were shown in Table 8.4. The difference between the mean values of particle size (before and after UV-A pelleting) was 0.01 mm<sup>2</sup>. The standard deviations of the measured particle size were 0.07 mm<sup>2</sup>. Sample size was calculated to be 600 by using operating characteristic curves with the power of the test being 0.8.

It meant that the probability of type II error (failed to detect the difference between particles sizes before and after UV-A pelleting while they were indeed different) in the T-test would be 20% when 600 sample particles were measured in the T-test. Since 10 pellets were produced, 60 sample particles were collected randomly from each pellet.

**Table 8.4 Measurement data of the pilot UV-A pelleting test**

Particle #	Particle size Before pelleting (mm <sup>2</sup> )	Particle size After pelleting (mm <sup>2</sup> )
1	4.26	4.21
2	4.33	4.31
3	4.17	4.21
4	4.31	4.26
5	4.15	4.19
6	4.19	4.23
7	4.29	4.21
8	4.27	4.24
9	4.22	4.27
10	4.33	4.29
Mean	4.25	4.24
Standard deviation	0.07	0.04

Tables 8.5 and 8.6 show the average particle sizes of all 60 particles in the 10 pellets measured using a microscope and Image J respectively. A two-sample T-test was performed to compare the particle sizes before and after UV-A pelleting. The obtained P values were 0.77 and 0.78 for the data measured by the two methods. It indicated that the particle sizes before and after UV-A pelleting were not significantly different at any significance level lower than 0.77 ( $\alpha < 0.77$ ). With the power of the test being 0.8, it was concluded that particle sizes before and after UV-A pelleting were not significantly different. UV-A pelleting had no significant effects on particle size.

**Table 8.5 Particle size measured using a microscope**

Pellet #	Before UV-A pelleting	After UV-A pelleting
	Particle size (average) (mm)	Particle size (average) (mm)
1	4.25	4.31
2	4.36	4.32
3	4.42	4.38
4	4.23	4.21
5	4.13	4.19
6	4.11	4.21
7	4.16	4.15
8	4.15	4.15
9	4.29	4.28
10	4.23	4.25
P value		0.77

**Table 8.6 Particle size measured using Image J**

Pellet #	Before UV-A pelleting	After UV-A pelleting
	Particle size (average) (mm)	Particle size (average) (mm)
1	4.24	4.19
2	4.32	4.32
3	4.38	4.36
4	4.27	4.26
5	4.15	4.19
6	4.19	4.23
7	4.26	4.19
8	4.24	4.21
9	4.21	4.27
10	4.32	4.28
P value		0.78

### 8.3.3 Comparison of two measurement methods

The current literature contains no reports of using Image J to measure the particle size of cellulosic biomass. In this paper, the measurement data from Image J were compared to those measured by the microscope method to evaluate the validity of using Image J to measure particle size of cellulosic biomass.

The measurement data of particle size obtained by the two methods (data in Tables 8.5 and 8.6) were combined in Table 8.7. Two-sample T-tests were used to compare the data from the two methods. The results of the T-tests indicated that the measurement data of the two methods had no significant difference at any significance level lower than 0.53 ( $\alpha < 0.53$ ). In addition, the power of the test was calculated to be 0.86 based on operating characteristic curves with the sample size being 600. It indicated that the measurement data obtained from Image J were not significantly different from those from the microscope method. It was concluded that Image J could be used to measure particle size of cellulosic biomass.

**Table 8.7 Comparison of the two measurement methods**

Pellet No.	Before UV-A pelleting		After UV-A pelleting	
	Method 1	Method 2	Method 1	Method 2
1	4.25	4.24	4.31	4.19
2	4.36	4.32	4.32	4.32
3	4.42	4.38	4.38	4.36
4	4.23	4.27	4.21	4.26
5	4.13	4.15	4.19	4.19
6	4.11	4.19	4.21	4.23
7	4.16	4.26	4.15	4.19
8	4.15	4.24	4.15	4.21
9	4.29	4.21	4.28	4.27
10	4.23	4.32	4.25	4.28
P value	0.53		0.87	



## 8.4 Conclusions

This paper reports an experimental investigation on effects of ultrasonic vibration-assisted (UV-A) pelleting on cellulosic biomass particle size. Particle sizes before and after UV-A pelleting are measured and compared by two methods: using a microscope and using Image J (an image-processing program). The following conclusions can be drawn:

- (1) Using water soaking to separate pellets into individual particles did not have significant effects on the size of the soaked particles (at the significance level of  $\alpha < 0.19$  with the power of the test being 0.8).
- (2) Particle sizes before and after UV-A pelleting are not significantly different. In other words, UV-A pelleting has no effects on particle size. Therefore, the proposed hypothesis that UV-A pelleting increases sugar yield by reducing particle size is rejected.
- (3) The measurement data of particle size obtained by using a microscope or Image J are not significantly different. Therefore, Image J can be used to measure the particle size of cellulosic biomass.

## Acknowledgements

This study is partly supported by NSF award CMMI-0970112. The authors gratefully extend their acknowledgements to Graham Pritchett and Eric Zinke (undergraduate students) at Kansas State University for their help in preparing manually-cut particles, and Mr. Clyde Treadwell at Sonic Mill for providing the ultrasonic pelleting equipment.

## References

- [1] Energy Information Administration, "U.S. energy consumption by sector of 1949-2009," 2009, retrieved from: <http://www.eia.doe.gov/emeu/aer/pdf/pages/sec2.pdf>.
- [2] Energy Information Administration, "Petroleum products supplied by type of 1949-2009," 2009, retrieved from: <http://www.eia.doe.gov/emeu/aer/txt/ptb0511.html>.
- [3] Energy Information Administration, "Short-term energy outlook," 2011, retrieved from: [http://www.eia.doe.gov/emeu/steo/pub/steo\\_full.pdf](http://www.eia.doe.gov/emeu/steo/pub/steo_full.pdf).
- [4] Fairfax Media, "U.S. pumps more money into cellulosic ethanol research," 2008, retrieved from: <http://sl.farmonline.com.au/news/nationalrural/agribusiness-and-general/us-pumps-more-money-into-cellulosic-ethanol-research/1234385.aspx>.
- [5] DOE, "Breaking the biological barriers to cellulosic ethanol: a joint research agenda," 2009, retrieved from: <http://genomicsgtl.energy.gov/biofuels/b2bworkshop.shtml>.
- [6] G.W. Bush, "2007 State of the Union Address," 2007, retrieved from: <http://www.washingtonpost.com/wpdyn/content/article/2007/01/23/AR2007012301075.html>.
- [7] Energy Information Administration, "Annual Energy Review 2009," 2010, retrieved from: <http://www.eia.doe.gov/aer/pdf/aer.pdf>.
- [8] Energy Information Administration, "Annual Energy Outlook 2011," 2010, retrieved from: [http://www.eia.gov/neic/speeches/newell\\_12162010.pdf](http://www.eia.gov/neic/speeches/newell_12162010.pdf).
- [9] J. Decker, "Going against the grain: ethanol from lignocellulosics," 2009, retrieved from: <http://www.renewableenergyworld.com/rea/news/article/2009/01/goingagainst-the-grain-ethanol-from-lignocellulosics-54346>.
- [10] J. Moresco, "U.S. biofuel output to miss mandates," 2008, retrieved from: <http://www.redherring.com/Home/25682>.

- [11] E. M. Rubin, "Genomics of cellulosic biofuels," *Nature*, Vol. 454, No. 7206, pp. 841-845, 2008.
- [12] K. Fehrenbacher, "11 Companies Racing to Build U.S. Cellulosic Ethanol Plants," 2008, retrieved from: <http://gigaom.com/cleantech/12-companies-racing-to-build-cellulosic-ethanol-plants-in-the-us/>.
- [13] G.W. Huber, "Breaking the Chemical and Engineering Barriers to Lignocellulosic Biofuels: Next Generation Hydrocarbon Biorefineries," 2008, retrieved from: <http://www.ecs.umass.edu/biofuels/Images/Roadmap2-08.pdf>.
- [14] A. Waves, "Ethanol Faces Challenges Ahead," 2009, retrieved from: <http://naturalresourcereport.com/2009/08/ethanol-faces-challenges-ahead/>.
- [15] J. Kho, "Fuel From Utility Poles: Cellulosic Ethanol Heats Up in Cool Economy," 2009, retrieved from: <http://cleantechnica.com/2009/01/19/fuel-from-utility-poles-cellulosic-ethanol-heats-up-in-cool-economy/>.
- [16] B. Yang, and E. Wyman, "Pretreatment: The Key to Unlocking Low-Cost Cellulosic Ethanol," *Biofuels, Bioproducts, and Biorefining*, Vol. 2, No. 1, pp. 26-40, 2008.
- [17] A. Aden, M. Ruth, K. Ibsen, J. Jechura, K. Neeves, J. Sheehan, B. Wallace, L. Montague, A. Slayton, and J. Lukas, "Lignocellulosic biomass to ethanol process design and economics utilizing co-current dilute acid prehydrolysis and enzymatic hydrolysis for corn stover," NREL Technical paper, TP-510-32438, 2002.
- [18] R. Wooley, M. Ruth, J. Sheehan, K. Ibsen, H. Majdeski, and A. Galvez, "Lignocellulosic biomass to ethanol process design and economics utilizing co-current dilute acid prehydrolysis and enzymatic hydrolysis current and futuristic scenarios," NREL Technical Paper, TP-580-26157, 1999.

- [19] S. Mani, L.G. Tabil, and S. Sokhansanj, "An overview of compaction of biomass grinds," *Powder Handling and Processing*, Vol. 15, No. 3, pp. 160-168, 2003.
- [20] S. Sokhansanj, S. Mani, and P. Zaini, "Binderless pelletization of biomass," ASABE Technical Paper, 056061, American Society of Agricultural and Biological Engineers, St. Joseph, MI, 2005.
- [21] Z.J. Pei, D.H. Wang, and R. Clark, "Ultrasonic vibration-assisted pelleting of cellulosic biomass: A preliminary experiment," *Proceedings of the 2009 International Manufacturing Science and Engineering Conference*, West Lafayette, IN, US, October 4-7, 2009.
- [22] W.L. Cong, P.F. Zhang, N. Qin, M. Zhang, X.X. Song, Q. Zhang, D. Nottingham, R. Clark, T. Deines, Z.J. Pei, and D.H. Wang, "Ultrasonic Vibration-Assisted Pelleting of Cellulosic Biomass for Biofuel Manufacturing," Poster presentation at the 2009 International Manufacturing Science and Engineering Conference, West Lafayette, IN, US, October 4-7, 2009.
- [23] Q. Zhang, P.F. Zhang, T. Deines, Z.J. Pei, D.H. Wang, X.R. Wu, and G. Pritchett, "Ultrasonic vibration assisted pelleting of sorghum: effects of pressure and ultrasonic power level," *CD-ROM Proceedings of the 2010 International Manufacturing Science and Engineering Conference (MSEC)*, Erie, PA, October 12-15, 2010.
- [24] P.F. Zhang, Z.J. Pei, D.H. Wang, X.R. Wu, W.L. Cong, M. Zhang, and T. Deines, "Ultrasonic vibration-assisted pelleting of cellulosic biomass for biofuel manufacturing," *Journal of Manufacturing Science and Engineering*, Vol. 133, No. 1, 2011.
- [25] D.F. Coulfield, and W.E. Moore, "Effect of varying crystallinity of cellulose on enzymatic hydrolysis," *Wood Science*, Vol. 6, pp. 375-377, 1974.

- [26] M. Pedersen, and A.S. Meyer, "Influence of substrate particle size and wet oxidation on physical surface structures and enzymatic hydrolysis of wheat straw," *AIChE*, Vol. 25, No. 2, pp. 399-408, 2009.
- [27] D.K. Sidiras, and E.G. Koukios, "Acid saccharification of ball-milled straw," *Biomass*, Vol. 19, No. 4, pp. 289-306, 1989.
- [28] A.I. Yeh, Y.C. Huang, and S.H. Chen, "Effect of particle size on the rate of enzymatic hydrolysis of cellulose," *Carbohydrate Polymers*, Vol. 79, No. 1, pp. 192-199, 2010.
- [29] K. Sanseethong, L. Meunier, U. Tantasucharit, E. Liaw, and M.H. Penner, "Rationale for particle size effect on rates of enzymatic saccharification of microcrystalline cellulose," *Journal of Food Biochemistry*, Vol. 22, pp. 321-330, 1998.
- [30] M. Zeng, N.S. Mosier, C.P. Huang, D.M. Sherman, and M.R. Ladisch, "Microscopic examination of changes of plant cell structure in corn stover due to hot water pretreatment and enzymatic hydrolysis," *Biotechnology and Bioengineering*, Vol. 97, pp. 265-278, 2007.
- [31] ASABE Standard S358.2, "Moisture Measurement—Forages," American Society of Agricultural and Biological Engineers, St. Joseph, US, 2002.
- [32] M.D. Abramoff, P.J. Magelhaes, and S.J. Ram, "Image processing with Image J". *Biophotonics International*, Vol. 11, No. 7, pp. 36-42, 2004.
- [33] D.C. Montgomery, 2001, *Design and Analysis of Experiments* (5th edition), John Wiley & Sons, New York.

## **Chapter 9 - Mechanism of UV-A pelleting to enhance sugar yield – microscopic examination on biomass surface morphology**

This chapter presents a microscopic examination of the changes on surface morphology of cellulosic biomass caused by UV-A pelleting and diluted acid pretreatment. Surface morphologies of biomass processed and not processed by UV-A pelleting are observed and compared using a scanning electron microscope (SEM). Significant differences in the surface morphologies between biomass processed by UV-A pelleting and biomass not processed by UV-A pelleting are revealed after they go through acid pretreatment. The content of this chapter will be submitted to Journal of Manufacturing Science and Engineering.

### Paper title:

Microscopic examination of changes on surface morphology of cellulosic biomass due to UV-A pelleting and diluted acid pretreatment

### To be submitted to:

Journal of Manufacturing Science and Engineering

### Authors' names:

P.F. Zhang<sup>1</sup>, K.Q. Fan<sup>1,2</sup>, Q. Zhang<sup>1</sup>, G. Singh<sup>3</sup>, Z.J. Pei<sup>1</sup>

### Authors' Affiliations:

1. Department of Industrial and Manufacturing Systems Engineering, Kansas State University, 2037 Durland Hall, Manhattan, KS 66506, USA

2. School of Electronical and Mechanical Engineering, Xidian University, P.O. Box 181, Xi'an, Shaanxi 710071, China

3. Department of Mechanical and Nuclear Engineering, Kansas State University, 3002 Rathbone Hall, Manhattan, KS 66506, USA

### **Abstract**

In cellulosic ethanol manufacturing, cellulose is converted into fermentable sugars that are converted into ethanol by fermentation. Ethanol yield is approximately proportional to sugar yield. It is found that the sugar yield of cellulosic biomass treated by ultrasonic vibration-assisted (UV-A) pelleting is higher than that of untreated biomass. However, the mechanisms of UV-A pelleting to increase biomass sugar yield are unknown. This paper reports an investigation on such mechanisms. Surface morphologies of biomass processed and not processed by UV-A pelleting are observed and compared using a scanning electron microscope (SEM). It is found that UV-A pelleting does not noticeably change the biomass surface morphology. However, significant differences in the surface morphologies between biomass processed by UV-A pelleting and biomass not processed by UV-A pelleting are revealed after they go through acid pretreatment. Severe disruption is observed on the surface of biomass processed by UV-A pelleting. Internal cellulose structures are also exposed by UV-A pelleting. For biomass surface not processed by UV-A pelleting, only small cracks are observed without internal cellulose structures.

## 9.1 Introduction

Rising petroleum price and concerns about the nation's energy security necessitate finding alternatives to petroleum-based liquid transportation fuels. Biofuels can be used as liquid transportation fuels. Ethanol (which has been used as additive to gasoline) is the most widely used biofuel [Demirbas, 2005]. Ethanol can be used readily in current-generation vehicles and distributed through the existing infrastructure without (or with slight) modifications [DOE, 2006]. In 2010, about 14.7 billion gallons of ethanol was produced in the U.S. [EIA, 2011]. The U.S. government has called for increasing the ethanol production to levels that would replace about 30% of the annual petroleum consumption (or roughly 90 billion gallons) by 2030 [DOE, 2003; Sokhansanj et al., 2006].

Cellulosic biomass (fibrous, woody, and generally inedible portions of plant matter) has been regarded as important feedstock for ethanol production due to environmental, social, and other benefits [DOE, 2006; Decker, 2009]. Major steps in cellulosic ethanol manufacturing are shown in Figure 9.1. There are three major steps to convert biomass to ethanol. The purpose of pretreatment is to increase the accessibility of cellulose to enzymatic hydrolysis. Hydrolysis breaks down cellulose into its component sugars. Fermentation converts sugars to ethanol. Ethanol yield in fermentation is approximately proportional to sugar yield in hydrolysis.

Ultrasonic vibration-assisted (UV-A) pelleting was first described in the literature by Pei et al. [Pei et al., 2009]. UV-A pelleting can produce pellets whose density is comparable to those produced by other pelleting methods [Zhang et al., 2010; Zhang et al., 2011]. It is also found that biomass (switchgrass) treated by UV-A pelleting could generate 23% higher sugar yield than untreated biomass powders [Zhang et al., 2011]. However, the mechanisms of UV-A pelleting to increase sugar yield are unknown. This paper reports an investigation on such mechanisms.



Surface morphologies of biomass processed and not processed by UV-A pelleting are observed and compared.

**Figure 9.1 Major steps in cellulosic ethanol manufacturing (after [Rubin, 2008])**

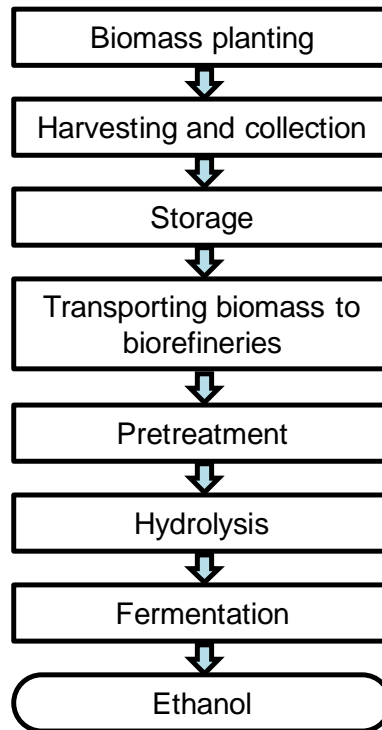

## 9.2 Literature review on effects of surface morphology on sugar yield

Zeng et al. [2007] compared the surface morphologies of corn stover before and after hot water pretreatment after which sugar yield of corn stover increased significantly. They found that hot water pretreatment broke the cell wall of corn stover and disrupted the cell structure. Wang et al. [2008] investigated the morphological structure of microcrystalline cellulose (MCC) before and after ultrasonic treatment. Many concave pits and cracks were observed on the surface of treated MCC while none of them was observed on the surface of untreated MCC. The pits and cracks were believed to increase the accessibility of cellulose and lead to higher sugar yield.

### **9.3 Experimental procedures and conditions**

The experimental procedure is presented in Figure 9.2. The biomass material used in this paper was wheat straw which was harvested from northwestern Kansas and stored indoors before use. Hammer milling was used for size reduction of wheat straw to powders. The straw powders were separated into two groups. One group was compressed to pellets by UV-A pelleting and the other group was not. The surface morphology of untreated powders (SM<sub>1</sub>) and pellets (SM<sub>2</sub>) was observed by using a scanning electron microscope (SEM). SM<sub>1</sub> was compared with SM<sub>2</sub> to test whether or not UV-A pelleting would change the surface morphology of wheat straw. Then both powders and pellets went through acid pretreatment. The surface morphology of pretreated powders (SM<sub>3</sub>) and pellets (SM<sub>4</sub>) were compared again to test whether or not UV-A pelleting had effects on the surface morphology of wheat straw after pretreatment.

#### ***9.3.1 Size reduction of wheat straw to powder using hammer milling***

In this study, a hammer mill (model 35, Meadows Mills, Inc., North Wilkesboro, NC, USA) was used to produce wheat straw powders. A sieve with a 2 mm screen size was put in the hammer mill to control particle size. The hammer mill had a steel drum containing a horizontal rotating shaft on which panels were welded, as shown in Figure 9.3. The hammers were mounted on panels using a pin and were free to swing on the ends of the panels. The size of wheat straw was reduced by hammers hitting biomass. The particles fell through the sieve if they were small enough. Large particles were hit more by hammers until they could fall through the sieve.

#### ***9.3.2 UV-A pelleting***

The experimental setup of UV-A pelleting is schematically illustrated in Figure 9.4. A mold was fixed on a machine table using a fixture. The mold was made in three separate parts

which were assembled together with pins. The top two parts formed a hollow cylindrical chamber and the bottom part served as a base. A certain amount of biomass (which was referred to as pellet weight) was loaded into the mold chamber.

**Figure 9.2 Experimental procedure**

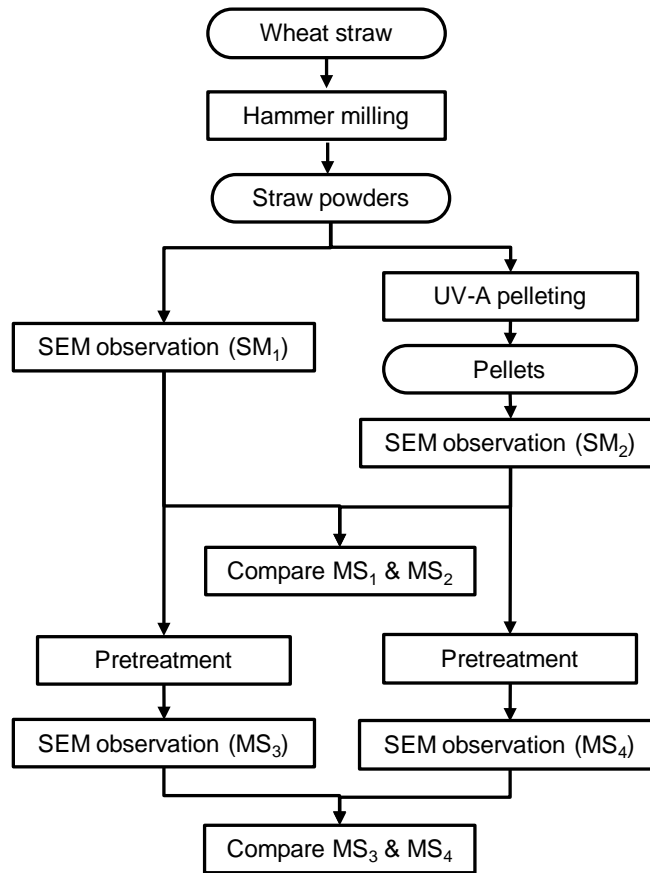

A tool with a solid cylinder tip was used to compress biomass. The diameter of the tool tip was 17.4 mm, slightly smaller than that of the mold chamber (18.6 mm). The tool was connected to an ultrasonic converter that generated ultrasonic vibration and transferred the vibration to the tool. A power supply provided the power needed to generate the ultrasonic vibration and controlled the amplitude of the vibration. The frequency of the vibration was 20 kHz.

**Figure 9.3 Hammer milling**

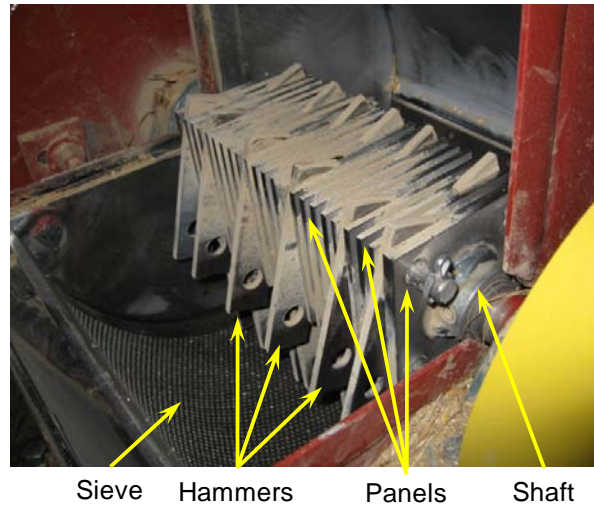

**Figure 9.4 Illustration of UV-A pelleting setup**

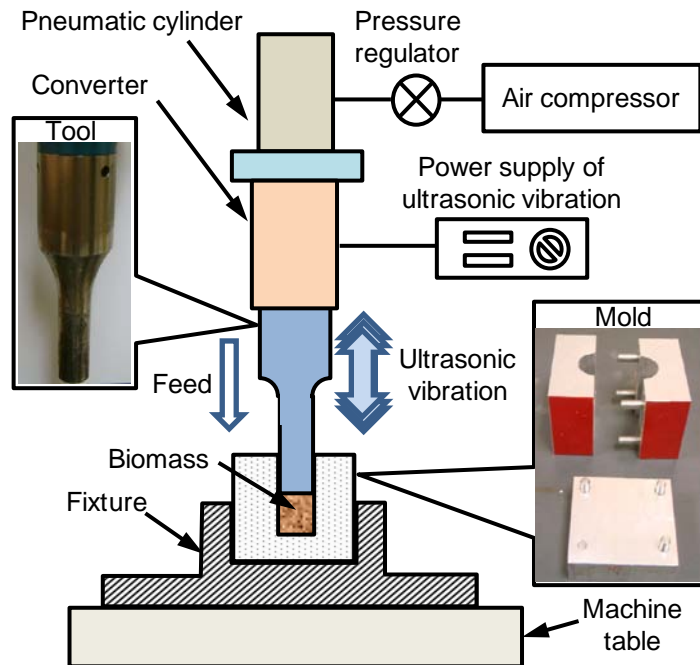

In UV-A pelleting, the tool was fed down with a constant pressure which was provided by an air compressor and controlled by a pressure regulator. In this study, the pressure applied on the top surface of wheat straw was referred to as pelleting pressure. When the tool moved down, the ultrasonic vibration was applied on it. The period of time when biomass was compressed was

referred to as pelleting time. When the predetermined pelleting time was over, the tool was retracted and the mold disassembled to unload the pellet.

### 9.3.3 Pretreatment

Pretreatment was carried out in a pressure reactor (Parr Instrument Company, Moline, IL, USA) with a 600 mL reaction vessel, as illustrated in Figure 9.5. Wheat straw samples (pellets or powders) were mixed with diluted sulfuric acid (1% w/v) in the vessel to obtain 3.3% solid content (approximately 10 grams wheat straw samples in 300 mL diluted sulfuric acid solution). The slurry was stirred by two impeller mixers and treated at a temperature of 140 °C for 30 minutes. Pretreated wheat straw was washed with hot distilled water and centrifuged four times to remove dissolved sugars and sulfuric acid. Washed wheat straw was dried in the air for 72 hours.

**Figure 9.5 Illustration of pretreatment reactor**

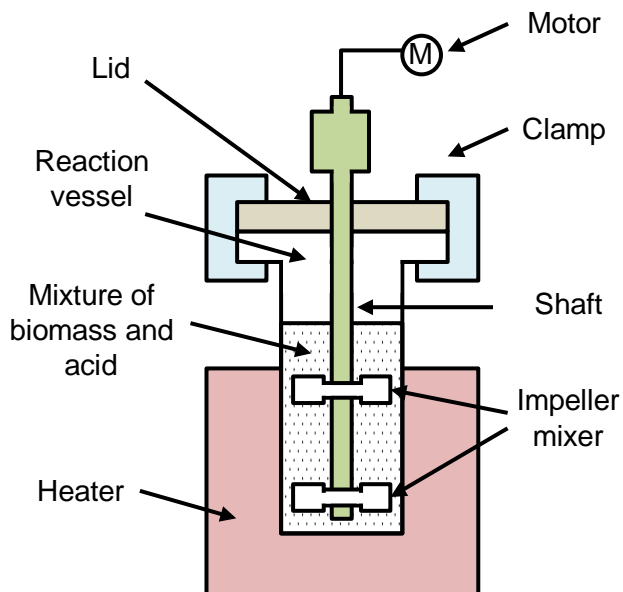

### 9.3.4 Scanning electron microscopic observation

To observe the surface morphology, dried wheat straw samples were observed by using an EVO MA10 SEM (Carl Zeiss Microscopy, Thornwood, NY, USA) operating at 5 kV.

## 9.4 Experimental results

Surface morphology of powders and pellets before pretreatment is shown in Figure 9.6. The untreated powders have naturally curved surfaces. The surfaces of wheat straw treated by UV-A pelleting are flat, which is caused by the pressure applied to the material during pelleting. Both surfaces look smooth and integrated. There is no obvious difference between the surfaces of the two types of materials, indicating that UV-A pelleting itself does not change the surface morphology of wheat straw as observed with SEM.

**Figure 9.6 SEM images of wheat straw before pretreatment**

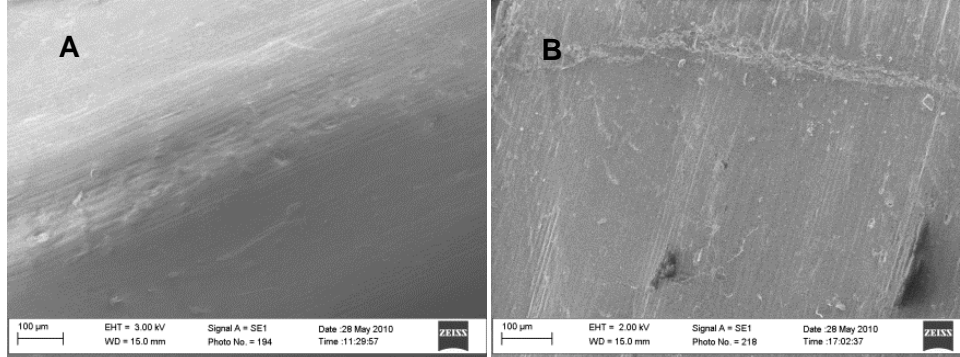

A: Untreated by UV-A pelleting;

B: Treated by UV-A pelleting.

Figure 9.7 shows the surface morphology of powders and pellets after pretreatment. There are some small cracks on the surface of pretreated wheat straw powders (Figure 9.7A). The cells on the surface can be recognized. For pellets after pretreatment, the surface is disrupted (Figure 9.7B), resulting in exposure of internal structure such as vascular bundles (Figure 9.7C,D,E,F). Vascular bundles have a spiral form (Figure 9.7F) or an annular ring form [Yu et al.,

2005; Corredor et al., 2009]. The major component of vascular bundles is cellulose [Yu et al., 2005]. The observation of vascular bundles indicates that UV-A pelleting, combined with pretreatment, would result in direct exposure of cellulose to enzymes and thus increase the accessibility of cellulose to enzymatic attack. However, such morphological feature is not observed in the samples without UV-A pelleting even though they are pretreated.

**Figure 9.7 SEM images of wheat straw after pretreatment**

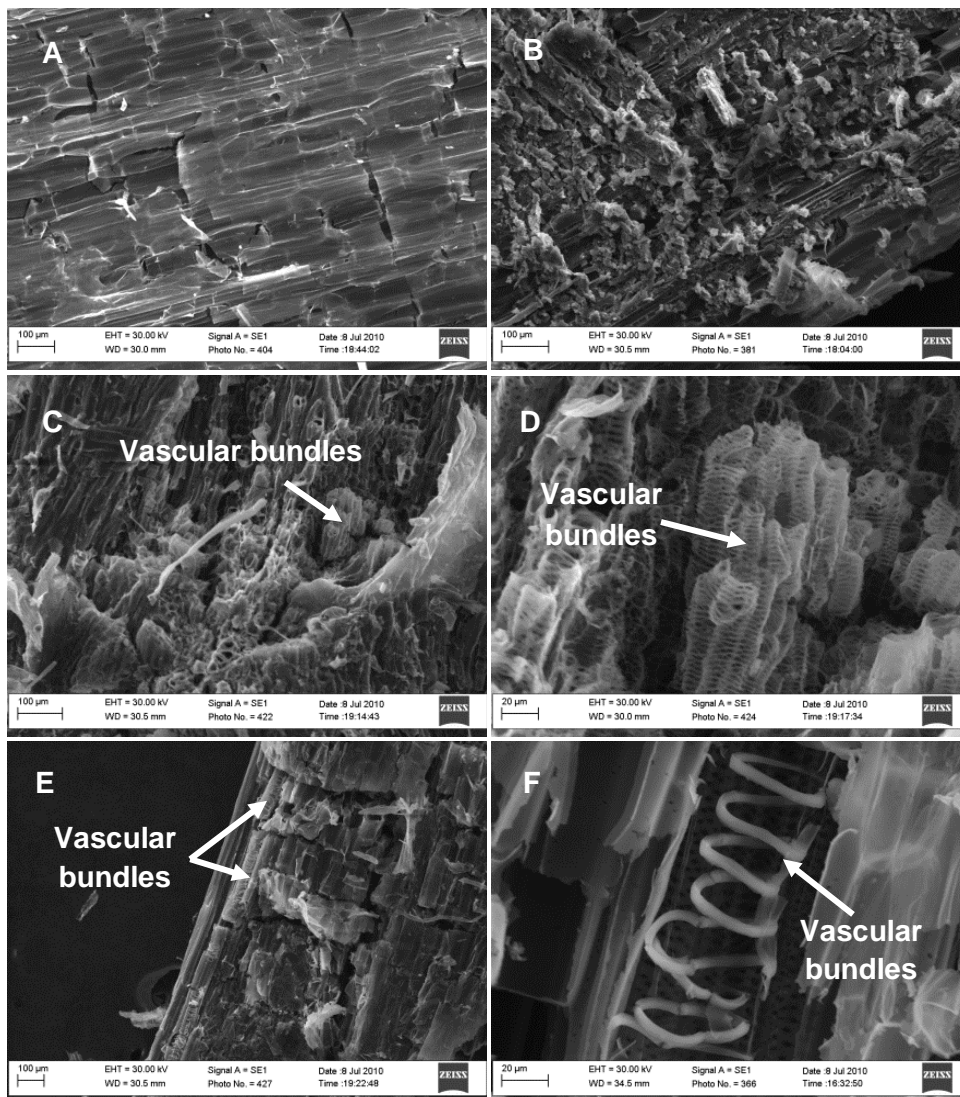

A: Untreated by UV-A pelleting;

B – F: Treated by UV-A pelleting.

## **9.5 Conclusions**

This paper reports an investigation on mechanisms of ultrasonic vibration-assisted (UV-A) pelleting of biomass to increase sugar yield in cellulosic ethanol manufacturing. The surface morphology of UV-A pelleting treated and untreated wheat straw are investigated and compared. It is found that UV-A pelleting does not noticeably change the biomass surface morphology. However, significant differences in the surface morphologies between biomass processed by UV-A pelleting and biomass not processed by UV-A pelleting are revealed after they go through acid pretreatment. Severe disruption is observed on the surface of biomass processed by UV-A pelleting. Internal cellulose structures are also exposed by UV-A pelleting. For biomass surface not processed by UV-A pelleting, only small cracks are observed without internal cellulose structures.

## **Acknowledgements**

This study is supported by NSF award CMMI-0970112. The authors gratefully extend their acknowledgements to Mr. Clyde Treadwell at Sonic Mill for providing the UV-A pelleting unit.

## **References**

- Corredor, D.Y., Salazar, J.M., Hohn, K.L., Bean, S., Bean, B., and Wang, D., 2009, "Evaluation and characterization of forage sorghum as feedstock for fermentable sugar production," *Applied Biochemistry and Biotechnology*, 158 (1), pp. 164-179.
- Decker, J., 2009, Going against the grain: ethanol from lignocellulosics, *Renewable Energy World*, <http://www.renewableenergyworld.com/rea/news/article/2009/01/going-against-the-grain-ethanol-from-lignocellulosics-54346>.



- Demirbas, A., 2005, "Bioethanol from cellulosic materials: a renewable motor fuel from biomass," *Energy Source*, 27, pp. 327-337.
- U.S. Department of Energy, 2003, Roadmap for agriculture biomass feedstock supply in the United States, <http://www.inl.gov/technicalpublications/Documents/3323197.pdf>.
- U.S. Department of Energy, 2006, Breaking the biological barriers to cellulosic ethanol: a joint research agenda, <http://genomicscience.energy.gov/biofuels/2005workshop/b2bhighres63006.pdf>.
- Energy Information Administration, Short-term energy outlook, July, 2011, [http://www.eia.gov/steo/steo\\_full.pdf](http://www.eia.gov/steo/steo_full.pdf).
- Pei, Z.J., Wang, D.H., and Clark, R., 2009, "Ultrasonic vibration assisted pelleting of cellulosic biomass: a preliminary experiment," Proceedings of the 2009 International Manufacturing Science and Engineering Conference, West Lafayette, IN, US, October 4-7, MSEC2009-84205.
- Rubin, E.M., 2008, "Genomics of cellulosic biofuels," *Nature*, 454, pp. 841-845.
- Sokhansanj, S., Turhollow, A., Tagore, S., and Mani, S., 2006, "Integrating biomass feedstock with an existing grain handling system for biofuels," ASABE Technical Paper No. 066189, American Society of Agricultural and Biological Engineers, St. Joseph, MI, USA.
- Wang, X.L., Fang, G.Z., Hu, C.P. and Du, T.C., 2008, "Application of ultrasonic waves in activation of microcrystalline cellulose," *Journal of Applied Polymer Science*, 109, pp. 2862-2767.
- Yu, H., Liu, R.G., Shen, D.W., Jiang, Y., and Huang, Y., 2005, "Study on morphology and orientation of cellulose in the vascular bundle of wheat straw," *Polymer*, 46, pp. 5689-

5694.

Zeng, M.J., Mosier, N.S., Huang, C.P., Sherman, D.M., and Ladisch, M.R., 2007, "Microscopic examination of changes of plant cell structure in corn stover due to hot water pretreatment and enzymatic hydrolysis," *Biotechnology and Bioengineering*, 97(2), pp. 265-278.

Zhang, P.F., Deines, T., Nottingham, D., Pei, Z.J., Wang, D.H., and Wu, X.R., "Ultrasonic vibration-assisted pelleting of biomass: a designed experimental investigation on pellet quality and sugar yield," *Proceedings of the 2010 International Manufacturing Science and Engineering Conference*, Erie, PA, US, October 12-15.

Zhang, P.F., Pei, Z.J., Wang, D.H., Wu, X.R., Cong, W.L., Zhang, M., and Deines, T., 2011, "Ultrasonic vibration-assisted pelleting of cellulosic biomass for biofuel manufacturing," *Journal of Manufacturing Science and Engineering*, 133(1), pp. 1087-1357.

## **Chapter 10 – Pellet density model in UV-A pelleting**

This chapter presents a mechanistic model to predict pellet density in UV-A pelleting. The predicted pellet densities are compared with experimental results. The content of this chapter will be submitted to Journal of Manufacturing Science and Engineering.

### Paper title:

Modeling of pellet density in ultrasonic vibration-assisted pelleting of cellulosic biomass

### To be submitted to:

Journal of Manufacturing Science and Engineering

### Authors' Names:

Pengfei Zhang<sup>1</sup>, Kangqi Fan<sup>1,2</sup>, Qi Zhang<sup>1</sup>, Z.J. Pei<sup>1</sup>, Donghai Wang<sup>3</sup>

### Authors' Affiliations:

1. Department of Industrial and Manufacturing Systems Engineering, Kansas State University, 2037 Durland Hall, Manhattan, KS 66506, USA

2. School of Electronical and Mechanical Engineering, Xidian University, P.O. Box 181, Xi'an, Shaanxi 710071, China

3. Department of Biological and Agricultural Engineering, Kansas State University, 150 Seaton Hall, Manhattan, KS 66506, USA

## **Abstract**

Ultrasonic vibration-assisted (UV-A) pelleting can increase cellulosic biomass density and reduce biomass handling and transportation costs in cellulosic ethanol manufacturing. Effects of input variables in UV-A pelleting on pellet density have been studied experimentally. However, there is no report on modeling of pellet density in UV-A pelleting. In the literature, most reported density models in pelleting of biomass are empirical. This paper presents a mechanistic model to predict pellet density in UV-A pelleting. The predicted data are compared with experimental results. There is good agreement between the model and experimental data.

## **10.1 Introduction**

### ***10.1.1 Manufacturing of cellulosic ethanol***

Rising petroleum price and concerns about the nation's energy security necessitate finding alternatives to petroleum-based liquid transportation fuels. One such alternative is ethanol which can be used readily by current-generation vehicles and distributed through the existing infrastructure without (or with slight) modifications [DOE, 2006]. Cellulosic biomass (fibrous, woody, and generally inedible portions of plant matter) has been regarded as an important feedstock for ethanol manufacturing due to environmental, social, and other benefits [DOE, 2006; Decker, 2009].

Major steps of cellulosic ethanol manufacturing are shown in Figure 10.1. It starts with biomass planting. A sequence of steps (harvesting and collection, storage, and transportation) is needed to turn biomass into feedstocks for biorefineries. Pretreatment, hydrolysis, and fermentation are the major steps for converting the feedstocks into ethanol.

**Figure 10.1 Major steps in cellulosic ethanol manufacturing (after [Rubin, 2008])**

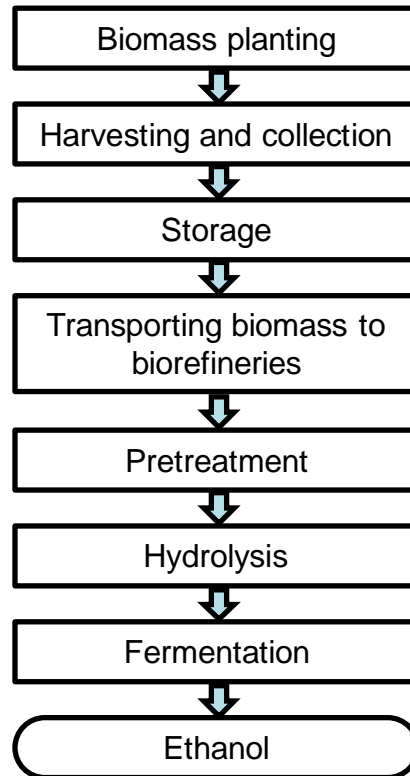

A DOE-sponsored study revealed several limitations to the commercial feasibility of cellulosic feedstocks for large-scale ethanol manufacturing [DOE, 2003]. One limitation is the high costs related to cellulosic feedstock production and logistics [DOE, 2006; Yang and Wyman, 2008], which can constitute 35% or more of the total production costs of cellulosic ethanol [Aden et al., 2002; Phillips et al., 2007]. Specifically, the logistics associated with handling low-density biomass and moving it from the land to biorefineries can make up more than 50% of the feedstock costs [Hess, 2007].

### ***10.1.2 Approaches of biomass pelleting***

Pelleting is generally described as “the agglomeration of small particles into larger particles by the means of a mechanical process, and in some applications, thermal processing”

[Falk, 1985]. Pelleting can increase the density of cellulosic biomass. Furthermore, pellets can be handled and transported with existing grain-handling equipment. As a result, efficiencies of biomass handling and transportation will be improved, resulting in a reduction in handling and transportation costs.

Biomass pelleting can be performed using different traditional processes (for example, using a screw extruder, a briquetting press, or a rolling machine) [Mani et al., 2003; Sokhansanj et al., 2005]. However, these processes generally involve high-temperature steam and high compressing pressure, and often use binder materials, making it difficult to realize cost-effective pelleting on or near the field where biomass is available.

Ultrasonic vibration-assisted (UV-A) pelleting does not use high-temperature steam and binder materials. Previous studies show that the pellet density of UV-A pelleting is comparable to that of traditional pelleting methods [Zhang et al., 2010; Zhang et al., 2011].

### ***10.1.3 Reported studies on pellet density in UV-A pelleting***

Effects of input variables (such as pelleting pressure, ultrasonic power, pellet weight, biomass particle size, and biomass moisture content) in UV-A pelleting on pellet density have been studied experimentally. Main effects of the input variables on pellet density were reported [Zhang et al., 2011]. Interaction effects of the input variables on pellet density were also reported [Zhang et al., 2010]. However, there is a lack of models on pellet density in UV-A pelleting.

### ***10.1.4 Density models for biomass pelleting***

Many empirical models on pellet density in traditional pelleting processes have been proposed, as summarized in Table 10.1. These models mainly describe the relations between pelleting pressure and pellet density. Other input variables are not involved in these models.

Although the empirical models can fit some experimental results well, they cannot explain the pelleting mechanisms. Furthermore, many empirical models do not fit the experimental result very well when the pelleting pressure is low, while low pelleting pressure is used in UV-A pelleting.

**Table 10.1 Models on pellet density of cellulosic biomass**

Model	Reference
$P = c_1(\rho^{c_2} - \rho_0^{c_3})$	Mewes, 1959
$P = c_4 \ln \rho^{c_5}$	O'Dogherty and Wheeler, 1984
$\frac{\rho_{max} - \rho}{\rho_{max} - \rho_0} = e^{(-P/K)}$	Bilanski et al., 1985
$\rho = \rho_0 + (c_6 + c_7 P)(1 - e^{-c_8 P})$	Ferrero et al., 1991
$P = c_9 + c_{10} \rho + c_{11} \rho^2$	Viswanathan and Gothandapani, 1999

where

$c_1, c_2 \dots c_{11}$  = model constants

P = applied pelleting pressure

$\rho$  = Density of compressed biomass

$\rho_0$  = Density of uncompressed biomass

$\rho_{max}$  = Maximum density of biomass

K = stiffness of biomass powders

Some researchers have proposed density models for biomass pelleting based on rheology theories where biomass is treated as a continuum material [Macosko, 1994]. Three types of deformation (elastic, plastic, and viscous) are denoted in rheological models as mechanical analogues such as spring, friction elements, and dashpot elements [Macosko, 1994]. The

compression behavior of biomass is simulated using combinations of spring, friction elements, and dashpot elements [Mohsenin, 1986; Macosko, 1994; Haddad, 1995]. However, a rheological model usually contains several unknown constants which are highly dependent on different materials. Therefore, many experiments are needed to determine the unknown constants.

### ***10.1.5 Outline of this paper***

In this paper, for the first time, a mechanistic model is proposed to predict pelleting density in UV-A pelleting. The objectives are to provide guidance to obtain the desired pellet density. This paper is organized into four sections. Following this introduction section, Section 10.2 develops the mechanistic model. Section 10.3 presents the experimental determination of a mechanistic parameter in the model. Section 10.4 discusses the experiments performed to verify the model. Conclusions are drawn up in Section 10.5.

## **10.2 Development of the mechanistic density model**

### ***10.2.1 Model assumptions***

Development of the mechanistic density model in this paper is based on the following assumptions:

- (1) Biomass uniformly fills the mold chamber;
- (2) The vertical pressure is uniform across any horizontal cross section;
- (3) The horizontal pressure is uniform across any horizontal cross section;
- (4) The frictional force per unit area between biomass and mold wall is given by the product of coefficient of friction and the horizontal pressure;
- (5) The coefficient of friction at any contacting point between biomass and mold is constant;



(6) In any horizontal layer of biomass, there is a linear relation between the vertical pressure and the horizontal pressure; and the ratio of the vertical pressure to the horizontal pressure in any horizontal layer of biomass is constant.

### ***10.2.2 Derivation of the model***

It has been observed that pellets will expand after removal of the pelleting pressure. The expansion will reduce pellet density. This phenomenon is not considered in this model. The model proposed in this paper aims to predict pellet density under certain pelleting pressure.

#### ***10.2.2.1 Density in pelleting without ultrasonic vibration (ultrasonic power = 0)***

Figure 10.2 shows the arrangement of mold, tool, and cellulosic biomass during pelleting. Let  $P_0$  be the external pressure applied vertically downwards by the tool at  $x = 0$ , the top of the pellet. In this study,  $P_0$  is also referred to as pelleting pressure. Let  $P_L$  be the resistant pressure applied vertically upwards by the mold at  $x = L$ , the bottom of the pellet. For the horizontal layer (with thickness of  $d_x$ ) at depth  $x$ , the vertical pressure on its top surface is referred to as  $P_x$  and on its bottom surface  $P_x + dP_x$ . The horizontal pressure in the layer is  $kP_x$ . Considering the equilibrium of the horizontal layer between the depths  $x$  and  $x + dx$ ,

$$P_x \cdot \pi r^2 + \rho g \cdot \pi r^2 \cdot dx = (P_x + dP_x) \cdot \pi r^2 + \mu \cdot 2\pi r \cdot dx \cdot kP_x \quad (1)$$

where,  $\rho$  is the pellet density,  $r$  is the radius of the mold chamber,  $\mu$  is the coefficient of friction between wheat straw and mold wall, and  $k$  is the ratio of vertical pressure to horizontal pressure. The reported  $\mu$  value in the literature varies from 0.2 to 0.4 [Ozerov, 1961; O'Dogherty, 1989], and  $k$  value varies from 0.35 to 0.5 [O'Dogherty, 1989]. In this study, the values of  $\mu$  and  $k$  are assumed to be 0.268 and 0.5 respectively. These values have also been used by other researchers [Faborode and O'Callaghan, 1986]. Equation (1) can be rearranged as:

$$\frac{dP_x}{dx} = \rho g - \frac{2\mu k}{r} \cdot P_x \quad (2)$$

The solution of this differential equation is:

$$P_x = \left( \int \rho g \cdot e^{\int \frac{2\mu k}{r} dx} \cdot dx + C \right) \cdot e^{-\int \frac{2\mu k}{r} dx} \quad (3)$$

where, C is a constant. Equation (3) can be transformed to:

$$P_x = \frac{\rho g r}{2\mu k} + C \cdot e^{-\frac{2\mu k}{r} x} \quad (4)$$

It is known that  $P_x = P_0$  at  $x = 0$ , and  $P_x = P_L$  at  $x = L$ . The following equations can be obtained:

$$\begin{cases} P_0 = \frac{\rho g r}{2\mu k} + C & (5) \\ P_L = \frac{\rho g r}{2\mu k} + C \cdot e^{-\frac{2\mu k}{r} L} & (6) \\ \rho = \frac{M}{L \cdot \pi r^2} & (7) \end{cases}$$

where, M is the weight of biomass loaded into the mold chamber. These three equations can be assembled into Equation (8):

$$P_L = \frac{\rho g r}{2\mu k} + \left( P_0 - \frac{\rho g r}{2\mu k} \right) \cdot e^{-\frac{2\mu k M}{\rho \pi r^3}} \quad (8)$$

The only unknown variable in Equation (8) is  $\rho$ , the density of compressed biomass. So  $\rho$  can be calculated.

**Figure 10.2 Sketch of the arrangement of mold, tool, and biomass with relevant forces**

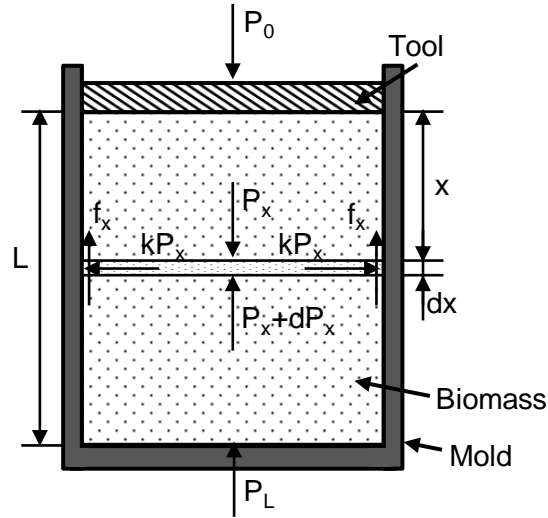

#### 10.2.2.2 Density in UV-A pelleting (ultrasonic power $\neq 0$ )

When ultrasonic vibration is applied on the tool, the pellet density can also be derived from Equation (1). However, values of  $\mu$  and  $k$  in Equation (1) for UV-A pelleting might be different from those for pelleting without ultrasonic vibration. In the literature, there are no results or data showing how ultrasonic vibration will affect the values of  $\mu$  and  $k$ . Since  $\mu$  and  $k$  always appear together as a product in Equations (1) and (8), a mechanistic parameter  $b$  is introduced to present the difference (if there is any) of the product in pelleting with and without applying ultrasonic vibration to the tool. And Equation (1) is changed to:

$$P_x \cdot \pi r^2 + \rho g \cdot \pi r^2 \cdot dx = (P_x + dP_x) \cdot \pi r^2 + b\mu \cdot 2\pi r \cdot dx \cdot kP_x \quad (9)$$

Accordingly, Equation (8) is changed to:

$$P_L = \frac{\rho g r}{2b\mu k} + \left(P_0 - \frac{\rho g r}{2b\mu k}\right) \cdot e^{-\frac{2b\mu k M}{\rho \pi r^3}} \quad (10)$$

In Equation (10), there are two unknown variables:  $\rho$  and  $b$ . In order to calculate  $\rho$ ,  $b$  needs to be determined experimentally.

## 10.3 Determination of mechanistic parameter b using experiments

### *10.3.1 Experimental setup and conditions*

The cellulosic biomass material used in this study was wheat straw which was harvested from northwestern Kansas and stored indoors before use. A hammer mill (model 35, Meadows Mills, Inc., North Wilkesboro, NC, USA) was used to produce straw powders using a 2 mm sieve. The moisture content of the straw powders was adjusted to 5% according to ASABE standard S358.2 [ASABE, 2002].

A Sonic-Mill ultrasonic machine (Sonic-Mill, Albuquerque, NM, USA) was used to perform UV-A pelleting. The setup of UV-A pelleting is illustrated in Figure 10.3. One gram of straw powders was put in a plastic tube. A compression spring (Lee Spring, Gilbert, AZ, USA) was put underneath the straw powders. A tool with a solid cylinder tip was used to compress biomass. The diameter of the tool tip was 17.4 mm, slightly smaller than that of the inner diameter of the tube (19 mm). The tool was connected to an ultrasonic converter that generated ultrasonic vibration and transferred the vibration to the tool. A power supply provided the power needed to generate the ultrasonic vibration. The ultrasonic power in this study was expressed as percentage numbers (from 0 to 100%). It controlled the amplitude of the tool vibration. Larger ultrasonic powers indicated higher amplitudes. The frequency of the vibration was 20 kHz.

In UV-A pelleting, the tool was fed down with a constant pressure which was provided by an air compressor and controlled by a pressure regulator. In the meanwhile of the tool moving down, the ultrasonic vibration was applied on it. Both wheat straw and the spring were compressed, and their heights kept decreasing until the tool could not move down any further. The heights of compressed straw pellet and spring were measured. Then the tool was retracted and the pellet was unloaded.

**Figure 10.3 Illustration of UV-A pelleting setup**

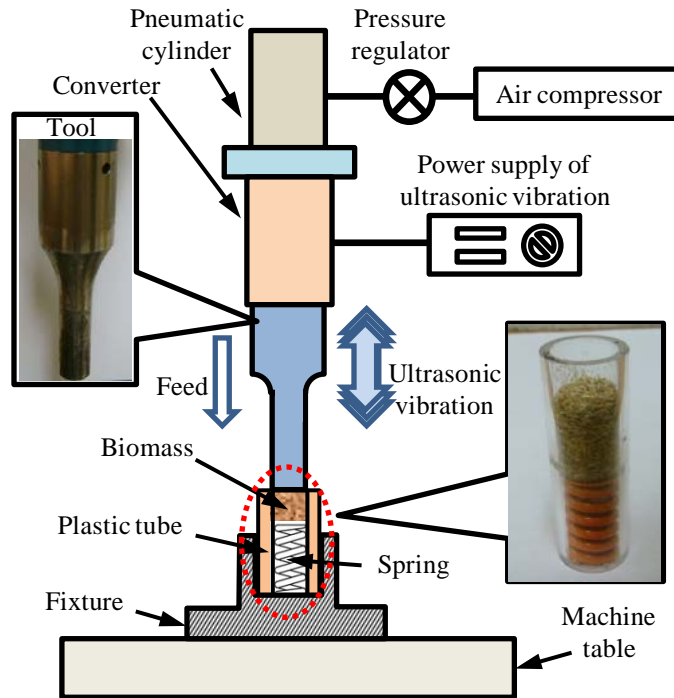

With known pellet height, pellet density ( $\rho$ ) could be calculated from Equation (7). With known heights of initial and compressed spring and the spring constant, the pressure at the bottom surface of pellet ( $P_L$ ) could be calculated based on Hooke's law. With known value of  $\rho$  and  $P_L$ , the value of the mechanistic parameter  $b$  can be calculated from Equation (10).

The  $b$  values for three levels of pelleting pressure (325, 650, and 975 psi) were determined. At each pressure level, the  $b$  values for three levels of ultrasonic power (20%, 30%, and 40%) were determined.

### ***10.3.2 Experimental results***

Experimental results on  $b$  value are presented in Table 10.2 and Figure 10.4. For each combination of pelleting pressure and ultrasonic power, three replicates were conducted to obtain the  $b$  value. The error bars in Figure 10.4 represent the standard deviation of  $b$  value. The  $b$

values at different levels of pelleting pressure are the same, indicating that pelleting pressure does not have significant effects on the b value. Ultrasonic power has significant effects on b value. As ultrasonic power increases, b value decreases.

**Table 10.2 Experimental results on b value**

Pelleting pressure (psi)	Ultrasonic power (%)	b value				
		b1	b2	b3	b4	average
325	20	0.91	0.82	0.84	0.81	0.85
	30	0.65	0.65	0.67	0.69	0.67
	40	0.47	0.42	0.42	0.45	0.44
650	20	0.88	0.84	0.82	0.82	0.84
	30	0.7	0.65	0.64	0.69	0.67
	40	0.44	0.48	0.41	0.43	0.44
975	20	0.81	0.81	0.84	0.86	0.83
	30	0.63	0.65	0.66	0.69	0.66
	40	0.42	0.45	0.43	0.44	0.44

**Figure 10.4 Experimental results on b value**

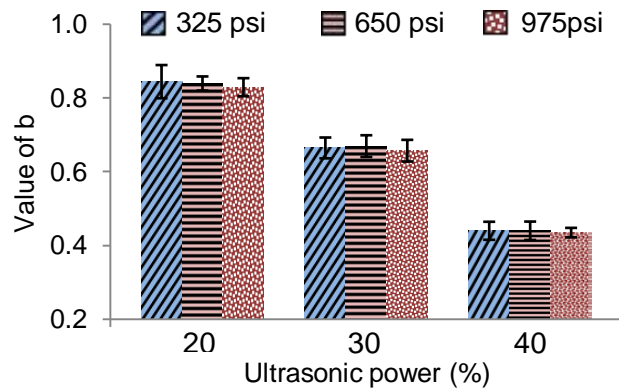
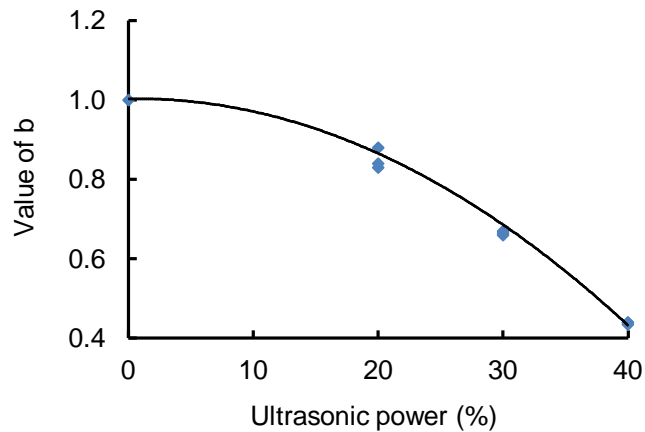

Figure 10.5 shows a plot of b values versus ultrasonic power. The b values in Figure 10.6 are the average value of experimental results at each level of pelleting pressure. The plot indicates a quadratic relation between b value and ultrasonic power:

$$b = a_0 + a_1 \cdot x + a_2 \cdot x^2 \quad (11)$$

where,  $a_0$ ,  $a_1$ , and  $a_2$  are constants,  $x$  represents the value of ultrasonic power (20, 30, and 40). Their values were estimated using regression function in Minitab (version 15). The estimates of  $a_0$ ,  $a_1$ , and  $a_2$  were found to be  $1$ ,  $5 \times 10^{-4}$ , and  $-4 \times 10^{-4}$  respectively.

**Figure 10.5 Relation between b value and ultrasonic power**



#### 10.4 Experimental verification

In this section, predicted pellet densities are compared with the experimental density results. All of the experimental density results were obtained from the same batch of wheat straw and the same setup (with the same UV-A pelleting machine, plastic tube, and spring) as those used to determine the value of parameter  $b$  in Section 10.3.

Figure 10.6 shows the comparison of pellet densities between model predictions and experiments when ultrasonic vibration is not applied on the tool (ultrasonic power = 0). The data are shown in Table 10.3. The solid line represents the values of predicted density. The

experimental results are plotted as dots. It can be seen that the predictions fit the experimental results very well when pelleting pressure is 975 psi. The difference between predictions and experimental results is about 3%. When pelleting pressure is 650 psi, the predictions still fit the experimental results well. The difference between predictions and experimental results is about 4%. When pelleting pressure is 325 psi, the difference between predictions and experimental results is about 6%.

**Figure 10.6 Comparison of pellet densities between prediction and experiments without ultrasonic vibration applied on the tool**

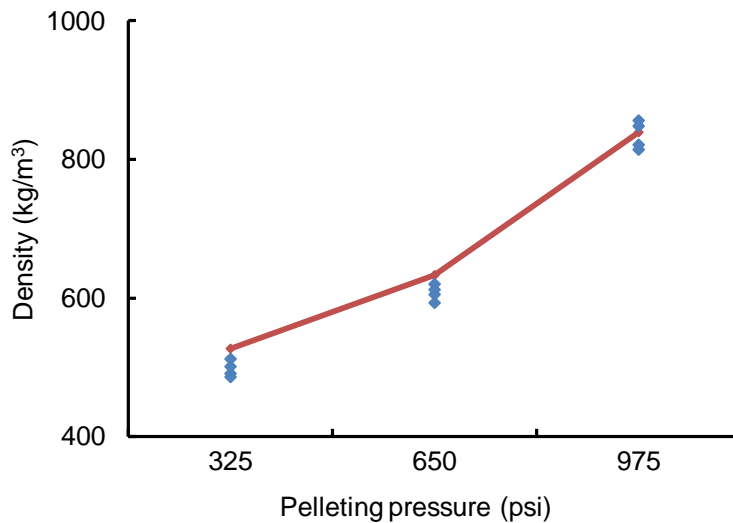

**Table 10.3 Data of pellet density obtained from experiments and model without ultrasonic vibration applied on the tool**

Pelleting pressure (psi)	Density obtained from experiments (kg/m <sup>3</sup> )				Predicted density (kg/m <sup>3</sup> )
325	512	486	491	501	527
650	605	620	593	612	633
975	821	856	814	848	839



Figure 10.7 shows the comparison of pellet densities between model predictions and experiments when different levels of ultrasonic power are applied on the tool and the pelleting pressure is 650 psi. The data are shown in Table 10.4. It can be seen that the predictions fit the experimental results very well at all three levels of ultrasonic power. The difference between predictions and experimental results is lower than 3%, indicating that the proposed model (with the experimentally determined b value) can predict the pellet density very well when ultrasonic vibration is applied on the tool.

**Figure 10.7 Comparison of pellet densities between predictions and experiments at different levels of ultrasonic power**

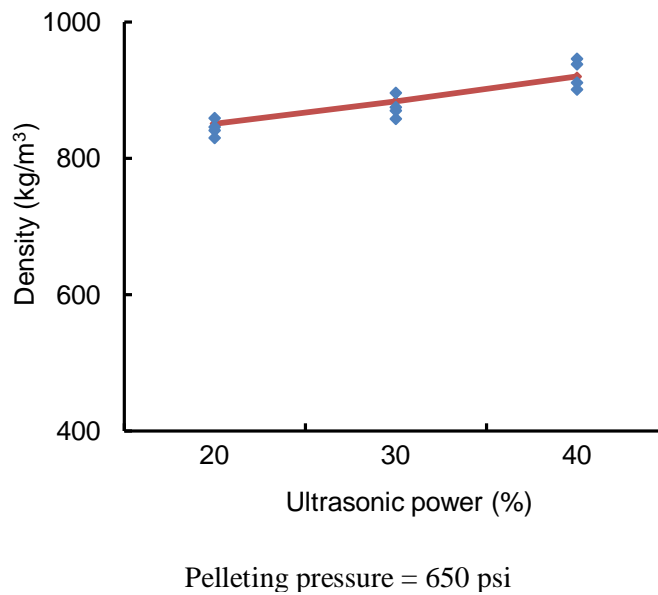
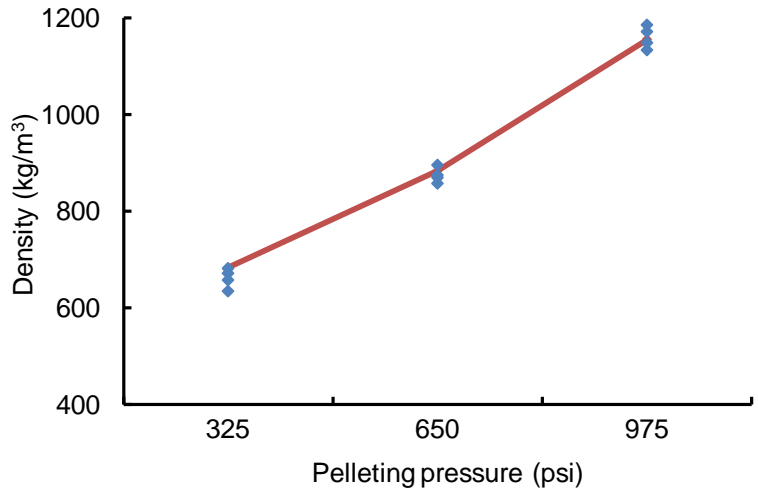

**Table 10.4 Data of pellet density obtained from experiments and predictions at different levels of ultrasonic power (pelleting pressure = 650 psi)**

Ultrasonic power (%)	Density obtained from experiments (kg/m <sup>3</sup> )				Predicted density (kg/m <sup>3</sup> )
20	841	859	830	846	851
30	896	875	870	858	884
40	901	938	946	911	920

Figure 10.8 shows the comparison of pellet densities between model predictions and experiments when 30% ultrasonic power is applied on the tool at different levels of pelleting pressure. The data are shown in Table 10.5. The predictions fit the experimental results very well at all three levels of pelleting pressure. The difference between predictions and experimental results is lower than 6%.

**Figure 10.8 Comparison of pellet densities between predictions and experiments at different levels of pelleting pressure**



Ultrasonic power = 30%

**Table 10.5 Data of pellet density obtained from experiments and predictions at different levels of pelleting pressure (ultrasonic power = 30%)**

Pelleting pressure (psi)	Density obtained from experiments (kg/m <sup>3</sup> )				Predicted density (kg/m <sup>3</sup> )
325	635	672	658	682	684
650	896	875	870	858	884
975	1172	1134	1186	1149	1156

## **10.5 Conclusions**

A mechanistic model for pellet density in ultrasonic vibration-assisted (UV-A) pelleting of cellulosic biomass has been developed using wheat straw as an example. The model was used to predict pellet density (without considering pellet expansion after removal of pelleting pressure) at different levels of ultrasonic power (0, 20%, 30%, and 40%). The predicted densities were compared with experimental results. When ultrasonic power is zero (ultrasonic vibration not applied on the tool), the proposed model can give good prediction on pellet density at higher pelleting pressure. When ultrasonic power is not zero (ultrasonic vibration applied on the tool), the proposed model (with one experimentally determined coefficient) can predict the pellet density very well.

## **Acknowledgement**

This study is supported by NSF award CMMI-0970112. The authors gratefully extend their acknowledgements to Daniel Reust and Kenneth Telford at Kansas State University for their help in conducting experiments, and Mr. Clyde Treadwell at Sonic Mill for providing experimental equipment.

## **References**

Aden, A., Ruth, M., Ibsen, K., Jechura, J., Neeves, K., Sheehan, J., Wallace, B., Montague, L., Slayton, A., and Lukas, J., 2002, "Lignocellulosic biomass to ethanol process design and economics utilizing co-current dilute acid prehydrolysis and enzymatic hydrolysis for corn stover," NREL/TP-510-32438, National Renewable Energy Laboratory, Golden, CO, US.

- ASABE Standard S358.2, 2002, “Moisture Measurement—Forages,” American Society of Agricultural and Biological Engineers, St. Joseph, US.
- Bilanski, W.K., Graham, V.A., and Hanusiak, J.A., 1985, “Mechanics of bulk forage deformation with application to wafering,” Transactions of American Society of Agricultural Engineers, 28(3), pp. 697-702.
- Decker, J., 2009, Going against the grain: ethanol from lignocellulosics, Renewable Energy World, <http://www.renewableenergyworld.com/rea/news/article/2009/01/going-against-the-grain-ethanol-from-lignocellulosics-54346>.
- U.S. Department of Energy, 2003, Roadmap for agricultural biomass feedstock supply in the United States, <http://genomicscience.energy.gov/biofuels/2005workshop/b2bhighres63006.pdf>.
- U.S. Department of Energy, 2006, Breaking the biological barriers to cellulosic ethanol: a joint research agenda, <http://genomicscience.energy.gov/biofuels/2005workshop/b2bhighres63006.pdf>.
- Falk, D., 1985, Pelleting cost center, in: Feed Manufacturing Technology, 3rd edition, M.M. McEllhiney (ed.), American Feed Industry Association, Arlington, VA, US.
- Faborode, M.O., and O’Callaghan, J.R., 1986, “Theoretical analysis of the compression of fibrous agricultural materials,” Journal of Agricultural Engineering, 35(3), pp. 175-191.
- Ferrero, A., Jorabik, J., and Molenda, M., “Density-pressure relationships in compaction of straw,” Canadian Agricultural Engineering, 33, pp. 107-111.
- Haddad, Y.M., 1995, Viscoelasticity of engineering materials, Chapman & Hall, New York, NY.
- Hess, J.R., Wright, C.T., and Kenney, K.L., 2007, “Cellulosic biomass feedstocks and logistics for ethanol production,” Biofuels, Bioproducts and Biorefining , 1, pp. 181–190.

- Macosko, C.W., 1994, *Rheology: Principles, Measurements and Applications*, Wiley, New York, NY.
- Mani, S., Tabil, L.G., and Sokhansanj, S., 2003, "An overview of compaction of biomass grinds," *Powder Handling and Processing*, 15(3), pp. 160-168.
- Mewes, E., 1959, "Compression relationships as a result of experiments in pressure chambers," *Landtechnische Forschung*, 9(3), pp. 68-76.
- Mohsenin, N.N., 1986, *Physical properties of plant and animal materials*, Gordon and Breach Science Publishers, New York, NY.
- O'Dogherty, M.J., and Wheeler, J.A., 1984, "Compression of straw to high densities in closed cylindrical dies," *Journal of Agricultural Engineering Research*, 29(1), pp. 61-72.
- O'Dogherty, M.J., 1989, "A review of the mechanical behavior of straw when compressed to high densities," *Journal of Agricultural Engineering Research*, 44, pp. 241-265.
- Ozerov, A.M., 1961, "The coefficient of friction of grass and its variation during drying," *Traktory Selkhoz mashiny*, 31 (5), pp. 19-21.
- Perlack, R.D., Wright, L.L., Turhollow, A.F., Graham, R.L., Stokes, B.J., and Erbach, D.C., 2005, "Biomass as Feedstocks for a Bioenergy and Byproducts Industry: The Technical Feasibility of a Billion-Ton Annual Supply," DOE Technical paper, GO-102005-2135.
- Phillips, S., Aden, A., Jechura, J., Dayton, D., and Eggeman, T., 2007, "Thermochemical ethanol via indirect gasification and mixed alcohol synthesis of lignocellulosic biomass," NREL Technical Report, TP-510-41168, National Renewable Energy Laboratory, Golden, CO, US.
- Rubin, E.M., 2008, "Genomics of cellulosic biofuels," *Nature*, 454, pp. 841-845.

- Sokhansanj, S., Mani, S., and Zaini, P., 2005, "Binderless pelletization of biomass," ASABE Paper No. 056061, American Society of Agricultural and Biological Engineers, St. Joseph., MI, US.
- Viswanathan, R., Gothandapani, L., 1999, "Pressure density relationships and stress relaxation characteristics of coir pith," *Journal of Agricultural Engineering Research*, 13, pp.217-225.
- Yang, B., and Wyman, E., 2008, "Pretreatment: the key to unlocking low-cost cellulosic ethanol," *Biofuels, Bioproducts, and Biorefining*, 2, pp. 26-40.
- Zhang, P.F., Deines, T., Nottingham, D., Pei, Z.J., Wang, D.H., and Wu, X.R., 2010, "Ultrasonic vibration-assisted pelleting of biomass: a designed experimental investigation on pellet quality and sugar yield," *Proceedings of the 2010 International Manufacturing Science and Engineering Conference*, Erie, PA, US, October 12-15.
- Zhang, P.F., Pei, Z.J., Wang, D.H., Wu, X.R., Cong, W.L., Zhang, M., and Deines, T., 2011, "Ultrasonic vibration-assisted pelleting of cellulosic biomass for biofuel manufacturing," *Journal of Manufacturing Science and Engineering*, 133(1), pp. 011012.1-011012.7.

## **Chapter 11 - Conclusions**

### **11.1 Summaries and conclusions of this dissertation**

In this dissertation, ultrasonic vibration-assisted (UV-A) pelleting of cellulosic biomass materials for ethanol manufacturing is investigated. The feasibility of UV-A pelleting as pretreatment for ethanol manufacturing is studied, and effects of input variables (such as biomass moisture content, biomass particle size, pelleting pressure, and ultrasonic vibration power) on pellet quality (such as density, durability, and stability) and sugar yield are studied. The sugar yields of biomass processed and not processed by UV-A pelleting are compared under different combinations of pretreatment variables (temperature, processing time, and solid content). The mechanisms through which UV-A pelleting increases sugar yield are investigated. A mechanistic model is developed to predict pellet density in UV-A pelleting. The studies presented in this dissertation are highlighted in Figure 11.1.

**Figure 11.1 Studies of this dissertation**

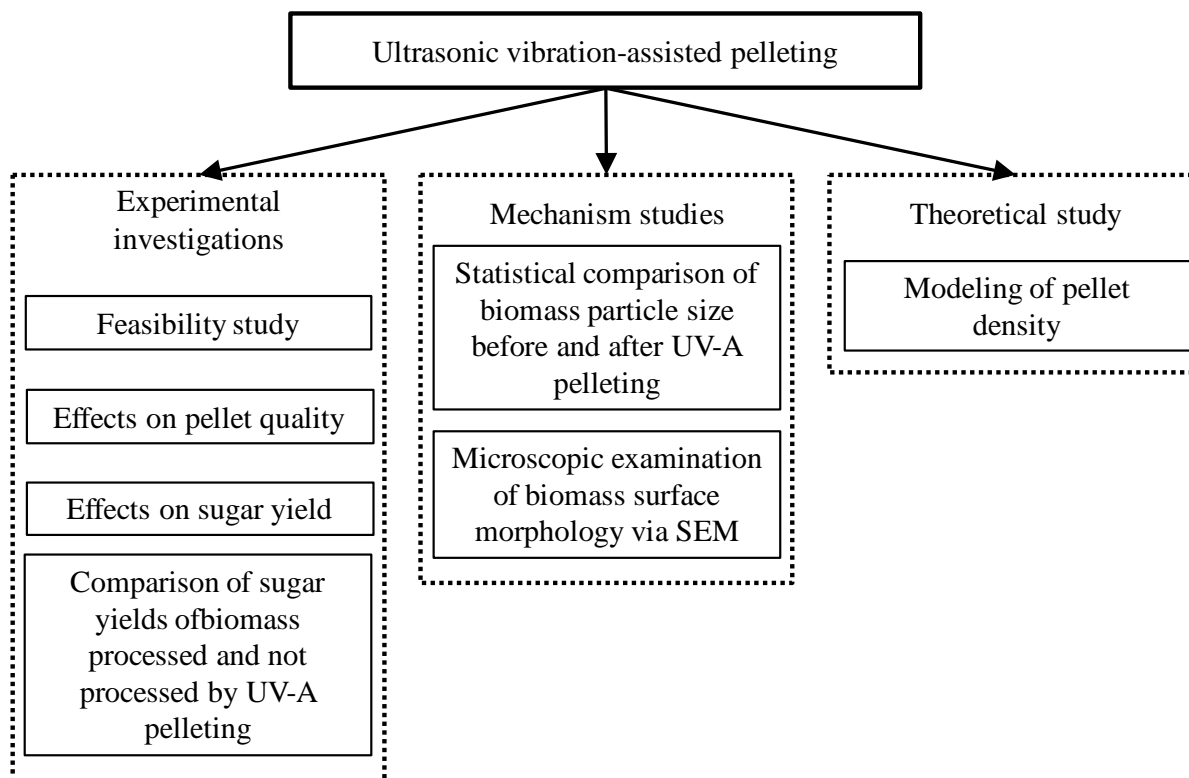

Below are the main conclusions drawn from this dissertation:

1. UV-A pelleting (without using any binder material) can produce pellets whose density is comparable to those produced by traditional pelleting processes (in which high pelleting pressure, high temperature steam, and binder materials are usually used). Pellets produced by UV-A pelleting also have good stability and durability. Ultrasonic vibration can also reduce pelleting force on the rotary UV-A pelleting machine.
2. The four input variables (biomass moisture content, biomass particle size, pelleting pressure, and ultrasonic vibration power) investigated have significant effects on pellet density. For pellet durability, biomass moisture content, biomass



particle size, and ultrasonic power, as well as the interaction effects of moisture content and ultrasonic power are significant. For pellet stability, only the main effect of particle size is significant. For sugar yield, the main effect of particle size and the interaction effects of particle size and moisture content are significant.

3. Biomass particles produced by hammer milling have lower crystallinity indices than those produced by knife milling and manual cutting. Each size reduction method produces biomass particles with different sizes but the same crystallinity index. The particles that have different sizes but the same crystallinity index have the same sugar yield.
4. Compared with non-pelleted biomass or biomass pelleted without ultrasonic vibration, pellets produced by UV-A pelleting can increase sugar yield by more than 20%. UV-A pelleted biomass has higher sugar yield than non-pelleted biomass under different combinations of pretreatment variables. The difference in sugar yield between UV-A pelleted and non-pelleted biomass is larger when shorter processing time or more solid content is applied in pretreatment.
5. Biomass particle sizes before and after UV-A pelleting are not significantly different. In other words, UV-A pelleting does change biomass particle size. Therefore, a hypothesis that UV-A pelleting increases sugar yield by reducing particle size is rejected.
6. UV-A pelleting does not noticeably change the biomass surface morphology observed after pelleting. Significant differences in the surface morphologies between UV-A pelleted biomass and non-pelleted biomass are revealed after pretreatment. Severe disruption is observed on the surface of UV-A pelleted

biomass. Internal cellulose structures are also exposed. For non-pelleted biomass surface, there are only small cracks and no internal cellulose structures. Therefore, it is hypothesized that UV-A pelleting increases sugar yield by increasing accessibility of cellulose to enzymes.

7. A mechanistic model for pellet density in UV-A pelleting of cellulosic biomass has been developed using wheat straw as an example. The model was used to predict pellet density (without considering pellet expansion after removal of pelleting pressure) at different levels of ultrasonic power (0, 20%, 30%, and 40%). The predicted densities were compared with experimental results. When ultrasonic power is zero (no ultrasonic vibration is applied on the tool), the proposed model can give good prediction on pellet density at higher pelleting pressure. When ultrasonic power is not zero (ultrasonic vibration is applied on the tool), the proposed model (with one experimentally determined coefficient) can predict the pellet density very well.

## **11.2 Contributions of this dissertation**

The major contributions of this dissertation are:

1. This dissertation, for the first time, presents a systematic investigation on ultrasonic vibration-assisted (UV-A) pelleting of cellulosic biomass. This research will fill gaps in the literature on cellulosic ethanol manufacturing.
2. This research is the first to show that UV-A pelleting (without using high temperature steam and binding materials) can produce pellets whose density is comparable to those produced by traditional pelleting methods. This research will add to the literature of both ultrasonics and pelleting. In addition, this result is of

practical use in industry to pellet biomass cost-effectively without using costly high temperature steam and binding materials.

3. This research is the first to study effects of UV-A pelleting of cellulosic biomass on sugar yield. This research is also the first to compare sugar yields between non-pelleted and UV-A pelleted biomass. The results will add to the literature of physical pretreatment of cellulosic biomass for enzymatic hydrolysis.
4. This research is the first to show that, in some conditions, mixed particle size results in higher pellet density than each separated particle size. This result will add to the literature of pelleting. In addition, this result is of practical use in pelleting industry for improving pellet density.
5. This research, for the first time, investigates the mechanisms through which UV-A pelleting can increase sugar yield. It is found that UV-A pelleting does not change biomass particle size. It is also found that UV-A pelleting can cause severe disruption on pretreated biomass surface and expose internal cellulose structure, leading to higher accessibility to cellulose by enzymes. This result will add to the literature of enzymatic hydrolysis of cellulosic biomass.
6. For the first time, this research has developed a mechanistic predictive model of pellet density in UV-A pelleting. The stated results help to understand the mechanisms through which ultrasonic vibration can increase pellet density. This research will fill gaps in the literature on modeling of biomass pelleting.

## Appendix A - Publications during Ph.D. study

### Journal publications

1. Zhang, P.F., Pei, Z.J., Wang, D.H., Wu, X.R., Cong, W.L., Zhang, M., and Denies, T., 2011, "Ultrasonic vibration-assisted pelleting of cellulosic biomass for biofuel manufacturing," *Journal of Manufacturing Science and Engineering*, 133 (1), pp. 011012.1-011012.7.
2. Zhang, P.F., Feng, Q., Pei, Z.J., and Zhang W.W., 2010, "Non-traditional drilling of SiC based ceramic matrix composites: a literature review," *Journal of Machining and Machinability of Materials*, 10 (3), pp. 235-259.
3. Zhang, P.F., Churi, N.J., Pei, Z.J., and Treadwell C., 2008, "Mechanical drilling processes for titanium alloys: a literature review," *Journal of Machining Science and Technology*, 12 (4), pp. 417-444.
4. Cong, W.L., Pei, Z.J., Zhang, P.F., Qin, N., Deines, T., and Lin, B., 2011, "Ultrasonic-vibration-assisted pelleting of switchgrass: effects of ultrasonic vibration," *Transaction of Tianjing University*, 17 (5), pp. 313-319.
5. Cong, W.L., Pei, Z.J., Denies, T., Nottingham, D., Zhang, P.F., and Treadwell, C., 2011, "Surface roughness in rotary ultrasonic machining: hypotheses and their testing via experiments and simulations," accepted by *Journal of Manufacturing Science and Engineering*.
6. Cong, W.L., Zhang, P.F., and Pei, Z.J., 2009, "Experimental investigations on material removal rate and surface roughness in lapping of substrate wafers: a literature review,"

Key Engineering Materials, 404, pp. 23-31.

7. Tang, Y.J., Zhang, P.F., Liu, D.F., and Pei, Z.J., 2011, “Effects of pellet weight in ultrasonic vibration-assisted pelleting for cellulosic biofuel manufacturing,” accepted by International Journal of Manufacturing Research.
8. Zhang, M., Song, X.X., Zhang, P.F., Pei, Z.J., Deines, T.W., and Wang, D.H., 2011, “Size reduction of cellulosic biomass in biofuel manufacturing: a study on confounding effects of particle size and biomass crystallinity,” accepted by Journal of Manufacturing Science and Engineering.

## Conference publications

9. Zhang, P.F., Zhang, Q., Pei, Z.J., and Pei, L., 2011, “An experimental investigation on cellulosic biofuel manufacturing: effects of biomass particle size on sugar yield,” Proceedings of the 2011 International Mechanical Engineering Congress and Exposition, Denver, CO, US, November 11-17.
10. Zhang, P.F., Zhang, Q., Pei, Z.J., and Pei, L., 2011, “Ultrasonic vibration-assisted pelleting in manufacturing of cellulosic biofuels: an investigation on biomass particle size,” Proceedings of the 2011 International Mechanical Engineering Congress and Exposition, Denver, CO, US, November 11-17.
11. Zhang, P.F., Zhang, M., Song, X.X., Zhang, Q., Cong, W.L., Qin, N., Pei, Z.J., Deines, T., and Wang, D.H., 2011, “Ultrasonic vibration-assisted pelleting of cellulosic biomass for biofuel manufacturing,” CD-ROM Proceedings of 2011 NSF Civil, Mechanical and Manufacturing Innovation Grantees and Research Conference, Atlanta, GA, US, January 4-7.
12. Zhang, P.F., and Pei, Z.J., 2011, “Cost estimates of cellulosic ethanol manufacturing: a literature review,” Proceedings of the 2011 International Manufacturing Science and Engineering (MSEC) Conference, Corvallis, OR, US, June 13-17.
13. Zhang, P.F., and Pei, Z.J., 2011, “Inclusion of green energy manufacturing contents in an introductory course on manufacturing processes and systems,” Proceedings of the 2011 American Society for Engineering Education (ASEE) Annual Conference and Exposition, Vancouver, BC, CANADA, June 26-29.
14. Zhang, P.F., Deines, T., Nottingham, D., Pei, Z.J., Wang, D.H., and Wu, X.R., 2010, “Ultrasonic vibration-assisted pelleting of biomass: a designed experimental investigation

- on pellet quality and sugar yield,” Proceedings of the 2010 International Manufacturing Science and Engineering Conference, Erie, PA, US, October 12-15.
15. Zhang, P.F., and Pei, Z.J., 2010, “Effects of ultrasonic treatments on cellulose in cellulose biofuel manufacturing: a literature review,” Proceedings of the 2010 International Manufacturing Science and Engineering (MSEC) Conference, Erie, PA, US, October 12-15.
  16. Zhang, P.F., Deines, T., Cong, W.L., Qin, N., Pei, Z.J., and Nottingham, D., 2010, “Ultrasonic vibration-assisted pelleting of switchgrass: effects of moisture content on pellet density, spring-back, and durability,” Proceedings of the Flexible Automation and Intelligent Manufacturing (FAIM) international conference, Oakland, CA, USA, July 12-14.
  17. Zhang, P.F., and Pei, Z.J., 2009, “Lapping of semiconductor wafers: an experimental investigation on subsurface damage,” Proceedings of the 2009 International Manufacturing Science and Engineering (MSEC) Conference, West Lafayette, IN, US, October 4-7.
  18. Zhang, P.F., Li, Z.C., Cong, W.L., and Pei, Z.J., 2009, “Fundamental research on silicon wafer fine grinding: 2008 progress report,” CD-ROM Proceedings of 2009 NSF Civil, Mechanical and Manufacturing Innovation Grantees and Research Conference, Honolulu, HI, US, June 22-25.
  19. Zhang, P.F., Lu, W.K., Liu, J.H., Pei, Z.J., and Fisher, G.R, 2008, “Fundamental research on silicon wafer fine grinding: 2007 progress report,” CD-ROM Proceedings of the 2008 NSF Civil, Mechanical and Manufacturing Innovation Grantees and Research Conference, Knoxville, TN, US, January 7-10.

20. Zhang, P.F., Pei, Z.J., and Treadwell, C., 2007, "Rotary ultrasonic machining of titanium alloy: experimental investigations," Proceedings of the International Symposium on Advances in Abrasive Technology (ISAAT), Dearborn, MI, US, September 25–28.
21. Cong, W.L., Deines, T.W., Feng, Q., Zhang, P.F., Qin, N., and Pei, Z.J., 2011, "Fundamental Research on Titanium drilling with rotary ultrasonic machining: 2010 progress report," CD-ROM Proceedings of 2011 NSF CMMI Research and Innovation Conference; Atlanta, GA, January 4-7.
22. Cong, W.L., Pei, Z.J., and Zhang, P.F., 2009, "Experimental investigations on flatness and subsurface damage in lapping of substrate wafers: a literature review," Proceedings of the ASME International Conference on Manufacturing Science and Engineering (MSEC), West Lafayette, IN, October 4-7.
23. Qin, N., Cong, W.L., Zhang, P.F., and Pei, Z.J., 2011, "Fundamental research on silicon wafer fine grinding: 2010 progress report," CD-ROM Proceedings of 2011 NSF CMMI Research and Innovation Conference; Atlanta, GA, January 4-7.
24. Song, X.X., Zhang, M., Pei, Z.J., Deines, T., Zhang, Q., Zhang, P.F., and Wang, D.H., 2011, "Size reduction of poplar wood using a lathe for biofuel manufacturing: a preliminary experiment," Proceedings of the 2011 International Mechanical Engineering Congress and Exposition, Denver, CO, US, November 11-17.
25. Song, X.X., Zhang, M., Deines, T., Zhang, P.F., Zhang, Q., and Pei, Z.J., 2010, "Ultrasonic-vibration-assisted pelleting of wheat straw: effects of moisture content," Proceedings of the Industrial Engineering Research Conference, Cancun, Mexico, June 5-9.
26. Zhang, M., Song, X.X., Zhang, P.F., Zhang, Q., Pei, Z.J., Deines, T., and Wang, D.H.,



- 2011, "Size reduction of cellulosic biomass in biofuel manufacturing: effects of milling orientation on sugar yield," Proceedings of the 2011 International Manufacturing Science and Engineering (MSEC) Conference, Corvallis, OR, US, June 13-17.
27. Zhang, M., Song, X.X, Deines, T., Zhang, P.F., Zhang, Q., Cong, W.L., Qin, N., and Pei, Z.J., 2010, "Ultrasonic-vibration-assisted pelleting of switchgrass: effects of binder material," Proceedings of the Industrial Engineering Research Conference, Cancun, Mexico, June 5-9.
28. Zhang, M., Song, X.X., Zhang, P.F., Pei, Z.J, and Deines, T., 2011, "Size reduction of cellulosic biomass in biofuel manufacturing: effects of biomass crystallinity and particle size," Proceedings of the 2011 International Mechanical Engineering Congress and Exposition, Denver, CO, US, November 11-17.
29. Zhang, Q., Zhang, P.F., Pei, Z.J., Wilson, J., McKinney, L., and Prichett, G., 2011, "An experimental comparison of two pelleting methods for cellulosic ethanol manufacturing," Proceedings of the 2011 International Manufacturing Science and Engineering (MSEC) Conference, Corvallis, OR, US, June 13-17.
30. Zhang, Q., Zhang, P.F., Song, X.X., Zhang, M., Pei, Z.J., and Deines, T., 2011, "A study on amount of biomass pellets used in durability testing," Proceedings of the 2011 International Manufacturing Science and Engineering (MSEC) Conference, Corvallis, OR, US, June 13-17.
31. Zhang, Q., Zhang, P.F., Pei, Z.J., and Pei, L., 2011, "Effects of treatments on cellulosic biomass structure in ethanol manufacturing: a literature review," Proceedings of the 2011 International Mechanical Engineering Congress and Exposition, Denver, CO, US, November 11-17.

32. Zhang, Q., Zhang, P.F., Pei, Z.J., Pritchett, G., Wilson, J., and McKinney, L., 2011, "Ultrasonic vibration assisted pelleting for cellulosic ethanol manufacturing: an experimental investigation of power consumption," Proceedings of the 2011 International Mechanical Engineering Congress and Exposition, Denver, CO, US, November 11-17.
33. Zhang, Q., Zhang, P.F., Deines, T., Zhang, M., Song, X.X., and Pei, Z.J., 2010, "Ultrasonic vibration assisted pelleting of wheat straw: effects of particle size," Proceedings of the 2010 Flexible Automation and Intelligent Manufacturing International Conference, Hayward, CA, July 12-14.
34. Zhang, Q., Zhang, P.F., and Pei, Z.J., 2010, "Effects of particle size on cellulosic biomass pellets: a literature review," Proceedings of the ASME International Conference on Manufacturing Science and Engineering (MSEC), Erie, PA, October 12-15.
35. Zhang, Q., Zhang, P.F., Deines, T., Pei, Z.J., Wang, D.H., Wu, X.R., and Pritchett, G., 2010, "Ultrasonic vibration assisted pelleting of sorghum: effects of pressure and ultrasonic power level," Proceedings of the ASME International Conference on Manufacturing Science and Engineering (MSEC), Erie, PA, October 12-15.

## Submitted papers

36. Song, X.X., Zhang, M., Deines, T., Zhang, P.F., and Pei, Z.J., 2011, “Energy consumption study in ultrasonic vibration-assisted pelleting of wheat straw for cellulosic biofuel manufacturing,” submitted to Proceedings of the ASME International Conference on Manufacturing Science and Engineering (MSEC), Notre Dame, IN, June 4-8.
37. Wu, H., Zhang, P.F., Zhang, Q., and Pei, Z.J., 2011, “Ultrasonic vibration-assisted pelleting of biomass: an investigation on effects of water soaking on biomass particle size,” submitted to Proceedings of the ASME International Conference on Manufacturing Science and Engineering (MSEC), Notre Dame, IN, June 4-8.
38. Zhang, Q., Zhang, P.F., Pritchett, G., Pei, Z.J., Song, X.X., Zhang, M., and Deines, T., 2011, “Ultrasonic-vibration assisted pelleting for cellulosic ethanol manufacturing: effects of particle size and moisture content on power consumption,” submitted to Proceedings of the ASME International Conference on Manufacturing Science and Engineering (MSEC), Notre Dame, IN, June 4-8.
39. Zhang, Q., Zhang, P.F., Pritchett, G., Pei, Z.J., Song, X.X., Zhang, M., and Deines, T., 2011, “Ultrasonic-vibration assisted pelleting for cellulosic biofuel manufacturing: a designed experimental investigation on power consumption,” submitted to Proceedings of the ASME International Conference on Manufacturing Science and Engineering (MSEC), Notre Dame, IN, June 4-8.
40. Zhang, Q., Zhang, P.F., Fan, K.Q., Zhang, M., Song, X.X., and Pei, Z.J., 2011, “An experimental comparison of sugar yield of two pelleting methods for cellulosic ethanol manufacturing,” submitted to Proceedings of the ASME International Conference on Manufacturing Science and Engineering (MSEC), Notre Dame, IN, June 4-8.

## Working papers

41. Zhang, P.F., Zhang, Q., Fan, K.Q., Zhang, M., and Pei, Z.J., Cost estimates of cellulosic ethanol manufacturing: a literature review, to be submitted to Journal of Manufacturing Science and Engineering.
42. Zhang, P.F., Fan, K.Q., Zhang, Q., Pei, Z.J., Xu, F., and Wang, D.H., Ultrasonic vibration-assisted pelleting in manufacturing of cellulosic ethanol: comparing sugar yield under different pretreatment conditions, to be submitted to Journal of Manufacturing Science and Engineering.
43. Zhang, P.F., Fan, K.Q., Zhang, Q., Singh, G., and Pei, Z.J., Microscopic examination of changes on surface morphology of cellulosic biomass due to UV-A pelleting and diluted acid pretreatment, to be submitted to Journal of Manufacturing Science and Engineering .
44. Zhang, P.F., Fan, K.Q., Zhang, Q., Pei, Z.J., and Wang, D.H., Modeling of pellet density in ultrasonic vibration-assisted pelleting of cellulosic biomass, to be submitted to Journal of Manufacturing Science and Engineering .

## Posters

1. Zhang, P.F., Cong, W.L., Qin, N., Sun, W.P., Zhang, X.H., Li, Z.C., Lu, W.K., Liu, J.H., and Pei, Z.J., 2009, "CAREER: Fundamental research on silicon wafer fine grinding to foster a quantum leap in manufacturing of silicon wafers," Poster section of 2009 NSF Civil, Mechanical and Manufacturing Innovation Grantees and Research Conference; Honolulu, Hawaii, June 22-25.
2. Zhang, P.F., Feng, Q., Zinke, E., Cong, W.L., Zhang, M., Song, X.X., Zhang, Q., Pei, Z.J., and Wang, D.H., 2010, "Ultrasonic vibration-assisted pelleting of cellulosic biomass for bioethanol manufacturing," Poster section of the ASME International Conference on Manufacturing Science and Engineering (MSEC), Erie, PA, October 12-15.
3. Cong, W.L., Zhang, P.F., Qin, N., Zhang, M., Song, X.X., Zhang, Q., Nottingham, D., Clark, R., Denies, T., Pei, Z.J., and Wang, D.H., 2009, "Ultrasonic-vibration-assisted pelleting of cellulosic biomass for biofuel manufacturing," Poster section of the ASME International Conference on Manufacturing Science and Engineering (MSEC), West Lafayette, IN, October 4-7.
4. Zhang, M., Song, X.X., Zhang, P.F., Theerarattananoon, K., Denies, T., Jones, E., Pei, Z.J., and Wang, D.H., 2010, "Poplar based biofuel manufacturing," Poster section of the ASME International Conference on Manufacturing Science and Engineering (MSEC), Erie, PA, October 12-15.