

HAND MADE HOUSES FOR EX-KAMAIYAS:  
A PATTERN LANGUAGE FOR THE PRODUCTION OF LOW-COST SELF-HELP  
HOUSING IN WESTERN TERAI REGIONS OF NEPAL

by

AMIT BAJRACHARYA

B.Arch., IOE, Tribhuvan University, Kathmandu, Nepal, 2008

A THESIS

submitted in partial fulfillment of the requirements for the degree

MASTER OF SCIENCE

Department of Architecture  
College of Architecture, Planning, and Design

KANSAS STATE UNIVERSITY  
Manhattan, Kansas

2011

Approved by:

Major Professor  
Dr. David Seamon

**Copyright**

AMIT BAJRACHARYA

2011

## **Abstract**

*Kamaiya* is a system of Nepalese agriculture bonded labor. In typical wage labor, one can enter or withdraw from the labor market as an independent agent; in the case of bonded labor, however, a worker cannot control his or her labor power. The Kamaiyas were liberated by the Nepalese government in 2000, and promised land to build houses. Without enough money for construction, however, many of these “ex-Kamaiyas,” as they are now called, are without housing or live in sub-standard units.

This thesis examines the housing possibilities for the ex-Kamaiyas and aims at creating basic guidelines for planning and designing low-cost, self-help housing. The thesis is an attempt to design affordable and environmentally responsive housing that draws on Nepalese vernacular traditions but incorporates some modern materials and construction methods. The research and designs are based on interviews with ex-Kamaiyas living in the Nepalese villages of Tesanpur, Janatanagar, and Bhuri Gaun. The thesis serves as a guide for non-profit organizations working to provide housing for the ex-Kamaiyas and consists of guidelines, termed “design patterns,” for laying out ex-Kamaiya neighborhoods and for designing and constructing individual houses. The thesis also provides step-by-step construction guidelines for building the houses. The thesis’s last chapter evaluates the proposed housing system and identifies strengths and weaknesses.

# Table of Contents

List of Figures .....	viii
List of Tables .....	xiii
Acknowledgements .....	xiv
Dedication .....	xv
Chapter 1: Introducing the Ex-Kamaiyas .....	1
Nepal and the Tharus .....	1
The Ex-Kamaiyas .....	4
Organization of the Thesis .....	6
Chapter 2: A Historical Overview of Self-Help Housing .....	8
Hassan Fathy's Approach at Self-Help Housing .....	11
Christopher Alexander's Effort at Self-Help Housing .....	15
Balkrishna Doshi's Effort at Self-Help Housing .....	22
Laurie Baker's Effort at Self-Help Housing .....	24
Conclusion .....	27
Chapter 3: Understanding Vernacular Architecture and the Ex-Kamaiyas .....	31
The Tharus' Vernacular Architecture .....	32
Low-Cost Housing Approaches of the INGOs .....	39
The Ex-Kamaiyas and their Housing Requirements .....	45
Conclusion .....	50
Chapter 4: Large-Scale Patterns for Designing Ex-Kamaiya Neighborhoods .....	53
Meta-Patterns for Ex-Kamaiya Neighborhoods .....	55
1. Sustainability .....	56

2. Sense of Place .....	57
3. Community Commitment .....	57
4. Modern yet Embracing Tradition .....	58
Design Patterns for Ex-Kamaiya Neighborhoods .....	59
1. Village Center as Activity Nucleus .....	59
2. Builder Yard .....	60
3. Hierarchy of Open Spaces .....	61
4. Neighborhoods as Housing Clusters .....	62
5. Connection between Communities .....	64
6. Common Courtyards .....	64
Neighborhoods Generated by Patterns .....	66
Conclusion .....	70
Chapter 5: Small-Scale Patterns for Designing Ex-Kamaiya Houses .....	73
Meta Patterns for Ex-Kamaiya Houses .....	74
1. Sense of Pride .....	75
2. Sense of Individuality and Uniqueness .....	75
3. Sense of Security .....	76
4. Modern yet Embracing Tradition .....	76
Design Patterns for Ex-Kamaiya Houses .....	77
1. Inhabiting the Site .....	77
2. Capturing Light .....	79
3. Capturing Wind .....	80
4. Space Layout .....	81

5. Verandah as In-between Space .....	81
6. Number of Stories .....	82
7. Sheltering Roof .....	83
8. Building with Available Materials .....	84
9. CSEB Walls with Innovative Bonding .....	84
10. Floors and Ceiling .....	85
11. Foundations .....	86
12. Windows and Doors .....	86
13. Bamboo for Structural Members .....	87
14. Exterior Design Elements .....	88
Houses Generated by Patterns .....	89
Conclusion .....	95
Chapter 6: Step-by-Step Construction .....	98
Step 1: Laying out Stakes .....	102
Step 2: Excavating Trenches for Foundation .....	103
Step 3: Placing Foundations .....	104
Step 4: Building Plinth .....	105
Step 5: Erecting CSEB Perimeter Walls .....	106
Step 6: Placing Perimeter Beam .....	107
Step 7: Constructing Second-Storey Floor .....	107
Step 8: Placing Doors and Windows .....	108
Step 9: Installing Electrical Circuits .....	109
Step 10: Erecting Bamboo Pillars .....	109

Step 11: Preparing Framework for Roof .....	110
Step 12: Placing CGI Sheets .....	111
Step 13: Preparing Ground Floor .....	111
Step 14: Preparing Front Yard .....	112
Step 15: Painting and Decorating Walls .....	112
Conclusion .....	113
Chapter 7: Conclusion .....	115
References .....	122
Appendix 1: Summary and Analysis of Interviews with Ex-Kamaiyas .....	126
Appendix 2: Climatic Data of Rampur, a Terai Town in Nepal .....	129
Appendix 3: IRB Application Form .....	130
Appendix 4: Interview Questions .....	140

## List of Figures

- Figure 1.* Cluster planning of traditional Tharu settlement in Bardiya, one of the western Terai districts of Nepal. Traced by the author from <http://maps.google.com/maps?hl=en&tab=w1> ..... 3
- Figure 2.* Map of Nepal showing Kamaiya habitation. Retrieved March 10, 2010 from [http://escr.omct.org/files/interdisciplinary-study/ii\\_b\\_3\\_nepal\\_case\\_study.pdf](http://escr.omct.org/files/interdisciplinary-study/ii_b_3_nepal_case_study.pdf) ..... 4
- Figure 3.* Plan of New Gourn Village. Image copyright 1993, Hassan Fathy, p.290. .... 13
- Figure 4.* Axonometric View of the five houses (left) and builder's yard (right) in Mexicali. Image copyright 1985, Christopher Alexander, p.12. .... 19
- Figure 5.* Overall site model of Aranya Community Housing. Image copyright 1995, Balkrishna Doshi, p. 24. .... 23
- Figure 6.* Features of Baker's cost-effective architecture: stepped arch, innovative brick bonding, windows, and jalls. Image copyright 1991, Gautam Bhatia, p. 44. .... 25
- Figure 7.* Cluster planning of typical traditional Tharu settlement in Bardiya, a western Terai district of Nepal. Image retrieved October 3, 2010 from <http://maps.google.com/maps?hl=en&tab=w1>. .... 33
- Figure 8.* Author's sketches of a traditional Tharu house and its surrounding in Bardiya, a western Terai district of Nepal. Source: Data collected by author, July, 2010. .... 35
- Figure 9.* Author's photograph of a Tharu house showing small fenestrations, horizontal members of wattle and daub wall, and roof form, July, 2010. .... 37
- Figure 10.* Author's photograph showing intercepting traditional roof tiles, khapada, with mud in-between, July, 2010. .... 38



<i>Figures 11 &amp; 12.</i> Author’s photographs showing one-story brick house for ex-Kamaiyas in Tesanpur provided by AAN, July, 2010. ....	40
<i>Figure 13.</i> Author’s sketches of floor plan and foundation of ex-Kamaiya house provided by AAN in Tesanpur. Source: Data collected by author, July 2010. ....	41
<i>Figures 14 &amp; 15.</i> Author’s photographs showing one story bamboo and timber house for ex-Kamaiyas in Bhuri Gaun provided by HFH, July 2010. ....	42
<i>Figure 16.</i> Author’s sketches of floor plan and section of ex-Kamaiya house provided by HFH in Bhuri Gaun. Source: Data collected by author, July 2010. ....	43
<i>Figures 17 &amp; 18.</i> Author’s photographs showing the additions made by ex-Kamaiya families to the houses provided by AAN in Tesanpur village, July, 2010. ....	47
<i>Figure 19.</i> Author’s photograph showing a house provided by AAN for a ex-Kamaiya family (right) and a building constructed by the family for kitchen (left) in Tesanpur, July, 2010. ....	49
<i>Figure 20.</i> Pattern 1: The Village Center as Activity Nucleus (author’s sketch of an open market in a village center, Feb, 2011). ....	60
<i>Figure 21.</i> Pattern 2: The Builder Yard (author’s sketch, February, 2011). ....	61
<i>Figure 22.</i> Pattern 3: The Hierarchy of Open Spaces (author’s sketch, February, 2011). ....	62
<i>Figure 23.</i> Pattern 4: The Neighborhoods as Housing Clusters (author’s sketch, February, 2011). ....	63
<i>Figure 24.</i> Pattern 5: The Connection between Communities (author’s sketch, February, 2011). ....	64
<i>Figure 25.</i> Pattern 6: The Common Courtyards (author’s sketch, February, 2011). ....	65

<i>Figure 26.</i> Author’s photograph of a map of Tesanpur village prepared by AAN showing the linearly planned ex-Kamaiya neighborhoods, July, 2010. ....	66
<i>Figure 27.</i> Author’s photograph of houses constructed by AAN in Tesanpur village, July, 2010. ....	67
<i>Figure 28.</i> Step 1-- Determining the project boundary and the main village center (left), Step 2-- Arranging neighborhoods around the main center (right) (author’s sketch, February, 2011). ....	68
<i>Figure 29.</i> Step 3-- Laying out the connecting roads and narrow alleys (left), Step 4-- Laying out individual plots around common courtyards (right) (author’s sketch, February, 2011). ....	69
<i>Figure 30.</i> The arrangement of proposed ex-Kamaiya houses around a common courtyard (author’s sketch, February, 2011). ....	69
<i>Figure 31.</i> Proposed ex-Kamaiya housing in Tesanpur village (author’s drawing, February, 2011). ....	71
<i>Figure 32.</i> Pattern 1: Inhabiting the Site (author’s sketch of an ex-Kamaiya neighborhood showing layout of houses around common courtyard, February, 2011). ....	78
<i>Figure 33.</i> Pattern 2: Capturing Light (author’s sketch of an ex-Kamaiya house section showing natural light distribution, February, 2011). ....	79
<i>Figure 34.</i> Pattern 3: Capturing Wind (author’s sketch of an ex-Kamaiya house section showing cross-ventilation, February, 2011). ....	80
<i>Figure 35.</i> Pattern 4: Space Layout (author’s sketch connection between spaces, February, 2011). ....	81
<i>Figure 36.</i> Pattern 5: Verandah as In-between Space (author’s sketch, February, 2011). ....	82

<i>Figure 37.</i> Pattern 6: Number of Stories (author’s sketch, February, 2011). .....	82
<i>Figure 38.</i> Pattern 7: Sheltering Roof (author’s sketch, February, 2011). .....	83
<i>Figure 39.</i> Pattern 8: Building with Available Materials (author’s sketch, February, 2011). .....	84
<i>Figure 40.</i> Pattern 9: CSEB Walls with Innovative Bonding (author’s sketch, February, 2011). .....	85
<i>Figure 41.</i> Pattern 10: Floors and Ceilings (author’s sketch of bamboo-mud floor, February, 2011). .....	85
<i>Figure 42.</i> Pattern 11: Foundations (author’s sketch of rammed earth foundation, February, 2011). .....	86
<i>Figure 43.</i> Pattern 12: Windows and Doors (Baker’s sketch of low-cost fenestrations, from Bhatia, 1991, p. 292-293). .....	87
<i>Figure 44.</i> Pattern 13: Bamboo for Structural Members (author’s drawing, February, 2011).	88
<i>Figure 45.</i> Pattern 14: Exterior Design Elements (author’s sketch of a Thrau woman decorating the exterior walls of her house, February, 2011). .....	88
<i>Figure 46.</i> Author’s sketches of model house 1. ....	90
<i>Figure 47.</i> Author’s drawings of model house 1 and its two story variation. ....	91
<i>Figure 48.</i> Author’s sketches of model house 2. ....	92
<i>Figure 49.</i> Author’s drawings of model house 2 and its roof-form variation. ....	93
<i>Figure 50.</i> Author’s sketches of model house 3. ....	94
<i>Figure 51.</i> Author’s drawings of model house 3 and its roof-form variation. ....	95
<i>Figure 52.</i> Step 1: Laying out Stakes (author’s drawing, March, 2011). ....	102
<i>Figure 53.</i> Step 2: Excavating Trench for Foundations (author’s drawing showing foundation trench and soil heaps to be used for foundation mix, March, 2011). ....	103

<i>Figure 54.</i> Step 3: Placing Foundations (author’s drawing showing steps which represent foundation ramming layers, March, 2011). .....	104
<i>Figure 55.</i> Step 4: Building Plinth (author’s sketch, March, 2011). .....	105
<i>Figure 56.</i> Step 5: Erecting CSEB Perimeter Walls (author’s drawing, March, 2011). .....	106
<i>Figure 57.</i> Step 6: Placing Perimeter Beam (author’s drawing, March, 2011). .....	107
<i>Figure 58.</i> Step 7: Constructing Second-Storey Floor (author’s drawing, March, 2011). ..	108
<i>Figure 59.</i> Step 8: Placing Doors and Windows (author’s drawing of pivot-hinge window, March, 2011). .....	108
<i>Figure 60.</i> Step 10: Erecting Bamboo Pillars (author’s drawing, March, 2011). .....	109
<i>Figure 61.</i> Step 11: Preparing Framework for Roof (author’s drawing, March, 2011). .....	110
<i>Figure 62.</i> Step 12: Placing CGI Sheets (author’s drawing, March, 2011). .....	111
<i>Figure 63.</i> Step 13: Preparing Ground Floor (author’s sketch of ground floor finish , March, 2011). .....	112

## List of Tables

<i>Table 1.</i> Summary of Interviews with Ex-Kamaiyas .....	48
<i>Table 2.</i> Step-by-step construction process for Mexicali Housing, Mexico .....	100
<i>Table 3.</i> Step-by-step construction process for the ex-Kamaiya Housing .....	101

## **Acknowledgement**

I am heartily thankful to my major professor David Seamon for his invaluable guidance and support in the preparation of this thesis. His inspiring advice and thought-provoking questions shaped my overall thinking and gave the right direction to my thesis. I enjoyed working with him. I offer my thanks to my other committee members, Professor Gary Coates and Assistant Professor Todd Gabbard, for their comments and advice.

I am also grateful to the staffs of ActionAid Nepal and Habitat for Humanity for providing me with the information about their work in ex-Kamaiya housing. In addition, I am grateful to the ex-Kamaiyas of Tesanpur, Janatanagar, and Bhuri Gaun for their cooperation and help during my field visit. Lastly, I offer my regards to all of those who supported me in any respect during the completion of the thesis.

## **Dedication**

To Mom, Dad, and Grandma.

# **Chapter 1:**

## **Introducing the ex-Kamaiyas**

Housing the poor has always been an utmost challenge for all countries. The problem is even greater in developing countries like my home country of Nepal. One of the rising challenges of the Nepalese government is providing housing for ex-Kamaiyas, the poorest people living in western Nepal. *Kamaiya* is a system of agricultural bonded labor. Laborers, known as Kamaiyas, were treated as slaves through the 20<sup>th</sup> century (Sharma, 1998). In typical wage labor, one can enter or withdraw from the labor market at will, but in the case of bonded labor, a worker cannot control his or her labor power. After the Kamaiyas were liberated in 2000, the Nepalese government promised to provide them with land to build houses. Without enough money for construction, many ex-Kamaiyas are without housing or live in dilapidated conditions (Shrestha, 2006).

This thesis examines the self-help housing possibilities for ex-Kamaiyas and aims at creating basic guidelines for planning and designing low-cost self-help housing. It is an attempt to design better living conditions for these people; and to make links with the dynamics of the place. The research is based on extensive discussions and interviews with ex-Kamaiyas who live in the Nepalese villages of Tesanpur, Janatanagar, and Bhuri Gaun. I also reviewed the vernacular building traditions of the Tharus of Nepal.

### **Nepal and the Tharus**

Sandwiched between China to the north and India to the south, Nepal is a small country extending 500 miles from east to west and some 150 miles north to south (Shrestha, 1972). Nepal has diversified landforms that range from the high Himalayas towards the north



to the tropical regions (Terai) of the Indo-Gangetic basin, close to sea level, towards the south. These Terai regions of Nepal extend from east to west along the border of India. Demographically, Nepal is inhabited by about sixty ethnic groups, who speak different languages, hold different faiths, and have diverse cultures. These ethnic groups are further divided into castes and sub-castes resulting in variations in their ways of living, culture, and tradition.

*Tharus* are one of the ethnic groups in Nepal with their own culture, traditions, art, and architecture. Though *Tharus* are believed to be one of the earliest groups inhabiting Nepal, their origin is still obscure (ibid.). They have mostly settled in the Terai regions of Nepal with their main occupations of farming and fishing. *Tharu* women are engaged in making bamboo baskets and wheat-straw fans. The *Tharus* are divided into different castes that each has its own culture and religion. They speak a language mixed of Prakrit, Bhojpuri and Maghadi (ibid.). They have their own cuisine and indigenous clothing.

The *Tharus* are usually divided into villages ranging from 50 to 200 inhabitants situated at a distance of about a mile apart (Toffin, 1991). These villages form an oasis of greenery in the midst of open rice fields. Their clustered dwellings contrast with non-*Tharu* houses which are usually scattered in the middle of the fields. In *Tharu* villages, houses are usually arranged in small clusters around an open courtyard (fig. 1). The forms of *Tharu* houses are distinct expressions of the need to adapt to given physical conditions. The houses have thin walls built of light materials like bamboo, mud, and reed with small openings for ventilation to keep out the humid heat (ibid.).



*Figure 1.* Cluster planning of traditional Tharu settlement in Bardiya, one of the western Terai districts of Nepal. Traced by the author from <http://maps.google.com/maps?hl=en&tab=w1>

The Terai regions of Nepal, known to be heavily malarious since remote times, were inhabited by the Tharus, who were reputed to have an innate resistance to malaria. After the eradication of malaria in the mid 1970s, there was a large influx of non-Tharu hill migrants into the Terai. The Tharus had no formalized records of the land they were cultivating. Thus, the migrants, who had close ties with the power center of the state, marginalized the traditionally landowning Tharus by occupying their lands (Shrestha, 2006). Due to illiteracy and with very few non-agricultural skills, the Tharus were forced to enter into bonded agricultural labor with the new landlords. The bondage continued through generations as interest incurred on loans increased, thus blocking any opportunity for following generations to become free of this exploitative labor relation.

## The ex-Kamaiyas

The term *Kamaiya* is believed to have arisen from the dialect of the Tharu ethnic group and refers to “hardworking, hired farm laborer.” There are about two hundred thousand agricultural wage laborers in Nepal; about half of them are landless and one-sixth of them are bonded laborers (Sharma, 1998). The *Kamaiya* system is one form of bonded labor prevalent in the Tharu ethnic group of the western Terai regions of Dang, Banke, Bardiya, Kailali, and Kanchanpur of Nepal (Shrestha, 2006) (fig. 2). The *Kamaiya* system is different from other wage labor because in typical wage labor one can enter or withdraw from the labor market at will. In the case of *Kamaiya* system, however, the laborers are usually bonded by debt incurred from the employer (Sharma, 1998). In this system, the ex-*Kamaiyas* were even forced to send their wives and children to work for the employer. Thus, the *Kamaiya* system can be described as a form of slavery which survived in Nepal for many centuries.



Figure 2. Map of Nepal showing Kamaiya habitation. Retrieved March 10, 2010 from [http://escr.omct.org/files/interdisciplinary-study/ii\\_b\\_3\\_nepal\\_case\\_study.pdf](http://escr.omct.org/files/interdisciplinary-study/ii_b_3_nepal_case_study.pdf)

The government of Nepal, by decree, abolished the Kamaiya system on 17 July 2000 (ibid). This was a landmark event in the lives of Kamaiyas. However, the initial elation quickly faded when the freed Kamaiyas found themselves without shelter after the landlords evicted them from their homes. The government, along with many non-governmental organizations (NGOs) and international non-governmental organizations (INGOs), are working to ensure proper housing, economic-livelihood possibilities, and education for the ex-Kamaiyas. But significant results have not yet been achieved.

The government has classified the ex-Kamaiyas into four categories and has issued respective identity cards (Shrestha, 2006). Homeless and landless ex-Kamaiya families are grouped as A Category (red card ID); families with either a house or a parcel of land are grouped as B Category (blue card ID); families with a house and with up to 0.16 acres of land are grouped as C Category (green card ID); and families with a house and more than 0.16 acres of land is grouped as D Category (white card ID). The Nepalese government provided land to some of the landless ex-Kamaiyas but failed to provide them with housing. Even ten years after their liberation, many are still waiting to receive land from the government. Almost all ex-Kamaiyas who have received land reside in unhygienic, temporary shelters. Thus, housing is still one of the prime concerns, and many NGOs and INGOs are working to provide the ex-Kamaiyas with appropriate shelter.

There is, however, lack of coordination between the government providing lands and the non-governmental organization providing houses. This has resulted in neighborhoods without any sense of community; land areas that are plotted in a grid-iron pattern without any response to tradition and cultural landscape; and houses built at a distance creating isolation and failing to create human bonds among neighbors. In addition, the dwellings built by the

non-governmental organizations are two-room houses which are identical and machine-like, based on the concept of one size fits all. The attempt of this system of production is to construct houses more rapidly and economically, but these houses have largely failed to respond to human feelings and individual dignity. As Christopher Alexander (1985) argues, a more participatory system of housing production is required that can respond to every individual's uniqueness and can bring people together in community. Thus, an incremental, self-help housing-production system that responds to individual and community needs while balancing the traditional and environmental landscape might be the approach that is needed.

### **Organization of the Thesis**

The thesis aims to serve as a guide for the production of socially, economically, environmentally, and technically sustainable self-help housing in the western Terai regions of Nepal. It provides guidelines for the design and layout of individual houses for the ex-Kamaiyas; guidelines for the planning of a typical ex-Kamaiya neighborhood, including the layout of community spaces and streets; and a step-by-step guide for the construction of the houses.

The thesis is organized as follows. Chapter 2 provides the basis for arguing that self-help housing is an effective means for providing low-cost dwellings for the ex-Kamaiyas. The chapter begins by exploring the history of low-cost housing and explains how the concept of self-help housing was identified. Hassan Fathy's self-help housing in New Gurna, Egypt and Christopher Alexander's housing experiment in Mexicali, Mexico are overviewed as two valuable prototypes for generating self-help housing. In addition, low-cost housing approaches of Balkrishna Doshi and Laurie Baker in India are also reviewed.

Chapter 3 starts with the overview of traditional Tharu houses and settlement patterns. Then the low-cost housing approaches of international non-governmental organizations (INGOs) who are working to provide housing for the ex-Kamaiyas are reviewed. In addition, chapter 3 analyses interviews that I conducted with ex-Kamaiyas living in three villages of Bardiya, a western Terai district of Nepal. The three villages studied are Tesanpur, Janatanagar, and Bhuri Gaun.

Chapter 4 explains the thesis' central design guidelines, termed "design patterns," for laying out ex-Kamaiya neighborhoods and elaborates how these guidelines were created. The chapter begins by identifying the underlying philosophical assumptions of the project, termed "meta-patterns," which help to create design patterns that are in tune with the underlying aims of the project. Following the approach of Christopher Alexander's *A Pattern Language* (Alexander, 1977), the patterns are arranged from larger to smaller environmental scale. In addition, to check the practicality and workability of the design patterns, they have been used to plan ex-Kamaiya neighborhoods in the village of Tesanpur.

As in chapter 4, chapter 5 begins with identifying the meta-patterns for the design and layout of individual houses for ex-Kamaiyas. Based on the meta-patterns, the design patterns for individual houses are explained. In addition, chapter 5 also explains how the design patterns are used to design houses for the ex-Kamaiyas.

In turn, chapter 6 provides step-by-step guidelines for the construction of ex-Kamaiya houses. This method of construction and construction materials is grounded in vernacular building tradition and modern needs of the ex-Kamaiyas. The final chapter of the thesis evaluates the proposed housing system as explained in chapters four-to-six and highlights strengths and weaknesses of the process.

## **Chapter 2:**

### **A Historical Overview of Self-Help Housing**

Social commentator Charles Abrams pointed out that housing has been one continuing emergency in the 20<sup>th</sup> century and remains such today (Abrams, 1946). Inadequate conditions along with problems of hygiene persist; dwelling affordability is worsening; and human overcrowding remains. For the last hundred years, attempts at providing housing for the world's growing population have faced setbacks because of war, natural disaster, and poverty, which in turn resulted in the rise of slums and squatters (Stohr, 2006). As architects adapted the idealism of the machine age and offered more utopian ideas, they failed to realize the day-to-day realities of providing housing, clean water, and sanitation to families in need.

Humanitarian social design originated in late 1800s and early 1900s, when the tenant movements brought the housing conditions of the poor to public attention (ibid). The uncontrolled urbanization brought by the industrial revolution resulted in unhygienic and squalid living conditions. The reform movement introduced light wells, better sanitation, and other design improvements for tenement housing (ibid). In 1898, Ebenezer Howard envisaged planned communities with clean air, water, equal opportunities, and free from slums. His vision, combined with the modernist concept of mass production envisioned after World War I, had profound influence on low-cost housing projects. The focus was on prefabrication of walls, floors, doors, and windows to be assembled on site. Le Corbusier, Walter Gropius, and Buckminster Fuller envisioned mass-manufactured dwellings as the future of housing. In the 1930s, the depression in America demanded cheap and portable housing which gave rise to mobile homes that represented the dream of prefabricated American dwellings (ibid).

With the end of World War II in 1945, millions of people became homeless and emergency shelter became a priority. Disaster relief was separated from development work as the housing field became more specialized. In addition, urban renewal was separated from low-cost housing in rural areas (ibid). There was an unprecedented boom in the housing sector based on the idea of mass production in the Western World to cope with growing housing needs. Though prefabrication and mass production had limited success, it was eventually exported to developing countries to house people displaced from slum clearance and as a feature of urban renewal programs. However, the mass production of houses could not meet demand and could not do much to deter spontaneous settlements (Ward, 1982).

As Ward writes, “Spontaneous settlement is just one name given to illegal housing developments that have emerged since World War II as a result of rapid urbanization throughout the Third World” (ibid, p.1). These developments are also referred to as uncontrolled, unauthorized, self-generated, and marginal settlements. With architects failing to realize the basic need of people for elementary shelter, self-help activists argued that funds should be directed away from government-built housing towards supporting families to upgrade and build their own homes (Stohr, 2006). The idea of people living in self-built homes is not new, and the concept can be traced back to cave dwellers. Since prehistoric times, people had been constructing their own houses without technical or financial aid from government, funding agencies, engineers, and architects.

The work of Hassan Fathy in New Gournia, Egypt is seen as one of the most notable experiments in self-help housing (Fathy, 1993). New Gournia was envisioned as a village built by the Gourni villagers themselves. All the buildings were constructed using local mud-brick and traditional craftsmanship. Though the project was never completed, it left a lasting legacy



in self-help housing. Over time, Fathy's concept of building by the poor for the poor would have a profound influence on architects working on issues of self-help housing in the developing world. For example, a self-help and mutual-aid project undertaken in Puerto Rico in 1949 to resettle 67,000 farm workers was very successful (Stohr, 2006). The state government provided small plots of land for each family, and families were organized in groups of thirty to work for each other along with a construction supervisor and a social worker. Families were free to design and build their homes using any method that made sense rather than just focusing on traditional construction systems. This project also influenced the work of John F.C. Turner in Peru and works of many other self-help activists (ibid). Thus, the poor were no longer seen as a burden but as a resource.

In the 1980s, the idea of self-help was given new directions by Millard and Linda Fuller, founders of Habitat for Humanity, who brought the concept of involving volunteers, rather than just relying on the labor forces of families. With the aim of upgrading living conditions of the urban poor, sites-and-services models were introduced which actually spurred debate about accessibility to work, land-ownership issues, and human impact on environment. The emphasis on quantity over quality resulted in homes deprived of design, so the role of architects in housing was again questioned. More recently, architects like Samuel Mockbee and Fred Cuny have focused on building sustainable communities, thus, bridging the gap between basic shelters and creating sustainable communities (ibid).

Today, with the world population growing at an alarming rate and natural hazards becoming more frequent, the need for inexpensive but workable housing is growing like never before. So it is a challenge to create economically and socially sustainable communities that can house the world's population without impacting the fragile environment.

## **Hassan Fathy's Approach at Self-Help Housing**

Hassan Fathy is one of the key figures in the field of self-help housing, and it is important to review his work in detail. His work in New Gournna, Egypt, is seen as one of the most notable experiments in self-help housing. Preserving traditional building skills and maintaining sustainable relationship of buildings with their natural environment are among the enduring themes of Fathy's work (Facey, 1999, p.43). He saw architecture as a communal art that reflects the personal habits and traditions of a community rather than altering or eradicating them (Steele, 1997, p.11). Being inspired by the beauty and sustainability of traditional Egyptian architecture, he experimented with mud-brick construction and built many mud-brick houses. For Fathy, choice of building materials was based on environmental forces in the building rather than the pursuit of a decorative effect (Steele, 1999, p.55).

Though Fathy was trained in Westernized institutions and came from a well-off family, he went into the peasant villages to design dwellings for poor whom he considered his clients. In 1981, Fathy told *Aramco World* writer John Feeney in an interview that the less expensive the house, the more art one has to be put into it. One cannot oversimplify and design one house for a million people. Fathy actually custom-designed each house in the settlement of New Gournna intended for seven thousand people. He was not against innovation or technology, but he saw technology as subservient to social values (Steele, 1997, p.11).

In 1945, Fathy was asked to design and build a new village on fifty acres of donated land for seven thousand relocated Egyptian peasants, the Gournnis. The old village of Gournna was built on the site of the Tombs of the Nobles. The residents of the village, Gournnis, were tomb robbers and they were destroying archeological treasures. In an effort to protect the archeologically important site from the Gournnis, government decided to resettle the Gournni

community in a new village to be built about three miles from the old village (Fathy, 1993). Egypt has a rich vernacular building tradition, which sought Fathy to revive as a way to envision the new village for the Gournis. Fathy believed that architecture is a traditional art: “When the full power of a human imagination is backed by the weight of a living tradition, the resulting work of art is far greater than any that an artist can achieve when he has no tradition to work in or when he willfully abandons his tradition” (ibid, p. 25). The revival of traditional methods of building vaults and domes in mud bricks ensured that the entire structure of the houses could be constructed out of mud. This made the houses much cheaper as well as aesthetically more pleasing.

Through the Gourni project, Fathy was offered a chance to test his ideas of low-cost architecture based on the sustainable building techniques that existed in Egypt for centuries. He opposed modernist concepts of residential towers and prototype mass housing and believed that development reflecting individual needs, social customs, and culture is possible only through self-help housing: “If you regard people as ‘millions’ to be shoveled into various boxes like loads of gravel, if you regard them as inanimate, unprotesting, uniform objects, always passive, always needing things done to them, you will miss the biggest opportunity to save money presented to you. For, of course, a man has a mind of his own, and a pair of hands that do what his mind tells them..... Give him half a chance and a man will solve his part of the housing problem without the help of architects, contractors, or planners- far better than any government authority ever can” (ibid, p.32).

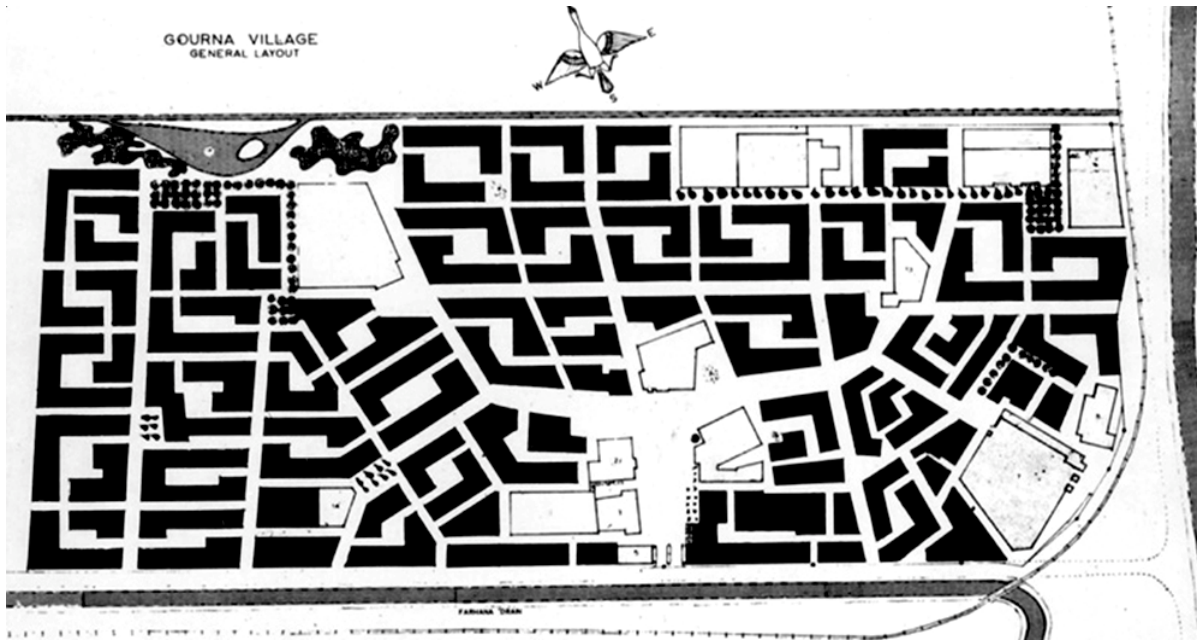

*Figure 3. Plan of New Gournia Village. Image copyright 1993, Hassan Fathy, p.290.*

Fathy designed the village with four neighborhoods separated by main streets as in Old Gournia, where five tribal groups were housed into four neighborhoods. He located a mosque, theatre, exhibition hall, and craft building around or near the main square. The regular grid-iron pattern was not followed, as it would have forced the uniform design of village blocks and houses. Fathy designed each house differently according to the requirements of individual families. He then, organized “Badanas” in blocks around a street. “Badana” is a group of twenty-to-thirty families related by blood (ibid). Spaces in each house included open-air kitchen, outdoor living room, bedrooms, stable for cows, and storage area, arranged around a small house courtyard designed to provide shade, capture cool air, and serve as a place for social events. All buildings were constructed using local mud-brick and traditional craftsmanship.

New Gournia was envisioned as a village built by the villagers themselves. But the project did not live up to Fathy's expectation because he could not convince the Gournis to work on the project. They resented resettlement and opposed the project as a whole because they were satisfied with the life in their old village. Though the project was never completed, it left a lasting legacy and is seen as a cornerstone in self-help housing. Fathy demonstrated that it is possible for the architect to guide a self-help project. After Fathy's book *Architecture for Poor* was published, visionary developers throughout the arid regions of the developing world have looked to his ideas of low-cost self-help housing (Swan, 1999, p.18).

Fathy left ever-lasting effects of his ideas and themes through his followers like Simone Swan, Abidel Wahed El-Wakil, and Sahel Lamei Mostafa (Facey, 1999). Simone Swan was inspired by Fathy's concept of using earthen materials and indigenous building techniques for self-help housing. In the late 1900s, she established the Adobe Alliance in the Big Bend area of West Texas to promote low-cost housing in the Mexico-US border region. She also introduced traditional Egyptian style of making domes and vaults in America. Abidel Wahed El-Waki is an Egyptian architect who is widely known for his mosque designs. He worked with Fathy and brought mud-architecture into a more practical realm after Fathy's death. Sahel Lamei Mostafa is another protégé and proponent of Hassan Fathy's ideas of sustainable mud architecture. He is an educator and architect from Egypt.

Hasan-Uddin Khan (1999, p.56) said about Hassan Fathy, "He is a reminder to us that there is more to architecture than economics, that what is valuable is looking at our own places and at who we are. I think those lessons, along with involving people in the ritual of building, and embracing a way of being in community, are things we should carry with us." Architectural critic James Steele (1999) credited Fathy with being the earliest sustainability-

oriented architect as he was able to develop a language based on natural materials, natural ventilation and natural systems. Integrating regional traditions with appropriate technology; using socially oriented, co-operative construction techniques; maintaining the primacy of human values in architecture; and establishing cultural pride through the act of buildings are some of Fathy's design principles which can be used when envisioning low-cost self-help housing for poor.

### **Christopher Alexander's Efforts at Self-Help Housing**

Christopher Alexander, mostly known for his theoretical contributions to environmental design, is an architect as well as a licensed contractor. Through his writings and designs, he argues for a new style in architecture, which looks far into the future, yet has its roots in ancient traditions. With Sarah Ishikawa and Murray Silverstein, Alexander devised a new approach to architectural design called pattern language, which can help people to design suitable spaces for themselves (Alexander et.al., 1977). He has designed and built more than 200 buildings in different parts of the world. He has also been involved in a number of low-cost housing projects where he applied his concepts of owner built houses (Alexander, 2008).

In 1969, Alexander, along with his colleagues from Center for Environmental Structure, were invited by the United Nations to participate in a design competition for a community of 1500 houses for Lima, Peru (Alexander, 1969, p.5). Besides planning and designing houses that can serve the needs of individual families, the design team presented sixty-seven design principles that Peruvian architects and individuals constructing houses can

follow. Later, in 1971, Alexander also designed and constructed fourteen low-income prototype houses in Lima, Peru (Grabow, 1983, p.233).

In 1990, Alexander was involved in the design of a community for seventy poor families in Santa Rosa de Cabal, Columbia (Alexander, 2008). Following his principle of self-generated and continually adaptive neighborhoods, he designed the process so that the streets were laid out by the community, and each house was designed and constructed by the family (ibid, p.323). The site model and drawings were generated after laying out stakes marking roads and building sites (Alexander, 2005, p.337). People followed the design sequence generated by Alexander to design, lay out, and construct their dwellings, which consisted of a main house volume, a secondary house volume, verandas, and gardens (Alexander, 2005, p.398). According to Alexander (2005), it was difficult to persuade planners and bank officials about the liability of the project, though the families agreed from the beginning on the idea of individual uniqueness of the houses.

Christopher Alexander's effort in Mexicali, Mexico, to teach families to build their own dwellings is also considered as an important experiment in the field of self-help housing (Alexander, 1985). He argues that, with the rise of mass production of houses, housing has been reduced to profit making and the idea that houses can be loved and cared has been lost (ibid). For Alexander, human feeling and human dignity come first; and housing is a fundamental human process in which social bonds are formed, and people feel proud of what they have achieved (ibid).

Alexander (1985) argues that developments in mass housing may have led to the production of houses more rapidly and economically. But, these identical, machinelike houses, based on the concept of one size fits all, cannot express the individuality of different

families. Instead, the houses look isolated, fail to create human bonds, and thus the neighborhood lacks a sense of community. According to Alexander, the centralized concept of a mass-housing system where houses are designed and built apart from the user cannot be successful: “Every family and every person is unique, and must be able to express this uniqueness, in order to express and retain human dignity. Every family and every person, is part of society, requires bonds of association with other people” (ibid, p. 24). Thus, Alexander argues for a system of production in which individual needs and choices are respected, and where people participate at every level of design and construction. This process creates a residential environment with its own characteristic details that help to maintain individual identity and bring people together in a community: “What we must find is a system of production which is capable of giving detailed, careful attention to all the particulars which are needed to make each house just right at its own level, at its own scale, and which is yet at the same time efficient enough, replicable enough, and simple enough so that it can be carried out on an enormous scale, and at a very low cost” (ibid, p. 40).

Alexander has proposed seven principles for the production of houses, which, he argues, can be applied in any part of the world for housing of any cost in any climate, culture, or density. These seven principles are:

1. The architect builder
2. The builder's yard
3. The collective design of common land
4. The layout of individual houses
5. Step by step construction
6. Cost control



## 7. The human rhythm of the process

In regard to his first principle, Alexander argues for a master-builder who works with the people during design and construction supervision of houses. The concept of master-builder is drawn from the past before architects limited themselves to paper plans. The master-builder that Alexander envisages also has the responsibility to make sure that actual designs are in the hands of the family. However, Alexander's idea of not creating design drawings on paper, but directly laying out the house on site and starting construction with design evolving at every step of construction, may not always be practical, especially when one is seeking a rapid, cheap method of construction. This also takes away the concept of the architect being able to create drawings to visualize the building and its functions ahead of construction to minimize design changes once the construction starts and ensure rapid completion of the construction.

The second principle proposed by Alexander is decentralized local builder's yards, which are places to store tools, equipment, and materials; to carry out experiments with building materials; to provide the architect builder with accommodation and office-workshop; and to later become space to conduct community activities (fig. 4). The builder's yard embodies the building system and the pattern language which families can use to build their houses. Alexander argues that a builder's yard can serve two master-builders who are given responsibility of five to twenty houses each.

In regard to the third principle, Alexander argues that appropriate design and location of common land is the most important factor for holding a neighborhood together. The process of production of houses in Mexicali starts with the layout of the common land. Alexander replaces the grid array of houses by a cluster system (i.e. houses arranged around

common land) which is aimed to provide residents with people effective control and immediate contact towards their common land (fig. 4). Alexander refers to two patterns from his earlier *A Pattern Language* while finalizing communal space, but does not clearly draw on the tradition and culture of people of the Mexicali residents.

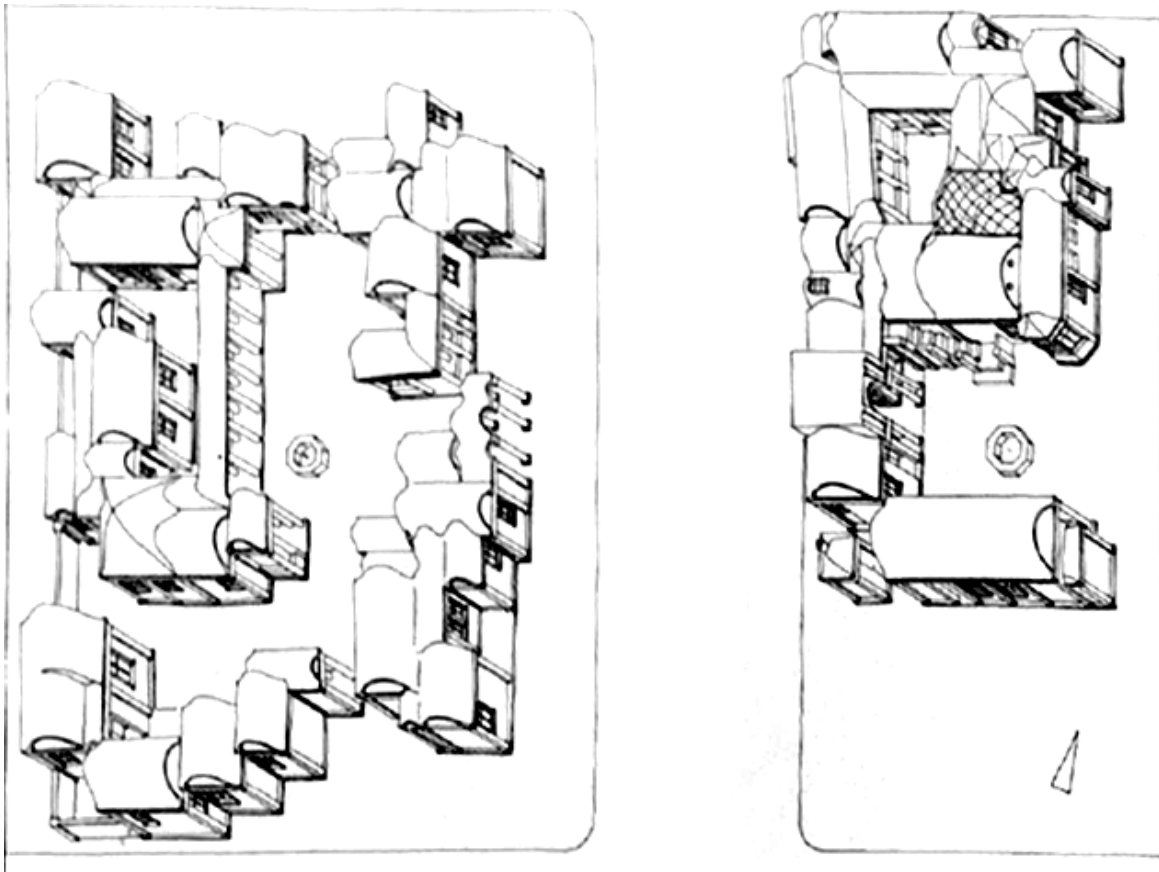

*Figure 4.* Axonometric View of the five houses (left) and builder's yard (right) in Mexicali. Image copyright 1985, Christopher Alexander, p.12.

Alexander's fourth principle is that families lay out their houses for themselves based on a predefined pattern language. He argues that families designing houses for themselves can create an environment with characteristic details that helps maintain a sense of identity. This approach completely contrasts with present forms of housing production based on standard units where houses are design and constructed separately from the future users.

In regard to his fifth principle, Alexander argues that the simplest and most cost-effective way of house construction is to standardize the construction operations. Thus, he proposes a step-by-step construction process divided into twenty-three operations: laying stakes, excavation of soil, placing wall foundations, erecting columns, erecting walls, placing roofs, etc. He further argues that these individual operations can be applied freely to each plan to create a structurally sound building without the need for working drawings for each individual building. According to Alexander, the completion of each construction operation in Mexicali gave a great sense of accomplishment and the fact that the people are themselves involved in the construction adds a sense of joy to the process.

Alexander's sixth principle describes a way of controlling cost while making each house different. In the case of the Mexicali project, the cost of design and permission was not more than that of a typical mass housing project because houses were designed as they were built. Alexander argues that the standardization of construction processes and parallel cost calculation for materials and labors is an effective way of controlling cost. In addition, rather than following higher standards, reducing the construction standards within the acceptable limits required to make the building safe, sound, clean, and beautiful helped to considerably reduce price in the case of the Mexicali project.

In his seventh principle, Alexander describes the construction of houses as a human process: "It is a human process, which allows spirit, humor, and emotion to be part of it and to enter the fabric of the buildings themselves, so that the buildings are felt, in the end, as the products of the rhythm which produced them" (ibid, p. 291). According to Alexander, in the case of the Mexicali project, families contributing their physical labor, people working extra

hours to complete a definite work for each day, people helping each other, and the celebration at the end of each construction operation made the project really special for the people.

The post-occupancy analysis of the Mexicali housing project done by Dorit Fromm and Peter Bosselmann, students who were involved during the construction of the project, shows that the housing had its successes and failures (Fromm, 1985). The families liked their dwellings very much, found them comfortable, fire-resistant, and earthquake-proof. Though the houses looked small and uncomfortable from outside, the families liked the vaulted ceilings and the sense of openness in the interior (ibid). The major success of the project is the sense of autonomy that the families felt in terms of being able to make changes to their homes, which is the major essence of the self-help housing.

Alexander had envisioned the house cluster to be a major element binding the families together, but it did not work as expected. Ambiguous ownership issues of shared land and lack of security and privacy forced families to eventually fence their houses (ibid). The idea of the builder's yard to support a decentralized housing program and later becoming a community center was unsuccessful because only five of the planned thirty houses were constructed. Abandonment of the builder's yard created security issues, as it became the breeding ground for drug dealers and burglars (ibid). Though the residents were relatively satisfied with their individual houses, the concept of a common area failed due to the lack of privacy and security in the area. The five families chosen to live together in a community proved to be incompatible as they didn't have a role in choosing their neighbors. As one of the residents in Mexicali project explained, the cluster concept was perhaps too novel for Mexican culture (ibid, p.89).

The Mexican government viewed the Mexicali project as labor-intensive and time-consuming, and not satisfying their need for rapidly erected modular dwellings. They saw the houses to be naïve and the construction system to be unworkable. Though the government saw the project as a failure, at least for Alexander it was an important design-build model in that he succeeded in delineating, at least theoretically, a practical way to construct self-help housing.

### **Balkrishna Doshi's Efforts at Self-Help Housing**

Balkrishna Doshi is an architect, educator, and researcher from Pune, India. Doshi is a proponent of sustainable architecture based on the vernacular tradition, thus responsive to climate and regional materials. He has played an instrumental role in establishing a research institute, the Vastu-Shilpa Foundation for Studies and Research in Environmental Design, which has done pioneering work in low-cost housing and city planning (Stohr, 2006).

In 1983, Doshi combined the best of sites-and-services and self-help housing models to create a mixed-income neighborhood in Indore, India, also called Aranya community housing (ibid, p.50). This housing represents an archetypal approach to large scale, low-cost dwellings for the poor (Doshi, 1988, p.24). Comprised of 7000 dwelling units in six self-contained neighborhoods and with all the necessary social, economic, and infrastructural amenities; the project aimed at creating a balanced and sustainable community of various socio-economic groups by encouraging co-operation, fraternity, tolerance, and self-help-generated, incremental physical development (Ekram, 1995). Of the 6500 plots, sixty-five

percent were allocated to the economically weaker section (EWS), while upper income plots were sold at a profit which was used to cross-subsidize the EWS plots (Doshi, 1988).

While planning the settlement in six self-contained neighborhoods, Doshi replaced the insensitive-grid layout of the site-and-services scheme with a more suitable, cluster-based plan (Stohr, 2006, p.50). Non-rectilinear alignment of streets with varying widths and turns were provided to accommodate a range of spontaneous human activities (fig. 5). Further, he designed eighty demonstration homes around a basic service core through which he provided an architectural vocabulary suitable to both socio-economic circumstances and climate (Davidson, 1995). In regard to design features and planning of the demonstration houses, room layout, balconies, patios, and other design details were supposed to help owners design and build their houses incrementally and affordably according to their tastes (ibid).

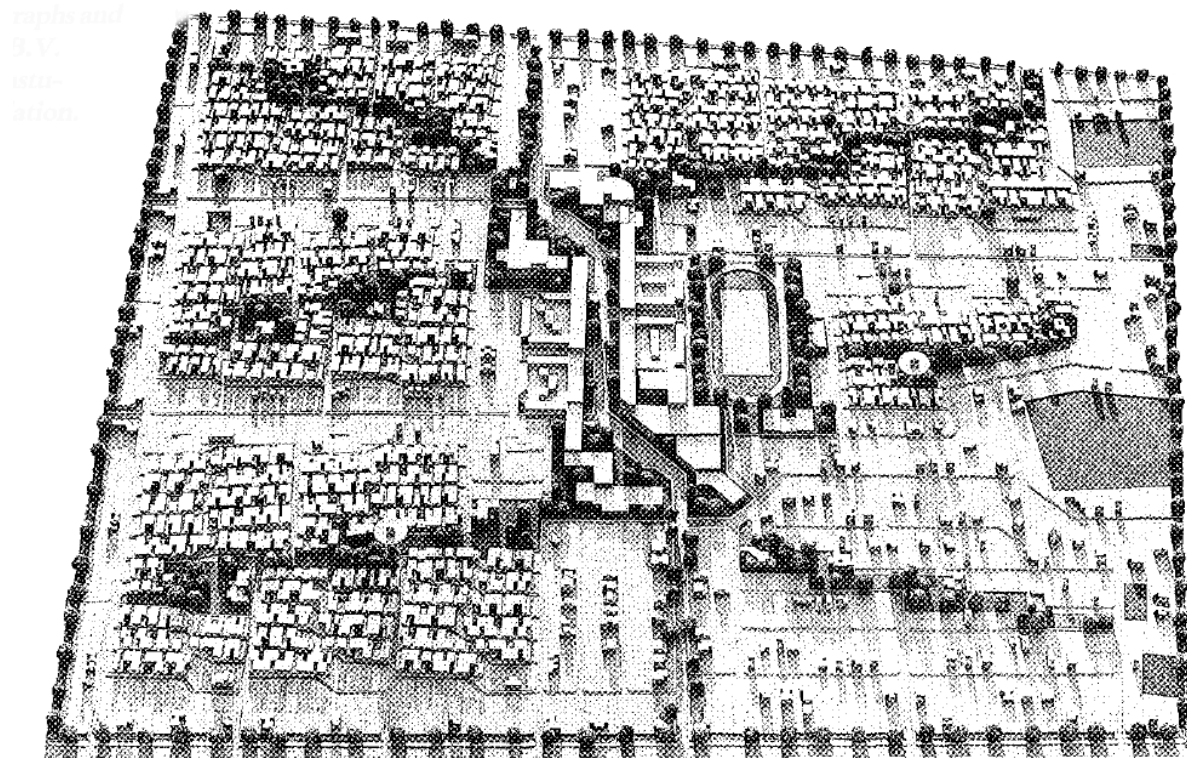

*Figure 5.* Overall site model of Aranya Community Housing. Image copyright 1995, Balkrishna Doshi, p. 24.

## **Laurie Baker's Efforts at Self-Help Housing**

Another significant figure working for the poor in India is Laurie Baker, an Englishman who settled in India in 1945. Baker is best known for his energy-efficient cost-effective architecture and aesthetic sensibility. His contribution to Indian low-cost housing can be paralleled with the work of John Turner in Latin America and Hassan Fathy in Egypt (Bhatia, 1991, p.19). Baker considered himself an architect for the poor and believed that self-help low-cost housing is the right approach to house the millions of homeless. Baker said, "I learn my architecture by watching what ordinary people do; in any case it is always the cheapest and simplest because ordinary people do it. They don't even employ builders; the families do it themselves..... I work primarily with the poor..... My feeling as an architect is that you're not after all trying to put up a monument which will be remembered as a 'Laurie Baker Building' but Mohan Singh's house where he can live happily with his family" (ibid, p.3).

Baker didn't accept the idea that the multiplicity of human needs can be addressed by a standard set of designs and materials. He argued that responsible architecture should address individuals' unique needs which stem from the local environment, the varying cultural patterns, and lifestyles (ibid, p.5). Baker explains, "I can never understand an architect who designs 500 houses all exactly the same..... It's perfectly easy to mix materials on any given site so the possibilities for variety are endless.... If only we didn't level sites and eliminate trees but instead plan to go around them, then we wouldn't get the long monotonous rows to begin with" (ibid, p.40). He skillfully adopted vernacular design patterns, traditional construction methods, and locally available materials to his architecture, which suited the specific problems of his poorer clients (ibid).

Traditional roof, stepped arches, overhanging eaves, skylights, and *jalis* (perforated walls) were all features of Baker's cost-effective architecture (ibid, p.40) (fig.6). He was able to achieve both cost-effectiveness and variations in design by innovative treatment of the building materials during construction. An example would be his innovative bonding techniques for brick walls, which can reduce quantity of materials required while increasing strength (ibid). Further, he did not believe in preparing cumbersome working drawings and had the ability to improvise on the site itself. Besides being low-cost, Baker's architecture is modern in the sense that he used simple construction and minimum materials (ibid, p.58).

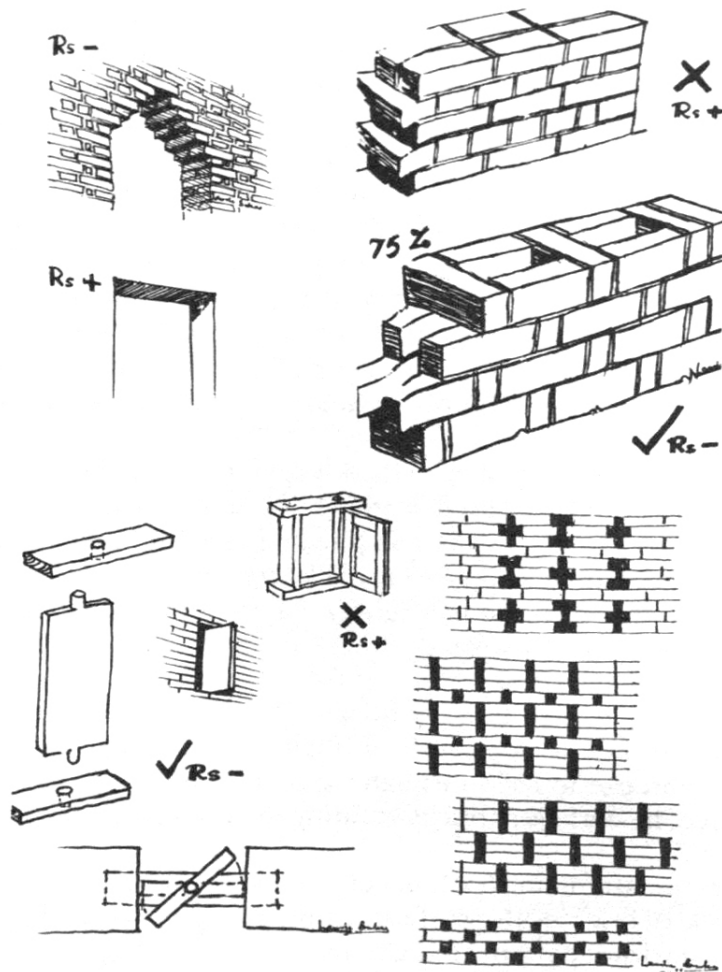

Figure 6. Features of Baker's cost-effective architecture: stepped arch, innovative brick bonding, windows, and jalis. Image copyright 1991, Gautam Bhatia, p. 44.



In 1970, Baker designed and built two demonstration houses for the poor in Trivandrum, India at a cost of 3,000 Indian rupees (equivalent to seventy US dollars) which government engineers and finance experts believed to be impossible (ibid, p.80). The houses, commissioned by the Archbishop of Trivandrum, were Baker's first project in the city (ibid, p.80). Instead of detailed blueprints, he prepared simple sketches which the masons were able to follow without the intervention of the architect. The houses had a cluster of small rooms under a minimum roof area with courtyard as multi-purpose extra private living space. The arrangement of spaces was such that privacy was maintained even with few internal doors. The cost was reduced by using shallow excavation for the foundation, exposed half-brick thick walls with jali windows, and roofs of wood with traditional tiles (ibid).

In 1974, Baker was involved in the construction of low-cost housing for storm-displaced fishermen in Trivandrum (ibid, p201). In building a more permanent, storm-resistant village with labor shared by the community, he used exposed half-brick walls with sloped concrete roofs. He replaced the long rows of conventional housing by staggering dwelling units so that their courts would catch breezes and offer sea views. In addition, each house has small in-between private rectangular lands for drying fishing nets and children's play (ibid). In short, a creative use of local materials, adaptation of vernacular tradition with modern technology, climate-responsive design, innovative space planning, and simple construction with community involvement are some of the main features of Baker's cost-effective energy efficient-architecture.

## **Conclusion**

With housing scarcity for the poor as one of the dominant world problems today, the efforts of self-help housing pioneers like Hassan Fathy, Christopher Alexander, Balkrishna Doshi, and Laurie Baker are invaluable. They have taken the efforts of self-help housing for the millions of poor to creative but practical realizations. All these architects have argued for involving people in the design and construction of their houses; developing design and construction from vernacular tradition; and using local materials that are climate-responsive. As I will suggest in the next chapters, their ideas and concepts have central relevance in finding the right approach to house the ex-Kamaiyas of western Terai regions of Nepal.

Hassan Fathy always believed that adaptive use of vernacular traditions with modern technology is an important aspect of low-cost housing that can respond to local culture and climate, while fulfilling unique individual needs. Fathy, during his low-cost housing work in New Gourna, was able to recognize the traditional skills of people to build vaults and domes in mud brick. He was able to build the entire structure of the Gourni's houses out of mud, a material that is available everywhere for free. This made the houses much cheaper as well as aesthetically more pleasing.

Fathy never took the modernist approach of residential towers and prototype mass housing. Rather he rigorously designed each house differently according to the unique needs of individual families. In addition, using socially oriented and co-operative construction techniques along with local materials, he made involvement of people to build their dwellings possible, which in turn reflected individuals' uniqueness, social customs, and culture.

In the case of low-cost housing for the ex-Kamaiyas, involving people in design and construction by using simple construction techniques and materials based on traditional

architecture can be an important approach. The ex-Kamaiyas, who are from the Tharu ethnic group, have their unique vernacular architecture, and reviving traditional buildings skills is an important consideration as it makes their involvement in the design and constructions of their dwellings more practical. It can help the ex-Kamaiyas establish their lost socio-cultural pride while creating architecture which has the primacy of human values. In addition, the self-help approach as described by Fathy can replace the prototype mass-housing approach.

Like Hassan Fathy, Christopher Alexander always seeks an architecture that can make people feel at home. He believes that housing is an elemental human process in which social bonds are created and human dignity is established (Alexander, 1985). Thus, Alexander is arguing for a participatory housing-production system in which individual needs and choices are addressed. Among the seven principles that he explains in *Production of houses*, four are especially relevant in the case of low-cost housing for the ex-Kamaiyas: the builder's yard, the collective design of common land, the layout of individual houses, and Step by step construction.

Alexander's concept of decentralized local builder's yards can be adopted as a single builder's yard serving a large housing project of fifty to one-hundred houses. Besides serving as a place to store tools and materials, office, and workshop, the builder's yard can be a demonstration building for the ex-Kamaiyas. It can demonstrate design principles, construction techniques, and materials to be used during design and building of individual houses. After completion of the project, the builder's yard can be used for community facilities like a school, gathering hall, and even as training center to teach ex-Kamaiyas livelihood skills.

Alexander argues for the involvement of community during the design, planning, and layout of common land as it the element with holds a neighborhood together. Common land is an important aspect of planning ex-Kamaiya communities as it is a place which brings people together for interaction and enhances life. In addition, involving community can help create a sense of belonging and care towards the common land.

The concept of involving families in the design, layout, and construction of houses based on a predefined pattern language, though perhaps utopian, is relevant, especially in the case of rural communities. The ex-Kamaiyas, with their own vernacular architecture, have a unique design sense and construction skills. Thus, by involving the ex-Kamaiyas in the building process, their construction prowess can be utilized, which gives their houses a stronger sense of identity and they can feel a sense of autonomy.

Another important argument that Alexander makes for low-cost housing is the standardization of the construction process by dividing construction into various steps. Rather than creating monotonous rows of standard housing blocks for the sake of economy, a standard process of construction can create houses according to the unique needs of individuals and still remain cost-effective. He further argues that completion of each step brings a sense of joy to the family. Thus, most of Alexander ideas for self-help housing are replicable in the context of low-cost housing for the ex-Kamaiyas in Nepal.

Balkrishna Doshi's innovative combination of site-and-services and self-help housing to create a mixed-income community in Indore, India, represents an archetypal approach to low-cost housing. In contrast to Alexander, Doshi didn't involve the community during the layout of the site and services, but he did design and construct eighty demonstration houses to help families design, plan, choose materials, and build their own houses. Like Fathy, Doshi

based his approach on features of the socio-cultural and economic milieu, though he allowed freedom of design, material choice, and construction. His concept of incremental self-help housing, which allows families to expand and decorate their houses according to their taste and budget, is replicable in the context of low-cost self-help housing for the ex-Kamaiyas. However, I see the possibility of involving families during the design and planning of plots, streets and community spaces.

Like Fathy and Alexander, Laurie Baker also opposed mass housing as a means for housing the poor. He believed in the creativity of ordinary people to build responsible architecture, which meets individuals' unique requirements while remediating the monotony of standardized housing. Baker's innovative use of local materials and his adaptive use of traditional building techniques can be replicated in the Nepalese context. Most of his works are in Kerala, India, which has a hot humid climate similar to that of the western Terai regions of Nepal. Thus, Baker's low-cost design features like stepped arches, overhanging eaves, jalis, skylights, and innovative brick bonding can be replicated in the low-cost housing for the ex-Kamaiyas.

## **Chapter 3:**

### **Understanding Vernacular Architecture and the Ex-Kamaiyas**

Vernacular architecture is a result of thousands of years of accumulated expertise, and uses locally available materials, moderates climate through energy from nature, and arranges spaces according to social and cultural requirements (Fathy, 1986, p. xx). Affordability is another aspect of building construction that vernacular architecture addresses. Since it uses local materials, indigenous technology, and native manpower; it incorporates economical building methods. Thus, adaptive use of vernacular architecture to fit with modern requirements is an appropriate approach to low-cost housing.

People have been constructing dwellings from prehistoric times using vernacular tradition and without any aid from government, architects, or engineers. With the failure of modernist public-housing to address the problem of low-income housing shortages, the idea of self-help housing became important (Ward, 1982, p. 7). The concept of owner-built houses becomes more relevant in the context of low-cost housing for poor who have traditional design and construction skills.

The sense of autonomy, pride, and responsibility that families feel by constructing their houses themselves are important aspects of self-help housing. John F. C. Turner (1976) wrote that “When dwellers control the major decisions and are free to make their own contribution to the design, construction or management of their housing, both the process and the environment produced stimulate individual and social well-being. When people have no control over, or responsibility for key decisions in the housing process, on the other hand, dwelling environments may instead become a barrier to personal fulfillment and a burden on the economy.”

Involving a human community in the design and construction of their houses and learning from vernacular architecture are two major issues brought forward by the pioneers of low-cost self-help housing reviewed in chapter 2. Hassan Fathy always saw local people as creative human resource and vernacular tradition as an inspiration for creating sustainable communities (Fathy, 1993). Similarly, Laurie Baker and Balkrishna Doshi have always believed in the creative potentials of the people. Yet again, Christopher Alexander (1985), in *The Production of Houses*, argues for a new process in low-cost housing where the involvement of households creates a living community with unique architecture. Thus, understanding vernacular building tradition, socio-cultural life-style, and building skills of the ex-Kamaiyas were an important aim in the field-study component of this thesis.

### **The Tharus' Vernacular Architecture**

To understand the architecture and landscape of a place, its socio-cultural and environmental determinants, material traditions, and space layouts and usages must be analyzed. The ex-Kamaiyas, ninety-five percent of whom are from the Tharu ethnic group, have their unique socio-cultural tradition and regional environment, which guide their architecture and landscape (Sharma, 1998). During my field visit in summer 2010, I analyzed Tharu settlements near Gulariya, in Bardiya, a western Terai district of Nepal. The Tharus living in these settlements have not suffered from the Kamaiya system and are not identified as ex-Kamaiyas.

Tharu settlements usually consist of twenty to thirty families, with buildings clustered together around open courts, surrounded by flat rice fields (fig. 7). These units sharply contrast with the non-Tharu houses, scattered haphazardly in the middle of rice fields. The flat landform means that there is no obstruction to solar radiation and air movement due to landform. Vegetation, usually shrubs about one to two meters high and trees nine to fifteen meters high, is concentrated along the periphery of the settlement. The vegetation is not close enough to contribute to the air-flow diversion or to solar radiation blockage. However, this vegetation and rice-field irrigation channels increase humidity and shape a micro-climate within each settlement.



*Figure 7.* Cluster planning of typical traditional Tharu settlement in Bardiya, a western Terai district of Nepal. Image retrieved October 3, 2010 from <http://maps.google.com/maps?hl=en&tab=w1>.



The Terai regions of Nepal have a hot-humid climate with a mean maximum temperature of about hundred degree F and a mean maximum humidity of ninety-nine percent. Since the summer months are hot and these houses are not designed to withstand a cold climate, even a mean minimum temperature of forty degree F has severe consequences in the absence of any active or passive heating systems. While it is quite windy during March and April, a mild and regular wind blows throughout the year. The rainy season often results in flooding, which is a big problem for traditional Tharu houses that do not cope well in flood water.

Tharu houses are usually rectangular in plan with the main entry faces east or west (fig. 8). While each household usually has separate blocks for sleeping space, toilet, and cattle shed, more affluent families have multiple sleeping blocks and separate buildings for granary and kitchen. A new house is constructed when a building becomes too small to shelter all members of a family. As families expand, existing buildings are not usually enlarged; rather, separate dwellings are constructed near the existing family house, provided there is enough space available.

In houses which do not have separate buildings for kitchen and granary, earthenware silos play an important role. These silos, made by Tharu women of mud, husk, and cow dung plaster, are used for storing grain and also serve as a partition wall between the kitchen and other rooms. The verandah is an important element in the design of the main housing block, and is a traditional response to a traditional hot-humid climate. These blocks are arranged around an open unpaved courtyard which is used for drying crops, a children's play area, community gatherings, and a sleeping area during hot summer nights (fig. 8). At times, a single courtyard is shared by more than one family. These one or two-story buildings are not,

however, located close enough to provide mutual shading, but they do facilitate wind-flow through the buildings.

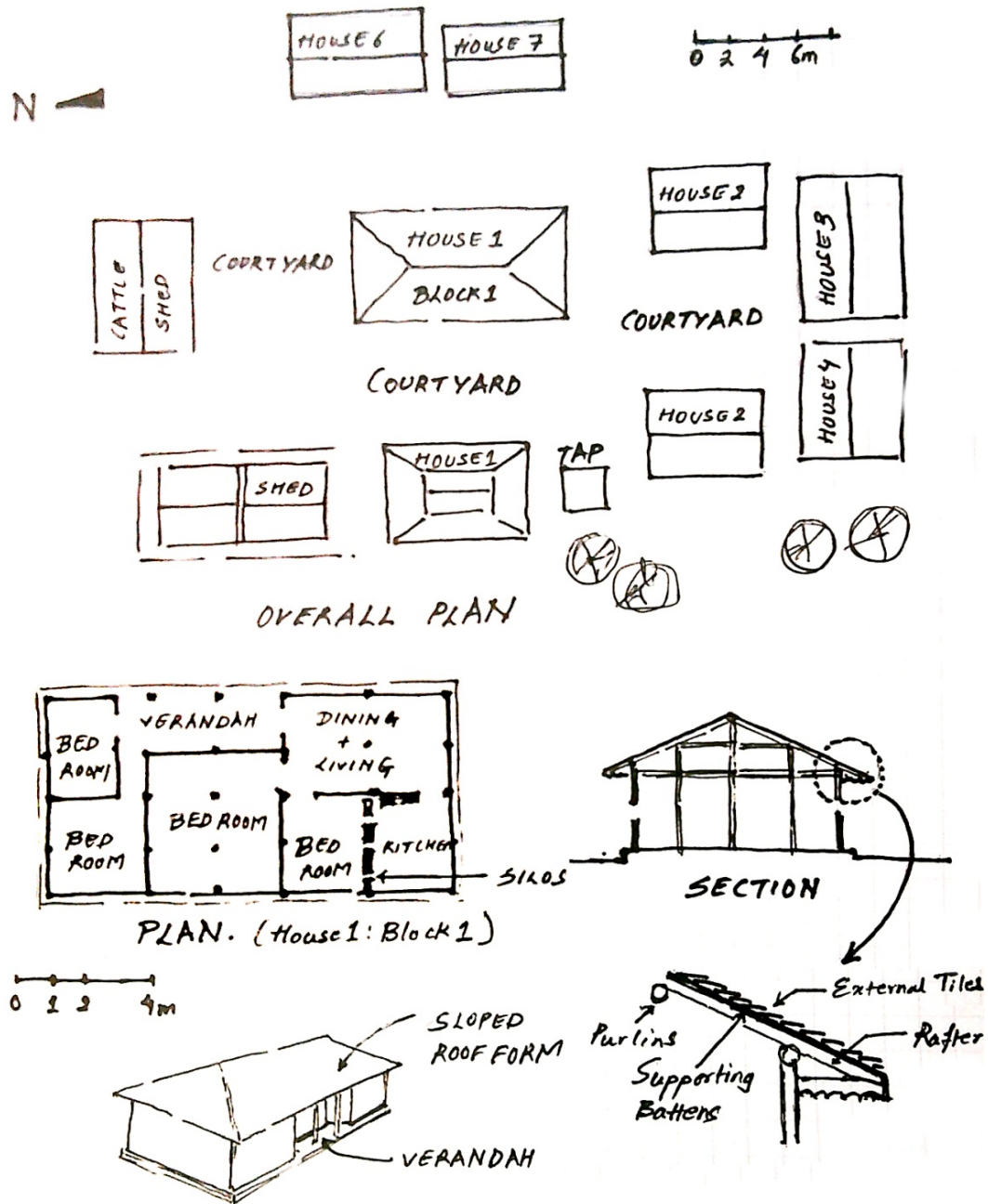

Figure 8. Author's sketches of a traditional Tharu house and its surrounding in Bardiya, a western Terai district of Nepal. Source: Data collected by author, July, 2010.

The Tharus have an important ritual regarding the proportions of a building's plan and its measurement units. Their measurement unit is called *haat* which means "hand." One haat is the length from the elbow joint to the tip of the middle finger of a Tharu male. Before the Tharus lay out a building plan, the length and breadth of the plan, measured in haat, are added and then multiplied by seven. The resulting number is then divided by eight to get the remainder. The attempt is to get an odd number remainder like one, three, five, or seven; even number remainders are avoided. The Tharu myth is that a remainder of one implies *Anand*, which means "comfort"; a remainder of three implies *Dhanwan*, which means "prosperity"; while remainders of five and seven imply *Santan*, which means "children." On the other hand, even remainders of two, four, or six imply *Durbhagya*, which refers to "misfortune." Similarly, a remainder eight means that the house, if built, will not be suitable for living.

Like many rural population around the world, the Tharus are skilled in traditional construction techniques. When a new house is built, all available members of the community, both men and women, participate in the construction. Men are responsible for building the foundation, wall structure, and roof, while women partake in plastering and making earthen fire-stoves for the kitchen and earthen silos. The Tharus generally construct their houses during the dry months, and the construction period for a typical Tharu house does not exceed six weeks.

Materials for construction are procured from the natural environment and include wood, bamboo, reed grass, and mud. Wood is acquired from nearby forests, while reed grass and bamboo are available through personal or community bamboo gardens. In addition, farming byproducts like rice husk and cow dung are used as construction materials, which all contribute to the sustainable nature of Tharu architecture.

After the plan of the house is arranged, a rammed-earth foundation is prepared. The plinth is usually raised about eight to ten inches from the ground and finished with a mixture of mud and cow dung laid on an insulation layer of rice husk. Wooden posts are placed which support the wattle-and-daub system of reed grass and bamboo, plastered on both sides with a mixture of yellow ochre clayey soil, rice husk, and cow dung. The light ochre colored walls have a smooth texture interrupted by vertical and horizontal support projections (fig. 9). These walls are about an inch thick, and have low thermal capacity and good insulation, which is suitable for a warm-humid climate. Sometimes, the Tharus also construct their buildings with sun-dried mud bricks.



*Figure 9.* Author's photograph of a Tharu house showing small fenestrations, horizontal members of wattle and daub wall, and roof form, July, 2010.

The house fenestration pattern seems to be governed by local rituals rather than any daylight or climatic needs. Windows are usually small and unglazed with or without shutters. The total area of windows is very small with respect to the total external wall area (fig. 9).

Thus, house fenestration has minimal effect on air movement and ventilation, and minimal solar radiation reach inside. Both windows and doors are constructed either from wood or bamboo. Tharu houses have distinct sloped roofs with large overhangs to shade and protect the exterior walls from sun and rain. Bamboo is used as rafters and purlins supporting the roof of thatch or *khapada*, a traditional mud tile used for roofing (fig. 10).



*Figure 10.* Author's photograph showing intercepting traditional roof tiles, *khapada*, with mud in-between, July, 2010.

The houses are usually not occupied for the entire day as the Tharus prefer to reside on a shaded verandah during the hot summer and in a sunny courtyard during winter months. The Tharus stay inside their houses only during meals and at night. Tharu men work in the farm fields, while the women are responsible for household work and maintenance of the houses. The inside of the house is cleaned daily, and a fresh coat of clay is applied to the floors every week. Two to three times a year, floors, outside walls, partitions, courtyards, and silos are recoated with mud, husk, and cow-dung plaster.

## **Low-cost Housing Approaches of the INGOs**

Among the poorest people of Nepal, the ex-Kamaiyas were victims of the Kamaiya system of bonded labor. Even after the declaration of freedom from slavery in 2000, they have not been able to establish themselves socially and economically. Due to lack of support for basic human needs like food, shelter, and jobs, a majority of ex-Kamaiyas still live miserable lives.

The Nepalese government and some international non-governmental organizations (INGOs) are working to provide them housing, economic-livelihood possibilities, and education. The government promised to provide lands for all the landless ex-Kamaiyas. However, ten years after their liberation, many are still waiting to acquire lands from the government. Those who have received lands live in unhygienic and temporary shelter without resources to build permanent dwellings. There have been a lucky few who live in housing provided by INGOs.

There are two main INGOs -- ActionAid Nepal (AAN) and Habitat for Humanity (HFH) -- working to provide low-cost housings for the Nepalese ex-Kamaiyas. Since this thesis aims to serve as a guide for these INGOs to provide better housing for the ex-Kamaiyas, I analyzed the housing provided by AAN in the ex-Kamaiya villages of Tesanpur and Janatanagar; and by HFH in the ex-Kamaiya village of Bhuri Gaun.

ActionAid (AA) is an international development organization founded in the United Kingdom in 1972. ActionAid Nepal (AAN) is a secular, non-political organization which has been working with the poorest and disadvantaged people of Nepal since 1982. Its aim is to eradicate poverty by empowering the poor. In 1990s, AAN played a major role in the movement that finally abolished the Kamaiya system of bonded labor in Nepal. Since then

AAN is working with local partner organizations to build 5000 houses, of which 1000 have already been built.

AAN has constructed houses for seventy-eight ex-Kamaiya families in Tesanpur; and, in Janatanagar, it has constructed houses for twenty-six more vulnerable families out of 112 households. The houses provided by AAN are single-story brick structures with an area of 330 square feet (figs. 11 & 12). The length and breadth of the buildings are twenty-two and fifteen feet respectively. According to AAN, a standard design has been repeated to reduce the buildings' cost, and for the ease of construction and cost management. The tentative cost for a single building is 75,000 Nepalese rupees (equivalent to 1000 US dollars). This amount, however, does not include other infrastructural elements such as toilets, access, electricity, water, and drainage.



*Figures 11 & 12. Author's photographs showing one-story brick house for ex-Kamaiyas in Tesanpur provided by AAN, July, 2010.*

The main entrance to the house faces east with a small multi-purpose veranda. In most of the houses, the available space is divided into two rooms used for sleeping and storing grains. Following traditional Tharu architecture, all families have constructed a separate building for kitchen use. The operable windows, though small, help to ventilate the rooms.

The houses have two-foot deep brick foundations, which are built up to plinth level with a three-inch damp-proof course (DPC) one foot above the ground (fig. 13). The building has a frame structure of nine-by-nine-inch brick columns with one steel rod as reinforcement and half-brick thick walls with cement mortar. The windows and doors are made of locally available timber. The sloped-roof structure is made of cement tiles supported by wooden rafters. Many ex-Kamaiya families have cement-plastered their houses at their own expense (figs. 11 & 12).

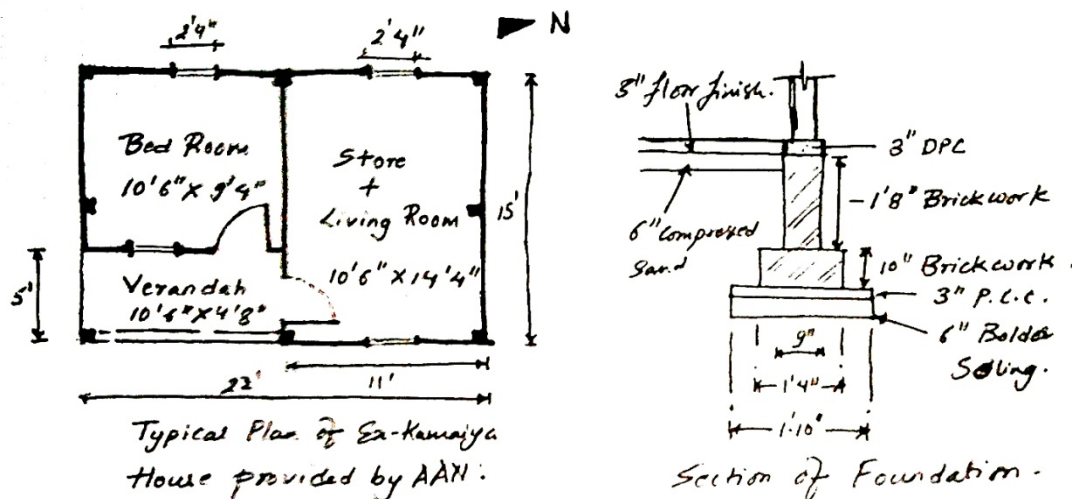

Figure 13. Author's sketches of floor plan and foundation of ex-Kamaiya house provided by AAN in Tesanpur. Source: Data collected by author, July 2010.

Habitat for Humanity (HFH) is another INGO working to provide housing for the poor in Nepal. HFH was originally established by an American couple, Millard and Linda Fuller, who first introduced the concept of volunteering to help with low-cost self-help housing projects. This approach accelerates the construction process and lessens the burden on already struggling families. Ex-Kamaiyas of western Nepal have been one of the target groups of HFH.



The low-cost housing approach of HFH is different from that of AAN in that HFH emphasizes vernacular construction techniques using local materials. The houses constructed by HFH in Bhuri Gaun for twenty-two ex-Kamaiya families are simple one-story wood, bamboo, and cement buildings with an area of about 300 square feet (figs. 14 & 15). As has AAN, HFH has used the same standard building for all eighteen households, and the total cost is around 70,000 Nepalese rupees (equivalent to 970 US dollars). Though the floor plan of houses provided by HFH is similar to that of AAN, the construction approach is completely different in that local materials are important.

Indigenous bamboo is suitable for house construction as it grows fast and is durable and easy to use as well as being environment friendly. While constructing these low-cost houses, HBH have made extensive use of bamboo for doors, windows, posts, mats for walls and ceiling, and fencing. HBH has its own bamboo treatment center in Chitwan, a central Terai district of Nepal, where bamboo is chemically treated, cut to size, and sent to construction sites. The ex-Kamaiya houses in Bhuri Gaun are made with bamboo wall panels on a timber frame finished with cement plaster.



*Figures 14 & 15. Author's photographs showing one story bamboo and timber house for ex-Kamaiyas in Bhuri Gaun provided by HFH, July 2010.*

The HBH houses have a brick foundation with a plinth one foot above the ground. Vertical wooden posts are placed at two-and-half-to-three feet apart supported by horizontal members at sill and lintel level, thus forming a wooden frame-work for bamboo panels, which are then plastered on both sides and painted white (figs. 14 & 15). Each room has two windows that are placed between wooden posts, an arrangement that helps with cross ventilation. The sloped roof is made of corrugated galvanized iron (CGI) sheets and placed on wooden purlins and rafters supported by the wooden framework.

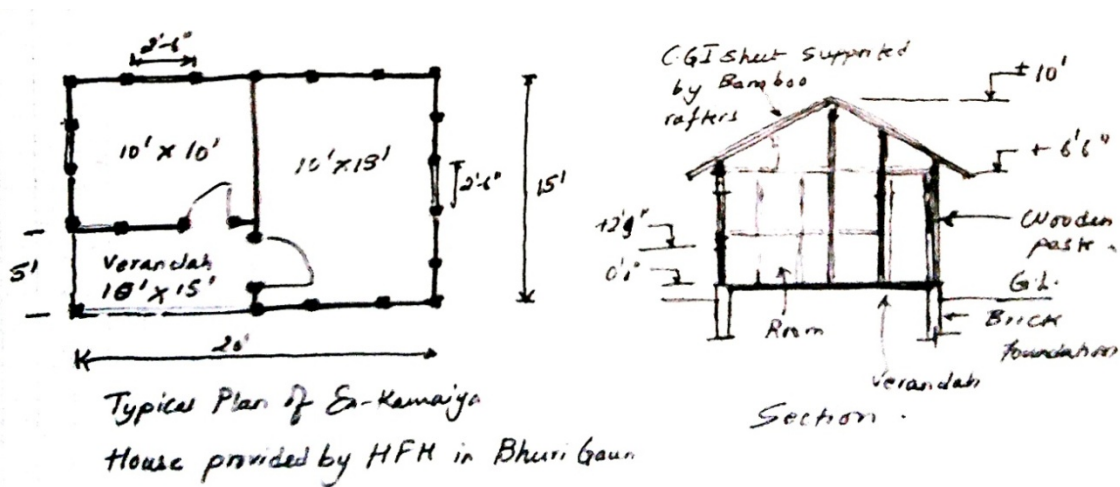

Figure 16. Author's sketches of floor plan and section of ex-Kamaiya house provided by HFH in Bhuri Gaun. Source: Data collected by author, July 2010.

The main problem with these houses is that they follow the modernist approach of mass housing where a standard dwelling unit is repeated without considering the unique requirements of individual families. The families have no involvement in the planning and layout of the plots, or in the design of the individual houses. The individual families' role in this approach to self-help housing is limited to that of unskilled laborers.

After observing these ex-Kamaiya communities, I conclude that there is lack of coordination between the government providing lands and the INGOs providing houses. AAN and HFH do not play any role in the layout of plots. The government divided the plots in a

grid-iron pattern accessed by wide roads, completely ignoring the traditional cultural landscape. In traditional settlements, the dwelling units are clustered around an open courtyard which serves as a gathering place for interaction, space for drying crops, and a play area for children. Thus, the common courtyard is an important aspect of traditional settlement as it brings together community members and creates human bonds. Overall, the government's neglecting this traditional settlement pattern has resulted in poorly planned neighborhoods without any sense of community.

In regard to the individual houses, the INGOs have followed the approach that one size fits all for constructing houses rapidly at minimal cost. However, the identical, machinelike houses have failed in many ways to respond to human feelings and dignity. In addition, the houses are too small for larger families as the size remains the same, whether the family is composed of two people or ten.

In the case of houses built by AAN, contemporary building materials like brick, cement, and concrete are used, which does not take into consideration traditional construction techniques and materials. Because of the use of contemporary building techniques and materials, ex-Kamaiyas' traditional construction skills remained unused. This limited the ex-Kamaiyas to working as unskilled laborers and required skilled workers from elsewhere. The brick foundations, which nearly cost one third of the cost of each house, can be replaced by adaptive use of a traditional rammed-earth foundation. The half-brick thick walls without horizontal ties make the houses vulnerable to earthquakes. The modern roof with concrete tiles does not function as efficiently as traditional thatch or a khapada roof. The concrete tiles absorb heat quickly and reradiate that heat into the interior spaces making rooms too warm to stay in during summer months.

The houses built by HBH have effectively adopted the traditional wattle-and-daub bamboo wall with mud plastering to bamboo wall panels on timber framing with cement plaster on both sides. However, the cement plaster can be replaced by more indigenous materials like lime and clay. The CGI sheets on the roof are the major problem in these houses because these sheets offer minimal thermal resistance. In summer, the rooms are excessively hot, while during the winter, the rooms are excessively cold.

### **The Ex-Kamaiyas and their Housing Requirements**

With the rise in interest of self-help low-cost housing, the poor are seen no longer as a burden but as a resource (Stohr, 2006). In addition to reducing the cost of housing, involving families in their housing gives them an opportunity to express their unique aesthetic taste. In that regard, Alexander (1985) has taken the concept of self-help to a new level by involving the families in a Mexicali housing project in the creative process of dwelling design and planning. Involving families in dwelling design and construction is an important aspect of low-cost housing for the ex-Kamaiyas as presented in this thesis.

More precisely, the central aim of this thesis is to provide guidelines for the production of low-cost housing for the ex-Kamaiyas, an effort which can ensure the active involvement of ex-Kamaiyas in the housing process to create attractive low-cost houses expressing families' individualities. In preparing the guidelines for such houses, I interviewed the ex-Kamaiyas in the settlements of Tesanpur, Janatanagar, and Bhuri Gaun to understand their housing requirements, socio-cultural habits, and traditional construction skills. Interviewing the ex-Kamaiyas is the first step towards their involvement in the housing process.

More specifically, during my field visit in July 2010, I interviewed ten ex-Kamaiya families in Tesanpur, six ex-Kamaiya families in Janatanagar, and four ex-Kamaiya families in Bhuri Gaun. Among the total of twenty families interviewed, nineteen families were from the Tharu ethnic group, a fact which indicates that the Tharus predominantly suffered during the Kamaiya system of bonded labor. After liberation in 2000, each of these ex-Kamaiya families was provided 0.4 acres of lands, and they have been living in the houses provided by AAN and HFH for the last three or four years.

The ex-Kamaiyas who are from the Tharu ethnic group have the tradition of breaking away from larger family units and living in detached families. Thus, for the twenty ex-Kamaiya families interviewed, the average number of family members is four (table 1). They make their living by farming and doing labor work in the nearby town of Gularia. Some ex-Kamaiyas, who took training in motorcycle repairing and plumbing organized by INGOs, work as skilled laborers. However, most of families can't make enough money to make a living, and there is a trend of ex-Kamaiya men going to larger cities in India for work, a situation which, at times, leaves the women and personal property vulnerable. Thus, economic sustainability and security of the families are important issues which need to be addressed when building housings for the ex-Kamaiyas.

The families actively participate in community organized programs and gather to celebrate local festivals in these planned communities; but, unlike in the traditional cluster settlements, these linearly planned, low-density settlements do not facilitate adequate interactions among villagers or a sense of community. The absence of a local market and primary schools does not contribute to daily chance encounters among people either. Sixty percent of the ex-Kamaiya interviewees agreed that, compared to the current low-density

settlements, in which they now live, the traditional cluster settlements generated a better sense of community and offered better security because houses were closely sited. Thus, the neighbors were near in case of any emergency. However, forty percent of the interviewees had hygiene issues in regard to traditional settlements and are appreciative of wide roads, a cleaner environment, and the openness of the current linearly-planned settlement (table 1). These new settlements also have electricity; hand pumps to pull out underground water; and a pit system for sanitation.

The houses provided by AAN and HFH, built using contemporary construction techniques, are sturdy and require less maintenance compared to the traditional Tharu house. However, many ex-Kamaiya families found these two-room houses too small in relation to their family space requirements. Many families, especially in Tesanpur village, have made additions to these houses using traditional construction technique and local materials like bamboo, mud bricks, and khapada tiles (figs. 17 & 18). Most of the families are using the space additions as a granary, while the two rooms and verandah are used for sleeping and living purposes. In addition, all the families have a separate mud and bamboo structure for the kitchen (fig. 19). The ex-Kamaiyas still use traditional firewood mud stove for cooking and prefer to have their kitchen in a separate building.



*Figures 17 & 18. Author's photographs showing the additions made by ex-Kamaiya families to the houses provided by AAN in Tesanpur village, July, 2010.*

Table 1. Summary of Interviews with ex-Kamaiyas												
S. No.	Name of Place	Building Type	Family Members	Daily Activities	Involvement in Construction of their house	Participation in skill development programs	Modern house or traditional Tharu bldg.	Space Requirements	Cluster or linear planning	Cooking Method	Defects of current house	Five things you want to improve in current house and community
1	Tesanpur	Brick + Plastered	4	Farming	Yes (as unskilled labor)	No	Modern	Bed Room, Kitchen, Store, Toilet, Cattle Shed	Cluster (Traditional)	Mud Stove	Cracks in roof tiles. Small Windows.	2-Story Construction. Add kitchen, Large Windows.
2	Tesanpur	Brick + Plastered	5	Farming, Labor	Yes (as unskilled labor)	Motorcycle Repair. (Not useful)	Modern	2 Bed Rooms, Kitchen, Store, Toilet, Cattle Shed	Cluster (Traditional)	Mud Stove	Cracks in roof tiles. Small Windows.	More Rooms, Roof Tiles, Large Windows
3	Tesanpur	Brick + Plastered	4	Farming, sometime labor-work in India	Yes (as unskilled labor)	Motorcycle Repair. (Not useful)	Modern	Bed Rooms, living room, Verandha, Kitchen, Store, Toilet, Cattle Shed	Cluster (Traditional)	Mud Stove	Cracks in plaster and roof tiles. Small area.	2-Story Construction. Add kitchen and bed rooms. Better toilet.
4	Tesanpur	Brick + Plastered	4	Farming, Labor	Yes (as unskilled labor)	No	Modern	Bed Rooms, Kitchen, Store, Toilet, Cattle Shed	Linear open as current planning	Mud Stove	Cracks in roof tiles. Small area.	Add kitchen and bed rooms. Better toilet.
5	Tesanpur	Brick + Plastered	1	Farming, Village Watchman	Yes (as unskilled labor)	No	Traditional if well built	Current House is ok. Kitchen and toilet are separate.	Linear open as current planning	Mud Stove	Don't like roof tiles.	Change roof to flat concrete.
6	Tesanpur	Brick + Plastered	2	Farming	Yes (as unskilled labor)	No	Modern	Current House is ok. Kitchen and toilet are separate.	Cluster (Traditional)	Mud Stove	Likes Everything.	Better Kitchen with modern stove, Toilet.
7	Tesanpur	Brick + Plastered	6	Farming, sometime labor-work in India	Yes (as unskilled labor)	No	Modern	Bed Rooms, Kitchen, Store, Toilet, Cattle Shed	Cluster (Traditional)	Mud Stove	Small area, small windows.	Store and kitchen separate, increase window .
8	Tesanpur	Brick + Plastered	6	Farming, labor work, son in India	Yes (as unskilled labor)	Motorcycle Repair. (Not useful)	Modern	2 Bed Rooms, Living Room, Guest Room, Kitchen, Store, Toilet, Cattle Shed	Linear open as current planning	Mud Stove	Small area, not enough windows.	Add store, kitchen, 2-storey, increase window, add fan.
9	Tesanpur	Brick + Plastered	4	Farming, Plumbing	Yes (as unskilled labor)	Plumbing (Useful)	Modern	2 Bed Room, Kitchen, Verandha, Store, Toilet, Cattle Shed	Cluster (Traditional)	Mud Stove	Cracks in tiles, leaks during rain, small area.	Space addition, make flat concrete roof.
10	Tesanpur	Brick + Plastered	5	Farming, Plumbing and other Labor works	Yes (as unskilled labor)	Plumbing (Useful)	Modern	2 Bed Room, Living room, Kitchen, Store, Toilet, Cattle Shed	Linear open as current planning	Mud Stove	Small area, cracks in tiles, Plastering not provided.	2-story, add kitchen with modern stove.
11	Janatanagar	Brick	4	Farming, Village Watchman, Son in India	Yes (as unskilled labor)	Cattle husbandry	Modern	2 Bed Rooms, veranda, living room, kitchen, Store, Toilet, Cattle Shed	Cluster (Traditional)	Mud Stove	Cracks in roof tiles, no toilet, small area.	Change roof tiles, add rooms, separate kitchen
12	Janatanagar	Brick	5	Farming, 2 sons in India	Yes (as unskilled labor)	No	Modern	Bed Rooms, living room, kitchen, Store, Toilet, Cattle Shed	Cluster (Traditional)	Mud Stove	Cracks in roof tiles, no toilet, small area.	2-story, Change roof tiles, add rooms, toilet.
13	Janatanagar	Old Tharu House	3	Farming, Labor-work	Yes	No	Modern	Bed Rooms, Kitchen, Store, Toilet, Cattle Shed	Cluster (Traditional)	Mud Stove	Walls not firm, leakage, low plinth, old house.	Construct a new concrete house.
14	Janatanagar	Brick	4	Farming, Labor-work	Yes (as unskilled labor)	No	Modern	2 Bed Rooms, veranda, living room, kitchen, Store, Toilet, Cattle Shed	Linear open as current planning	Mud Stove	Cracks in roof tiles, no toilet, small area.	Change roof tiles, add rooms, plaster, separate kitchen and toilet.
15	Janatanagar	Brick	3	Farming	Yes (as unskilled labor)	Mid wife Training	Modern	Bed Room, Kitchen, Store, Toilet, Cattle Shed	Linear open as current planning	Mud Stove	Cracks in roof tiles, not plastered, no toilet, small area.	Change roof tiles, add rooms, plaster, separate kitchen and toilet.
16	Janatanagar	Brick	4	Farming, 1 son in India	Yes (as unskilled labor)	No	Modern	2 Bed Rooms, veranda, living room, kitchen, Store, Toilet, Cattle Shed	Cluster (Traditional)	Mud Stove	Small windows, no plaster, no toilet, small area.	2-story construction, add separate kitchen & toilet, larger windows, plaster.
17	Bhuri Guan	Bamboo + Cement plaster	5	Farming, Labor-work	Yes (as unskilled labor)	No	Modern	2 Bed Rooms, Living / Veranda, Kitchen, Store, Toilet, Cattle Shed	Cluster (Traditional)	Mud Stove + Kerosene Stove	Small area, no space for kitchen and store, no toilet.	Likes to make 2-story brick building.
18	Bhuri Guan	Bamboo + Cement plaster	4	Farming, Labor work in india	Yes (as unskilled labor)	No	Modern	2 Bed Rooms, Veranda, Kitchen, Store, Toilet, Cattle Shed	Linear open as current planning	Mud Stove + Kerosene Stove	Small area, too hot inside, small windows.	Add spaces for store, kitchen, larger windows.
19	Bhuri Guan	Bamboo + Cement plaster	3	Farming	Yes (as unskilled labor)	No	Modern	Bed Rooms, Kitchen, Store, Toilet, Cattle Shed	Linear open as current planning	Mud Stove	Need more rooms.	2-story construction, add kitchen, store and toilet.
20	Bhuri Guan	Bamboo + Cement plaster	6	Farming, Labor-work	Yes (as unskilled labor)	No	Modern	Veranda, 2 Bed Rooms, Kitchen, Store, Toilet, Cattle Shed	Cluster (Traditional)	Mud Stove	Small area, too hot inside, no toilet.	Likes to make brick building.

The ex-Kamaiyas pointed out some defects of the current houses provided by AAN and HFH. In addition to the smallness of the houses, they are not satisfied with the roof structure. The cement tiles and CGI sheets used for roof covering are not good for climate insulation with the result that the interior is excessively hot during summer and cold during winter. In addition, the cement tiles have cracked, thus causing water leakage during rain. According to most of the families, the windows are too few and too small to properly illuminate and ventilate the house. Finally, all the interviewees expressed their need for a larger house with separate space for a granary and kitchen.

The additions made to houses provided by AAN and the separate blocks built for a kitchens show the ex-Kamaiyas' knowledge of traditional Tharu house construction (fig. 19). However, the use of contemporary construction materials and techniques in the houses provided by AAN limited the role the ex-Kamaiyas could play in the design and planning of their houses. But utilizing design and construction skills of the ex-Kamaiyas should be an important consideration in providing low-cost self-help housing.



*Figure 19.* Author's photograph showing a house provided by AAN for a ex-Kamaiya family (right) and a building constructed by the family for kitchen (left) in Tesanpur, July, 2010.



Though the ex-Kamaiyas do not have knowledge of contemporary construction materials and technology, ninety-five percent of the interviewees want to live in brick-and-concrete houses as do affluent people in nearby cities. In contrast, only five percent prefer to live in a traditional Tharu house, even if significant improvements were made (table 1). Thus, it is important to significantly modify traditional construction materials and techniques according to modern needs, while still maintaining a building tradition simple enough so that the ex-Kamaiyas' construction skills can be utilized.

During the interviews, I discussed with the ex-Kamaiya families their space requirements for an ideal house. The first priority for the families is the space for a granary because farming is their primary occupation, and they need a secure place to store grains. Secondly, all the families with three or more members want to have at least two bedrooms. Many ex-Kamaiya families favor kitchen and dining space inside the main house if they are provided modern wood stoves. They prefer a large shaded verandah that can be used as a living, working, and gathering space, rather than separate a living room. In addition, they desire a toilet and cattle shade located apart from the main building.

## **Conclusion**

Adaptive contemporary use of vernacular architecture is an important approach to low-cost, self-help housing. Affordability, climate responsiveness, use of indigenous construction materials and technology, use of local manpower, and socio-cultural response are the traits of vernacular architecture which make it relevant for cost-effective housing (Fathy, 1993). Thus, the vernacular building traditions of the Tharus of western Nepal were analyzed

during my field visit to identify design and construction possibilities for low-cost, self-help housing for the ex-Kamaiyas.

The Tharus live in cluster settlements of twenty to thirty houses. The one-or-two-story houses are arranged around open courtyards, where people come together and thus create a sense of community. Usually, a single family has multiple buildings used for different purposes like sleeping, grain storage, cooking, and cattle. The buildings are constructed by the families using local materials and agricultural byproducts like mud, wood, bamboo, thatch, khapada tiles, rice husk, and cow dung.

Tharu houses, constructed employing simple techniques and local available materials, are not built to endure and require frequent maintenance. The houses are well adapted to the hot, humid monsoon climate. However, orienting the buildings with longer sides facing north-south and properly placing vegetation to shade west walls further improve climate responsiveness. In addition, windows need to be designed and built to improve ventilation and air movement within the buildings.

Housing provided by INGOs like HFH and AAN demonstrates some qualities of the Tharus' vernacular tradition, but have not utilized the positive aspects of Tharu vernacular architecture and planning. These INGO houses, especially housing provided by HFH, besides imitating traditional built form, have tried to incorporate traditional construction techniques using local materials like bamboo and wood. However, the excessive use of contemporary construction techniques and materials has limited the ex-Kamaiyas to being only unskilled laborers.

Though the INGOs are doing a good job by providing houses for the homeless ex-Kamaiyas, their approaches need to be modified. The house design needs to address

individual families' unique requirements by promoting a self-help approach. The construction techniques and materials, adapted from vernacular tradition, must be simple for families to easily construct and maintain their houses.

The overall planning of settlements is done by the government without the involvement of INGOs. The government divides the land into rectangular plots, and access roads are provided in a grid-iron pattern. Then the INGOs become involved and build houses for the ex-Kamaiya families. This trend has resulted in settlements without any sense of community. The settlements are not able to cope with the needs of ex-Kamaiyas because they do not have any similarity to traditional cluster settlements, which are still popular among the Tharus. Thus, a more integrated and coordinated approach to design, planning, and construction of low-cost housing is indispensable to create socially vibrant, economically sustainable, and environment friendly ex-Kamaiya communities.

Self-help is an important aspect of low-cost housing for the ex-Kamaiyas. This thesis aims at laying out some simple guidelines for the INGOs and the ex-Kamaiyas to build cost-efficient housing that satisfies individual needs of families while addressing the community as a whole. As explained in this chapter, I analyzed the housing requirements of the ex-Kamaiyas families and their reactions to current housings provided by INGOs. This analysis helps me prepare guidelines for the production of self-help, low-cost housing which ensures active participation of the ex-Kamaiya families from the design, planning, and construction till the completion and future maintenance of the houses. These guidelines and resulting designs are presented in chapter 4 and 5.

## **Chapter 4:**

### **Large-Scale Patterns for Designing Ex-Kamaiya Neighborhoods**

After the liberation of the ex-Kamaiyas from slavery, they have been the focus of the Nepalese government and INGOs. The government has been working to provide lands for the ex-Kamaiyas on which they can build houses and begin farming. In parallel, INGOs have been working to provide basic human needs like food, shelter, and jobs. As explained in chapter 3, AAN and HFH are the two INGOs working to provide low-cost houses for the ex-Kamaiyas. However, a lack of coordinated effort has resulted in settlements without a sense of community and houses without identities. The low-density, linearly-planned plots do not make use of any knowledge from traditional cluster settlements. In addition, the standard design for houses built using contemporary technology is not able to satisfy the unique needs of specific families, and limits these families' participation in the construction process. Thus, there is the need for a revised production system, which emphasizes the continuity of tradition and satisfies individual families' unique needs through participatory housing and community design.

This thesis analyzes the self-help housing possibilities for the ex-Kamaiyas and aims at generating basic guidelines for planning and designing cost-effective housing for the ex-Kamaiyas. It is an attempt to create better living conditions for these people, an aim which ties to the dynamics of place and responds to the needs of people and local environment. I have named these design guidelines "design patterns." These patterns describe a self-help, incremental housing-production system that responds to individual as well as community needs while incorporating local tradition and environmental requirements.

The basis for these patterns includes the published literature, analysis of the Tharu vernacular architecture, and interviews with the ex-Kamaiyas. As explained in chapter 2, I analyzed the low-cost housing approaches of Hassan Fathy, Christopher Alexander, Balkrishna Doshi, and Laurie Baker. Adaptive use of vernacular architecture, use of local materials, climate-responsive design, and involving families in design and building of their houses are the key aspects emphasized by these architects. To understand the possibility of using Tharu vernacular architecture in the low-cost housing for ex-Kamaiyas, I studied the Tharu settlements in Bardiya, one of the western Terai districts of Nepal. In addition, I interviewed twenty ex-Kamaiyas from three villages in Bardiya to understand their housing requirements and construction skills.

Christopher Alexander's *A Pattern Language* and the design studio project of Meadowcreek by David Seamon and Gary Coates (Coates & Seamon, 1993) are taken as the point of departure to aid in identifying a workable process for creating patterns for the planning, design, and construction of the ex-Kamaiya neighborhoods and individual houses. As Coates and Seamon (ibid.) have argued, I believe that the patterns for this project will help to bridge the gap between broad philosophical qualities of self-help housing design and practical needs of the ex-Kamaiyas.

Following the format of Christopher Alexander's *A Pattern Language*, the patterns for self-help housing for ex-Kamaiyas are arranged from larger to smaller environmental scale. They start with design patterns for the neighborhood and then move to patterns for the design of houses. As Alexander (1975) argues, this linear sequence is important because it helps to clarify the connections among patterns. The neighborhood design patterns are explained in this chapter, and the individual house design patterns are explained in chapter 5.

As in *A Pattern Language*, each design pattern establishes a problem statement followed by a solution. Each pattern explains a principle for the design of low-cost housing which can be reused any number of times. These patterns can be used by architects, INGOs, and people themselves to design and construct cost-effective housing. However, the patterns presented here specifically deal with the housing for ex-Kamaiyas living in the western Terai regions of Nepal and should not be repeated in other contexts without considering the specifics of the particular people and place.

The pattern language approach is more relevant in the context of self-help housing for ex-Kamaiyas than designing mass housing because the patterns prescribe a continuing design process in which the families participate (Alexander, 1985). In addition, the patterns are developed in cooperation with the ex-Kamaiyas as desirable for that particular people and place.

### **Meta-Patterns for Ex-Kamaiya Neighborhoods**

Before identifying the actual design patterns for planning and designing ex-Kamaiya housing, it is important to clarify the underlying philosophical assumptions of the project because it helps to create patterns that are in tune with the underlying planning and design themes (Coates and Seamon, 1993, p. 334). The low-cost housing work of Hassan Fathy and Christopher Alexander clarified that owner-built housing using local construction materials and technologies is the right approach to housing the ex-Kamaiyas. After observing the ex-Kamaiya settlements and conducting interviews, I realized what the low-cost housing projects should aim for: the ex-Kamaiyas need homes and a place where they can feel safe and take pride in; they require a style of design that reflects individual families' unique characteristics.

The underlying planning and design themes for the low-cost ex-Kamaiya housing projects are termed “meta-patterns.” As Coates and Seamon (1993) argue, the understanding of meta-patterns is indispensable because they help to keep the more specific design patterns for neighborhood planning and individual houses in tune with the essential needs of ex-Kamaiya housing. As with the design patterns, each of the four following meta-pattern establishes a problem statement and then describes the most relevant solution.

### ***1. Sustainability***

When the concept of sustainability is put forward in the context of low-cost housing for the ex-Kamaiyas, it is about sustaining the project itself. Contemporary mass housing using modern technologies has not been able to realize the needs of community and individual, and eventually become unsustainable. The overarching theme of sustainability can be seen from the viewpoint of social sustainability, economic sustainability, environmental sustainability, and technical sustainability (Sowman & Urquhart, 1998). Thus, the concept of sustainability broadly relates to the major project theme of designing and planning for people, place, and environment.

For a project to be socially sustainable, it must promote a sense of community and safety, while ensuring the physical and psychological well-being of the people. Economic sustainability relates to the affordability and accessibility of the project. Empowering the families and involving them in the design and construction of their houses are important aspects of the project’s economic sustainability. In addition, the location and planning of the ex-Kamaiya neighborhoods must ensure the daily livelihood of the families.

Adaptive use of vernacular construction techniques, climate-responsive design, and local materials are also important aspects of environmental sustainability. Nature should be seen as a part of community rather than a resource to be exploited. To make the project technically sustainable, the construction technology needs to be simple enough for the inhabitants to maintain and add to themselves. The self-help nature of the project will help to achieve this goal.

## ***2. Sense of Place***

Sense of place is rare in today's context of mass production and globalization. This problem of lack of sense of place is severe in the context of low-cost housing for the poor. The machine-like houses repeated over and over again create a dull landscape which fails to support place identity. Every place has its unique socio-cultural landscape and built environment which makes it distinct from other regions and places. It is very important to preserve this sense of place. Uses of local technology, indigenous design and planning methods, local construction materials, and community involvement help to maintain the sense of place. In the ex-Kamaiya communities that have nearly lost their identity while being labor-bonded, it becomes very important to restore their unique culture and tradition to create a unique sense of place.

## ***3. Community Commitment***

Lack of community commitment can result in places which people do not care for. In the context of low-cost housing, the concept of community involvement has links with affordability as well as with a sense of family ownership. In addition, lack of care and



responsibility towards public places ultimately results in a failure of the sense of community. The low-cost housing for ex-Kamaiyas needs to promote community involvement to develop a sense of personal and communal ownership and responsibility. Residents should be engaged during the design, planning, and construction of neighborhoods and individual houses. This ensures the active participation as well as commitment of the people towards the project that they built for themselves.

#### ***4. Modern yet Embracing Tradition***

In traditional Tharu settlements, the dwelling units are clustered around an open courtyard which brings together community members and creates human bonds. However, contemporary ex-Kamaiya housings are planned in a rigid grid-iron pattern with very low density. This has resulted in poorly planned neighborhoods without any sense of community.

Though using community-responsive design and planning techniques from vernacular tradition is probably the best approach to low-cost housing, the ex-Kamaiyas, as interviews pointed out, are still intrigued by linearly planned mass housings (see chapter 3). Sixty percent of the ex-Kamaiya interviewees agreed that the traditional cluster settlements generated a better sense of community and offered better security because houses were closely sited. However, forty percent of the interviewees expressed hygiene and congestion as important concerns regarding traditional settlements. They are attracted to wide roads, cleaner environments, and the openness of the linearly-planned settlement. Thus, the ex-Kamaiya neighborhoods need to be planned considering the vernacular tradition while also incorporating the modern perceptions of the inhabitants. These communities, though modern, need to embrace tradition.

## **Design Patterns for Ex-Kamaiya Neighborhoods**

Design patterns are the central guidelines for planning and designing the neighborhoods and individual houses for the ex-Kamaiya families. These patterns are derived from the self-help housing approaches of the four architects whose works were reviewed earlier and from vernacular settlement-patterns and contemporary housing requirements of the ex-Kamaiyas. The meta-patterns just explained clarify the underlying themes of ex-Kamaiya housing upon which the design patterns are based. As in the case of meta-patterns, the design patterns are arranged from larger to smaller environmental scale. Design patterns for the neighborhood are discussed in this chapter, while patterns for the design of individual houses are discussed in chapter 5.

### ***1. Village Center as Activity Nucleus***

All settlements need to have a main center which is the activity nucleus of the community. This center plays an important role in bringing people together and establishing community identity. According to Christopher Alexander (2005, p. 340), identifying the location and shape of a main center is the first step towards laying out a successful neighborhood. The center is a real place--lively, beautiful, and significant for the residents.

Traditional Tharu settlements usually have village centers as places where community gatherings and weekly markets are held. In the case of ex-Kamaiya housing today, smaller neighborhoods can be arranged around a village center. This center should be developed as an activity nucleus where all major community activities take place. Market place, school, temple, and craft training center are the major elements to be incorporated in this center (fig. 20).



*Figure 20. Pattern 1: The Village Center as Activity Nucleus (author's sketch of an open market in a village center, Feb, 2011).*

## **2. Builder's yard**

Alexander used the concept of builder's yards for low-cost housing in Mexicali, Mexico (Alexander, 1985). Builder's yards are places to store tools, equipment, and materials; to carry out experiments with building materials; to provide the architect builder with accommodation and office-workshop space (ibid.). Alexander's concept of decentralized local builder's yards can be adopted as a single builder's yard serving a large housing project of fifty to one-hundred houses. The village center is an ideal location for a builder's yard.

The builder's yard should be constructed at the beginning, following the building system and design patterns proposed for individual houses. Besides serving as a place to store tools and materials, office, workshop, and accommodation, the builder's yard will be a demonstration building for the ex-Kamaiyas. It will demonstrate the workability of design patterns, construction techniques, and materials to be used in the construction of individual houses. Most importantly, after completion of the project, the builder's yard will be used for community facilities like school, market place, and training center.

A market in the village center will be a weekly or bi-weekly activity and will not have permanent shops. The stalls to be constructed for storing tools and materials can later serve the purpose of open market shops. On the other hand, more permanent structures in the builder's yard for office and workshop can be adapted as a craft training center. This would be a place for the ex-Kamaiyas to display their traditional bamboo crafts and learn new livelihood skills. Thus, the training center plays an important role in the economic sustainability of the settlements. In addition, other spaces in the builder's yard could be used

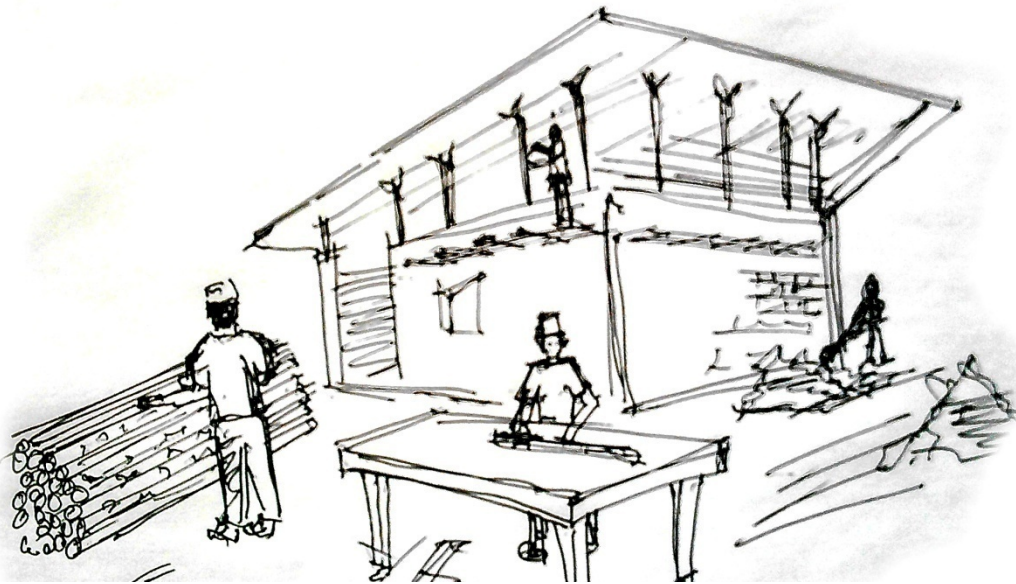

for school buildings.

*Figure 21. Pattern 2: The Builder's yard (author's sketch, February, 2011).*

### ***3. Hierarchy of Open Spaces***

In traditional Tharu settlements, houses are arranged in a cluster with a hierarchy of open space which ranges from the front verandah of a house to common courtyards and rice fields surrounding the entire cluster. This hierarchy of space arrangement is typical in Tharu settlement and should be incorporated in the ex-Kamaiya housing with necessary modifications (fig. 22).

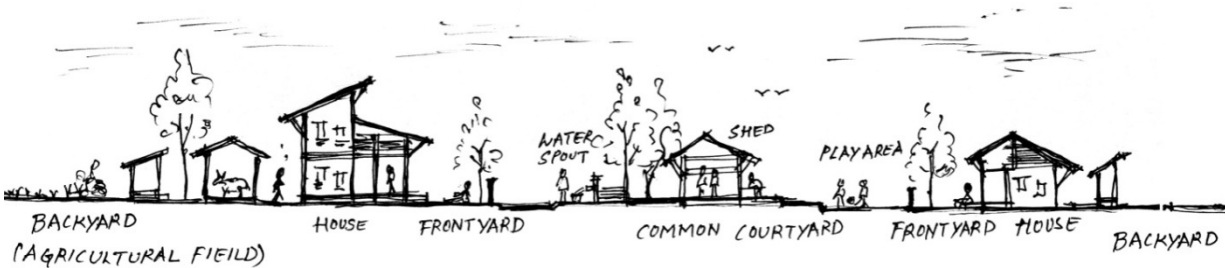

Figure 22. Pattern 3: The Hierarchy of Open Spaces (author's sketch, February, 2011).

Since the ex-Kamaiya interviewees were concerned about security, the houses need to have boundary walls which separate the houses from the main courtyard. Each house can have a front yard which will be used for drying farm produce and for personal gathering space. The front yard is an extra addition to the traditional space hierarchy which serves as a transition between private and public spaces. Thus, every house will have a verandah facing the front yard which overlooks the larger common courtyard of the neighborhood cluster. The cluster is again surrounded by rice fields which complete the hierarchy of open space.

#### ***4. Neighborhoods as Housing Clusters***

The neighborhoods should be planned considering the vernacular tradition while also incorporating the modern perceptions of the inhabitants. Wider roads, cleaner environments, and a sense of openness are important aspects emphasized by the interviewees that can be incorporated in traditional cluster settlements without losing a sense of security and community identity. This design pattern must follow the underlying theme of creating modern communities that embraces tradition.

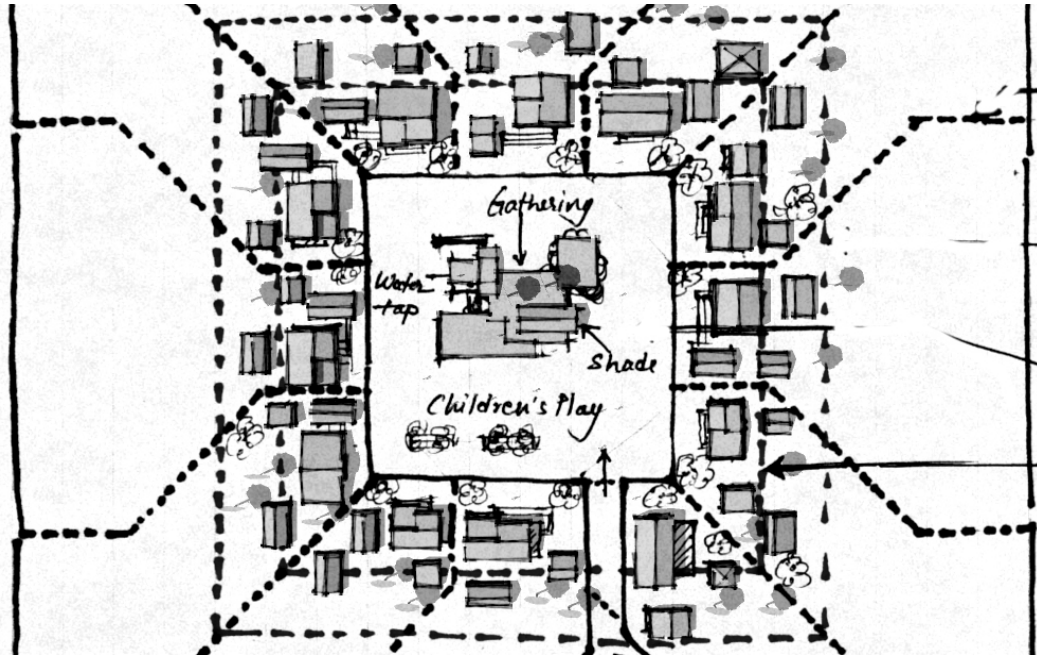
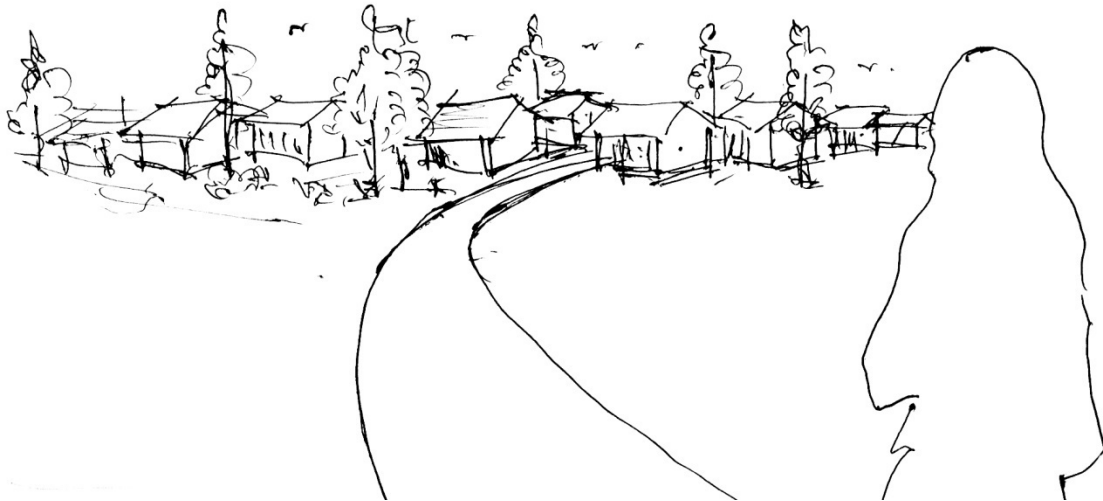

Figure 23. Pattern 4: The Neighborhoods as Housing Clusters (author's sketch, February, 2011).

The housing can be divided into smaller neighborhood clusters of eight to fifteen houses located close to each other around a common open courtyard (fig. 23). The neighborhood cluster should be smaller than traditional cluster settlements, but have larger common space to accommodate daily communal activities. Placing houses close to each other creates a sense of community and security, while a sense of openness is maintained by the common space around which the houses are arranged. These neighborhood clusters can then be arranged around the main village center as described earlier. In addition, identifying families to be clustered together in a neighborhood is an important part of settlement layouts. Families coming from the same places can be the basis for clustering houses in neighborhoods, much in the way Hassan Fathy used the “badana” as a means to design the neighborhood block of New Gournā.

## **5. Connection between Communities**

Each neighborhood is a cluster of houses arranged around a central common area and surrounded by agricultural fields. These neighborhoods should be arranged around the main village center. The connection between the neighborhoods and their connection to the village center is necessary to enhance interaction and support public activities. The ex-Kamaiya communities, predominantly located in rural areas, should be developed to be walkable. The neighborhoods can be connected to the village center by graveled roads, while narrow walking alleys can run through the fields to make connections among the neighborhoods. The width of roads should be as narrow as possible to support the walkability and density of the settlement. However, the roads should be wide enough for emergency vehicles.

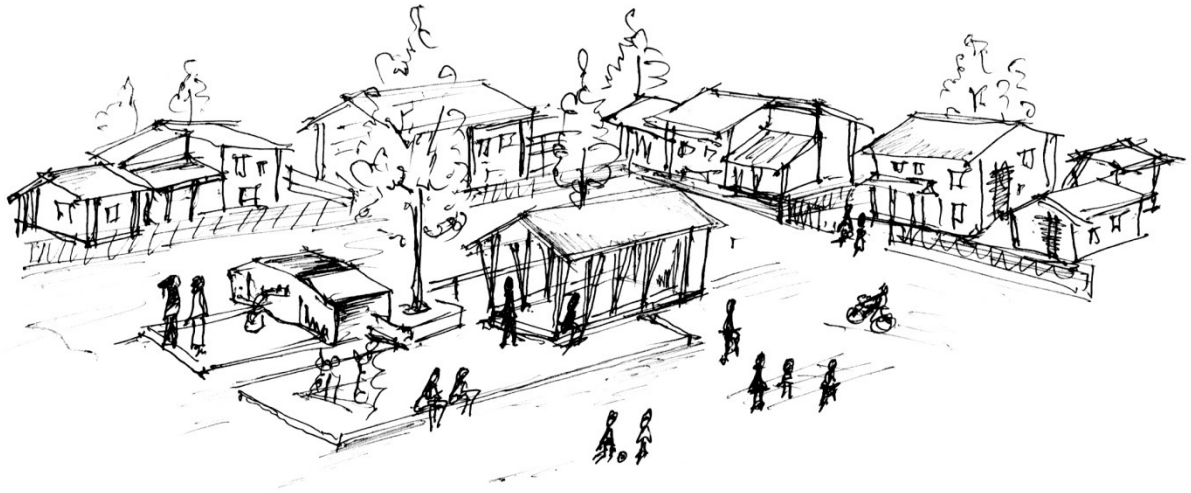

*Figure 24. Pattern 5: The Connection between Communities (author's sketch, February, 2011).*

## **6. Common Courtyards**

Traditionally, the Tharu houses were clustered together around an open courtyard which was shared communally by village families. This open space was used for drying crops, public gathering and interaction space, children's play area, and location of communal well. Thus, design of the common land is an important aspect of ex-Kamaiya housing because

it helps to bring people together for interaction and to enhance life. A water source, shaded resting place, and children's play area are three important elements to be incorporated in the common land.



*Figure 25. Pattern 6: The Common Courtyards (author's sketch, February, 2011).*

Rather than providing hand-pumps or wells for individual houses, a community water spout and communal well not only reduce the water infrastructure cost but also promote interaction among villagers while they fetch water. Since the neighborhood clusters consist of only eight to fifteen houses arranged around the central open space, the distance between the houses and water spout will not be more than 200 feet. A shed, a shaded resting place with trees, is another important element in the common space. It is a platform partly covered by a traditional-sloped roof and partly open to the sky. It will serve as a gathering place where men meet, play cards, and have social interactions. In addition, a children's play area should be incorporated in the common land such that it is visible from the verandahs of all houses in the cluster. It will bring together children of the neighborhood and, along with the children, their parents, who come together to watch children and interact.



## Neighborhoods Generated by Patterns

To ensure the practicality and workability of the design patterns and broader meta-patterns, they have been used to design and plan the ex-Kamaiya neighborhoods for a Tesanpur village. It is a hypothetical project in which an existing ex-Kamaiya settlement has been redesigned and allows for comparisons with the existing settlement of Tesanpur planned and constructed by AAN and the Nepalese government. This comparison not only helps to point out deficiencies of current approaches to ex-Kamaiya housing, but also bolsters the pattern-language approach used here to self-help housing for the ex-Kamaiyas.

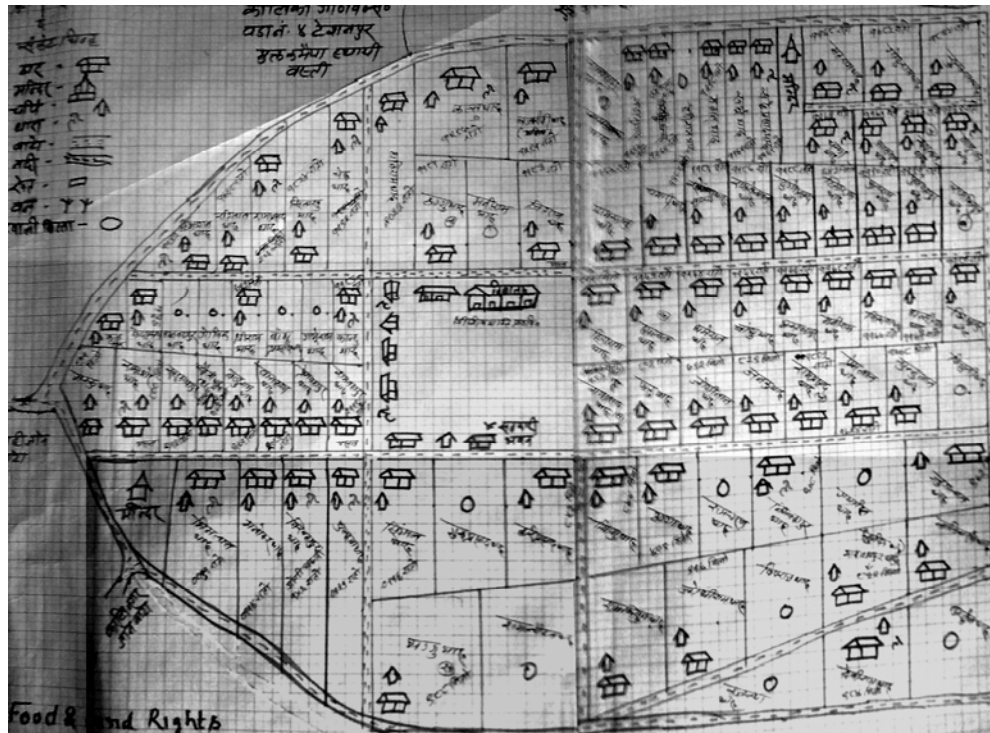

Figure 26. Author's photograph of a map of Tesanpur village prepared by AAN showing the linearly planned ex-Kamaiya neighborhoods, July, 2010.

Tesanpur is one of the three ex-Kamaiya villages that I analyzed during my field trip in summer, 2010. There are seventy-eight ex-Kamaiya families living in the houses provided by AAN and each family owns 0.4 acres of land. The government plotted the village in a grid-

iron pattern, and AAN (which does not play any role in plotting the land) has constructed identical two-room houses for each family. The low-density, linearly-planned rows of identical houses have resulted in isolated neighborhoods without any sense of community identity (fig. 26 & 27). In contrast, my proposed settlement attempts to create sustainable communities with a sense of place identity and community commitment. Though it is a hypothetical project, to pursue the underlying theme of community commitment, the families have been interviewed and their requirements have been analyzed as explained earlier. Thus, the suggestions made by ex-Kamaiya interviewees have been incorporated in my design and planning of Tesanpur as an important aspect of community involvement.



*Figure 27.* Author's photograph of houses constructed by AAN in Tesanpur village, July, 2010.

As a first step, the best location of the main village center for the entire settlement must be determined and a tentative layout established (fig. 28). This center is an activity nucleus of the community, which brings people together and creates a sense of community. Thus, the location of the village center and its relation with the surrounding neighborhoods become very important. Secondly, the settlement is divided into seven neighborhood clusters after identifying families to be clustered together in each neighborhood (fig. 28). The ex-Kamaiyas interviewed in Tesanpur are originally from six different Nepalese villages—

Jawadi, Fulpur, Bakhautiya, Mainapokhar, Kakaura, and Rajapur. Families coming from the same village are grouped together in one neighborhood with the assumption that these families will get on well and create a better sense of community. These clusters are then laid out around the village center such that the center is easily accessible from all the neighborhoods.

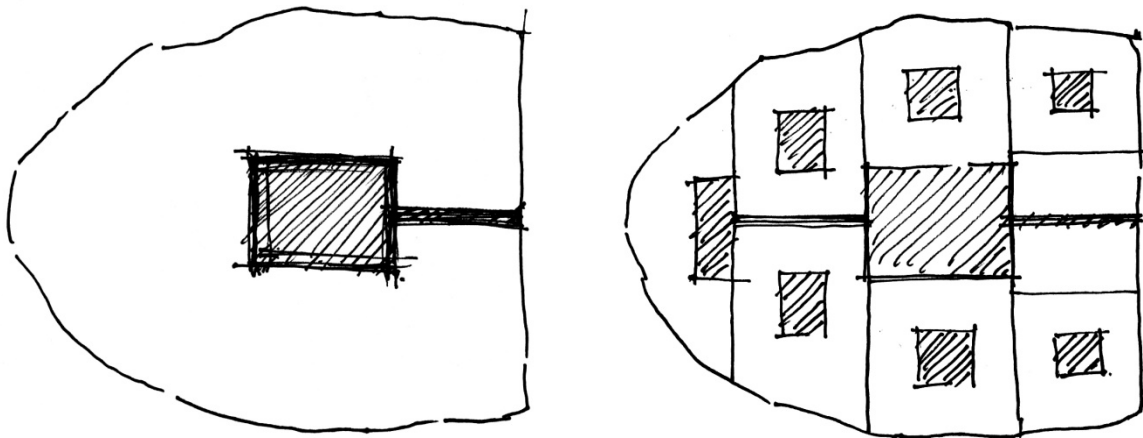

*Figure 28.* Step 1-- Determining the project boundary and the main village center (left), Step 2-- Arranging neighborhoods around the main center (right) (author's sketch, February, 2011).

Next, the road network connecting the neighborhoods and the village center is laid out (fig. 29). The neighborhoods are connected to the village center by twelve-and fourteen-foot graveled roads, while three-foot walking alleys connect the neighborhoods. The minimum width of the roads is determined by the need to service emergency vehicles. The final step is the layout of the individual plots around the common courtyards and the layout of a builder's yard (fig. 29). The builder's yard is located in the village center, which is converted to community facilities after the completion of the project.

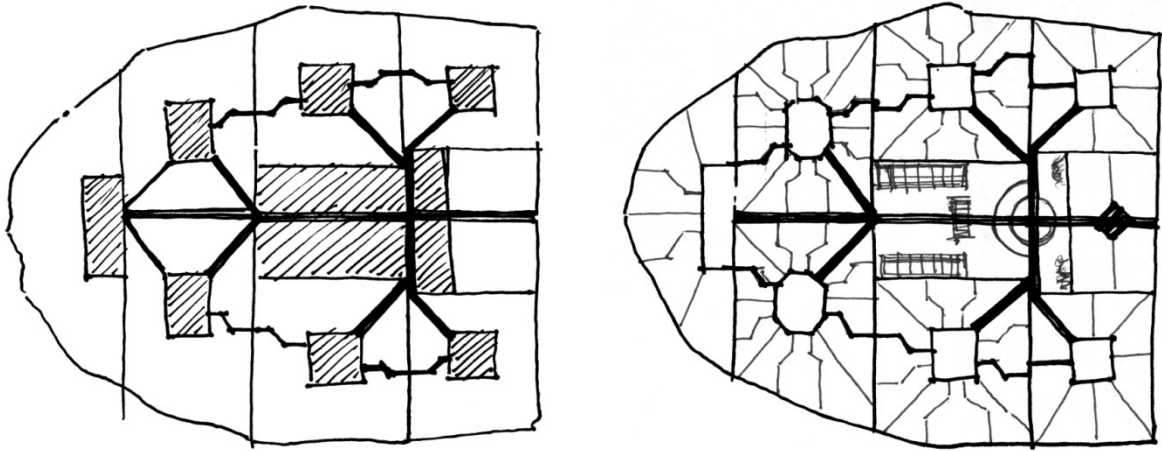

Figure 29. Step 3-- Laying out the connecting roads and narrow alleys (left), Step 4-- Laying out individual plots around common courtyards (right) (author's sketch, February, 2011).

The neighborhood clusters are planned by drawing on both modern adaptations and vernacular-settlement features. Each neighborhood cluster has eight to fourteen houses and a central common courtyard of at least 9,000 square feet. A community water spout and a communal well are located in the common courtyard of each neighborhood. In addition, a shed is provided for men to meet, play cards, and interact, and a children's play area are incorporated in each cluster.

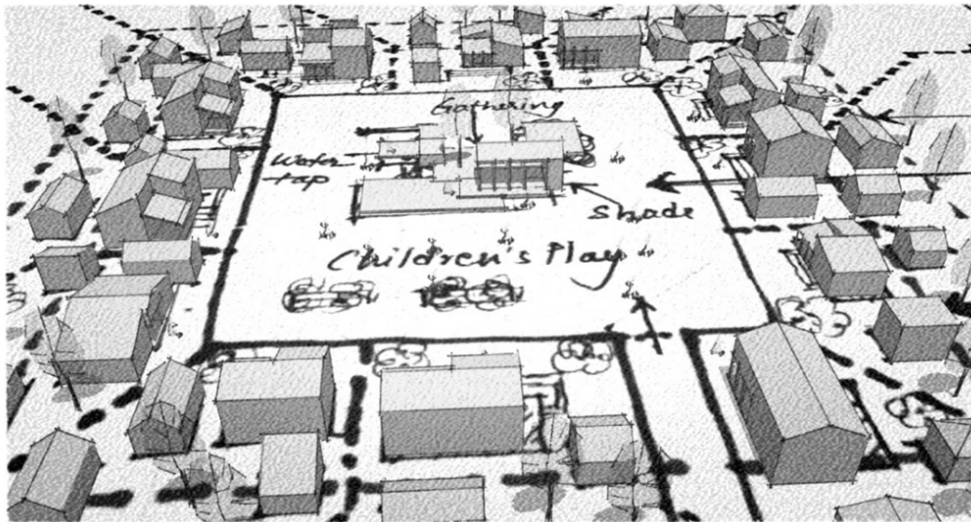

Figure 30. The arrangement of proposed ex-Kamaiya houses around a common courtyard (author's sketch, February, 2011).

The neighborhood clusters are smaller than traditional cluster settlements, but have a larger common space. The houses are placed close to each other, but a sense of openness is maintained by larger central common courtyard. Thus, the cluster planning of neighborhoods with central open space arranged around the village center is the main feature of the proposed ex-Kamaiya housing layout in Tesanpur (fig. 31).

The proposed design of ex-Kamaiya neighborhoods for Tesanpur demonstrates practical applicability of the pattern language approach to self-help housing for ex-Kamaiyas. The process is simple but incorporates the complexities of individual and community needs. These neighborhoods will have a better sense of community and security than linearly planned neighborhoods because they are based on the actual requirements of the residents and are adapted from traditional settlement patterns.

## **Conclusion**

Realizing many weaknesses in the housing approaches of the Nepalese government and INGOs working to provide houses for the ex-Kamaiyas, I have proposed a new system of housing production. This system is based on the self-help housing approaches of architects like Hassan Fathy and Christopher Alexander, the vernacular building tradition of the Tharus, and the practical daily requirements of the ex-Kamaiyas. As illustrated in the preceding sections of this chapter, this system is envisioned in terms of design guidelines which are arranged in Christopher Alexander's *A Pattern Language* format.

Continuity of tradition, climate-responsive design, community involvement, creating a better sense of community, and satisfying the contemporary needs of the ex-Kamaiya communities are the key qualities delineated by the patterns. As explained earlier, these patterns help to bridge the gap between broad philosophical qualities of self-help housing

design and practical needs of the ex-Kamaiya communities. The meta-patterns are explained at the start, thus ensuring that the design patterns remain within the broader aims of the project.

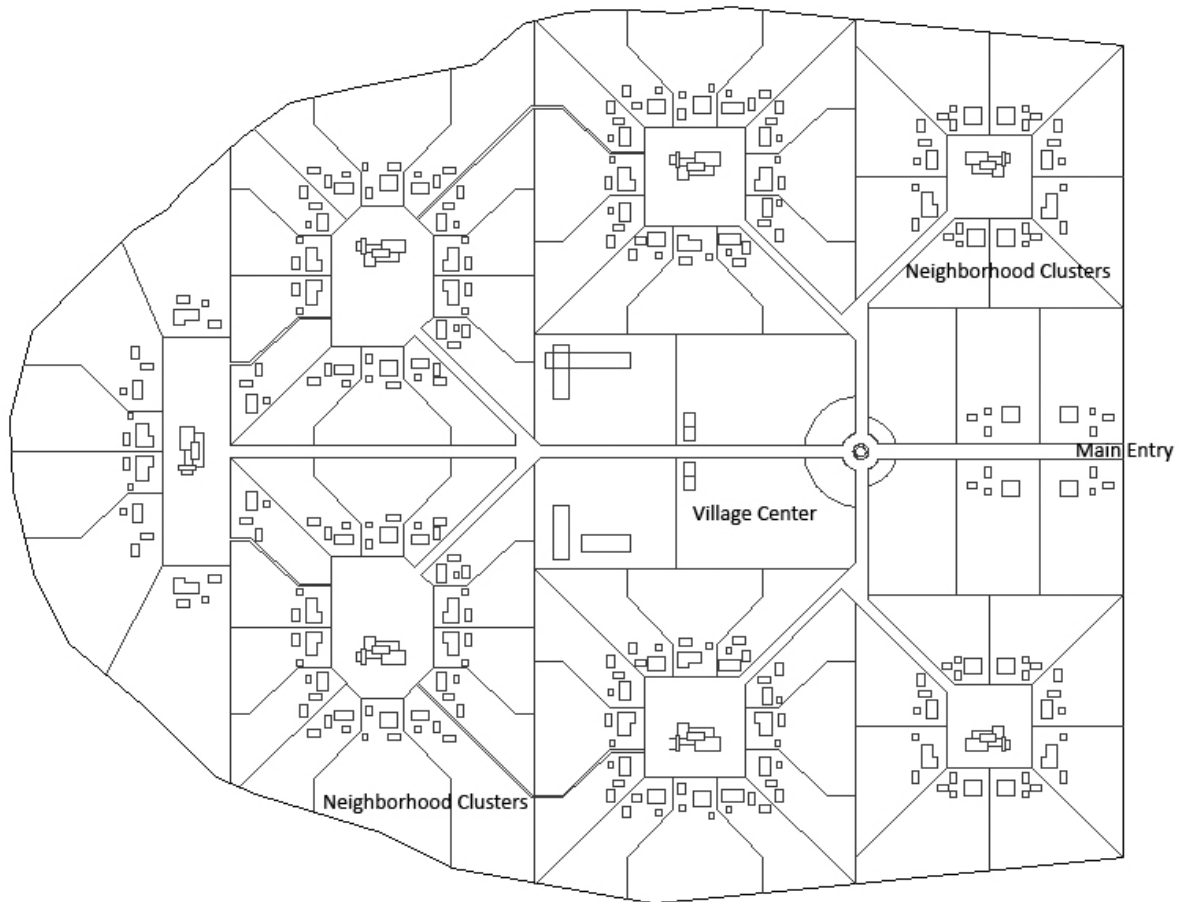

*Figure 31.* Proposed ex-Kamaiya housing in Tesanpur village (author's drawing, February, 2011).

The neighborhood design for Tesanpur demonstrates the appropriateness of the pattern language approach for the planning of an ex-Kamaiya neighborhood. The patterns should help create lively neighborhoods with a unique community identity, while satisfying the hygiene needs and sense of openness that many ex-Kamaiyas desire. In Tesanpur, neighborhood clusters result by arranging houses around a central courtyard, which is the heart of

community activity. These clusters are then arranged around the main village center, which plays a major role in the economic and social sustainability of the project.

The larger design patterns for ex-Kamaiya neighborhoods describe a generalized approach for laying out specific ex-Kamaiya settlements. Thus, these neighborhood design patterns, along with broader meta-patterns, illustrate a realistic approach to ex-Kamaiya neighborhood planning that responds to community needs, incorporates local tradition, and integrates the natural environment in a sustainable manner. I next need to present the smaller design patterns for the design and construction of individual houses and related meta-patterns. These are described in chapter 5.

## **Chapter 5:**

### **Small-Scale Patterns for Designing Ex-Kamaiya Houses**

As argued in chapter 4, *A Pattern Language* approach is one useful way to design and plan ex-Kamaiya neighborhoods because this process creates communities with a more coherent identity, satisfying individual and community needs. This approach of using patterns based on local tradition and community requirements can also be used to design and construct ex-Kamaiya houses. In addition, the *Pattern Language* approach can ensure a coordinated approach in laying out neighborhoods and constructing individual houses.

As explained earlier, AAN and HFH are the two INGOs working to provide low-cost houses for the ex-Kamaiyas. Using contemporary technologies, these INGOs have constructed two-room houses for all the ex-Kamaiya families. Unfortunately, these houses are not only unable to satisfy specific needs of the families but also unable to express each family's unique identity, including participation in the construction process. Thus, the *Pattern Language* approach to designing and constructing ex-Kamaiya houses needs to emphasize the continuity of tradition and satisfaction of individual families' unique needs through owner-built housing.

Hassan Fathy's and Christopher Alexander's works demonstrate that owner-built housing using local construction materials and technologies can be a successful approach for low-cost housing for the poor. Thus, the following design patterns for designing and constructing ex-Kamaiya houses are based on the concept of owner-built houses. In addition, the incremental-housing concept of Balkrishna Doshi and the low-cost construction techniques of Laurie Baker are addressed by these patterns. Further, my analysis of existing



Tharu houses and housing requirements of ex-Kamaiyas have been important in generating these small-scale design patterns for ex-Kamaiya houses.

As explained earlier in chapter 4, the house patterns developed here will help to bridge the gap between broad philosophical qualities of self-help housing design and practical needs of the ex-Kamaiyas (Coates & Seamon, 1993). Following Christopher Alexander's *Pattern Language* approach in arranging the patterns from larger to smaller environmental scale, the sequence starts with large-scale design patterns and then moves to small-scale design patterns for the design of houses. The individual house design patterns are explained in this chapter, while neighborhood design patterns have already been explained earlier in chapter 4.

### **Meta-Patterns for Ex-Kamaiya Houses**

Meta-patterns express the deeper philosophical aims of a project, which in the case of ex-Kamaiya housing is to restore the lost pride of the once enslaved ex-Kamaiyas, partly through good design. Hassan Fathy and Christopher Alexander's cost-efficient housing work clarified that owner-built houses using local construction materials and technologies is the right approach to build the ex-Kamaiyas houses. After observing the current ex-Kamaiya housing conditions and conducting interviews, I realized that the ex-Kamaiyas need homes and a place in which they can feel safe and in which they can take pride; they require a style of design that reflects the individual families' unique characteristics. The understanding of meta-patterns is indispensable to keep the more specific design patterns for individual houses in tune with the essential needs of the ex-Kamaiya (Coates and Seamon, 1993, p. 334). Thus, these meta-patterns are explained ahead of the design patterns for designing ex-Kamaiya houses.

## ***1. Sense of Pride***

Being homeless is one of the worst feelings that a human being can experience. Everyone feels pride for his or her house. The ex-Kamaiyas, predominantly homeless while they were labor-bonded, feel great pride for their recently acquired houses and lands. The sense of pride that one feels by possessing a house can be further enhanced by making the house flexible to accommodate necessary changes as per individuals' requirements. In addition, if the ex-Kamaiyas are involved in the design and construction of their houses, they will have a better sense of ownership, and love and care for their houses.

All the ex-Kamaiyas have knowledge about traditional building-construction materials and techniques. Thus, it will be easier to involve the ex-Kamaiyas in the construction of their houses if traditional construction techniques are modified and adapted as per modern needs rather than following unfamiliar contemporary construction techniques. In addition, the concept of incremental design is more viable in the case of owner-built houses because individuals can add on to their dwellings or rebuild them in the future.

## ***2. Sense of Individuality and Uniqueness***

As pointed out by Alexander in *The Production of Houses*, each individual house needs to be unique and reflect the character of the family and the love and care they have for their houses. The current houses provided to the ex-Kamaiyas are the same design repeated over and over and thus, these houses fail to satisfy families' unique needs and cannot express the families' unique identities.

In the case of ex-Kamaiya houses, the notion of the individual house reflecting the family's distinctive character and identity becomes more imperative because these people were previously treated as slaves and had their identities stolen. The unique character of house

can reflect the family's uniqueness and restore their identity. This sense of uniqueness can be achieved through owner-built incremental housing, in which the character of the house is shaped by the family.

### ***3. Sense of Security***

People should feel calm and safe when they are at home. However, this is not always the case. Many ex-Kamaiyas living in temporary structures are always under the threat of robberies or natural disasters. Even a few evening showers can cause havoc because roofs often leak. Security is still important for the ex-Kamaiya houses provided by INGOs because the dwellings are placed very far apart. In most ex-Kamaiya families, men usually go to India in search of employment, which make the houses more vulnerable to looting and robberies. Thus, houses need to be well built, and close proximity between houses can help create a sense of security.

### ***4. Modern yet Embracing Tradition***

Traditional Tharu houses are built from locally available materials like mud, bamboo, and wood, which make them environmentally responsive. However, houses built by INGOs use contemporary building materials and technology. This approach has resulted in environmentally and climatically unsustainable design. In addition, this method limits the participation of the families in the building construction, since they are only familiar with traditional building technology.

The ex-Kamaiyas have a rich building tradition, but ninety-five percent of the ex-Kamaiyas in my interviews favor modern materials and construction technologies used by

affluent groups in nearby cities. According to Laurie Baker, "When it comes to the poor who've already been living on mud, they know it only of its disadvantages. Their dream is a brick-and-cement home" (Bhatia, 1991, p. 71). Thus, significant improvement in traditional building techniques and awareness among the ex-Kamaiyas about these traditional techniques are necessary. In this sense, adaptive use of traditional construction materials and techniques enhanced by modern improvements is the approach to build low-cost self-help houses emphasized here. This modified building technology, however, needs to be simple enough for the ex-Kamaiyas to learn and to apply during the construction of their houses.

## **Design Patterns for Ex-Kamaiya Houses**

After the individual plots are laid out in neighborhood clusters following the large-scale design patterns, the houses need to be designed, laid out, and constructed following the small-scale design pattern to be highlighted next. These design patterns are the actual guidelines for designing and constructing the ex-Kamaiyas houses. The adaptive use of traditional architecture, local materials, climate-responsive design, and involving families in design and building of their houses are the underlying themes of ex-Kamaiya housing emphasized in the housing meta-patterns just described above. As in the case of meta-patterns, the design patterns are arranged from larger to smaller environmental scale.

### ***1. Inhabiting the Site***

Understanding the site is an important part of designing any project and needs to be considered in the design of ex-Kamaiya houses. The traditional Tharu houses and the existing conditions of the building site should be carefully analyzed. Then, following the concept of

community involvement, the houses should be laid out on the site with the cooperation of the ex-Kamaiya families to satisfy their individual and group requirements.

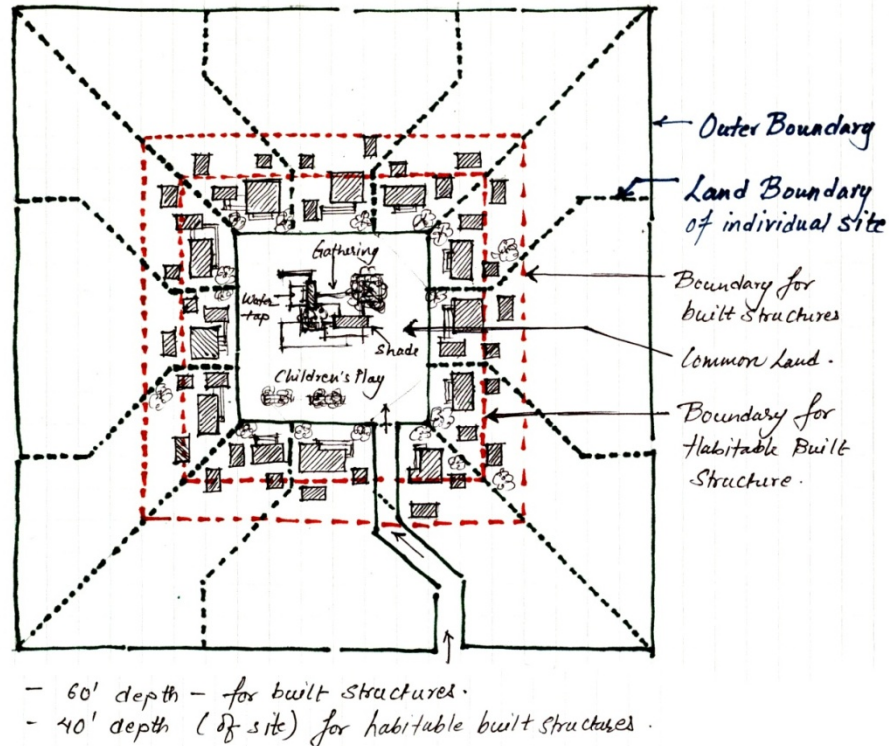

Figure 32. Pattern 1: Inhabiting the Site (author's sketch of an ex-Kamaiya neighborhood showing layout of houses around common courtyard, February, 2011).

As explained in Chapter 5, the individual plots are laid out around a common courtyard to create neighborhood clusters. The plots are usually fifty feet wide and no more than 200 feet deep. Though the location of houses in the plots will be decided by the families, the main house unit should to be placed within forty feet of the front boundary line, which is connected to the common land (fig. 32). The aim is to concentrate the houses around common courtyards and create a better sense of community. In addition, the houses should be designed and constructed by adapting the vernacular tradition as per the modern requirements mentioned in my interviews by the ex-Kamaiya families. Thus, the design of individual

houses as well as their layout on the site should take the site into consideration as well as respond to the traditional and cultural values of the ex-Kamaiyas.

## 2. Capturing Light

Naturally lit spaces have the capacity to change the mood of people and are believed to be more cheerful than dark spaces (Jacobson, Silverstein & Winslow, 2002, p. 99). Traditional Tharu houses and the current houses provided by the INGOs have small windows, thus resulting in dark indoor spaces. To counter the darkness, one of the important design strategies is to shape the house in response to the sun with its rooms located and organized so as to catch maximum natural light while keeping the summer sun out. Building elongated along east-west axis help is ideal for hot-humid climate. Larger windows with overhangs to block the summer sun are the right approaches in a hot-humid climate like the western Terai regions of Nepal (fig. 33).

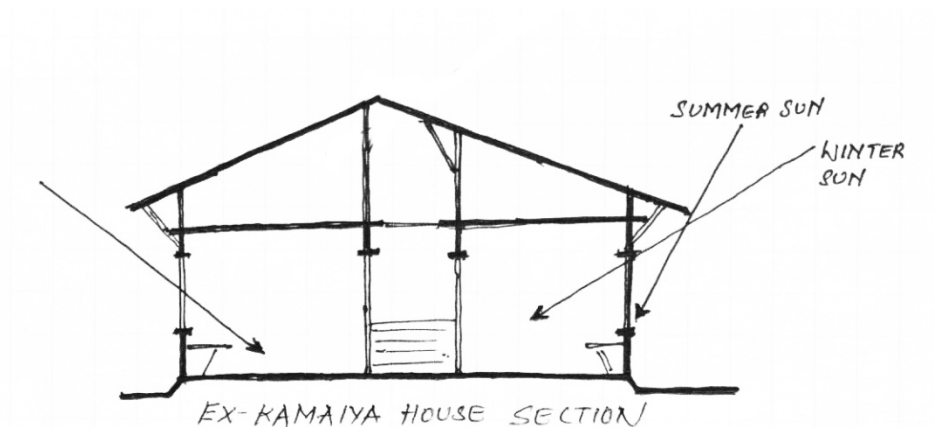

Figure 33. Pattern 2: Capturing Light (author's sketch of an ex-Kamaiya house section showing natural light distribution, February, 2011).

Rooms lit from one side only are usually uncomfortable because of the steep light gradient on the walls and floors, which makes the areas farthest from the windows

uncomfortably dark compared to areas nearer the windows (Alexander, 1969, p. 120). Thus, all the rooms which are to be used during the day should have light coming in from windows or sky lights at least from two directions. In addition, this manner of lighting also reduces the dependency on expensive and not readily available artificial lighting.

### 3. *Capturing Wind*

The western Terai regions of Nepal have a predominantly hot-humid climate with a harsh winter. The most efficient way to cool buildings in a hot-humid climate is to increase the evaporation of moisture by breezes. Thus, the houses need to be oriented to catch the prevailing south-western winds, and rooms should have windows on two sides so that they can be cross-ventilated (Brown & DeKay, 2001). In addition, the design of roofs and shaded spaces becomes important for catching the breezes (fig. 34). The incorporation of shaded verandahs with windows can help to increase air flow through the buildings (Alexander, 1969, p. 119).

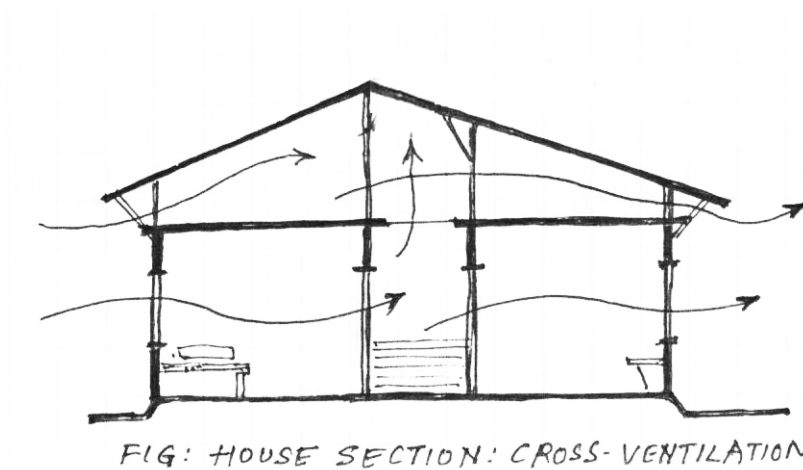

Figure 34. Pattern 3: Capturing Wind (author's sketch of an ex-Kamaiya house section showing cross-ventilation, February, 2011).

#### 4. Space Layout

The traditional Tharu house usually has a main unit with sleeping space and granary, and separate smaller units for kitchen, toilet, and cattle shed. Since the Tharus use a traditional firewood mud stove for cooking, they prefer to have a separate unit for the kitchen, while the toilet and cattle shed are built separately for hygienic reasons. Efficient use of spaces and easier connection between spaces are important considerations when laying out the main unit of the houses. This unit should include sleeping rooms and granary arranged around a pivotal verandah space, while the decision of incorporating the kitchen into the main unit will depend on the individual family. The cattle shed and toilet must be located separately because all the ex-Kamaiyas in my interviews did not prefer toilets and cattle sheds as part of their main house unit.

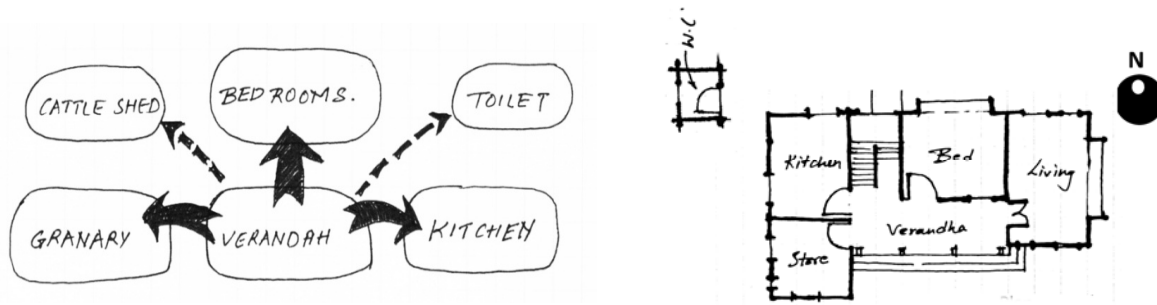

Figure 35. Pattern 4: Space Layout (author's sketch connection between spaces, February, 2011).

#### 5. Verandah as In-between Space

The verandah is an important element of traditional Tharu house architecture. Its ability to shade the summer sun while catching cool breezes makes it an important design asset in hot-humid climates. In addition, the verandah plays an important role in bringing family members together in a space which “lives” (fig. 36). It is a place that residents occupy on hot summer days. Also, it is a place to interact with guests and family members. Finally, it can be used for sleeping during warm summer nights. Thus, the verandah should be



incorporated into the houses as an in-between living space linking the exterior and interior. It should be wide enough to allow for family sitting and to serve as an outdoor living room.



Figure 36. Pattern 5: Verandah as In-between Space (author's sketch, February, 2011).

## 6. Number of Stories

Traditional Tharu houses, built out of mud and bamboo, are usually one-story high as are all ex-Kamaiya houses provided by the INGOs. Many ex-Kamaiya interviewees, however, desire to live in two-story houses, which according to them would provide a stronger sense of pride. Constructing two-story houses will take more money because they require thicker walls and foundations. However, the upper story can be constructed from light material like bamboo, while the lower story incorporates a load-bearing wall (fig. 37).

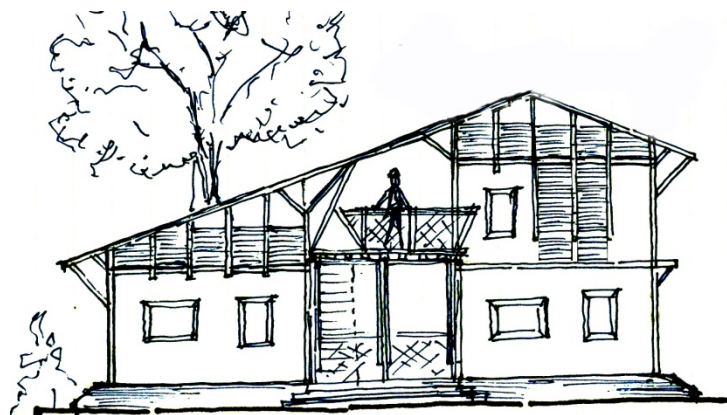
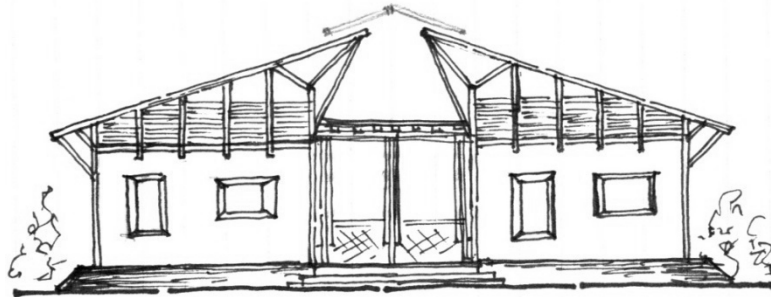

Figure 37. Pattern 6: Number of Stories (author's sketch, February, 2011).

## 7. *Sheltering Roof*

The roof plays a primal role in the lives of inhabitants (Silverstein, 1993). It must be distinct enough to make its presence felt so that residents will feel the sense of shelter (Jacobson, Silverstein & Winslow, 2002, p. 75). In relation to the ex-Kamaiya houses, the roof should also function climatically. The traditional sloped roof with khapada tiles does not work well because khapada tiles are burnt mud-tiles requiring scarce firewood for their production. In addition, the ex-Kamaiya interviewees prefer contemporary corrugated galvanized iron sheets (CGI sheets) rather than khapada tiles or a straw roof.



*Figure 38. Pattern 7: Sheltering Roof (author's sketch, February, 2011).*

A double roof consisting of a sloped upper layer of CGI sheets and a flat lower layer of bamboo and mud is a workable alternative for the hot-humid climate of western Terai. A ventilation gap between the two roof-layers helps to moderate the house's interior temperature because the sun's heat is re-radiated from the CGI sheets and carried away by the wind. In addition, the house-like quality of the double roof evokes a sense of shelter that can also satisfy family's wish for a modern-appearing dwelling. The design of the roof, however, has to take into consideration the strong local winds.

## 8. Building with Available Materials

Though the overarching theme for the material selection is cost efficiency, environmental responsiveness and basic comfort needs of ex-Kamaiya families should also be considered while selecting construction materials. The suggestions made by interviewees to improve the current INGO houses show their interest in modern materials and construction technology used by the affluent groups in near-by cities. Materials like “compressed stabilized earth block” (CSEB), bamboo, sand, mud, and cement can balance the modern needs of inhabitants with tradition (fig. 39). CSEB blocks can be considered as modern building materials which are cheaper and more energy-efficient than fired bricks. Bamboo is one of the fastest growing plants abundantly available in western Terai that can be used in building construction as structural and decorative material.

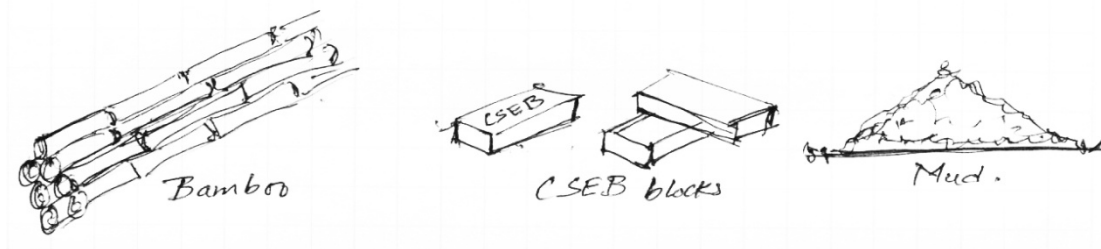

Figure 39. Pattern 8: Building with Available Materials (author's sketch, February, 2011).

## 9. CSEB Walls with Innovative Bonding

CSEB blocks are a mixture of mud and sand compressed to form blocks of required size. Lime or cement is added as a stabilizer which binds the composites together. CSEB blocks are popular in Nepal and replacing normal kiln-fired bricks. These blocks cost less than normal bricks and are comparatively energy-efficient and climate-responsive. CSEB blocks are laid out as normal brickwork and are resistant to humidity and rain. For further cost-efficiency and better insulation, innovative bonding methods can be used (Bhatia, 1991).

For example, figure 40 shows a bonding technique where CSEB blocks are laid out to make an interior air space that works as insulation and also reduces the amount of blocks and bonding mortar by twenty-five percent without losing strength.

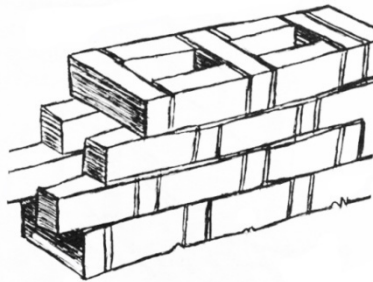

Figure 40. Pattern 9: CSEB Walls with Innovative Bonding (author's sketch, February, 2011).

## 10. Floors and Ceilings

The ground floor slab and first floor are the two major horizontal elements in ex-Kamaiya houses. Traditional Tharu houses have mud floors plastered with a mixture of rice-husk, mud, and cow dung. These mud floors work well compared to contemporary cement floors because they do not get excessively cold during the winter or hot during the summer. However, most of the ex-Kamaiya interviewees prefer cement floors, which for them is modern, though they agree that traditional mud floors work better. Even so, for climate-responsive design and cost-efficiency, traditional mud floor is a better alternative to cement floors (fig. 41). The floors can be supported by bamboo beams while bamboo mats can be used for ceiling finish.

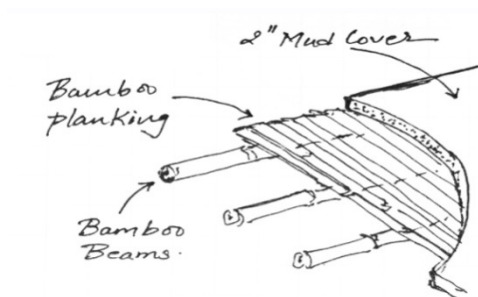
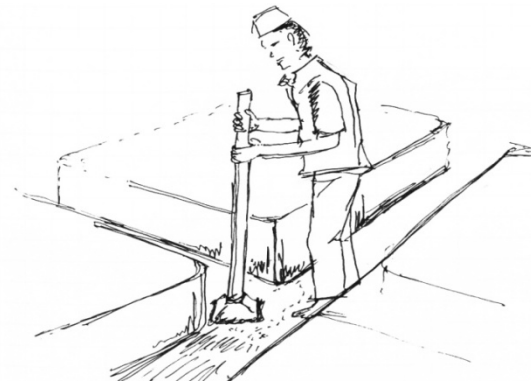

Figure 41. Pattern 10: Floors and Ceilings (author's sketch of bamboo-mud floor, February, 2011).

## ***11. Foundations***

The cost of constructing foundations for a house can be as high as one-third of the total expenses. Thus, cost-efficient design of foundations is an important objective in the design of low-cost houses. Traditional Tharu houses usually have rammed-earth foundations, while the INGOs have used brick foundations. The high cost of brick foundation can be mitigated by resorting to traditional rammed-earth foundations (fig. 42). The best alternative is adaptive use of traditional rammed-earth foundations by mixing in cement, sand, and fly-ash to soil and ramming layer by layer. These rammed-earth foundations are not only cost-efficient and structurally sound, but also the use of cement will also respond to the ex-Kamaiyas' interest in modern materials, thus supporting psychological comfort in regard to the structural safety of their houses.



*Figure 42.* Pattern 11: Foundations (author's sketch of rammed earth foundation, February, 2011).

## ***12. Windows and Doors***

Fenestration plays an important role in keeping a house comfortable and pleasing. Large shaded doors and windows are preferred in the hot-humid climate of western Nepal. However, larger windows can drastically increase construction costs. So, windows and doors need to be designed by considering the adequacy of size and cost of construction. Laurie Baker's concept of door openings without door frames, pivot-hinged windows of simple

vertical planks, corbel arches, and brick lintels could help reduce construction costs while maintaining required standards (Bhatia, 1991) (fig. 43).

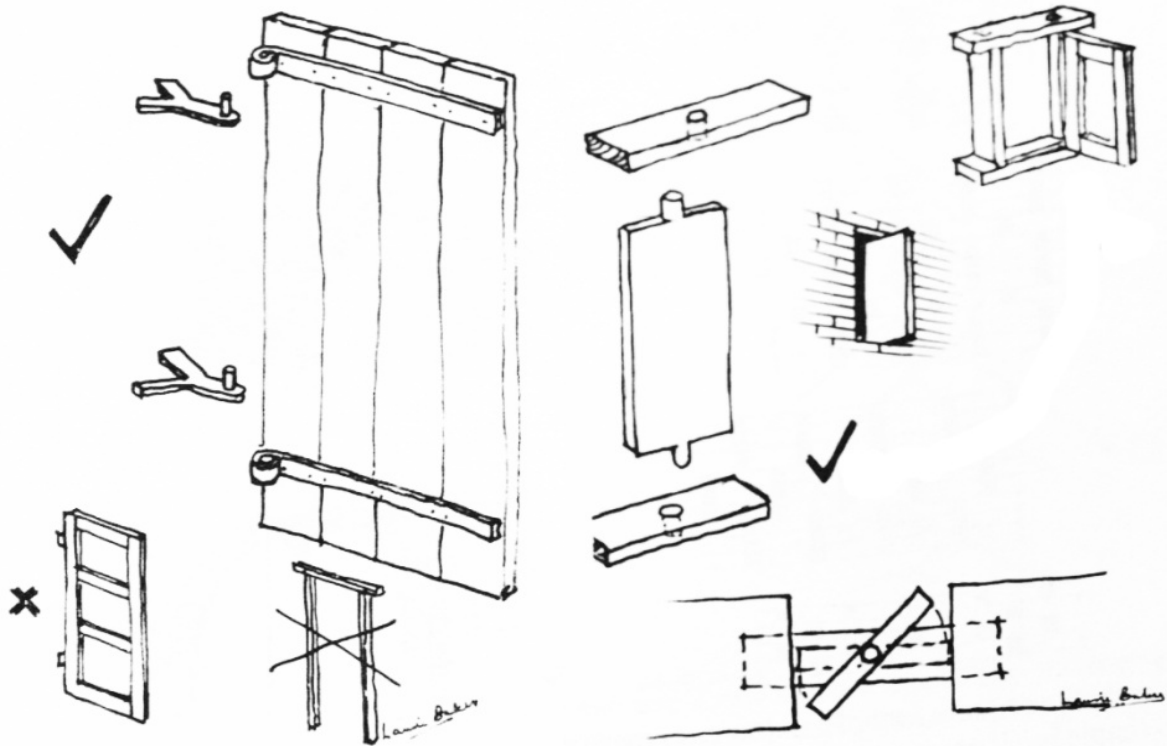

Figure 43. Pattern 12: Windows and Doors (Baker's sketch of low-cost fenestrations, from Bhatia, 1991, p. 292-293).

### 13. Bamboo for Structural Members

Bamboo is an elegant material with the strength and flexibility to be used for building structures. In traditional Tharu houses, bamboo was used to construct walls and fenestrations and to support roofs. The availability of bamboo in Nepal makes the use of bamboo in low-cost house construction relevant. Bamboo is fairly cheap and can even be harvested in one's backyard. Bamboo can be used for roof purlins, rafters, pillars, and struts. In addition, bamboo can be used to construct boundary walls, while bamboo mats can be used for ceilings. The structure of the double roof is the most important feature of ex-Kamaiya houses. Bamboo pillars and struts can be used to support the double roof system (fig. 44).

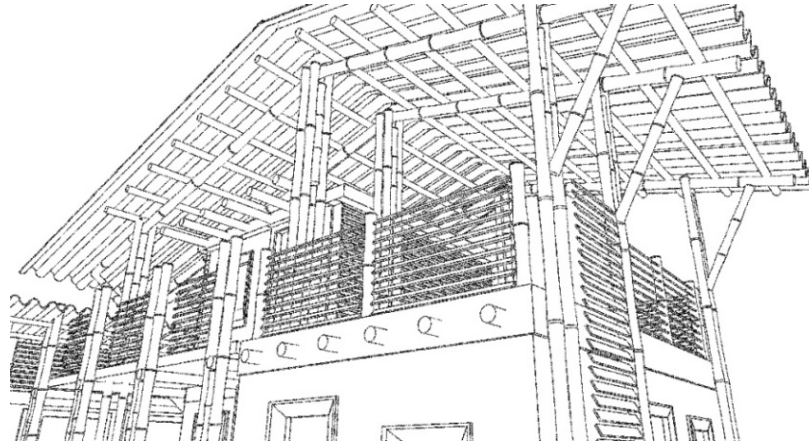

Figure 44. Pattern 13: Bamboo for Structural Members (author's drawing, February, 2011).

#### 14. Exterior Design Elements

As explained earlier, the ex-Kamaiyas are from the Tharu ethnic group, who have a rich tradition of carving and decorating exterior walls with mud plaster and paints (fig. 45). In addition, these people have special prowess in bamboo crafts which can be incorporated into the exterior design of houses. Thus, decoration of the houses, including the treatment of exterior walls, should involve personal taste thereby offering the ex-Kamaiyas a freedom to express their unique art and individuality.

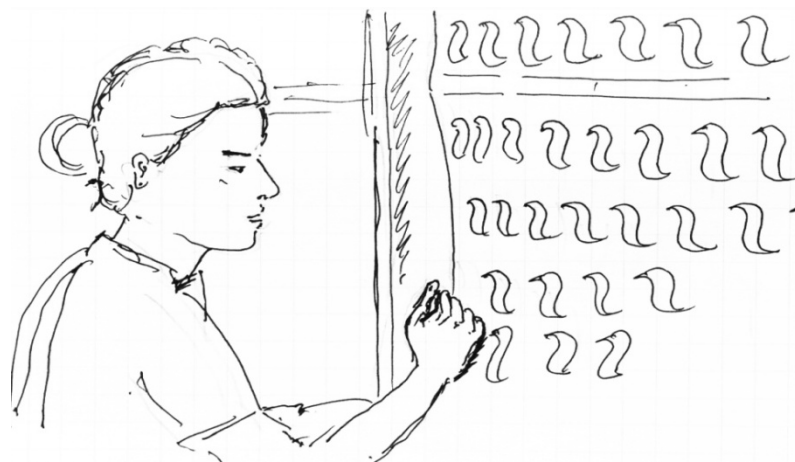

Figure 45. Pattern 14: Exterior Design Elements (author's sketch of a Tharu woman decorating the exterior walls of her house, February, 2011).

## **Houses Generated by Patterns**

In this section of the thesis, the small-scale design patterns and underlying meta-patterns for the low-cost ex-Kamaiya houses have been used to design houses for the ex-Kamaiyas in Tesanpur village. It is a hypothetical project which ensures the practicality and workability of the proposed patterns. Tesanpur is one of the three ex-Kamaiya villages that I analyzed during my field trip in summer, 2010. There are seventy-eight ex-Kamaiya families living in the identical two-room houses provided by AAN, and each family owns 0.4 acres of land. These linearly-planned rows of identical houses do not represent individual families' unique identities and have created isolated neighborhoods without any community sense.

After the redesign of existing ex-Kamaiya neighborhoods, as presented in chapter 4, the individual houses have been designed following the proposed design patterns described in the last section. The houses are designed in coordination with the ex-Kamaiyas, who were interviewed during my field visit in July, 2010. This satisfies the underlying theme of involving families in the design process so that the houses reflect the families' unique characteristics. The houses make adaptive use of traditional Tharu architecture, which gives them a style of design that reflects a sense of place, region, and culture. In addition, the houses are designed to evoke a sense of pride and security among the ex-Kamaiya families.

After studying the space requirements of ten ex-Kamaiya families in Tesanpur, I am proposing three model houses that can incorporate changes as per the necessity of the individual family. These houses are designed to incorporate the variations in space requirements, location of specific functions, and number of stories. All three model houses have a main house unit with sleeping space, veranda, and granary; and supplementary units for kitchen, toilet, and cattle shed (figs. 46-50).



The area of the main-house unit will be 350 to 450 square feet for all three houses, while the sizes of the supplementary units will vary according to individual family needs. The area of the main-house unit is also dependent upon the size of the family. It is assumed that funds for construction of the main-house unit, 2000 to 2500 US dollars, will be provided by the INGOs, while the supplementary units will be constructed and paid for by the families themselves. The families can construct these units following the construction techniques and materials used in the main unit, or the traditional bamboo and mud-brick construction depending upon their affordability.

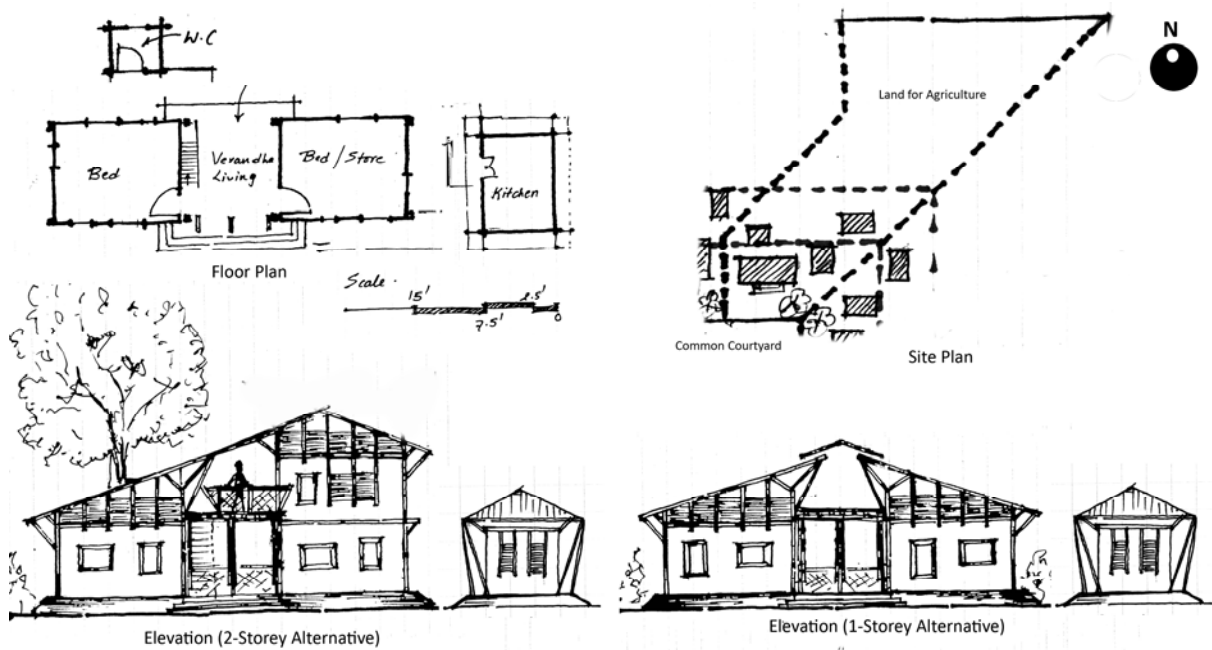
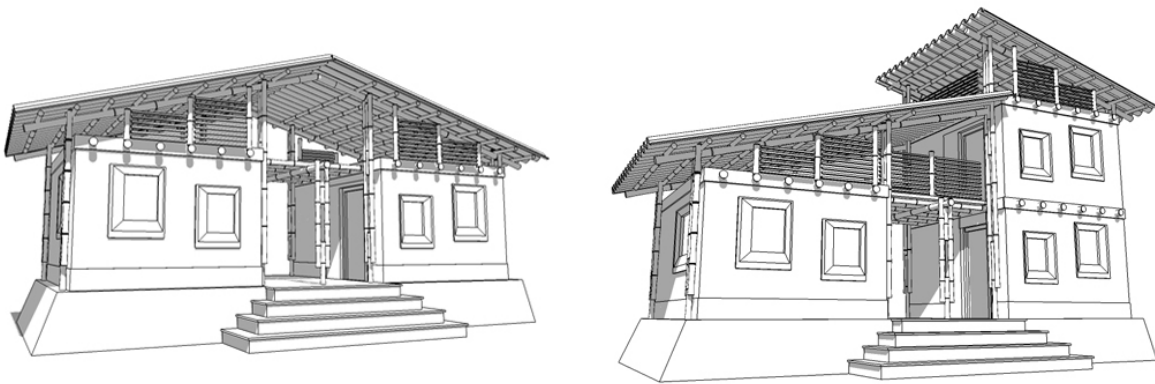

Figure 46. Author's sketches of model house 1.

The main-house unit is placed within forty feet of the front boundary line to help concentrate the houses around common courtyards and to create a better sense of community. Efficient space use and connection between spaces are considered when laying out the rooms in the main unit. The verandah has been incorporated in each house as an in-between living space linking the exterior and interior. It is designed to serve as a family sitting space, thus

bringing family members together. It shades the summer sun, and catches cool breezes-- features which make it an ideal building feature in the hot-humid climate of western Terai.

The houses have a rectangular-plan form elongated along the east-west axis with rooms located and organized so as to catch maximum natural light and cool breezes. All rooms have windows with overhangs on two walls for enhancing cross ventilation, which is a useful approach in a hot-humid climate. Windows and doors are designed following Laurie Baker's cost-effective concept of frameless doors and pivot-hinged windows (figs. 43 & 47).



*Figure 47. Author's drawings of model house 1 and its two story variation.*

A double roof consisting of a sloped upper layer of CGI sheets and a flat lower layer of bamboo and mud with a ventilation gap in-between is used in all the houses. This roof form should work well climatically and fulfills the ex-Kamaiyas' requirement for a roof of modern appearance. The roof's ventilation gap helps to moderate the house's interior temperature because the sun's heat is re-radiated from the CGI sheets and carried away by the wind. The roof overhangs are designed to keep off the summer sun and protect the walls from driving rain during monsoon. In addition, the roof form is distinct enough to evoke a sense of shelter for the family. Traditional mud floors have been proposed for the houses because they do not get excessively cold during the winter or hot during the summer. Cost-efficient and

structurally sound rammed-earth foundations have been proposed for all the houses. These are created by mixing cement, sand, and fly-ash to soil, which are rammed layer by layer.

Cost efficiency, environmental responsiveness, and comfort needs of ex-Kamaiya families are considered when selecting construction materials. CSEB blocks, bamboo, sand, mud, and cement are chosen as the main construction materials because they balance the modern needs of inhabitants with tradition and are cost-efficient. CSEB masonry walls with innovative bonding will be used for the construction of ground floor and should provide climate insulation. In turn, the first floor will be constructed from bamboo. Since the ex-Kamaiyas have a rich tradition of carving and decorating exterior walls with mud plaster and paints, the exterior finishing and decoration of the houses are left to be completed by the individual families.

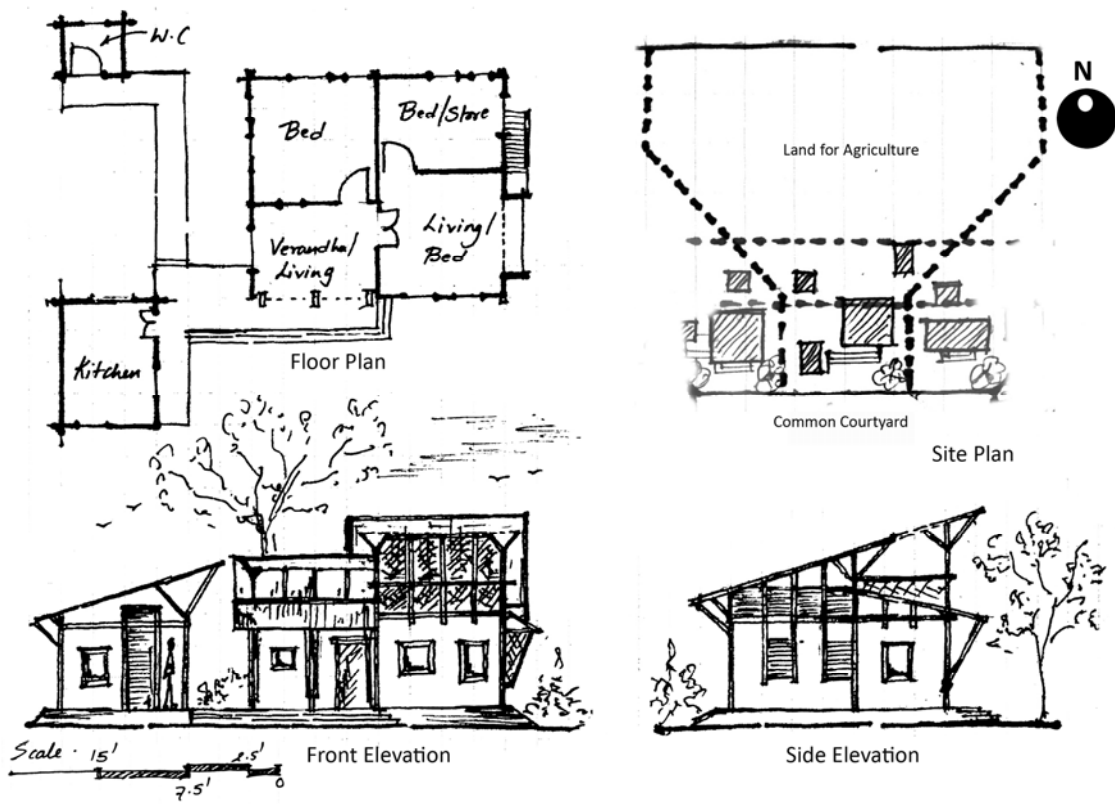
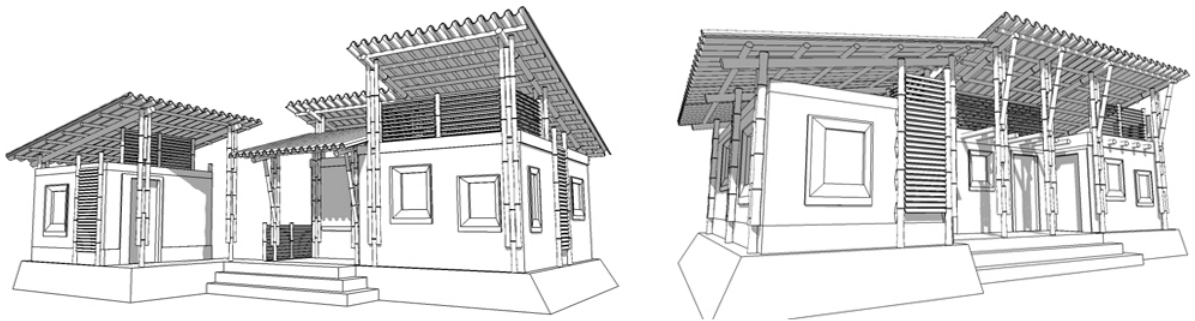

Figure 48. Author's sketches of model house 2.

Model house 1 is designed for families with one to three members. However, the two-story variation of this house can satisfy the space requirements of families with four to five family members (fig. 47). In the main house unit, the bedroom and granary are arranged on the two sides of the large central verandah, which serves as an outside living space (fig. 46). A portion of the verandah space can be used for a granary, thus providing two separate rooms for sleeping. The kitchen, cattle shed, and toilet are designed separately around the main unit. The kitchen may be incorporated in the main unit as per the requirement of individual family. Funds for construction of the main-house unit will be provided by the INGOs, while the supplementary units will be constructed and paid for by the families.



*Figure 49.* Author's drawings of model house 2 and its roof-form variation.

Model house 2 is designed for families with three to five members. It has the main house unit with three rooms arranged around the verandah (fig. 48). These rooms are used as bedrooms, granary, or living room. Since most of the ex-Kamaiya interviewees use the verandah as living space, the living room can be used for a children's bedroom. As in the case of model house 1, the kitchen, cattle shed, and toilet are designed separately. However, if the family desires, the kitchen can be incorporated in the main unit, replacing the living room. Further variation in the model house 2 is achieved by altering the roof form as shown in Figure 49.

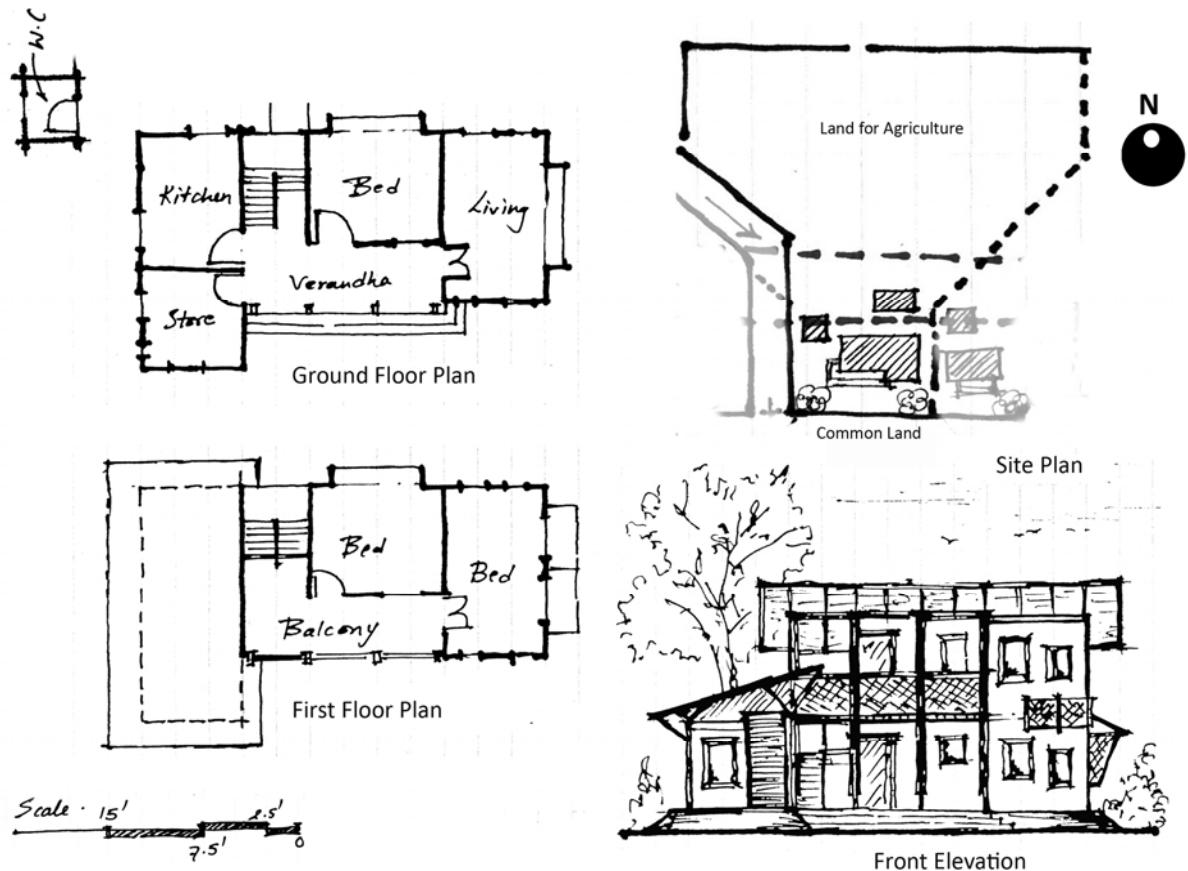
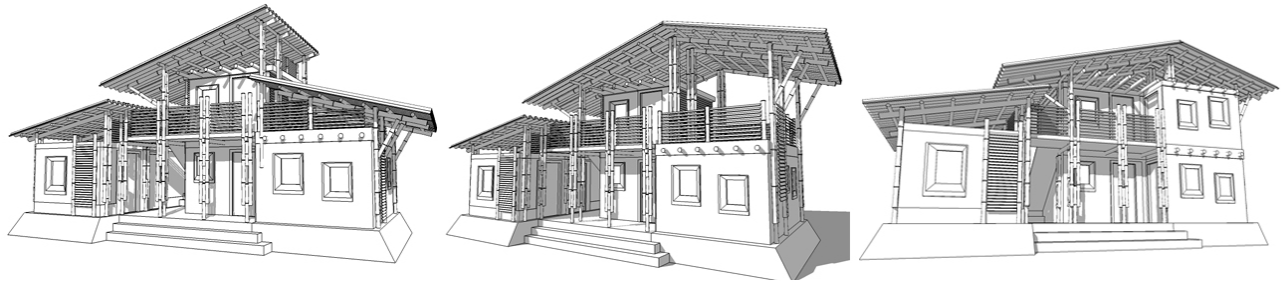

Figure 50. Author's sketches of model house 3.

Model house 3 is the largest of the three proposed dwelling designs with a two-story main-house unit. It is designed for families with four or more members. The ground floor consists of bedroom, verandah, living room, granary, and kitchen, while the first floor only has bedrooms. However, the space arrangement and location of specific rooms can be changed as per the requirement of the individual family. Further variation in the Model house 3 is achieved by altering the space usage of the first floor (fig. 51). The lower floor will be constructed with CSEB blocks, while lighter bamboo construction will be used in the first floor. This makes the construction of first floor space cost-efficient and can be paid for by the funds provided by INGOs. Though the kitchen and granary are attached to the main unit, the families will be responsible to fund the construction of these spaces (fig. 50).



*Figure 51. Author's drawings of model house 3 and its roof-form variation.*

The proposed design of ex-Kamaiya model houses for Tesanpur village demonstrates practical applicability of the pattern language approach to self-help houses for the ex-Kamaiyas. These houses will have a better sense of pride, security, and community commitment because they are based on the actual requirements of the residents and are adapted partly from the traditional Tharu houses. In addition, these houses can readily incorporate necessary changes and additions as families grow and change. The three model houses are designed after studying the space requirements of only ten families in Tensanpur. Thus, they do not represent the standard designs for all ex-Kamaiya houses in Nepal. Each house needs to be designed and constructed separately, following the design patterns explained earlier in this chapter.

## **Conclusion**

As has already been indicated, the mass housing approaches of the Nepalese government and INGOs are not able to satisfy the complex needs of the ex-Kamaiya families and communities. After analyzing the housing conditions the ex-Kamaiyas, I realized that they need a place where they can feel a sense of pride and security. In addition, they require a style of design that reflects their identities. Thus, I have proposed a new system to design and construct the ex-Kamaiya houses based on the low-cost self-help housing approaches of

Hassan Fathy and Christopher Alexander, the incremental housing concept of Balkrishna Doshi, and the cost-efficient designs of Laurie Baker. This system also considers the vernacular building tradition of the Tharus and the practical daily requirements of the ex-Kamaiyas.

This new system of producing low-cost houses is envisioned in terms of design guidelines, named as design patterns, which are arranged in Christopher Alexander's *Pattern Language* format. The design patterns emphasize the continuity of tradition, climate-responsive design, use of local materials and technology, and satisfaction of individual families' unique needs through owner-built housing. These patterns help to bridge the gap between broad philosophical qualities of self-help housing design and practical needs of the ex-Kamaiya families.

Compared to designing identical machine-like houses, the pattern language approach is more relevant in the context of self-help housing for ex-Kamaiyas because the patterns prescribe a continuing design process in which the families participate (Alexander, 1985). The process is simple but incorporates the complexities of individual and community needs. The workability of the pattern language approach to designing ex-Kamaiya houses is demonstrated by the three model houses presented in the preceding section of this chapter.

These model houses, designed by following the pattern language approach, incorporate changes and additions as per families' individual needs and establish unique identity. The built form and arrangement of these houses help to create a better sense of pride and security. Further, the houses are designed to respond to the hot-humid climate of the Terai regions. These dwellings have larger windows with overhangs, verandah as outdoor living

room, and double roof with distinct roof forms. Local materials like bamboo and mud are used as major construction materials.

Thus, the small-scale design patterns, along with the broader meta-patterns, illustrate a realistic approach to ex-Kamaiya house design and construction, which responds to variation in individual family needs, incorporates local tradition, and integrates the natural environment in a sustainable manner. The three model houses clarify and concretize the validity of these patterns. Next, the step-by-step process for the construction of these model houses is presented in chapter 6.



## **Chapter 6:**

### **Step-by-Step Construction**

As explained in earlier chapters, the pattern language is a useful approach to generating low-cost, self-help housing for the ex-Kamaiyas. The large-scale design patterns for the ex-Kamaiya neighborhood design respond to community needs, incorporate local tradition, ensure community involvement, and integrate the natural environment in a sustainable manner. Thus, lively neighborhoods with unique community identities can be created which also satisfies the hygienic needs and sense of openness that many ex-Kamaiyas desire. On the other hand, the small-scale design patterns for the ex-Kamaiya house design help generate low-cost, region-specific, and climate-responsive houses that can express individual families' unique identities and generate a sense of pride and security.

Thus, it is clear that the proposed system of ex-Kamaiya housing production is in many ways an advance over contemporary mass housing solutions where identical houses are repeated over and over. However, it needs to be made clear whether all these unique houses can be produced in an orderly manner such that they do not cost more than the houses produced by contemporary mass housing. Alexander (1985) argues that, through standardization of the construction process by dividing construction into various steps, the required cost economy can be achieved without compromising the uniqueness of owner-built houses.

Contemporary mass-housing production systems, based on standardized building components, prohibit architectural variation and are inflexible with respect to adding a human touch according to a personal taste (Alexander, 1985, p. 220). Though contemporary mass housing may have led to the production of houses more rapidly and economically, these

identical, machinelike houses cannot express the individual identities of different families (ibid.). Instead, the houses appear isolated, fail to create human bonds, and thus the neighborhood lacks a sense of community (ibid.).

Thus, Alexander argues for a more participatory housing-production system which can satisfy individual needs and choices: “The detailed adaptation of a house to its inhabitants must go all the way down to the details of construction; it cannot stop short, in the plan.... replace the idea of a building system as a system of components to be assembled, with a step-by-step system of building operations” (ibid., p. 221). Alexander’s low-cost housing project in Mexicali, Mexico, is an excellent example of a participatory design-build approach in which individual needs and choices are met by involving families at every level of design and construction.

In the Mexicali housing, Alexander followed a step-by-step construction process divided into twenty-three operations: laying stakes, excavation of soil, placing wall foundations, erecting columns, erecting walls, placing roofs, and so forth as shown in table 2. He argues that these individual operations can be applied freely to each house to create a structurally sound building without the need for working drawing for each individual building (ibid., p. 209). The completion of each construction operation gives a great sense of accomplishment to residents and the fact that they themselves are involved in the construction adds a sense of joy to the process (ibid.).

*Table 2. Step-by-step construction process for Mexicali Housing, Mexico*

Step 1	Lay out Stakes
Step 2	Excavate and Neutralize Soil
Step 3	Place Corner Stones
Step 4	Place Wall Foundations
Step 5	Prepare Slab
Step 6	Place Under-Slab Plumbing
Step 7	Pour Slab
Step 8	Erect Columns
Step 9	Erect Walls between the Columns
Step 10	Install Door Frames
Step 11	Build Perimeter Beams
Step 12	Weave Roof Baskets
Step 13	Erect Gable Ends
Step 14	Install Electrical Circuits
Step 15	Place Roof First Coat
Step 16	Place Roof Top Coat
Step 17	Install Window Frames
Step 18	Build and Install Windows
Step 19	Build and Install Doors
Step 20	Install Plumbing
Step 21	Install Electrical
Step 22	Paint Walls, Roofs, and Trim
Step 23	Lay Brick Floors on Walks and Arcade Floors

Thus, rather than creating monotonous rows of standard housing blocks for the sake of economy, a standard process of construction can create houses according to the unique needs of the residents and still remain cost-effective. Following Alexander's approach of step-by-

step construction as explained in *The Production of Houses*, the construction process of the proposed ex-Kamaiya housing has been divided into a set of fifteen steps that will be defined individually such that they can be easily used to construct the ex-Kamaiya houses that adapt to families' unique needs and identities. These fifteen steps are summarized in table 3.

*Table 3. Step-by-step construction process for the ex-Kamaiya Housing*

Step 1	Laying out Stakes
Step 2	Excavating Trench for Foundations
Step 3	Placing Foundations
Step 4	Building Plinth
Step 5	Erecting CSEB Perimeter Walls
Step 6	Placing Perimeter Beam
Step 7	Constructing Floor
Step 8	Placing Doors and Windows
Step 9	Installing Electrical Circuits
Step 10	Erecting Bamboo Pillars
Step 11	Preparing Framework for Roof
Step 12	Placing CGI Sheets
Step 13	Preparing Ground Floor
Step 14	Preparing Front Yard
Step 15	Painting and Decorating Walls

These fifteen construction steps for the production of ex-Kamaiya houses follow the criteria delineated by Alexander in *The Production of Houses*. These construction operations are planned to be consistent with the patterns used to design the houses. Each construction step is complete in itself, which according to Alexander (1985) helps to create a sense of accomplishment as each step is finished. Though Alexander argues for a rough layout

designed directly on the ground without any dimensional constraints from paper drawings, the proposed steps follow a simple hand-made design drawing set produced in coordination with the families. This helps to pace the construction operations with minimal confusion, and saves lengthy modification time required while designing and laying out plans directly onto ground. In the next section, I overview each of the fifteen construction steps in turn.

### **Step 1: Laying out Stakes**

After the preparation of rough design drawings in coordination with the ex-Kamaiya families, the first step towards the construction of a house is to mark out the foundations for excavation by laying out wooden stakes. The foundations will support the load-bearing CSEB walls. However, before marking the foundations, the top soil on the site needs to be removed and stacked in a corner of the site to be reused later for landscaping.

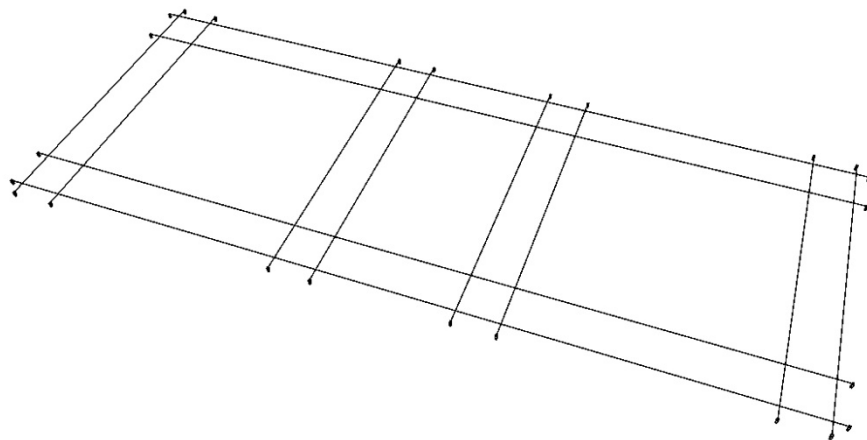

*Figure 52. Step 1: Laying out Stakes (author's drawing, March, 2011).*

It is important to mark exactly the width of the trench to avoid wasting the filling-mix. For a one-story, load-bearing building, foundations should be twenty inches deep and twenty inches wide. The foundations must be marked by wooden stakes hammered into the ground

such that excavation will not disturb them. Next, strings should be tied to the stakes to represent the width of the foundations (fig. 52). Lime powder or kitchen ash can be used to mark the foundation width on the ground.

## **Step 2: Excavating Trenches for Foundations**

After the width of the foundations is marked, a foundation trench should be dug accurately to the required length, width, and depth. The excavated soil need not be moved away, as it can be used to prepare the foundation-mix to be rammed (fig. 53). The soil should be thrown onto a sieve placed on top of a frame, which is within the trench outline. Once the frame is filled, the sieve and frame should be removed and the soil is later mixed with sand and cement in the proportion of 10:4:1 for the foundation-mix. The same procedure should be followed to dig and fill the frame. Before the foundation is fully excavated, a tube level should be used to mark the top level of the foundation at each corner.

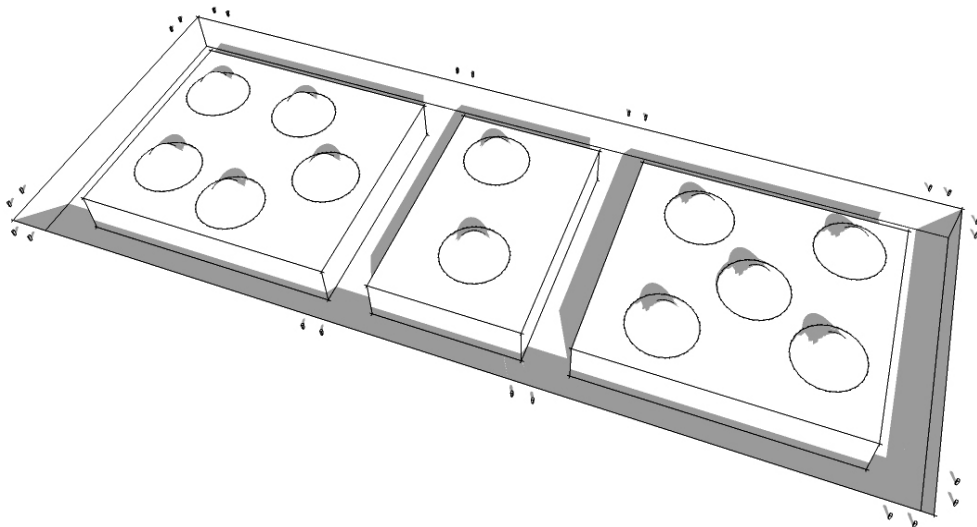
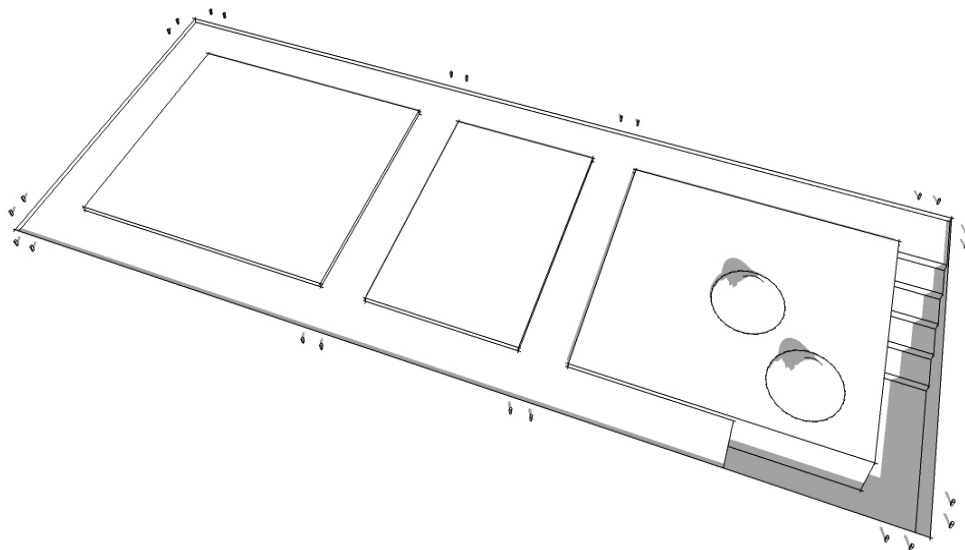

*Figure 53.* Step 2: Excavating Trench for Foundations (author's drawing showing foundation trench and soil heaps to be used for foundation mix, March, 2011).

### Step 3: Placing Foundations

As explained earlier in chapter 5, rammed-earth foundations made from a dry mix of cement, sand, and soil is best for the foundations. If fly ash is available, it can be used to replace up to fifty percent of the cement in the mix. The cement, sand, and soil must be first mixed thoroughly, to get a uniform color and homogenous mixture. Then, water is added to moisten the mixture and further mixed a couple of times.

Before placing the complete foundations, steps should be prepared in one corner of the trench representing the foundation ramming layers (fig. 54). A twenty-inch-deep foundation can be divided into five steps, each representing four-inches of foundation layer. Then the foundation mix must be placed in the trench and rammed to four-inch thick layers. Each layer must be sprinkled with water before adding another layer on to it for enhancing the bonding between the layers. The top layer of the foundations must be leveled with the ground level.



*Figure 54.* Step 3: Placing Foundations (author's drawing showing steps which represent foundation ramming layers, March, 2011).

## Step 4: Building Plinth

On top of the foundation, a plinth with a height of eighteen-to-twenty-four inches should be constructed from CSEB blocks (fig. 55). The lower one-third of the plinth must be eighteen inches thick, while the upper portion must be fourteen inches thick with a gap to hold the bamboo columns. A layer of coal tar, as a damp-proof membrane, should then be laid on the plinth, upon which a three-inch-thick and nine-inch-wide reinforced concrete beam is placed as a ring beam. Form work and steel reinforcement for the ring beam must be carefully placed before pouring the concrete so that the damp-proof membrane is not disturbed. The ring beam should also have holes at the corners to hold the rebar reinforcements for the CSEB walls. On the outside, an earth filling can be sloped from the plinth level to the ground level to help stabilize the plinth. The space between the CSEB walls should be filled with the soil excavated from the foundation trench and compacted.

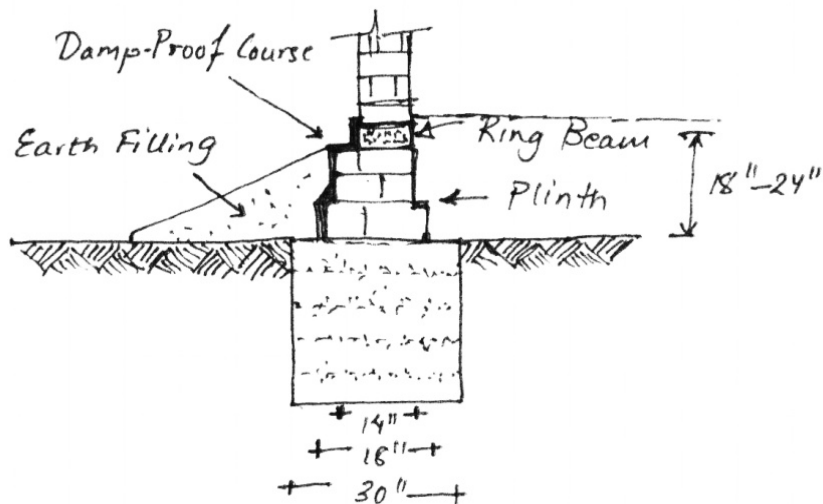

*Foundation & Plinth Section.*

Figure 55. Step 4: Building Plinth (author's sketch, March, 2011).



## Step 5: Erecting CSEB Perimeter Walls

Before erecting the CSEB walls, the plinth and the holes to hold the rebar reinforcements should be cleaned. The corner rebar reinforcement should be erected along with the nine-inch-thick CSEB walls. CSEB blocks, available in the size of normal bricks, should be laid with an interior air space that works as insulation and also reduces the amount of blocks and bonding mortar by twenty-five percent without losing strength (fig. 56). The uppermost layers of the walls should be constructed without an air gap. While erecting the walls, the position of doors and windows should be fixed, and hinges should be placed to hold the doors and windows. Wooden lintels can be used rather than reinforced concrete lintels for cost-effectiveness, and wooden lintels, in the form of pivot-hinged windows, can replace the upper horizontal wooden member that holds the window shutter (fig. 43).

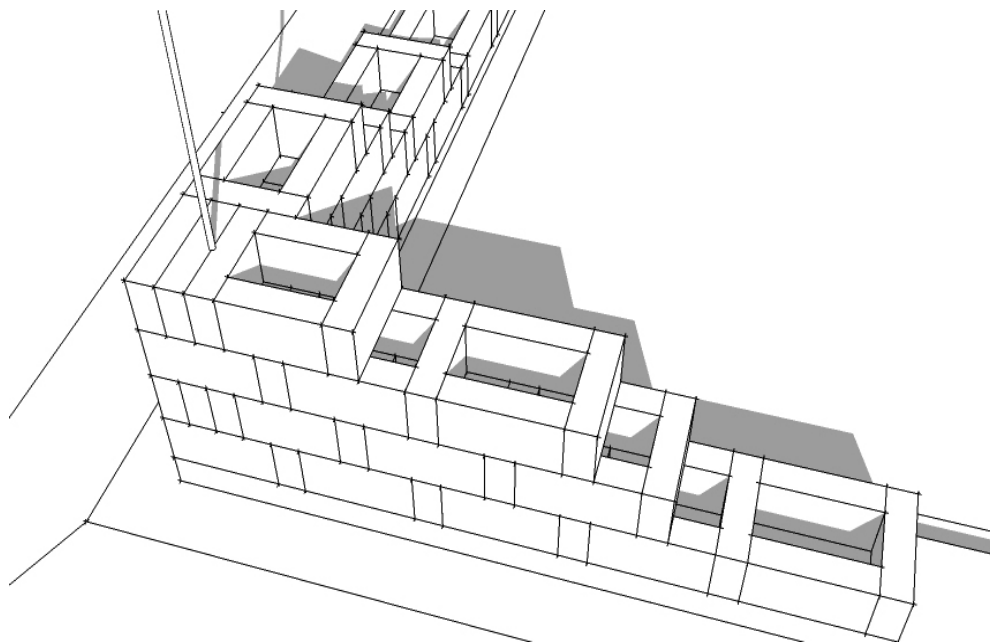

*Figure 56.* Step 5: Erecting CSEB Perimeter Walls (author's drawing, March, 2011).

## Step 6: Placing Perimeter Beam

After the last course of CSEB blocks is laid, a perimeter beam must be placed to hold the walls together and support the bamboo beams. Two wooden perimeter beams, three-inch-by-three-inch in cross section each, should be laid along the walls with a gap of three inches in between the two beams (fig. 57). These two beams must be nailed to wooden pieces at an interval of at least three feet.

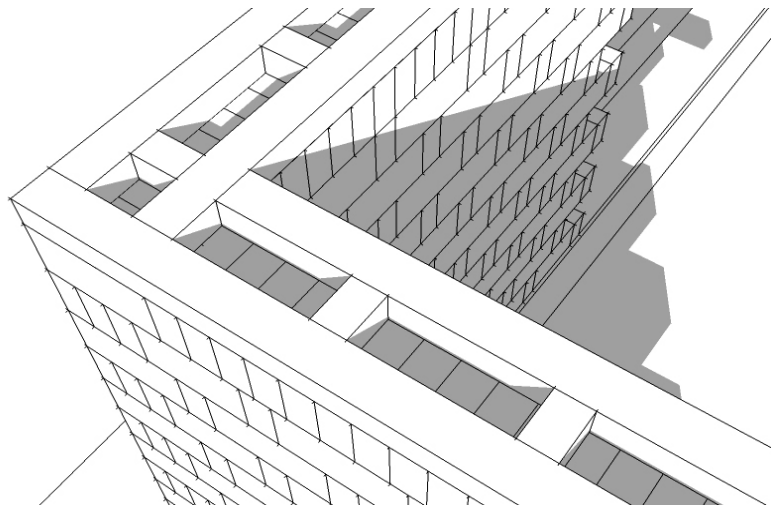

*Figure 57. Step 6: Placing Perimeter Beam (author's drawing, March, 2011).*

## Step 7: Constructing Second-Story Floor

As explained in chapter 5, for climate-responsive design and cost-efficiency, a traditional mud floor is better than a cement floor. This mud floor can be supported by bamboo beams placed at one-foot intervals. The bamboo must be soaked in a borax (5%) and alum (10%) solution for two days to protect against insects and fungus. The bamboo beams are placed on the wooden perimeter beams and joined by nails and hemp ropes. On top of the bamboo beams are placed cut-bamboo pieces as planks to hold the mud floor. The bamboo planks are fastened together with ropes. Then two inches of mud, sand, and cement mix (in the proportion of 15:3:1) is poured and leveled.

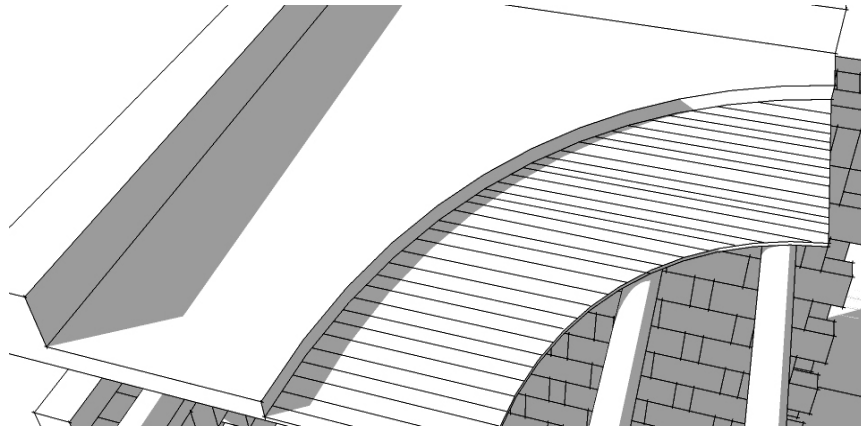

*Figure 58. Step 7: Constructing Second-Story Floor (author's drawing, March, 2011).*

### **Step 8: Placing Doors and Windows**

After the walls and floors are constructed, the doors and windows should be placed. The position of doors and windows has already been fixed while constructing the walls. However, before placing the doors and windows, the amount of light in each room should be checked and necessary modifications should be made. Then the size of openings needs to be measured to prepare the shutters. Since the hinges to hold the doors are already placed, the door shutters should now be attached. In regard to the windows, the openings have wooden sills and lintels with holes to hold the pivot-hinge shutters (fig 59).

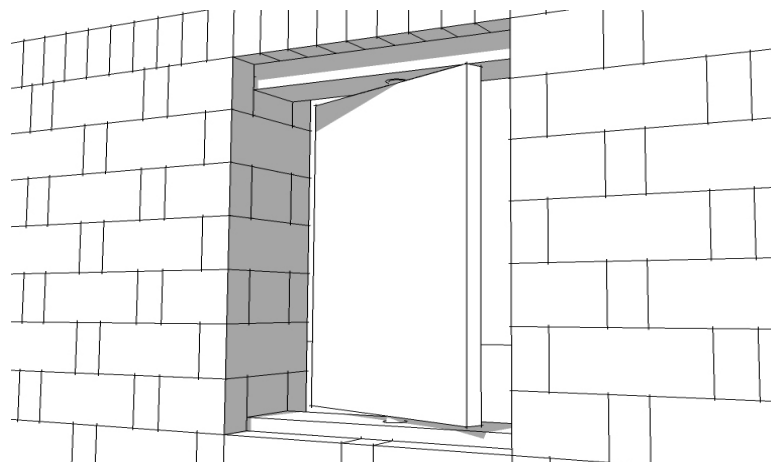

*Figure 59. Step 8: Placing Doors and Windows (author's drawing of pivot-hinge window, March, 2011).*

## **Step 9: Installing Electrical Circuits**

The main-house units will not have a plumbing system for water supply and sewage or heating and cooling. Rather, the houses will have community taps for water supply and toilets in the back yard. Thus, the only service infrastructure to be incorporated into the ex-Kamaiya houses is electrical circuits. Insulated copper wires should be laid along the walls, six inches high from floor level from the main distribution box to the fixtures. After the wires are placed, switches, outlets, and light fixtures should be placed.

## **Step 10: Erecting Bamboo Pillars**

Chemically treated bamboo can be used as pillars to support the sloped roof. The bamboo pillars can be used as an aesthetic element too by joining two or three bamboo together to form a more attractive bamboo pillar (fig 60). In addition, understanding the joints between structural-bamboo members is important. The simplest system recommended here is to tie the bamboo with hemp rope.

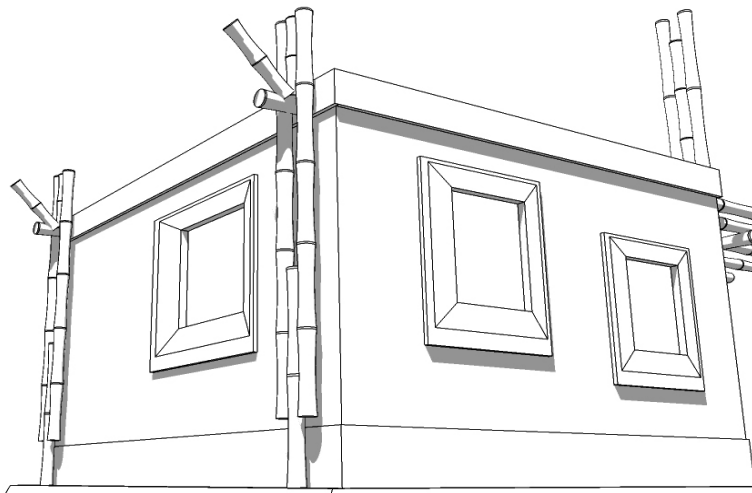
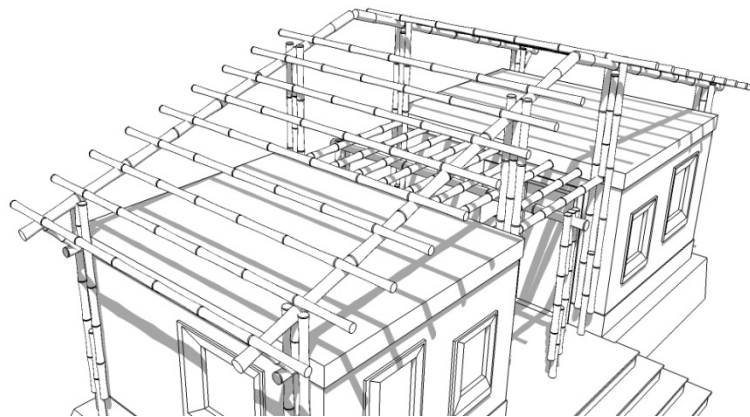

*Figure 60.* Step 10: Erecting Bamboo Pillars (author's drawing, March, 2011).

Before erecting the bamboo pillars, the gap made on the plinth to hold these pillars must be cleaned. The required height of the pillars should be measured, and the bamboo pillars are prepared. After the pillars are erected, they should be tied to the bamboo-floor beams to hold them in place (fig 60). The bamboo pillars shown in Figure 60 have a lower member tied to two middle members. In turn, the middle members are tied to the top member that supports the roof rafters. These pillars can also integrate bamboo struts to support the roof overhangs.

### **Step 11: Preparing Framework for Roof**

As explained in chapter 5, the proposed roof is a double roof consisting of a sloped upper layer of CGI sheets and a flat lower layer of bamboo and mud. The lower layer is constructed from mud supported by bamboo planks and beams. In the case of the upper layer of the roof, first, the structural framework must be prepared to support the roof coverings. With the scarcity of other wood, treated bamboo becomes a viable option. The bamboo rafters should be supported by the bamboo pillars. These rafters then support the bamboo purlins on to which the CGI sheets can be placed. The bamboo pillars, rafters, and purlins should be tied together by hemp rope.



*Figure 61. Step 11: Preparing Framework for Roof (author's drawing, March, 2011).*

## Step 12: Placing CGI Sheets

CGI sheets are chosen for roofing instead of traditional khapada tiles because these tiles require scarce firewood for their production. In addition, CGI sheets satisfy the ex-Kamaiyas' interest in contemporary construction materials. After the structural framework of bamboo rafters and purlins are placed, the CGI sheets are laid (fig. 62). They can be hooked or nailed to the bamboo purlins. The CGI sheets need to be placed such that their ends overlap one another four-to-six inches. Finally, the roof ridge cover and rain-water gutters should be placed.

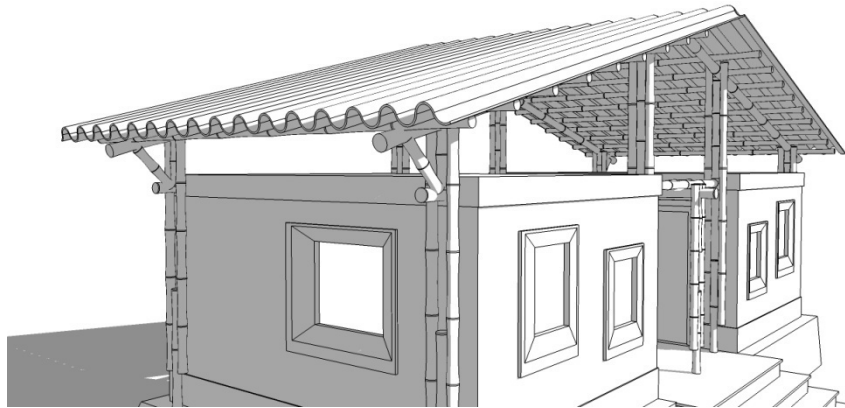

*Figure 62.* Step 12: Placing CGI Sheets (author's drawing, March, 2011).

## Step 13: Preparing Ground Floor

After the roof is ready, the next step is to finish the floors of the rooms and verandah. The soil filling should be first rammed to an even level. On top of this compacted soil, four inches of sand should be place and rammed for compacting. A tube level should be used to level the floor. Then cement-sand mortar (1:5) should be spread; over the mortar is laid the CSEB tiles. The mortar creates a bond between the sand layer below and the CSEB tiles.

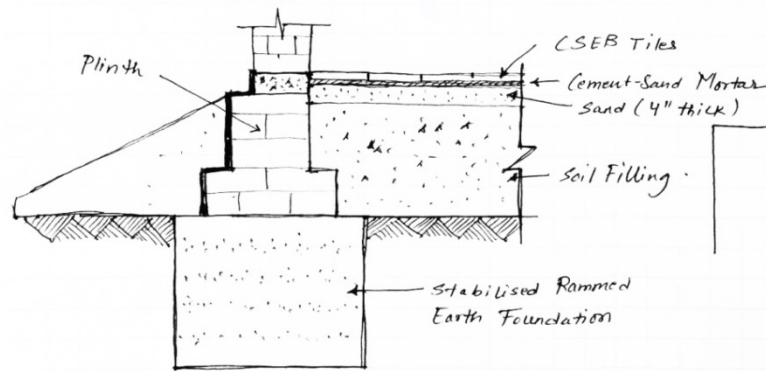

Figure 63. Step 13: Preparing Ground Floor (author's sketch of ground floor finish , March, 2011).

### Step 14: Preparing Front Yard

The back yard of the houses will have a cattle shed and farm lots that will be developed later by the families themselves. The yard in front of the main-house unit will be prepared as part of the main building and can be used as a space for drying crops, sitting, and children's play. Thus, to prevent muddiness during the monsoon, a hardened surface is preferred for the front yard. First, the yard should be dug about ten inches deep. The soil from the trench, except the top soil, should be mixed with sand and cement (in the proportion of 15:3:1). Then water is added to this dry mix to moisten it. The mix can then be placed into the trench in layers of three or four inches and rammed to level with the ground.

### Step 15: Painting and Decorating Walls

The final step in the construction of an ex-Kamaiya house is painting and decorating the walls. Decoration of the houses, including the treatment of interior and exterior walls, should involve personal taste and offer the ex-Kamaiyas a freedom to express their unique art

and individuality. Since the ex-Kamaiyas have rich traditions of wall carving and decorating exterior walls with mud plaster and paints, the designing and finishing of walls can be left to the families themselves.

## **Conclusion**

The self-help, low-cost housing production system proposed here overcomes many of the drawbacks of contemporary mass housing. This system, based on the *Pattern Language* format, might play a central role in producing lively neighborhoods and houses that express individual families' unique identities. Through the standardization of the self-help construction process, these houses can be built in an orderly manner staying within the cost limits of contemporary low-cost housing. The fifteen construction steps discussed earlier describes a standard building process in which cost economy can be achieved without compromising the unique features of owner-built houses.

As explained earlier, the fifteen construction steps are based on Christopher Alexander's step-by-step construction approach for producing housing in Mexicali, Mexico. The ex-Kamaiya houses produced will each include a main-house unit and secondary units. The fifteen-step construction process, however, only explains the construction of the main-house unit. The construction for the secondary-house units will depend on the ex-Kamaiya families, as they will need to bear the cost themselves. They can either follow the proposed construction steps for houses or draw on their knowledge of traditional construction techniques.

The proposed step-by-step construction system is based on my study of traditional Tharu construction techniques and my knowledge of contemporary materials and technologies available in Nepal. Thus, the process needs to be practically tested before application to the



actual production of ex-Kamaiya houses. Some of the construction steps are based on theoretical knowledge, so empirical testing of these ideas is indispensable.

For example, the double roof construction supported by bamboo pillars is a new building technology for Nepal and needs proper testing before application. It must be evaluated for its structural soundness during strong winds and for climate-effectiveness during hot summer days. The proposed treatment of bamboo is based on the current method used in the Terai regions of Nepal, and probably more cost-effective and better bamboo treatments need to be researched. Also needing testing is the proposed system of structural-bamboo joints tied with hemp rope.

One of the important assumptions made here is that CSEB blocks can effectively replace contemporary bricks. Thus, the availability of CSEB blocks and the viability of their on-site production need to be further researched. In addition, the dimensions of proposed rammed-earth foundations and the foundation mix is based on rule-of-thumb. The structural viability and safety of these foundations need to be further researched by structural analysts.

Once the proposed construction process is thoroughly tested, it can be applied to the production of ex-Kamaiya houses. The application of this construction process divided into fifteen steps should ensure cost-effectiveness and an orderly construction of houses with varying designs as per individual family's requirements. In addition, these construction operations would be consistent with the proposed patterns and carried out by the family members themselves. Thus, the completion of each construction step should create a sense of accomplishment, which can't be experienced in mass manufactured houses.

## **Chapter 7:**

### **Conclusion**

This thesis has sought to provide an effective method for building low-cost dwellings for the ex-Kamaiyas, the poorest and most underprivileged Nepalese people, who are either without housing or living in sub-standard units. Based on my interviews with the ex-Kamaiyas, an analysis of Tharu vernacular architecture, and a study of popular self-help housing approaches around the world, the thesis has provided design guidelines for planning, designing, and building low-cost houses and neighborhoods.

The modernist housing approach of residential towers and mass-manufactured dwellings is not always a correct approach to low-cost housing. An appropriate combination of vernacular traditions and modern technology is the key to successful low-cost housing because it responds to local culture and climate, while fulfilling individual needs (Fathy, 1993). In addition, the use of socially-oriented and co-operative construction technologies makes the involvement of people in building their dwellings more viable. This approach also reflects individuals' uniqueness, social customs, and culture. The proposed ex-Kamaiya housing production system involves families in design and construction by using simple construction techniques and materials drawn from traditional Tharu architecture. This helps the ex-Kamaiyas establish their lost socio-cultural pride while creating architecture which has the primacy of human values.

Housing is an elemental human process in which social bonds are created and human dignity is established (Alexander, 1985). A participatory housing-production system in which individual needs and choices are addressed is an important approach to this elemental human process. Thus, the involvement of the community during the design and construction of

individual houses as well as the planning and layout of neighborhoods is a key aspect of the proposed housing production system, which helps create a self-generated and continually adaptive neighborhood that is consistent with the concept of incremental housing. In addition, this housing system uses the creativity of ordinary people to build responsible architecture, which meets individuals' unique requirements while remediating the monotony of standardized housing.

The thesis lays out these ideas in the form of design guidelines, which have been called design patterns. These patterns help to bridge the gap between broad philosophical qualities of self-help housing design and practical needs of the ex-Kamaiya communities. The idea is that the INGOs, as well as the families themselves, follow the design patterns in planning, designing, and constructing the ex-Kamaiya neighborhoods and houses. There are large-scale design patterns for neighborhood design and small-scale design patterns for individual house design; their practicality would be tested by designing and building an ex-Kamaiya neighborhood and houses.

The large-scale patterns might potentially create lively neighborhoods with a unique community identity, satisfy the hygiene needs, and generate a sense of openness. The neighborhood design of Tesanpur, presented in chapter 4, demonstrates the appropriateness of the larger-scale patterns in planning ex-Kamaiya communities. Neighborhood clusters are created by arranging houses around a central courtyard, which is the heart of community activities. These clusters are then arranged around the main village center, which plays a major role in the economic and social sustainability of the project.

Next, the smaller-scale design patterns illustrate a realistic approach to ex-Kamaiya house design and construction, which responds to variation in individual family needs,

incorporates local tradition, and integrates the natural environment in a sustainable manner. The three model houses presented in chapter 5 clarify and concretize the validity of these patterns. These houses incorporate changes and additions as per families' individual needs, and establish unique identities and sense of pride. The dwellings have large windows with overhangs, a verandah as outdoor living room, and a double roof with distinct roof forms to respond to the hot-humid climate of the Terai regions. In addition, these houses draw from Laurie Baker's idea of innovative use of local materials and traditional building techniques, and incorporate low-cost design features like frame-less openings and innovative brick bonding.

Another important aspect of the proposed low-cost housing production system is the standardization of the construction process. Though cost-efficiency in contemporary mass-housing is achieved through standardized building components, the resulting dwellings lack architectural variation and a human touch. Thus, this thesis delineated fifteen standard construction steps for building an ex-Kamaiya house through which the required cost-efficiency can be achieved without compromising the uniqueness of owner-built houses.

The proposed method of housing is an important alternative to current approaches of INGOs. The ex-Kamaiyas have their own unique culture, tradition, lifestyle, and vernacular architecture. Adaptive use of vernacular architecture to fit with modern requirements is an appropriate approach to low-cost housing. Affordability is another aspect of building construction that vernacular architecture addresses because it uses local materials, indigenous technology, and native manpower. However, the houses provided by INGOs do not typically draw on vernacular architecture; their construction approach mirrors and follow contemporary

mass housing trends. In contrast, the proposed method offered in this thesis makes adaptive use of vernacular Tharu architecture while incorporating contemporary needs of the families.

The Nepalese government has provided lands for the ex-Kamaiyas, while the INGOs have worked to provide shelter. However, there is a lack of coordination between the government and the INGOs, which has resulted in low-density, linearly-planned settlements without a sense of community and standard box-like houses without identities. The housing production system proposed in this thesis is based on the positive aspects of Tharu vernacular architecture and planning, while incorporating the modern requirements of the ex-Kamaiyas. The proposed neighborhood clusters are smaller than traditional cluster settlements, but have a larger common space. The houses are placed close to each other to eliminate social isolation, while a sense of openness is maintained by the larger central common courtyard.

As conventional modernist public housing failed to address the problem of low-income housing shortages, the idea of self-help housing has arisen (Ward, 1982, p. 7). The sense of autonomy, pride, and responsibility that families potentially come to know by constructing houses themselves are important aspects of self-help housing. The concept of owner-built houses is more relevant in the context of low-cost housing for the ex-Kamaiyas who have traditional design and construction skills. The INGOs have not, however, utilized the ex-Kamaiyas' skills to their full potential, but have limited the ex-Kamaiyas' efforts to unskilled labor. In contrast in this thesis, the proposed design patterns for ex-Kamaiya houses focus on involving families in the design as well as in the construction as skilled manpower. Simplification of the construction methods and use of local materials are given importance, which make the owner-built houses more relevant.

Sense of place is another issue that the proposed housing method offered in this thesis attempts to actualize. The problem of a lack of sense of place is severe in the context of low-cost housing for the poor. The machine-like houses repeated over and over again in the current ex-Kamaiya houses provided by the INGOs create a dull landscape which fails to support place identity. In the ex-Kamaiya communities that have nearly lost their identity while being labor-bonded, it is important to restore the unique socio-cultural landscape and built environment to create a sense of place. The method proposed here focuses on the use of local technology, indigenous design and planning methods, local construction materials, and community involvement to maintain the sense of place.

Contemporary mass housing strategies followed by the INGOs have not regularly been able to realize the needs of community and individual; they no doubt will eventually become unsustainable. In contrast, the housing method proposed here is more in tune with sustainability. The method is socially sustainable as it promotes a sense of community and safety, while ensuring the physical and psychological well-being of the people. By empowering the ex-Kamaiya families and involving them in the design and construction of their houses, the process becomes affordable, and thus, economically sustainable. In addition, adaptive use of vernacular construction techniques, climate-responsive design, and local materials makes the process environmentally sustainable.

The proposed low-cost housing production system, however, has some limitations. As explained earlier, the Nepalese government has been providing land to the ex-Kamaiya families plotted in a rectilinear grid-iron pattern. Thus, in the case of the ex-Kamaiyas who have already received plots, the proposed housing production system requires these plots to be re-plotted around a central common land. This re-plotting is important to achieve the house

clusters, which is one of the important aspects of the neighborhood design. However, it may not be easy to receive general consensus from all the ex-Kamaiya families for this process.

Another weakness of the low-cost housing production method proposed here is the difficulty of cost control. Though the standardization of building construction methods ensures cost-effectiveness and an orderly construction of houses with varying designs as per individual family's requirements, the cost of houses will vary. This variation may result in difficulties for INGOs to separate funds for individual families. The usual trend has been to allocate equal amounts of money to each ex-Kamaiya family and build identical machine-like houses irrespective of the number of family members. Thus, a more compressive and organized effort is necessary in allocating funds, based on the family size and space requirements.

Another limitation of the system offered here is that the proposed construction operations are not based on empirical findings and do not take seismic and wind-load factors into consideration. Rather, these construction steps are grounded in my study of traditional Tharu construction techniques and my knowledge of contemporary materials and technologies. Thus, the construction process needs to be practically tested, and detail calculations of seismic and wind load need to be done before applying the process in the actual production of ex-Kamaiya houses. For example, the double roof supported by bamboo pillars is a new building technology for Nepal and needs to be tested for its structural safety and climate-responsiveness. Since CSEB blocks are the main construction materials, their availability and on-site production need to be further researched. In addition, most of the proposed constructions are based on rules of thumb and need additional research and experimentation.

The proposed system of low-cost housing production emphasizes incremental housing and socially-oriented construction techniques. It is assumed that as the families grow, they will make necessary additions to their houses by themselves. This thesis, however, does not address the broader issue of neighborhood growth and community enlargement. Thus, this issue of community growth needs to be further researched before implementing the proposed housing production system.

Even with these limitations, however, the proposed ex-Kamaiya housing production method is viable and realistic. The limitations can be overcome by working in coordination with the government providing land, the INGOs providing funds to build houses, and the ex-Kamaiya families. In addition, the proposed design patterns and construction process can be empirically tested before application to actual production of ex-Kamaiya houses. Thus, this thesis provides a significant and viable alternative for the production of low-cost ex-Kamaiya housing. It provides guidelines for the design and layout of individual houses for the ex-Kamaiyas; guidelines for the planning of a typical ex-Kamaiya neighborhood, including the layout of community spaces and streets; and a step-by-step guide for the construction of the houses.



## References

- Abrams, C. (1946). *The future of housing*. New York: Harper & Brothers.
- Alexander, C. & Center for Environmental Structure. (1969). *Houses generated by patterns*. Berkeley, Calif.: Center for Environmental Structure.
- Alexander, C., Ishikawa, S., & Silverstein, M. (1977). *A pattern language: Towns, buildings, construction*. New York: Oxford University Press.
- Alexander, C. (1985). *The production of houses*. New York: Oxford University Press.
- Alexander, C. (2002). *The process of creating life*. Center for Environmental Structure series, 10. Berkeley, Calif: Center for Environmental Structure.
- Alexander, C., & Center for Environmental Structure. (2005). *A vision of a living world: An essay on the art of building and the nature of the universe*. The Center for Environmental Structure series, v. 11. Berkeley, Calif: Center for Environmental Structure.
- Alexander, C. (2008). Generative codes: The path to building welcoming, beautiful, sustainable neighborhoods. In T. Haas (Ed.), *New urbanism and beyond: Designing cities for the future*. (p.14-29). New York: Rizzoli.
- Bhatia, G., & Housing and Urban Development Corporation (India). (1991). *Laurie Baker, life, work, writings*. New Delhi, India: Viking.
- Brown, G. Z., & DeKay, M. (2001). *Sun, wind & light: Architectural design strategies*. New York: Wiley.

- Coates, G. & Seamon, D. (1993). Promoting a foundational ecology practically through Christopher Alexander's pattern language: The example of Meadowcreek. In D. Seamon, *Dwelling, seeing and designing* (p. 331-354). Albany: State University of New York Press.
- Curtis, W. J. R. (1988). *Balkrishna Doshi: An architecture for India*. New York: Rizzoli.
- Davidson, C. (1995). *Aranya community housing*. Retrieved from [http://archnet.org/library/documents/one-document.jsp?document\\_id=6065](http://archnet.org/library/documents/one-document.jsp?document_id=6065)
- Doshi, B.V. (1988). *Architect's record of Aranya community housing*. MIMAR, 28, p.24-29. Retrieved from [http://archnet.org/library/files/one-file.jsp?file\\_id=1255](http://archnet.org/library/files/one-file.jsp?file_id=1255)
- Ekram, L. (1995). *Technical review of Aranya community housing*. Retrieved from [http://archnet.org/library/files/one-file.jsp?file\\_id=1253](http://archnet.org/library/files/one-file.jsp?file_id=1253)
- Facey, W. (1999). Building on the Past. *Aramco World*, 50(4), p.33-45.
- Fathy, H (1986). *Natural energy and vernacular architecture: Principles and examples with reference to hot arid climates*. Chicago: The University of Chicago Press.
- Fathy, H. (1993). *Architecture for the poor: An experiment in rural Egypt*. Chicago: The University of Chicago Press.
- Feeney, J. (1999). Building for the 800 Million: An Interview with Hassan Fathy. *Aramco World*, 50(4), p.28-31.
- Fromm, D. & Bosselmann, P. (1985). Mexicali revisited: Seven years later. *Places*, 1(4), 78-91. New York: The Design History Foundation.
- Grabow, S. (1983). *Christopher Alexander: The search for a new paradigm in architecture*. Stocksfield: Oriel Press.

- Guneratne, A. (2002). *Many tongues, one people: The making of Tharu identity in Nepal*. Ithaca: Cornell University Press.
- Haas, T. (2008). *New urbanism and beyond: Designing cities for the future*. New York: Rizzoli.
- Jacobson, M., Silverstein, M., & Winslow, B. (2002). *Patterns of home: The ten essentials of enduring design*. Newtown, CT: Taunton Press.
- Khan, H. (1999). Inventing Tradition and the Paradox of Continuity. *Aramco World*, 50(4), p.56-57.
- Khosla, R. (1995). *Local technical review of Aranya community housing*. Retrieved from [http://archnet.org/library/files/one-file.jsp?file\\_id=1254](http://archnet.org/library/files/one-file.jsp?file_id=1254)
- Rao, M. M. (2000). *The Architecture of Laurie Baker in Kerala, India: Space, Experience and Meaning*. Master of Science in Architecture: Kansas State University.
- Robertson, A. & Mishra, S. (1997). *Forced to plough: Bonded labor in Nepal's agricultural economy*. Kathmandu: Antislavery International and Informal Sector Service Center.
- Sharma, S. & Thakurathi, M. (1998). *A revisit to the Kamaiya system of Nepal*. Informal Service Sector Center.
- Shrestha, D. B., Singh, C. B., & Pradhan, B. M. (1972). *Ethnic groups of Nepal and their ways of living*. Kathmandu: H.M.G. Press.
- Shrestha, G.R., Rajkarnikar, D.G., & Thapa, S. (2006). *Economic and livelihood alternatives for ex-Kamaiyas and equally vulnerable communities in western Nepal*. Geneva: International Labour Office.
- Silverstein, M. (1993). The first roof: Interpreting a spatial pattern. In D. Seamon, *Dwelling, seeing and designing* (p. 77-100). Albany: State University of New York Press.

- Sowman, M., & Urquhart, P. (1998). *A place called home: Environmental issues and low-cost housing*. Cape Town: University of Cape Town Press.
- Srivastava, S.K. (1958). *The Tharus, a study in culture dynamics*. Agra University Press.
- Steele, J. (1988). *Hassan Fathy*. London: Academy Editions.
- Steele, J. (1997). *An architecture for people: The complete works of Hassan Fathy*. London: Thames and Hudson Ltd.
- Steele, J. (1999). Fathy as a Precursor of Sustainability. *Aramco World*, 50(4), p.55-56.
- Stohr, K. (2006). 100 Years of Humanitarian Design. In Architecture for Humanity (Organization), *Design like you give a damn: Architectural responses to humanitarian crises*. (pp. 33-55). New York, NY: Metropolis Books.
- Swan, Simone. (1999). Elegant Solutions. *Aramco World*, 50(4), p.17-27.
- Toffin, G. (1991). *Man and his house in the Himalayas: Ecology of Nepal*. New Delhi: Sterling.
- Turner, J., & Fichter, R. (1972). *Freedom to build: Dweller control for the housing progress*. New York: MacMillan.
- Turner, J. (1976). *Housing by people: Towards autonomy in building environment*. London: Calder & Boyars Ltd.
- Ward, P.M. (1982). *Self-help housing a critique*. London: Mansell Publishing Limited.

## **Appendix 1:**

### **Summary and Analysis of Interviews with Ex-Kamaiyas**

1. Number of household interviewed:
  - a. Tesanpur (total 78 houses, all built by Action Aid): 10 households interviewed.
  - b. Janatanagar (total 112 houses, 26 built by Action Aid): 6 households interviewed.
  - c. Bhurigaon (total 22 houses, all built by Habitat for Humanity): 4 households interviewed.
2. Flooding problem:
  - a. Tesanpur: Once in 3-4 years
  - b. Janatanagar: Once in 2-3 years
  - c. Bhurigaon: Every year
3. Min. and max. number of family members: Min. 1 and Max. 6
  - a. 6 members in 3 families
  - b. 5 members in 4 families
  - c. 4 members in 8 families
  - d. 3 members in 3 families
  - e. 2 members in 1 family
  - f. 1 member in 1 family (Note: Detached family preferred: no joint family found)
4. Daily activities: Farming and labor work. Going to India for labor work is a usual trend.
5. Small market (2-3 shops), School, etc available with ½ hr to 1 hr distance.
6. Interviewee from Tharu ethnic group: 19 out of 20.
7. Participation in community gathering: yes-19; rarely-1. This shows an active participation in community organized activities.
8. Involvement in construction of house: All household interviewed participated in the construction of their houses as unskilled labor workers.

9. Knowledge of traditional Tharu Construction: 100% interviewees had the knowledge of traditional Tharu house construction and all the houses has some kind of extensions made by themselves either added directly to the houses provided by ActionAid or separate construction. All households have separate shed construction in traditional Tharu style for Kitchen.
10. No one had knowledge of new construction materials and technology, however, 95% of the interview wanted to live in modern house and only 5% preferred to live in traditional Tharu house after making significant improvements.
11. Participation in skill development programs organized by various NGOs and INGOs: 7 out of 20 have participated. (Motorcycle repair training- 3 (not used); Plumbing- 2 (useful); Cattle husbandry- 1(useful); Midwife training- 1(useful).
12. Landlord house type: Traditional- 45%; Modern- 55%. That means the concept of living in traditional house is not gone yet.
13. Infrastructures:
  - a. Electricity: Available
  - b. Water supply: Hand pumps to pull out underground water (Installed by a different INGO).
  - c. Sanitation: Pit system.
14. Cluster type or Linear type land division/housing:
  - a. Percentage of interviewee preferring traditional cluster type housing: 60% (sense of community, close to neighbors, good from security point of view; but dirty in the absence of toilets)
  - b. Percentage of interviewee preferring linear type housing (current type): 40% (cleaner, feeling of openness, wide roads; but lacks sense of community and security problem specially when men are at work)
15. Percentage of household using traditional stove using fire wood: 100% (10% also use kerosene stove). If the new type of improved stoves which produce very less smoke can be introduced, people will prefer to have kitchen attached to main building rather than a separate one)
16. Primary defects of current house provided by ActionAid: Roof tiles, small windows, small area with just two rooms, cracks in plaster, no toilets and space for kitchen.

17. Preferred improvements: larger area, 2-story construction, modern construction materials, improved roof, larger windows, color. The suggestions made by interviewees to improve the current houses clearly show their interest in modern materials and construction technology used by the affluent groups in near-by cities.
18. General Space requirements: 2-bed rooms, kitchen, toilet, granary (store), living / guest room, verandah, cattle shed,
19. Possible Variations in design:
  - a. 1 or 2 story houses.
  - b. Houses with attached or separate kitchen.
  - c. Houses with or without separate space for living/guest room.
  - d. Houses with one, two or three bed rooms.

## Appendix 2:

### Climatic Data of Rampur, a Terai Town in Nepal

Latitude (deg/min): 27°37'  
 Longitude (deg/min): 84°25'  
 Elevation (m): 0256

2003 RAMPUR

Month	T max (°C)	T min (°C)	RH (%) 8:45	RH (%) 17:45	Rainfall (mm)
January	20.5	7.9	97.8	83.7	35.1
February	26.0	10.5	98.9	72.5	59.4
March	29.6	14.2	84.5	62.2	62.0
April	34.8	19.6	69.6	56.5	101.0
May	35.5	21.2	65.7	58.0	99.9
June	34.2	24.3	86.3	77.6	473.2
July	33.7	25.4	85.3	76.8	930.0
August	33.9	25.6	85.6	80.8	548.9
September	33.2	24.8	85.3	81.0	292.2
October	32.8	20.9	87.9	77.9	81.1
November	29.0	15.1	94.9	82.0	0.0
December	24.7	9.2	99.0	79.2	10.7

2004 RAMPUR

Month	T max (°C)	T min (°C)	RH (%) 8:45	RH (%) 17:45	Rainfall (mm)
January	21.3	9.0	98.8	79.7	62.7
February	26.4	10.3	98.9	67.6	0.0
March	33.2	15.8	81.1	50.9	0.0
April	33.4	20.2	74.1	58.5	180.2
May	34.9	22.6	74.2	61.0	111.4
June	34.6	24.4	79.7	71.6	472.5
July	33.0	25.3	86.6	82.2	495.5
August	34.5	25.9	85.1	82.1	214.3
September	33.3	24.4	86.9	82.1	417.7
October	31.5	18.8	84.9	78.1	75.7
November	28.1	13.0	92.1	77.4	12.0
December	24.7	9.7	99.3	78.4	0.0

Source: Department of Hydrology and Meteorology, Government of Nepal, Kathmandu



# Appendix 3:

## IRB Application Form

<b>FOR OFFICE USE ONLY:</b> IRB Protocol # _____ Application Received: _____ Routed: _____ Training Complete: _____
--

### Committee for Research Involving Human Subjects (IRB)

Application for Approval Form  
Last revised on April 2010

**ADMINISTRATIVE INFORMATION:**

- **Title of Project:** (if applicable, use the exact title listed in the grant/contract application)  
Handmade Houses for ex-Kamaiyas: A Pattern Language for Production of Self-help Houses in Western Tarai Regions of Nepal

- **Type of Application:**  
 New/Renewal       Revision (to a pending new application)  
 Modification (to an existing # \_\_\_\_\_ approved application)

- **Principal Investigator:** (must be a KSU faculty member)  

<b>Name:</b>	<b>Dr. David Seamon</b>	<b>Degree/Title:</b>	<b>Professor</b>
<b>Department:</b>	<b>Architecture</b>	<b>Campus Phone:</b>	<b>785-532-5953</b>
<b>Campus Address:</b>	<b>202C Seaton, KSU, Manhattan</b>	<b>Fax #:</b>	
<b>E-mail</b>	<b>traid@ksu.edu</b>		

- **Contact Name/Email/Phone for Questions/Problems with Form:** Amit Bajracharya  
amit1st@ksu.edu; 785-320-1577

- **Does this project involve any collaborators not part of the faculty/staff at KSU?** (projects with non-KSU collaborators may require additional coordination and approvals):  
 No  
 Yes

- **Project Classification** (Is this project part of one of the following?):  
 Thesis  
 Dissertation  
 Faculty Research  
 Other: \_\_\_\_\_

**Note:** Class Projects should use the short form application for class projects.

- **Please attach a copy of the Consent Form:**  
 Copy attached  
 Consent form not used

- **Funding Source:**  Internal     External (identify source and attach a copy of the sponsor's grant application or contract as submitted to the funding agency)  
 Copy attached       Not applicable

	<b>Self.</b>
--	--------------

- Based upon criteria found in 45 CFR 46 – and the overview of projects that may qualify for exemption explained at <http://www.hhs.gov/ohrp/humansubjects/guidance/decisioncharts.htm#c2>, I believe that my project using human subjects should be determined by the IRB to be exempt from IRB review:

No

Yes (If yes, please complete application **including** Section XII. C. ‘Exempt Projects’; remember that only the IRB has the authority to determine that a project is exempt from IRB review)

If you have questions, please call the University Research Compliance Office (URCO) at 532-3224, or [comply@ksu.edu](mailto:comply@ksu.edu)

## Human Subjects Research Protocol Application Form

The KSU IRB is required by law to ensure that all research involving human subjects is adequately reviewed for specific information and is approved prior to inception of any proposed activity. Consequently, it is important that you answer all questions accurately. If you need help or have questions about how to complete this application, please call the Research Compliance Office at 532-3224, or e-mail us at [comply@ksu.edu](mailto:comply@ksu.edu).

Please provide the requested information in the shaded text boxes. The shaded text boxes are designed to accommodate responses within the body of the application. As you type your answers, the text boxes will expand as needed. After completion, print the form and send the original and one photocopy to the Institutional Review Board, Room 203, Fairchild Hall.

<b>Principal Investigator:</b>	<b>Dr. David Seamon</b>
<b>Project Title:</b>	<b>Handmade Houses for ex-Kamaiyas: A Pattern Language for Production of Self-help Houses in Western Tarai Regions of Nepal</b>
<b>Date:</b>	<b>04/16/2010</b>

### MODIFICATION

Is this a modification of an approved protocol?  Yes  No

If yes, please comply with the following:

If you are requesting a modification or a change to an IRB approved protocol, please provide a concise description of all of the changes that you are proposing in the following block. Additionally, please highlight or bold the proposed changes in the body of the protocol where appropriate, so that it is clearly discernable to the IRB reviewers what and where the proposed changes are. This will greatly help the committee and facilitate the review.

### NON-TECHNICAL SYNOPSIS (brief narrative description of proposal easily understood by nonscientists):

**This research aims to study the self-help housing possibilities for ex-Kamaiyas, members of Tharu ethnic group in western Nepal, who, until 2000, were labor bonded. The ex-Kamaiyas are economically disadvantaged in the sense that they do not currently have proper housing or sufficient farmland for self-sufficient food production.**

#### I. BACKGROUND (concise narrative review of the literature and basis for the study):

**Based on the self-help housing concept of architects Christopher Alexander and Hassan Fathy, I plan to develop a pattern language for self-help houses for ex-Kamaiyas in western Tarai regions of Nepal.**

#### II. PROJECT/STUDY DESCRIPTION (please provide a concise narrative description of the proposed activity in terms that will allow the IRB or other interested parties to clearly understand what it is that you propose to do that involves human subjects. This description must be in enough detail so that IRB members can make an informed decision about proposal).

**Taking photographs, mapping daily activities, and interviewing ex-Kamaiyas living in the western Tarai regions of Nepal.**

III. **OBJECTIVE** (briefly state the objective of the research – what you hope to learn from the study):

**I hope to better understand the household requirements of ex-Kamaiyas, their social customs and culture, art and architecture, etc. that will help develop appropriate pattern language for the production of self-help housing.**

IV. **DESIGN AND PROCEDURES** (succinctly outline formal plan for study):

- A. Location of study: **Western Tarai regions of Nepal (Dang, Banke, and Bardiya)**
- B. Variables to be studied: **Housing needs, including cultural, social, and economic dimensions.**
- C. Data collection methods: (surveys, instruments, etc – **PLEASE ATTACH**) **Photographs, interviews, and observation of daily activities of ex-Kamaiyas.**
- D. List any factors that might lead to a subject dropping out or withdrawing from a study. These might include, but are not limited to emotional or physical stress, pain, inconvenience, etc.: **None.**
- E. List all biological samples taken: (if any) **No.**
- F. Debriefing procedures for participants: **A copy of the thesis results will be provided to ActionAid, an international organization working to provide housing for ex-Kamaiyas, as well as the community that will be studied.**

V. **RESEARCH SUBJECTS:**

- A. Source: **ex-Kamaiyas (Members of the Tharu ethnic group in western Nepal)**
- B. Number: **Approximately 30**
- C. Characteristics: (list any unique qualifiers desirable for research subject participation) **An Ex-Kamaiya community will be identified and 30 participants will be selected for survey.**
- D. Recruitment procedures: (Explain how do you plan to recruit your subjects? Attach any fliers, posters, etc. used in recruitment. If you plan to use any inducements, ie. cash, gifts, prizes, etc., please list them here.) **Participants will be identified with the help of ActionAid, an international organization working to provide housing for ex-Kamaiyas.**

VI. **RISK – PROTECTION – BENEFITS:** The answers for the three questions below are central to human subjects research. You must demonstrate a reasonable balance between anticipated risks to research participants, protection strategies, and anticipated benefits to participants or others.

- A. **Risks for Subjects:** (Identify any reasonably foreseeable physical, psychological, or social risks for participants. State that there are “no known risks” if appropriate.)  
**None**
- B. **Minimizing Risk:** (Describe specific measures used to minimize or protect subjects from anticipated risks.)  
**NA**
- C. **Benefits:** (Describe any reasonably expected benefits for research participants, a class of participants, or to society as a whole.)  
**Step-by-step guidelines for constructing self-help housing for ex-Kamaiyas.**

In your opinion, does the research involve **more than minimal risk** to subjects? (“Minimal risk” means that “the risks of harm anticipated in the proposed research are not greater, considering probability and magnitude, than those ordinarily encountered in daily life or during the performance of routine physical or psychological examinations or tests.”)

Yes       No

**VII. CONFIDENTIALITY:** Confidentiality is the formal treatment of information that an individual has disclosed to you in a relationship of trust and with the expectation that it will not be divulged to others without permission in ways that are inconsistent with the understanding of the original disclosure. Consequently, it is your responsibility to protect information that you gather from human research subjects in a way that is consistent with your agreement with the volunteer and with their expectations. If possible, it is best if research subjects' identity and linkage to information or data remains unknown.

Explain how you are going to protect confidentiality of research subjects and/or data or records. Include plans for maintaining records after completion.

**In surveys and interviews, participants will be identified by a number; in the thesis report, no individual's name will be used.**

**VIII. INFORMED CONSENT:** Informed consent is a critical component of human subjects research – it is your responsibility to make sure that any potential subject knows exactly what the project that you are planning is about, and what his/her potential role is. (There may be projects where some forms of “deception” of the subject is necessary for the execution of the study, but it must be carefully justified to and approved by the IRB). A schematic for determining when a waiver or alteration of informed consent may be considered by the IRB is found at

<http://ohrp.osophs.dhhs.gov/humansubjects/guidance/45cfr46.htm#46.116>

Even if your proposed activity does qualify for a waiver of informed consent, you must still provide potential participants with basic information that informs them of their rights as subjects, i.e. explanation that the project is research and the purpose of the research, length of study, study procedures, debriefing issues to include anticipated benefits, study and administrative contact information, confidentiality strategy, and the fact that participation is entirely voluntary and can be terminated at any time without penalty, etc. Even if your potential subjects are completely anonymous, you are obliged to provide them (and the IRB) with basic information about your project. See informed consent example on the URCO website. It is a federal requirement to maintain informed consent forms for 3 years after the study completion.

**Yes      No      Answer the following questions about the informed consent procedures.**

- A. Are you using a written informed consent form? If “yes,” include a copy with this application. If “no” see b.
- B. In accordance with guidance in 45 CFR 46, I am requesting a waiver or alteration of informed consent elements (See Section VII above). If “yes,” provide a basis and/or justification for your request.
- C. Are you using the online Consent Form Template provided by the URCO? If “no,” does your Informed Consent document has all the minimum required elements of informed consent found in the Consent Form Template? (Please explain)
- D. Are your research subjects anonymous? If they are anonymous, you will not have access to any information that will allow you to determine the identity of the research subjects in your study, or to link research data to a specific individual in any way. Anonymity is a powerful protection for potential research subjects. (An anonymous subject is one whose identity is unknown even to the researcher or the data or information collected cannot be linked in any way to a specific person).
- No names will be used in the thesis report and all respondents will be referred to by number. All responses will be kept strictly confidential.**
- E. Are subjects debriefed about the purposes, consequences, and benefits of the research? Debriefing refers to a mechanism for informing the research subjects of the results or conclusions, after the data is collected and analyzed, and the study is over. (If “no” explain why.) Attach copy of debriefing statement to be utilized.

**Once the thesis is completed, the researcher will present a public presentation on his work for the organizations working to provide shelter for ex-Kamaiyas; ex-Kamaiyas who participated in the survey will be invited.**

**\*It is a requirement that you maintain all signed copies of informed consent documents for at least 3 years following the completion of your study. These documents must be available for examination and review by federal compliance officials.**

**IX. PROJECT INFORMATION:** (If you answer yes to any of the questions below, you should explain them in one of the paragraphs above)

- | Yes                                 | No                                  | <b>Does the project involve any of the following?</b>  |
|-------------------------------------|-------------------------------------|--|
| <input type="checkbox"/>            | <input checked="" type="checkbox"/> | a. Deception of subjects   |
| <input type="checkbox"/>            | <input checked="" type="checkbox"/> | b. Shock or other forms of punishment  |
| <input type="checkbox"/>            | <input checked="" type="checkbox"/> | c. Sexually explicit materials or questions about sexual orientation, sexual experience or sexual abuse            |
| <input type="checkbox"/>            | <input checked="" type="checkbox"/> | d. Handling of money or other valuable commodities   |
| <input type="checkbox"/>            | <input checked="" type="checkbox"/> | e. Extraction or use of blood, other bodily fluids, or tissues   |
| <input type="checkbox"/>            | <input checked="" type="checkbox"/> | f. Questions about any kind of illegal or illicit activity   |
| <input type="checkbox"/>            | <input checked="" type="checkbox"/> | g. Purposeful creation of anxiety  |
| <input type="checkbox"/>            | <input checked="" type="checkbox"/> | h. Any procedure that might be viewed as invasion of privacy   |
| <input type="checkbox"/>            | <input checked="" type="checkbox"/> | i. Physical exercise or stress   |
| <input type="checkbox"/>            | <input checked="" type="checkbox"/> | j. Administration of substances (food, drugs, etc.) to subjects  |
| <input type="checkbox"/>            | <input checked="" type="checkbox"/> | k. Any procedure that might place subjects at risk   |
| <input type="checkbox"/>            | <input checked="" type="checkbox"/> | l. Any form of potential abuse; i.e., psychological, physical, sexual  |
| <input type="checkbox"/>            | <input checked="" type="checkbox"/> | m. Is there potential for the data from this project to be published in a journal, presented at a conference, etc? |
| <input checked="" type="checkbox"/> | <input type="checkbox"/>            | n. Use of surveys or questionnaires for data collection  |
- IF YES, PLEASE ATTACH!!**

**X. SUBJECT INFORMATION:** (If you answer yes to any of the questions below, you should explain them in one of the paragraphs above)

- | Yes                                 | No                                  | <b>Does the research involve subjects from any of the following categories?</b>  |
|-------------------------------------|-------------------------------------|--|
| <input type="checkbox"/>            | <input checked="" type="checkbox"/> | a. Under 18 years of age (these subjects require parental or guardian consent)   |
| <input type="checkbox"/>            | <input checked="" type="checkbox"/> | b. Over 65 years of age  |
| <input type="checkbox"/>            | <input checked="" type="checkbox"/> | c. Physically or mentally disabled   |
| <input checked="" type="checkbox"/> | <input type="checkbox"/>            | d. Economically or educationally disadvantaged   |
| <input type="checkbox"/>            | <input checked="" type="checkbox"/> | e. Unable to provide their own legal informed consent  |
| <input type="checkbox"/>            | <input checked="" type="checkbox"/> | f. Pregnant females as target population   |
| <input type="checkbox"/>            | <input checked="" type="checkbox"/> | g. Victims   |
| <input type="checkbox"/>            | <input checked="" type="checkbox"/> | h. Subjects in institutions (e.g., prisons, nursing homes, halfway houses)   |
| <input type="checkbox"/>            | <input checked="" type="checkbox"/> | i. Are research subjects in this activity students recruited from university classes or volunteer pools? If so, do you have a reasonable alternative(s) to participation as a research subject in your project, i.e., another activity such as writing or reading that would serve to protect students from unfair pressure or coercion to participate in this project? If you answered this question "Yes," explain any <u>alternatives options</u> for class credit for potential human subject volunteers in your study. (It is also important to remember that: Students must be free to choose <b>not</b> to participate in research that they have signed up for <b>at any time</b> without penalty. Communication of their decision can be conveyed in any manner, to include <b>simply not showing up</b> for the research.) |

- j. Are research subjects **audio** taped? If yes, how do you plan to protect the recorded information and mitigate any additional risks?
- k. Are research subjects' images being recorded (video taped, photographed)? If yes, how do you plan to protect the recorded information and mitigate any additional risks?  
Photographs of interior living conditions of the houses, the surrounding conditions and landscape, and community activities, will be taken with the permission from the subjects.

XI. **CONFLICT OF INTEREST:** Concerns have been growing that financial interests in research may threaten the safety and rights of human research subjects. Financial interests are not in them selves prohibited and may well be appropriate and legitimate. Not all financial interests cause Conflict of Interest (COI) or harm to human subjects. However, to the extent that financial interests may affect the welfare of human subjects in research, IRB's, institutions, and investigators must consider what actions regarding financial interests may be necessary to protect human subjects. Please answer the following questions:

- |                          |                                     |   |
|--------------------------|-------------------------------------|---|
| <b>Yes</b>               | <b>No</b>                           |   |
| <input type="checkbox"/> | <input checked="" type="checkbox"/> | a. Do you or the institution have any proprietary interest in a potential product of this research, including patents, trademarks, copyrights, or licensing agreements? |
| <input type="checkbox"/> | <input checked="" type="checkbox"/> | b. Do you have an equity interest in the research sponsor (publicly held or a non-publicly held company)?   |
| <input type="checkbox"/> | <input checked="" type="checkbox"/> | c. Do you receive significant payments of other sorts, eg., grants, equipment, retainers for consultation and/or honoraria from the sponsor of this research?           |
| <input type="checkbox"/> | <input checked="" type="checkbox"/> | d. Do you receive payment per participant or incentive payments?  |
| <input type="checkbox"/> | <input checked="" type="checkbox"/> | e. If you answered yes on any of the above questions, please provide adequate explanatory information so the IRB can assess any potential COI indicated above.          |

**XII. PROJECT COLLABORATORS:**

**A. KSU Collaborators – list anyone affiliated with KSU who is collecting or analyzing data:** (list all collaborators on the project, including co-principal investigators, undergraduate and graduate students)

Name:	Department:	Campus Phone:	Campus Email:
Amit Bajracharya	Architecture	(785) 320-1577	Amit1st@ksu.edu

**B. Non-KSU Collaborators:** (List all collaborators on your human subjects research project not affiliated with KSU in the spaces below. KSU has negotiated an Assurance with the Office for Human Research Protections (OHRP), the federal office responsible for oversight of research involving human subjects. When research involving human subjects includes collaborators who are not employees or agents of KSU the activities of those unaffiliated individuals may be covered under the KSU Assurance only in accordance with a formal, written agreement of commitment to relevant human subject protection policies and IRB oversight. The Unaffiliated Investigators Agreement can be found and downloaded at <http://www.k-state.edu/research/comply/irb/forms/Unaffiliated%20Investigator%20Agreement.doc>

**C.** The URCO must have a copy of the Unaffiliated Investigator Agreement on file for each non-KSU collaborator who is not covered by their own IRB and assurance with OHRP. Consequently, it is critical that you identify non-KSU collaborators, and initiate any coordination and/or approval process early, to minimize delays caused by administrative requirements.)

Name:	Organization:	Phone:	Institutional Email:
NA			

**Does your non-KSU collaborator's organization have an Assurance with OHRP?** (for Federalwide Assurance and Multiple Project Assurance (MPA) listings of other institutions, please reference the OHRP website under Assurance Information at: <http://ohrp.cit.nih.gov/search>).

No  
 Yes If yes, Collaborator's FWA or MPA # \_\_\_\_\_

**Is your non-KSU collaborator's IRB reviewing this proposal?**

No  
 Yes If yes, IRB approval # \_\_\_\_\_

**C. Exempt Projects:** 45 CFR 46 identifies six categories of research involving human subjects that may be exempt from IRB review. The categories for exemption are listed here: <http://www.hhs.gov/ohrp/humansubjects/guidance/decisioncharts.htm#c2>. If you believe that your project qualifies for exemption, please indicate which exemption category applies (1-6). Please remember that only the IRB can make the final determination whether a project is exempt from IRB review, or not.

**Exemption Category:** \_\_\_\_\_

**XIII. CLINICAL TRIAL**  Yes  No  
 (If so, please give product.)

**Export Controls Training:**

-The Provost has mandated that all KSU faculty/staff with a full-time appointment participate in the Export Control Program.

-If you are not in our database as having completed the Export Control training, this proposal will not be approved until your participation is verified.

-To complete the Export Control training, follow the instructions below:

Click on:

<http://www.k-state.edu/research/comply/ecp/index.htm>

1. After signing into K-State Online, you will be taken to the Export Control Homepage
2. Read the directions and click on the video link to begin the program
3. Make sure you enter your name / email when prompted so that participation is verified

If you click on the link and are not taken to K-State Online, this means that you have already completed the Export Control training and have been removed from the roster. If this is the case, no further action is required.

-Can't recall if you have completed this training? Contact the URCO at 785-532-3224 or [comply@ksu.edu](mailto:comply@ksu.edu) and we will be happy to look it up for you.

**Post Approval Monitoring:** The URCO has a Post-Approval Monitoring (PAM) program to help assure that activities are performed in accordance with provisions or procedures approved by the IRB. Accordingly, the URCO staff will arrange a PAM visit as appropriate; to assess compliance with approved activities.

**If you have questions, please call the University Research Compliance Office (URCO) at 532-3224, or [comply@ksu.edu](mailto:comply@ksu.edu)**

## INVESTIGATOR ASSURANCE FOR RESEARCH INVOLVING HUMAN SUBJECTS

(Print this page separately because it requires a signature by the PI.)

P.I. Name: Dr. David Seamon

Title of Project: Handmade Houses for ex-Kamaiyas: A pattern language for production of self-help houses in Western Tarai regions of Nepal

XIV. **ASSURANCES:** As the Principal Investigator on this protocol, I provide assurances for the following:

- A. **Research Involving Human Subjects:** This project will be performed in the manner described in this proposal, and in accordance with the Federalwide Assurance FWA00000865 approved for Kansas State University available at <http://ohrp.osophs.dhhs.gov/polasur.htm#FWA>, applicable laws, regulations, and guidelines. Any proposed deviation or modification from the procedures detailed herein must be submitted to the IRB, and be approved by the Committee for Research Involving Human Subjects (IRB) prior to implementation.
- B. **Training:** I assure that all personnel working with human subjects described in this protocol are technically competent for the role described for them, and have completed the required IRB training modules found on the URCO website at: <http://www.k-state.edu/research/comply/irb/training/index.htm>. I understand that no proposals will receive final IRB approval until the URCO has documentation of completion of training by all appropriate personnel.
- C. **Extramural Funding:** If funded by an extramural source, I assure that this application accurately reflects all procedures involving human subjects as described in the grant/contract proposal to the funding agency. I also assure that I will notify the IRB/URCO, the KSU PreAward Services, and the funding/contract entity if there are modifications or changes made to the protocol after the initial submission to the funding agency.
- D. **Study Duration:** I understand that it is the responsibility of the Committee for Research Involving Human Subjects (IRB) to perform continuing reviews of human subjects research as necessary. I also understand that as continuing reviews are conducted, it is my responsibility to provide timely and accurate review or update information when requested, to include notification of the IRB/URCO when my study is changed or completed.
- E. **Conflict of Interest:** I assure that I have accurately described (in this application) any potential Conflict of Interest that my collaborators, the University, or I may have in association with this proposed research activity.
- F. **Adverse Event Reporting:** I assure that I will promptly report to the IRB / URCO any unanticipated problems involving risks to subjects or others that involve the protocol as approved.
- G. **Accuracy:** I assure that the information herein provided to the Committee for Human Subjects Research is to the best of my knowledge complete and accurate.

\_\_\_\_\_  
(Principal Investigator Signature)

\_\_\_\_\_  
(date)



**KANSAS STATE UNIVERSITY**

**INFORMED CONSENT STATEMENT (Interview)**

**PROJECT TITLE:** Handmade Houses for ex-Kamaiyas: A Pattern Language for Production of Self-help Houses in South-western Nepal

**APPROVAL DATE OF PROJECT:** \_\_\_\_\_

**EXPIRATION DATE OF PROJECT:** \_\_\_\_\_

**PRINCIPAL INVESTIGATOR:**

Dr. David Seamon

**CO-INVESTIGATOR(S):**

Amit Bajracharya

**CONTACT AND PHONE FOR ANY PROBLEMS/QUESTIONS:**

(784) 320-1577; amit1st@ksu.edu

**IRB CHAIR CONTACT/PHONE INFORMATION:**

Rick Scheidt, Chair, Committee on Research Involving Human Subjects, 203 Fairchild Hall, Kansas State University, Manhattan, KS 66506, (785) 532-3224.

Jerry Jaax, Associate Vice Provost for Research Compliance and University Veterinarian, 203 Fairchild Hall, Kansas State University, Manhattan, KS 66506, (785) 532-3224.

**SPONSOR OF PROJECT:** Self.

**PURPOSE OF THE RESEARCH:**

The purpose of this study is to understand your social customs, traditions, daily activities, and inherited art and architecture. I am especially interested in knowing about your interest in vernacular buildings; your building construction and decoration skills; community living habits; your residential space requirements; and existing infrastructure facilities.

**PROCEDURES OR METHODS TO BE USED:**

The data will be collected via interviews and it will not take more than 60 minutes. The participation in the survey is completely voluntary and you have the right not to answer any question. You have the right to withdraw your participation anytime you wish. A copy of your responses will be made and both the original and copy will be used for the purpose of the thesis and carefully stored.

**ALTERNATIVE PROCEDURES OR TREATMENTS, IF ANY, THAT MIGHT BE ADVANTAGEOUS TO SUBJECT:**

NA.

(The participation in the survey is completely voluntary and one has the right not to answer any question that he/she feels is irrelevant.)

**LENGTH OF STUDY:**

Interview: Approx. 60 minutes for each respondent.

**RISKS ANTICIPATED:**

Responding to this questionnaire will not bring any kind of risk to the participant.

**BENEFITS ANTICIPATED:** The research is intended to provide practical guidelines for developing a pattern language for the production of houses for ex-Kamaiyas in the western Tarai regions of Nepal. The pattern may be useful in helping ex-Kamaiyas to build self-help housing.

**EXTENT OF CONFIDENTIALITY:** No names will be used in the thesis report and all respondents will be referred to by number. All responses will be kept strictly confidential.

**IS COMPENSATION OR MEDICAL TREATMENT AVAILABLE IF INJURY OCCURS:** NA

**PARENTAL APPROVAL FOR MINORS:** NA (Minors will not be surveyed)

**TERMS OF PARTICIPATION:** I understand this project is research, and that my participation is completely voluntary. I also understand that if I decide to participate in this study, I may withdraw my consent at any time, and stop participating at any time without explanation, penalty, or loss of benefits, or academic standing to which I may otherwise be entitled.

I verify that my signature below indicates that I have read and understand this consent form, and willingly agree to participate in this study under the terms described, and that my signature acknowledges that I have received a signed and dated copy of this consent form.

(Remember that it is a requirement for the P.I. to maintain a signed and dated copy of the same consent form signed and kept by the participant)

**Participant Name:** \_\_\_\_\_

**Participant Signature:** \_\_\_\_\_ **Date:** \_\_\_\_\_

**Witness to Signature: (project staff)** \_\_\_\_\_ **Date:** \_\_\_\_\_

## **Appendix 4:**

### **Interview Questions**

1. When did you move into your current camp/shelter?
2. Where did you live prior to your current shelter?
3. How many family members do you have? Can you describe the daily activities of you and your family members?
4. What do you do for your living?
5. Do you or your family members have knowledge of traditional Tharu bamboo crafts?
6. Have you participated in self-help skill development programs?
7. Would you like to stay in a traditional Tharu house or a different kind of dwelling? If the latter, what would it be?
8. Do you have any knowledge about Tharu art and architecture?
9. Can you construct a traditional Tharu house?
10. Was your previous landlord's house a traditional Tharu building or a concrete building?
11. Are there any design or architectural features that you like or dislike in the houses that you have lived in or visited?
12. Are you satisfied with the current house that you are living in?
13. What are the five changes that you want to make in your current house?
14. Can you describe the ideal house you want to live in?
15. What are your residential space requirements? (Clarify as necessary)
16. Do you have cattle?

17. How do you cook your food?
18. Would you rather live in detached houses or in cluster type housing? (Clarify as necessary)
19. Which Tharu village planning would you like: Linear planning or cluster planning?
20. Do you prefer to live in a joint family or detached family?
21. Do you celebrate traditional Tharu festivals and follow Tharu culture and traditions?
22. Do the community host celebrations for holidays or other special occasions? Do you participate in these events?
23. Are winters more severe or summers with monsoon rain?